



**5G;
5GS;
User Equipment (UE) conformance specification;
Part 1: Protocol
(3GPP TS 38.523-1 version 16.6.0 Release 16)**



Reference

RTS/TSGR-0538523-1vg60

Keywords

5G

ETSI

650 Route des Lucioles
F-06921 Sophia Antipolis Cedex - FRANCE

Tel.: +33 4 92 94 42 00 Fax: +33 4 93 65 47 16

Siret N° 348 623 562 00017 - NAF 742 C
Association à but non lucratif enregistrée à la
Sous-Préfecture de Grasse (06) N° 7803/88

Important notice

The present document can be downloaded from:
<http://www.etsi.org/standards-search>

The present document may be made available in electronic versions and/or in print. The content of any electronic and/or print versions of the present document shall not be modified without the prior written authorization of ETSI. In case of any existing or perceived difference in contents between such versions and/or in print, the prevailing version of an ETSI deliverable is the one made publicly available in PDF format at www.etsi.org/deliver.

Users of the present document should be aware that the document may be subject to revision or change of status. Information on the current status of this and other ETSI documents is available at <https://portal.etsi.org/TB/ETSIDeliverableStatus.aspx>

If you find errors in the present document, please send your comment to one of the following services:
<https://portal.etsi.org/People/CommiteeSupportStaff.aspx>

Copyright Notification

No part may be reproduced or utilized in any form or by any means, electronic or mechanical, including photocopying and microfilm except as authorized by written permission of ETSI.
The content of the PDF version shall not be modified without the written authorization of ETSI.
The copyright and the foregoing restriction extend to reproduction in all media.

© ETSI 2021.
All rights reserved.

DECT™, **PLUGTESTS™**, **UMTS™** and the ETSI logo are trademarks of ETSI registered for the benefit of its Members.
3GPP™ and **LTE™** are trademarks of ETSI registered for the benefit of its Members and of the 3GPP Organizational Partners.
oneM2M™ logo is a trademark of ETSI registered for the benefit of its Members and of the oneM2M Partners.
GSM® and the GSM logo are trademarks registered and owned by the GSM Association.

Intellectual Property Rights

Essential patents

IPRs essential or potentially essential to normative deliverables may have been declared to ETSI. The information pertaining to these essential IPRs, if any, is publicly available for **ETSI members and non-members**, and can be found in ETSI SR 000 314: "*Intellectual Property Rights (IPRs); Essential, or potentially Essential, IPRs notified to ETSI in respect of ETSI standards*", which is available from the ETSI Secretariat. Latest updates are available on the ETSI Web server (<https://ipr.etsi.org/>).

Pursuant to the ETSI IPR Policy, no investigation, including IPR searches, has been carried out by ETSI. No guarantee can be given as to the existence of other IPRs not referenced in ETSI SR 000 314 (or the updates on the ETSI Web server) which are, or may be, or may become, essential to the present document.

Trademarks

The present document may include trademarks and/or tradenames which are asserted and/or registered by their owners. ETSI claims no ownership of these except for any which are indicated as being the property of ETSI, and conveys no right to use or reproduce any trademark and/or tradename. Mention of those trademarks in the present document does not constitute an endorsement by ETSI of products, services or organizations associated with those trademarks.

Legal Notice

This Technical Specification (TS) has been produced by ETSI 3rd Generation Partnership Project (3GPP).

The present document may refer to technical specifications or reports using their 3GPP identities. These shall be interpreted as being references to the corresponding ETSI deliverables.

The cross reference between 3GPP and ETSI identities can be found under <http://webapp.etsi.org/key/queryform.asp>.

Modal verbs terminology

In the present document "**shall**", "**shall not**", "**should**", "**should not**", "**may**", "**need not**", "**will**", "**will not**", "**can**" and "**cannot**" are to be interpreted as described in clause 3.2 of the [ETSI Drafting Rules](#) (Verbal forms for the expression of provisions).

"**must**" and "**must not**" are **NOT** allowed in ETSI deliverables except when used in direct citation.

Contents

Intellectual Property Rights	2
Legal Notice	2
Modal verbs terminology	2
Foreword.....	18
1 Scope	20
2 References	20
3 Definitions, symbols and abbreviations	22
3.1 Definitions	22
3.2 Symbols	22
3.3 Abbreviations	22
4 Overview	22
4.1 Test methodology	22
4.1.1 Testing of optional functions and procedures	22
4.1.2 Test interfaces and facilities.....	23
4.2 Implicit testing.....	23
4.3 Repetition of tests	23
4.4 Handling of differences between conformance requirements in different releases of core specifications	23
5 Reference conditions, generic and test procedures, test parameters.....	24
5.1 Reference conditions	24
5.2 Generic and test procedures.....	24
5.3 Test parameters	24
5.3.1 PLMNs.....	24
5.3.2 Cells	24
5.3.3 USIM	25
5.3.4 Messages and Information Elements (IEs)	25
6 Idle mode operations	25
6.1 NR idle mode operations	25
6.1.1 NG-RAN Only PLMN Selection	25
6.1.1.1 PLMN selection of RPLMN, HPLMN/EHPLMN, UPLMN and OPLMN / Automatic mode	25
6.1.1.2 PLMN selection of "Other PLMN/access technology combinations" / Automatic mode	34
6.1.1.3 Cell reselection of ePLMN in manual mode	40
6.1.1.4 PLMN selection in shared network environment / Automatic mode	44
6.1.1.5 PLMN selection of RPLMN, HPLMN/EHPLMN, UPLMN and OPLMN / Automatic mode / User reselection	50
6.1.1.6 PLMN selection / Periodic reselection / MinimumPeriodicSearchTimer	56
6.1.1.7 PLMN selection of RPLMN or (E)HPLMN; Automatic mode	59
6.1.1.8 PLMN selection of RPLMN or (E)HPLMN; Manual mode	62
6.1.2 NG-RAN Only Cell Selection	65
6.1.2.1 Cell Selection/Qrxlevmin & Cell Reselection (Intra NR)	65
6.1.2.2 Cell Selection / Qqualmin/Intra NR / Serving cell becomes non-suitable (Srxlev > 0, Squal < 0)	75
6.1.2.3 Cell selection / Intra NR/ Serving cell becomes non-suitable (S<0, MIB Indicated barred).....	85
6.1.2.4 Cell Reselection for interband operation.....	90
6.1.2.6	98
6.1.2.7 Cell reselection / Equivalent PLMN	98
6.1.2.8 Cell reselection / Equivalent PLMN / Single Frequency operation	103
6.1.2.9 Cell reselection using Qhyst, Qoffset and Treselection	106
6.1.2.10	115
6.1.2.11 Area Specific SIBs using systemInformationAreaID.....	115
6.1.2.12 Cell reselection using cell status and cell reservations / cellReservedForOtherUse	121

6.1.2.13	Cell reselection using cell status and cell reservations / Access Identity 0, 1, 2 and 12 to 14 – cellReservedForOperatorUse	125
6.1.2.14	Cell reselection using cell status and cell reservations / Access Identity 11 or 15 - cellReservedForOperatorUse	127
6.1.2.15	Cell reselection in shared network environment	130
6.1.2.16	Inter-frequency cell reselection (equal priority)	134
6.1.2.17	Cell reselection / Cell-specific reselection parameters provided by the network in a neighbouring cell list	136
6.1.2.18	Cell reselection, Sintrasearch, Snonintrasearch.....	138
6.1.2.19	Speed-dependent cell reselection	145
6.1.2.19.1	Test Purpose (TP)	145
6.1.2.19.2	Conformance requirements.....	145
6.1.2.19.3	Test Description.....	147
6.1.2.20	Inter-frequency cell reselection according to cell reselection priority provided by SIBs.....	152
6.1.2.21	Cell reselection, SIntra SearchQ and SnonIntraSearchQ	157
6.1.2.22	Inter-frequency cell reselection based on common priority information with parameters ThreshX,HighQ, ThreshX,LowQ and ThreshServing,LowQ.....	167
6.1.2.23	Cell reselection/ MFBI.....	176
6.2	Multi-mode environment.....	184
6.2.1	Inter-RAT PLMN selection	184
6.2.1.1	Inter-RAT PLMN Selection / Selection of correct RAT for OPLMN / Automatic mode.....	184
6.2.1.2	Inter-RAT PLMN Selection / Selection of correct RAT for UPLMN / Automatic mode.....	187
6.2.1.3	Inter-RAT PLMN Selection / Selection of correct PLMN and RAT in shared network environment / Automatic mode.....	189
6.2.1.4	Inter-RAT PLMN Selection / Selection of correct RAT from the OPLMN list / Manual mode	194
6.2.1.5	Inter-RAT Background HPLMN Search / Search for correct RAT for HPLMN / Automatic Mode	197
6.2.2	Inter-RAT Cell Selection	202
6.2.2.1	Inter-RAT cell selection / From NR RRC_IDLE to EUTRA_Idle / Serving cell becomes non-suitable	202
6.2.2.2	Inter-RAT cell selection / From E-UTRA_Idle to NR RRC_IDLE / Serving cell becomes non-suitable	209
6.2.3	Inter-RAT Cell Reselection	217
6.2.3.1	Inter-RAT cell reselection / From E-UTRA_Idle to NR RRC_IDLE (lower priority & higher priority, Srxlev based)	217
6.2.3.2	Inter-RAT cell reselection / From E-UTRA_Idle to NR RRC_IDLE (lower priority & higher priority, Squal based)	226
6.2.3.3	Inter-RAT cell reselection / From NR RRC_IDLE to E-UTRA_IDLE (lower priority & higher priority, Srxlev based)	234
6.2.3.4	Inter-RAT cell reselection / From NR RRC_Idle to E-UTRA_IDLE (lower priority & higher priority, Squal based)	241
6.2.3.5	Inter-RAT cell reselection/From NR RRC_IDLE to E-UTRA_Idle according to RAT priority provided by dedicated signalling (RRCRelease).....	248
6.2.3.6	Inter-RAT cell reselection / From E-UTRA_Idle to NR RRC_IDLE according to RAT priority provided by dedicated signalling (RRConnRelease).....	256
6.2.3.7	Inter-RAT cell reselection/From NR RRC_IDLE to E-UTRA RRC_IDLE, Snonintrasearch...	263
6.2.3.8	Inter-RAT cell reselection/From E-UTRA RRC_IDLE to NR RRC_Idle, Snonintrasearch	267
6.2.3.9	Speed Dependent Cell Reselection (NR RRC_IDLE to E-UTRA RRC_IDLE).....	273
6.2.3.10	Inter-RAT cell reselection / From E-UTRA_Idle to NR RRC_IDLE / schedulingInfoList-v12j0	282
6.2.3.11	Inter-RAT cell reselection / From E-UTRA_Idle to NR RRC_IDLE / schedulingInfoListExt-r12	291
6.3	5GS Steering of Roaming.....	299
6.3.1	Steering of Roaming	299
6.3.1.1	Steering of UE in roaming during registration/security check successful using List Type 1	299
6.3.1.2	Steering of UE in roaming during registration/security check successful but SOR Transparent container indicates ACK has been NOT been requested.....	305
6.3.1.3	Steering of UE in roaming during registration/security check unsuccessful/Automatic mode ..	312
6.3.1.4	Steering of UE in roaming during registration/security check unsuccessful/ Manual mode.....	318
6.3.1.5	Steering of UE in roaming during registration/UE configured to receive Steering of Roaming information but does not receive Steering of Roaming from Network	323
6.3.1.6	328

6.3.1.7	Steering of UE in roaming during registration/security check unsuccessful but emergency service pending to be activated.....	328
6.3.1.8	Steering of UE in roaming after registration/Automatic PLMN selection mode	333
6.3.1.9	Steering of UE in roaming after registration/Manual PLMN selection mode	337
6.4	UE Procedures in RRC_INACTIVE state	341
6.4.1	NG-RAN Only PLMN Selection in RRC_INACTIVE state	341
6.4.1.1	PLMN Selection/Higher priority/HPLMN in Automatic PLMN Selection Mode	341
6.4.1.2	Cell reselection of ePLMN in manual mode	348
6.4.2	Cell Selection/Qrxlevmin & Cell Reselection (Intra NR in RRC_INACTIVE state).....	356
6.4.2.1	Cell Selection/Qrxlevmin & Cell Reselection (Intra NR in RRC_INACTIVE state).....	356
6.4.2.2	Inter-frequency cell reselection according to cell reselection priority provided by SIBs in RRC_INACTIVE state.....	364
6.4.3	Inter-RAT Cell Reselection	369
6.4.3.1	Inter-RAT cell reselection From NR RRC_INACTIVE to E-UTRA RRC_IDLE (lower priority & higher priority, Srxlev based).....	369
7	Layer 2.....	377
7.1	NR Layer 2	377
7.1.0	Common test case specific values for Layer 2.....	377
7.1.1	MAC	377
7.1.1.0	Default Pre-Test Conditions for all MAC test cases	377
7.1.1.1	Random Access Procedures	379
7.1.1.1.1	Correct selection of RACH parameters / Random access preamble and PRACH resource explicitly signalled to the UE by RRC / contention free random access procedure	379
7.1.1.1.1a	Correct selection of RACH parameters / Random access preamble and PRACH resource explicitly signalled to the UE by PDCCH Order / contention free random access procedure	386
7.1.1.1.2	Random access procedure / Successful / C-RNTI Based / Preamble selected by MAC itself	393
7.1.1.1.3	Random access procedure / Successful / SI request	409
7.1.1.1.4	Random access procedure / Successful / Beam Failure / Preamble selected by MAC itself / Non Contention Free RACH procedure	420
7.1.1.1.5	Random access procedure / Successful / Supplementary Uplink	436
7.1.1.1.6	Random access procedure / Successful/ Temporary C-RNTI Based / Preamble selected by MAC itself.....	441
7.1.1.2	Downlink Data Transfer.....	455
7.1.1.2.1	Correct Handling of DL MAC PDU / Assignment / HARQ process	455
7.1.1.2.2	Correct Handling of DL HARQ process PDSCH Aggregation	466
7.1.1.2.3	Correct HARQ process handling / CCCH	472
7.1.1.2.4	Correct HARQ process handling / BCCH	477
7.1.1.3	Uplink Data Transfer.....	480
7.1.1.3.1	Correct Handling of UL MAC PDU / Assignment / HARQ process	480
7.1.1.3.2	Logical channel prioritization handling	492
7.1.1.3.2b	Logical channel prioritization handling with Mapping restrictions.....	495
7.1.1.3.3	Correct handling of MAC control information / Scheduling requests	504
7.1.1.3.4	Correct handling of MAC control information / Buffer status / UL data arrive in the UE Tx buffer / Regular BSR	509
7.1.1.3.5	Correct handling of MAC control information / Buffer Status / UL resources are allocated / Padding BSR	519
7.1.1.3.6	Correct handling of MAC control information / Buffer status / Periodic BSR timer expires	526
7.1.1.3.7	UE power headroom reporting / Periodic reporting / DL pathloss change reporting	533
7.1.1.3.8	UE power headroom reporting / SCell activation / DL pathloss change reporting.....	540
7.1.1.3.8.1	UE power headroom reporting / SCell activation / DL pathloss change reporting/ Intra-band Contiguous CA.....	540
7.1.1.3.8.2	UE power headroom reporting / SCell activation / DL pathloss change reporting / Inter-Band CA	548
7.1.1.3.8.3	UE power headroom reporting / SCell activation / DL pathloss change reporting / Intra-band non-Contiguous CA	549
7.1.1.3.9	Correct Handling of UL HARQ process / PUSCH Aggregation.....	549
7.1.1.3.10	Correct Handling of HARQ process / Multiple CORESETPoolIndex	555
7.1.1.4	Transport Size Selection	557

7.1.1.4.1	DL-SCH Transport Block Size Selection	557
7.1.1.4.1.0	Common parameters for DL-SCH Transport Block Size Selection.....	557
7.1.1.4.1.1	DL-SCH Transport Block Size selection / DCI format 1_0.....	557
7.1.1.4.1.2	Void	565
7.1.1.4.1.3	DL-SCH transport block size selection / DCI format 1_1 / RA type 0/RA Type 1 / 2 Codewords enabled.....	565
7.1.1.4.1.4	DL-SCH transport block size selection / DCI format 1_1 / RA type 0/RA Type 1 / 2 Codewords enabled / 256QAM.....	578
7.1.1.4.2	UL-SCH Transport Block Size Selection	593
7.1.1.4.2.0	Common parameters for UL-SCH Transport Block Size Selection.....	593
7.1.1.4.2.1	UL-SCH Transport Block Size selection / DCI format 0_0 / Transform precoding disabled	593
7.1.1.4.2.2	Void	604
7.1.1.4.2.3	UL-SCH transport block size selection / DCI format 0_1 / RA type 0/RA Type 1 / Transform precoding disabled	604
7.1.1.4.2.4	UL-SCH transport block size selection / DCI format 0_1 / RA type 0/RA Type 1 / 256QAM / Transform precoding disabled	620
7.1.1.4.2.5	UL-SCH Transport Block Size selection / DCI format 0_0 / Transform precoding and 64QAM	635
7.1.1.5	Discontinuous reception	645
7.1.1.5.0	DRX Common Definitions	645
7.1.1.5.1	DRX operation / Short cycle not configured / Parameters configured by RRC	646
7.1.1.5.2	DRX operation / Short cycle not configured / Long DRX command MAC control element reception	651
7.1.1.5.3	DRX operation / Short cycle configured / Parameters configured by RRC	656
7.1.1.5.4	DRX Operation / Short cycle configured / DRX command MAC control element reception	660
7.1.1.5.5	DRX operation / Short cycle configured / Long DRX command MAC control element reception	666
7.1.1.6	Semi-Persistent Scheduling	671
7.1.1.6.1	Correct handling of DL assignment / Semi-persistent case	671
7.1.1.6.2	Correct handling of UL grant / configured grant Type 1	677
7.1.1.6.3	Correct handling of UL grant / configured grant Type 2.....	687
7.1.1.6.4	Correct handling of DL assignment / Multi Semi-persistent configuration.....	697
7.1.1.7	Activation/Deactivation of SCells.....	703
7.1.1.7.1	Activation/Deactivation of SCells / Activation/Deactivation MAC control element reception / sCellDeactivationTimer	703
7.1.1.8	Bandwidth Part (BWP) operation	709
7.1.1.8.1	Bandwidth Part (BWP) operation UL/DL	709
7.1.1.9	MAC Reconfiguration and Reset	722
7.1.1.9.1	MAC Reset	722
7.1.1.10	Other Procedures	728
7.1.1.10.1	DataInactivityTimer expiry	728
7.1.1.10.2	Recommended Bit Rate	729
7.1.1.11	NR Dual Connectivity	734
7.1.1.11.1	DC power headroom reporting / PSCell activation and DL pathloss change reporting	734
7.1.1.12	UE power saving	738
7.1.1.12.1	Cross-slot scheduling / DCI 1_1	738
7.1.1.12.2	742
7.1.1.12.3	DRX adaptation / UE wakeup indication	742
7.1.2	RLC	754
7.1.2.1	Default Pre-Test Conditions for all RLC test cases.....	754
7.1.2.1.1	Default Pre-Test Conditions for AM RLC test cases.....	754
7.1.2.1.2	Default Pre-Test Conditions for UM RLC test cases.....	755
7.1.2.2	RLC Unacknowledged mode	756
7.1.2.2.1	UM RLC / Segmentation and reassembly / 6-bit SN / Segmentation Info (SI) field	756
7.1.2.2.2	UM RLC / Segmentation and reassembly / 12-bit SN / Segmentation Info (SI) field	760
7.1.2.2.3	UM RLC / 6-bit SN / Correct use of sequence numbering	762
7.1.2.2.4	UM RLC / 12-bit SN / Correct use of sequence numbering	766
7.1.2.2.5	UM RLC / Receive Window operation and t-Reassembly expiry	770
7.1.2.2.6	UM RLC / RLC re-establishment procedure	775
7.1.2.3	RLC Acknowledged Mode	779

7.1.2.3.1	AM RLC / 12-bit SN / Segmentation and reassembly / Segmentation Info (SI) field	779
7.1.2.3.2	AM RLC / 18-bit SN / Segmentation and reassembly / Segmentation Info (SI) field	783
7.1.2.3.3	AM RLC / 12-bit SN / Correct use of sequence numbering	785
7.1.2.3.4	AM RLC / 18-bit SN / Correct use of sequence numbering	789
7.1.2.3.5	AM RLC / 12-bit SN / Control of transmit window/Control of receive window	790
7.1.2.3.5a	AM RLC / 18-bit SN / Control of transmit window/Control of receive window	794
7.1.2.3.6	AM RLC / Polling for status.....	795
7.1.2.3.7	AM RLC / Receiver status triggers	801
7.1.2.3.8	AM RLC / Reconfiguration of RLC parameters by upper layers	806
7.1.2.3.9	AM RLC / Reassembling of AMD PDUs	812
7.1.2.3.10	AM RLC / Re-transmission of RLC PDU with and without re-segmentation	820
7.1.2.3.11	AM RLC / RLC re-establishment procedure	827
7.1.3	PDCP	832
7.1.3.0	Default Pre-Test Conditions for all PDCP test cases	832
7.1.3.1	Maintenance of PDCP sequence numbers for radio bearers	833
7.1.3.1.1	Maintenance of PDCP sequence numbers / User plane / 12 bit SN	833
7.1.3.1.2	Maintenance of PDCP sequence numbers / User plane / 18 bit SN	837
7.1.3.2	PDCP integrity protection	838
7.1.3.2.1	Integrity protection / Correct functionality of integrity algorithm SNOW3G / SRB / DRB	838
7.1.3.2.2	Integrity protection / Correct functionality of integrity algorithm AES / SRB / DRB	846
7.1.3.2.3	Integrity protection / Correct functionality of integrity algorithm ZUC / SRB / DRB	847
7.1.3.3	PDCP Ciphering and deciphering	848
7.1.3.3.1	Ciphering and deciphering / Correct functionality of encryption algorithm SNOW3G / SRB / DRB	848
7.1.3.3.2	Ciphering and deciphering / Correct functionality of encryption algorithm AES / SRB / DRB	853
7.1.3.3.3	Ciphering and deciphering / Correct functionality of encryption algorithm ZUC / SRB / DRB	854
7.1.3.4	PDCP Handover	855
7.1.3.4.1	PDCP handover / Lossless handover / PDCP sequence number maintenance / PDCP status report to convey the information on missing or acknowledged PDCP SDUs at handover / In-order delivery and duplicate elimination in the downlink	855
7.1.3.4.2	PDCP handover / Non-lossless handover / PDCP sequence number maintenance	864
7.1.3.5	PDCP other	868
7.1.3.5.1	PDCP Discard.....	868
7.1.3.5.2	PDCP Uplink Routing / Split DRB	870
7.1.3.5.3	PDCP Data Recovery	875
7.1.3.5.4	PDCP reordering / Maximum re-ordering delay below t-Reordering / t-Reordering timer operations	882
7.1.3.5.5	PDCP Duplication	887
7.1.3.5.6	PDCP Duplication / 3 RLC entities	893
7.1.3.5.7	Ethernet header compression and decompression / Correct functionality of ethernet header compression and decompression	898
7.1.4	SDAP	901
7.1.4.1	SDAP Data Transfer and PDU Header Handling UL/DL	901
7.1.4.1.1	Test Purpose (TP)	901
7.1.4.1.2	Conformance requirements.....	902
7.1.4.2	SDAP Data Transfer handling without Header UL/DL	910
7.1.4.2.1	Test Purpose (TP)	910
7.1.4.2.2	Conformance requirements.....	910
7.1.4.2.3	Test description	912
8	RRC	917
8.1	NR RRC	917
8.1.1	RRC connection management procedures	917
8.1.1.1	Paging	917
8.1.1.1.1	RRC / Paging for connection / Multiple paging records.....	917
8.1.1.1.2	RRC / Paging for connection / Shared network environment.....	922
8.1.1.2	RRC connection establishment	928
8.1.1.2.1	RRC connection establishment / Return to idle state after T300 expiry	928
8.1.1.2.2	Void.....	932
8.1.1.2.3	RRC connection establishment / RRC Reject with wait time.....	932

8.1.1.2.4	RRC connection establishment / Extended and spare fields in SI	935
8.1.1.3	RRC release	938
8.1.1.3.1	RRC connection release / Redirection to another NR frequency	938
8.1.1.3.2	RRC connection release / Redirection from NR to E-UTRA	941
8.1.1.3.3	RRC connection release / Success / With priority information	944
8.1.1.3.4	RRC connection release / Success / With priority information / E-UTRA	954
8.1.1.3.5	Void	963
8.1.1.3.6	Void	963
8.1.1.4	RRC resume	963
8.1.1.4.1	RRC resume / Suspend-Resume / RNA update / Success	963
8.1.1.4.2	RRC resume / Suspend-Resume / RRC setup / T319 expiry	971
8.1.1.4.3	Void	976
8.1.2	RRC reconfiguration	976
8.1.2.1	Radio bearer establishment / reconfiguration / release	976
8.1.2.1.1	RRC reconfiguration / DRB / SRB / Establishment / Modification / Release / Success	976
8.1.2.1.2	RRC reconfiguration / RRC bearer establishment / uplinkTxDirectCurrentList	985
8.1.2.1.3	Void	988
8.1.2.1.4	RRC reconfiguration / Dedicated RLF timer	988
8.1.2.1.5	NR CA / RRC reconfiguration / SCell addition / modification / release / Success	991
8.1.2.1.5.1	NR CA / RRC reconfiguration / SCell addition / modification / release / Success / Intra-band Contiguous CA	991
8.1.2.1.5.2	NR CA / RRC reconfiguration / SCell addition / modification / release / Success / Inter-band CA	995
8.1.2.1.5.3	NR CA / RRC reconfiguration / SCell addition / modification / release / Success / Intra-band non-contiguous CA	995
8.1.3	Measurement configuration control and reporting	996
8.1.3.1	Intra NR measurements	996
8.1.3.1.1	Measurement configuration control and reporting / Intra NR measurements / Event A1 / Event A2	996
8.1.3.1.2	Measurement configuration control and reporting / Event A3 / Measurement of Neighbor NR cell / Intra-frequency measurements	1007
8.1.3.1.3	Measurement configuration control and reporting / Event A3 / Measurement of Neighbour NR cell / Inter-frequency measurements	1016
8.1.3.1.4	Measurement configuration control and reporting / Event A3 / Measurement of Neighbour NR cell / Inter-band measurements	1019
8.1.3.1.5	Measurement configuration control and reporting / Event A4 / Measurement of Neighbour NR cell / Intra-frequency measurements	1021
8.1.3.1.6	Measurement configuration control and reporting / Event A4 / Measurement of Neighbour NR cell / Inter-frequency measurements	1029
8.1.3.1.7	Measurement configuration control and reporting / Event A4 / Measurement of Neighbour NR cell / Inter-band measurements	1032
8.1.3.1.8	Measurement configuration control and reporting / Event A5 / Measurement of Neighbour NR cell / Intra-frequency measurements	1034
8.1.3.1.9	Measurement configuration control and reporting / Event A5 / Measurement of Neighbour NR cell / Inter-frequency measurements	1043
8.1.3.1.10	Measurement configuration control and reporting / Event A5 / Measurement of Neighbour NR cell / Inter-band measurements	1046
8.1.3.1.11	Measurement configuration control and reporting / Intra NR measurements / Two simultaneous events A3 (intra and inter-frequency measurements) / RSRQ based measurements	1048
8.1.3.1.12	Measurement configuration control and reporting / Intra NR measurements / Two simultaneous events A5 (intra and inter-frequency measurements) / SINR based measurements	1058
8.1.3.1.13	Measurement configuration control and reporting / SS/PBCH block based / CSI-RS based intra-frequency measurements / Measurement of Neighbour NR cell	1068
8.1.3.1.14	Void	1089
8.1.3.1.14A	Measurement configuration control and reporting / SS/PBCH block based / CSI-RS based inter-frequency measurements / Measurement of Neighbour NR cell	1089
8.1.3.1.15	Void	1095
8.1.3.1.15A	Measurement configuration control and reporting / Intra NR measurements / Blacklisting	1095

8.1.3.1.16	Measurement configuration control and reporting / Intra NR measurements / Whitelisting	1109
8.1.3.1.17	NR CA / Measurement configuration control and reporting / Intra NR measurements / Event A6	1118
8.1.3.1.17.1	NR CA / Measurement configuration control and reporting / Intra NR measurements / Event A6 / Intra-band Contiguous CA	1118
8.1.3.1.17.2	NR CA / Measurement configuration control and reporting / Intra NR measurements / Event A6 / Inter-band CA	1128
8.1.3.1.17.3	NR CA / Measurement configuration control and reporting / Intra NR measurements / Event A6 / Intra-band non Contiguous CA	1130
8.1.3.1.18	NR CA / Measurement configuration control and reporting / Intra NR measurements / Additional measurement reporting	1130
8.1.3.1.18.1	NR CA / Measurement configuration control and reporting / Intra NR measurements / Additional measurement reporting / Intra-band Contiguous CA	1130
8.1.3.1.18.2	NR CA / Measurement configuration control and reporting / Intra NR measurements / Additional measurement reporting / Inter-band CA	1141
8.1.3.1.18.3	NR CA / Measurement configuration control and reporting / Intra NR measurements / Additional measurement reporting / Intra-band non Contiguous CA	1142
8.1.3.1.19	1143
8.1.3.1.20	Measurement configuration control and reporting / Measurement Gaps / gapFR1	1143
8.1.3.1.21	Measurement configuration control and reporting / Measurement Gaps / gapFR2	1150
8.1.3.1.22	1159
8.1.3.1.23	Measurement configuration control and reporting / Intra NR measurements / Continuation of the measurements after RRC Resume	1159
8.1.3.2	Inter-RAT measurements	1166
8.1.3.2.1	Measurement configuration control and reporting / Inter-RAT measurements / Event B1 / Measurement of E-UTRA cells	1166
8.1.3.2.2	Measurement configuration control and reporting / Inter-RAT measurements / Event B2 / Measurement of E-UTRA cells	1176
8.1.3.2.3	Measurement configuration control and reporting / Inter-RAT measurements / Event B2 / Measurement of E-UTRA cells / RSRQ based measurements	1186
8.1.3.2.4	Measurement configuration control and reporting / Inter-RAT measurements / Event B2 / Measurement of E-UTRA cells / SINR based measurements	1195
8.1.3.2.5	Void	1205
8.1.3.3	Measurement for self-optimized networks	1205
8.1.3.3.1	Measurement configuration control and reporting / CGI reporting of NR cell	1205
8.1.3.3.2	Measurement configuration control and reporting / CGI reporting of E-UTRA cell	1217
8.1.4	Handover	1230
8.1.4.1	Intra NR handover	1230
8.1.4.1.1	Void	1230
8.1.4.1.2	Intra NR handover / Success / Inter-frequency	1230
8.1.4.1.3	Void	1246
8.1.4.1.4	Void	1246
8.1.4.1.5	Intra NR handover / Failure / Re-establishment successful	1246
8.1.4.1.6	Intra NR handover / Failure / Re-establishment failure	1253
8.1.4.1.7	NR CA / Intra NR handover / Success / PCell Change and SCell addition / SCell release	1258
8.1.4.1.7.1	NR CA / Intra NR handover / Success / PCell Change and SCell addition / SCell release / Intra-band Contiguous CA	1258
8.1.4.1.7.2	NR CA / Intra NR handover / Success / PCell Change and SCell addition / SCell release / Inter-band CA	1263
8.1.4.1.7.3	NR CA / Intra NR handover / Success / PCell Change and SCell addition / SCell release / Intra-band non-contiguous CA	1264
8.1.4.1.8	NR CA / Intra NR handover / Success / PCell Change / SCell no Change	1264
8.1.4.1.8.1	NR CA / Intra NR handover / Success / PCell Change / SCell no Change / Intra-band Contiguous CA	1264
8.1.4.1.8.2	NR CA / Intra NR handover / Success / PCell Change / SCell no Change / Inter-band CA	1268
8.1.4.1.8.3	NR CA / Intra NR handover / Success / PCell Change / SCell no Change / Intra-band non-contiguous CA	1269
8.1.4.1.9	NR CA / Intra NR handover / Failure / Re-establishment successful	1270
8.1.4.1.9.1	NR CA / Intra NR handover / Failure / Re-establishment successful / Intra-band Contiguous CA	1270

8.1.4.1.9.2	NR CA / Intra NR handover / Failure / Re-establishment successful / Inter-band CA	1281
8.1.4.1.9.3	NR CA / Intra NR handover / Failure / Re-establishment successful / Intra-band non-contiguous CA	1282
8.1.4.2	Inter-RAT handover	1282
8.1.4.2.1	Inter-RAT handover from NR	1282
8.1.4.2.1.1	Inter-RAT handover / From NR to E-UTRA / Success	1282
8.1.4.2.1.2	Inter-RAT handover / From NR to EN-DC / Success	1288
8.1.4.2.2	Inter-RAT handover to NR	1294
8.1.4.2.2.1	Inter-RAT handover / From E-UTRA to NR / Success	1294
8.1.4.3	DAPS handover	1299
8.1.4.3.1	DAPS handover / Success	1299
8.1.5	RRC others	1309
8.1.5.1	UE capability transfer	1309
8.1.5.1.1	UE capability transfer / Success	1309
8.1.5.2	SI change / On-demand SIB	1326
8.1.5.2.1	SI change / Notification of BCCH modification / Short message for SI update	1326
8.1.5.2.2	SI change / Notification of BCCH modification / Short message for SI update in NR RRC_CONNECTED state	1330
8.1.5.3	PWS notification	1333
8.1.5.3.1	PWS notification / PWS reception in NR RRC_IDLE state	1333
8.1.5.3.2	PWS notification / PWS reception in NR RRC_INACTIVE state	1335
8.1.5.3.3	PWS notification / PWS reception in NR RRC_CONNECTED state	1336
8.1.5.3.4	PWS notification / PWS reception using dedicatedSystemInformationDelivery	1337
8.1.5.4	Counter check	1343
8.1.5.4.1	Counter check / Reception of CounterCheck message by the UE	1343
8.1.5.5	Redirection to NR	1347
8.1.5.5.1	Redirection to NR / From E-UTRA / Success	1347
8.1.5.6	Radio link failure	1352
8.1.5.6.1	Radio link failure / RRC connection re-establishment success	1352
8.1.5.6.2	Void	1359
8.1.5.6.3	Radio link failure / T311 expiry	1359
8.1.5.6.4	Void	1363
8.1.5.6.5	NR CA / No Radio Link Failure on SCell / RRC Connection Continues on Pcell	1363
8.1.5.6.5.1	NR CA / No Radio Link Failure on SCell / RRC Connection Continues on PCell / Intra-band Contiguous CA	1363
8.1.5.6.5.2	NR CA / No Radio Link Failure on SCell / RRC Connection Continues on PCell / Inter-band CA	1367
8.1.5.6.5.3	NR CA / No Radio Link Failure on SCell / RRC Connection Continues on PCell / Intra-band non-Contiguous CA	1368
8.1.5.7	Failure information	1368
8.1.5.7.1	Failure information / RLC failure / MCG	1368
8.1.5.7.1.1	Failure information / RLC failure / MCG / Intra-band Contiguous CA	1368
8.1.5.7.1.2	Failure information / RLC failure / MCG / Inter-band CA	1373
8.1.5.7.1.3	Failure information / RLC failure / MCG / Intra-band non Contiguous CA	1374
8.1.5.8	Processing delay	1375
8.1.5.8.1	Processing delay / RRC_Idle to RRC_Connected / RRC_Inactive to RRC_Connected / Success / Latency check	1375
8.2	MR-DC RRC	1386
8.2.1	UE Capability	1386
8.2.1.1	UE capability transfer / Success	1386
8.2.1.1.1	UE capability transfer / Success / EN-DC	1386
8.2.1.2	Void	1418
8.2.2	Radio Bearer Addition, Modification and Release	1418
8.2.2.1	Radio Bearer Addition, Modification and Release / SRB	1418
8.2.2.1.1	SRB3 Establishment, Reconfiguration and Release / NR addition, modification and release / EN-DC	1418
8.2.2.1.2	SRB3 Establishment, Reconfiguration and Release / NR addition, modification and release / NR-DC	1428
8.2.2.2	Split SRB Establishment and Release	1436
8.2.2.2.1	Split SRB Establishment and Release / EN-DC	1436
8.2.2.3	Simultaneous SRB3 and Split SRB / Sequential message flow on SRB3 and Split SRB	1446

8.2.2.3.1	Simultaneous SRB3 and Split SRB / Sequential message flow on SRB3 and Split SRB with one UL path / EN-DC	1446
8.2.2.4	PSCell addition, modification and release / SCG DRB	1456
8.2.2.4.1	PSCell addition, modification and release / SCG DRB / EN-DC	1456
8.2.2.4.2	PSCell addition, modification and release / SCG DRB / NR-DC	1466
8.2.2.5	PSCell addition, modification and release / Split DRB	1473
8.2.2.5.1	PSCell addition, modification and release / Split DRB / EN-DC	1473
8.2.2.5.2	PSCell addition, modification and release / Split DRB / NR-DC	1482
8.2.2.6	Bearer Modification / MCG DRB	1491
8.2.2.6.1	Bearer Modification / MCG DRB / SRB / PDCP version change / EN-DC	1491
8.2.2.7	Bearer Modification / Handling for bearer type change without security key change	1503
8.2.2.7.1	Bearer Modification / Handling for bearer type change without security key change / EN-DC	1503
8.2.2.7.2	Bearer Modification / Handling for bearer type change without security key change / NR-DC	1517
8.2.2.8	Bearer Modification / Handling for bearer type change with security key change	1529
8.2.2.8.1	Bearer Modification / Handling for bearer type change with security key change / EN-DC	1529
8.2.2.8.2	Bearer Modification / Handling for bearer type change with security key change / NR-DC	1553
8.2.2.9	Bearer Modification / Uplink data path / Split DRB Reconfiguration	1574
8.2.2.9.1	Bearer Modification / Uplink data path / Split DRB Reconfiguration / EN-DC	1574
8.2.2.9.2	Bearer Modification / Uplink data path / Split DRB Reconfiguration / NR-DC	1582
8.2.3	Measurement Configuration Control and Reporting / Handovers	1587
8.2.3.1	Measurement configuration control and reporting / Inter-RAT measurements / Event B1 / Measurement of NR cells	1587
8.2.3.1.1	Measurement configuration control and reporting / Inter-RAT measurements / Event B1 / Measurement of NR cells / EN-DC	1587
8.2.3.2	Measurement configuration control and reporting / Inter-RAT measurements / Event B1 / Measurement of NR cells / RSRQ based measurements	1598
8.2.3.2.1	Measurement configuration control and reporting / Inter-RAT measurements / Event B1 / Measurement of NR cells / RSRQ based measurements / EN-DC	1598
8.2.3.3	Measurement configuration control and reporting / Inter-RAT measurements / Periodic reporting / Measurement of NR cells	1608
8.2.3.3.1	Measurement configuration control and reporting / Inter-RAT measurements / Periodic reporting / Measurement of NR cells / EN-DC	1608
8.2.3.4	Measurement configuration control and reporting / Event A1 / Measurement of NR PSCell .	1619
8.2.3.4.1	Measurement configuration control and reporting / Event A1 / Measurement of NR PSCell / EN-DC	1619
8.2.3.5	Measurement configuration control and reporting / Event A2 / Measurement of NR PSCell .	1628
8.2.3.5.1	Measurement configuration control and reporting / Event A2 / Measurement of NR PSCell / EN-DC	1628
8.2.3.6	Measurement configuration control and reporting / Event A3 / Measurement of Neighbour NR cells	1634
8.2.3.6.1	Measurement configuration control and reporting / Event A3 / Measurement of Neighbour NR cells / Intra-frequency measurements / EN-DC	1634
8.2.3.6.1a	Measurement configuration control and reporting / Event A3 / Measurement of Neighbor NR cell / Inter-frequency measurements / EN-DC	1642
8.2.3.6.1b	Measurement configuration control and reporting / Event A3 / Measurement of Neighbor NR cell / Inter-band measurements / EN-DC	1645
8.2.3.7	Measurement configuration control and reporting / Event A4 (intra-frequency, inter-frequency and inter-band measurements) / Measurement of Neighbour NR cell	1648
8.2.3.7.1	Measurement configuration control and reporting / Event A4 / Measurement of Neighbour NR cell / Intra-frequency measurements / EN-DC	1648
8.2.3.7.1a	Measurement configuration control and reporting / Event A4 / Measurement of Neighbor NR cell / Inter-frequency measurements / EN-DC	1658
8.2.3.7.1b	Measurement configuration control and reporting / Event A4 / Measurement of Neighbor NR cell / Inter-band measurements / EN-DC	1661
8.2.3.8	Measurement configuration control and reporting / Event A5 / Measurement of Neighbour NR cell	1664
8.2.3.8.1	Measurement configuration control and reporting / Event A5 / Measurement of Neighbour NR cell / Intra-frequency measurements / EN-DC	1664

8.2.3.8.1a	Measurement configuration control and reporting / Event A5 / Measurement of Neighbor NR cell / Inter-frequency measurements / EN-DC	1675
8.2.3.8.1b	Measurement configuration control and reporting / Event A5 / Measurement of Neighbor NR cell / Inter-band measurements / EN-DC.....	1679
8.2.3.9	Measurement configuration control and reporting / SS/PBCH block based / CSI-RS based intra-frequency measurements / Measurement of Neighbour NR cell.....	1682
8.2.3.9.1	Measurement configuration control and reporting / SS/PBCH block based / CSI-RS based Intra-frequency measurements / Measurement of Neighbour NR Cell / EN-DC	1682
8.2.3.10	Measurement configuration control and reporting / SS/PBCH block based / CSI-RS based inter-frequency measurements / Measurement of Neighbour NR cell.....	1703
8.2.3.10.1	Measurement configuration control and reporting / SS/PBCH block based /CSI-RS based Inter-frequency measurements/ Measurement of Neighbour NR Cell / EN-DC	1703
8.2.3.11	Measurement configuration control and reporting / Measurement Gaps	1726
8.2.3.11.1	Measurement configuration control and reporting / Measurement Gaps / NR FR1 / EN-DC	1726
8.2.3.11.2	Measurement configuration control and reporting / Measurement Gaps / NR FR2 / EN-DC	1742
8.2.3.12	Measurement configuration control and reporting / Inter-RAT measurements / Event B2 / Measurement of NR cells.....	1751
8.2.3.12.1	Measurement configuration control and reporting / Inter-RAT measurements / Event B2 / Measurement of NR cells / EN-DC	1751
8.2.3.13	PCell Handover with SCG change / Reconfiguration with sync / SCG DRB	1763
8.2.3.13.1	PCell Handover with SCG change / Reconfiguration with sync / SCG DRB / EN-DC	1763
8.2.3.14	SCG change / Reconfiguration with sync / Split DRB.....	1770
8.2.3.14.1	SCG change / Reconfiguration with sync / Split DRB / EN-DC.....	1770
8.2.3.14.2	SCG change / Reconfiguration with sync / Split DRB / NR-DC.....	1776
8.2.3.15	Measurement configuration control and reporting / Two simultaneous events A2 and A3 (intra-frequency measurements) / Measurement of Neighbour NR cells	1782
8.2.3.15.1	Measurement configuration control and reporting / Two simultaneous events A2 and A3 (intra-frequency measurements) / Measurement of Neighbour NR cells / EN-DC	1782
8.2.3.16	Measurement configuration control and reporting / SRB3	1792
8.2.3.16.1	Measurement configuration control and reporting / SRB3 / Intra NR measurements / EN-DC	1792
8.2.3.16.2	Measurement configuration control and reporting / SRB3 / Intra NR measurements / NR-DC	1799
8.2.4	Carrier Aggregation	1806
8.2.4.1	NR CA / NR SCell addition / modification / release / Success	1806
8.2.4.1.1	NR CA / NR SCell addition / modification / release / Success / EN-DC	1806
8.2.4.1.1.1	NR CA / NR SCell addition / modification / release / Success / EN-DC / Intra-band Contiguous CA	1806
8.2.4.1.1.2	NR CA / NR SCell addition / modification / release / Success / EN-DC / Intra-band non-Contiguous CA	1817
8.2.4.1.1.3	NR CA / NR SCell addition / modification / release / Success / EN-DC / Inter-band CA.....	1817
8.2.4.2	NR CA / Simultaneous PSCell and SCell addition / PSCell and SCell change / CA Release ..	1818
8.2.4.2.1	NR CA / Simultaneous PSCell and SCell addition / PSCell and SCell change / CA Release/ EN-DC.....	1818
8.2.4.2.1.1	NR CA / Simultaneous PSCell and SCell addition / PSCell and SCell change / CA Release / EN-DC / Intra-band Contiguous CA	1818
8.2.4.2.1.2	NR CA / Simultaneous PSCell and SCell addition / PSCell and SCell change / CA Release / EN-DC / Intra-band non-Contiguous CA	1832
8.2.4.2.1.3	NR CA / Simultaneous PSCell and SCell addition / PSCell and SCell change / CA Release / EN-DC / Inter-band CA.....	1833
8.2.4.3	NR CA / SCell change / Intra-NR measurement event A6 / SRB3.....	1833
8.2.4.3.1	NR CA / SCell change / Intra-NR measurement event A6 / SRB3 / EN-DC	1833
8.2.4.3.1.1	NR CA / SCell change / Intra-NR measurement event A6 / SRB3 / EN-DC / Intra-band Contiguous CA	1833
8.2.4.3.1.2	NR CA / SCell change / Intra-NR measurement event A6 / SRB3 / EN-DC / Intra-band non-Contiguous CA	1846
8.2.4.3.1.3	NR CA / SCell change / Intra-NR measurement event A6 / SRB3 / EN-DC / Inter-band CA	1846
8.2.5	Reconfiguration Failure / Radio link failure	1848

8.2.5.1	Radio link failure / PSCell addition failure	1848
8.2.5.1.1	Radio link failure / Random access problem / EN-DC	1848
8.2.5.1.2	Radio link failure / Random access problem / NR-DC	1850
8.2.5.2	Radio link failure / PSCell out of sync indication	1852
8.2.5.2.1	Radio link failure / PSCell out of sync indication / EN-DC	1852
8.2.5.2.2	Radio link failure / PSCell out of sync indication / NR-DC	1856
8.2.5.3	Radio link failure / rlc-MaxNumRetx failure	1860
8.2.5.3.1	Radio link failure / rlc-MaxNumRetx failure / EN-DC	1860
8.2.5.4	Reconfiguration failure / SCG change failure	1863
8.2.5.4.1	Reconfiguration failure / SCG change failure / EN-DC	1863
8.2.5.5	Reconfiguration failure / SCG Reconfiguration failure / SRB3	1867
8.2.5.5.1	Void	1867
8.2.5.6	Reconfiguration failure / SCG Reconfiguration failure / SRB1	1867
8.2.5.6.1	Void	1867
8.2.6	MR-DC RRC others	1867
8.2.6.1	Failure information / RLC failure / SCG	1867
8.2.6.1.1	Failure information / RLC failure / SCG / EN-DC	1867
8.2.6.1.1.1	Failure information / RLC failure / SCG / EN-DC / Intra-band Contiguous CA	1867
8.2.6.1.1.2	Failure information / RLC failure / SCG / EN-DC / Inter-band CA	1876
8.2.6.1.1.3	Failure information / RLC failure / SCG / EN-DC / Intra-band non Contiguous CA	1877
8.2.6.1.2	Failure information / RLC failure / SCG / NR-DC	1877
8.2.6.1.2.1	Failure information / RLC failure / SCG / NR-DC / Intra-band Contiguous CA	1877
8.2.6.1.2.2	Failure information / RLC failure / SCG / NR-DC / Inter-band CA	1887
8.2.6.1.2.3	Failure information / RLC failure / SCG / NR-DC / Intra-band non Contiguous CA	1887
8.2.6.2	Processing delay	1888
8.2.6.2.1	Processing delay / PSCell addition / SCG DRB / Success / Latency check / EN-DC	1888
9	Mobility management	1892
9.1	5GS Mobility Management	1892
9.1.1	Primary authentication and key agreement	1892
9.1.1.1	EAP based primary authentication and key agreement / EAP-AKA' related procedures	1892
9.1.1.2	EAP based primary authentication and key agreement / Reject	1896
9.1.1.3	EAP based primary authentication and key agreement / EAP message transport / Abnormal	1902
9.1.1.4	5G AKA based primary authentication and key agreement / 5G-AKA related procedures	1907
9.1.1.5	5G AKA based primary authentication and key agreement / Reject	1914
9.1.1.6	5G AKA based primary authentication and key agreement / Abnormal	1917
9.1.2	Security mode control	1922
9.1.2.1	NAS security mode command	1922
9.1.2.2	Protection of initial NAS signalling messages	1928
9.1.2.3	Integrity protection / Correct functionality of 5G NAS integrity algorithm / SNOW3G	1930
9.1.2.4	Integrity protection / Correct functionality of 5G NAS integrity algorithm / AES	1933
9.1.2.5	Integrity protection / Correct functionality of 5G NAS integrity algorithm / ZUC	1934
9.1.2.6	Ciphering and deciphering / Correct functionality of 5G NAS encryption algorithm / SNOW3G	1935
9.1.2.7	Ciphering and deciphering / Correct functionality of 5G NAS encryption algorithm / AES	1937
9.1.2.8	Ciphering and deciphering / Correct functionality of 5G NAS encryption algorithm / ZUC	1938
9.1.3	Identification	1939
9.1.3.1	Identification procedure	1939
9.1.4	Generic UE configuration update	1944
9.1.4.1	Generic UE configuration update / New 5G-GUTI, NITZ, registration requested, Network slicing indication, New Allowed NSSAI / acknowledgement from the UE	1944
9.1.5	Registration	1956
9.1.5.1	Initial Registration	1956
9.1.5.1.1	Initial registration / Success / 5G-GUTI reallocation, Last visited TAI	1956
9.1.5.1.2	Initial registration / SGS services / Equivalent PLMN list handling	1961
9.1.5.1.3	Initial registration / SGS services / NSSAI handling	1965
9.1.5.1.3a	Initial registration / SGS services / NSSAI handling / NSSAI Storage	1975
9.1.5.1.4	Initial registration / SGS services / MICO mode / TAI list handling	1985
9.1.5.1.5	Initial registration / Abnormal / Failure after 5 attempts	1988
9.1.5.1.6	Initial registration / Rejected / Illegal UE	1992
9.1.5.1.7	Void	1995
9.1.5.1.8	Initial registration / Rejected / Serving network not authorized	1995

9.1.5.1.9	Initial registration / Abnormal / Change of cell into a new tracking area	1996
9.1.5.1.10	Initial registration / Rejected / PLMN not allowed	1999
9.1.5.1.11	Initial registration / Rejected / Tracking area not allowed	2002
9.1.5.1.12	Initial registration / Rejected / Roaming not allowed in this tracking area	2006
9.1.5.1.13	Initial registration / Rejected / No suitable cells in tracking area	2010
9.1.5.1.14	Initial registration / Rejected / Congestion / Abnormal cases / T3346	2013
9.1.5.2	Mobility and periodic registration update	2017
9.1.5.2.1	Mobility registration update / TAI list handling	2017
9.1.5.2.2	Periodic registration update / Accepted	2023
9.1.5.2.3	2025
9.1.5.2.4	Mobility registration update / The lower layer requests NAS signalling connection recovery	2025
9.1.5.2.6	Void	2029
9.1.5.2.7	Mobility and periodic registration update / Rejected / UE identity cannot be derived by the network	2029
9.1.5.2.8	Mobility and periodic registration update / Rejected / Implicitly de-registered	2031
9.1.5.2.9	Mobility and periodic registration update / Abnormal / Change of cell into a new tracking area, collision with generic UE configuration update procedure	2035
9.1.6	De-registration	2037
9.1.6.1	UE-initiated de-registration	2037
9.1.6.1.1	UE-initiated de-registration / Switch off / Abnormal / De-registration and 5GMM common procedure collision	2037
9.1.6.1.2	UE-initiated de-registration / Normal de-registration / Abnormal / Transmission failure without TAI change from lower layers, De-registration and 5GMM common procedure collision, T3521 timeout	2042
9.1.6.1.3	UE-initiated de-registration / Abnormal / Change of cell into a new tracking area	2046
9.1.6.1.4	Void	2049
9.1.6.2	Network-initiated de-registration	2049
9.1.6.2.1	Network-initiated de-registration / De-registration for 3GPP access / Re-registration required	2049
9.1.6.2.2	Network-initiated de-registration / De-registration for 3GPP access / Re-registration not required	2051
9.1.7	Service request	2053
9.1.7.1	Service request / IDLE mode uplink user data transport / Rejected / Restricted service area, Abnormal / T3517, T3525	2053
9.1.7.2	Service request / CONNECTED mode user data transport / Abnormal / T3517	2059
9.1.8	SMS over NAS	2064
9.1.8.1	SMS over NAS / MO and MT SMS over NAS - Idle mode	2064
9.1.8.2	SMS over NAS / Multiple MO and MT SMS over NAS - CONNECTED mode	2072
9.2	5GS Non-3GPP Access Mobility Management	2077
9.2.1	Primary authentication and key agreement procedure	2077
9.2.1.1	EAP based primary authentication and key agreement	2077
9.2.1.2	5G AKA based primary authentication and key agreement	2079
9.2.2	Security Mode Control	2083
9.2.2.1	NAS security mode command	2083
9.2.2.2	Protection of initial NAS signalling messages	2089
9.2.3	Void	2091
9.2.4	Generic UE configuration	2091
9.2.4.1	Generic UE configuration update	2091
9.2.5	Registration	2100
9.2.5.1	Initial Registration	2100
9.2.5.1.1	Initial registration / Success / 5G-GUTI reallocation, Last visited TAI	2100
9.2.5.1.2	Initial registration / 5GS services / NSSAI handling	2103
9.2.5.1.3	Void	2112
9.2.5.1.4	Initial registration / Rejected / Congestion / Abnormal cases / T3346	2112
9.2.5.2	Mobility Registration	2116
9.2.5.2.1	Mobility registration update / registered slice(s) change	2116
9.2.5.2.2	Mobility registration update/Change of SMS over NAS capability	2117
9.2.6	De-registration	2119
9.2.6.1	UE-initiated de-registration	2119
9.2.6.1.1	UE-initiated de-registration / switch off	2119
9.2.6.2	Network-initiated de-registration	2123

9.2.6.2.1	Network-initiated de-registration / De-registration for Non-3GPP access / Re-registration required.....	2123
9.2.6.2.2	Network-initiated de-registration / De-registration for Non 3GPP access / Re-registration not required.....	2125
9.2.7	Service request.....	2129
9.2.7.1	Service request / IDLE mode uplink user data transport / Rejected / Restricted service area, Abnormal / T3517.....	2129
9.2.7.2	Service request / CMM CONNECTED mode/uplink user data transport / Abnormal / T3517.....	2133
9.2.8	SMS over NAS.....	2135
9.2.8.1	SMS over NAS / MO SMS over NAS - 5GMM-Idle mode.....	2135
9.3	Inter-system mobility.....	2138
9.3.1	5GS-EPC Inter-system mobility.....	2138
9.3.1.1	Inter-system mobility registration update / Single-registration mode with N26 / 5GMM-IDLE / 5GC to EPC.....	2138
9.3.1.2	Inter-system mobility registration update / Single-registration mode with N26 / 5GMM-IDLE / EPC to 5GC.....	2139
9.3.1.3	Inter-system mobility and periodic registration update / Rejected / Single-registration mode with N26 / Handling of EPC relevant parameters.....	2144
10	Session management.....	2147
10.1	5GS session management.....	2147
10.1.1	PDU session authentication and authorization.....	2147
10.1.1.1	PDU session authentication and authorization / during the UE-requested PDU session procedure.....	2147
10.1.1.2	PDU session authentication and authorization / after the UE-requested PDU session procedure.....	2153
10.1.2	Network-requested PDU session modification.....	2158
10.1.2.1	Network-requested PDU session modification / Accepted.....	2158
10.1.2.2	Network-requested PDU session modification / Abnormal / PDU session in state PDU SESSION INACTIVE.....	2169
10.1.3	Network-requested PDU session release.....	2172
10.1.3.1	Void.....	2172
10.1.3.2	Network-requested PDU session release / Accepted / Insufficient resources / T3396, Accepted / Insufficient resources for specific slice and DNN / T3584, Abnormal / No PDU session context active for the received PDU session ID.....	2172
10.1.4	UE-requested PDU session establishment.....	2182
10.1.4.1	UE-requested PDU session establishment / Abnormal / T3580.....	2182
10.1.5	UE-requested PDU session modification.....	2184
10.1.5.1	UE-requested PDU session modification.....	2184
10.1.6	UE-requested PDU session release.....	2186
10.1.6.1	UE-requested PDU session release / Abnormal / Collision with network-requested PDU session modification procedure.....	2186
10.1.6.2	UE-requested PDU session release / Abnormal / Collision with network-requested PDU session release procedure.....	2189
10.2	EN-DC session management.....	2192
10.2.1	Network initiated procedures.....	2192
10.2.1.1	Default EPS bearer context activation.....	2192
10.2.1.2	Dedicated EPS bearer context activation.....	2196
10.2.2	UE initiated procedures.....	2200
10.2.2.1	EPS bearer resource allocation / modification.....	2200
10.3	5GS Non-3GPP Access Session Management.....	2208
10.3.1	PDU session authentication and authorization.....	2208
10.3.1.1	PDU session authentication and authorization / during the UE-requested PDU session procedure.....	2208
10.3.2	Network-requested PDU session modification.....	2213
10.3.2.1	Network-requested PDU session modification /Accepted/Rejected.....	2213
10.3.3	Network-requested PDU session Release.....	2217
10.3.3.1	Network-requested PDU session release / accepted/ with and without reactivation.....	2217
10.3.4	UE-requested PDU session establishment.....	2222
10.3.4.1	UE-requested PDU session establishment / Abnormal / T3580.....	2222
10.3.5	UE-requested PDU session modification.....	2223
10.3.5.1	UE-requested PDU session modification/Success.....	2223

10.3.6	UE-requested PDU session release	2223
10.3.6.1	UE-requested PDU session release / Abnormal / Collision with network-requested PDU session modification procedure	2223
11	Multilayer Procedures	2225
11.1	5GS\EPS Fallback	2225
11.1.1	MO MMTEL voice call setup from NR RRC_IDLE / EPS Fallback with redirection / Single registration mode with N26 interface / Success	2225
11.1.2	MO MMTEL voice call setup from NR RRC_IDLE / EPS Fallback with redirection / Single registration mode without N26 interface / Success	2231
11.1.3	MO MMTEL voice call setup from NR RRC_CONNECTED / EPS Fallback with handover / Single registration mode with N26 interface / Success	2242
11.1.4	MO MMTEL voice call setup from NR RRC_CONNECTED / EPS Fallback with redirection / Single registration mode with N26 interface / E-UTRAN cell reselection using cell status barred / Success	2252
11.1.5	MO MMTEL voice call setup from NR RRC_CONNECTED / EPS Fallback with redirection / Single registration mode without N26 interface / E-UTRAN cell reselection using cell status reservation / Success	2265
11.1.6	MT MMTEL voice call setup from NR RRC_IDLE / EPS Fallback with redirection / Single registration mode without N26 interface / Success	2276
11.1.7	Emergency call setup from NR RRC_IDLE / Emergency Services Fallback to EPS with redirection / Single registration mode with N26 interface / Success	2286
11.1.8	2294
11.1.9	MO MMTEL voice call setup from NR RRC_IDLE / EPS Fallback with redirection / Single registration mode with N26 interface / voiceFallbackIndication	2294
11.2	5GS/RAT Fallback	2300
11.3	Unified Access Control (UAC)	2300
11.3.1	UAC / Access Identity 0 / 0% access probability / MTSI MO speech call/SMSoIP/Uplink User data transfer	2300
11.3.2	UAC / Access Identity 0 / 0% access probability / Paging for MT Access/Emergency Call	2312
11.3.3	UAC / Access Identity 0 / AC8 / RRC_INACTIVE / RNAUpdate/RRC Resume	2323
11.3.4	UAC / Access Identity 0 / Registration procedure for mobility and periodic registration update / BarringPerPLMN/Implicit AC Barring List	2327
11.3.5	UAC / Access Identity 1 / New cell not in the country of its HPLMN/EHPLMN 0% access probability/MPS indicator / HPLMN/0%/100% accessibility AC5/MMTEL-Video call	2336
11.3.6	UAC / Access Identity 2 / New cell not in the country of its HPLMN/EHPLMN 0% access probability/MCS indicator / HPLMN/0%/100% accessibility AC7/RRC_INACTIVE	2349
11.3.7	UAC / Access Identity 11..15 / High Priority Access / HPLMN/0% accessibility AC2/Emergency call	2362
11.3.8	UAC / Access Identity 0 / NR RRC_IDLE / Cell re-selection while T390 is running	2369
11.3.9	UAC / Access Identity 0 / ODAC / PLMN / RPLMN / not EPLMN	2379
11.4	Emergency Services	2386
11.4.1	5GMM-REGISTERED.NORMAL-SERVICE / 5GMM-IDLE / Emergency call / Utilising emergency number stored on the USIM / New emergency PDU session / Network failing the authentication check (5G AKA)	2386
11.4.2	5GMM-DEREGISTERED.LIMITED-SERVICE / Emergency call / Utilisation of emergency numbers stored on the ME / Initial registration for emergency services / Handling of forbidden PLMNs	2390
11.4.3	5GMM-DEREGISTERED.NO-SUPI / Emergency call / Utilisation of emergency numbers stored on the ME / Initial registration for emergency services	2396
11.4.4	5GMM-REGISTERED.ATTEMPTING-REGISTRATION-UPDATE T3346 running / Emergency call establishment / 5GMM-REGISTERED.NORMAL-SERVICE / Emergency call establishment before T3396 expiry	2400
11.4.5	5GMM-REGISTERED.LIMITED-SERVICE / 5GMM-IDLE / Emergency call establishment and release / Handling of 5GS forbidden tracking areas for roaming	2406
11.4.6	5GMM-REGISTERED.NON-ALLOWED-SERVICE / Emergency call establishment and release / Handling of non-allowed tracking areas	2409
11.4.7	Handling of Local and Extended emergency numbers / Mobility	2412
11.4.8	Handling of Local and extended emergency numbers / Switch-off and maximum local numbers storage	2424
11.4.9	5GMM-DEREGISTERED.LIMITED-SERVICE No suitable cells in tracking area / Emergency call establishment and release	2430

11.4.10	5GMM-REGISTERED.NORMAL-SERVICE / N26 interface not supported / N1 mode to S1 mode transfer of an existing emergency PDU session	2435
12	NR sidelink	2439
12.1	PC5-only operation	2439
12.2	Inter-carrier concurrent operation	2439
12.2.1	Inter-carrier concurrent operation / Sidelink communication	2439
12.2.1.1	2439
12.2.1.2	2439
12.2.1.3	Inter-carrier concurrent operation / Sidelink communication / RRC_CONNECTED / Transmission / Network scheduling	2439
12.2.2	2447
12.2.3	Inter-carrier concurrent operation / Measurement configuration and reporting via Uu RRC	2447
12.2.3.1	Inter-carrier concurrent operation / Measurement configuration and reporting via Uu RRC / CBR measurement reporting / Event C1 and C2	2447
Annex A (informative): Change history		2454
History		2481

Foreword

This Technical Specification has been produced by the 3rd Generation Partnership Project (3GPP).

The contents of the present document are subject to continuing work within the TSG and may change following formal TSG approval. Should the TSG modify the contents of the present document, it will be re-released by the TSG with an identifying change of release date and an increase in version number as follows:

Version x.y.z

where:

- x the first digit:
 - 1 presented to TSG for information;
 - 2 presented to TSG for approval;
 - 3 or greater indicates TSG approved document under change control.
- y the second digit is incremented for all changes of substance, i.e. technical enhancements, corrections, updates, etc.
- z the third digit is incremented when editorial only changes have been incorporated in the document.

In the present document, modal verbs have the following meanings:

- shall** indicates a mandatory requirement to do something
- shall not** indicates an interdiction (prohibition) to do something

The constructions "shall" and "shall not" are confined to the context of normative provisions, and do not appear in Technical Reports.

The constructions "must" and "must not" are not used as substitutes for "shall" and "shall not". Their use is avoided insofar as possible, and they are not used in a normative context except in a direct citation from an external, referenced, non-3GPP document, or so as to maintain continuity of style when extending or modifying the provisions of such a referenced document.

- should** indicates a recommendation to do something
- should not** indicates a recommendation not to do something
- may** indicates permission to do something
- need not** indicates permission not to do something

The construction "may not" is ambiguous and is not used in normative elements. The unambiguous constructions "might not" or "shall not" are used instead, depending upon the meaning intended.

- can** indicates that something is possible
- cannot** indicates that something is impossible

The constructions "can" and "cannot" are not substitutes for "may" and "need not".

- will** indicates that something is certain or expected to happen as a result of action taken by an agency the behaviour of which is outside the scope of the present document
- will not** indicates that something is certain or expected not to happen as a result of action taken by an agency the behaviour of which is outside the scope of the present document
- might** indicates a likelihood that something will happen as a result of action taken by some agency the behaviour of which is outside the scope of the present document

might not indicates a likelihood that something will not happen as a result of action taken by some agency the behaviour of which is outside the scope of the present document

In addition:

is (or any other verb in the indicative mood) indicates a statement of fact

is not (or any other negative verb in the indicative mood) indicates a statement of fact

The constructions "is" and "is not" do not indicate requirements.

The present document is part 1 of a multi-part deliverable covering the 5G System (5GS) User Equipment (UE) protocol conformance specification, as identified below:

- **3GPP TS 38.523-1: "5GS; User Equipment (UE) conformance specification; Part 1: Protocol"** (the present document).
- 3GPP TS 38.523-2 [2]: "5GS; User Equipment (UE) conformance specification; Part 2: Applicability of protocol test cases".
- 3GPP TS 38.523-3 [3]: "5GS; User Equipment (UE) conformance specification; Part 3: Protocol Test Suites".

1 Scope

The present document specifies the protocol conformance testing for the 3GPP UE connecting to the 5G System (5GS) via its radio interface(s).

The following information can be found in the present document (first part of a multi-part test specification):

- the overall test structure;
- the test configurations;
- the conformance requirement and references to the core specifications;
- the test purposes; and
- a brief description of the test procedure, the specific test requirements and short message exchange table.

The applicability of the individual test cases is specified in the ICS proforma specification (3GPP TS 38.523-2 [2]). The Test Suites are specified in part 3 (3GPP TS 38.523-3 [3]).

The present document is valid for UE implemented according to 3GPP Releases starting from Release 15 up to the Release indicated on the cover page of the present document.

2 References

The following documents contain provisions which, through reference in this text, constitute provisions of the present document.

- References are either specific (identified by date of publication, edition number, version number, etc.) or non-specific.
- For a specific reference, subsequent revisions do not apply.
- For a non-specific reference, the latest version applies. In the case of a reference to a 3GPP document (including a GSM document), a non-specific reference implicitly refers to the latest version of that document *in the same Release as the present document*.

- [1] 3GPP TR 21.905: "Vocabulary for 3GPP Specifications".
- [2] 3GPP TS 38.523-2: "5GS; UE conformance specification; Part 2: Implementation Conformance Statement (ICS) proforma specification".
- [3] 3GPP TS 38.523-3: "5GS; User Equipment (UE) conformance specification; Part 3: Protocol Test Suites".
- [4] 3GPP TS 38.508-1: "5GS; User Equipment (UE) conformance specification; Part 1: Common test environment".
- [5] 3GPP TS 38.508-2: "5GS; User Equipment (UE) conformance specification; Part 2: Common Implementation Conformance Statement (ICS) proforma".
- [6] 3GPP TS 38.509: "5GS; Special conformance testing functions for User Equipment (UE)".
- [7] 3GPP TS 36.508: "Evolved Universal Terrestrial Radio Access (E-UTRA) and Evolved Universal Terrestrial Radio Access (E-UTRAN); Common Test Environments for User Equipment (UE) Conformance Testing".
- [8] 3GPP TS 36.509: "Evolved Universal Terrestrial Radio Access (E-UTRA) and Evolved Universal Terrestrial Radio Access Network (E-UTRAN); Special conformance testing functions for User Equipment (UE)".
- [9] 3GPP TS 38.113: "New Radio (NR); Requirements for support of radio resource management".

- [10] 3GPP TS 36.133: "Evolved Universal Terrestrial Radio Access (E-UTRA); Requirements for support of radio resource management".
- [11] 3GPP TS 36.331: "Evolved Universal Terrestrial Radio Access (E-UTRA); Radio Resource Control (RRC); Protocol specification".
- [12] 3GPP TS 38.331: "NR; Radio Resource Control (RRC) protocol specification".
- [13] 3GPP TS 36.523-1: "Evolved Universal Terrestrial Radio Access (E-UTRA) and Evolved Packet Core (EPC); User Equipment (UE) conformance specification; Part 1: Protocol conformance specification".
- [14] 3GPP TS 38.212: "NR; Multiplexing and channel coding".
- [15] 3GPP TS 38.214: "NR; Physical layer procedures for data".
- [16] 3GPP TS 38.101-1: "NR; User Equipment (UE) radio transmission and reception; Part 1: Range 1 Standalone".
- [17] 3GPP TS 38.101-2: "NR; User Equipment (UE) radio transmission and reception; Part 2: Range 2 Standalone".
- [18] 3GPP TS 38.321: "NR; Medium Access Control (MAC) protocol specification".
- [19] 3GPP TS 38.323: "NR; Packet Data Convergence Protocol (PDCP) specification".
- [20] 3GPP TS 33.501: "Security Architecture and Procedures for 5G System".
- [21] 3GPP TS 24.301: "Non-Access-Stratum (NAS) protocol for Evolved Packet System (EPS); Stage 3".
- [22] 3GPP TS 24.501: "Non-Access-Stratum (NAS) protocol for 5G System (5GS); Stage 3".
- [23] 3GPP TS 38.306: "NR: User Equipment (UE) radio access capabilities"[24] 3GPP TS 38.211: "NR; Physical channels and modulation".
- [25] 3GPP TS 36.523-3: "Evolved Universal Terrestrial Radio Access (E-UTRA) and Evolved Universal Terrestrial Radio Access (E-UTRAN); User Equipment (UE) conformance specification; Part 3: Abstract Test Suites (ATS)".
- [26] 3GPP TS 38.300: "NR; NR and NG-RAN Overall Description; Stage 2".
- [27] 3GPP TS 38.322: "NR; Radio Link Control (RLC) protocol specification".
- [28] 3GPP TS 37.340: "NR; Multi-connectivity; Overall description; Stage-2".
- [29] 3GPP TS 36.523-2: " Evolved Universal Terrestrial Radio Access (E-UTRA) and Evolved Packet Core (EPC); User Equipment (UE) conformance specification; Part 2: Implementation Conformance Statement (ICS) proforma specification".
- [30] 3GPP TS 38.133: " NR; Requirements for support of radio resource management".
- [31] 3GPP TS 23.502: "Procedures for the 5G System; Stage 2".
- [32] IETF RFC 7296: "Internet Key Exchange Protocol Version 2 (IKEv2)".
- [33] 3GPP TS 24.502: "Access to the 3GPP 5G Core Network (5GCN) via Non-3GPP Access Networks (N3AN); Stage 3".
- [34] 3GPP TS 23.003: "Numbering, addressing and identification".
- [35] 3GPP TS 34.229-1: "Internet Protocol (IP) multimedia call control protocol based on Session Initiation Protocol (SIP) and Session Description Protocol (SDP); User Equipment (UE) conformance specification; Part 1: Protocol conformance specification".
- [36] 3GPP TS 31.102: "Characteristics of the Universal Subscriber Identity Module (USIM) application".

- [37] 3GPP TS 23.501: "System Architecture for the 5G System; Stage 2".
- [38] 3GPP TS 23.122: "Non-Access-Stratum functions related to Mobile Station (MS) in idle mode".
- [39] GSMA PRD IR.88: "LTE and EPC Roaming Guidelines".
- [40] 3GPP TS 27.007: "AT command set for User Equipment (UE)".
- [41] 3GPP TS 34.229-5: "Internet Protocol (IP) multimedia call control protocol based on Session Initiation Protocol (SIP) and Session Description Protocol (SDP); User Equipment (UE) conformance specification; Part 5: Protocol conformance specification using 5G System (5GS)".
- [42] 3GPP TS 22.101: "Service aspects; Service principles".
- [43] 3GPP TS 24.008: "Mobile radio interface Layer 3 specification; Core network protocols; Stage 3".

3 Definitions, symbols and abbreviations

3.1 Definitions

For the purposes of the present document, the terms and definitions given in TR 21.905 [1], specifications referred to in the tests' Conformance requirements clauses and the following apply. A term defined in the present document takes precedence.

Floor: Floor(x) is the largest integer smaller than or equal to x.

Ceil: Ceil (x) is the smallest integer larger than or equal to x.

3.2 Symbols

For the purposes of the present document, symbols defined in specifications referred to in the tests' Conformance requirements clauses and the following apply. A symbol defined in the present document takes precedence.

None.

3.3 Abbreviations

For the purposes of the present document, the abbreviations given in TR 21.905 [1]], specifications referred to in the tests' Conformance requirements clauses and the following apply. An abbreviation defined in the present document takes precedence.

ICS	Implementation Conformance Statement
FFS	For Further Study

4 Overview

4.1 Test methodology

4.1.1 Testing of optional functions and procedures

Any function or procedure which is optional, as indicated in the present document may be subject to a conformance test if it is implemented in the UE.

A declaration by the apparatus supplier (ICS) is used to determine whether an optional function/procedure has been implemented.

4.1.2 Test interfaces and facilities

Detailed descriptions of the UE test interfaces and special facilities for testing are provided in TS 38.509 [6].

4.2 Implicit testing

For some 3GPP signalling and protocol features conformance is not verified explicitly in the present document. This does not imply that correct functioning of these features is not essential, but that these are implicitly tested to a sufficient degree in other tests.

Implicit testing of 5GS requirements may be done also in tests specified in other 3GPP conformance test specifications. For clarity these are listed below:

- Indication for support of EN-DC: if the UE supports E-UTRA-NR dual connectivity, then the UE shall set the DCNR bit to "dual connectivity with NR supported" in the UE network capability IE of the ATTACH REQUEST/TRACKING AREA UPDATE REQUEST message; verified implicitly (the setting of the DCNR bit to 1) by tests specified in TS 36.523-1 [13].

NOTE 1: It is assumed that an UE supporting EN-DC will support EPS (legacy LTE) and therefore it will be tested against all relevant legacy LTE tests.

4.3 Repetition of tests

As a general rule, the test cases specified in the present document are highly reproducible and don't need to be repeated unless otherwise stated. However, the rate of correct UE behaviour such as cell re-selection, measurement and handover is specified statistically, e.g. "at least 90%" [8], [9]. Additionally, in some of the test cases, presented in TS 38.523-3 [3], HARQ retransmissions are not tolerated, because of characteristics of the test case. In such cases a repetition of test may be required. Details are FFS.

4.4 Handling of differences between conformance requirements in different releases of core specifications

The conformance requirements which determine the scope of each test case are explicitly copy-pasted from relevant core specifications in the especially dedicated for this clause of each test with the title 'Conformance requirements'.

NOTE: When in the copy/pasted text there are references to other specifications the reference numbers will not match the reference numbers used in the present document. This approach has been taken in order to allow easy copy and then search for conformance requirements in those specifications.

When differences between conformance requirements in different releases of the cores specifications have impact on the Pre-test conditions, Test procedure sequence or/and the Specific message contents, the Conformance requirements related to different releases are specified separately with clear indication of the Release of the spec from which they were copied.

When there is no Release indicated for a conformance requirement text, this should be understood either as the Conformance requirements in the latest version of the spec with release = the TC Applicability release (which can be found in the column 'Release' for the relevant for the test case entry in the tables in TS 38.523-2 [2], subclause 4.1, or, as the Conformance requirements in the latest version of the spec of the release when the feature was introduced to the core specs.

5 Reference conditions, generic and test procedures, test parameters

5.1 Reference conditions

The reference environments used by all signalling tests in the present document are specified in TS 38.508-1 [4]. If a test requires an environment that is different to those specified in TS 38.508-1 [4] then, this shall be specified in the test itself.

5.2 Generic and test procedures

A set of basic generic procedures for bringing the UE into a specific signalling state, as well as, test procedures comprising well defined actions after the UE enters a specific state are specified in TS 38.508-1 [4]. These procedures are used (referred to) in numerous test cases throughout the present document.

5.3 Test parameters

5.3.1 PLMNs

PLMN identifiers such as PLMN1, PLMN2, etc. are used in test cases to associate a cell with an MCC and MNC for that cell.

Whenever a PLMN identifier is provided explicitly in a test description without explicit MCC and MNC values, the MCC and MNC values corresponding to the PLMN identifier shall be understood as those specified in TS 36.523-1 [42], Table 6.0.1-1.

If no PLMN is explicitly specified in the test then the PLMN(s) specified for the relevant cell(s) in TS 38.508-1 [4] (NR cells) or 36.508 [2] (E-UTRA cells) apply. If no PLMN is explicitly specified in the test nor in the TS 38.508-1 [4] (NR cells) or 36.508 [2] (E-UTRA cells) for the used in the test cell(s) then the PLMN used in the test is the one defined as PLMN1 in TS 36.523-1 [42], Table 6.0.1-1.

5.3.2 Cells

Cell identifiers such as NR Cell 1 and NGC Cell A (for NR cells), or, Cell 1 and Cell A (for E-UTRA cells). are used in test cases to associate a cell with various parameters.

Cells used in the tests throughout the present document are defined in TS 38.508-1 [4], subclauses 4.4.2 and 6.3.2.2 for NR cells, and, TS 36.508 [2], subclauses 4.4.2 and 6.3.2 for E-UTRA cells respectively. Signal levels for signalling tests are defined in TS 38.508-1 [4], subclause 6.2.2 and TS 36.508 [2], subclause 6.2.2.

Associated with the Cells used in the test cases are a number of parameters e.g. Tracing Area Identifiers (TAIs) such as TAI-1, TAI-2, etc., specific MCC and MNC values for the simulated PLMN, etc. For Default NAS parameters for simulated NR cells and Simulated network scenarios for NAS test cases for 5GS these are defined in TS 38.508-1 [4], subclauses 4.4.2 and 6.3.2.1 respectively. Similarly such parameters are defined in TS 36.508 [2] for E-UTRA cells.

Whenever a Cell identifier is provided explicitly in a test description without explicit definition of parameters, the parameters values corresponding to the Cell identifier shall be understood as those specified in TS 38.508-1 [4] or TS 36.523-1 [42] respectively for the cell with that identifier.

Whenever a test in the present document requires cells characteristics, e.g. power level settings, TAIs, MCC/MNC which differ to those specified in TS 38.508-1 [4] for NR cells or in TS 36.508 [2] for E-UTRA cells then, these shall be specified explicitly in the test itself.

5.3.3 USIM

Default USIM fields and signalling test case specific USIM Configurations are specified in TS 38.508-1 [4], subclause 6.4.

Whenever a test in the present document does not provide an explicit reference to a specific USIM Configurations specified in TS 38.508-1 [4], subclause 6.4 then, the default parameters specified in TS 38.508-1 [4], subclause 4.8.3 shall be assumed.

Whenever a test in the present document requires specific USIM settings which do not exist in any of the defined USIM Configurations in TS 38.508-1 [4], it is recommended that a new USIM Configuration is defined and then the configuration is referred from the test. Defining specific USIM setting within a test definition should be avoided.

5.3.4 Messages and Information Elements (IEs)

Default Messages and IE contents, and where applicable IE fields values, used by the tests defined in the present document are specified in TS 38.508-1 [4], subclauses 4.6, 4.7 and 4.7A. For messages exchanged on other RAT e.g. E-UTRAN/EPC these can be found in TS 36.508 [2].

If a test requires a message and/or IE contents and/or IE field value which is different to those specified in TS 38.508-1 [4] then, specific message content shall be specified in the test itself with a derivation path referring to the relevant default message in TS 38.508-1 [4]. Whenever a specific message content is not explicitly provided in a test then this shall be understood as the message having exactly the same content as the default message specified in TS 38.508-1 [4].

NOTE: Similar rules apply to messages exchanged on other RATs and defined elsewhere e.g. in TS 36.508 [2].

6 Idle mode operations

6.1 NR idle mode operations

Editor's note: Intended to capture tests of Idle Mode behaviour defined in TS 38.304

FFS

6.1.1 NG-RAN Only PLMN Selection

6.1.1.1 PLMN selection of RPLMN, HPLMN/EHPLMN, UPLMN and OPLMN / Automatic mode

6.1.1.1.1 Test Purpose (TP)

(1)

```
with { UE in Automatic network selection mode and RPLMN, HPLMN, UPLMN and OPLMN NR cells available
and UE is fitted with a USIM indicating RPLMN should be selected }
ensure that {
  when { UE is switched on or return to coverage }
  then { UE selects a cell of the RPLMN and UE attempts Registration on the selected cell }
}
```

(2)

```
with { UE camped on an NG-RAN VPLMN cell and cells of a higher priority NG-RAN PLMN available }
ensure that {
  when { higher priority PLMN search timer T expires }
  then { UE selects and camps on a cell of the highest priority PLMN and UE attempts Registration
with mobility on the selected cell }
}
```

(3)

```

with { UE in Automatic network selection mode and HPLMN, UPLMN and OPLMN NG-RAN cells available and
UE is fitted with a USIM with Access Technology data files for each PLMN and there are no equivalent
HPLMNs defined}
ensure that {
  when { UE is switched on or return to coverage }
  then { UE selects a cell of the highest priority PLMN and UE attempts Registration with mobility
on the selected cell }
}

```

(4)

```

with { UE camped on an NR VPLMN cell and cells of a NG-RAN HPLMN available }
ensure that {
  when { higher priority PLMN search timer T expires }
  then { UE selects and camps on a cell of HPLMN and UE attempts Registration on the selected cell
}
}

```

6.1.1.1.2 Conformance requirements

References: The conformance requirements covered in the present TC are specified in: TS 23.122 clauses 4.4.3.1, 4.4.3.1.1 and 4.4.3.3.1. Unless otherwise stated these are Rel-15 requirements.

[TS 23.122, clause 4.4.3.1]

At switch on, or following recovery from lack of coverage, the MS selects the registered PLMN or equivalent PLMN (if it is available) using all access technologies that the MS is capable of and if necessary (in the case of recovery from lack of coverage, see subclause 4.5.2) attempts to perform a Location Registration.

NOTE 1: The MS in automatic network selection mode can end the PLMN search procedure once the registered PLMN or equivalent PLMN is found on an access technology.

NOTE 2: An MS in automatic network selection mode can use location information to determine which PLMNs can be available in its present location.

EXCEPTION: As an alternative option to this, if the MS is in automatic network selection mode and it finds coverage of an EHPLMN, the MS may register to that EHPLMN and not return to the registered PLMN or equivalent PLMN. If the EHPLMN list is not present or is empty, and the HPLMN is available, the MS may register on the HPLMN and not return to the registered PLMN or equivalent PLMN. The operator shall be able to control by SIM configuration whether an MS that supports this option is permitted to perform this alternative behaviour.

EXCEPTION: In A/Gb mode an MS with voice capability, shall not search for CPBCCCH carriers. In A/Gb mode an MS not supporting packet services shall not search for CPBCCCH carriers.

If successful registration is achieved, the MS indicates the selected PLMN.

If there is no registered PLMN, or if registration is not possible due to the PLMN being unavailable or registration failure, the MS follows one of the following two procedures depending on its PLMN selection operating mode. At switch on, if the MS provides the optional feature of user preferred PLMN selection operating mode at switch on then this operating mode shall be used. Otherwise, the MS shall use the PLMN selection mode that was used before switching off.

EXCEPTION: At switch on, if the MS is in manual mode and neither registered PLMN nor PLMN that is equivalent to it is available but EHPLMN is available, then instead of performing the manual network selection mode procedure of subclause 4.4.3.1.2 the MS may select and attempt registration on the highest priority EHPLMN. If the EHPLMN list is not available or is empty and the HPLMN is available, then the MS may select and attempt registration on the HPLMN. The MS shall remain in manual mode.

NOTE 3: If successful registration is achieved, then the current serving PLMN becomes the registered PLMN and the MS does not store the previous registered PLMN for later use.

EXCEPTION: If registration is not possible on recovery from lack of coverage due to the registered PLMN being unavailable, an MS attached to GPRS services, attached via E-UTRAN or registered via the NG-RAN may, optionally, continue looking for the registered PLMN for an implementation dependent time.

NOTE 4: An MS attached to GPRS services, attached via E-UTRAN or registered via the NG-RAN should use the above exception only if one or more PDP contexts, PDN connections or PDU sessions are currently active.

[TS 23.122, clause 4.4.3.1.1]

The MS selects and attempts registration on other PLMN/access technology combinations, if available and allowable, in the following order:

- i) either the HPLMN (if the EHPLMN list is not present or is empty) or the highest priority EHPLMN that is available (if the EHPLMN list is present) ;
- ii) each PLMN/access technology combination in the "User Controlled PLMN Selector with Access Technology" data file in the SIM (in priority order);
- iii) each PLMN/access technology combination in the "Operator Controlled PLMN Selector with Access Technology" data file in the SIM (in priority order);
- iv) other PLMN/access technology combinations with received high quality signal in random order;
- v) other PLMN/access technology combinations in order of decreasing signal quality.

When following the above procedure the following requirements apply:

- a) An MS with voice capability shall ignore PLMNs for which the MS has identified at least one GSM COMPACT.
- b) In A/Gb mode or GSM COMPACT, an MS with voice capability, or an MS not supporting packet services shall not search for CPBCCCH carriers.
- c) In ii and iii, the MS should limit its search for the PLMN to the access technology or access technologies associated with the PLMN in the appropriate PLMN Selector with Access Technology list (User Controlled or Operator Controlled selector list).

An MS using a SIM without access technology information storage (i.e. the "User Controlled PLMN Selector with Access Technology" and the "Operator Controlled PLMN Selector with Access Technology" data files are not present) shall instead use the "PLMN Selector" data file, for each PLMN in the "PLMN Selector" data file, the MS shall search for all access technologies it is capable of. The priority ordering amongst the access technologies is implementation dependent.

- d) In iv and v, the MS shall search for all access technologies it is capable of, before deciding which PLMN to select.
- e) In ii, and iii, a packet only MS which supports GSM COMPACT, but using a SIM without access technology information storage (i.e. the "User Controlled PLMN Selector with Access Technology" and the "Operator Controlled PLMN Selector with Access Technology" data files are not present) shall instead use the "PLMN Selector" data file, for each PLMN in the "PLMN Selector" data file, the MS shall search for all access technologies it is capable of and shall assume GSM COMPACT access technology as the lowest priority radio access technology.
- f) In i, the MS shall search for all access technologies it is capable of. No priority is defined for the preferred access technology and the priority is an implementation issue, but "HPLMN Selector with Access Technology" data file on the SIM may be used to optimise the procedure.
- g) In i, an MS using a SIM without access technology information storage (i.e. the "HPLMN Selector with Access Technology" data file is not present) shall search for all access technologies it is capable of. The priority ordering amongst the access technologies is implementation dependent. A packet only MS which supports GSM COMPACT using a SIM without access technology information storage shall also assume GSM COMPACT access technology as the lowest priority radio access technology.

NOTE 1: For f) and g), the MS in automatic network selection mode can end the PLMN search procedure once the HPLMN or the highest priority EHPLMN is found on an access technology.

NOTE 2: For i, ii and iii, the MS can use location information to determine which PLMNs can be available in its present location.

- h) In v, the MS shall order the PLMN/access technology combinations in order of decreasing signal quality within each access technology. The order between PLMN/access technology combinations with different access technologies is an MS implementation issue.

NOTE 3: Requirements a) and b) apply also to requirement d), so a GSM voice capable MS should not search for GSM COMPACT PLMNs, even if capable of GSM COMPACT.

NOTE 4: Requirements a) and b) apply also to requirement f), so a GSM voice capable MS should not search for GSM COMPACT PLMNs, even if this is the only access technology on the "HPLMN Selector with Access Technology" data file on the SIM.

NOTE 5: High quality signal is defined in the appropriate AS specification.

- i) In i to v, the MS shall not consider PLMNs where voice service was not possible as PLMN selection candidate, unless such PLMN is available in GERAN or UTRAN or no other allowed PLMN is available.
- j) In i to v, if the MS only supports EMM-REGISTERED without PDN connection (see TS 24.301 [23A]), the MS shall not consider PLMNs which do not advertise support of EMM-REGISTERED without PDN connection.
- k) In i to v, if the MS only supports control plane CIoT EPS optimization (see TS 24.301 [23A]) and the UE camps on a E-UTRA cell which is not NB-IoT cell (see TS 36.304 [43], TS 36.331 [22]), the MS shall not consider PLMNs which do not advertise support of EPS services with control plane CIoT EPS optimization.
- l) In i to v, if the MS is in eCall only mode, the MS shall not consider PLMNs which do not advertise support for eCall over IMS, unless such PLMNs are available in GERAN or UTRAN.

NOTE 6: As an implementation option, an MS in eCall only mode that was not able to select any PLMN according to l) can perform a second iteration of i to v with no restriction.

If successful registration is achieved, the MS indicates the selected PLMN.

If registration cannot be achieved because no PLMNs are available and allowable, the MS indicates "no service" to the user, waits until a new PLMN is available and allowable and then repeats the procedure.

If there were one or more PLMNs which were available and allowable, but an LR failure made registration on those PLMNs unsuccessful or an entry in any of the lists "forbidden location areas for roaming", "forbidden tracking areas for roaming", "5GS forbidden tracking areas for roaming", "forbidden location areas for regional provision of service", "forbidden tracking areas for regional provision of service" or "5GS forbidden tracking areas for regional provision of service" prevented a registration attempt, the MS selects the first such PLMN again and enters a limited service state.

[TS 23.122, clause 4.4.3.3.1]

If the MS is in a VPLMN, the MS shall periodically attempt to obtain service on its HPLMN (if the EHPLMN list is not present or is empty) or one of its EHPLMNs (if the EHPLMN list is present) or a higher priority PLMN/access technology combinations listed in "user controlled PLMN selector" or "operator controlled PLMN selector" by scanning in accordance with the requirements that are applicable to i), ii) and iii) as defined in the Automatic Network Selection Mode in subclause 4.4.3.1.1. In the case that the mobile has a stored "Equivalent PLMNs" list the mobile shall only select a PLMN if it is of a higher priority than those of the same country as the current serving PLMN which are stored in the "Equivalent PLMNs" list. For this purpose, a value of timer T may be stored in the SIM. The interpretation of the stored value depends on the radio capabilities supported by the MS:

- For an MS that does not support any of the following: EC-GSM-IoT, Category M1 or Category NB1 (as defined in TS 36.306 [54]), T is either in the range 6 minutes to 8 hours in 6 minute steps or it indicates that no periodic attempts shall be made. If no value for T is stored in the SIM, a default value of 60 minutes is used for T.
- For an MS that only supports any of the following or a combination of: EC-GSM-IoT, Category M1 or Category NB1 (as defined in TS 36.306 [54]), T is either in the range 2 hours to 240 hours, using 2 hour steps from 2 hours to 80 hours and 4 hour steps from 84 hours to 240 hours, or it indicates that no periodic attempts shall be made. If no value for T is stored in the SIM, a default value of 72 hours is used.
- For an MS that supports both:
 - a) any of the following or a combination of: EC-GSM-IoT, Category M1 or Category NB1 (as defined in 3GPP TS 36.306 [54]); and

- b) any access technology other than the following: EC-GSM-IoT, Category M1 or Category NB1 (as defined in 3GPP TS 36.306 [54]),

then T is interpreted depending on the access technology in use as specified below:

- 1) if the MS is using any of the following at the time of starting timer T: EC-GSM-IoT, Category M1 or Category NB1 (as defined in 3GPP TS 36.306 [54]), T is either in the range 2 hours to 240 hours, using 2 hour steps from 2 hours to 80 hours and 4 hour steps from 84 hours to 240 hours, or it indicates that no periodic attempts shall be made. If no value for T is stored in the SIM, a default value of 72 hours is used; and
- 2) if the MS is not using any of the following at the time of starting timer T: EC-GSM-IoT, Category M1 or Category NB1 (as defined in 3GPP TS 36.306 [54]), T is either in the range 6 minutes to 8 hours in 6 minute steps or it indicates that no periodic attempts shall be made. If no value for T is stored in the SIM, a default value of 60 minutes is used for T.

If the MS is configured with the MinimumPeriodicSearchTimer as specified in 3GPP TS 24.368 [50] or 3GPP TS 31.102 [40], the MS shall not use a value for T that is less than the MinimumPeriodicSearchTimer. If the value stored in the SIM, or the default value for T (when no value is stored in the SIM), is less than the MinimumPeriodicSearchTimer, then T shall be set to the MinimumPeriodicSearchTimer.

The MS does not stop timer T, as described in 3GPP TS 24.008 [23] and 3GPP TS 24.301 [23A], when it activates power saving mode (PSM) (see 3GPP TS 23.682 [27A]).

The MS can be configured for Fast First Higher Priority PLMN search as specified in 3GPP TS 31.102 [40] or 3GPP TS 24.368 [50]. Fast First Higher Priority PLMN search is enabled if the corresponding configuration parameter is present and set to enabled. Otherwise, Fast First Higher Priority PLMN search is disabled.

The attempts to access the HPLMN or an EHPLMN or higher priority PLMN shall be as specified below:

- a) The periodic attempts shall only be performed in automatic mode when the MS is roaming, and not while the MS is attached for emergency bearer services, is registered for emergency services, has a PDU session for emergency services or has a PDN connection for emergency bearer services;
- b) The MS shall make the first attempt after a period of at least 2 minutes and at most T minutes:
 - only after switch on if Fast First Higher Priority PLMN search is disabled; or
 - after switch on or upon selecting a VPLMN if Fast First Higher Priority PLMN search is enabled.
- c) The MS shall make the following attempts if the MS is on the VPLMN at time T after the last attempt;
- d) Periodic attempts shall only be performed by the MS while in idle mode;
- d1) Periodic attempts may be postponed while the MS is in power saving mode (PSM) (see 3GPP TS 23.682 [27A]).
- d2) Periodic attempts may be postponed while the MS is receiving eMBMS transport service in idle mode (see 3GPP TS 23.246 [68]).
- e) If the HPLMN (if the EHPLMN list is not present or is empty) or a EHPLMN (if the list is present) or a higher priority PLMN is not found, the MS shall remain on the VPLMN.
- f) In steps i), ii) and iii) of subclause 4.4.3.1.1 the MS shall limit its attempts to access higher priority PLMN/access technology combinations to PLMN/access technology combinations of the same country as the current serving VPLMN, as defined in Annex B.
- g) Only the priority levels of Equivalent PLMNs of the same country as the current serving VPLMN, as defined in Annex B, shall be taken into account to compare with the priority level of a selected PLMN.
- h) If the PLMN of the highest priority PLMN/access technology combination available is the current VPLMN, or one of the PLMNs in the "Equivalent PLMNs" list, the MS shall remain on the current PLMN/access technology combination.

6.1.1.1.3 Test description

6.1.1.1.3.1 Pre-test conditions

System Simulator:

- Four multi-PLMN NR Cells as specified in TS 38.508-1 [4] Table 4.4.2.1 are configured broadcasting PLMNs as indicated in Table 6.1.1.1.3.1-1.
- The PLMNs are identified in the test by the identifiers in Table 6.1.1.1.3.1-1 and the PLMN settings are defined in TS 36.523-1 [13] table 6.0.1-1.

Table 6.1.1.1.3.1-1: PLMN identifiers

NR Cell	PLMN name
1	PLMN1
12	PLMN15
13	PLMN16
2	PLMN17

All NR cells are high quality

All NR cells are suitable cells;

System information combination NR-1 as defined in TS 38.508-1 [4] clause 4.4.3.1.2 is used in NR cells

UE:

The UE is in Automatic PLMN selection mode.

The UE is registered to PLMN1 before it is switched off.

USIM configuration as defined in TS 38.508-1 [4] Table 6.4.1-1 will be loaded except for PLMN identifiers in Table 6.1.1.1.3.1-1.

Preamble:

- The UE is made to camp on NR Cell 12 and then Switched OFF (State ON-B) as defined in TS 38.508-1 [4] Table 4.4A.2-0

6.1.1.1.3.2 Test procedure sequence

Table 6.1.1.1.3.2-1 for FR1 and Table 6.1.1.1.3.2-2 for FR2 illustrates the downlink power levels and other changing parameters to be applied for the cells at various time instants of the test execution. Row marked "T0" denotes the initial conditions after preamble, while columns marked "T1", "T2" and "T3" are to be applied subsequently in the Main behaviour. The exact instants on which these values shall be applied are described in the texts in this clause.

Table 6.1.1.1.3.2-1: Cell configuration changes over time for FR1

	Parameter	Unit	NR Cell 1	NR Cell 12	NR Cell 13	NR Cell 2	Remarks
T0	SS/PBCH SSS EPRE	dBm/SCS	"Off"	-88	"Off"	"Off"	Power level "Off" is defined in TS 38.508-1 Table 6.2.2.1-3
T1	SS/PBCH SSS EPRE	dBm/SCS	-88	-88	-88	"Off"	Power level "Off" is defined in TS 38.508-1 Table 6.2.2.1-3
T2	SS/PBCH SSS EPRE	dBm/SCS	"Off"	-88	-88	"Off"	Power level "Off" is defined in TS 38.508-1 Table 6.2.2.1-3
T3	SS/PBCH SSS EPRE	dBm/SCS	"Off"	-88	-88	-88	Power level "Off" is defined in TS 38.508-1 Table 6.2.2.1-3

Table 6.1.1.1.3.2-2: Cell configuration changes over time for FR2

	Parameter	Unit	NR Cell 1	NR Cell 12	NR Cell 13	NR Cell 2	Remarks
T0	SS/PBCH SSS EPRE	dBm/SCS	"Off"	[-85]	"Off"	"Off"	Power level "Off" is defined in TS 38.508-1 Table 6.2.2.1-3
T1	SS/PBCH SSS EPRE	dBm/SCS	[-85]	[-85]	[-85]	"Off"	Power level "Off" is defined in TS 38.508-1 Table 6.2.2.1-3
T2	SS/PBCH SSS EPRE	dBm/SCS	"Off"	[-85]	[-85]	"Off"	Power level "Off" is defined in TS 38.508-1 Table 6.2.2.1-3
T3	SS/PBCH SSS EPRE	dBm/SCS	"Off"	[-85]	[-85]	[-85]	Power level "Off" is defined in TS 38.508-1 Table 6.2.2.1-3

Table 6.1.1.1.3.2-2: Main behaviour

St	Procedure	Message Sequence		TP	Verdict
		U - S	Message		
1	SS adjusts cell levels according to row T1 of table 6.1.1.1.3.2-1 for FR1 and table 6.1.1.1.3.2-2 for FR2	-	-	-	-
2	Power on the UE.	-	-	-	-
3	Check: Does the UE send a <i>RRCSetupRequest</i> on NR Cell 12?	-->	<i>RRCSetupRequest</i>	1	P
4-21	Steps 3 to 20 of the registration procedure described in TS 38.508-1 subclause 4.5.2.2-2 are performed on NR Cell 12. NOTE: The UE performs registration and the RRC connection is released.	-	-	-	-
22	Check: Does the UE send a <i>RRCSetupRequest</i> on NR Cell 1 after 120 seconds, but before 660seconds (Note 1 and 2) from power on?	-->	<i>RRCSetupRequest</i>	4	P
22 A-22 B	Steps 3-4 of Table 4.5.2.2-2 of the generic procedure in TS 38.508-1 [4] are performed. (Note 3)	-	-	-	-
-	EXCEPTION: Steps 23a1 to 23b5 describe behaviour that depends on events happening prior to their execution; the "lower case letter" identifies a step sequence that take place if a specific prior event takes place,	-	-	-	-
23a 1-23a 17a 1	IF 5GS registration type is set as Initial Registration in step 22B, THEN Steps 4 to 20a1 of the generic test procedure in TS 38.508-1 Table 4.5.2.2-2 are performed on NR Cell 1.	-	-	-	-
23b 1-23b 2	Void	-	-	-	-
23b 3-23b 5a1	IF 5GS registration type is set as Mobility Registration in step 22B, THEN Steps 4 to 6a1 of the generic test procedure in TS 38.508-1 Table 4.9.5.2.2-1 are performed on NR Cell 1.	-	-	-	-
24-27	Void	-	-	-	-
28	SS adjusts cell levels according to row T2 of table 6.1.1.1.3.2-2 for FR1 and table 6.1.1.1.3.2-1 for FR2	-	-	-	-
29	Check: Does the UE send a <i>RRCSetupRequest</i> on NR Cell 13?	-	-	3	P
29 A-29 B	Steps 3-4 of Table 4.5.2.2-2 of the generic procedure in TS 38.508-1 [4] are performed. (Note 3)	-	-	-	-
-	EXCEPTION: Steps 29a1 to 29b5 describe behaviour that depends on events happening prior to their execution; the "lower case letter" identifies a step sequence that take place if a specific prior event takes place,	-	-	-	-
29a 1-29a 17a 1	IF 5GS registration type is set as Initial Registration in step 29B, THEN Steps 4 to 20a1 of the generic test procedure in TS 38.508-1 Table 4.5.2.2-2 are performed on NR Cell 13.	-	-	3	P
29b 1-29b 2	Void.	-	-	-	-

29b 3- 29b 5a1	IF 5GS registration type is set as Mobility Registration in step 29B, THEN Steps 4 to 6a1 of the generic test procedure in TS 38.508-1 Table 4.9.5.2.2-1 are performed on NR Cell 13.	-	-	3	-
30	SS adjusts cell levels according to row T3 of table 6.1.1.1.3.2-1 for FR1 and table 6.1.1.1.3.2-2 for FR2	-	-	-	-
31	Check: Does the UE send a <i>RRCSetupRequest</i> on NR Cell 2 after 120 seconds, but before 660 seconds after step 30? (Note 1 and 2)	-->	<i>RRCSetupRequest</i>	2	P
31 A- 31 B	Steps 3-4 of Table 4.5.2.2-2 of the generic procedure in TS 38.508-1 [4] are performed. (Note 3)	-	-	-	-
-	EXCEPTION: Steps 32a1 to 32b5 describe behaviour that depends on events happening prior to their execution; the "lower case letter" identifies a step sequence that take place if a specific prior event takes place,	-	-	-	-
32a 1- 32a 17a 1	IF 5GS registration type is set as Initial Registration in step 31B, THEN Steps 4 to 20a1 of the generic test procedure in TS 38.508-1 Table 4.5.2.2-2 are performed on NR Cell 2.	-	-	-	-
32b 1- 32b 2	Void	-	-	-	-
32b 3- 32b 5a1	IF 5GS registration type is set as Mobility Registration in step 31B, THEN Steps 4 to 6a1 of the generic test procedure in TS 38.508-1 Table 4.9.5.2.2-1 are performed on NR Cell 2.	-	-	-	-
33- 36	Void	-	-	-	-
<p>Note 1: Following attempts to access the HPLMN/EHPLMN/higher priority PLMN in VPLMN is operator specific setting (Refer to TS 23.122 Rel-15). Hence, window between 120s to T+Tolerance is being used, where the high priority PLMN search timer T defined by EF_{HPLMN}.</p> <p>Note 2: Tolerance of 5min is added to allow time for the UE to find the proper PLMN.</p> <p>Note 3: The 5GS registration type shall be only set as Mobility Registration for R16 UEs according to TS 24.501 subclause 5.2.3.2.5 specified in Release 16. The EXCEPTION description applies only to R15 UEs.</p>					

6.1.1.1.3.3 Specific message contents

None

6.1.1.2 PLMN selection of "Other PLMN/access technology combinations" / Automatic mode

6.1.1.2.1 Test Purpose (TP)

(1)

```

with { UE in Automatic network selection mode and EHPLMN, UPLMN and OPLMN/access technology
combinations cells available and UE is fitted with a USIM with Access Technology data files for each
PLMN }
ensure that {
  when { UE is switched on or return to coverage }
  then { UE selects a cell of the EHPLMN and UE attempts a Registration on the selected cell }
}

```

(2)

```

with { UE in Automatic network selection mode and UPLMN, OPLMN and other PLMN/access technology
combinations cells available and UE is fitted with a USIM with Access Technology data files for each
PLMN }
ensure that {
  when { UE is switched on or return to coverage }
  then { UE selects a cell of the UPLMN and UE attempts a Registration on the selected cell }
}

```

(3)

```

with { UE in Automatic network selection mode and OPLMN and other PLMN/access technology
combinations cells available and UE is fitted with a USIM with Access Technology data files for each
PLMN }
ensure that {
  when { UE is switched on or return to coverage }
  then { UE selects a cell of the OPLMN and UE attempts a Registration on the selected cell }
}

```

(4)

```

with { UE in Automatic network selection mode and other PLMN/access technology combinations cells
not belonging to any of EHPLMN, UPLMN or OPLMN available }
ensure that {
  when { UE is switched on or return to coverage }
  then { UE selects a cell of other PLMN/access technology combinations and UE attempts a
Registration on the selected cell }
}

```

6.1.1.2.2 Conformance requirements

References: The conformance requirements covered in the current TC are specified in: TS 23.122 clauses 4.4.3.1.1. Unless otherwise stated these are Rel-15 requirements.

[TS 23.122, clause 4.4.3.1.1]

The MS selects and attempts registration on other PLMN/access technology combinations, if available and allowable, in the following order:

- i) either the HPLMN (if the EHPLMN list is not present or is empty) or the highest priority EHPLMN that is available (if the EHPLMN list is present) ;
- ii) each PLMN/access technology combination in the "User Controlled PLMN Selector with Access Technology" data file in the SIM (in priority order);
- iii) each PLMN/access technology combination in the "Operator Controlled PLMN Selector with Access Technology" data file in the SIM (in priority order);
- iv) other PLMN/access technology combinations with received high quality signal in random order;
- v) other PLMN/access technology combinations in order of decreasing signal quality.

When following the above procedure the following requirements apply:

- a) An MS with voice capability shall ignore PLMNs for which the MS has identified at least one GSM COMPACT.
- b) In A/Gb mode or GSM COMPACT, an MS with voice capability, or an MS not supporting packet services shall not search for CPBCCCH carriers.

- c) In ii and iii, the MS should limit its search for the PLMN to the access technology or access technologies associated with the PLMN in the appropriate PLMN Selector with Access Technology list (User Controlled or Operator Controlled selector list).

An MS using a SIM without access technology information storage (i.e. the "User Controlled PLMN Selector with Access Technology" and the "Operator Controlled PLMN Selector with Access Technology" data files are not present) shall instead use the "PLMN Selector" data file, for each PLMN in the "PLMN Selector" data file, the MS shall search for all access technologies it is capable of. The priority ordering amongst the access technologies is implementation dependent.

- d) In iv and v, the MS shall search for all access technologies it is capable of, before deciding which PLMN to select.
- e) In ii, and iii, a packet only MS which supports GSM COMPACT, but using a SIM without access technology information storage (i.e. the "User Controlled PLMN Selector with Access Technology" and the "Operator Controlled PLMN Selector with Access Technology" data files are not present) shall instead use the "PLMN Selector" data file, for each PLMN in the "PLMN Selector" data file, the MS shall search for all access technologies it is capable of and shall assume GSM COMPACT access technology as the lowest priority radio access technology.
- f) In i, the MS shall search for all access technologies it is capable of. No priority is defined for the preferred access technology and the priority is an implementation issue, but "HPLMN Selector with Access Technology" data file on the SIM may be used to optimise the procedure.
- g) In i, an MS using a SIM without access technology information storage (i.e. the "HPLMN Selector with Access Technology" data file is not present) shall search for all access technologies it is capable of. The priority ordering amongst the access technologies is implementation dependent. A packet only MS which supports GSM COMPACT using a SIM without access technology information storage shall also assume GSM COMPACT access technology as the lowest priority radio access technology.

NOTE 1: For f) and g), the MS in automatic network selection mode can end the PLMN search procedure once the HPLMN or the highest priority EHPLMN is found on an access technology.

NOTE 2: For i, ii and iii, the MS can use location information to determine which PLMNs can be available in its present location.

- h) In v, the MS shall order the PLMN/access technology combinations in order of decreasing signal quality within each access technology. The order between PLMN/access technology combinations with different access technologies is an MS implementation issue.

NOTE 3: Requirements a) and b) apply also to requirement d), so a GSM voice capable MS should not search for GSM COMPACT PLMNs, even if capable of GSM COMPACT.

NOTE 4: Requirements a) and b) apply also to requirement f), so a GSM voice capable MS should not search for GSM COMPACT PLMNs, even if this is the only access technology on the "HPLMN Selector with Access Technology" data file on the SIM.

NOTE 5: High quality signal is defined in the appropriate AS specification.

- i) In i to v, the MS shall not consider PLMNs where voice service was not possible as PLMN selection candidate, unless such PLMN is available in GERAN or UTRAN or no other allowed PLMN is available.
- j) In i to v, if the MS only supports EMM-REGISTERED without PDN connection (see 3GPP TS 24.301 [23A]), the MS shall not consider PLMNs which do not advertise support of EMM-REGISTERED without PDN connection.
- k) In i to v, if the MS only supports control plane CIoT EPS optimization (see 3GPP TS 24.301 [23A]) and the UE camps on a E-UTRA cell which is not NB-IoT cell (see 3GPP TS 36.304 [43], 3GPP TS 36.331 [22]), the MS shall not consider PLMNs which do not advertise support of EPS services with control plane CIoT EPS optimization.
- l) In i to v, if the MS is in eCall only mode, the MS shall not consider PLMNs which do not advertise support for eCall over IMS, unless such PLMNs are available in GERAN or UTRAN.

NOTE 6: As an implementation option, an MS in eCall only mode that was not able to select any PLMN according to I) can perform a second iteration of i to v with no restriction.

If successful registration is achieved, the MS indicates the selected PLMN.

If registration cannot be achieved because no PLMNs are available and allowable, the MS indicates "no service" to the user, waits until a new PLMN is available and allowable and then repeats the procedure.

If there were one or more PLMNs which were available and allowable, but an LR failure made registration on those PLMNs unsuccessful or an entry in any of the lists "forbidden location areas for roaming", "forbidden tracking areas for roaming", "5GS forbidden tracking areas for roaming", "forbidden location areas for regional provision of service", "forbidden tracking areas for regional provision of service" or "5GS forbidden tracking areas for regional provision of service" prevented a registration attempt, the MS selects the first such PLMN again and enters a limited service state.

6.1.1.2.3 Test description

6.1.1.2.3.1 Pre-test conditions

System Simulator:

- Four inter-frequency multi-PLMN cells as specified in TS 38.508-1 [4] clause 4.4.1.1.3 are configured broadcasting default PLMNs as indicated in TS 38.508-1 [4] Table 4.4.2-3.
- The PLMNs are identified in the test by the identifiers in Table 6.1.1.2.3.1-1.

Table 6.1.1.2.3.1-1: PLMN identifiers

NR Cell	PLMN name
1	PLMN1
12	PLMN2
13	PLMN3
11	PLMN4

UE:

- The UE is in Automatic PLMN selection mode.
- The UE is equipped with a USIM configuration as defined in TS 38.508-1 [4] Table 6.4.1-4.

Preamble:

- Ensure that the UE has cleared the RPLMN. And the UE is in state Switched OFF (state 0-A).

6.1.1.2.3.2 Test procedure sequence

Table 6.1.1.2.3.2-1/2 shows the cell configurations used during the test. Subsequent configurations marked "T1", "T2" "T3" "T4" etc are applied at the points indicated in the Main behaviour description in Table 6.1.1.2.3.2-3. Cell powers are chosen for a serving cell and a non-suitable "Off" cell as defined in TS 38.508-1 [4] Table 6.2.2.1-3 for FR1 and Table 6.2.2.2-2 for FR2.

Table 6.1.1.2.3.2-1: Time instances of cell power level and parameter changes for FR1

	Parameter	Unit	NR Cell 1	NR Cell 12	NR Cell 13	NR Cell 11	Remarks
T1	SS/PBCH SSS EPRE	dBm/SCS	-88	-88	-88	"Off"	Power level "Off" is defined in TS 38.508-1 [4] Table 6.2.2.1-3.
T2	SS/PBCH SSS EPRE	dBm/SCS	"Off"	-88	-88	-88	Power level "Off" is defined in TS 38.508-1 [4] Table 6.2.2.1-3.
T3	SS/PBCH SSS EPRE	dBm/SCS	"Off"	"Off"	-88	-88	Power level "Off" is defined in TS 38.508-1 [4] Table 6.2.2.1-3.
T4	SS/PBCH SSS EPRE	dBm/SCS	"Off"	"Off"	"Off"	-88	Power level "Off" is defined in TS 38.508-1 [4] Table 6.2.2.1-3.

Table 6.1.1.2.3.2-2: Time instances of cell power level and parameter changes for FR2

	Parameter	Unit	NR Cell 1	NR Cell 12	NR Cell 13	NR Cell 11	Remarks
T1	SS/PBCH SSS EPRE	dBm/SCS	-82	-82	-82	"Off"	Power level "Off" is defined in TS 38.508-1 [4] Table 6.2.2.2-2.
T2	SS/PBCH SSS EPRE	dBm/SCS	"Off"	-82	-82	-82	Power level "Off" is defined in TS 38.508-1 [4] Table 6.2.2.2-2.
T3	SS/PBCH SSS EPRE	dBm/SCS	"Off"	"Off"	-82	-82	Power level "Off" is defined in TS 38.508-1 [4] Table 6.2.2.2-2.
T4	SS/PBCH SSS EPRE	dBm/SCS	"Off"	"Off"	"Off"	-82	Power level "Off" is defined in TS 38.508-1 [4] Table 6.2.2.2-2.

Table 6.1.1.2.3.2-3: Main behaviour

St	Procedure	Message Sequence		TP	Verdict
		U - S	Message		
1	SS adjusts cell levels according to row T1 of table 6.1.1.2.3.2-1/2.	-	-	-	-
2	Power on the UE.	-	-	-	-
3	Check: Does the UE send an <i>RRCSetupRequest</i> on NR Cell 1?	-->	NR RRC: <i>RRCSetupRequest</i>	1	P
4-21	Steps 3 to 20a1 of the registration procedure described in TS 38.508-1 [4] subclause 4.5.2.2 are performed on NR Cell 1. NOTE: The UE performs registration and the RRC connection is not released.	-	-	-	-
21A	The UE is switched off by executing generic procedure in Table 4.9.6.3-1 in TS 38.508-1 [4]	-	-	-	-
22	SS adjusts cell levels according to row T2 of table 6.1.1.2.3.2-1/2.	-	-	-	-
22A	Void	-	-	-	-
22B	The UE is Switched ON.	-	-	-	-
23	Check: Does the test result of generic test procedure in TS 38.508-1 [4] Table 4.5.2.2-2 indicate that the UE is camped on NR Cell 12? NOTE: The UE performs registration and the RRC connection is not released.	-->	-	2	P
24-27b1	Void	-	-	-	-
28	The UE is switched off by executing generic procedure in Table 4.9.6.3-1 in TS 38.508-1 [4].	-	-	-	-
29	SS adjusts cell levels according to row T3 of table 6.1.1.2.3.2-1/2.	-	-	-	-
29A	Void.	-	-	-	-
29B	The UE is Switched ON.	-	-	-	-
30	Check: Does the test result of generic test procedure in TS 38.508-1 [4] Table 4.5.2.2-2 indicate that the UE is camped on NR Cell 13? NOTE: The UE performs registration and the RRC connection is not released.	-->	-	3	P
31-34b1	Void.	-	-	-	-
35	The UE is switched off by executing generic procedure in Table 4.9.6.3-1 in TS 38.508-1 [4]	-	-	-	-
36	SS adjusts cell levels according to row T4 of table 6.1.1.2.3.2-1/2.	-	-	-	-
36A	Void.	-	-	-	-
36B	The UE is Switched ON.	-	-	-	-
37	Check: Does the test result of generic test procedure in TS 38.508-1 [4] Table 4.5.2.2-2 indicate that the UE is camped on NR Cell 11?	-->	-	4	P
38-42b1	Void.	-	-	-	-

6.1.1.2.3.3 Specific message contents

None

6.1.1.3 Cell reselection of ePLMN in manual mode

6.1.1.3.1 Test Purpose (TP)

(1)

```
with { UE camped normally on a cell and network has downloaded a list of equivalent PLMNs during the
Registration procedure }
ensure that {
  when { Higher ranked cell is a cell of a PLMN in the downloaded equivalent PLMN list }
  then { UE reselects to the equivalent PLMN cell }
}
```

(2)

```
with { UE camped normally on a cell and network has downloaded a list of equivalent PLMNs during
Registration procedure for mobility }
ensure that {
  when { Highest ranked cell is a cell of a PLMN not in the downloaded equivalent PLMN list }
  then { UE does not reselect to the cell }
}
```

6.1.1.3.2 Conformance requirements

References: The conformance requirements covered in the current TC are specified in: TS 23.122, clauses 4.4.3.1.2. Unless otherwise stated these are Rel-15 requirements.

[TS 23.122, clause 4.4.3.1.2]

The MS selects and attempts registration on other PLMN/access technology combinations, if available and allowable, in the following order:

- i) either the HPLMN (if the EHPLMN list is not present or is empty) or the highest priority EHPLMN that is available (if the EHPLMN list is present) ;
- ii) each PLMN/access technology combination in the "User Controlled PLMN Selector with Access Technology" data file in the SIM (in priority order);
- iii) each PLMN/access technology combination in the "Operator Controlled PLMN Selector with Access Technology" data file in the SIM (in priority order);
- iv) other PLMN/access technology combinations with received high quality signal in random order;
- v) other PLMN/access technology combinations in order of decreasing signal quality.

When following the above procedure the following requirements apply:

- a) An MS with voice capability shall ignore PLMNs for which the MS has identified at least one GSM COMPACT.
- b) In A/Gb mode or GSM COMPACT, an MS with voice capability, or an MS not supporting packet services shall not search for CPBCCCH carriers.
- c) In ii and iii, the MS should limit its search for the PLMN to the access technology or access technologies associated with the PLMN in the appropriate PLMN Selector with Access Technology list (User Controlled or Operator Controlled selector list).

An MS using a SIM without access technology information storage (i.e. the "User Controlled PLMN Selector with Access Technology" and the "Operator Controlled PLMN Selector with Access Technology" data files are not present) shall instead use the "PLMN Selector" data file, for each PLMN in the "PLMN Selector" data file, the MS shall search for all access technologies it is capable of. The priority ordering amongst the access technologies is implementation dependent.

- d) In iv and v, the MS shall search for all access technologies it is capable of, before deciding which PLMN to select.

- e) In ii, and iii, a packet only MS which supports GSM COMPACT, but using a SIM without access technology information storage (i.e. the "User Controlled PLMN Selector with Access Technology" and the "Operator Controlled PLMN Selector with Access Technology" data files are not present) shall instead use the "PLMN Selector" data file, for each PLMN in the "PLMN Selector" data file, the MS shall search for all access technologies it is capable of and shall assume GSM COMPACT access technology as the lowest priority radio access technology.
- f) In i, the MS shall search for all access technologies it is capable of. No priority is defined for the preferred access technology and the priority is an implementation issue, but "HPLMN Selector with Access Technology" data file on the SIM may be used to optimise the procedure.
- g) In i, an MS using a SIM without access technology information storage (i.e. the "HPLMN Selector with Access Technology" data file is not present) shall search for all access technologies it is capable of. The priority ordering amongst the access technologies is implementation dependent. A packet only MS which supports GSM COMPACT using a SIM without access technology information storage shall also assume GSM COMPACT access technology as the lowest priority radio access technology.

NOTE 1: For f) and g), the MS in automatic network selection mode can end the PLMN search procedure once the HPLMN or the highest priority EHPLMN is found on an access technology.

NOTE 2: For i, ii and iii, the MS can use location information to determine which PLMNs can be available in its present location.

- h) In v, the MS shall order the PLMN/access technology combinations in order of decreasing signal quality within each access technology. The order between PLMN/access technology combinations with different access technologies is an MS implementation issue.

NOTE 3: Requirements a) and b) apply also to requirement d), so a GSM voice capable MS should not search for GSM COMPACT PLMNs, even if capable of GSM COMPACT.

NOTE 4: Requirements a) and b) apply also to requirement f), so a GSM voice capable MS should not search for GSM COMPACT PLMNs, even if this is the only access technology on the "HPLMN Selector with Access Technology" data file on the SIM.

NOTE 5: High quality signal is defined in the appropriate AS specification.

- i) In i to v, the MS shall not consider PLMNs where voice service was not possible as PLMN selection candidate, unless such PLMN is available in GERAN or UTRAN or no other allowed PLMN is available.
- j) In i to v, if the MS only supports EMM-REGISTERED without PDN connection (see 3GPP TS 24.301 [23A]), the MS shall not consider PLMNs which do not advertise support of EMM-REGISTERED without PDN connection.
- k) In i to v, if the MS only supports control plane CIoT EPS optimization (see 3GPP TS 24.301 [23A]) and the UE camps on a E-UTRA cell which is not NB-IoT cell (see 3GPP TS 36.304 [43], 3GPP TS 36.331 [22]), the MS shall not consider PLMNs which do not advertise support of EPS services with control plane CIoT EPS optimization.
- l) In i to v, if the MS is in eCall only mode, the MS shall not consider PLMNs which do not advertise support for eCall over IMS, unless such PLMNs are available in GERAN or UTRAN.

NOTE 6: As an implementation option, an MS in eCall only mode that was not able to select any PLMN according to l) can perform a second iteration of i to v with no restriction.

If successful registration is achieved, the MS indicates the selected PLMN.

If registration cannot be achieved because no PLMNs are available and allowable, the MS indicates "no service" to the user, waits until a new PLMN is available and allowable and then repeats the procedure.

If there were one or more PLMNs which were available and allowable, but an LR failure made registration on those PLMNs unsuccessful or an entry in any of the lists "forbidden location areas for roaming", "forbidden tracking areas for roaming", "5GS forbidden tracking areas for roaming", "forbidden location areas for regional provision of service", "forbidden tracking areas for regional provision of service" or "5GS forbidden tracking areas for regional provision of service" prevented a registration attempt, the MS selects the first such PLMN again and enters a limited service state.

6.1.1.3.3 Test description

6.1.1.3.3.1 Pre-test conditions

System Simulator

- Three inter-frequency multi-PLMN NR cells.
- Each NR cell has only a single PLMN identity. The PLMNs are identified in the test by the identifiers in Table 6.1.1.3.3.1-1.

Table 6.1.1.3.3.1-1: PLMN identifiers

NR Cell	PLMN name
1	PLMN1
12	PLMN2
13	PLMN3

- System information combination NR-4 as defined in TS 38.508-1 [4] clause 4.4.3.1.2-1 is used in NR cell 1 and NR cell 12.
- System information combination NR-1 as defined in TS 38.508-1 [4] clause 4.4.3.1.2-1 is used in NR cell 13.

UE

- The UE is in Manual PLMN selection mode.

Preamble

- The UE is registered on PLMN1 (NR Cell 1) using the procedure described in TS 38.508-1 [4] clause 4.5.2.2-2 except that the REGISTRATION ACCEPT message indicates PLMN2 in the Equivalent PLMN list as described in Table 6.1.1.3.3.3-3.
- The UE is in state Registered, Idle Mode (state 1N-A) on NR Cell 1 according to TS 38.508-1 [4];

6.1.1.3.3.2 Test procedure sequence

Table 6.1.1.3.3.2-1: Time instances of cell power level and parameter changes for FR1

	Parameter	Unit	NR Cell 1	NR Cell 12	NR Cell 13	Remarks
T1	SS/PBCH SSS EPRE	dBm/SCS	-99	-88	-78	
T2	SS/PBCH SSS EPRE	dBm/SCS	"Off"	"Off"	"Off"	Power level "Off" is defined in TS 38.508-1 [4] Table 6.2.2.1-3

Table 6.1.1.3.3.2-2: Time instances of cell power level and parameter changes for FR2

	Parameter	Unit	NR Cell 1	NR Cell 12	NR Cell 13	Remarks
T1	SS/PBCH SSS EPRE	dBm/SCS	FFS	FFS	FFS	
T2	SS/PBCH SSS EPRE	dBm/SCS	"Off"	"Off"	"Off"	Power level "Off" is defined in TS 38.508-1 [4] Table 6.2.2.2-2

Table 6.1.1.3.3.2-3: Main behaviour

St	Procedure	Message Sequence		TP	Verdict
		U - S	Message		
1	SS adjusts cell levels according to row T1 of table 6.1.1.3.3.2-1/2.	-	-	-	-
2	Check: Does the test result of generic test procedure in TS 38.508-1 [4] subclause 4.9.5.2.2-1 indicate that the UE is camped on NR Cell 12? NOTE: The REGISTRATION REQUEST is accepted with PLMN1 listed as an Equivalent PLMN.	-	-	1	-
3	Check: Does the UE send an <i>RRCSetupRequest</i> on NR Cell 13 within 60s?	-->	NR RRC: <i>RRCSetupRequest</i>	2	F
4	SS adjusts cell levels according to row T2 of table 6.1.1.3.3.2-1/2.	-	-	-	-
5	Set UE to Automatic PLMN selection mode. (Note 1)	-	-	-	-

Note 1: Step 5 is to ensure UE is set back to automatic PLMN selection mode for the next test case.

6.1.1.3.3.3 Specific message contents

Table 6.1.1.3.3.3-1: SIB4 for NR Cell 1 (preamble and all steps, Table 6.1.1.3.3.2-3)

Derivation path: TS 38.508-1 [4] Table 4.6.2-3			
Information Element	Value/Remark	Comment	Condition
SIB4 ::= SEQUENCE {			
interFreqCarrierFreqList SEQUENCE (SIZE (1..maxFreq)) OF InterFreqCarrierFreqInfo {	2 entries		
InterFreqCarrierFreqInfo[1] SEQUENCE {		entry 1	
dl-CarrierFreq	Same downlink NR ARFCN as used for NR Cell 12		
cellReselectionPriority	4		
}			
InterFreqCarrierFreqInfo[2] SEQUENCE {		entry 2	
dl-CarrierFreq	Same downlink NR ARFCN as used for NR Cell 13		
cellReselectionPriority	4		
}			
}			
}			

Table 6.1.1.3.3.2-2: SIB4 for NR Cell 12 (preamble and all steps, Table 6.1.1.3.3.2-3)

Derivation path: TS 38.508-1 [4] Table 4.6.2-3			
Information Element	Value/Remark	Comment	Condition
SIB4 ::= SEQUENCE {			
interFreqCarrierFreqList SEQUENCE (SIZE (1..maxFreq)) OF nterFreqCarrierFreqInfo {	2 entries		
InterFreqCarrierFreqInfo[1] SEQUENCE {		entry 1	
dl-CarrierFreq	Same downlink NR ARFCN as used for NR Cell 1		
cellReselectionPriority	4		
}			
InterFreqCarrierFreqInfo[2] SEQUENCE {		entry 2	
dl-CarrierFreq	Same downlink NR ARFCN as used for NR Cell 13		
cellReselectionPriority	4		
}			
}			
}			

Table 6.1.1.3.3.3-3: REGISTRATION ACCEPT for NR Cell 1 (preamble)

Derivation path: TS 38.508-1 [4] Table 4.7.1-7			
Information Element	Value/Remark	Comment	Condition
Equivalent PLMNs	PLMN2		NR Cell 1

Table 6.1.1.3.3.3-4: REGISTRATION ACCEPT for NR Cell 12 (step 2, Table 6.1.1.3.3.2-3)

Derivation path: TS 38.508-1 [4] Table 4.7.1-7			
Information Element	Value/Remark	Comment	Condition
Equivalent PLMNs	PLMN1		NR Cell 12

6.1.1.4 PLMN selection in shared network environment / Automatic mode

6.1.1.4.1 Test Purpose (TP)

(1)

```
with { The UE is in automatic network selection mode and there is a suitable cell with multiple PLMN identities among which the HPLMN but not the registered PLMN }
ensure that {
  when { the UE is switched on }
  then { the UE attaches to the HPLMN on the shared cell }
}
```

(2)

```
with { the UE in automatic network selection mode and there is a suitable cell with multiple PLMN identities among which the registered PLMN }
ensure that {
  when { the UE returns to coverage }
  then { the UE performs a registration procedure due to mobility to the registered PLMN on the shared cell }
}
```

6.1.1.4.2 Conformance requirements

References: The conformance requirements covered in the current TC are specified in: TS 38.304 clause 5.1.1.2, TS 23.122 clauses 4.4.3 and 4.4.3.1.1, TS 38.331 clauses 5.3.3.4, and TS 24.501 clause 5.3.1.1. Unless otherwise stated these are Rel-15 requirements.

[TS 38.304 clause 5.1.1.2]

The UE shall scan all RF channels in the NR bands according to its capabilities to find available PLMNs. On each carrier, the UE shall search for the strongest cell and read its system information, in order to find out which PLMN(s) the cell belongs to. If the UE can read one or several PLMN identities in the strongest cell, each found PLMN (see the PLMN reading in TS 38.331 [3]) shall be reported to the NAS as a high quality PLMN,

...

Once the UE has selected a PLMN, the cell selection procedure shall be performed in order to select a suitable cell of that PLMN to camp on.

[TS 23.122 clauses 4.4.3]

When the MS reselects to a cell in a shared network, and the cell is a suitable cell for multiple PLMN identities received on the BCCH or on the EC-BCCH the AS indicates these multiple PLMN identities to the NAS according to 3GPP TS 44.018 [34], 3GPP TS 44.060 [39], 3GPP TS 25.304 [32] and 3GPP TS 36.304 [43]. The MS shall choose one of these PLMNs. If the registered PLMN is available among these PLMNs, the MS shall not choose a different PLMN.

The MS shall not use the PLMN codes contained in the "HPLMN Selector with Access Technology" data file.

It is possible for the home network operator to identify alternative Network IDs as the HPLMN. If the EHPLMN list is present, and not empty, the entries in the EHPLMN list are used in the network selection procedures. When attempting to select a network the highest priority EHPLMN that is available shall be selected. If the EHPLMN list is present and is empty or if the EHPLMN list is not present, the HPLMN derived from the IMSI is used for network selection procedures.

NOTE 1: The "HPLMN Selector with Access Technology" data file is only used by the MS to get the HPLMN access technologies related to the HPLMN code which corresponds to the PLMN code included in the IMSI if the EHPLMN list is not present or is empty. If the EHPLMN list is present then this data field is applicable to all the entries within the EHPLMN list.

NOTE 2: Different GSM frequency bands (e.g. 900, 1800, 1900, 400) are all considered GSM access technology. An MS supporting more than one band should scan all the bands it's supports when scanning for GSM frequencies. However GSM COMPACT systems which use GSM frequency bands but with the CBPCCH broadcast channel are considered as a separate access technology from GSM.

NOTE 3: The inclusion of the HPLMN derived from the IMSI in the EHPLMN list is allowed. The priority of the HPLMN derived from the IMSI is given by its position in the EHPLMN list, see 3GPP TS 31.102 [40]

[TS 23.122 clause 4.4.3.1.1]

The MS selects and attempts registration on other PLMN/access technology combinations, if available and allowable, in the following order:

- i) either the HPLMN (if the EHPLMN list is not present or is empty) or the highest priority EHPLMN that is available (if the EHPLMN list is present) ;
- ii) each PLMN/access technology combination in the "User Controlled PLMN Selector with Access Technology" data file in the SIM (in priority order);
- iii) each PLMN/access technology combination in the "Operator Controlled PLMN Selector with Access Technology" data file in the SIM (in priority order);
- iv) other PLMN/access technology combinations with received high quality signal in random order;
- v) other PLMN/access technology combinations in order of decreasing signal quality.

When following the above procedure the following requirements apply:

- a) An MS with voice capability shall ignore PLMNs for which the MS has identified at least one GSM COMPACT.
- b) In A/Gb mode or GSM COMPACT, an MS with voice capability, or an MS not supporting packet services shall not search for CPBCCH carriers.

- c) In ii and iii, the MS should limit its search for the PLMN to the access technology or access technologies associated with the PLMN in the appropriate PLMN Selector with Access Technology list (User Controlled or Operator Controlled selector list).

An MS using a SIM without access technology information storage (i.e. the "User Controlled PLMN Selector with Access Technology" and the "Operator Controlled PLMN Selector with Access Technology" data files are not present) shall instead use the "PLMN Selector" data file, for each PLMN in the "PLMN Selector" data file, the MS shall search for all access technologies it is capable of. The priority ordering amongst the access technologies is implementation dependent.

- d) In iv and v, the MS shall search for all access technologies it is capable of, before deciding which PLMN to select.
- e) In ii, and iii, a packet only MS which supports GSM COMPACT, but using a SIM without access technology information storage (i.e. the "User Controlled PLMN Selector with Access Technology" and the "Operator Controlled PLMN Selector with Access Technology" data files are not present) shall instead use the "PLMN Selector" data file, for each PLMN in the "PLMN Selector" data file, the MS shall search for all access technologies it is capable of and shall assume GSM COMPACT access technology as the lowest priority radio access technology.
- f) In i, the MS shall search for all access technologies it is capable of. No priority is defined for the preferred access technology and the priority is an implementation issue, but "HPLMN Selector with Access Technology" data file on the SIM may be used to optimise the procedure.
- g) In i, an MS using a SIM without access technology information storage (i.e. the "HPLMN Selector with Access Technology" data file is not present) shall search for all access technologies it is capable of. The priority ordering amongst the access technologies is implementation dependent. A packet only MS which supports GSM COMPACT using a SIM without access technology information storage shall also assume GSM COMPACT access technology as the lowest priority radio access technology.

NOTE 1: For f) and g), the MS in automatic network selection mode can end the PLMN search procedure once the HPLMN or the highest priority EHPLMN is found on an access technology.

NOTE 2: For i, ii and iii, the MS can use location information to determine which PLMNs can be available in its present location.

- h) In v, the MS shall order the PLMN/access technology combinations in order of decreasing signal quality within each access technology. The order between PLMN/access technology combinations with different access technologies is an MS implementation issue.

NOTE 3: Requirements a) and b) apply also to requirement d), so a GSM voice capable MS should not search for GSM COMPACT PLMNs, even if capable of GSM COMPACT.

NOTE 4: Requirements a) and b) apply also to requirement f), so a GSM voice capable MS should not search for GSM COMPACT PLMNs, even if this is the only access technology on the "HPLMN Selector with Access Technology" data file on the SIM.

NOTE 5: High quality signal is defined in the appropriate AS specification.

- i) In i to v, the MS shall not consider PLMNs where voice service was not possible as PLMN selection candidate, unless such PLMN is available in GERAN or UTRAN or no other allowed PLMN is available.
- j) In i to v, if the MS only supports EMM-REGISTERED without PDN connection (see 3GPP TS 24.301 [23A]), the MS shall not consider PLMNs which do not advertise support of EMM-REGISTERED without PDN connection.
- k) In i to v, if the MS only supports control plane CIoT EPS optimization (see 3GPP TS 24.301 [23A]) and the UE camps on a E-UTRA cell which is not NB-IoT cell (see 3GPP TS 36.304 [43], 3GPP TS 36.331 [22]), the MS shall not consider PLMNs which do not advertise support of EPS services with control plane CIoT EPS optimization.
- l) In i to v, if the MS is in eCall only mode, the MS shall not consider PLMNs which do not advertise support for eCall over IMS, unless such PLMNs are available in GERAN or UTRAN.

NOTE 6: As an implementation option, an MS in eCall only mode that was not able to select any PLMN according to I) can perform a second iteration of i to v with no restriction.

If successful registration is achieved, the MS indicates the selected PLMN.

If registration cannot be achieved because no PLMNs are available and allowable, the MS indicates "no service" to the user, waits until a new PLMN is available and allowable and then repeats the procedure.

If there were one or more PLMNs which were available and allowable, but an LR failure made registration on those PLMNs unsuccessful or an entry in any of the lists "forbidden location areas for roaming", "forbidden tracking areas for roaming", "5GS forbidden tracking areas for roaming", "forbidden location areas for regional provision of service", "forbidden tracking areas for regional provision of service" or "5GS forbidden tracking areas for regional provision of service" prevented a registration attempt, the MS selects the first such PLMN again and enters a limited service state.

[TS 38.331 clause 5.3.3.4]

The UE shall perform the following actions upon reception of the *RRCSetup*:

...

1> set the content of *RRCSetupComplete* message as follows:

2> if upper layers provide an *5G-S-TMSI*:

3> if the *RRCSetup* is received in response to an *RRCSetupRequest*:

4> set the *ng-5G-S-TMSI-Value* to *ng-5G-S-TMSI-Part2*;

3> else:

4> set the *ng-5G-S-TMSI-Value* to *ng-5G-S-TMSI*;

2> set the *selectedPLMN-Identity* to the PLMN selected by upper layers (TS 24.501 [23]) from the PLMN(s) included in the *plmn-IdentityList* in *SIB1*;

...

1> submit the *RRCSetupComplete* message to lower layers for transmission, upon which the procedure ends

[TS 24.501 clause 5.3.1.1]

The UE NAS also provides the lower layers with the identity of the selected PLMN (see 3GPP TS 38.331 [30]). In a shared network, the UE shall choose one of the PLMN identities as specified in 3GPP TS 23.122 [5].

6.1.1.4.3 Test description

6.1.1.4.3.1 Pre-test conditions

System Simulator:

- NR Cells 1 and 2, as specified in TS 38.508-1 [4] clause 4.4.1.1.3 are configured according to Table 4.4.2-3 in TS 38.508-1 [4] except for multiple broadcasted PLMN identities as shown in Table 6.1.1.4.3.1-1: PLMN identifiers broadcasted by cells in shared network, and NR Cells 1 and 2 with different tracking area codes as shown in Table 6.1.1.4.3.1-2.

Table 6.1.1.4.3.1-1: PLMN identifiers

NR Cell	PLMN names
1	PLMN4 (for preamble)
	PLMN15, PLMN1 (for test body)
2	PLMN15, PLMN1, PLMN16

Table 6.1.1.4.3.1-2: Tracking area codes

NR Cell	TAC	TAI
1	1	TAI-1
2	2	TAI-2

UE:

- The UE is in Automatic PLMN selection mode.
- The UE is equipped with a USIM configuration as defined in TS 38.508-1 [4] Table 6.4.1-5.
- The UE is registered to PLMN4 before it is switched off.

Preamble:

- The UE is in state Switched OFF (state ON-B) according to TS 38.508-1 [4].

6.1.1.4.3.2 Test procedure sequence

Table 6.1.1.4.3.2-1/2 shows the cell configurations used during the test. The configuration T0 indicates the initial conditions. Subsequent configuration marked "T1" is applied at the points indicated in the Main behaviour description in Table 6.1.1.4.3.2-2. Cell powers are chosen for a serving cell and a non-suitable cell as defined in TS 38.508-1 [4] Table 6.2.2.1-3 for FR1 and Table 6.2.2.2-2 for FR2.

Table 6.1.1.4.3.2-1: Time instances of cell power level and parameter changes for FR1

	Parameter	Unit	NR Cell 1	NR Cell 2	Remarks
T0	SS/PBCH SSS EPRE	dBm/SCS	-88	"Off"	Power level "Off" is defined in TS 38.508-1 [4] Table 6.2.2.1-3,
T1	SS/PBCH SSS EPRE	dBm/SCS	"Off"	"Off"	Close the NR Cell 1 to make sure the UE lose coverage. Power level "Off" is defined in TS 38.508-1 [4] Table 6.2.2.1-3,
T2	SS/PBCH SSS EPRE	dBm/SCS	"Off"	-88	Power level "Off" is defined in TS 38.508-1 [4] Table 6.2.2.1-3,

Table 6.1.1.4.3.2-2: Time instances of cell power level and parameter changes for FR2

	Parameter	Unit	NR Cell 1	NR Cell 2	Remarks
T0	SS/PBCH SSS EPRE	dBm/SCS	-95	"Off"	Power level "Off" is defined in TS 38.508-1 [4] Table 6.2.2.2-2.
T1	SS/PBCH SSS EPRE	dBm/SCS	"Off"	"Off"	Close the NR Cell 1 to make sure the UE lose coverage. Power level "Off" is defined in TS 38.508-1 [4] Table 6.2.2.2-2.
T2	SS/PBCH SSS EPRE	dBm/SCS	"Off"	-95	Power level "Off" is defined in TS 38.508-1 [4] Table 6.2.2.2-2.

Table 6.1.1.4.3.2-3: Main behaviour

St	Procedure	Message Sequence		TP	Verdict
		U - S	Message		
1	The SS adjusts cell levels according to row T0 of table 6.1.1.4.3.2-1/2.	-	-	-	-
2	Power on the UE.	-	-	-	-
3	Check: Does the UE transmit an <i>RRCSetupRequest</i> on NR Cell 1?	-->	NR RRC: <i>RRCSetupRequest</i>	1	P
4	The SS transmits an <i>RRCSetup</i> message.	<--	NR RRC: <i>RRCSetup</i>	-	-
5	Check: Does the UE transmit an <i>RRCSetupComplete</i> message indicating the HPLMN (second PLMN in the list)? Note: This message contains an REGISTRATION REQUEST message according to default message contents.	-->	NR RRC: <i>RRCSetupComplete</i>	1	P
6-21	Steps 5 to 20 of the registration procedure described in TS 38.508-1 [4] subclause 4.5.2.2-2 are performed on NR Cell 1. NOTE: The UE performs registration and the RRC connection is released.	-	-	-	-
22	The SS adjusts cell levels according to row T1 of table 6.1.1.4.3.2-1/2 to ensure UE to lose coverage.	-	-	-	-
23	Wait for 15s to allow UE to go out of service	-	-	-	-
24	The SS adjusts cell levels according to row T2 of table 6.1.1.4.3.2-1/2.	-	-	-	-
25	Check: Does the UE transmit an <i>RRCSetupRequest</i> on NR Cell 2?	-->	NR RRC: <i>RRCSetupRequest</i>	2	P
26	SS transmits an <i>RRCSetup</i> message.	<--	NR RRC: <i>RRCSetup</i>	-	-
27-31b 1	Steps 2 to 6b1 of the generic test procedure in TS 38.508-1 [4] subclause 4.9.5.2.2-1 are performed on NR Cell 2. NOTE: The UE performs a registration for mobility procedure and the RRC connection is released.	-	-	-	-

6.1.1.4.3.3 Specific message contents

Table 6.1.1.4.3.3-1: *SIB1* for NR Cell 1 (all steps, Table 6.1.1.4.3.2-1)

Derivation Path: 38.508-1 [4] Table 4.6.1-28			
Information Element	Value/remark	Comment	Condition
SIB1 ::= SEQUENCE {			
CellAccessRelatedInfo SEQUENCE {			
PLMN-IdentityInfoList SEQUENCE (SIZE (1..maxPLMN)) OF PLMN-IdentityInfo {	1 entry		
PLMN-IdentityInfo[1] SEQUENCE {		entry 1	
plmn-IdentityList SEQUENCE (SIZE (1..maxPLMN)) OF PLMN-Identity {	2 entries		
plmn-Identity[1]	PLMN15	entry 1	
plmn-Identity[2]	PLMN1	entry 2	
}			
}			
}			
}			
}			

Table 6.1.1.4.3.3-2: *SIB1* for NR Cell 2 (all steps, Table 6.1.1.4.3.2-1)

Derivation Path: 38.508-1 [4] Table 4.6.1-28			
Information Element	Value/remark	Comment	Condition
SIB1 ::= SEQUENCE {			
CellAccessRelatedInfo SEQUENCE {			
PLMN-IdentityInfoList SEQUENCE (SIZE (1..maxPLMN)) OF PLMN-IdentityInfo {	1 entry		
PLMN-IdentityInfo[1] SEQUENCE {		entry 1	
plmn-IdentityList SEQUENCE (SIZE (1..maxPLMN)) OF PLMN-Identity {	3 entries		
plmn-Identity[1]	PLMN15	entry 1	
plmn-Identity[2]	PLMN1	entry 2	
plmn-Identity[3]	PLMN16	entry 3	
}			
}			
}			
}			
}			

Table 6.1.1.4.3.3-3: *RRCSetupComplete* (step 5 and 27, Table 6.1.1.4.3.2-2)

Derivation Path: 38.508-1 [4], Table 4.6.1-22			
Information Element	Value/remark	Comment	Condition
RRCSetupComplete ::= SEQUENCE {			
criticalExtensions CHOICE {			
rrcSetupComplete SEQUENCE {			
selectedPLMN-Identity	2	PLMN1	
}			
}			
}			

6.1.1.5 PLMN selection of RPLMN, HPLMN/EHPLMN, UPLMN and OPLMN / Automatic mode / User reselection

6.1.1.5.1 Test Purpose (TP)

(1)

```
with { UE in Automatic network selection mode registered to UPLMN and RPLMN, UPLMN and OPLMN NG-RAN
cells available }
ensure that {
  when { UE is requested to initiate reselection and registration onto an available PLMN }
  then { UE reselects to the cell which belongs to higher priority OPLMN }
}
```

(2)

```
with { UE in Automatic network selection mode registered to OPLMN and only RPLMN NG-RAN cells
available }
ensure that {
  when { UE is requested to initiate reselection and registration onto an available PLMN }
  then { UE remains on the current cell which belongs to RPLMN }
}
```

(3)

```
with { UE in Automatic network selection mode registered to OPLMN and RPLMN, UPLMN and OPLMN NG-RAN
cells available }
ensure that {
  when { UE is requested to initiate reselection and registration onto an available PLMN }
  then { UE reselects to the cell which belongs to UPLMN }
}
```

(4)

```

with { UE in Automatic network selection mode registered to UPLMN and RPLMN, UPLMN, OPLMN and HPLMN
NG-RAN cells available }
ensure that {
  when { UE is requested to initiate reselection and registration onto an available PLMN }
  then { UE reselects to the cell which belongs to HPLMN }
}

```

6.1.1.5.2 Conformance requirements

References: The conformance requirements covered in the current TC are specified in: TS 23.122 clauses 4.4.3.2 and 4.4.3.2.1. Unless otherwise stated these are Rel-15 requirements.

[TS 23.122, clause 4.4.3.2]

At any time the user may request the MS to initiate reselection and registration onto an available PLMN, according to the following procedures, dependent upon the operating mode.

[TS 23.122, clause 4.4.3.2.1]

The MS selects and attempts registration on PLMN/access technology combinations, if available and allowable, in all of its bands of operation in accordance with the following order:

- i) the HPLMN (if the EHPLMN list is not present or is empty) or the highest priority EHPLMN that is available (if the EHPLMN list is present);
- ii) PLMN/access technology combinations contained in the "User Controlled PLMN Selector with Access Technology" data file in the SIM (in priority order) excluding the previously selected PLMN/access technology combination;
- iii) PLMN/access technology combinations contained in the "Operator Controlled PLMN Selector with Access Technology" data file in the SIM (in priority order) excluding the previously selected PLMN/access technology combination;
- iv) other PLMN/access technology combinations with the received high quality signal in random order excluding the previously selected PLMN/access technology combination;
- v) other PLMN/access technology combinations, excluding the previously selected PLMN/access technology combination in order of decreasing signal quality or, alternatively, the previously selected PLMN/access technology combination may be chosen ignoring its signal quality;
- vi) The previously selected PLMN/access technology combination.

The previously selected PLMN/access technology combination is the PLMN/access technology combination which the MS has selected prior to the start of the user reselection procedure.

NOTE 1: If the previously selected PLMN is chosen, and registration has not been attempted on any other PLMNs, then the MS is already registered on the PLMN, and so registration is not necessary.

The equivalent PLMNs list shall not be applied to the user reselection in Automatic Network Selection Mode.

When following the above procedure the requirements a), b), c), e), f), g), h), j), k) and l) in subclause 4.4.3.1.1 apply: Requirement d) shall apply as shown below:

- d) In iv, v, and vi, the MS shall search for all access technologies it is capable of before deciding which PLMN/access technology combination to select.

NOTE 2: High quality signal is defined in the appropriate AS specification.

- 6.1.1.5.3 Test description
- 6.1.1.5.3.1 Pre-test conditions
- 6.1.1.5.3.1 Pre-test conditions

System Simulator:

- Four inter-frequency multi-PLMN cells as specified in TS 38.508-1 [4] clause 4.4.1.2 are configured broadcasting default NAS parameters as indicated in TS 38.508-1 [4] Table 4.4.2-3.
- The PLMNs are identified in the test by the identifiers in Table 6.1.1.5.3.1-1.

Table 6.1.1.5.3.1-1: PLMN identifiers

NR Cell	PLMN name
1	PLMN1
12	PLMN2
3	PLMN3
13	PLMN4

UE:

- The UE is in Automatic PLMN selection mode.
- The UE is equipped with a USIM configuration as defined in TS 38.508-1 [4] Table 6.4.1-6.

Preamble:

- The UE is in state Registered, Idle Mode (state 1N-A) on NR Cell 1 according to TS 38.508-1 [4].

- 6.1.1.5.3.2 Test procedure sequence

Table 6.1.1.5.3.2-1: Time instances of cell power level and parameter changes for FR1

	Parameter	Unit	NR Cell 1	NR Cell 12	NR Cell 3	NR Cell 13	Remark
T1	SS/PBCH SSS EPRE	dBm/ SCS	-88	-88	"Off"	-88	The power level values are assigned to satisfy $R_{NRCell\ 1} = R_{NRCell\ 12} = R_{NRCell\ 13}$. (NOTE 1).
T2	SS/PBCH SSS EPRE	dBm/ SCS	"Off"	-88	"Off"	"Off"	
T3	SS/PBCH SSS EPRE	dBm/ SCS	-88	"Off"	-88	-88	The power level values are assigned to satisfy $R_{NRCell\ 1} = R_{NRCell\ 3} = R_{NRCell\ 13}$. (NOTE 1).
NOTE 1: Power level "Off" is defined in TS 38.508-1 [4] Table 6.2.2.1-3.							

Table 6.1.1.5.3.2-2: Time instances of cell power level and parameter changes for FR2

	Parameter	Unit	NR Cell 1	NR Cell 12	NR Cell 3	NR Cell 13	Remark
T1	SS/PBCH SSS EPRE	dBm/ SCS	FFS	FFS	"Off"	FFS	The power level values are assigned to satisfy $R_{\text{NRCell } 1} = R_{\text{NRCell } 12} = R_{\text{NRCell } 13}$. (NOTE 1).
T2	SS/PBCH SSS EPRE	dBm/ SCS	"Off"	FFS	"Off"	"Off"	
T3	SS/PBCH SSS EPRE	dBm/ SCS	FFS	"Off"	FFS	FFS	The power level values are assigned to satisfy $R_{\text{NRCell } 1} = R_{\text{NRCell } 3} = R_{\text{NRCell } 13}$. (NOTE 1).
NOTE 1: Power level "Off" is defined in TS 38.508-1 [4] Table 6.2.2.2-2.							

Table 6.1.1.5.3.2-3: Main behaviour

St	Procedure	Message Sequence		TP	Verdict
		U - S	Message		
1	The SS changes the power level setting according to the row "T1" in table 6.1.1.5.3.2-1/2.	-	-	-	-
2	Cause the UE in Automatic network selection mode to initiate user reselection and registration onto an available PLMN. (Note 1)	-	-	-	-
3	Check: Does the UE send an <i>RRCSetupRequest</i> on NR Cell 12?	-->	NR RRC: <i>RRCSetupRequest</i>	1	P
3A-3B	Steps 3-4 of Table 4.5.2.2-2 of the generic procedure in TS 38.508-1 [4] are performed. (Note 2)	-	-	-	-
-	EXCEPTION: Steps 4a1 to 4b5a1 describe behaviour that depends on events happening prior to their execution; the "lower case letter" identifies a step sequence that take place if a specific prior event takes place,	-	-	-	-
4a1-4a17 a1	IF 5GS registration type is set as Initial Registration in step 3B, THEN Steps 4 to 20a1 of the generic test procedure in TS 38.508-1 Table 4.5.2.2-2 are performed on NR Cell 12.	-	-	-	-
4b1-4b2	Void	-	-	-	-
4b3-4b5a 1	IF 5GS registration type is set as Mobility Registration in step 3B, THEN Steps 4 to 6a1 of the generic test procedure in TS 38.508-1 Table 4.9.5.2.2-1 are performed on NR Cell 12.	-	-	-	-
5-8	Void	-	-	-	-
9	The SS changes the power level setting according to the row "T2" in table 6.1.1.5.3.2-1/2.	-	-	-	-
10	Cause the UE in Automatic network selection mode to initiate user reselection and registration onto an available PLMN. (Note 1)	-	-	-	-
11	Check: Does the UE send an <i>RRCSetupRequest</i> on NR Cell 12 within 90 s?	-->	NR RRC: <i>RRCSetupRequest</i>	2	F
12	The SS changes the power level setting according to the row "T1" in table 6.1.1.5.3.2-1/2.	-	-	-	-
13	Cause the UE in Automatic network selection mode to initiate user reselection and registration onto an available PLMN. (Note 1)	-	-	-	-
14	Check: Does the UE send an <i>RRCSetupRequest</i> on NR Cell 1?	-->	NR RRC: <i>RRCSetupRequest</i>	3	P
14A-14B	Steps 3-4 of Table 4.5.2.2-2 of the generic procedure in TS 38.508-1 [4] are performed. (Note 2)	-	-	-	-
-	EXCEPTION: Steps 15a1 to 15b5a1 describe behaviour that depends on events happening prior to their execution; the "lower case letter" identifies a step sequence that take place if a specific prior event takes place,	-	-	-	-
15a1 - 15a1 7a1	IF 5GS registration type is set as Initial Registration in step 14B, THEN Steps 4 to 20a1 of the generic test procedure in TS 38.508-1 Table 4.5.2.2-2 are performed on NR Cell 1.	-	-	-	-
151-15b2	Void	-	-	-	-
15b3 - 15b5 a1	IF 5GS registration type is set as Mobility Registration in step 14B, THEN Steps 4 to 6a1 of the generic test procedure in TS 38.508-1 Table 4.9.5.2.2-1 are performed on NR Cell 1.	-	-	-	-

16-19	Void	-	-	-	-
20	The SS changes the power level setting according to the row "T3" in table 6.1.1.5.3.2-1/2.	-	-	-	-
21	Cause the UE in Automatic network selection mode to initiate user reselection and registration onto an available PLMN. (Note 1)	-	-	-	-
22	Check: Does the UE send an <i>RRCSetupRequest</i> on NR Cell 3?	-->	NR RRC: <i>RRCSetupRequest</i>	4	P
22A-22B	Steps 3-4 of Table 4.5.2.2-2 of the generic procedure in TS 38.508-1 [4] are performed. (Note 2)	-	-	-	-
-	EXCEPTION: Steps 23a1 to 23b5a1 describe behaviour that depends on events happening prior to their execution; the "lower case letter" identifies a step sequence that take place if a specific prior event takes place,	-	-	-	-
23a1 - 23a1 7a1	IF 5GS registration type is set as Initial Registration in step 22B, THEN Steps 4 to 20a1 of the generic test procedure in TS 38.508-1 Table 4.5.2.2-2 are performed on NR Cell 3.	-	-	-	-
23b1 - 23b2	Void	-	-	-	-
23b3 - 23b5 a1	IF 5GS registration type is set as Mobility Registration in step 22B, THEN Steps 4 to 6a1 of the generic test procedure in TS 38.508-1 Table 4.9.5.2.2-1 are performed on NR Cell 3.	-	-	-	-
24-27	Void	-	-	-	-
Note 1: MMI command "TRIGGER_USER_RESELECTION" to be used. AT command AT+COPS is not suitable to achieve the test purpose.					
Note 2: The 5GS registration type shall be only set as Mobility Registration for R16 UEs according to TS 24.501 subclause 5.2.3.2.5 specified in Release 16. The EXCEPTION description applies only to R15 UEs.					

6.1.1.5.3.3 Specific message contents

None

6.1.1.6 PLMN selection / Periodic reselection / MinimumPeriodicSearchTimer

6.1.1.6.1 Test Purpose (TP)

(1)

```
with { UE configured with "MinimumPeriodicSearchTimer" }
ensure that {
  when { UE camps on an NG-RAN VPLMN cell upon switch on and cells of a higher priority NG-RAN PLMN available }
  then { the MS shall make the first attempt to access the HPLMN or an EHPLMN or higher priority PLMN after a period of at least 2 minutes }
}
```

(2)

```
with { UE configured with "MinimumPeriodicSearchTimer", having made first attempt to higher priority PLMN and camped on an NG-RAN VPLMN cell and cells of a higher priority NG-RAN PLMN available }
ensure that {
  when { the higher priority PLMN search timer T stored in the USIM or the default value for T is less than the "MinimumPeriodicSearchTimer" }
  then { UE shall not use a value for T that is less than the "MinimumPeriodicSearchTimer" and selects and camps on a cell of the highest priority PLMN and attempts a location registration on the selected cell upon expiry of "MinimumPeriodicSearchTimer" }
}
```

6.1.1.6.2 Conformance requirements

References: The conformance requirements covered in the present test case are specified in: TS 23.122, clause 4.4.3.3.1 Unless otherwise stated these are Rel-15 requirements.

[TS 23.122, clause 4.4.3.3.1]

If the MS is in a VPLMN, the MS shall periodically attempt to obtain service on its HPLMN (if the EHPLMN list is not present or is empty) or one of its EHPLMNs (if the EHPLMN list is present) or a higher priority PLMN/access technology combinations listed in "user controlled PLMN selector" or "operator controlled PLMN selector" by scanning in accordance with the requirements that are applicable to i), ii) and iii) as defined in the Automatic Network Selection Mode in subclause 4.4.3.1.1. In the case that the mobile has a stored "Equivalent PLMNs" list the mobile shall only select a PLMN if it is of a higher priority than those of the same country as the current serving PLMN which are stored in the "Equivalent PLMNs" list. For this purpose, a value T minutes may be stored in the SIM, T is either in the range 6 minutes to 8 hours in 6 minute steps or it indicates that no periodic attempts shall be made. If no value is stored in the SIM, a default value of 60 minutes is used for T.

If the MS is configured with the MinimumPeriodicSearchTimer as specified in 3GPP TS 24.368 [50] or 3GPP TS 31.102 [40], the MS shall not use a value for T that is less than the MinimumPeriodicSearchTimer. If the value stored in the SIM, or the default value for T (when no value is stored in the SIM), is less than the MinimumPeriodicSearchTimer, then T shall be set to the MinimumPeriodicSearchTimer.

The attempts to access the HPLMN or an EHPLMN or higher priority PLMN shall be as specified below:

- a) The periodic attempts shall only be performed in automatic mode when the MS is roaming, and not while the MS is attached for emergency bearer services or has a PDN connection for emergency bearer services;
- b) After switch on a period of at least 2 minutes and at most T minutes shall elapse before the first attempt is made;

6.1.1.6.3 Test Description

6.1.1.6.3.1 Pre-test conditions

System Simulator:

- 3 NR cells: NR Cell 11, 12 and 13 as specified in TS 38.508-1[4] table 4.4.2-3 are configured as shown in Table 6.1.1.6.3.1-1.
- PLMN settings are defined in TS 36.523-1 [13] table 6.0.1-1.

Table 6.1.1.6.3.1-1: PLMN identifiers

NR Cell	PLMN names
NR Cell 11	PLMN16
NR Cell 12	PLMN1
NR Cell 13	PLMN15

UE:

- The UE is in Automatic PLMN selection mode.
- The UE is configured with a value of MinimumPeriodicSearchTimer set to 7 minutes.
- The UE is equipped with a USIM configuration 11 as per TS 38.508-1 [4] Table 6.4.1-11.

Preamble:

- The UE performs a successful registration on PLMN1 after which it is switched OFF (State ON-B) as per TS 38.508-1 [4] table 4.4A.2-0.

6.1.1.6.3.2 Test procedure sequence

Table 6.1.1.6.3.2-1 and Table 6.1.1.6.3.2-2 shows the cell configurations used during the test. The configuration T0 indicates the initial conditions. Subsequent configurations marked “T1” & “T2” are applied at the point indicated in the Main behaviour description in Table 6.1.1.6.3.2-3. Cell powers are chosen for a serving cell and a non-suitable [Off] cell as defined in TS 38.508-1[4] table 6.2.2.1-3.

Table 6.1.1.6.3.2-1: Time instances of cell power level and parameter changes for FR1

	Parameter	Unit	NR Cell 11	NR Cell 12	NR Cell 13	Remark
T0	SS/PBCH SSS EPRE	dBm/SC S	Off	-88	Off	
T1	SS/PBCH SSS EPRE	dBm/SC S	Off	-88	-88	
T2	SS/PBCH SSS EPRE	dBm/SC S	-88	-88	-88	

Table 6.1.1.6.3.2-2: Time instances of cell power level and parameter changes for FR2

	Parameter	Unit	NR Cell 11	NR Cell 12	NR Cell 13	Remark
T0	SS/PBCH SSS EPRE	dBm/SC S	Off	-82	Off	
	Qrxlevmin	dBm	-	-91+ Delta(N Rf2)	-	
T1	SS/PBCH SSS EPRE	dBm/SC S	Off	-82	-82	
	Qrxlevmin		-	-91+ Delta(N Rf2)	-91+ Delta(NRf 3)	
T2	SS/PBCH SSS EPRE	dBm/SC S	-82	-82	-82	
	Qrxlevmin		-91+ Delta(N Rf1)	-91+ Delta(N Rf2)	-91+ Delta(NRf 3)	

Table 6.1.1.6.3.2-3: Main behaviour

St	Procedure	Message Sequence		TP	Verdict
		U - S	Message		
1	SS adjusts cell levels according to row T1 of table 6.1.1.6.3.2-1/2.	-	-	-	-
2	Power on the UE.	-	-	-	-
3-22a 1	Steps 1 to 20a1 of the registration procedure described in TS 38.508-1[4] table 4.5.2.2-2 are performed on NR Cell 12.	-	-	-	-
23	Check: Does the UE send an <i>RRCSetupRequest</i> on NR Cell 13 after 120 seconds, but before 420 seconds ("MinimumPeriodicSearchTimer") from power on?	-->	<i>NR RRC: RRCSetupRequest</i>	1	P
24-28a 1	Steps 2 to 6a1 of the mobility registration updating procedure described in TS 38.508-1[4] Table 4.9.5.2.2-1 are performed on NR Cell 13.	-	-	-	-
29	SS adjusts cell levels according to row T2 of table 6.1.1.6.3.2-1/2.	-	-	-	-
30	Check: Does the UE send an <i>RRCSetupRequest</i> on NR Cell 11 after 420 seconds ("MinimumPeriodicSearchTimer") from step 24?	-->	<i>NR RRC: RRCSetupRequest</i>	2	P
31-35a 1	Steps 2 to 6a1 of the mobility registration updating procedure described in TS 38.508-1[4] Table 4.9.5.2.2-1 are performed on NR Cell 11.	-	-	-	-
Note: Timers in Steps 23 and 30 are derived from the value defined by the "MinimumPeriodicSearchTimer".					

6.1.1.6.3.3 Specific message contents

None

6.1.1.7 PLMN selection of RPLMN or (E)HPLMN; Automatic mode

6.1.1.7.1 Test Purpose (TP)

(1)

```
with { UE in Automatic network selection mode and RPLMN, EHPLMN and HPLMN cells available and UE is
fitted with a USIM containing the EHPLMN list and the USIM indicates RPLMN or (E)HPLMN should be
selected }
ensure that {
  when { UE is switched on }
  then { UE selects a cell of the RPLMN or EHPLMN. }
}
```

(2)

```
with { UE in Automatic network selection mode and RPLMN, HPLMN and VPLMN cells available and UE is
fitted with a USIM not containing or containing empty EHPLMN list and the USIM indicates RPLMN or
(E)HPLMN should be selected }
ensure that {
  when { UE is switched on }
  then { UE selects a cell of the RPLMN or HPLMN. }
}
```

6.1.1.7.2 Conformance requirements

References: The conformance requirements covered in the present TC are specified in: TS 38.304 clause 5.1.2.2, TS 23.122 clauses 1.2, 4.4.3.1 and 4.4.3.1.1. Unless otherwise stated these are Rel-15 requirements.

[TS 38.304 clause 5.1.2.2]

The UE shall scan all RF channels in the NR bands according to its capabilities to find available PLMNs. On each carrier, the UE shall search for the strongest cell and read its system information, in order to find out which PLMN(s) the cell belongs to. If the UE can read one or several PLMN identities in the strongest cell, each found PLMN (see the PLMN reading in TS 38.331 [3]) shall be reported to the NAS as a high quality PLMN (but without the RSRP value), provided that the following high-quality criterion is fulfilled:

1. For an NR Cell, the measured RSRP value shall be greater than or equal to -110 dBm.

...

Once the UE has selected a PLMN, the cell selection procedure shall be performed in order to select a suitable cell of that PLMN to camp on.

[TS 23.122, clause 1.2]

Equivalent HPLMN list: To allow provision for multiple HPLMN codes, PLMN codes that are present within this list shall replace the HPLMN code derived from the IMSI for PLMN selection purposes. This list is stored on the USIM and is known as the EHPLMN list. The EHPLMN list may also contain the HPLMN code derived from the IMSI. If the HPLMN code derived from the IMSI is not present in the EHPLMN list then it shall be treated as a Visited PLMN for PLMN selection purposes.

[TS 23.122 clause 4.4.3.1]

At switch on, or following recovery from lack of coverage, the MS selects the registered PLMN or equivalent PLMN (if it is available) using all access technologies that the MS is capable of and if necessary (in the case of recovery from lack of coverage, see subclause 4.5.2) attempts to perform a Location Registration.

NOTE 1: The MS in automatic network selection mode can end the PLMN search procedure once the registered PLMN or equivalent PLMN is found on an access technology.

NOTE 2: An MS in automatic network selection mode can use location information to determine which PLMNs can be available in its present location.

EXCEPTION: As an alternative option to this, if the MS is in automatic network selection mode and it finds coverage of an EHPLMN, the MS may register to that EHPLMN and not return to the registered PLMN or equivalent PLMN. If the EHPLMN list is not present or is empty, and the HPLMN is available, the MS may register on the HPLMN and not return to the registered PLMN or equivalent PLMN. The operator shall be able to control by SIM configuration whether an MS that supports this option is permitted to perform this alternative behaviour.

[TS 23.122 clause 4.4.3.1.1]

The MS selects and attempts registration on other PLMN/access technology combinations, if available and allowable, in the following order:

- i) either the HPLMN (if the EHPLMN list is not present or is empty) or the highest priority EHPLMN that is available (if the EHPLMN list is present);
- ii) each PLMN/access technology combination in the "User Controlled PLMN Selector with Access Technology" data file in the SIM (in priority order);
- iii) each PLMN/access technology combination in the "Operator Controlled PLMN Selector with Access Technology" data file in the SIM (in priority order);
- iv) other PLMN/access technology combinations with received high quality signal in random order;
- v) other PLMN/access technology combinations in order of decreasing signal quality.

6.1.1.7.3 Test description

6.1.1.7.3.1 Pre-test conditions

System Simulator:

- 4 NR Cells as specified in TS 38.508-1[4] table 4.4.2-3 are configured as shown in Table 6.1.1.7.3.1-1. PLMN settings are defined in TS 36.523-1 [13] table 6.0.1-1.

Table 6.1.1.7.3.1-1: PLMN identifiers

NR Cell	PLMN names
NR Cell 12	PLMN4
NR Cell 1	PLMN1
NR Cell 11	PLMN15
NR Cell 13	PLMN3

UE:

- The UE is in Automatic PLMN selection mode.
- USIM configurations 2 and 3 will be used as specified in tables 6.4.1-2 and 6.4.1-3 in TS 38.508-1 [4]. The points at which each USIM configuration is used is specified in 6.1.1.7.3.2-2.

Preamble:

- The UE performs a successful registration on PLMN4 after which the UE is brought into the state Switched OFF (state ON-B) according to Table 4.4A.2-0 TS 38.508-1[4].

6.1.1.7.3.2 Test procedure sequence

Table 6.1.1.7.3.2-1 for FR1 and table 6.1.1.7.3.2-2 for FR2 illustrate the downlink power levels to be applied for the cells at various time instants of the test execution. Row marked "T0" denotes the initial conditions after preamble, while columns marked "T1" is to be applied subsequently in the Main behaviour. The exact instants on which these values shall be applied are described in the texts in this clause.

Table 6.1.1.7.3.2-1: Cell configuration changes over time for FR1

	Parameter	Unit	NR Cell 1	NR Cell 12	NR Cell 11	NR Cell 13	Remarks
T0	SS/PBCH SSS EPRE	dBm/SCS	"Off"	-88	-88	"Off"	Power level "Off" is defined in TS 38.508-1 [4] Table 6.2.2.1-3
T1	SS/PBCH SSS EPRE	dBm/SCS	-88	-88	"Off"	-88	Power level "Off" is defined in TS 38.508-1 [4] Table 6.2.2.1-3

Table 6.1.1.7.3.2-2: Cell configuration changes over time for FR2

	Parameter	Unit	NR Cell 1	NR Cell 12	NR Cell 11	NR Cell 13	Remarks
T0	SS/PBCH SSS EPRE	dBm/SCS	"Off"	-82	-82	"Off"	Power level "Off" is defined in TS 38.508-1 [4] Table 6.2.2.1-3
	Qrxlevmin	dBm	-	-91+ Delta(NRf2)	-91+ Delta(NRf1)	-	
T1	SS/PBCH SSS EPRE	dBm/SCS	-82	-82	"Off"	-82	Power level "Off" is defined in TS 38.508-1 [4] Table 6.2.2.1-3
	Qrxlevmin	dBm	-91+ Delta(NRf1)	-91+ Delta(NRf2)	-	-91+ Delta(NRf3)	

Table 6.1.1.7.3.2-3 Main behaviour

St	Procedure	Message Sequence		TP	Verdict
		U - S	Message		
1	Power on the UE with the USIM configuration 2 specified in table 6.4.1-2 TS 38.508-1 [4].	-	-	-	-
2	Check: Does the UE transmit an <i>RRCSetupRequest</i> on NR Cell 12 or NR Cell 11?	-->	NR RRC: <i>RRCSetupRequest</i>	1	P
3-20	Steps 3-20a1 of the registration procedure described in TS 38.508-1 [4] table 4.5.2.2-2 are performed on NR Cell 12 or NR Cell 11. NOTE: The UE performs registration with valid stored security context (see preamble) and the RRC connection is released.	-	-	-	-
21	Void	-	-	-	-
22	The generic test procedure in TS 38.508-1 [4] Table 4.9.6.1-1 of Switch off procedure in RRC_IDLE are performed.	-	-	-	-
23	Void	-	-	-	-
24	The SS adjusts cell levels according to row T1 of table 6.1.1.7.3.2-1.	-	-	-	-
25	The UE is brought back to operation with the USIM configuration 3 specified in table 6.4.1-3 TS 38.508-1 [4].	-	-	-	-
26	Check: Does the UE transmit an <i>RRCSetupRequest</i> on NR Cell 12 or NR Cell 1?	-->	NR RRC: <i>RRCSetupRequest</i>	2	P
27-44	Steps 3 to 20a1 of the registration procedure described in TS 38.508-1 [4] table 4.5.2.2-2 are performed on NR Cell 12 or NR Cell 1.	-	-	-	-

6.1.1.7.3.3 Specific message contents

None

6.1.1.8 PLMN selection of RPLMN or (E)HPLMN; Manual mode

6.1.1.8.1 Test Purpose (TP)

(1)

```

with { UE in Manual network selection mode and EHPLMN and HPLMN cells available and (E)RPLMN cell is
not available and UE is fitted with a USIM containing the EHPLMN list and the UE supports the
exception to manual mode selection mode }
ensure that {
  then { UE is switched on }
  then { UE selects a cell of the highest priority EHPLMN. }
}

```

(2)

```

with { UE in Manual network selection mode and HPLMN and VPLMN cells available and (E)RPLMN cell is
not available and UE is fitted with a USIM not containing or containing empty EHPLMN list and the
UE supports the exception to manual mode selection mode }
ensure that {
  when { UE is switched on }
  then { UE selects a cell of the HPLMN. }
}

```

6.1.1.8.2 Conformance requirements

References: The conformance requirements covered in the present TC are specified in: TS 38.304 clause 5.1.2.2, TS 23.122 clauses 1.2, 4.4.3.1 and 4.4.3.1.2. Unless otherwise stated these are Rel-15 requirements.

[TS 38.304 clause 5.1.2.2]

The UE shall scan all RF channels in the NR bands according to its capabilities to find available PLMNs. On each carrier, the UE shall search for the strongest cell and read its system information, in order to find out which PLMN(s) the cell belongs to. If the UE can read one or several PLMN identities in the strongest cell, each found PLMN (see the PLMN reading in TS 38.331 [3]) shall be reported to the NAS as a high quality PLMN (but without the RSRP value), provided that the following high-quality criterion is fulfilled:

1. For an NR cell, the measured RSRP value shall be greater than or equal to -110 dBm.

...

Once the UE has selected a PLMN, the cell selection procedure shall be performed in order to select a suitable cell of that PLMN to camp on.

[TS 23.122, clause 1.2]

Equivalent HPLMN list: To allow provision for multiple HPLMN codes, PLMN codes that are present within this list shall replace the HPLMN code derived from the IMSI for PLMN selection purposes. This list is stored on the USIM and is known as the EHPLMN list. The EHPLMN list may also contain the HPLMN code derived from the IMSI. If the HPLMN code derived from the IMSI is not present in the EHPLMN list then it shall be treated as a Visited PLMN for PLMN selection purposes.

[TS 23.122 clause 4.4.3.1]

At switch on, or following recovery from lack of coverage, the MS selects the registered PLMN or equivalent PLMN (if it is available) using all access technologies that the MS is capable of and if necessary (in the case of recovery from lack of coverage, see subclause 4.5.2) attempts to perform a Location Registration.

NOTE 1: The MS in automatic network selection mode can end the PLMN search procedure once the registered PLMN or equivalent PLMN is found on an access technology.

NOTE 2: An MS in automatic network selection mode can use location information to determine which PLMNs can be available in its present location.

EXCEPTION: As an alternative option to this, if the MS is in automatic network selection mode and it finds coverage of an EHPLMN, the MS may register to that EHPLMN and not return to the registered PLMN or equivalent PLMN. If the EHPLMN list is not present or is empty, and the HPLMN is available, the MS may register on the HPLMN and not return to the registered PLMN or equivalent PLMN. The operator shall be able to control by SIM configuration whether an MS that supports this option is permitted to perform this alternative behaviour.

[TS 23.122 clause 4.4.3.1.2]

The MS indicates whether there are any PLMNs, which are available using all supported access technologies. This includes PLMNs in the "forbidden PLMNs" list, "forbidden PLMNs for GPRS service" list and PLMNs which only offer services not supported by the MS. An MS which supports GSM COMPACT shall also indicate GSM COMPACT PLMNs (which use PBCCH).

If displayed, PLMNs meeting the criteria above are presented in the following order:

- i)- either the HPLMN (if the EHPLMN list is not present or is empty) or, if one or more of the EHPLMNs are available then based on an optional data field on the SIM either only the highest priority available EHPLMN is to be presented to the user, or all available EHPLMNs are presented to the user in priority order. If the data field is not present on the SIM, then only the highest priority available EHPLMN is presented;
- ii)- PLMN/access technology combinations contained in the " User Controlled PLMN Selector with Access Technology " data file in the SIM (in priority order);
- iii)- PLMN/access technology combinations contained in the "Operator Controlled PLMN Selector with Access Technology" data file in the SIM (in priority order);
- iv)- other PLMN/access technology combinations with received high quality signal in random order;
- v)- other PLMN/access technology combinations in order of decreasing signal quality.

6.1.1.8.3 Test description

6.1.1.8.3.1 Pre-test conditions

System Simulator:

- 3 NR cells: NR Cells 1, 13 and 12 as specified in TS 38.508-1[4] table 6.3.2.2-1 are configured as shown in Table 6.1.1.8.3.1-1. PLMN settings are defined in TS 36.523-1 [13] table 6.0.1-1.

Table 6.1.1.8.3.1-1: PLMN identifiers

NR Cell	PLMN names
NR Cell 1 (configured during preamble)	PLMN4
NR Cell 1 (configured in test body all steps)	PLMN1
NR Cell 13	PLMN15
NR Cell 12	PLMN3

UE:

- The UE is in Manual PLMN selection mode.
- USIM configurations 2 and 3 will be used as specified in tables 6.4.1-2 and 6.4.1-3 in TS 38.508-1 [4]. The points at which each USIM configuration is used is specified in 6.1.1.8.3.2-2.

Preamble:

- The UE performs a successful registration on PLMN4 after which the UE is brought into the state Switched OFF (state ON-B) according to Table 4.4A.2-0 TS 38.508-1[4].

6.1.1.8.3.2 Test procedure sequence

Table 6.1.1.8.3.2-1 for FR1 and table 6.1.1.8.3.2-2 for FR2 illustrate the downlink power levels to be applied for the cells at various time instants of the test execution. Row marked "T0" denotes the initial conditions after preamble, while columns marked "T1" is to be applied subsequently in the Main behaviour. The exact instants on which these values shall be applied are described in the texts in this clause.

Table 6.1.1.8.3.2-1: Cell configuration changes over time for FR1

	Parameter	Unit	NR Cell 1	NR Cell 13	NR Cell 12	Remark
T0	SS/PBCH SSS EPRE	dBm/SCS	-88	-88	"Off"	Power level "Off" is defined in TS 38.508-1 Table 6.2.2.1-3
T1	SS/PBCH SSS EPRE	dBm/SCS	-88	"Off"	-88	Power level "Off" is defined in TS 38.508-1 Table 6.2.2.1-3

Table 6.1.1.8.3.2-2: Cell configuration changes over time for FR2

	Parameter	Unit	NR Cell 1	NR Cell 13	NR Cell 12	Remark
T0	SS/PBCH SSS EPRE	dBm/SCS	-82	-82	"Off"	Power level "Off" is defined in TS 38.508-1 Table 6.2.2.1-3
	Qrxlevmin	dBm	-91+ Delta(NRf1)	-91+ Delta(NRf3)	-	
T1	SS/PBCH SSS EPRE	dBm/SCS	-82	"Off"	-82	Power level "Off" is defined in TS 38.508-1 Table 6.2.2.1-3
	Qrxlevmin	dBm	-91+ Delta(NRf1)	-	-91+ Delta(NRf2)	

Table 6.1.1.8.3.2-3: Main behaviour

St	Procedure	Message Sequence		TP	Verdict
		U - S	Message		
1	Power on the UE with the USIM configuration 2 specified in table 6.4.1-2 TS 38.508-1 [4]..	-	-	-	-
2	Check: Does the UE transmit an <i>RRCSetupRequest</i> on NR Cell 13?	-->	NR RRC: <i>RRCSetupRequest</i>	1	P
3 - 20	Steps 3 to 20a1 of the registration procedure described in TS 38.508-1[4] table 4.5.2.2-2 are performed on NR Cell 13. NOTE: The UE performs registration with valid stored security context (see preamble) and the RRC connection is released.	-	-	-	-
21	Void	-	-	-	-
22	The generic test procedure in TS 38.508-1 [4] Table 4.9.6.1-1 of Switch off procedure in RRC_IDLE are performed.	-	-	-	-
23	Void	-	-	-	-
24	The SS adjusts cell according to row T1 of table 6.1.1.8.3.2-1.	-	-	-	-
25	The UE is brought back to operation with the USIM configuration 3 specified in table 6.4.1-3 TS 38.508-1 [4].	-	-	-	-
26	Check: Does the UE transmit an <i>RRCSetupRequest</i> on NR Cell 1?	-->	NR RRC: <i>RRCSetupRequest</i>	2	P
27- 44	Steps 3 to 20a1 of the registration procedure described in TS 38.508-1[4] table 4.5.2.2-2 are performed on NR Cell 1.	-	-	-	-

6.1.1.8.3.3 Specific message contents

None

6.1.2 NG-RAN Only Cell Selection

6.1.2.1 Cell Selection/Qrxlevmin & Cell Reselection (Intra NR)

6.1.2.1.1 Test Purpose (TP)

(1)

```
with { UE in NR RRC_IDLE state }
ensure that {
```

```

when { a cell fulfils all requirements for a suitable cell except the cell selection criteria
which are not fulfilled (Srxlev<0) }
  then { the UE does not consider the cell suitable and no camping on this cell can take place }
}

```

(2)

```

with { UE in NR RRC_IDLE state }
ensure that {
  when { a cell fulfils all requirements for a suitable cell including the cell selection criteria
for a cell which are also fulfilled (Srxlev>0) }
  then { the UE considers the cell suitable and camps on it }
}

```

(3)

```

with { UE in NR RRC_IDLE state }
ensure that {
  when { UE detects the cell ranked as the best cell }
  then { UE reselects the new cell }
}

```

(4)

```

with { UE in NR RRC_IDLE state }
ensure that {
  when { a cell fulfils cell selection criteria but trackingAreaCode is not provided for that PLMN }
  then { the UE considers the cell as barred and no camping on this cell can take place }
}

```

6.1.2.1.2 Conformance requirements

References: The conformance requirements covered in the present TC are specified in: 3GPP TS 38.300 clauses 9.2.1.1, 3GPP TS 38.304 clause 4.1, 4.5, 5.2.1, 5.2.3.1, 5.2.3.2, 5.2.4.6 and 5.3.1. Unless otherwise stated these are Rel-15 requirements.

[TS 38.300, clause 9.2.1.1]

The principles of PLMN selection in NR are based on the 3GPP PLMN selection principles. Cell selection is required on transition from RM-DEREGISTERED to RM-REGISTERED, from CM-IDLE to CM-CONNECTED and from CM-CONNECTED to CM-IDLE and is based on the following principles:

- The UE NAS layer identifies a selected PLMN and equivalent PLMNs;
- Cell selection is always based on CD-SSBs located on the synchronization raster (see subclause 5.2.4):
 - The UE searches the NR frequency bands and for each carrier frequency identifies the strongest cell as per the CD-SSB. It then reads cell system information broadcast to identify its PLMN(s):
 - The UE may search each carrier in turn ("initial cell selection") or make use of stored information to shorten the search ("stored information cell selection").
- The UE seeks to identify a suitable cell; if it is not able to identify a suitable cell it seeks to identify an acceptable cell. When a suitable cell is found or if only an acceptable cell is found it camps on that cell and commence the cell reselection procedure:
 - A suitable cell is one for which the measured cell attributes satisfy the cell selection criteria; the cell PLMN is the selected PLMN, registered or an equivalent PLMN; the cell is not barred or reserved and the cell is not part of a tracking area which is in the list of "forbidden tracking areas for roaming";
 - An acceptable cell is one for which the measured cell attributes satisfy the cell selection criteria and the cell is not barred.

Transition to RRC_IDLE:

On transition from RRC_CONNECTED to RRC_IDLE, a UE should camp on the last cell for which it was in RRC_CONNECTED or a cell/any cell of set of cells or frequency be assigned by RRC in the state transition message.

Recovery from out of coverage:

The UE should attempt to find a suitable cell in the manner described for stored information or initial cell selection above. If no suitable cell is found on any frequency or RAT, the UE should attempt to find an acceptable cell.

In multi-beam operations, the cell quality is derived amongst the beams corresponding to the same cell (see subclause 9.2.4).

[TS 38.304, clause 4.1]

The RRC_IDLE state and RRC_INACTIVE state tasks can be subdivided into three processes:

- PLMN selection;
- Cell selection and reselection;
- Location registration and RNA update.

PLMN selection, cell reselection procedures, and location registration are common for both RRC_IDLE state and RRC_INACTIVE state. RNA update is only applicable for RRC_INACTIVE state. When UE selects a new PLMN, UE transitions from RRC_INACTIVE to RRC_IDLE.

When a UE is switched on, a public land mobile network (PLMN) is selected by NAS. For the selected PLMN, associated RAT(s) may be set 3GPP TS 23.122 [9]. The NAS shall provide a list of equivalent PLMNs, if available, that the AS shall use for cell selection and cell reselection.

With cell selection, the UE searches for a suitable cell of the selected PLMN, chooses that cell to provide available services, and monitors its control channel. This procedure is defined as "camping on the cell".

The UE shall, if necessary, then register its presence, by means of a NAS registration procedure, in the tracking area of the chosen cell. As an outcome of a successful Location Registration, the selected PLMN then becomes the registered PLMN 3GPP TS 23.122 [9].

If the UE finds a more suitable cell, according to the cell reselection criteria, it reselects onto that cell and camps on it. If the new cell does not belong to at least one tracking area to which the UE is registered, location registration is performed. In RRC_INACTIVE state, if the new cell does not belong to the configured RNA, an RNA update procedure is performed.

If necessary, the UE shall search for higher priority PLMNs at regular time intervals as described in 3GPP TS 23.122 [9] and search for a suitable cell if another PLMN has been selected by NAS.

If the UE loses coverage of the registered PLMN, either a new PLMN is selected automatically (automatic mode), or an indication of available PLMNs is given to the user so that a manual selection can be performed (manual mode).

Registration is not performed by UEs only capable of services that need no registration.

The purpose of camping on a cell in RRC_IDLE state and RRC_INACTIVE state is fourfold:

- a) It enables the UE to receive system information from the PLMN.
- b) When registered and if the UE wishes to establish an RRC connection or resume a suspended RRC connection, it can do this by initially accessing the network on the control channel of the cell on which it is camped.
- c) If the network needs to send a message or deliver data to the registered UE, it knows (in most cases) the set of tracking areas (in RRC_IDLE state) or RNA (in RRC_INACTIVE state) in which the UE is camped. It can then send a "paging" message for the UE on the control channels of all the cells in the corresponding set of areas. The UE will then receive the paging message and can respond.
- d) It enables the UE to receive ETWS and CMAS notifications.

[TS 38.304, clause 4.5]

The cells are categorised according to which services they offer:

acceptable cell:

An "acceptable cell" is a cell on which the UE may camp to obtain limited service (originate emergency calls and receive ETWS and CMAS notifications). Such a cell shall fulfil the following requirements, which is the minimum set of requirements to initiate an emergency call and to receive ETWS and CMAS notification in an NR network:

- The cell is not barred, see subclause 5.3.1;
- The cell selection criteria are fulfilled, see subclause 5.2.3.2.

suitable cell:

A cell is considered as suitable if the following conditions are fulfilled:

- The cell is part of either the selected PLMN or the registered PLMN or PLMN of the Equivalent PLMN list and *trackingAreaCode* is provided for that PLMN;
- The cell selection criteria are fulfilled, see subclause 5.2.3.2.

According to the latest information provided by NAS:

- The cell is not barred, see subclause 5.3.1;
- The cell is part of at least one TA that is not part of the list of "Forbidden Tracking Areas" (TS 22.261 [12]), which belongs to a PLMN that fulfils the first bullet above.

barred cell:

A cell is barred if it is so indicated in the system information, as specified in TS 38.331 [3].

reserved cell:

A cell is reserved if it is so indicated in system information, as specified in TS 38.331 [3].

Following exception to these definitions are applicable for UEs:

- if a UE has an ongoing emergency call, all acceptable cells of that PLMN are treated as suitable for the duration of the emergency call.

[TS 38.304, clause 5.2.1]

UE shall perform measurements for cell selection and reselection purposes as specified in TS 38.133 [8].

The NAS can control the RAT(s) in which the cell selection should be performed, for instance by indicating RAT(s) associated with the selected PLMN, and by maintaining a list of forbidden registration area(s) and a list of equivalent PLMNs. The UE shall select a suitable cell based on RRC_IDLE or RRC_INACTIVE state measurements and cell selection criteria.

In order to expedite the cell selection process, stored information for several RATs, if available, may be used by the UE.

When camped on a cell, the UE shall regularly search for a better cell according to the cell reselection criteria. If a better cell is found, that cell is selected. The change of cell may imply a change of RAT. Details on performance requirements for cell reselection can be found in TS 38.133 [8].

The NAS is informed if the cell selection and reselection result in changes in the received system information relevant for NAS.

For normal service, the UE shall camp on a suitable cell, monitor control channel(s) of that cell so that the UE can:

- receive system information from the PLMN; and
- receive registration area information from the PLMN, e.g., tracking area information; and
- receive other AS and NAS Information; and
- if registered:
 - receive paging and notification messages from the PLMN; and
 - initiate transfer to Connected mode.

For cell selection in multi-beam operations, measurement quantity of a cell is up to UE implementation.

For cell reselection in multi-beam operations, using a maximum number (*nrofSS-BlocksToAverage*) of beams to be considered and a threshold (*absThreshSS-BlocksConsolidation*) which are configured for a cell, the measurement quantity of this cell is derived amongst the beams corresponding to the same cell based on SS/PBCH block as follows:

- if the highest beam measurement quantity value is below the threshold:
 - derive a cell measurement quantity as the highest beam measurement quantity value, where each beam measurement quantity is described in TS 38.215 [11].
- else:
 - derive a cell measurement quantity as the linear average of the power values of up to the maximum number of highest beam measurement quantity values above the threshold.

[TS 38.304, clause 5.2.3.1]

Cell selection is performed by one of the following two procedures:

- a) Initial cell selection (no prior knowledge of which RF channels are NR frequencies):
 1. The UE shall scan all RF channels in the NR bands according to its capabilities to find a suitable cell.
 2. On each frequency, the UE need only search for the strongest cell.
 3. Once a suitable cell is found, this cell shall be selected.
- b) Cell selection by leveraging stored information:
 1. This procedure requires stored information of frequencies and optionally also information on cell parameters from previously received measurement control information elements or from previously detected cells.
 2. Once the UE has found a suitable cell, the UE shall select it.
 3. If no suitable cell is found, the initial cell selection procedure in a) shall be started.

NOTE: Priorities between different frequencies or RATs provided to the UE by system information or dedicated signalling are not used in the cell selection process.

[TS 38.304, clause 5.2.3.2]

The cell selection criterion S is fulfilled when:

$$S_{rxlev} > 0 \text{ AND } S_{qual} > 0$$

$$\text{where: } S_{rxlev} = Q_{rxlevmeas} - (Q_{rxlevmin} + Q_{rxlevminoffset}) - P_{compensation} - Q_{offsettemp}$$

$$S_{qual} = Q_{qualmeas} - (Q_{qualmin} + Q_{qualminoffset}) - Q_{offsettemp}$$

where:

Srxlev	Cell selection RX level value (dB)
Squal	Cell selection quality value (dB)
Qoffset _{temp}	Offset temporarily applied to a cell as specified in TS 38.331 [3] (dB)
Qrxlev _{meas}	Measured cell RX level value (RSRP)
Qqual _{meas}	Measured cell quality value (RSRQ)
Qrxlev _{min}	Minimum required RX level in the cell (dBm). If the UE supports SUL frequency for this cell, Qrxlev _{min} is obtained from <i>RxLevMinSUL</i> , if present, in <i>SIB1</i> , <i>SIB2</i> and <i>SIB4</i> , additionally, if Q _{rxlevminoffsetcellSUL} is present in <i>SIB3</i> and <i>SIB4</i> for the concerned cell, this cell specific offset is added to the corresponding Qrxlev _{min} to achieve the required minimum RX level in the concerned cell; else Qrxlev _{min} is obtained from <i>q-RxLevMin</i> in <i>SIB1</i> , <i>SIB2</i> and <i>SIB4</i> , additionally, if Q _{rxlevminoffsetcell} is present in <i>SIB3</i> and <i>SIB4</i> for the concerned cell, this cell specific offset is added to the corresponding Qrxlev _{min} to achieve the required minimum RX level in the concerned cell.
Qqual _{min}	Minimum required quality level in the cell (dB). Additionally, if Q _{qualminoffsetcell} is signalled for the concerned cell, this cell specific offset is added to achieve the required minimum quality level in the concerned cell.
Qrxlev _{minoffset}	Offset to the signalled Q _{rxlevmin} taken into account in the Srxlev evaluation as a result of a periodic search for a higher priority PLMN while camped normally in a VPLMN 3GPP TS 23.122 [9]
Qqual _{minoffset}	Offset to the signalled Q _{qualmin} taken into account in the Squal evaluation as a result of a periodic search for a higher priority PLMN while camped normally in a VPLMN 3GPP TS 23.122 [9]
P _{compensation}	If the UE supports the additionalP _{max} in the NS-P _{maxList} , if present, in <i>SIB1</i> , <i>SIB2</i> and <i>SIB4</i> : $\max(P_{EMAX1} - P_{PowerClass}, 0) - (\min(P_{EMAX2}, P_{PowerClass}) - \min(P_{EMAX1}, P_{PowerClass}))$ (dB); else: $\max(P_{EMAX1} - P_{PowerClass}, 0)$ (dB)
P _{EMAX1} , P _{EMAX2}	Maximum TX power level of a UE may use when transmitting on the uplink in the cell (dBm) defined as P _{EMAX} in TS 38.101 [15]. P _{EMAX1} and P _{EMAX2} are obtained from the <i>p-Max</i> and <i>NS-PmaxList</i> respectively in <i>SIB1</i> , <i>SIB2</i> and <i>SIB4</i> as specified in TS 38.331 [3].
P _{PowerClass}	Maximum RF output power of the UE (dBm) according to the UE power class as defined in TS 38.101 [15]

The signalled values Q_{rxlevminoffset} and Q_{qualminoffset} are only applied when a cell is evaluated for cell selection as a result of a periodic search for a higher priority PLMN while camped normally in a VPLMN (3GPP TS 23.122 [9]). During this periodic search for higher priority PLMN, the UE may check the S criteria of a cell using parameter values stored from a different cell of this higher priority PLMN.

[TS 38.304, clause 5.2.4.6]

The cell-ranking criterion R_s for serving cell and R_n for neighbouring cells is defined by:

$$R_s = Q_{meas,s} + Q_{hyst} - Q_{offset,temp}$$

$$R_n = Q_{meas,n} - Q_{offset} - Q_{offset,temp}$$

where:

Q _{meas}	RSRP measurement quantity used in cell reselections.
Q _{offset}	For intra-frequency: Equals to Q _{offsets,n} , if Q _{offsets,n} is valid, otherwise this equals to zero. For inter-frequency: Equals to Q _{offsets,n} plus Q _{offsetfrequency} , if Q _{offsets,n} is valid, otherwise this equals to Q _{offsetfrequency} .
Q _{offsettemp}	Offset temporarily applied to a cell as specified in TS 38.331 [3].

The UE shall perform ranking of all cells that fulfil the cell selection criterion S, which is defined in 5.2.3.2.

The cells shall be ranked according to the R criteria specified above by deriving Q_{meas,n} and Q_{meas,s} and calculating the R values using averaged RSRP results.

If *rangeToBestCell* is not configured, the UE shall perform cell reselection to the highest ranked cell. If this cell is found to be not-suitable, the UE shall behave according to subclause 5.2.4.4.

If *rangeToBestCell* is configured, then the UE shall perform cell reselection to the cell with the highest number of beams above the threshold (i.e. *absThreshSS-BlocksConsolidation*) among the cells whose R value is within *rangeToBestCell* of the R value of the highest ranked cell. If there are multiple such cells, the UE shall perform cell reselection to the highest ranked cell among them. If this cell is found to be not-suitable, the UE shall behave according to subclause 5.2.4.4.

In all cases, the UE shall reselect the new cell, only if the following conditions are met:

- the new cell is better ranked than the serving cell during a time interval $T_{\text{reselection}_{\text{RAT}}}$;
- more than 1 second has elapsed since the UE camped on the current serving cell.

[TS 38.304, clause 5.3.1]

Cell status and cell reservations are indicated in the *MIB* or *SIB1* message as specified in TS 38.331 [3] by means of three fields:

- *cellBarred* (IE type: "barred" or "not barred")
Indicated in *MIB* message. In case of multiple PLMNs indicated in *SIB1*, this field is common for all PLMNs
- *cellReservedForOperatorUse* (IE type: "reserved" or "not reserved")
Indicated in *SIB1* message. In case of multiple PLMNs indicated in *SIB1*, this field is specified per PLMN.
- *cellReservedForOtherUse* (IE type: "true")
Indicated in *SIB1* message. In case of multiple PLMNs indicated in *SIB1*, this field is common for all PLMNs.

When cell status is indicated as "not barred" and "not reserved" for operator use and not "true" for other use,

- All UEs shall treat this cell as candidate during the cell selection and cell reselection procedures.

When cell status is indicated as "true" for other use,

- The UE shall treat this cell as if cell status is "barred".

When cell status is indicated as "not barred" and "reserved" for operator use for any PLMN and not "true" for other use,

- UEs assigned to Access Identity 11 or 15 operating in their HPLMN/EHPLMN shall treat this cell as candidate during the cell selection and reselection procedures if the field *cellReservedForOperatorUse* for that PLMN set to "reserved".
- UEs assigned to an Access Identity 0, 1, 2 and 12 to 14 shall behave as if the cell status is "barred" in case the cell is "reserved for operator use" for the registered PLMN or the selected PLMN.

NOTE 1: Access Identities 11, 15 are only valid for use in the HPLMN/ EHPLMN; Access Identities 12, 13, 14 are only valid for use in the home country as specified in TS 22.261 [12].

When cell status "barred" is indicated or to be treated as if the cell status is "barred",

- The UE is not permitted to select/reselect this cell, not even for emergency calls.
- The UE shall select another cell according to the following rule:
- If the cell is to be treated as if the cell status is "barred" due to being unable to acquire the *MIB*:
 - the UE may exclude the barred cell as a candidate for cell selection/reselection for up to 300 seconds.
 - the UE may select another cell on the same frequency if the selection criteria are fulfilled.
- else:
 - If the cell is to be treated as if the cell status is "barred" due to being unable to acquire the *SIB1* or due to *trackingAreaCode* being absent in *SIB1* as specified in TS 38.331 [3]:
 - The UE may exclude the barred cell as a candidate for cell selection/reselection for up to 300 seconds.

- If the field *intraFreqReselection* in *MIB* message is set to "allowed", the UE may select another cell on the same frequency if re-selection criteria are fulfilled;
 - The UE shall exclude the barred cell as a candidate for cell selection/reselection for 300 seconds.
- If the field *intraFreqReselection* in *MIB* message is set to "not allowed" the UE shall not re-select a cell on the same frequency as the barred cell;
 - The UE shall exclude the barred cell and the cells on the same frequency as a candidate for cell selection/reselection for 300 seconds.

The cell selection of another cell may also include a change of RAT.

6.1.2.1.3 Test description

6.1.2.1.3.1 Pre-test conditions

System Simulator:

- NR Cell 1 and NR Cell 11.
- System information combination NR-2 as defined in TS 38.508-1 [4] clause 4.4.3.1.2 is used in NR cells.

UE:

- None.

Preamble:

- The UE is in state Switched OFF (state 0-A) according to TS 38.508-1 [4].

6.1.2.1.3.2 Test procedure sequence

Table 6.1.2.1.3.2-1/2 illustrate the downlink power levels and other changing parameters to be applied for the cell at various time instants of the test execution. The exact instants on which these values shall be applied are described in the texts in this clause. Configurations marked "T1", "T2", "T3" and "T4" are applied at the points indicated in the Main behaviour description in Table 6.1.2.1.3.2-3.

Table 6.1.2.1.3.2-1: Time instances of cell power level and parameter changes for FR1

	Parameter	Unit	NR Cell 1	NR Cell 11	Remark
T1	SS/PBCH SSS EPRE	dBm/ SCS	-98	Off	The power level value is such to satisfy $Srxlev_{NRCell1} < 0$ but the UE is able to read the PLMN identity
	Qrxlevmin	dBm	-90	-	
	Qrxlevminoffset	dB	0	-	
	Pcompensation	dB	0	-	
T2	SS/PBCH SSS EPRE	dBm/ SCS	-80	Off	The power level is such that $Srxlev_{NRCell1} > 0$
	Qrxlevmin	dBm	-90	-	
	Qrxlevminoffset	dB	0	-	
	Pcompensation	dB	0	-	
T3	SS/PBCH SSS EPRE	dBm/ SCS	-87	-78	The power level values are assigned to satisfy $R_{NRCell1} < R_{NRCell11}$.
	Qrxlevmin	dBm	-90	-90	
	Qrxlevminoffset	dB	0	0	
	Pcompensation	dB	0	0	
T4	SS/PBCH SSS EPRE	dBm/ SCS	-78	-85	The power level values are assigned to satisfy $R_{NRCell1} > R_{NRCell11}$.
	Qrxlevmin	dBm	-90	-90	
	Qrxlevminoffset	dB	0	0	
	Pcompensation	dB	0	0	

Note: The downlink signal level uncertainty is specified in TS 38.508-1 [4] clause 6.2.2.1.

Table 6.1.2.1.3.2-2: Time instances of cell power level and parameter changes for FR2

	Parameter	Unit	NR Cell 1	NR Cell 11	Remark
T1	SS/PBCH SSS EPRE	dBm/ SCS	-100	Off	The power level value is such to satisfy $Srxlev_{NRCell11} < 0$ but the UE is able to read the PLMN identity
	Qrxlevmin	dBm	- $91 + \Delta(NRf1)$	-	
	Qrxlevminoffset	dB	0	-	
	Pcompensation	dB	0	-	
T2	SS/PBCH SSS EPRE	dBm/ SCS	-82	Off	The power level is such that $Srxlev_{NRCell11} > 0$
	Qrxlevmin	dBm	- $91 + \Delta(NRf1)$	-	
	Qrxlevminoffset	dB	0	-	
	Pcompensation	dB	0	-	
T3	SS/PBCH SSS EPRE	dBm/ SCS	-91	-82	The power level values are assigned to satisfy $R_{NRCell1} < R_{NRCell11}$.
	Qrxlevmin	dBm	- $100 + \Delta(NRf1)$	- $100 + \Delta(NRf1)$	
	Qrxlevminoffset	dB	0	0	
	Pcompensation	dB	0	0	
T4	SS/PBCH SSS EPRE	dBm/ SCS	-82	-91	The power level values are assigned to satisfy $R_{NRCell1} > R_{NRCell11}$.
	Qrxlevmin	dBm	- $100 + \Delta(NRf1)$	- $100 + \Delta(NRf1)$	
	Qrxlevminoffset	dB	0	0	
	Pcompensation	dB	0	0	

Table 6.1.2.1.3.2-3: Main behaviour

St	Procedure	Message Sequence		TP	Verdict
		U - S	Message		
1	SS adjusts the SS/PBCH EPRE level of NR Cell 1 according to row "T1" in table 6.1.2.1.3.2-1/2.	-	-	-	-
2	The UE is switched on.	-	-	-	-
3	Check: Does the UE send an <i>RRCSetupRequest</i> on NR Cell 1 within the next 60 s?	-->	NR RRC: <i>RRCSetupRequest</i>	1	F
4	SS re-adjusts the SS/PBCH EPRE level of NR Cell 1 level according to row "T2" in table 6.1.2.1.3.2-1/2.	-	-	-	-
5	Check: Does the UE send an <i>RRCSetupRequest</i> on NR Cell 1?	-->	NR RRC: <i>RRCSetupRequest</i>	2	P
6-23	Steps 3 to 20 of the registration procedure described in TS 38.508-1 [4] Table 4.5.2.2-2 are performed on NR Cell 1. NOTE: The UE performs registration and the RRC connection is released.	-	-	-	-
-	EXCEPTION: Step 23Aa1 should be executed in case of FR2	-	-	-	-
23Aa1	SS change NR Cell 1 SIB1 with modification of <i>Qrxlevmin</i> .	-	-	-	-
24	The SS changes SS/PBCH EPRE level of NR Cell 11 according to the row "T3" in table 6.1.2.1.3.2-1/2.	-	-	-	-
25-31	Check: Does the test result of generic test procedure in TS 38.508-1 [4] clause 4.9.5 indicate that the UE is camped on NR Cell 11? NOTE 1: The UE performs registration and the RRC connection is released.	-	-	3	P
32	SS change NR Cell 1 SIB1	-	-	-	-
32A	Wait for 2.1* modification period second for the SS to transmit modified system information (Note 1)				
33	The SS changes SS/PBCH EPRE level of NR Cell 1 and 11 according to the row "T4" in table 6.1.2.1.3.2-1/2.	-	-	-	-
34	Check: Does the UE send an <i>RRCSetupRequest</i> on NR Cell 1 within the next 60 s?	-	-	4	F
Note 1: The modification period, expressed in number of radio frames = $\text{modificationPeriodCoeff} * \text{defaultPagingCycle}$.					

6.1.2.1.3.3 Specific message contents

Table 6.1.2.1.3.3-1: SIB1 for NR Cell 1 (preamble) and NR Cell 11 (preamble)

Derivation Path: TS 38.508-1 [4], Table 4.6.1-28			
Information Element	Value/remark	Comment	Condition
SIB1 ::= SEQUENCE {			
cellSelectionInfo SEQUENCE {			
q-RxLevMin	-45	-90 dBm	FR1
q-RxLevMin	ROUND((-91+Delta(NRf1))/2)		FR2
}			
}			

Table 6.1.2.1.3.3-1A: SIB1 for NR Cell 1 (Step23Aa1, Table 6.1.2.1.3.2-3)

Derivation Path: TS 38.508-1 [4], Table 4.6.3-16			
Information Element	Value/remark	Comment	Condition
SIB1 ::= SEQUENCE {			
cellSelectionInfo SEQUENCE {			
q-RxLevMin	ROUND([-100+Delta(NRf1)]/2)		FR2
}			
}			

Table 6.1.2.1.3.3-2: SIB1 for NR Cell 1 (Step32, Table 6.1.2.1.3.2-3)

Derivation Path: TS 38.508-1 [4], Table 4.6.1-28			
Information Element	Value/remark	Comment	Condition
SIB1 ::= SEQUENCE {			
cellSelectionInfo SEQUENCE {			
q-RxLevMin	-45	-90 dBm	FR1
q-RxLevMin	ROUND((-91+Delta(NRf1))/2)	-91+Delta(NRf1) dBm	FR2
}			
cellAccessRelatedInfo	CellAccessRelatedInfo		
}			

Table 6.1.2.1.3.3-3: CellAccessRelatedInfo (Table 6.1.2.1.3.3-2)

Derivation Path: TS 38.508-1 [4], Table 4.6.3-16			
Information Element	Value/remark	Comment	Condition
CellAccessRelatedInfo ::= SEQUENCE {			
plmn-IdentityList	PLMN-IdentityInfoList		
cellReservedForOtherUse	Not present		
}			

Table 6.1.2.1.3.3-4: PLMN-IdentityInfoList (Table 6.1.2.1.3.3-3)

Derivation Path: TS 38.508-1 [4], Table 4.6.3-108			
Information Element	Value/remark	Comment	Condition
PLMN-IdentityInfoList ::= SEQUENCE (SIZE (1..maxPLMN)) OF PLMN-IdentityInfo {	1 entry		
PLMN-IdentityInfo[1] SEQUENCE {		entry 1	
trackingAreaCode	Not present		
}			
}			

6.1.2.2 Cell Selection / Qqualmin/Intra NR / Serving cell becomes non-suitable (Srxlev > 0, Squal < 0)

6.1.2.2.1 Test Purpose (TP)

(1)

```
with { UE in NR RRC_IDLE state }
ensure that {
  when { a cell fulfils all requirements for a suitable cell except the cell selection criteria
  which are not fulfilled (Srxlev>0 AND Squal<0) }
  then { the UE does not consider the cell suitable and no camping on this cell can take place }
}
```

(2)

```

with { UE in NR RRC_IDLE state }
ensure that {
  when { a cell fulfils all requirements for a suitable cell including the cell selection criteria
for a cell which are also fulfilled (Srxlev>0 AND Squal>0) }
  then { the UE considers the cell suitable and camps on it }
}

```

(3)

```

with { UE in NR RRC_IDLE state }
ensure that {
  when { the serving cell becomes non-suitable (Srxlev > 0 and Squal < 0) and there is a suitable
neighbour cell (Srxlev > 0 and Squal > 0) }
  then { UE selects the suitable neighbour cell }
}

```

6.1.2.2.2 Conformance requirements

References: The conformance requirements covered in the present TC are specified in: 3GPP TS 38.300 clauses 9.2.1.1, 3GPP TS 38.304 clause 4.1, 4.5, 5.2.1, 5.2.3.1, 5.2.3.2, 5.2.4.6 and 5.3.1. Unless otherwise stated these are Rel-15 requirements.

[TS 38.300, clause 9.2.1.1]

The principles of PLMN selection in NR are based on the 3GPP PLMN selection principles. Cell selection is required on transition from RM-DEREGISTERED to RM-REGISTERED, from CM-IDLE to CM-CONNECTED and from CM-CONNECTED to CM-IDLE and is based on the following principles:

- The UE NAS layer identifies a selected PLMN and equivalent PLMNs;
- Cell selection is always based on CD-SSBs located on the synchronization raster (see subclause 5.2.4):
 - The UE searches the NR frequency bands and for each carrier frequency identifies the strongest cell as per the CD-SSB. It then reads cell system information broadcast to identify its PLMN(s):
 - The UE may search each carrier in turn ("initial cell selection") or make use of stored information to shorten the search ("stored information cell selection").
- The UE seeks to identify a suitable cell; if it is not able to identify a suitable cell it seeks to identify an acceptable cell. When a suitable cell is found or if only an acceptable cell is found it camps on that cell and commence the cell reselection procedure:
 - A suitable cell is one for which the measured cell attributes satisfy the cell selection criteria; the cell PLMN is the selected PLMN, registered or an equivalent PLMN; the cell is not barred or reserved and the cell is not part of a tracking area which is in the list of "forbidden tracking areas for roaming";
 - An acceptable cell is one for which the measured cell attributes satisfy the cell selection criteria and the cell is not barred.

Transition to RRC_IDLE:

On transition from RRC_CONNECTED to RRC_IDLE, a UE should camp on the last cell for which it was in RRC_CONNECTED or a cell/any cell of set of cells or frequency be assigned by RRC in the state transition message.

Recovery from out of coverage:

The UE should attempt to find a suitable cell in the manner described for stored information or initial cell selection above. If no suitable cell is found on any frequency or RAT, the UE should attempt to find an acceptable cell.

In multi-beam operations, the cell quality is derived amongst the beams corresponding to the same cell (see subclause 9.2.4).

[TS 38.304, clause 4.1]

The RRC_IDLE state and RRC_INACTIVE state tasks can be subdivided into three processes:

- PLMN selection;
- Cell selection and reselection;
- Location registration and RNA update.

PLMN selection, cell reselection procedures, and location registration are common for both RRC_IDLE state and RRC_INACTIVE state. RNA update is only applicable for RRC_INACTIVE state. When UE selects a new PLMN, UE transitions from RRC_INACTIVE to RRC_IDLE.

When a UE is switched on, a public land mobile network (PLMN) is selected by NAS. For the selected PLMN, associated RAT(s) may be set 3GPP TS 23.122 [9]. The NAS shall provide a list of equivalent PLMNs, if available, that the AS shall use for cell selection and cell reselection.

With cell selection, the UE searches for a suitable cell of the selected PLMN, chooses that cell to provide available services, and monitors its control channel. This procedure is defined as "camping on the cell".

The UE shall, if necessary, then register its presence, by means of a NAS registration procedure, in the tracking area of the chosen cell. As an outcome of a successful Location Registration, the selected PLMN then becomes the registered PLMN 3GPP TS 23.122 [9].

If the UE finds a more suitable cell, according to the cell reselection criteria, it reselects onto that cell and camps on it. If the new cell does not belong to at least one tracking area to which the UE is registered, location registration is performed. In RRC_INACTIVE state, if the new cell does not belong to the configured RNA, an RNA update procedure is performed.

If necessary, the UE shall search for higher priority PLMNs at regular time intervals as described in 3GPP TS 23.122 [9] and search for a suitable cell if another PLMN has been selected by NAS.

If the UE loses coverage of the registered PLMN, either a new PLMN is selected automatically (automatic mode), or an indication of available PLMNs is given to the user so that a manual selection can be performed (manual mode).

Registration is not performed by UEs only capable of services that need no registration.

The purpose of camping on a cell in RRC_IDLE state and RRC_INACTIVE state is fourfold:

- a) It enables the UE to receive system information from the PLMN.
- b) When registered and if the UE wishes to establish an RRC connection or resume a suspended RRC connection, it can do this by initially accessing the network on the control channel of the cell on which it is camped.
- c) If the network needs to send a message or deliver data to the registered UE, it knows (in most cases) the set of tracking areas (in RRC_IDLE state) or RNA (in RRC_INACTIVE state) in which the UE is camped. It can then send a "paging" message for the UE on the control channels of all the cells in the corresponding set of areas. The UE will then receive the paging message and can respond.
- d) It enables the UE to receive ETWS and CMAS notifications.

[TS 38.304, clause 4.5]

The cells are categorised according to which services they offer:

acceptable cell:

An "acceptable cell" is a cell on which the UE may camp to obtain limited service (originate emergency calls and receive ETWS and CMAS notifications). Such a cell shall fulfil the following requirements, which is the minimum set of requirements to initiate an emergency call and to receive ETWS and CMAS notification in an NR network:

- The cell is not barred, see subclause 5.3.1;
- The cell selection criteria are fulfilled, see subclause 5.2.3.2.

suitable cell:

A cell is considered as suitable if the following conditions are fulfilled:

- The cell is part of either:
 - the selected PLMN, or:
 - the registered PLMN, or:
 - a PLMN of the Equivalent PLMN list.
- The cell selection criteria are fulfilled, see subclause 5.2.3.2;

According to the latest information provided by NAS:

- The cell is not barred, see subclause 5.3.1;
- The cell is part of at least one TA that is not part of the list of "Forbidden Tracking Areas" TS 22.261 [12], which belongs to a PLMN that fulfils the first bullet above.

barred cell:

A cell is barred if it is so indicated in the system information TS 38.331 [3].

reserved cell:

A cell is reserved if it is so indicated in system information TS 38.331 [3].

Following exception to these definitions are applicable for UEs:

- if a UE has an ongoing emergency call, all acceptable cells of that PLMN are treated as suitable for the duration of the emergency call.

[TS 38.304, clause 5.2.1]

UE shall perform measurements for cell selection and reselection purposes as specified in TS 38.133 [8].

The NAS can control the RAT(s) in which the cell selection should be performed, for instance by indicating RAT(s) associated with the selected PLMN, and by maintaining a list of forbidden registration area(s) and a list of equivalent PLMNs. The UE shall select a suitable cell based on RRC_IDLE or RRC_INACTIVE state measurements and cell selection criteria.

In order to expedite the cell selection process, stored information for several RATs, if available, may be used by the UE.

When camped on a cell, the UE shall regularly search for a better cell according to the cell reselection criteria. If a better cell is found, that cell is selected. The change of cell may imply a change of RAT. Details on performance requirements for cell reselection can be found in TS 38.133 [8].

The NAS is informed if the cell selection and reselection result in changes in the received system information relevant for NAS.

For normal service, the UE shall camp on a suitable cell, monitor control channel(s) of that cell so that the UE can:

- receive system information from the PLMN; and
- receive registration area information from the PLMN, e.g., tracking area information; and
- receive other AS and NAS Information; and
- if registered:
 - receive paging and notification messages from the PLMN; and
 - initiate transfer to Connected mode.

For cell selection in multi-beam operations, measurement quantity of a cell is up to UE implementation.

For cell reselection in multi-beam operations, using a maximum number (*nrofSS-BlocksToAverage*) of beams to be considered and a threshold (*absThreshSS-BlocksConsolidation*) which are configured for a cell, the measurement quantity of this cell is derived amongst the beams corresponding to the same cell based on SS/PBCH block as follows:

- if the highest beam measurement quantity value is below the threshold:
 - derive a cell measurement quantity as the highest beam measurement quantity value, where each beam measurement quantity is described in TS 38.215 [11].
- else:
 - derive a cell measurement quantity as the linear average of the power values of up to the maximum number of highest beam measurement quantity values above the threshold.

[TS 38.304, clause 5.2.3.1]

Cell selection is performed by one of the following two procedures:

- a) Initial cell selection (no prior knowledge of which RF channels are NR frequencies):
 1. The UE shall scan all RF channels in the NR bands according to its capabilities to find a suitable cell.
 2. On each frequency, the UE need only search for the strongest cell.
 3. Once a suitable cell is found, this cell shall be selected.
- b) Cell selection by leveraging stored information:
 1. This procedure requires stored information of frequencies and optionally also information on cell parameters from previously received measurement control information elements or from previously detected cells.
 2. Once the UE has found a suitable cell, the UE shall select it.
 3. If no suitable cell is found, the initial cell selection procedure in a) shall be started.

NOTE: Priorities between different frequencies or RATs provided to the UE by system information or dedicated signalling are not used in the cell selection process.

[TS 38.304, clause 5.2.3.2]

The cell selection criterion S is fulfilled when:

$$S_{rxlev} > 0 \text{ AND } S_{qual} > 0$$

$$S_{rxlev} = Q_{rxlevmeas} - (Q_{rxlevmin} + Q_{rxlevminoffset}) - P_{compensation} - Q_{offsettemp}$$

where:

$$S_{qual} = Q_{qualmeas} - (Q_{qualmin} + Q_{qualminoffset}) - Q_{offsettemp}$$

where:

Srxlev	Cell selection RX level value (dB)
Squal	Cell selection quality value (dB)
Qoffset _{temp}	Offset temporarily applied to a cell as specified in TS 38.331 [3] (dB)
Q _{rxlevmeas}	Measured cell RX level value (RSRP)
Q _{qualmeas}	Measured cell quality value (RSRQ)
Q _{rxlevmin}	Minimum required RX level in the cell (dBm). If the UE supports SUL frequency for this cell, Q _{rxlevmin} is obtained from <i>RxLevMinSUL</i> , if present, in <i>SIB1</i> , <i>SIB2</i> and <i>SIB4</i> , additionally, if Q _{rxlevminoffsetcellSUL} is present in <i>SIB3</i> and <i>SIB4</i> for the concerned cell, this cell specific offset is added to the corresponding Q _{rxlevmin} to achieve the required minimum RX level in the concerned cell; else Q _{rxlevmin} is obtained from <i>q-RxLevMin</i> in <i>SIB1</i> , <i>SIB2</i> and <i>SIB4</i> , additionally, if Q _{rxlevminoffsetcell} is present in <i>SIB3</i> and <i>SIB4</i> for the concerned cell, this cell specific offset is added to the corresponding Q _{rxlevmin} to achieve the required minimum RX level in the concerned cell.
Q _{qualmin}	Minimum required quality level in the cell (dB). Additionally, if Q _{qualminoffsetcell} is signalled for the concerned cell, this cell specific offset is added to achieve the required minimum quality level in the concerned cell.
Q _{rxlevminoffset}	Offset to the signalled Q _{rxlevmin} taken into account in the Srxlev evaluation as a result of a periodic search for a higher priority PLMN while camped normally in a VPLMN 3GPP TS 23.122 [9]
Q _{qualminoffset}	Offset to the signalled Q _{qualmin} taken into account in the Squal evaluation as a result of a periodic search for a higher priority PLMN while camped normally in a VPLMN 3GPP TS 23.122 [9]
P _{compensation}	If the UE supports the additionalP _{max} in the NS-P _{maxList} , if present, in <i>SIB1</i> , <i>SIB2</i> and <i>SIB4</i> : $\max(P_{EMAX1} - P_{PowerClass}, 0) - (\min(P_{EMAX2}, P_{PowerClass}) - \min(P_{EMAX1}, P_{PowerClass}))$ (dB); else: $\max(P_{EMAX1} - P_{PowerClass}, 0)$ (dB)
P _{EMAX1} , P _{EMAX2}	Maximum TX power level of a UE may use when transmitting on the uplink in the cell (dBm) defined as P _{EMAX} in TS 38.101 [15]. P _{EMAX1} and P _{EMAX2} are obtained from the <i>p-Max</i> and <i>NS-PmaxList</i> respectively in <i>SIB1</i> , <i>SIB2</i> and <i>SIB4</i> as specified in TS 38.331 [3].
P _{PowerClass}	Maximum RF output power of the UE (dBm) according to the UE power class as defined in TS 38.101 [15]

The signalled values Q_{rxlevminoffset} and Q_{qualminoffset} are only applied when a cell is evaluated for cell selection as a result of a periodic search for a higher priority PLMN while camped normally in a VPLMN (3GPP TS 23.122 [9]). During this periodic search for higher priority PLMN, the UE may check the S criteria of a cell using parameter values stored from a different cell of this higher priority PLMN.

[TS 38.304, clause 5.2.4.6]

The cell-ranking criterion R_s for serving cell and R_n for neighbouring cells is defined by:

$$R_s = Q_{meas,s} + Q_{hyst} - Q_{offset,temp}$$

$$R_n = Q_{meas,n} - Q_{offset} - Q_{offset,temp}$$

where:

Q _{meas}	RSRP measurement quantity used in cell reselections.
Q _{offset}	For intra-frequency: Equals to Q _{offsets,n} , if Q _{offsets,n} is valid, otherwise this equals to zero. For inter-frequency: Equals to Q _{offsets,n} plus Q _{offsetfrequency} , if Q _{offsets,n} is valid, otherwise this equals to Q _{offsetfrequency} .
Q _{offset,temp}	Offset temporarily applied to a cell as specified in TS 38.331 [3].

The UE shall perform ranking of all cells that fulfil the cell selection criterion S, which is defined in 5.2.3.2.

The cells shall be ranked according to the R criteria specified above by deriving Q_{meas,n} and Q_{meas,s} and calculating the R values using averaged RSRP results.

If *rangeToBestCell* is not configured, the UE shall perform cell reselection to the highest ranked cell. If this cell is found to be not-suitable, the UE shall behave according to subclause 5.2.4.4.

If *rangeToBestCell* is configured, then the UE shall perform cell reselection to the cell with the highest number of beams above the threshold (i.e. *absThreshSS-BlocksConsolidation*) among the cells whose R value is within *rangeToBestCell* of the R value of the highest ranked cell. If there are multiple such cells, the UE shall perform cell reselection to the highest ranked cell among them. If this cell is found to be not-suitable, the UE shall behave according to subclause 5.2.4.4.

In all cases, the UE shall reselect the new cell, only if the following conditions are met:

- the new cell is better ranked than the serving cell during a time interval $T_{\text{reselectionRAT}}$;
- more than 1 second has elapsed since the UE camped on the current serving cell.

[TS 38.304, clause 5.3.1]

Cell status and cell reservations are indicated in the *MIB* or *SIB1* message TS 38.331 [3] by means of three fields:

- *cellBarred* (IE type: "barred" or "not barred")
Indicated in *MIB* message. In case of multiple PLMNs indicated in *SIB1*, this field is common for all PLMNs
- *cellReservedForOperatorUse* (IE type: "reserved" or "not reserved")
Indicated in *SIB1* message. In case of multiple PLMNs indicated in *SIB1*, this field is specified per PLMN.
- *cellReservedForOtherUse* (IE type: "true")
Indicated in *SIB1* message. In case of multiple PLMNs indicated in *SIB1*, this field is common for all PLMNs.

When cell status is indicated as "not barred" and "not reserved" for operator use and not "true" for other use,

- All UEs shall treat this cell as candidate during the cell selection and cell reselection procedures.

When cell status is indicated as "true" for other use,

- The UE shall treat this cell as if cell status is "barred".

When cell status is indicated as "not barred" and "reserved" for operator use for any PLMN and not "true" for other use,

- UEs assigned to Access Identity 11 or 15 operating in their HPLMN/EHPLMN shall treat this cell as candidate during the cell selection and reselection procedures if the field *cellReservedForOperatorUse* for that PLMN set to "reserved".
- UEs assigned to an Access Identity in the range of 0 to 10 and 12 to 14 shall behave as if the cell status is "barred" in case the cell is "reserved for operator use" for the registered PLMN or the selected PLMN.

NOTE 1: Access Identities 11, 15 are only valid for use in the HPLMN/ EHPLMN; Access Identities 12, 13, 14 are only valid for use in the home country as specified in 3GPP TS 22.261 [12].

When cell status "barred" is indicated or to be treated as if the cell status is "barred",

- The UE is not permitted to select/reselect this cell, not even for emergency calls.
- The UE shall select another cell according to the following rule:
 - If the cell is to be treated as if the cell status is "barred" due to being unable to acquire the *MIB* or the *SIB1*:
 - the UE may exclude the barred cell as a candidate for cell selection/reselection for up to 300 seconds.
 - the UE may select another cell on the same frequency if the selection criteria are fulfilled.
 - else
 - If the field *intraFreqReselection* in *MIB* message is set to "allowed", the UE may select another cell on the same frequency if re-selection criteria are fulfilled;
 - The UE shall exclude the barred cell as a candidate for cell selection/reselection for 300 seconds.

- If the field *intraFreqReselection* in *MIB* message is set to "not allowed" the UE shall not re-select a cell on the same frequency as the barred cell;
- The UE shall exclude the barred cell and the cells on the same frequency as a candidate for cell selection/reselection for 300 seconds.

The cell selection of another cell may also include a change of RAT.

6.1.2.2.3 Test description

6.1.2.2.3.1 Pre-test conditions

System Simulator:

- NR Cell 1 and NR Cell 11 have different tracking areas according to TS 38.508-1 [4] Table 4.4.2-3.
- System information combination NR-2 as defined in TS 38.508-1[4] clause 4.4.3.1.2, and message contents defined in is used in NR cells.

UE:

- None.

Preamble:

- The UE is in state Switched OFF (state 0-A) according to TS 38.508-1[4].

6.1.2.2.3.2 Test procedure sequence

Table 6.1.2.2.3.2-1/2 illustrate the downlink power levels and other changing parameters to be applied for the cell at various time instants of the test execution. The exact instants on which these values shall be applied are described in the texts in this clause. Configurations marked "T1" "T2" and "T3" are applied at the points indicated in the Main behaviour description in Table 6.1.2.2.3.2-3.

Table 6.1.2.2.3.2-1: Time instances of cell power level and parameter changes for FR1

	Parameter	Unit	NR Cell 1	NR Cell 11	Remark
T1	SS/PBCH SSS EPRE	dBm/ SCS	-91	Off	The power level value is such to satisfy $S_{rxlev_{NRCell1}} > 0$ and $S_{qual_{NRCell1}} < 0$ but the UE is able to read the PLMN identity
	RSRQ	dB	-12.56	-	
	Noc	dBm/ SCS	-94	-	
	Qrxlevmin	dBm	-110	-	
	Qrxlevminoffset	dB	0	-	
	Qqualmin	dB	-12	-	
	Qqualminoffset	dB	0	-	
	Pcompensation	dB	0	-	

T2	SS/PBCH SSS EPRE	dBm/SCS	-78	-115	The power level is such that $Srxlev_{NRCell1} > 0$ and $Squal_{NRCell1} > 0$
	RSRQ	dB	-10.89	-31.83	
	Noc	dBm/SCS	-94	-94	
	Qrxlevmin	dBm	-110	-110	
	Qrxlevminoffset	dB	0	-0	
	Qqualmin	dB	-12	-12	
	Qqualminoffset	dB	0	-0	
	Pcompensation	dB	0	-0	
T3	SS/PBCH SSS EPRE	dBm/SCS	-91	-78	$Srxlev_{NRCell1} > 0$ and $Squal_{NRCell1} < 0$
	RSRQ	dB	-12.56	-10.89	
	Noc	dBm/SCS	-94	-94	
	Qrxlevmin	dBm	-110	-110	
	Qrxlevminoffset	dB	0	0	
	Qqualmin	dB	-12	-12	
	Qqualminoffset	dB	0	0	
	Pcompensation	dB	0	0	
	Srxlev*	dB	19	40	NR Cell 11 is suitable cell
	Squal*	dB	-0.56	1.11	
	Note: The downlink signal level uncertainty is specified in TS 38.508-1 [4] clause 6.2.2.1				

Table 6.1.2.3.2-2: Time instances of cell power level and parameter changes for FR2

	Parameter	Unit	NR Cell 1	NR Cell 11	Remark
T1	SS/PBCH SSS EPRE	dBm/SCS	FFS	Off	The power level value is such to satisfy $Srxlev_{NRCell1} > 0$ and $Squal_{NRCell1} < 0$ but the UE is able to read the PLMN identity
	RSRQ	dB	-FFS	-	
	Noc	dBm/SCS	FFS	-	
	Qrxlevmin	dBm	FFS	-	
	Qrxlevminoffset	dB	0	-	
	Qqualmin	dB	FFS	-	
	Qqualminoffset	dB	0	-	
	Pcompensation	dB	0	-	
T2	SS/PBCH SSS EPRE	dBm/SCS	FFS	Off	The power level is such that $Srxlev_{NRCell1} > 0$ and $Squal_{NRCell1} > 0$
	RSRQ	dB	FFS	-	
	Noc	dBm/SCS	FFS	-	
	Qrxlevmin	dBm	FFS	-	
	Qrxlevminoffset	dB	0	-	
	Qqualmin	dB	FFS	-	
	Qqualminoffset	dB	0	-	
	Pcompensation	dB	0	-	
T3	SS/PBCH SSS EPRE	dBm/SCS	FFS	FFS	$Srxlev_{NRCell1} > 0$ and $Squal_{NRCell1} < 0$
	RSRQ	dB	FFS	FFS	
	Noc	dBm/SCS	FFS	FFS	
	Qrxlevmin	dBm	FFS	FFS	
	Qrxlevminoffset	dB	0	0	
	Qqualmin	dB	FFS	FFS	
	Qqualminoffset	dB	0	0	
	Pcompensation	dB	0	0	
	Srxlev*	dB	FFS	FFS	NR Cell 11 is suitable cell
	Squal*	dB	FFS	FFS	
	Note: The downlink signal level uncertainty is specified in TS 38.508-1 [4] clause FFS.				

Table 6.1.2.2.3.2-3: Main behaviour

St	Procedure	Message Sequence		TP	Verdict
		U - S	Message		
1	SS adjusts the SS/PBCH EPRE level of NR Cell 1 according to row "T1" in table 6.1.2.2.3.2-1/2.	-	-	-	-
2	The UE is switched on.	-	-	-	-
3	Check: Does the UE send an <i>RRCSetupRequest</i> on NR Cell 1 within the next 60 s?	-->	NR RRC: <i>RRCSetupRequest</i>	1	F
4	SS re-adjusts the SS/PBCH EPRE level of NR Cell 1 level according to row "T2" in table 6.1.2.2.3.2-1/2.	-	-	-	-
5	Check: Does the UE send an <i>RRCSetupRequest</i> on NR Cell 1?	-->	NR RRC: <i>RRCSetupRequest</i>	2	P
6-23	Steps 3 to 20 of the registration procedure described in TS 38.508-1 [4] Table 4.5.2.2-2 are performed on NR Cell 1. NOTE: The UE performs registration and the RRC connection is released.	-	-	-	-
24	SS adjusts the SS/PBCH EPRE level of NR Cell 1 and NR Cell 11 according to row "T3" in table 6.1.2.2.3.2-1/2.	-	-	-	-
25	Check: Does the test result of generic test procedure in TS 38.508-1 [4] Table 4.9.5.2.2-1 indicate that the UE is camped on NR Cell 11? NOTE: The UE performs a registration for mobility procedure and the RRC connection is released.	-	-	3	P

6.1.2.2.3.3 Specific message contents

Table 6.1.2.2.3.3-1: *SIB1*(NR Cell 1, Preamble and all steps of Table 6.1.2.2.3.2-3)

Derivation Path: TS 38.508-1 [4], Table 4.6.1-28 with Condition QBASED			
Information Element	Value/remark	Comment	Condition
SIB1 ::= SEQUENCE {			
cellSelectionInfo SEQUENCE {			
	-12		FR1
	FFS		FR2
}			
}			

Table 6.1.2.2.3.3-2: *SIB2*(NR Cell 1, Preamble and all steps of Table 6.1.2.2.3.2-3)

Derivation Path: TS 38.508-1 [4], Table 4.6.2-1 with Condition QBASED			
Information Element	Value/remark	Comment	Condition
SIB2 ::= SEQUENCE {			
intraFreqCellReselectionInfo SEQUENCE {			
q-QualMin	-12	-12dB	FR1
	FFS		FR2
}			
}			

6.1.2.3 Cell selection / Intra NR/ Serving cell becomes non-suitable (S<0, MIB Indicated barred)

6.1.2.3.1 Test Purpose (TP)

(1)

```
with { UE in NR RRC_IDLE state }
ensure that {
  when { the serving cell becomes non-suitable (S<0) and there is a suitable neighbour cell (S>0) }
  then { UE selects the suitable neighbour cell }
}
```

(2)

```
with { UE in NR RRC_IDLE state }
ensure that {
  when { the serving cell becomes barred and there is a suitable neighbour cell }
  then { UE selects the suitable neighbour cell }
}
```

6.1.2.3.2 Conformance requirements

References: The conformance requirements covered in the present TC are specified in: 3GPP TS 38.304 clause 4.1, 5.2.3.2 and 5.3.1. Unless otherwise stated these are Rel-15 requirements.

[TS 38.304, clause 4.1]

The RRC_IDLE state and RRC_INACTIVE state tasks can be subdivided into three processes:

- PLMN selection;
- Cell selection and reselection;
- Location registration and RNA update.

PLMN selection, cell reselection procedures, and location registration are common for both RRC_IDLE state and RRC_INACTIVE state. RNA update is only applicable for RRC_INACTIVE state. When UE selects a new PLMN, UE transitions from RRC_INACTIVE to RRC_IDLE.

When a UE is switched on, a public land mobile network (PLMN) is selected by NAS. For the selected PLMN, associated RAT(s) may be set 3GPP TS 23.122 [9]. The NAS shall provide a list of equivalent PLMNs, if available, that the AS shall use for cell selection and cell reselection.

With cell selection, the UE searches for a suitable cell of the selected PLMN, chooses that cell to provide available services, and monitors its control channel. This procedure is defined as "camping on the cell".

The UE shall, if necessary, then register its presence, by means of a NAS registration procedure, in the tracking area of the chosen cell. As an outcome of a successful Location Registration, the selected PLMN then becomes the registered PLMN 3GPP TS 23.122 [9].

If the UE finds a more suitable cell, according to the cell reselection criteria, it reselects onto that cell and camps on it. If the new cell does not belong to at least one tracking area to which the UE is registered, location registration is performed. In RRC_INACTIVE state, if the new cell does not belong to the configured RNA, an RNA update procedure is performed.

If necessary, the UE shall search for higher priority PLMNs at regular time intervals as described in 3GPP TS 23.122 [9] and search for a suitable cell if another PLMN has been selected by NAS.

If the UE loses coverage of the registered PLMN, either a new PLMN is selected automatically (automatic mode), or an indication of available PLMNs is given to the user so that a manual selection can be performed (manual mode).

Registration is not performed by UEs only capable of services that need no registration.

The purpose of camping on a cell in RRC_IDLE state and RRC_INACTIVE state is fourfold:

- a) It enables the UE to receive system information from the PLMN.
- b) When registered and if the UE wishes to establish an RRC connection or resume a suspended RRC connection, it can do this by initially accessing the network on the control channel of the cell on which it is camped.
- c) If the network needs to send a message or deliver data to the registered UE, it knows (in most cases) the set of tracking areas (in RRC_IDLE state) or RNA (in RRC_INACTIVE state) in which the UE is camped. It can then send a "paging" message for the UE on the control channels of all the cells in the corresponding set of areas. The UE will then receive the paging message and can respond.
- d) It enables the UE to receive ETWS and CMAS notifications.

[TS 38.304, clause 5.2.3.2]

The cell selection criterion S is fulfilled when:

$$Srxlev > 0 \text{ AND } Squal > 0$$

where:

$$Srxlev = Q_{rxlevmeas} - (Q_{rxlevmin} + Q_{rxlevminoffset}) - P_{compensation} - Q_{offsettemp}$$

$$Squal = Q_{qualmeas} - (Q_{qualmin} + Q_{qualminoffset}) - Q_{offsettemp}$$

where:

Srxlev	Cell selection RX level value (dB)
Squal	Cell selection quality value (dB)
Qoffsettemp	Offset temporarily applied to a cell as specified in TS 38.331 [3] (dB)
Qrxlevmeas	Measured cell RX level value (RSRP)
Qqualmeas	Measured cell quality value (RSRQ)
Qrxlevmin	Minimum required RX level in the cell (dBm). If the UE supports SUL frequency for this cell, Qrxlevmin is obtained from <i>RxLevMinSUL</i> , if present, in <i>SIB1</i> , <i>SIB2</i> and <i>SIB4</i> , additionally, if <i>QrxlevminoffsetcellSUL</i> is present in <i>SIB3</i> and <i>SIB4</i> for the concerned cell, this cell specific offset is added to the corresponding Qrxlevmin to achieve the required minimum RX level in the concerned cell; else Qrxlevmin is obtained from <i>q-RxLevMin</i> in <i>SIB1</i> , <i>SIB2</i> and <i>SIB4</i> , additionally, if <i>Qrxlevminoffsetcell</i> is present in <i>SIB3</i> and <i>SIB4</i> for the concerned cell, this cell specific offset is added to the corresponding Qrxlevmin to achieve the required minimum RX level in the concerned cell.
Qqualmin	Minimum required quality level in the cell (dB). Additionally, if <i>Qqualminoffsetcell</i> is signalled for the concerned cell, this cell specific offset is added to achieve the required minimum quality level in the concerned cell.
Qrxlevminoffset	Offset to the signalled Qrxlevmin taken into account in the Srxlev evaluation as a result of a periodic search for a higher priority PLMN while camped normally in a VPLMN 3GPP TS 23.122 [9]
Qqualminoffset	Offset to the signalled Qqualmin taken into account in the Squal evaluation as a result of a periodic search for a higher priority PLMN while camped normally in a VPLMN 3GPP TS 23.122 [9]
Pcompensation	If the UE supports the additionalPmax in the NS-PmaxList, if present, in <i>SIB1</i> , <i>SIB2</i> and <i>SIB4</i> : $\max(P_{EMAX1} - P_{PowerClass}, 0) - (\min(P_{EMAX2}, P_{PowerClass}) - \min(P_{EMAX1}, P_{PowerClass}))$ (dB); else: $\max(P_{EMAX1} - P_{PowerClass}, 0)$ (dB)
P _{EMAX1} , P _{EMAX2}	Maximum TX power level of a UE may use when transmitting on the uplink in the cell (dBm) defined as P _{EMAX} in TS 38.101 [15]. P _{EMAX1} and P _{EMAX2} are obtained from the <i>p-Max</i> and <i>NS-PmaxList</i> respectively in <i>SIB1</i> , <i>SIB2</i> and <i>SIB4</i> as specified in TS 38.331 [3].
P _{PowerClass}	Maximum RF output power of the UE (dBm) according to the UE power class as defined in TS 38.101 [15]

The signalled values $Q_{rxlevminoffset}$ and $Q_{qualminoffset}$ are only applied when a cell is evaluated for cell selection as a result of a periodic search for a higher priority PLMN while camped normally in a VPLMN (3GPP TS 23.122 [9]). During this periodic search for higher priority PLMN, the UE may check the S criteria of a cell using parameter values stored from a different cell of this higher priority PLMN.

[TS 38.304, clause 5.3.1]

Cell status and cell reservations are indicated in the *MIB* or *SIB1* message TS 38.331 [3] by means of three fields:

- *cellBarred* (IE type: "barred" or "not barred")
Indicated in *MIB* message. In case of multiple PLMNs indicated in *SIB1*, this field is common for all PLMNs
- *cellReservedForOperatorUse* (IE type: "reserved" or "not reserved")
Indicated in *SIB1* message. In case of multiple PLMNs indicated in *SIB1*, this field is specified per PLMN.
- *cellReservedForOtherUse* (IE type: "true")
Indicated in *SIB1* message. In case of multiple PLMNs indicated in *SIB1*, this field is common for all PLMNs.

When cell status is indicated as "not barred" and "not reserved" for operator use and not "true" for other use,

- All UEs shall treat this cell as candidate during the cell selection and cell reselection procedures.

When cell status is indicated as "true" for other use,

- The UE shall treat this cell as if cell status is "barred".

When cell status is indicated as "not barred" and "reserved" for operator use for any PLMN and not "true" for other use,

- UEs assigned to Access Identity 11 or 15 operating in their HPLMN/EHPLMN shall treat this cell as candidate during the cell selection and reselection procedures if the field *cellReservedForOperatorUse* for that PLMN set to "reserved".
- UEs assigned to an Access Identity in the range of 0 to 10 and 12 to 14 shall behave as if the cell status is "barred" in case the cell is "reserved for operator use" for the registered PLMN or the selected PLMN.

NOTE 1: Access Identities 11, 15 are only valid for use in the HPLMN/ EHPLMN; Access Identities 12, 13, 14 are only valid for use in the home country as specified in 3GPP TS 22.261 [12].

When cell status "barred" is indicated or to be treated as if the cell status is "barred",

- The UE is not permitted to select/reselect this cell, not even for emergency calls.
- The UE shall select another cell according to the following rule:
- If the cell is to be treated as if the cell status is "barred" due to being unable to acquire the *MIB* or the *SIB1*:
 - the UE may exclude the barred cell as a candidate for cell selection/reselection for up to 300 seconds.
 - the UE may select another cell on the same frequency if the selection criteria are fulfilled.
- else
 - If the field *intraFreqReselection* in *MIB* message is set to "allowed", the UE may select another cell on the same frequency if re-selection criteria are fulfilled;
 - The UE shall exclude the barred cell as a candidate for cell selection/reselection for 300 seconds.
 - If the field *intraFreqReselection* in *MIB* message is set to "not allowed" the UE shall not re-select a cell on the same frequency as the barred cell;
 - The UE shall exclude the barred cell and the cells on the same frequency as a candidate for cell selection/reselection for 300 seconds.

The cell selection of another cell may also include a change of RAT.

6.1.2.3.3 Test description

6.1.2.3.3.1 Pre-test conditions

System Simulator:

- NR Cell 1 and NR Cell 11 have different tracking areas according to TS 38.508-1 [4] Table 4.4.2-3.
- System information combination NR-2 as defined in TS 38.508-1[4] clause 4.4.3.1.2 is used in NR cells.

UE:

None.

Preamble:

- UE is in state IN-A on NR Cell 1(serving cell) according to 38.508-1 [4].

6.1.2.3.3.2 Test procedure sequence

Table 6.1.2.3.3.2-1/2 illustrate the downlink power levels and other changing parameters to be applied for the cells at various time instants of the test execution. The exact instants on which these values shall be applied are described in the texts in this clause. The configuration T0 indicates the initial conditions for preamble. Configurations marked "T1" and "T2" are applied at the points indicated in the Main behaviour description in Table 6.1.2.3.3.2-3.

Table 6.1.2.3.3.2-1: Time instances of cell power level and parameter changes for FR1

	Parameter	Unit	NR Cell 1	NR Cell 11	Remark
T0	SS/PBCH SSS EPRE	dBm/SCS	-88	"Off"	The power level values are assigned to ensure the UE registered on NR Cell 1.
	Qrxlevmin	dBm	-110	-	
T1	SS/PBCH SSS EPRE	dBm/SCS	"Off"	-88	$Srxlev_{NRCell\ 1} < 0$ (NOTE 1)
	Qrxlevmin	dBm	-	-110	
T2	SS/PBCH SSS EPRE	dBm/SCS	-94	-88	$Srxlev_{NRCell\ 11} > 0$, $Srxlev_{NRCell\ 1} > 0$
	Qrxlevmin	dBm	-110	-110	
	cellBarred	-	notBarred	barred	Serving cell becomes barred

NOTE 1: Power level "Off" is defined in TS 38.508-1 [4] Table 6.2.2.1-3.

Table 6.1.2.3.3.2-2: Time instances of cell power level and parameter changes for FR2

	Parameter	Unit	NR Cell 1	NR Cell 11	Remark
T0	SS/PBCH SSS EPRE	dBm/SCS	FFS	"Off"	The power level values are assigned to ensure the UE registered on NR Cell 1.
	Qrxlevmin	dBm	FFS	-	
T1	SS/PBCH SSS EPRE	dBm/SCS	"Off"	FFS	$Srxlev_{NRCell\ 1} < 0$ (NOTE 1)
	Qrxlevmin	dBm	-	FFS	
T2	SS/PBCH SSS EPRE	dBm/SCS	FFS	FFS	$Srxlev_{NRCell\ 11} > 0$, $Srxlev_{NRCell\ 1} > 0$
	Qrxlevmin	dBm	FFS	FFS	
	cellBarred	-	notBarred	barred	Serving cell becomes barred

NOTE 1: Power level "Off" is defined in TS 38.508-1 [4] Table 6.2.2.2-2.

NOTE: If the UE fails the test because of a failure to detect and reselect to a right cell, then the operator may re-run the test.

Table 6.1.2.3.3.2-3: Main behaviour

St	Procedure	Message Sequence		TP	Verdict
		U - S	Message		
1	SS re-adjusts the SS/PBCH EPRE level of NR Cell 1 and NR Cell 11 according to row "T1" in table 6.1.2.3.3.2-1/2.	-	-	-	-
2	Check: Does the test result of generic test procedure in TS 38.508-1 [4] clause 4.9.5 indicate that the UE is camped on NR Cell 11? NOTE: The UE performs a registration for mobility procedure and the RRC connection is released.	-	-	1	-
3	SS changes NR Cell 11 SS/PBCH EPRE level and MIB IE <i>cellBarred</i> according to row "T2" in table 6.1.2.3.3.2-1/2. And SS transmits Short Message on PDCCH addressed to P-RNTI using Short Message field in DCI format 1_0. Bit 1 of Short Message field is set to 1 to indicate the SysInfo Modification.	-	-	-	-
4	Check: Does the test result of generic test procedure in TS 38.508-1 [4] clause 4.9.5 indicate that the UE is camped on NR Cell 1? NOTE: The RRC connection is released and UE is in RRC_IDLE mode.	-	-	2	-

6.1.2.3.3.3 Specific message contents

Table 6.1.2.3.3.3-1: *SIB1* for NR Cells 1 and 11 (Preamble and all steps, table 6.1.2.3.3.2-3)

Derivation Path: TS 38.508-1 [4], Table 4.6.1-28			
Information Element	Value/remark	Comment	Condition
SIB1 ::= SEQUENCE {			
cellSelectionInfo SEQUENCE {			
q-RxLevMin	-55	-110 dBm	FR1
	FFS		FR2
}			
}			

Table 6.1.2.3.3.3-2: *SIB2* for NR Cells 1 and 11 (Preamble and all steps, table 6.1.2.3.3.2-3)

Derivation Path: TS 38.508-1 [4], Table 4.6.2-1			
Information Element	Value/remark	Comment	Condition
SIB2 ::= SEQUENCE {			
cellReselectionInfoCommon SEQUENCE {			
rangeToBestCell	Not present		
}			
intraFreqCellReselectionInfo SEQUENCE {			
q-RxLevMin	-55	-110 dBm	FR1
	FFS		FR2
t-ReselectionNR	7		
}			
}			

Table 6.1.2.3.3.3-3: *MIB* for NR Cell 11 (step 3, Table 6.1.2.3.3.2-3)

Derivation Path: TS 38.508-1 [4], Table 4.6.1-6			
Information Element	Value/remark	Comment	Condition
MIB ::= SEQUENCE {			
cellBarred	barred		
}			

6.1.2.4 Cell Reselection for interband operation

6.1.2.4.1 Test Purpose (TP)

(1)

```
with { UE in NR RRC_IDLE state }
ensure that {
  when { UE detects the cell re-selection criteria are met for the cell on the different frequency
band }
  then { UE reselects the new cell }
}
```

6.1.2.4.2 Conformance requirements

References: The conformance requirements covered in the present TC are specified in TS 38.304: clause 5.2.3.2 and 5.2.4.5. Unless otherwise stated these are Rel-15 requirements.

[TS 38.304, clause 5.2.3.2]

The cell selection criterion S is fulfilled when:

$$S_{rxlev} > 0 \text{ AND } S_{qual} > 0$$

where:

$$S_{rxlev} = Q_{rxlevmeas} - (Q_{rxlevmin} + Q_{rxlevminoffset}) - P_{compensation} - Q_{offsettemp}$$

$$S_{qual} = Q_{qualmeas} - (Q_{qualmin} + Q_{qualminoffset}) - Q_{offsettemp}$$

where:

Srxlev	Cell selection RX level value (dB)
Squal	Cell selection quality value (dB)
Qoffset _{temp}	Offset temporarily applied to a cell as specified in TS 38.331 [3] (dB)
Qrxlevmeas	Measured cell RX level value (RSRP)
Qqualmeas	Measured cell quality value (RSRQ)
Qrxlevmin	Minimum required RX level in the cell (dBm). If the UE supports SUL frequency for this cell, Qrxlevmin is obtained from <i>RxLevMinSUL</i> , if present, in <i>SIB1</i> , <i>SIB2</i> and <i>SIB4</i> , additionally, if Q _{rxlevminoffsetcellSUL} is present in <i>SIB3</i> and <i>SIB4</i> for the concerned cell, this cell specific offset is added to the corresponding Qrxlevmin to achieve the required minimum RX level in the concerned cell; else Qrxlevmin is obtained from <i>q-RxLevMin</i> in <i>SIB1</i> , <i>SIB2</i> and <i>SIB4</i> , additionally, if Q _{rxlevminoffsetcell} is present in <i>SIB3</i> and <i>SIB4</i> for the concerned cell, this cell specific offset is added to the corresponding Qrxlevmin to achieve the required minimum RX level in the concerned cell.
Qqualmin	Minimum required quality level in the cell (dB). Additionally, if Q _{qualminoffsetcell} is signalled for the concerned cell, this cell specific offset is added to achieve the required minimum quality level in the concerned cell.
Qrxlevminoffset	Offset to the signalled Q _{rxlevmin} taken into account in the Srxlev evaluation as a result of a periodic search for a higher priority PLMN while camped normally in a VPLMN, as specified in TS 23.122 [9]
Qqualminoffset	Offset to the signalled Q _{qualmin} taken into account in the Squal evaluation as a result of a periodic search for a higher priority PLMN while camped normally in a VPLMN, as specified in TS 23.122 [9]
P _{compensation}	If the UE supports the additionalP _{max} in the NR-NS-P _{maxList} , if present, in <i>SIB1</i> , <i>SIB2</i> and <i>SIB4</i> : $\max(P_{EMAX1} - P_{PowerClass}, 0) - (\min(P_{EMAX2}, P_{PowerClass}) - \min(P_{EMAX1}, P_{PowerClass}))$ (dB); else: $\max(P_{EMAX1} - P_{PowerClass}, 0)$ (dB)
P _{EMAX1} , P _{EMAX2}	Maximum TX power level of a UE may use when transmitting on the uplink in the cell (dBm) defined as P _{EMAX} in TS 38.101 [15]. If UE supports SUL frequency for this cell, P _{EMAX1} and P _{EMAX2} are obtained from the <i>p-Max</i> for SUL in <i>SIB1</i> and <i>NR-NS-PmaxList</i> for SUL respectively in <i>SIB1</i> , <i>SIB2</i> and <i>SIB4</i> as specified in TS 38.331 [3], else P _{EMAX1} and P _{EMAX2} are obtained from the <i>p-Max</i> and <i>NR-NS-PmaxList</i> respectively in <i>SIB1</i> , <i>SIB2</i> and <i>SIB4</i> for regular UL as specified in TS 38.331 [3].
P _{PowerClass}	Maximum RF output power of the UE (dBm) according to the UE power class as defined in TS 38.101 [15]

The signalled values Q_{rxlevminoffset} and Q_{qualminoffset} are only applied when a cell is evaluated for cell selection as a result of a periodic search for a higher priority PLMN while camped normally in a VPLMN (TS 23.122 [9]). During this periodic search for higher priority PLMN, the UE may check the S criteria of a cell using parameter values stored from a different cell of this higher priority PLMN.[TS 38.304, clause 5.2.4.5]

If *threshServingLowQ* is broadcast in system information and more than 1 second has elapsed since the UE camped on the current serving cell, cell reselection to a cell on a higher priority NR frequency or inter-RAT frequency than the serving frequency shall be performed if:

- A cell of a higher priority NR or EUTRAN RAT/frequency fulfils $Squal > Thresh_{X, HighQ}$ during a time interval $T_{reselection_{RAT}}$

Otherwise, cell reselection to a cell on a higher priority NR frequency or inter-RAT frequency than the serving frequency shall be performed if:

- A cell of a higher priority RAT/ frequency fulfils $Srxlev > Thresh_{X, HighP}$ during a time interval $T_{reselection_{RAT}}$; and
- More than 1 second has elapsed since the UE camped on the current serving cell.

Cell reselection to a cell on an equal priority NR frequency shall be based on ranking for intra-frequency cell reselection as defined in subclause 5.2.4.6.

If *threshServingLowQ* is broadcast in system information and more than 1 second has elapsed since the UE camped on the current serving cell, cell reselection to a cell on a lower priority NR frequency or inter-RAT frequency than the serving frequency shall be performed if:

- The serving cell fulfils $S_{qual} < \text{Thresh}_{\text{Serving, LowQ}}$ and a cell of a lower priority NR or E-UTRAN RAT/ frequency fulfils $S_{qual} > \text{Thresh}_{X, \text{LowQ}}$ during a time interval $\text{T}_{\text{reselection}_{\text{RAT}}}$.

Otherwise, cell reselection to a cell on a lower priority NR frequency or inter-RAT frequency than the serving frequency shall be performed if:

- The serving cell fulfils $S_{rxlev} < \text{Thresh}_{\text{Serving, LowP}}$ and a cell of a lower priority RAT/ frequency fulfils $S_{rxlev} > \text{Thresh}_{X, \text{LowP}}$ during a time interval $\text{T}_{\text{reselection}_{\text{RAT}}}$; and
- More than 1 second has elapsed since the UE camped on the current serving cell.

Cell reselection to a higher priority RAT/frequency shall take precedence over a lower priority RAT/frequency if multiple cells of different priorities fulfil the cell reselection criteria.

If more than one cell meets the above criteria, the UE shall reselect a cell as follows:

- If the highest-priority frequency is an NR frequency, the highest ranked cell among the cells on the highest priority frequency(ies) meeting the criteria according to clause 5.2.4.6;
- If the highest-priority frequency is from another RAT, the highest ranked cell among the cells on the highest priority frequency(ies) meeting the criteria of that RAT.

6.1.2.4.3 Test description

6.1.2.4.3.1 Pre-test conditions

System Simulator:

- NR Cell 1 and NR Cell 10.
- System information combination NR-4 as defined in TS 38.508-1 [4] Table 4.4.3.1.2-1 is used in NR cells.

UE:

None.

Preamble:

- The UE is in state 1N-A on NR Cell 1(serving cell) according to TS 38.508-1 [4] Table 4.4.A.2-1.

6.1.2.4.3.2 Test procedure sequence

Table 6.1.2.6.3.2-1/2 illustrates the downlink power levels and other changing parameters to be applied for the NR cells at various time instants of the test execution. The exact instants on which these values shall be applied are described in the texts in this clause. The configuration "T0" indicates the initial conditions. Subsequent configurations marked "T1" is applied at the points indicated in the Main behaviour description in Table 6.1.2.4.3.2-3.

Table 6.1.2.4.3.2-1: Time instances of cell power level and parameter changes for FR1

	Parameter	Unit	NR Cell 1	NR Cell 10	Remark
T0	SS/PBCH SSS EPRE	dBm/SCS	-88	Off	The power level values are assigned to ensure the UE registered on NR Cell 1.
T1	SS/PBCH SSS EPRE	dBm/SCS	-88	-78	NR Cell 10 become stronger than $\text{Thresh}_{\text{NR Cell 10, high}}$.
Note: Power level "Off" is defined in TS38.508-1 [4] Table 6.2.2.1-3.					

Table 6.1.2.4.3.2-2: Time instances of cell power level and parameter changes for FR2

	Parameter	Unit	NR Cell 1	NR Cell 10	Remark
T0	SS/PBCH SSS EPRE	dBm/SCS	FFS	Off	The power level values are assigned to ensure the UE registered on NR Cell 1.
T1	SS/PBCH SSS EPRE	dBm/SCS	FFS	FFS	NR Cell 10 become stronger than Thresh _{NR Cell 10, high} .
Note: The uncertain downlink signal level is specified in TS 38.508-1 [4] clause FFS.					

Table 6.1.2.4.3.2-3: Main behaviour

St	Procedure	Message Sequence		TP	Verdict
		U - S	Message		
1	The SS changes NR Cell 10 SS/PBCH EPRE level according to the row "T1" in table 6.1.2.4.3.2-1/2.	-	-	-	-
2	Wait for 34 seconds to allow UE to recognise the change.	-	-	-	-
3	Check: Does the test result of generic test procedure in TS 38.508-1 [4] Table 4.9.4-1 indicate that the UE is camped on NR Cell 10?	-	-	1	-

6.1.2.4.3.3 Specific message contents

Table 6.1.2.4.3.3-1: Conditions for specific message contents in Tables below

Condition	Explanation
NR Cell 1	This condition applies to system information transmitted on NR Cell 1.
NR Cell 10	This condition applies to system information transmitted on NR Cell 10.

Table 6.1.2.4.3.3-2: SIB2 of NR Cell 1 and NR Cell10 (preamble and all steps, Table 6.1.2.4.3.2-3)

Derivation Path: TS 38.508-1 [4], Table 4.6.2-1			
Information Element	Value/remark	Comment	Condition
SIB2::= SEQUENCE {			
cellReselectionServingFreqInfo			
SEQUENCE{			
cellReselectionPriority	1		NR Cell 1
	5		NR Cell 10
}			
}			

Table 6.1.2.4.3.3-3: SIB4 of NR Cell 1 and NR Cell 10 (preamble and all steps, Table 6.1.2.4.3.2-3)

Derivation Path: TS 38.508-1 [4], Table 4.6.2-3			
Information Element	Value/remark	Comment	Condition
SIB4 ::= SEQUENCE {			
InterFreqCarrierFreqList SEQUENCE (SIZE (1..maxFreq)) OF	1 entry		
InterFreqCarrierFreqInfo {			
InterFreqCarrierFreqInfo[1] SEQUENCE		entry 1	
{			
dl-CarrierFreq	Same downlink ARFCN as used for NR Cell 10		NR Cell 1
	Same downlink ARFCN as used for NR Cell 1		NR Cell 10
t-ReselectionNR	7	seconds	
threshX-HighP	10	20 dB	
cellReselectionPriority	5		NR Cell 1
	1		NR Cell 10
}			
}			
}			

6.1.2.5 Cell reselection for interband operation using Pcompensation / Between FDD and TDD

6.1.2.5.1 Test Purpose (TP)

(1)

```
with { UE in NR RRC_IDLE state on a FDD band }
ensure that {
  when { UE detects the cell selection using Pcompensation & reselection criteria is met for the
cell on a TDD band }
    then { UE reselects the new cell }
}
```

6.1.2.5.2 Conformance requirements

References: The conformance requirements covered in the present TC are specified in TS 38.304: clause 5.2.3.2 and 5.2.4.5. Unless otherwise stated these are Rel-15 requirements.

[TS 38.304, clause 5.2.3.2]

The cell selection criterion S is fulfilled when:

$$S_{rxlev} > 0 \text{ AND } S_{qual} > 0$$

where:

$$S_{rxlev} = Q_{rxlevmeas} - (Q_{rxlevmin} + Q_{rxlevminoffset}) - P_{compensation} - Q_{offsettemp}$$

$$S_{qual} = Q_{qualmeas} - (Q_{qualmin} + Q_{qualminoffset}) - Q_{offsettemp}$$

where:

Srxlev	Cell selection RX level value (dB)
Squal	Cell selection quality value (dB)
Qoffsettemp	Offset temporarily applied to a cell as specified in TS 38.331 [3] (dB)
Qrxlevmeas	Measured cell RX level value (RSRP)
Qqualmeas	Measured cell quality value (RSRQ)
Qrxlevmin	Minimum required RX level in the cell (dBm). If the UE supports SUL frequency for this cell, Qrxlevmin is obtained from <i>RxLevMinSUL</i> , if present, in <i>SIB1</i> , <i>SIB2</i> and <i>SIB4</i> , additionally, if <i>QrxlevminoffsetcellSUL</i> is present in <i>SIB3</i> and <i>SIB4</i> for the concerned cell, this cell specific offset is added to the corresponding Qrxlevmin to achieve the required minimum RX level in the concerned cell; else Qrxlevmin is obtained from <i>q-RxLevMin</i> in <i>SIB1</i> , <i>SIB2</i> and <i>SIB4</i> , additionally, if <i>Qrxlevminoffsetcell</i> is present in <i>SIB3</i> and <i>SIB4</i> for the concerned cell, this cell specific offset is added to the corresponding Qrxlevmin to achieve the required minimum RX level in the concerned cell.
Qqualmin	Minimum required quality level in the cell (dB). Additionally, if <i>Qqualminoffsetcell</i> is signalled for the concerned cell, this cell specific offset is added to achieve the required minimum quality level in the concerned cell.
Qrxlevminoffset	Offset to the signalled Qrxlevmin taken into account in the Srxlev evaluation as a result of a periodic search for a higher priority PLMN while camped normally in a VPLMN, as specified in TS 23.122 [9]
Qqualminoffset	Offset to the signalled Qqualmin taken into account in the Squal evaluation as a result of a periodic search for a higher priority PLMN while camped normally in a VPLMN, as specified in TS 23.122 [9]
Pcompensation	If the UE supports the additionalPmax in the NR-NS-PmaxList, if present, in <i>SIB1</i> , <i>SIB2</i> and <i>SIB4</i> : $\max(P_{EMAX1} - P_{PowerClass}, 0) - (\min(P_{EMAX2}, P_{PowerClass}) - \min(P_{EMAX1}, P_{PowerClass}))$ (dB); else: $\max(P_{EMAX1} - P_{PowerClass}, 0)$ (dB)
P _{EMAX1} , P _{EMAX2}	Maximum TX power level of a UE may use when transmitting on the uplink in the cell (dBm) defined as P _{EMAX} in TS 38.101 [15]. If UE supports SUL frequency for this cell, P _{EMAX1} and P _{EMAX2} are obtained from the <i>p-Max</i> for SUL in <i>SIB1</i> and <i>NR-NS-PmaxList</i> for SUL respectively in <i>SIB1</i> , <i>SIB2</i> and <i>SIB4</i> as specified in TS 38.331 [3], else P _{EMAX1} and P _{EMAX2} are obtained from the <i>p-Max</i> and <i>NR-NS-PmaxList</i> respectively in <i>SIB1</i> , <i>SIB2</i> and <i>SIB4</i> for regular UL as specified in TS 38.331 [3].
P _{PowerClass}	Maximum RF output power of the UE (dBm) according to the UE power class as defined in TS 38.101 [15]

The signalled values *Qrxlevminoffset* and *Qqualminoffset* are only applied when a cell is evaluated for cell selection as a result of a periodic search for a higher priority PLMN while camped normally in a VPLMN (TS 23.122 [9]). During this periodic search for higher priority PLMN, the UE may check the S criteria of a cell using parameter values stored from a different cell of this higher priority PLMN.[TS 38.304, clause 5.2.4.5]

If *threshServingLowQ* is broadcast in system information and more than 1 second has elapsed since the UE camped on the current serving cell, cell reselection to a cell on a higher priority NR frequency or inter-RAT frequency than the serving frequency shall be performed if:

- A cell of a higher priority NR or EUTRAN RAT/frequency fulfils $Squal > Thresh_{X, HighQ}$ during a time interval $T_{reselection_{RAT}}$

Otherwise, cell reselection to a cell on a higher priority NR frequency or inter-RAT frequency than the serving frequency shall be performed if:

- A cell of a higher priority RAT/ frequency fulfils $Srxlev > Thresh_{X, HighP}$ during a time interval $T_{reselection_{RAT}}$; and
- More than 1 second has elapsed since the UE camped on the current serving cell.

Cell reselection to a cell on an equal priority NR frequency shall be based on ranking for intra-frequency cell reselection as defined in subclause 5.2.4.6.

If *threshServingLowQ* is broadcast in system information and more than 1 second has elapsed since the UE camped on the current serving cell, cell reselection to a cell on a lower priority NR frequency or inter-RAT frequency than the serving frequency shall be performed if:

- The serving cell fulfils $S_{qual} < \text{Thresh}_{\text{Serving, LowQ}}$ and a cell of a lower priority NR or E-UTRAN RAT/ frequency fulfils $S_{qual} > \text{Thresh}_{X, \text{LowQ}}$ during a time interval $\text{T}_{\text{reselection}_{\text{RAT}}}$.

Otherwise, cell reselection to a cell on a lower priority NR frequency or inter-RAT frequency than the serving frequency shall be performed if:

- The serving cell fulfils $S_{rxlev} < \text{Thresh}_{\text{Serving, LowP}}$ and a cell of a lower priority RAT/ frequency fulfils $S_{rxlev} > \text{Thresh}_{X, \text{LowP}}$ during a time interval $\text{T}_{\text{reselection}_{\text{RAT}}}$; and
- More than 1 second has elapsed since the UE camped on the current serving cell.

Cell reselection to a higher priority RAT/frequency shall take precedence over a lower priority RAT/frequency if multiple cells of different priorities fulfil the cell reselection criteria.

If more than one cell meets the above criteria, the UE shall reselect a cell as follows:

- If the highest-priority frequency is an NR frequency, the highest ranked cell among the cells on the highest priority frequency(ies) meeting the criteria according to clause 5.2.4.6;
- If the highest-priority frequency is from another RAT, the highest ranked cell among the cells on the highest priority frequency(ies) meeting the criteria of that RAT.

6.1.2.5.3 Test description

6.1.2.5.3.1 Pre-test conditions

System Simulator:

- NR Cell 1 is set to NR FDD mode and NR Cell 10 is set to NR TDD mode.
- System information combination NR-4 as defined in TS 38.508-1 [4] Table 4.4.3.1.2-1 is used in NR cells.

UE:

None.

Preamble:

- The UE is in state 1N-A on NR Cell 1(serving cell) according to TS 38.508-1 [4] Table 4.4A.2-1.

6.1.2.5.3.2 Test procedure sequence

Table 6.1.2.5.3.2-1/2 illustrates the downlink power levels and other changing parameters to be applied for the NR cells at various time instants of the test execution. The exact instants on which these values shall be applied are described in the texts in this clause. The configuration "T0" indicates the initial conditions. Subsequent configuration marked "T1" is applied at the points indicated in the Main behaviour description in Table 6.1.2.5.3.2-3.

Table 6.1.2.5.3.2-1: Time instances of cell power level and parameter changes for FR1

	Parameter	Unit	NR Cell 1	NR Cell 10	Remark
T0	SS/PBCH SSS EPRE	dBm/SCS	-88	Off	The power level values are assigned to ensure the UE registered on NR Cell 1.
T1	SS/PBCH SSS EPRE	dBm/SCS	-88	-80	NR Cell 1 become lower than $\text{Thresh}_{\text{serv}, \text{low}}$ and NR Cell 10 become stronger than $\text{Thresh}_{\text{NR Cell 10, low}}$.
Note: Power level "Off" is defined in TS38.508-1 [4] Table 6.2.2.1-3.					

Table 6.1.2.5.3.2-2: Time instances of cell power level and parameter changes for FR2

	Parameter	Unit	NR Cell 1	NR Cell 10	Remark
T0	SS/PBCH SSS EPRE	dBm/SCS	FFS	Off	The power level values are assigned to ensure the UE registered on NR Cell 1.
T1	SS/PBCH SSS EPRE	dBm/SCS	FFS	FFS	NR Cell 1 become lower than $\text{Thresh}_{\text{serv}, \text{low}}$ and NR Cell 10 become stronger than $\text{Thresh}_{\text{NR Cell 10, low}}$.
Note: The uncertain downlink signal level is specified in TS 38.508-1[4] section FFS.					

Table 6.1.2.5.3.2-3: Main behaviour

St	Procedure	Message Sequence		TP	Verdict
		U - S	Message		
1	The SS changes NR Cell 10 SS/PBCH EPRE level according to the row "T1" in table 6.1.2.5.3.2-1/2.	-	-	-	-
2	Wait for 34 seconds to allow UE to recognise the change.	-	-	-	-
3	Check: Does the test result of generic test procedure in TS 38.508-1 [4] Table 4.9.4-1 indicate that the UE is camped on NR Cell 10?	-	-	1	-

6.1.2.5.3.3 Specific message contents

Table 6.1.2.5.3.3-1: Conditions for specific message contents in Tables below

Condition	Explanation
NR Cell 1	This condition applies to system information transmitted on NR Cell 1.
NR Cell 10	This condition applies to system information transmitted on NR Cell 10.

Table 6.1.2.5.3.3-2: SIB1 of NR Cell 1 (preamble and all steps, Table 6.1.2.5.3.2-3)

Derivation Path: TS 38.508-1 [4], Table 4.6.1-28			
Information Element	Value/remark	Comment	Condition
SIB1 ::= SEQUENCE {			
servingCellConfigCommon SEQUENCE{			
uplinkConfigCommon SEQUENCE{			
FrequencyInfoUL SEQUENCE {			
p-Max	33dBm		
}			
}			
}			
}			

Table 6.1.2.5.3.3-3: SIB2 of NR Cell 1 and NR Cell10 (preamble and all steps, Table 6.1.2.5.3.2-3)

Derivation Path: TS 38.508-1 [4], Table 4.6.2-1			
Information Element	Value/remark	Comment	Condition
SIB2 ::= SEQUENCE {			
cellReselectionServingFreqInfo SEQUENCE{			
threshServingLowP	9	18 dB	NR Cell 1
cellReselectionPriority	5		NR Cell 1
	1		NR Cell 10
}			
}			

Table 6.1.2.5.3.3-4: SIB4 of NR Cell 1 and NR Cell 10 (preamble and all steps, Table 6.1.2.5.3.2-3)

Derivation Path: TS 38.508-1 [4], Table 4.6.2-3			
Information Element	Value/remark	Comment	Condition
SIB4 ::= SEQUENCE {			
InterFreqCarrierFreqList SEQUENCE (SIZE (1..maxFreq)) OF InterFreqCarrierFreqInfo {	1 entry		
InterFreqCarrierFreqInfo[1] SEQUENCE {		entry 1	
dl-CarrierFreq	Same downlink ARFCN as used for NR Cell 10		NR Cell 1
	Same downlink ARFCN as used for NR Cell 1		NR Cell 10
p-Max	33dBm		NR Cell 1
t-ReselectionNR	7	seconds	
threshX-HighP	14	28 dB	
threshX-LowP	6	12 dB	
cellReselectionPriority	1		NR Cell 1
	5		NR Cell 10
}			
}			

6.1.2.6

6.1.2.7 Cell reselection / Equivalent PLMN

6.1.2.7.1 Test Purpose (TP)

(1)

with { UE camped normally on a cell and network has downloaded a list of equivalent PLMNs during the Registration procedure}

```

ensure that {
  when { a suitable neighbour cell on an equivalent PLMN becomes better ranked than the suitable
  Serving cell}
  then { UE reselects to this equivalent PLMN cell}
}

```

(2)

```

with { UE camped normally on a cell and network has downloaded a list of equivalent PLMNs during the
Registration procedure}
ensure that {
  when { the Serving cell becomes unsuitable due to S<0 and a suitable cell exists on an equivalent
  PLMN}
  then {UE reselects to this equivalent PLMN cell}
}

```

(3)

```

with { UE camped normally on a cell and network has downloaded a list of equivalent PLMNs during the
Registration procedure}
ensure that {
  when { the UE evaluates cells for reselection}
  then { UE ignores suitable cells for which the UE has no reselection priority provided}
}

```

6.1.2.7.2 Conformance requirements

References: The conformance requirements covered in the present test case are specified in: TS 23.122, clause 4.4.3, TS 38.304, clause 5.2.4.1. Unless otherwise stated these are Rel-15 requirements.

[TS 38.304, clause 5.2.4.1]

The UE shall only perform cell reselection evaluation for NR frequencies and inter-RAT frequencies that are given in system information and for which the UE has a priority provided.

[TS 23.122, clause 4.4.3]

The Mobile Equipment stores a list of "equivalent PLMNs". This list is replaced or deleted at the end of each location update procedure, routing area update procedure, GPRS attach procedure, tracking area update procedure, EPS attach procedure, and registration procedure. The list is deleted by an MS attached for emergency bearer services after detach or registered for emergency services after deregistration. The stored list consists of a list of equivalent PLMNs as downloaded by the network plus the PLMN code of the registered PLMN that downloaded the list. All PLMNs in the stored list, in all access technologies supported by the PLMN, are regarded as equivalent to each other for PLMN selection, cell selection/re-selection and handover.

6.1.2.7.3 Test Description

6.1.2.7.3.1 Pre-test conditions

System Simulator:

Three inter-frequency multi-PLMN NR Cells as specified in TS 38.508-1 Table 4.4.2.1 are configured broadcasting PLMNs as indicated in Table 6.1.2.7.3.1-1.

The PLMNs are identified in the test by the identifiers in Table 6.1.2.7.3.1-1.

Table 6.1.2.7.3.1-1: PLMN identifiers

NR Cell	PLMN name	MCC	MNC
11	PLMN1	001	11
12	PLMN2	002	21
13	PLMN3	003	31

All NR cells are high quality.

All cells are suitable cells.

System information combination NR-4 as defined in TS 38.508-1 [4] clause 4.4.3.1.3 is used in NR cells

UE:

The UE is in Automatic PLMN selection mode.

Preamble:

The UE is registered on PLMN1 (NR Cell 11) using the procedure described in TS 38.508-1[4] clause 4.5.2.2 except that the REGISTRATION ACCEPT message indicates PLMN3 in the Equivalent PLMN list as described in Table 6.1.2.7.3.3-1.

The UE is in state Registered, Idle Mode (State 1N-A) on NR Cell 11 according to 38.508-1[4];

6.1.2.7.3.2 Test procedure sequence

Table 6.1.2.7.3.2-1 for FR1 and Table 6.1.2.7.3.2-2 for FR2 illustrates the downlink power levels and other changing parameters to be applied for the cells at various time instants of the test execution. Row marked "T0" denotes the initial conditions after preamble, while columns marked "T1" and "T2" are to be applied subsequently in the Main behaviour. The exact instants on which these values shall be applied are described in the texts in this clause.

Table 6.1.2.7.3.2-1: Cell configuration changes over time for FR1

	Parameter	Unit	NR Cell 11	NR Cell 12	NR Cell 13	Remarks
T0	SS/PBCH SSS EPRE	dBm/SCS	-78	-89	-100	All NR cells S>0
T1	SS/PBCH SSS EPRE	dBm/SCS	-115	-89	-100	NR Cell 11 S < 0 as described in TS 38.508-1 clause FFS
T2	SS/PBCH SSS EPRE	dBm/SCS	-78	-100	-89	All NR cells S>0
Note 1: The default values (including "not present") for all other parameters influencing cell reselection are suitable for this test. The values are defined in TS 38.508-1 clauses FFS.						

Table 6.1.2.7.3.2-2: Cell configuration changes over time for FR2

	Parameter	Unit	NR Cell 11	NR Cell 12	NR Cell 13	Remarks
T0	SS/PBCH SSS EPRE	FFS	FFS	FFS	FFS	All NR cells S>0
T1	SS/PBCH SSS EPRE	FFS	FFS	FFS	FFS	NR Cell 1 S < 0 as described in TS 38.508-1 clause FFS
T2	SS/PBCH SSS EPRE	FFS	FFS	FFS	FFS	All NR cells S>0
Note 1: The default values (including "not present") for all other parameters influencing cell reselection are suitable for this test. The values are defined in TS 38.508-1 clauses FFS.						

Table 6.1.2.7.3.2-3: Main behaviour

St	Procedure	Message Sequence		TP	Verdict
		U - S	Message		
1	Check: Does the UE transmit an <i>RRCSetupRequest</i> message within T seconds? (Note 1)	-->	NR RRC: <i>RRCSetupRequest</i>	1	F
2	SS adjusts cell levels according to row T1 of table 6.1.2.7.3.2-1 for FR1 (or table 6.1.2.7.3.2-2 for FR2)	-	-	-	-
3	Check: Does the test result of generic test procedure in TS 38.508-1 Table 4.9.5.2.2-1 indicate that the UE is camped on NR Cell 13? NOTE: The UE performs a "REGISTRATION REQUEST" procedure with type "mobility registration updating" with PLMN1 and PLMN2 listed as an Equivalent PLMN in the REGISTRATION ACCEPT message; the RRC connection is released.	-		2	-
4	Check: Does the test result of generic test procedure in TS 38.508-1 Table 4.9.5.2.2-1 indicate that the UE is camped on NR Cell 12? NOTE: The UE performs a "REGISTRATION REQUEST" procedure with type "mobility registration updating" with PLMN1 and PLMN3 listed as an Equivalent PLMN in the REGISTRATION ACCEPT message; the RRC connection is released.	-		1	-
5	SS adjusts cell levels according to row T0 of table 6.1.2.7.3.2-1 for FR1 (or table 6.1.2.7.3.2-2 for FR2)	-		-	-
6	Check: Does the UE transmit an <i>RRCSetupRequest</i> message within T seconds? (Note 1)	-->	NR RRC <i>RRCSetupRequest</i>	1,3	F
7	SS adjusts cell levels according to row T2 of table 6.1.2.7.3.2-1 for FR1 (or table 6.1.2.7.3.2-2 for FR2)	-	-	-	-
8	Check: Does the test result of generic test procedure in TS 38.508-1 Table 4.9.5.2.2-1 indicate that the UE is camped on NR Cell 13? NOTE: The UE performs a "REGISTRATION REQUEST" procedure with type "mobility registration updating" with PLMN1 and PLMN2 listed as an Equivalent PLMN in the REGISTRATION ACCEPT message; the RRC connection is released. (Note 2)	-		3	P
<p>Note 1: In Steps 1 and 6, wait T seconds to ensure that the UE has detected, measured and evaluated the neighbour inter-frequency NR cells is provided, see TS 38.133 clause 4.2.2.4, where in T = 100sec for FR1 and 300sec for FR2</p> <p>Note 2: In Step 8, the UE moves to Cell 13 because no reselection priority is defined for Cell 1, see Table 6.1.2.7.3.3-4.</p>					

6.1.2.7.3.3 Specific message contents

Table 6.1.2.7.3.3-1: REGISTRATION ACCEPT for NR Cell 11 (preamble)

Derivation path: TS 38.508-1 Table 4.7.1-7			
Information Element	Value/remark	Comment	Condition
Equivalent PLMNs	PLMN3		

Table 6.1.2.7.3.2-2: REGISTRATION ACCEPT for NR Cell 13 (step 3 and 18, Table 6.1.2.7.3.2-3)

Derivation path: TS 38.508-1 Table 4.7.1-7			
Information Element	Value/remark	Comment	Condition
Equivalent PLMNs	PLMN1, 2		

Table 6.1.2.7.3.3-3: REGISTRATION ACCEPT for NR Cell 12 (step 4, Table 6.1.2.7.3.2-3)

Derivation path: TS 38.508-1 Table 4.7.1-7			
Information Element	Value/remark	Comment	Condition
Equivalent PLMNs	PLMN1, 3		

Table 6.1.2.7.3.3-4: SystemInformationBlockType4 for Cell 12 (preamble and all steps, Table 6.1.2.7.3.2-3)

Derivation Path: TS 38.508-1 Table 4.6.2-3			
Information Element	Value/remark	Comment	Condition
SIB4 ::= SEQUENCE {			
interFreqCarrierFreqList SEQUENCE (SIZE (1..maxFreq)) OF InterFreqCarrierFreqInfo {	2 entries	<i>n</i> denotes the index of the entry	
InterFreqCarrierFreqInfo[1] SEQUENCE {		entry 1	
dl-CarrierFreq	Same downlink EARFCN as used for Cell 11		
cellReselectionPriority	Not present	UE does not have a priority for frequency of Cell 11	
}			
InterFreqCarrierFreqInfo[2] SEQUENCE {		entry 2	
dl-CarrierFreq	Same downlink EARFCN as used for Cell 13		
}			
lateNonCriticalExtension	Not present		
}			

Table 6.1.2.7.3.3-5: SystemInformationBlockType4 for Cell 13 (preamble and all steps, Table 6.1.2.7.3.2-3)

Derivation Path: TS 38.508-1 Table 4.6.2-3			
Information Element	Value/remark	Comment	Condition
SIB4 ::= SEQUENCE {			
interFreqCarrierFreqList SEQUENCE (SIZE (1..maxFreq)) OF InterFreqCarrierFreqInfo {	2 entries	<i>n</i> denotes the index of the entry	
InterFreqCarrierFreqInfo[1] SEQUENCE {		entry 1	
dl-CarrierFreq	Same downlink EARFCN as used for Cell 11		
cellReselectionPriority	Not present	UE does not have a priority for frequency of Cell 11	
}			
InterFreqCarrierFreqInfo[2] SEQUENCE {		entry 2	
dl-CarrierFreq	Same downlink EARFCN as used for Cell 12		
}			
lateNonCriticalExtension	Not present		
}			

6.1.2.8 Cell reselection / Equivalent PLMN / Single Frequency operation

6.1.2.8.1 Test Purpose (TP)

(1)

```
with { UE camped normally on a cell and network has downloaded a list of equivalent PLMNs during the
Registration procedure }
ensure that {
  when { a suitable neighbour cell on an equivalent PLMN becomes better ranked than the suitable
Serving cell }
  then { UE reselects to this equivalent PLMN cell }
}
```

(2)

```
with { UE camped normally on a cell and network has downloaded a list of equivalent PLMNs during the
Registration procedure }
ensure that {
  when { the Serving cell becomes unsuitable due to S<0 and a suitable cell exists on an equivalent
PLMN }
  then { UE reselects to this equivalent PLMN cell }
}
```

6.1.2.8.2 Conformance requirements

References: The conformance requirements covered in the present TC are specified in TS 38.304: clause 5.2.4.1. Unless otherwise stated these are Rel-15 requirements.

[TS 38.304, clause 5.2.4.1]

The UE shall only perform cell reselection evaluation for NR frequencies and inter-RAT frequencies that are given in system information and for which the UE has a priority provided.

6.1.2.8.3 Test description

6.1.2.8.3.1 Pre-test conditions

System Simulator:

- Three intra-frequency multi-PLMN cells.
- The PLMNs are identified in the test by the identifiers in Table 6.1.2.8.3.1-1.
- System information combination NR-3 as defined in TS 38.508-1 [4] clause 4.4.3.1.3 is used in NR cells

Table 6.1.2.8.3.1-1: PLMN identifiers

Cell	PLMN name
1	PLMN1
2	PLMN2
4	PLMN3

- All cells are high quality.
- All cells are suitable cells.

UE:

- The UE is in Automatic PLMN selection mode.

Preamble:

- The UE is registered on PLMN1 (NR Cell 1) using the procedure described in TS 38.508-1[4] clause 4.5.2.2 except that the REGISTRATION ACCEPT message indicates PLMN3 in the Equivalent PLMN list as described in Table 6.1.2.8.3.3-1.
- The UE is in state Registered, Idle Mode (State 1N-A) on NR Cell 1 according to TS 38.508-1[4] Table 4.4A.2-1.

6.1.2.8.3.2 Test procedure sequence

Table 6.1.2.8.3.2-1 for FR1 and Table 6.1.2.8.3.2-2 for FR2 illustrates the downlink power levels and other changing parameters to be applied for the cells at various time instants of the test execution. Row marked "T0" denotes the initial conditions after preamble, while columns marked "T1" and "T2" are to be applied subsequently in the Main behaviour. The exact instants on which these values shall be applied are described in the texts in this clause.

Table 6.1.2.8.3.2-1: Cell configuration changes over time for FR1

	Parameter	Unit	NR Cell 1	NR Cell 2	NR Cell 4	Remarks
T0	SS/PBCH SSS EPRE	dBm/SC S	-78	-84	-90	All NR cells S > 0
T1	SS/PBCH SSS EPRE	dBm/SC S	-115	-88	-82	NR Cell 1 S < 0 as described in TS 38.508-1[4] clause 6.2.2.1
T2	SS/PBCH SSS EPRE	dBm/SC S	-115	-82	-88	

Table 6.1.2.8.3.2-2: Cell configuration changes over time for FR2

	Parameter	Unit	NR Cell 1	NR Cell 2	NR Cell 4	Remarks
T0	SS/PBCH SSS EPRE	FFS	FFS	FFS	FFS	All NR cells S > 0
T1	SS/PBCH SSS EPRE	FFS	FFS	FFS	FFS	NR Cell 1 S < 0 as described in TS 38.508-1[4] clause 6.2.2.2
T2	SS/PBCH SSS EPRE	FFS	FFS	FFS	FFS	

Table 6.1.2.8.3.2-3: Main behaviour

St	Procedure	Message Sequence		TP	Verdict
		U - S	Message		
1	Check: Does the UE send an <i>RRCSetupRequest</i> within the next T seconds? NOTE: The wait period of T seconds is to ensure that the UE has detected, measured and evaluated the neighbour inter-frequency NR cells is provided, see TS 38.133[30] clause 4.2.2.4, where in T = 100sec for FR1 and 300sec for FR2.	-->	NR RRC: <i>RRCSetupRequest</i>	1	F
2	SS adjusts cell levels according to row T1 of table 6.1.2.8.3.2-1 for FR1 (or table 6.1.2.8.3.2-2 for FR2).	-	-	-	-
3	Check: Does the test result of generic test procedure in TS 38.508-1[4] subclause 4.9.5 indicate that the UE is camped on NR Cell 4? NOTE: The UE performs a Registration procedure for mobility registration update with PLMN1 and PLMN2 listed as an Equivalent PLMN in the REGISTRATION ACCEPT message.	-	-	2	-
4	SS adjusts cell levels according to row T2 of table 6.1.2.8.3.2-1 for FR1 (or table 6.1.2.8.3.2-2 for FR2).	-	-	-	-
5	Check: Does the test result of generic test procedure in TS 38.508-1 [4] subclause 4.9.5 indicate that the UE is camped on NR Cell 2? NOTE: The UE performs a Registration procedure for mobility registration update with PLMN1 and PLMN3 listed as an Equivalent PLMN in the REGISTRATION ACCEPT message.	-	-	1	-
6	SS adjusts cell levels according to row T1 of table 6.1.2.8.3.2-1 for FR1 (or table 6.1.2.8.3.2-2 for FR2).	-	-	-	-
7	Check: Does the test result of generic test procedure in TS 38.508-1 [4] subclause 4.9.5 indicate that the UE is camped on NR Cell 4, 'connected without release'? NOTE: The UE performs a Registration procedure for mobility registration update with PLMN1 and PLMN2 listed as an Equivalent PLMN in the REGISTRATION ACCEPT message.	-	-	1	-

6.1.2.8.3.3 Specific message contents

Table 6.1.2.8.3.3-1: REGISTRATION ACCEPT for NR Cell 1 (preamble)

Derivation path: TS 38.508-1[4] Table 4.7.1-7			
Information Element	Value/Remark	Comment	Condition
Equivalent PLMNs	PLMN3		

Table 6.1.2.8.3.3-2: REGISTRATION ACCEPT for NR Cell 4 (steps 3 & 7, Table 6.1.2.8.3.2-3)

Derivation path: TS 38.508-1[4] Table 4.7.1-7			
Information Element	Value/Remark	Comment	Condition
Equivalent PLMNs	PLMN1, 2		

Table 6.1.2.8.3.3-3: REGISTRATION ACCEPT for NR Cell 2 (step 5, Table 6.1.2.8.3.2-3)

Derivation path: TS 38.508-1[4] Table 4.7.1-7			
Information Element	Value/Remark	Comment	Condition
Equivalent PLMNs	PLMN1, 3		

6.1.2.9 Cell reselection using Qhyst, Qoffset and Treselection

6.1.2.9.1 Test Purpose (TP)

(1)

```
with { UE in NR RRC_IDLE state, and the UE is not in high mobility state }
ensure that {
  when { Qhyst is non-zero or its value changes in system information }
  then { UE reselects the highest ranked cell taking the actual Qhyst value into account }
}
```

(2)

```
with { UE in NR RRC_IDLE state, and the UE is not in high mobility }
ensure that {
  when { cell reselection criteria are fulfilled during a time interval Treselection }
  then { UE reselects the highest ranked cell after the Treselection interval expires }
}
```

(3)

```
with { UE in NR RRC_IDLE state, and the UE is not in high mobility }
ensure that {
  when { Qoffset is non-zero or its value changes in system information }
  then { UE reselects the highest ranked cell taking the actual Qoffset value into account }
}
```

6.1.2.9.2 Conformance requirements

References: The conformance requirements covered in the present TC are specified in TS 38.304: clause 5.2.4.6. Unless otherwise stated these are Rel-15 requirements.

[TS 38.304, clause 5.2.4.6]

The cell-ranking criterion R_s for serving cell and R_n for neighbouring cells is defined by:

$$R_s = Q_{\text{meas},s} + Q_{\text{hyst}} - Q_{\text{offsettemp}}$$

$$R_n = Q_{\text{meas},n} - Q_{\text{offset}} - Q_{\text{offsettemp}}$$

where:

Q_{meas}	RSRP measurement quantity used in cell reselections.
Q_{offset}	For intra-frequency: Equals to $Q_{\text{offsets},n}$, if $Q_{\text{offsets},n}$ is valid, otherwise this equals to zero. For inter-frequency: Equals to $Q_{\text{offsets},n}$ plus $Q_{\text{offsetfrequency}}$, if $Q_{\text{offsets},n}$ is valid, otherwise this equals to $Q_{\text{offsetfrequency}}$.
$Q_{\text{offsettemp}}$	Offset temporarily applied to a cell as specified in TS 38.331 [3].

The UE shall perform ranking of all cells that fulfil the cell selection criterion S , which is defined in 5.2.3.2.

The cells shall be ranked according to the R criteria specified above by deriving $Q_{\text{meas},n}$ and $Q_{\text{meas},s}$ and calculating the R values using averaged RSRP results.

If *rangeToBestCell* is not configured, the UE shall perform cell reselection to the highest ranked cell. If this cell is found to be not-suitable, the UE shall behave according to subclause 5.2.4.4.

If *rangeToBestCell* is configured, then the UE shall perform cell reselection to the cell with the highest number of beams above the threshold (i.e. *absThreshSS-BlocksConsolidation*) among the cells whose R value is within *rangeToBestCell* of the R value of the highest ranked cell. If there are multiple such cells, the UE shall perform cell reselection to the highest ranked cell among them. If this cell is found to be not-suitable, the UE shall behave according to subclause 5.2.4.4.

In all cases, the UE shall reselect the new cell, only if the following conditions are met:

- the new cell is better than the serving cell according to the cell reselection criteria specified above during a time interval $T_{reselection_{RAT}}$;
- more than 1 second has elapsed since the UE camped on the current serving cell.

6.1.2.9.3 Test description

6.1.2.9.3.1 Pre-test conditions

System Simulator:

- NR Cell 1, NR Cell 2 and NR Cell 11.
- System information combination NR-3 as defined in TS 38.508-1 [4] Table 4.4.3.1.2-1 is used in NR cells.

UE:

None.

Preamble:

- The UE is in state 1N-A on NR Cell 1(serving cell) according to TS 38.508-1 [4] Table 4.4A.2-1.

6.1.2.9.3.2 Test procedure sequence

Table 6.1.2.9.3.2-1/2 illustrates the downlink power levels and other changing parameters to be applied for the NR cells at various time instants of the test execution. The exact instants on which these values shall be applied are described in the texts in this clause. The configuration "T0" indicates the initial conditions. Subsequent configurations marked "T1", "T2" and so on are applied at the points indicated in the Main behaviour description in Table 6.1.2.9.3.2-3.

Table 6.1.2.9.3.2-1: Time instances of cell power level and parameter changes For FR1

	Parameter	Unit	NR Cell 1	NR Cell 2	NR Cell 11	Remark
T0	SS/PBCH SSS EPRE	dBm/SCS	-88	Off	Off	The power level values are assigned to ensure the UE registered on NR Cell 1.
	Qhysts	dB	24	0	0	
	Qoffsets,n	dB	0	0	0	
	Treselectio nNR	S	0	0	0	
T1	SS/PBCH SSS EPRE	dBm/SCS	-94	-88	Off	NR Cell 2 becomes stronger than NR Cell 1 but NR Cell 1 remains the highest ranked one due to Qhysts NR Cell 1
	Qhysts	dB	24	0	0	
	Qoffsets,n	dB	0	0	0	
	Treselectio nNR	S	0	0	0	
T2	SS/PBCH SSS EPRE	dBm/SCS	-94	-88	Off	Qhysts NR Cell 1 change causes NR Cell 2 to become highest ranked cell
	Qhysts	dB	0	0	0	
	Qoffsets,n	dB	0	0	0	
	Treselectio nNR	S	0	0	0	
T3	SS/PBCH SSS EPRE	dBm/SCS	-88	-94	Off	NR Cell 1 becomes the strongest and highest ranked one due to power adjustment
	Qhysts	dB	0	0	0	
	Qoffsets,n	dB	0	0	0	
	Treselectio nNR	S	0	0	0	
T4	SS/PBCH SSS EPRE	dBm/SCS	-88	-94	Off	Qoffsets,n NR Cell1 change to 24dB, Qoffsets,n NR Cell 2 remains zero
	Qhysts	dB	0	0	0	
	Qoffsets,n	dB	24	0	0	
	Treselectio nNR	S	0	0	0	
T5	SS/PBCH SSS EPRE	dBm/SCS	-94	-88	Off	NR Cell 1 becomes weaker but it remains the highest ranked one due to Qoffsets,n NR Cell 1
	Qhysts	dB	0	0	0	
	Qoffsets,n	dB	24	0	0	
	Treselectio nNR	S	0	0	0	
T6	SS/PBCH SSS EPRE	dBm/SCS	-94	-88	Off	NR Cell 2 becomes the highest ranked one due to Qoffsets,n NR Cell 1 change
	Qhysts	dB	0	0	0	
	Qoffsets,n	dB	0	0	0	
	Treselectio nNR	S	0	0	0	
T7	SS/PBCH SSS EPRE	dBm/SCS	-88	-94	Off	NR Cell 1 becomes the highest ranked one
	Qhysts	dB	0	0	0	
	Qoffsets,n	dB	0	0	0	
	Treselectio nNR	S	0	0	0	
T8	SS/PBCH SSS EPRE	dBm/SCS	-88	Off	-94	TreselectionNR of NR Cell 1 change to 7S
	Qhysts	dB	0	0	0	
	Qoffsets,n	dB	0	0	0	
	Treselectio nNR	S	7	0	0	
T9	SS/PBCH SSS EPRE	dBm/SCS	-94	Off	-88	NR Cell 2 becomes the highest ranked one
	Qhysts	dB	0	0	0	
	Qoffsets,n	dB	0	0	0	
	Treselectio nNR	S	7	0	0	

Note: Power level "Off" is defined in TS38.508-1 [4] Table 6.2.2.1-3.

Table 6.1.2.9.3.2-2: Time instances of cell power level and parameter changes For FR2

	Parameter	Unit	NR Cell 1	NR Cell 2	NR Cell 11	Remark
T0	SS/PBCH SSS EPRE	dBm/SCS	-82	Off	Off	The power level values are assigned to ensure the UE registered on NR Cell 1.
	Qhyst _s	dB	24	0	0	
	Qoffset _{s,n}	dB	0	0	0	
	TreselectionNR	S	0	0	0	
T1	SS/PBCH SSS EPRE	dBm/SCS	-91	-82	Off	NR Cell 2 becomes stronger than NR Cell 1 but NR Cell 1 remains the highest ranked one due to Qhyst _s NR Cell 1
	Qhyst _s	dB	24	0	0	
	Qoffset _{s,n}	dB	0	0	0	
	TreselectionNR	S	0	0	0	
T2	SS/PBCH SSS EPRE	dBm/SCS	-91	-82	Off	Qhyst _s NR Cell 1 change causes NR Cell 2 to become highest ranked cell
	Qhyst _s	dB	0	0	0	
	Qoffset _{s,n}	dB	0	0	0	
	TreselectionNR	S	0	0	0	
T3	SS/PBCH SSS EPRE	dBm/SCS	-82	-91	Off	NR Cell 1 becomes the strongest and highest ranked one due to power adjustment
	Qhyst _s	dB	0	0	0	
	Qoffset _{s,n}	dB	0	0	0	
	TreselectionNR	S	0	0	0	
T4	SS/PBCH SSS EPRE	dBm/SCS	-82	-91	Off	Qoffset _{s,n} NR Cell1 change to 24dB, Qoffset _{s,n} NR Cell 2 remains zero
	Qhyst _s	dB	0	0	0	
	Qoffset _{s,n}	dB	24	0	0	
	TreselectionNR	S	0	0	0	
T5	SS/PBCH SSS EPRE	dBm/SCS	-91	-82	Off	NR Cell 1 becomes weaker but it remains the highest ranked one due to Qoffset _{s,n} NR Cell 1
	Qhyst _s	dB	0	0	0	
	Qoffset _{s,n}	dB	24	0	0	
	TreselectionNR	S	0	0	0	
T6	SS/PBCH SSS EPRE	dBm/SCS	-91	-82	Off	NR Cell 2 becomes the highest ranked one due to Qoffset _{s,n} NR Cell 1 change
	Qhyst _s	dB	0	0	0	
	Qoffset _{s,n}	dB	0	0	0	
	TreselectionNR	S	0	0	0	
T7	SS/PBCH SSS EPRE	dBm/SCS	-82	-91	Off	NR Cell 1 becomes the highest ranked one
	Qhyst _s	dB	0	0	0	
	Qoffset _{s,n}	dB	0	0	0	
	TreselectionNR	S	0	0	0	
T8	SS/PBCH SSS EPRE	dBm/SCS	-82	Off	-94	TreselectionNR of NR Cell 1 change to 7S
	Qhyst _s	dB	0	0	0	
	Qoffset _{s,n}	dB	0	0	0	
	TreselectionNR	S	7	0	0	
T9	SS/PBCH SSS EPRE	dBm/SCS	-91	Off	-88	NR Cell 2 becomes the highest ranked one
	Qhyst _s	dB	0	0	0	
	Qoffset _{s,n}	dB	0	0	0	
	TreselectionNR	S	7	0	0	

Table 6.1.2.9.3.2-3: Main behaviour

St	Procedure	Message Sequence		TP	Verdict
		U - S	Message		
1	SS re-adjusts the SSS levels according to row "T1" in table 6.1.2.9.3.2-1/2.	-	-	-	-
1A	Wait for 34[FR1]/130[FR2] seconds, the SS transmits a Paging message on NR Cell 2.	<-	NR RRC: <i>Paging</i>	-	-
2	Check: Does the UE send an NR: <i>RRCSetupRequest</i> on NR Cell 2 within the next 10 seconds?	-->	NR RRC: <i>RRCSetupRequest</i>	1	F
3	SS notifies UE of the system information change on NR Cell 1 by send Short Message on PDCCH using P-RNTI.	<-	NR RRC: <i>Paging</i>	-	-
4	SS resets $Q_{\text{hyst}}^{\text{NR Cell 1}}$ according to row "T2" in table 6.1.2.9.3.2-1/2, The <i>ValueTag</i> of <i>SIB2</i> in the SI-SchedulingInfo of <i>SIB1</i> is increased on NR Cell 1.	-	-	-	-
5	Wait for 2.1* modification period to allow the new system information to take effect.	-	-	-	-
6	Check: Does the test result of generic test procedure in TS 38.508-1 [4] Table 4.9.4-1 indicate that the UE is camped on NR Cell 2?	-	-	1	P
7	SS re-adjusts SSS levels according to rows "T3" in table 6.1.2.9.3.2-1/2.	-	-	-	-
8	Wait for 8[FR1]/27[FR2] seconds to allow UE to recognise the change.	-	-	-	-
9	The test result of generic test procedure in TS 38.508-1 [4] Table 4.9.4-1 indicate that the UE is camped on NR Cell 1.	-	-	-	-
10	SS notifies UE of the system information change on NR Cell 1 by send Short Message on PDCCH using P-RNTI.	<-	NR RRC: <i>Paging</i>	-	-
11	SS changes $Q_{\text{offset}}^{\text{NR Cell 1}}$ according to rows "T4" in table 6.1.2.9.3.2-1/2. The <i>ValueTag</i> of <i>SIB3</i> in the SI-SchedulingInfo of <i>SIB1</i> is increased on NR Cell 1.	-	-	-	-
12	Wait for 2.1* modification period to allow the new system information to take effect.	-	-	-	-
13	SS re-adjusts SSS levels according to row "T5" in table 6.1.2.9.3.2-1/2.	-	-	-	-
14	Wait for 8[FR1]/27[FR2] seconds to allow UE to recognise the change.	-	-	-	-
15	Check: Does the test result of generic test procedure in TS 38.508-1 [4] Table 4.9.4-1 indicate that the UE is still camped on NR Cell 1?	-	-	3	P
16	SS notifies UE of the system information change on NR Cell 1 by send Short Message on PDCCH using P-RNTI.	<-	NR RRC: <i>Paging</i>	-	-
17	SS resets $Q_{\text{offset}}^{\text{NR Cell 1}}$ according to row "T6" in table 6.1.2.9.3.2-1/2, The <i>ValueTag</i> of <i>SIB3</i> in the SI-SchedulingInfo of <i>SIB1</i> is increased on NR Cell 1.	-	-	-	-
18	Wait for 2.1* modification period to allow the new system information to take effect.	-	-	-	-
19	Check: Does the test result of generic test procedure in TS 38.508-1 [4] Table 4.9.4-1 indicate that the UE is camped on NR Cell 2?	-	-	3	P
20	SS re-adjusts SSS levels according to rows "T7" in table 6.1.2.9.3.2-1/2.	-	-	-	-
21	Wait for 8[FR1]/27[FR2] seconds to allow UE to recognise the change.	-	-	-	-
22	Check: Does the test result of generic test procedure in TS 38.508-1 [4] Table 4.9.4-1 indicate that the UE is camped on NR Cell 1?	-	-	3	P
23	SS sends notification of the system information change on NR Cell 1 by send Short Message on PDCCH using P-RNTI.	<-	NR RRC: <i>Paging</i>	-	-

24	SS changes Treselection _{NR Cell 1} according to rows "T8" in table 6.1.2.9.3.2-1/2, The ValueTag of SIB2 in the SI-SchedulingInfo of SIB1 is increased on NR Cell 1.	-	-	-	-
25	SS re-adjusts cell power levels according to rows "T8" in table 6.1.2.9.3.2-1/2.	-	-	-	-
26	Wait for 34[FR1]/130[FR2] seconds to allow UE to detect Cell 11.	-	-	-	-
27	SS re-adjusts SSS levels according to rows "T9" in table 6.1.2.9.3.2-1/2.	-	-	-	-
28	Check: Does the UE send an NR: RRCSetupRequest on NR Cell 11 within Timer=TreselectionNR from step 27?	-->	NR RRC: RRCSetupRequest	2	F
29	SS waits for Timer=TreselectionNR Cell 1 expires after step 27				
30	Check: Does the UE send an NR: RRCSetupRequest on NR Cell 11?	-->	NR RRC: RRCSetupRequest	2	P
31-34	Steps 2 to 5 of the generic test procedure in TS 38.508-1 [4] Table 4.9.5.2.2-1 are performed on NR Cell 11.	-	-	-	-
Note: The wait time at steps 2 and 26 is T _{detect, NR_Intra} and at Steps 8,14 and 21 it is T _{evaluate, NR_Intra} (as per TS 38.133 [30], clause 4.2.2.3) plus the time to read the system information T _{SI-NR} .					

6.1.2.9.3.3 Specific message contents

Table 6.1.2.9.3.3-1: SIB1 of NR Cell 1 (preamble and all steps, Table 6.1.2.9.3.2-3)

Derivation Path: TS 38.508-1 [4], Table 4.6.1-28			
Information Element	Value/remark	Comment	Condition
SIB1 ::= SEQUENCE {			
si-SchedulingInfo	SI-SchedulingInfo		
}			

Table 6.1.2.9.3.3-2: SI-SchedulingInfo (si-SchedulingInfo in Table 6.1.2.9.3.3-1)

Derivation Path: TS 38.508-1 [4], Table 4.6.3-173			
Information Element	Value/remark	Comment	Condition
SI-SchedulingInfo ::= SEQUENCE {			
schedulingInfoList SEQUENCE (SIZE(1..maxSI-Message)) OF SchedulingInfo {	1 entry		
SchedulingInfo[1] SEQUENCE {		entry 1	
sib-MappingInfo SEQUENCE (SIZE (1..maxSIB)) OF SIB-TypeInfo {	2 entries		
SIB-TypeInfo[1] SEQUENCE {		entry 1	
Type[1]	sibType2		
valueTag[1]	0	The value is increased by 1 in step 4 and step 24	
}			
SIB-TypeInfo[2] SEQUENCE {		entry 2	
Type[2]	sibType3		
valueTag[2]	0	The value is increased by 1 in step 11 and step 17	
}			
}			
}			
}			

Table 6.1.2.9.3.3-3: SIB2 of NR Cell 1 (preamble, Table 6.1.2.9.3.2-3)

Derivation Path: TS 38.508-1 [4], Table 4.6.2-1			
Information Element	Value/remark	Comment	Condition
SIB2 ::= SEQUENCE {			
cellReselectionInfoCommon SEQUENCE			
{			
q-Hyst	dB24		
}			
}			

Table 6.1.2.9.3.3-4: SIB2 of NR Cell 1 (step 4, Table 6.1.2.9.3.2-3)

Derivation Path: TS 38.508-1 [4], Table 4.6.2-1			
Information Element	Value/remark	Comment	Condition
SIB2 ::= SEQUENCE {			
cellReselectionInfoCommon SEQUENCE			
{			
q-Hyst	dB0		
}			
}			

Table 6.1.2.9.3.3-5: SIB3 of NR Cell 1 (step 11, Table 6.1.2.9.3.2-3)

Derivation Path: TS 38.508-1 [4], Table 4.6.2-2			
Information Element	Value/remark	Comment	Condition
SIB3 ::= SEQUENCE {			
intraFreqNeighCellList SEQUENCE (SIZE (1..	1 entry		
maxCellIntra)) OF IntraFreqNeighCellInfo {			
IntraFreqNeighCellInfo[1] SEQUENCE{		entry 1	
q-OffsetCell	dB24		
}			
}			

Table 6.1.2.9.3.3-6: SIB3 of NR Cell 1 (step 17, Table 6.1.2.9.3.2-3)

Derivation Path: TS 38.508-1 [4], Table 4.6.2-2			
Information Element	Value/remark	Comment	Condition
SIB3 ::= SEQUENCE {			
intraFreqNeighCellList SEQUENCE (SIZE (1..	1 entry		
maxCellIntra)) OF IntraFreqNeighCellInfo {			
IntraFreqNeighCellInfo[1] SEQUENCE {		entry 1	
q-OffsetCell	dB0		
}			
}			

Table 6.1.2.9.3.3-7: SIB2 of NR Cell 1 (step 24, Table 6.1.2.9.3.2-3)

Derivation Path: TS 38.508-1 [4], Table 4.6.2-1			
Information Element	Value/remark	Comment	Condition
SIB2 ::= SEQUENCE {			
intraFreqCellReselectionInfo SEQUENCE			
{			
t-ReselectionNR	7	seconds	
}			
}			

6.1.2.10

6.1.2.11 Area Specific SIBs using systemInformationAreaID

6.1.2.11.1 Test Purpose (TP)

(1)

```
with { UE is in NR RRC_IDLE state }
ensure that {
  when { SIB1 does not include si-RequestConfig and si-BroadcastStatus set to notBroadcasting }
  then { UE sends RRCSystemInfoRequest message and acquires the necessary SIBs }
}
```

(2)

```
with { UE in NR_RRC Idle State }
ensure that {
  when { UE reselects to neighbor cell with same systemInformationAreaID and SIB1 does not include
si-RequestConfig and si-BroadcastStatus set to notBroadcasting }
  then { UE applies system information parameters of previous cell for reselection purposes }
}
```

6.1.2.11.2 Conformance requirements

References: The conformance requirements covered in the present TC are specified in: 3GPP TS 38.304, clause 5.2.4.4, 5.2.4.6 and 5.3.1. Unless otherwise stated these are Rel-15 requirements.

[TS 38.304, clause 5.2.4.2]

Following rules are used by the UE to limit needed measurements:

- If the serving cell fulfils $S_{rxlev} > S_{IntraSearchP}$ and $S_{qual} > S_{IntraSearchQ}$, the UE may choose not to perform intra-frequency measurements.
- Otherwise, the UE shall perform intra-frequency measurements.
- The UE shall apply the following rules for NR inter-frequencies and inter-RAT frequencies which are indicated in system information and for which the UE has priority provided as defined in 5.2.4.1:
 - For a NR inter-frequency or inter-RAT frequency with a reselection priority higher than the reselection priority of the current NR frequency, the UE shall perform measurements of higher priority NR inter-frequency or inter-RAT frequencies according to TS 38.133 [8].
 - For a NR inter-frequency with an equal or lower reselection priority than the reselection priority of the current NR frequency and for inter-RAT frequency with lower reselection priority than the reselection priority of the current NR frequency:
 - If the serving cell fulfils $S_{rxlev} > S_{nonIntraSearchP}$ and $S_{qual} > S_{nonIntraSearchQ}$, the UE may choose not to perform measurements of NR inter-frequencies or inter-RAT frequency cells of equal or lower priority;
- Otherwise, the UE shall perform measurements of NR inter-frequencies or inter-RAT frequency cells of equal or lower priority according to TS 38.133 [8].

[TS 38.304, clause 5.2.4.6]

If *threshServingLowQ* is broadcast in system information and more than 1 second has elapsed since the UE camped on the current serving cell, cell reselection to a cell on a higher priority NR frequency or inter-RAT frequency than the serving frequency shall be performed if:

- A cell of a higher priority NR or EUTRAN RAT/frequency fulfils $S_{qual} > Thresh_{X, HighQ}$ during a time interval $T_{reselection_{RAT}}$

Otherwise, cell reselection to a cell on a higher priority NR frequency or inter-RAT frequency than the serving frequency shall be performed if:

- A cell of a higher priority RAT/ frequency fulfils $Srxlev > Thresh_{X, HighP}$ during a time interval $Treselection_{RAT}$; and
- More than 1 second has elapsed since the UE camped on the current serving cell.

Cell reselection to a cell on an equal priority NR frequency shall be based on ranking for intra-frequency cell reselection as defined in clause 5.2.4.6.

If $thresh_{ServingLowQ}$ is broadcast in system information and more than 1 second has elapsed since the UE camped on the current serving cell, cell reselection to a cell on a lower priority NR frequency or inter-RAT frequency than the serving frequency shall be performed if:

- The serving cell fulfils $Squal < Thresh_{Serving, LowQ}$ and a cell of a lower priority NR or E-UTRAN RAT/ frequency fulfils $Squal > Thresh_{X, LowQ}$ during a time interval $Treselection_{RAT}$.

Otherwise, cell reselection to a cell on a lower priority NR frequency or inter-RAT frequency than the serving frequency shall be performed if:

- The serving cell fulfils $Srxlev < Thresh_{Serving, LowP}$ and a cell of a lower priority RAT/ frequency fulfils $Srxlev > Thresh_{X, LowP}$ during a time interval $Treselection_{RAT}$; and
- More than 1 second has elapsed since the UE camped on the current serving cell.

Cell reselection to a higher priority RAT/frequency shall take precedence over a lower priority RAT/frequency if multiple cells of different priorities fulfil the cell reselection criteria.

If more than one cell meets the above criteria, the UE shall reselect a cell as follows:

- If the highest-priority frequency is an NR frequency, the highest ranked cell among the cells on the highest priority frequency(ies) meeting the criteria according to clause 5.2.4.6;
- If the highest-priority frequency is from another RAT, the strongest cell among the cells on the highest priority frequency(ies) meeting the criteria of that RAT.

[TS 38.331, clause 5.2.2.2.1]

The UE shall apply the SI acquisition procedure as defined in clause 5.2.2.3 upon cell selection (e.g. upon power on), cell-reselection, return from out of coverage, after reconfiguration with sync completion, after entering the network from another RAT, upon receiving an indication that the system information has changed, upon receiving a PWS notification; and whenever the UE does not have a valid version of a stored SIB.

When the UE acquires a *MIB* or a *SIB1* or an SI message in a serving cell as described in clause 5.2.2.3, and if the UE stores the acquired SIB, then the UE shall store the associated *areaScope*, if present, the first *PLMN-Identity* in the *PLMN-IdentityInfoList*, the *cellIdentity*, the *systemInformationAreaID*, if present, and the *valueTag*, if present, as indicated in the *si-SchedulingInfo* for the SIB. The UE may use a valid stored version of the SI except *MIB*, *SIB1*, *SIB6*, *SIB7* or *SIB8* e.g. after cell re-selection, upon return from out of coverage or after the reception of SI change indication.

NOTE: The storage and management of the stored SIBs in addition to the SIBs valid for the current serving cell is left to UE implementation.

The UE shall:

- 1> delete any stored version of a SIB after 3 hours from the moment it was successfully confirmed as valid;
- 1> for each stored version of a SIB:
 - 2> if the *areaScope* is associated and its value for the stored version of the SIB is the same as the value received in the *si-SchedulingInfo* for that SIB from the serving cell:
 - 3> if the first *PLMN-Identity* included in the *PLMN-IdentityInfoList*, the *systemInformationAreaID* and the *valueTag* that are included in the *si-SchedulingInfo* for the SIB received from the serving cell are identical to the *PLMN-Identity*, the *systemInformationAreaID* and the *valueTag* associated with the stored version of that SIB:
 - 4> consider the stored SIB as valid for the cell;

...

[TS 38.331, clause 5.2.2.3.3]

The UE shall:

...

1> else:

- 2> apply the *timeAlignmentTimerCommon* included in *SIB1*;
- 2> apply the CCCH configuration as specified in 9.1.1.2;
- 2> initiate transmission of the *RRCSystemInfoRequest* message in accordance with 5.2.2.3.4;
- 2> if acknowledgement for *RRCSystemInfoRequest* message is received from lower layers:
 - 3> acquire the requested SI message(s) as defined in subclause 5.2.2.3.2, immediately;

....

[TS 38.331, clause 5.2.2.3.4]

The UE shall set the contents of *RRCSystemInfoRequest* message as follows:

- 1> set the *requested-SI-List* to indicate the SI message(s) that the UE requires to operate within the cell, and for which *si-BroadcastStatus* is set to *notBroadcasting*.

The UE shall submit the *RRCSystemInfoRequest* message to lower layers for transmission.

6.1.2.11.3 Test description

6.1.2.11.3.1 Pre-test conditions

System Simulator:

- NR Cell 1, NR Cell 3 and NR Cell 6.
- System information combination NR-2 as defined in TS 38.508-1 [4] clause 4.4.3.1.2 is used in NR Cells.

UE:

None.

Preamble:

- The UE is in NR RRC Idle mode (state 1N-A) on NR Cell 1 according to 38.508-1 [4] Table 4.4A.2-1.

6.1.2.11.3.2 Test procedure sequence

Table 6.1.2.11.3.2-1/2 illustrate the downlink power levels and other changing parameters to be applied for the cell at various time instants of the test execution. The exact instants on which these values shall be applied are described in the texts in this clause. The configuration T0 indicates the initial conditions for preamble. Configurations marked "T1" and "T2" is applied at the points indicated in the Main behaviour description in Table 6.1.2.11.3.2-3.

Table 6.1.2.11.3.2-1: Time instances of cell power level and parameter changes for FR1

	Parameter	Unit	NR Cell 1	NR Cell 3	NR Cell 6	Remark
T0	SS/PBCH SSS EPRE	dBm/SCS	-88	Off	Off	
T1	SS/PBCH SSS EPRE	dBm/SCS	-95	-80	Off	The power level values are assigned to satisfy $Srxlev_{NRCell3} > Thresh_{X, HighP}$
T2	SS/PBCH SSS EPRE	dBm/SCS	Off	-88	-80	The power level values are assigned to satisfy $R_{NRCell3} < R_{NRCell6}$

Table 6.1.2.11.3.2-2: Time instances of cell power level and parameter changes for FR2

	Parameter	Unit	NR Cell 1	NR Cell 3	NR Cell 6	Remark
T0	SS/PBCH SSS EPRE	dBm/SCS	FFS	Off	Off	
T1	SS/PBCH SSS EPRE	dBm/SCS	FFS	FFS	Off	The power level values are assigned to satisfy $Srxlev_{NRCell3} > Thresh_{X, HighP}$
T2	SS/PBCH SSS EPRE	dBm/SCS	Off	FFS	FFS	The power level values are assigned to satisfy $R_{NRCell3} < R_{NRCell6}$

Table 6.1.2.11.3.2-3: Main behaviour

St	Procedure	Message Sequence		TP	Verdict
		U - S	Message		
0	The SS changes SIB1 as specified as Table 6.1.2.11.3.3-1. Note: The sysinfo combination of NR cell 1 is changed to NR-4.	-	-	-	-
0A	The SS notifies the UE of change of System Information on NR Cell 1 by send Short Message on PDCCH using P-RNTI.	<-	NR PDCCH (DCI 1_0): Short Message	-	-
1	Void	-	-	-	-
2	UE sends <i>RRCSystemInfoRequest</i> message to NR Cell 1 to request SIB4.	-->	NR RRC: <i>RRCSystemInfoRequest</i>	1	P
3	NR Cell 1 starts broadcasting <i>SystemInformation</i> message which including SIB4.	<-	NR RRC: <i>SystemInformation</i>	-	-
3A	The SS re-adjusts the SS/PBCH EPRE levels and according to row "T1" in table 6.1.2.11.3.2-1/2.	-	-	-	-
4	Wait 34s to let UE to perform inter-frequency cell reselection to NR Cell 3 (Note 1).	-	-	-	-
4A	Does the UE send <i>RRCSystemInfoRequest</i> message on NR Cell 3 to request SIB4 in the next 5s?			2	F
4B	The test result of generic test procedure in TS 38.508-1 [4] Table 4.9.4.2.2-1 indicate that the UE is camped on NR Cell 3.	-	-	-	-
5	The SS re-adjusts the SS/PBCH EPRE levels and according to row "T2" in table 6.1.2.11.3.2-1/2.	-	-	-	-
6	Void				
6A	Wait 34s to let UE to perform inter-frequency cell reselection to NR Cell 6.(Note 1)	-	-	-	-
7	Check: Does the test result of generic test procedure in TS 38.508-1 [4] Table 4.9.4.2.2-1 indicate that the UE is camped on NR Cell 6?	-	-	2	P
Note 1: The wait time for cell reselection procedure is selected to cover $T_{\text{detect, NR_inter}} (32\text{s}) + T_{\text{SI-NR}} (1280 \text{ ms}) = 33.28\text{s}$ rounded up to 34s.					

6.1.2.11.3.3 Specific message contents

Table 6.1.2.11.3.3-1: SIB1 of NR cell 1 and NR cell 3 (All steps in Table 6.1.2.11.3.2-3)

Derivation Path: TS 38.508-1 [4], Table 4.6.1-28 with Condition SIG AND FR1			
Information Element	Value/remark	Comment	Condition
SIB1 ::= SEQUENCE {			
cellSelectionInfo SEQUENCE {			
si-SchedulingInfo	SI-SchedulingInfo-Area	Table 6.1.2.11.3.3-2	
}			

Table 6.1.2.11.3.3-2: SI-SchedulingInfo-Area (Table 6.1.2.11.3.3-1)

Derivation Path: TS 38.508-1 [4], Table 4.6.3-173 with Condition FR1			
Information Element	Value/remark	Comment	Condition
SI-SchedulingInfo ::= SEQUENCE {			
schedulingInfoList SEQUENCE (SIZE (1..maxSI-Message)) OF SchedulingInfo {	2 entries		
SchedulingInfo[1] SEQUENCE {		entry 1	
si-BroadcastStatus	broadcasting		
si-Periodicity	rf32		
sib-MappingInfo SEQUENCE (SIZE (1..maxSIB)) OF SIB-TypeInfo {	1 entry		
SIB-TypeInfo[1] SEQUENCE {		entry 1	
type	sibType2		
}			
}			
}			
SchedulingInfo[2] SEQUENCE {		entry 2	
si-BroadcastStatus	not broadcasting		
si-Periodicity	rf64		
sib-MappingInfo SEQUENCE (SIZE (1..maxSIB)) OF SIB-TypeInfo {	1 entry		
SIB-TypeInfo[1] SEQUENCE {		entry 1	
type	sibType4		
valueTag	0		
areaScope	true		
}			
}			
}			
systemInformationAreaID	'0000 0000 0000 0000 0000 0011'B		
}			

Table 6.1.2.11.3.3-3: RRCSystemInfoRequest (Step 2, Table 6.1.2.11.3.2-3)

Derivation Path: TS 38.508-1 [4], Table 4.6.1-24			
Information Element	Value/remark	Comment	Condition
RRCSystemInfoRequest ::= SEQUENCE {			
criticalExtensions CHOICE {			
rrcSystemInfoRequest-r15 SEQUENCE {			
requested-SI-List	010000000000000000000000 000000000000	Bit corresponds to SIB4 in <i>schedulingInfoList</i>	
}			
}			
}			

Table 6.1.2.11.3.3-4: *SystemInformation* (Step 3, Table 6.1.2.11.3.2-3)

Derivation Path: TS 38.508-1 [4], Table 4.6.1-29			
Information Element	Value/remark	Comment	Condition
SystemInformation ::= SEQUENCE {			
criticalExtensions CHOICE {			
systemInformation-r15 SEQUENCE {			
sib-TypeAndInfo SEQUENCE (SIZE (1..maxSIB))	1 entry		
OF CHOICE {			
SIB4 SEQUENCE {	As per TS 38.508-1 [4]		
interFreqCarrierFreqList SEQUENCE (SIZE (1..maxFreq))	2 entries		
OF InterFreqCarrierFreqInfo {			
InterFreqCarrierFreqInfo[1] SEQUENCE {		entry 1	
dl-CarrierFreq	Same downlink NR ARFCN as used for NR Cell 3		
smtc	SSB-MTC as defined in TS 38.508-1 [4] Table 4.6.3-185 with condition INTER-FREQ_ODD		
}			
InterFreqCarrierFreqInfo[2] SEQUENCE {		entry 2	
dl-CarrierFreq	Same downlink NR ARFCN as used for NR Cell 6		
smtc	SSB-MTC as defined in TS 38.508-1 [4] Table 4.6.3-185 with condition INTER-FREQ_ODD	smtc of the inter-freq carrier for NR Cell 6 is calculated with respect to NR Cell 3	
}			
}			
}			
}			
}			

6.1.2.12 Cell reselection using cell status and cell reservations / cellReservedForOtherUse

6.1.2.12.1 Test Purpose (TP)

(1)

```
with { UE camped normally in state NR RRC_IDLE }
ensure that {
  when { A higher ranked cell is found with cell status "true" for other use }
  then { UE does not attempt to reselect to the higher ranked cell }
}
```

6.1.2.12.2 Conformance requirements

References: The conformance requirements covered in the present TC are specified in: 3GPP TS 38.304, clause 5.2.4.4, 5.2.4.6 and 5.3.1. Unless otherwise stated these are Rel-15 requirements.

[TS 38.304, clause 5.2.4.4]

For the highest ranked cell (including serving cell) according to cell reselection criteria specified in subclause 5.2.4.6, for the best cell according to absolute priority reselection criteria specified in subclause 5.2.4.5, the UE shall check if the access is restricted according to the rules in subclause 5.3.1.

If that cell and other cells have to be excluded from the candidate list, as stated in subclause 5.3.1, the UE shall not consider these as candidates for cell reselection. This limitation shall be removed when the highest ranked cell changes.

If the highest ranked cell or best cell according to absolute priority reselection rules is an intra-frequency or inter-frequency cell which is not suitable due to being part of the "list of 5GS forbidden TAs for roaming" or belonging to a PLMN which is not indicated as being equivalent to the registered PLMN, the UE shall not consider this cell and other cells on the same frequency, as candidates for reselection for a maximum of 300 seconds. If the UE enters into state *any cell selection*, any limitation shall be removed. If the UE is redirected under NR control to a frequency for which the timer is running, any limitation on that frequency shall be removed.

If the highest ranked cell or best cell according to absolute priority reselection rules is an inter-RAT cell which is not suitable due to being part of the "list of forbidden TAs for roaming" or belonging to a PLMN which is not indicated as being equivalent to the registered PLMN, the UE shall not consider this cell and other cells on the same frequency, as candidates for reselection for a maximum of 300 seconds. If the UE enters into state *any cell selection*, any limitation shall be removed. If the UE is redirected under NR control to a frequency for which the timer is running, any limitation on that frequency shall be removed.

[TS 38.304, clause 5.2.4.6]

The cell-ranking criterion R_s for serving cell and R_n for neighbouring cells is defined by:

$$R_s = Q_{\text{meas},s} + Q_{\text{hyst}} - Q_{\text{offset,temp}}$$

$$R_n = Q_{\text{meas},n} - Q_{\text{offset}} - Q_{\text{offset,temp}}$$

where:

Q_{meas}	RSRP measurement quantity used in cell reselections.
Q_{offset}	For intra-frequency: Equals to $Q_{\text{offset},s,n}$, if $Q_{\text{offset},s,n}$ is valid, otherwise this equals to zero. For inter-frequency: Equals to $Q_{\text{offset},s,n}$ plus $Q_{\text{offset,frequency}}$, if $Q_{\text{offset},s,n}$ is valid, otherwise this equals to $Q_{\text{offset,frequency}}$.
$Q_{\text{offset,temp}}$	Offset temporarily applied to a cell as specified in TS 38.331 [3].

The UE shall perform ranking of all cells that fulfil the cell selection criterion S , which is defined in 5.2.3.2.

The cells shall be ranked according to the R criteria specified above by deriving $Q_{\text{meas},n}$ and $Q_{\text{meas},s}$ and calculating the R values using averaged RSRP results.

If *rangeToBestCell* is not configured, the UE shall perform cell reselection to the highest ranked cell. If this cell is found to be not-suitable, the UE shall behave according to subclause 5.2.4.4.

If *rangeToBestCell* is configured, then the UE shall perform cell reselection to the cell with the highest number of beams above the threshold (i.e. *absThreshSS-BlocksConsolidation*) among the cells whose R value is within *rangeToBestCell* of the R value of the highest ranked cell. If there are multiple such cells, the UE shall perform cell reselection to the highest ranked cell among them. If this cell is found to be not-suitable, the UE shall behave according to subclause 5.2.4.4.

In all cases, the UE shall reselect the new cell, only if the following conditions are met:

- the new cell is better than the serving cell according to the cell reselection criteria specified above during a time interval $T_{\text{reselection,RAT}}$;
- more than 1 second has elapsed since the UE camped on the current serving cell.

[TS 38.304, clause 5.3.1]

Cell status and cell reservations are indicated in the *MIB* or *SIB1* message as specified in TS 38.331 [3] by means of three fields:

- *cellBarred* (IE type: "barred" or "not barred")
Indicated in *MIB* message. In case of multiple PLMNs indicated in *SIB1*, this field is common for all PLMNs
- *cellReservedForOperatorUse* (IE type: "reserved" or "not reserved")
Indicated in *SIB1* message. In case of multiple PLMNs indicated in *SIB1*, this field is specified per PLMN.

- *cellReservedForOtherUse* (IE type: "true")
Indicated in *SIB1* message. In case of multiple PLMNs indicated in *SIB1*, this field is common for all PLMNs.

When cell status is indicated as "not barred" and "not reserved" for operator use and not "true" for other use,

- All UEs shall treat this cell as candidate during the cell selection and cell reselection procedures.

When cell status is indicated as "true" for other use,

- The UE shall treat this cell as if cell status is "barred".

When cell status is indicated as "not barred" and "reserved" for operator use for any PLMN and not "true" for other use,

- UEs assigned to Access Identity 11 or 15 operating in their HPLMN/EHPLMN shall treat this cell as candidate during the cell selection and reselection procedures if the field *cellReservedForOperatorUse* for that PLMN set to "reserved".
- UEs assigned to an Access Identity 1, 2 and 12 to 14 shall behave as if the cell status is "barred" in case the cell is "reserved for operator use" for the registered PLMN or the selected PLMN.

NOTE 1: Access Identities 11, 15 are only valid for use in the HPLMN/ EHPLMN; Access Identities 12, 13, 14 are only valid for use in the home country as specified in TS 22.261 [12].

When cell status "barred" is indicated or to be treated as if the cell status is "barred",

- The UE is not permitted to select/reselect this cell, not even for emergency calls.
- The UE shall select another cell according to the following rule:
 - If the cell is to be treated as if the cell status is "barred" due to being unable to acquire the *MIB*:
 - the UE may exclude the barred cell as a candidate for cell selection/reselection for up to 300 seconds.
 - the UE may select another cell on the same frequency if the selection criteria are fulfilled.
 - else:
 - If the cell is to be treated as if the cell status is "barred" due to being unable to acquire the *SIB1*:
 - The UE may exclude the barred cell as a candidate for cell selection/reselection for up to 300 seconds.
 - If the field *intraFreqReselection* in *MIB* message is set to "allowed", the UE may select another cell on the same frequency if re-selection criteria are fulfilled;
 - The UE shall exclude the barred cell as a candidate for cell selection/reselection for 300 seconds.
 - If the field *intraFreqReselection* in *MIB* message is set to "not allowed" the UE shall not re-select a cell on the same frequency as the barred cell;
 - The UE shall exclude the barred cell and the cells on the same frequency as a candidate for cell selection/reselection for 300 seconds.

The cell selection of another cell may also include a change of RAT.

6.1.2.12.3 Test description

6.1.2.12.3.1 Pre-test conditions

System Simulator:

- NR Cell 1 and NR Cell 11 in different tracking areas.
- System information combination NR-2 as defined in TS 38.508-1 [4] clause 4.4.3.1.2 is used in NR Cells.

UE:

None.

Preamble:

- The UE is in NR RRC Idle mode (state 1N-A) on NR Cell 1 according to 38.508-1 [4] Table 4.4A.2-1.

6.1.2.12.3.2 Test procedure sequence

Table 6.1.2.12.3.2-1/2 illustrate the downlink power levels and other changing parameters to be applied for the cell at various time instants of the test execution. The exact instants on which these values shall be applied are described in the texts in this clause. The configuration T0 indicates the initial conditions for preamble. Configurations marked "T1" is applied at the points indicated in the Main behaviour description in Table 6.1.2.12.3.2-3.

Table 6.1.2.12.3.2-1: Time instances of cell power level and parameter changes for FR1

	Parameter	Unit	NR Cell 1	NR Cell 11	Remark
T0	SS/PBCH SSS EPRE	dBm/ SCS	-88	Off	
T1	SS/PBCH SSS EPRE	dBm/ SCS	-88	-80	The power level values are assigned to satisfy $R_{NRCell\ 1} < R_{NRCell\ 11}$
	cellReservedFor OtherUse	-	-	True	

Table 6.1.2.12.3.2-2: Time instances of cell power level and parameter changes for FR2

	Parameter	Unit	NR Cell 1	NR Cell 11	Remark
T0	SS/PBCH SSS EPRE	dBm/ SCS	FFS	Off	
T1	SS/PBCH SSS EPRE	dBm/ SCS	FFS	FFS	The power level values are assigned to satisfy $R_{NRCell\ 1} < R_{NRCell\ 11}$
	cellReservedFor OtherUse	-	-	True	

Table 6.1.2.12.3.2-3: Main behaviour

St	Procedure	Message Sequence		TP	Verdict
		U - S	Message		
1	The SS re-adjusts the SS/PBCH EPRE levels and according to row "T1" in table 6.1.2.12.3.2-1/2.	-	-	-	-
2	Check: Does the UE initiate a random access procedure on NR Cell 11 within the next 120s?	-	-	1	F
3	Check: Does the test result of generic test procedure in TS 38.508-1 [4] Table 4.9.4.2.2-1 indicate that check UE is in state NR RRC_IDLE on NR Cell 1?	-	-	1	-

6.1.2.12.3.3 Specific message contents

Table 6.1.2.12.3.3-1: SIB1 for NR Cell 11 (Preamble, Table 6.1.2.12.3.2-3)

Derivation Path: TS 38.508-1 [4], Table 4.6.1-5			
Information Element	Value/Remark	Comment	Condition
SIB1 ::= SEQUENCE {			
cellAccessRelatedInfo SEQUENCE {			
cellReservedForOtherUse	true		
}			
}			

6.1.2.13 Cell reselection using cell status and cell reservations / Access Identity 0, 1, 2 and 12 to 14 – cellReservedForOperatorUse

6.1.2.13.1 Test Purpose (TP)

(1)

```
with { UE camped normally in state NR RRC_IDLE and UE fitted with a USIM with at least one of the
following Access Identities set: 0,1,2,12,13,14 }
ensure that {
  when { a higher ranked cell is found "reserved" for Operator use }
  then { UE does not attempt to reselect to the higher ranked cell }
}
```

6.1.2.13.2 Conformance requirements

References: The conformance requirements covered in the present TC are specified in: 3GPP TS 38.304, clause 5.3.1. Unless otherwise stated these are Rel-15 requirements.

[TS 38.304, clause 5.3.1]

Cell status and cell reservations are indicated in the *MIB* or *SIB1* message as specified in TS 38.331 [3] by means of three fields:

- *cellBarred* (IE type: "barred" or "not barred")
Indicated in *MIB* message. In case of multiple PLMNs indicated in *SIB1*, this field is common for all PLMNs
- *cellReservedForOperatorUse* (IE type: "reserved" or "not reserved")
Indicated in *SIB1* message. In case of multiple PLMNs indicated in *SIB1*, this field is specified per PLMN.
- *cellReservedForOtherUse* (IE type: "true")
Indicated in *SIB1* message. In case of multiple PLMNs indicated in *SIB1*, this field is common for all PLMNs.

When cell status is indicated as "not barred" and "not reserved" for operator use and not "true" for other use,

- All UEs shall treat this cell as candidate during the cell selection and cell reselection procedures.

When cell status is indicated as "true" for other use,

- The UE shall treat this cell as if cell status is "barred".

When cell status is indicated as "not barred" and "reserved" for operator use for any PLMN and not "true" for other use,

- UEs assigned to Access Identity 11 or 15 operating in their HPLMN/EHPLMN shall treat this cell as candidate during the cell selection and reselection procedures if the field *cellReservedForOperatorUse* for that PLMN set to "reserved".
- UEs assigned to an Access Identity 0, 1, 2 and 12 to 14 shall behave as if the cell status is "barred" in case the cell is "reserved for operator use" for the registered PLMN or the selected PLMN.

NOTE 1: Access Identities 11, 15 are only valid for use in the HPLMN/EHPLMN; Access Identities 12, 13, 14 are only valid for use in the home country as specified in TS 22.261 [12].

When cell status "barred" is indicated or to be treated as if the cell status is "barred",

- The UE is not permitted to select/reselect this cell, not even for emergency calls.
- The UE shall select another cell according to the following rule:
 - If the cell is to be treated as if the cell status is "barred" due to being unable to acquire the *MIB*:
 - the UE may exclude the barred cell as a candidate for cell selection/reselection for up to 300 seconds.
 - the UE may select another cell on the same frequency if the selection criteria are fulfilled.
 - else:

- If the cell is to be treated as if the cell status is "barred" due to being unable to acquire the *SIB1* or due to *trackingAreaCode* being absent in *SIB1* as specified in TS 38.331 [3];- The UE may exclude the barred cell as a candidate for cell selection/reselection for up to 300 seconds.
- If the field *intraFreqReselection* in *MIB* message is set to "allowed", the UE may select another cell on the same frequency if re-selection criteria are fulfilled;
 - The UE shall exclude the barred cell as a candidate for cell selection/reselection for 300 seconds.
- If the field *intraFreqReselection* in *MIB* message is set to "not allowed" the UE shall not re-select a cell on the same frequency as the barred cell;
 - The UE shall exclude the barred cell and the cells on the same frequency as a candidate for cell selection/reselection for 300 seconds.

The cell selection of another cell may also include a change of RAT.

6.1.2.13.3 Test description

6.1.2.13.3.1 Pre-test conditions

System Simulator:

- NR Cell 1 and NR Cell 12 with different tracking areas.
- NR Cell 1 and NR Cell 12 are HPLMN.
- System information combination NR-4 as defined in TS 38.508-1 [4] clause 4.4.3.1.2 is used in NR Cells.

UE:

None.

Preamble:

- The UE is in NR RRC Idle mode (state 1N-A) on NR Cell 1 according to TS 38.508-1 [4] Table 4.4A.2-1.
- The UE switches off and then switches on.
- The UE is in NR RRC Idle mode (state 1N-A) on NR Cell 1 according to TS 38.508-1 [4] Table 4.4A.2-1.

6.1.2.13.3.2 Test procedure sequence

Table 6.1.2.13.3.2-1/2 illustrate the downlink power levels and other changing parameters to be applied for the cell at various time instants of the test execution. The exact instants on which these values shall be applied are described in the texts in this clause. Configurations marked "T0" is applied for Preamble. Configurations marked "T1" is applied at the points indicated in the Main behaviour description in Table 6.1.2.13.3.2-3.

Table 6.1.2.13.3.2-1: Time instances of cell power level and parameter changes for FR1

	Parameter	Unit	NR Cell 1	NR Cell 12	Remark
T0	SS/PBCH SSS EPRE	dBm/ SCS	-88	Off	
T1	SS/PBCH SSS EPRE	dBm/ SCS	-88	-80	The power level values are assigned to satisfy $R_{NRCell\ 1} < R_{NRCell\ 12}$
	cellReservedFor OperatorUse	-	-	Reserved	

Cell status and cell reservations are indicated in the *MIB* or *SIB1* message as specified in TS 38.331 [3] by means of three fields:

- *cellBarred* (IE type: "barred" or "not barred")
Indicated in *MIB* message. In case of multiple PLMNs indicated in *SIB1*, this field is common for all PLMNs
- *cellReservedForOperatorUse* (IE type: "reserved" or "not reserved")
Indicated in *SIB1* message. In case of multiple PLMNs indicated in *SIB1*, this field is specified per PLMN.
- *cellReservedForOtherUse* (IE type: "true")
Indicated in *SIB1* message. In case of multiple PLMNs indicated in *SIB1*, this field is common for all PLMNs.

When cell status is indicated as "not barred" and "not reserved" for operator use and not "true" for other use,

- All UEs shall treat this cell as candidate during the cell selection and cell reselection procedures.

When cell status is indicated as "true" for other use,

- The UE shall treat this cell as if cell status is "barred".

When cell status is indicated as "not barred" and "reserved" for operator use for any PLMN and not "true" for other use,

- UEs assigned to Access Identity 11 or 15 operating in their HPLMN/EHPLMN shall treat this cell as candidate during the cell selection and reselection procedures if the field *cellReservedForOperatorUse* for that PLMN set to "reserved".
- UEs assigned to an Access Identity 1, 2 and 12 to 14 shall behave as if the cell status is "barred" in case the cell is "reserved for operator use" for the registered PLMN or the selected PLMN.

NOTE 1: Access Identities 11, 15 are only valid for use in the HPLMN/ EHPLMN; Access Identities 12, 13, 14 are only valid for use in the home country as specified in TS 22.261 [12].

When cell status "barred" is indicated or to be treated as if the cell status is "barred",

- The UE is not permitted to select/reselect this cell, not even for emergency calls.
- The UE shall select another cell according to the following rule:
 - If the cell is to be treated as if the cell status is "barred" due to being unable to acquire the *MIB*:
 - the UE may exclude the barred cell as a candidate for cell selection/reselection for up to 300 seconds.
 - the UE may select another cell on the same frequency if the selection criteria are fulfilled.
 - else:
 - If the cell is to be treated as if the cell status is "barred" due to being unable to acquire the *SIB1*:
 - The UE may exclude the barred cell as a candidate for cell selection/reselection for up to 300 seconds.
 - If the field *intraFreqReselection* in *MIB* message is set to "allowed", the UE may select another cell on the same frequency if re-selection criteria are fulfilled;
 - The UE shall exclude the barred cell as a candidate for cell selection/reselection for 300 seconds.
 - If the field *intraFreqReselection* in *MIB* message is set to "not allowed" the UE shall not re-select a cell on the same frequency as the barred cell;
 - The UE shall exclude the barred cell and the cells on the same frequency as a candidate for cell selection/reselection for 300 seconds.

The cell selection of another cell may also include a change of RAT.

6.1.2.14.3 Test description

6.1.2.14.3.1 Pre-test conditions

System Simulator:

- NR Cell 1 and NR Cell 3 in different tracking areas.
- NR Cell 1 and NR Cell 3 are HPLMN.
- System information combination NR-4 as defined in TS 38.508-1 [4] clause 4.4.3.1.2 is used in NR Cells.

UE:

- The UE is equipped with a USIM containing default values and USIM Configuration 17.

Preamble:

- The UE is in NR RRC Idle mode (state 1N-A) on NR Cell 1 according to TS 38.508-1 [4] Table 4.4A.2-1.

6.1.2.14.3.2 Test procedure sequence

Table 6.1.2.14.3.2-1/2 illustrate the downlink power levels and other changing parameters to be applied for the cell at various time instants of the test execution. The exact instants on which these values shall be applied are described in the texts in this clause. Configurations marked "T0" is applied for Preamble. Configurations marked "T1" is applied at the points indicated in the Main behaviour description in Table 6.1.2.14.3.2-3.

Table 6.1.2.14.3.2-1: Time instances of cell power level and parameter changes for FR1

	Parameter	Unit	NR Cell 1	NR Cell 3	Remark
T0	SS/PBCH SSS EPRE	dBm/ SCS	-88	Off	
T1	SS/PBCH SSS EPRE	dBm/ SCS	-88	-80	The power level values are assigned to satisfy $R_{NRCell\ 1} < R_{NRCell\ 3}$
	cellReservedFor OperatorUse	-	-	Reserved	

Table 6.1.2.14.3.2-2: Time instances of cell power level and parameter changes for FR2

	Parameter	Unit	NR Cell 1	NR Cell 3	Remark
T0	SS/PBCH SSS EPRE	dBm/ SCS	FFS	Off	
T1	SS/PBCH SSS EPRE	dBm/ SCS	FFS	FFS	The power level values are assigned to satisfy $R_{NRCell\ 1} < R_{NRCell\ 3}$
	cellReservedFor OperatorUse	-	-	Reserved	

Table 6.1.2.14.3.2-3: Main behaviour

St	Procedure	Message Sequence		TP	Verdict
		U - S	Message		
1	The SS adjusts the SS/PBCH EPRE levels according to row "T1" in table 6.1.2.14.3.2-1/2.	-	-	-	-
2	Check: Does the test result of test steps 1 to 5 of generic test procedure in TS 38.508-1 [4] Table 4.9.5.2.2-1 indicate that the UE is camped on NR Cell 3?	-	-	1	P

6.1.2.14.3.3 Specific message contents

Table 6.1.2.14.3.3-1: SIB1 for NR Cell 3 (Preamble, Table 6.1.2.14.3.2-3)

Derivation Path: TS 38.508-1 [4], Table 4.6.1-5			
Information Element	Value/Remark	Comment	Condition
SIB1 ::= SEQUENCE {			
cellAccessRelatedInfo SEQUENCE {			
plmn-IdentityList SEQUENCE (SIZE (1..maxPLMN)) OF PLMN-Identity {			
cellReservedForOperatorUse	Reserved		
}			
}			
}			

6.1.2.15 Cell reselection in shared network environment

6.1.2.15.1 Test Purpose (TP)

(1)

```
with { the UE is in NR RRC_Idle and registered on the HPLMN }
ensure that {
  when { a cell of a different PLMN but shared with the HPLMN becomes highest ranked cell }
  then { the UE reselects the cell shared with the HPLMN }
}
```

6.1.2.15.2 Conformance requirements

References: The conformance requirements covered in the present TC are specified in: 3GPP TS 23.122, clause 4.4.3, and TS 38.304, clause 5.2.4.6. Unless otherwise stated these are Rel-15 requirements.

[TS 23.122, clause 4.4.3]

The registration on the selected PLMN and the location registration are only necessary if the MS is capable of services which require registration. Otherwise, the PLMN selection procedures are performed without registration.

The ME shall utilise all the information stored in the SIM related to the PLMN selection; e.g. "HPLMN Selector with Access Technology", "User Controlled PLMN Selector with Access Technology", "Forbidden PLMNs", "Equivalent HPLMN", see 3GPP TS 31.102 [40].

The ME shall either utilise the "Operator controlled PLMN Selector with Access Technology" that it has stored locally on the ME, or the Operator controlled PLMN Selector with Access Technology" stored in the SIM, for the purposes of PLMN selection.

The "HPLMN Selector with Access Technology", "User Controlled PLMN Selector with Access Technology" and "Operator Controlled PLMN Selector with Access Technology" data files in the SIM include associated access technologies for each PLMN entry, see 3GPP TS 31.102 [40]. The PLMN/access technology combinations are listed in priority order. If an entry indicates more than one access technology, then no priority is defined for the access technologies within this entry and the priority applied to each access technology within this entry is an implementation issue. If no particular access technology is indicated in an entry, it shall be assumed that all access technologies supported by the ME apply to the entry. If an entry only indicates access technologies not supported by the ME, the entry shall be ignored. If an entry indicates at least one access technology supported by the ME, the entry shall be used in the PLMN selection procedures if the other criteria defined for the specific PLMN selection procedures are fulfilled.

The Mobile Equipment stores a list of "equivalent PLMNs". This list is replaced or deleted at the end of each location update procedure, routing area update procedure, GPRS attach procedure, tracking area update procedure, EPS attach procedure, and registration procedure. The list is deleted by an MS attached for emergency bearer services after detach or registered for emergency services after deregistration. The stored list consists of a list of equivalent PLMNs as downloaded by the network plus the PLMN code of the registered PLMN that downloaded the list. All PLMNs in the stored list, in all access technologies supported by the PLMN, are regarded as equivalent to each other for PLMN selection, cell selection/re-selection and handover.

When the MS reselects to a cell in a shared network, and the cell is a suitable cell for multiple PLMN identities received on the BCCH or on the EC-BCCH the AS indicates these multiple PLMN identities to the NAS according to 3GPP TS 44.018 [34], 3GPP TS 44.060 [39], 3GPP TS 25.304 [32] and 3GPP TS 36.304 [43]. The MS shall choose one of these PLMNs. If the registered PLMN is available among these PLMNs, the MS shall not choose a different PLMN.

The MS shall not use the PLMN codes contained in the "HPLMN Selector with Access Technology" data file.

It is possible for the home network operator to identify alternative Network IDs as the HPLMN. If the EHPLMN list is present, and not empty, the entries in the EHPLMN list are used in the network selection procedures. When attempting to select a network the highest priority EHPLMN that is available shall be selected. If the EHPLMN list is present and is empty or if the EHPLMN list is not present, the HPLMN derived from the IMSI is used for network selection procedures.

NOTE 1: The "HPLMN Selector with Access Technology" data file is only used by the MS to get the HPLMN access technologies related to the HPLMN code which corresponds to the PLMN code included in the IMSI if the EHPLMN list is not present or is empty. If the EHPLMN list is present then this data field is applicable to all the entries within the EHPLMN list.

NOTE 2: Different GSM frequency bands (e.g. 900, 1800, 1900, 400) are all considered GSM access technology. An MS supporting more than one band should scan all the bands it's supports when scanning for GSM frequencies. However GSM COMPACT systems which use GSM frequency bands but with the CBPCCH broadcast channel are considered as a separate access technology from GSM.

NOTE 3: The inclusion of the HPLMN derived from the IMSI in the EHPLMN list is allowed. The priority of the HPLMN derived from the IMSI is given by its position in the EHPLMN list, see 3GPP TS 31.102 [40]

[TS 38.304, clause 5.2.4.6]

The cell-ranking criterion R_s for serving cell and R_n for neighbouring cells is defined by:

$$R_s = Q_{\text{meas},s} + Q_{\text{hyst}} - Q_{\text{offset,temp}}$$

$$R_n = Q_{\text{meas},n} - Q_{\text{offset}} - Q_{\text{offset,temp}}$$

where:

Q_{meas}	RSRP measurement quantity used in cell reselections.
Q_{offset}	For intra-frequency: Equals to $Q_{\text{offset},s,n}$, if $Q_{\text{offset},s,n}$ is valid, otherwise this equals to zero. For inter-frequency: Equals to $Q_{\text{offset},s,n}$ plus $Q_{\text{offset,frequency}}$, if $Q_{\text{offset},s,n}$ is valid, otherwise this equals to $Q_{\text{offset,frequency}}$.
$Q_{\text{offset,temp}}$	Offset temporarily applied to a cell as specified in TS 38.331 [3].

The UE shall perform ranking of all cells that fulfil the cell selection criterion S , which is defined in 5.2.3.2.

The cells shall be ranked according to the R criteria specified above by deriving $Q_{\text{meas},n}$ and $Q_{\text{meas},s}$ and calculating the R values using averaged RSRP results.

If *rangeToBestCell* is not configured, the UE shall perform cell reselection to the highest ranked cell. If this cell is found to be not-suitable, the UE shall behave according to subclause 5.2.4.4.

If *rangeToBestCell* is configured, then the UE shall perform cell reselection to the cell with the highest number of beams above the threshold (i.e. *absThreshSS-BlocksConsolidation*) among the cells whose R value is within *rangeToBestCell* of the R value of the highest ranked cell. If there are multiple such cells, the UE shall perform cell reselection to the highest ranked cell among them. If this cell is found to be not-suitable, the UE shall behave according to subclause 5.2.4.4.

In all cases, the UE shall reselect the new cell, only if the following conditions are met:

- the new cell is better ranked than the serving cell during a time interval $T_{\text{reselection,RAT}}$;
- more than 1 second has elapsed since the UE camped on the current serving cell.

6.1.2.15.3 Test description

6.1.2.15.3.1 Pre-test conditions

System Simulator:

- NR Cell 1 (HPLMN)
- NR Cell 11 (primary PLMN: same MCC like HPLMN but different MNC, secondary PLMN: HPLMN)
- System information combination NR-3 as defined in TS 38.508-1 [4] clause 4.4.3.1.3 is used in NR Cells.

UE:

- None.

Preamble:

- The UE is in NR RRC Idle mode (state 1N-A) on NR Cell 1 according to 38.508-1 [4] Table 4.4A.2-1

6.1.2.15.3.2 Test procedure sequence

Table 6.1.2.15.3.2-1/2 illustrate the downlink power levels and other changing parameters to be applied for the cell at various time instants of the test execution. The exact instants on which these values shall be applied are described in the texts in this clause. Row marked "T0" denotes the conditions after the preamble. Configurations marked "T1" is applied at the points indicated in the Main behaviour description in Table 6.1.2.15.3.2-3.

Table 6.1.2.15.3.2-1: Time instances of cell power level and parameter changes for FR1

	Parameter	Unit	NR Cell 1	NR Cell 11	Remark
T0	SS/PBCH SSS EPRE	dBm/ SCS	-88	Off	
T1	SS/PBCH SSS EPRE	dBm/ SCS	-88	-78	The power level values are assigned to satisfy $S_{rxlevNRCell 11} > S_{rxlevNRCell 1}$

Table 6.1.2.15.3.2-2: Time instances of cell power level and parameter changes for FR2

	Parameter	Unit	NR Cell 1	NR Cell 11	Remark
T0	SS/PBCH SSS EPRE	dBm/ SCS	-91	Off	
T1	SS/PBCH SSS EPRE	dBm/ SCS	-91	-82	The power level values are assigned to satisfy $S_{rxlevNRCell 11} > S_{rxlevNRCell 1}$

Table 6.1.2.15.3.2-3: Main behaviour

St	Procedure	Message Sequence		TP	Verdict
		U - S	Message		
1	SS adjusts the SS/PBCH EPRE level of NR Cell 1 and NR Cell 11 according to row "T1" in table 6.1.2.1.3.2-1/2.	-	-	-	-
2	Check: Does the UE transmit an <i>RRCSetupRequest</i> message on NR Cell 11?	-->	NR RRC: <i>RRCSetupRequest</i>	1	P
3	The SS transmits an <i>RRCSetup</i> message.	<--	NR RRC: <i>RRCSetup</i>	-	-
4	Check: Does the UE transmit an <i>RRCSetupComplete</i> message indicating the HPLMN (second PLMN in the list)? Note: this message contains an REGISTRATION REQUEST message indicating "mobility registration updating" to update the registration of the actual tracking area according to default message contents.	-->	NR RRC: <i>RRCSetupComplete</i>	1	P
5 - 7	Steps 4 to 6 of the registration procedure described in TS 38.508-1 [4] Table 4.9.5.2.2-1 are performed on NR Cell 11.	-	-	-	-

6.1.2.15.3.3 Specific message contents

Table 6.1.2.15.3.3-1: *SIB1* for NR Cell 1 (Preamble and all steps, Table 6.1.2.15.3.2-3)

Derivation Path: TS 38.508-1 [4], Table 4.6.1-28			
Information Element	Value/remark	Comment	Condition
SIB1 ::= SEQUENCE {			
cellAccessRelatedInfo SEQUENCE {			
plmn-IdentityList SEQUENCE (SIZE (1..maxPLMN)) OF PLMN-Identity {			
plmn-Identity[1]	Set to the same Mobile Country Code and Mobile Network Code stored in EF _{IMSI} on the test USIM card		
}			
}			
}			

Table 6.1.2.15.3.3-2: *SIB1* for NR Cell 11 (Preamble and all steps, Table 6.1.2.15.3.2-3)

Derivation Path: TS 38.508-1 [4], Table 4.6.1-28			
Information Element	Value/Remark	Comment	Condition
SIB1 ::= SEQUENCE {			
cellAccessRelatedInfo SEQUENCE {			
plmn-IdentityList SEQUENCE (SIZE (1..maxPLMN)) OF PLMN-Identity {			
plmn-Identity[1]	Set to the same Mobile Country Code stored in EF _{IMSI} on the test USIM, MNC=02	Same MCC like PLMN for NR Cell 1 but different MNC	
plmn-Identity[2]	Set to the same Mobile Country Code and Mobile Network Code stored in EF _{IMSI} on the test USIM card	This is the same PLMN as NR Cell 1	
}			
}			
}			

Table 6.1.2.15.3.3-3: RRCSetupComplete (step 4, Table 6.1.2.15.3.2-3)

Derivation Path: TS 38.508-1 [4], Table 4.6.1-22			
Information Element	Value/remark	Comment	Condition
RRCSetupComplete ::= SEQUENCE {			
criticalExtensions CHOICE {			
rrcSetupComplete SEQUENCE {			
selectedPLMN-Identity	2	HPLMN	
}			
}			
}			

6.1.2.16 Inter-frequency cell reselection (equal priority)

6.1.2.16.1 Test Purpose (TP)

(1)

```
with { UE in NR RRC_IDLE state }
ensure that {
  when { UE detects both intra-frequency and equal priority inter-frequency neighbour cells and the
inter-frequency cell is the highest ranked cell }
  then { UE reselects the inter-frequency cell }
}
```

6.1.2.16.2 Conformance requirements

References: The conformance requirements covered in the present TC are specified in: 3GPP TS 38.304, clause 5.2.4.6. Unless otherwise stated these are Rel-15 requirements.

[TS 38.304, clause 5.2.4.6]

The cell-ranking criterion R_s for serving cell and R_n for neighbouring cells is defined by:

$$R_s = Q_{\text{meas},s} + Q_{\text{hyst}} - Q_{\text{offset,temp}}$$

$$R_n = Q_{\text{meas},n} - Q_{\text{offset}} - Q_{\text{offset,temp}}$$

where:

Q_{meas}	RSRP measurement quantity used in cell reselections.
Q_{offset}	For intra-frequency: Equals to $Q_{\text{offset},s,n}$, if $Q_{\text{offset},s,n}$ is valid, otherwise this equals to zero. For inter-frequency: Equals to $Q_{\text{offset},s,n}$ plus $Q_{\text{offset,frequency}}$, if $Q_{\text{offset},s,n}$ is valid, otherwise this equals to $Q_{\text{offset,frequency}}$.
$Q_{\text{offset,temp}}$	Offset temporarily applied to a cell as specified in TS 38.331 [3].

The UE shall perform ranking of all cells that fulfil the cell selection criterion S , which is defined in 5.2.3.2.

The cells shall be ranked according to the R criteria specified above by deriving $Q_{\text{meas},n}$ and $Q_{\text{meas},s}$ and calculating the R values using averaged RSRP results.

If *rangeToBestCell* is not configured, the UE shall perform cell reselection to the highest ranked cell. If this cell is found to be not-suitable, the UE shall behave according to subclause 5.2.4.4.

If *rangeToBestCell* is configured, then the UE shall perform cell reselection to the cell with the highest number of beams above the threshold (i.e. *absThreshSS-BlocksConsolidation*) among the cells whose R value is within *rangeToBestCell* of the R value of the highest ranked cell. If there are multiple such cells, the UE shall perform cell reselection to the highest ranked cell among them. If this cell is found to be not-suitable, the UE shall behave according to subclause 5.2.4.4.

In all cases, the UE shall reselect the new cell, only if the following conditions are met:

- the new cell is better ranked than the serving cell during a time interval $T_{reselection_{RAT}}$;
- more than 1 second has elapsed since the UE camped on the current serving cell.

6.1.2.16.3 Test description

6.1.2.16.3.1 Pre-test conditions

System Simulator:

- NR Cell 1, NR Cell 2 and NR Cell 3 have different tracking areas.
- System information combination NR-5 as defined in TS 38.508-1 [4] clause 4.4.3.1.3 is used in NR Cells.

UE:

None.

Preamble:

- The UE is in NR RRC Idle mode (state 1N-A) on NR Cell 1 (according to 38.508-1 [4] Table 4.4A.2-1).

6.1.2.16.3.2 Test procedure sequence

Table 6.1.2.16.3.2-1/2 illustrate the downlink power levels and other changing parameters to be applied for the cell at various time instants of the test execution. The exact instants on which these values shall be applied are described in the texts in this clause. Row marked "T0" denotes the conditions after the preamble. Configurations marked "T1", "T2" and "T3" are applied at the points indicated in the Main behaviour description in Table 6.1.2.16.3.2-3.

Table 6.1.2.16.3.2-1: Time instances of cell power level and parameter changes for FR1

	Parameter	Unit	NR Cell 1	NR Cell 2	NR Cell 3	Remark
T0	SS/PBCH SSS EPRE	dBm/ SCS	-88	-94	-78	The power level values are set so that $R_{NRCell 2} < R_{NRCell 1} < R_{NRCell 3}$.

Table 6.1.2.16.3.2-2: Time instances of cell power level and parameter changes for FR2

	Parameter	Unit	NR Cell 1	NR Cell 2	NR Cell 3	Remark
T0	SS/PBCH SSS EPRE	dBm/ SCS	FFS	FFS	FFS	

Table 6.1.2.16.3.2-3: Main behaviour

St	Procedure	Message Sequence		TP	Verdict
		U - S	Message		
1	The SS adjusts the SS/PBCH EPRE levels according to row "T0" in table 6.1.2.16.3.2-1/2.	-	-	-	-
2	Check: Does the test result of generic test procedure in TS 38.508-1 [4] Table 4.9.5.2.2-1 indicate that the UE is camped on NR Cell 3?	-	-	1	-

6.1.2.16.3.3 Specific message contents

None.

6.1.2.17 Cell reselection / Cell-specific reselection parameters provided by the network in a neighbouring cell list

6.1.2.17.1 Test Purpose (TP)

(1)

```
with { the UE is in NR RRC_IDLE and SystemInformationBlockType3 contain a cell-specific Qoffset for
a neighbour intra frequency cell }
ensure that {
  when { the neighbour cell has lower power than the serving cell but it is higher ranked due to the
cell-specific Qoffset }
  then { the UE reselects the neighbour cell with cell-specific Qoffset }
}
```

(2)

```
with { the UE is in RRC_IDLE and SystemInformationBlockType3 contain a black listed cell }
ensure that {
  when { a black listed intra-freq cell becomes higher ranked than the serving cell }
  then { the UE remains camped on the serving cell }
}
```

6.1.2.17.2 Conformance requirements

References: The conformance requirements covered in the present TC are specified in: 3GPP TS 38.304, clause 5.2.4.6. Unless otherwise stated these are Rel-15 requirements.

[TS 38.304, clause 5.2.4.6]

The cell-ranking criterion R_s for serving cell and R_n for neighbouring cells is defined by:

$$R_s = Q_{\text{meas},s} + Q_{\text{hyst}} - Q_{\text{offset,temp}}$$

$$R_n = Q_{\text{meas},n} - Q_{\text{offset}} - Q_{\text{offset,temp}}$$

where:

Q_{meas}	RSRP measurement quantity used in cell reselections.
Q_{offset}	For intra-frequency: Equals to $Q_{\text{offset},s,n}$, if $Q_{\text{offset},s,n}$ is valid, otherwise this equals to zero. For inter-frequency: Equals to $Q_{\text{offset},s,n}$ plus $Q_{\text{offset,frequency}}$, if $Q_{\text{offset},s,n}$ is valid, otherwise this equals to $Q_{\text{offset,frequency}}$.
$Q_{\text{offset,temp}}$	Offset temporarily applied to a cell as specified in TS 38.331 [3].

The UE shall perform ranking of all cells that fulfil the cell selection criterion S , which is defined in 5.2.3.2.

The cells shall be ranked according to the R criteria specified above by deriving $Q_{\text{meas},n}$ and $Q_{\text{meas},s}$ and calculating the R values using averaged RSRP results.

If *rangeToBestCell* is not configured, the UE shall perform cell reselection to the highest ranked cell. If this cell is found to be not-suitable, the UE shall behave according to subclause 5.2.4.4.

If *rangeToBestCell* is configured, then the UE shall perform cell reselection to the cell with the highest number of beams above the threshold (i.e. *absThreshSS-BlocksConsolidation*) among the cells whose R value is within *rangeToBestCell* of the R value of the highest ranked cell. If there are multiple such cells, the UE shall perform cell reselection to the highest ranked cell among them. If this cell is found to be not-suitable, the UE shall behave according to subclause 5.2.4.4.

In all cases, the UE shall reselect the new cell, only if the following conditions are met:

- the new cell is better ranked than the serving cell during a time interval $T_{\text{reselection,RAT}}$;
- more than 1 second has elapsed since the UE camped on the current serving cell.

6.1.2.17.3 Test description

6.1.2.17.3.1 Pre-test conditions

System Simulator:

- NR Cell 1, NR Cell 2 and NR Cell 4 in different tracking areas.
- System information combination NR-3 as defined in TS 38.508-1 [4] clause 4.4.3.1.3 is used in NR Cells.
- NR Cell 1 is transmitting *SIB3* according to specific message contents ($Q_{\text{offset}_{1,2}}$ is -24dB).
- NR Cell 2 is transmitting *SIB3* according to specific message contents (NR Cell 4 is on black list)

UE:

None.

Preamble:

- The UE is in NR RRC Idle mode (state 1N-A) on NR Cell 1 (according to 38.508-1 [4] Table 4.4A.2-1).

6.1.2.17.3.2 Test procedure sequence

Table 6.1.2.15.3.2-1/2 illustrate the downlink power levels and other changing parameters to be applied for the cell at various time instants of the test execution. The exact instants on which these values shall be applied are described in the texts in this clause. Row marked "T0" denotes the conditions after the preamble. Configurations marked "T1", "T2" and "T3" are applied at the points indicated in the Main behaviour description in Table 6.1.2.15.3.2-3.

Table 6.1.2.17.3.2-1: Time instances of cell power level and parameter changes for FR1

	Parameter	Unit	NR Cell 1	NR Cell 2	NR Cell 4	Remark
T0	SS/PBCH SSS EPRE	dBm/ SCS	-88	Off	Off	Only NR Cell 1 is on
T1	SS/PBCH SSS EPRE	dBm/ SCS	-88	-94	Off	NR Cell 2 has lower power but is higher ranked due to cell-specific $Q_{\text{offset}_{1,2}}$
T2	SS/PBCH SSS EPRE	dBm/ SCS	Off	-94	Off	
T3	SS/PBCH SSS EPRE	dBm/ SCS	Off	-94	-88	NR Cell 4 has higher power than NRCell 2 but is black listed

Table 6.1.2.17.3.2-2: Time instances of cell power level and parameter changes for FR2

	Parameter	Unit	NR Cell 1	NR Cell 2	NR Cell 4	Remark
T0	SS/PBCH SSS EPRE	dBm/ SCS	-82	Off	Off	Only NR Cell 1 is on
T1	SS/PBCH SSS EPRE	dBm/ SCS	-82	-91	Off	NR Cell 2 has lower power but is higher ranked due to cell-specific $Q_{\text{offset}_{1,2}}$
T2	SS/PBCH SSS EPRE	dBm/ SCS	Off	-91	Off	
T3	SS/PBCH SSS EPRE	dBm/ SCS	Off	-91	-82	NR Cell 4 has higher power than NRCell 2 but is black listed

Table 6.1.2.17.3.2-3: Main behaviour

St	Procedure	Message Sequence		TP	Verdict
		U - S	Message		
1	The SS adjusts the SS/PBCH EPRE levels according to row "T1" in table 6.1.2.17.3.2-1/2.	-	-	-	-
2-6	Check: Does the test result of test steps 1 to 5 of generic test procedure in TS 38.508-1 [4] Table 4.9.5.2.2-1 indicate that the UE is camped on NR Cell 2?	-	-	1	P
7	The SS re-adjusts the SS/PBCH EPRE levels according to row "T2" in table 6.1.2.17.3.2-1/2.	-	-	-	-
8	Wait for 1 second to allow UE to recognise the change.	-	-	-	-
9	The SS transmits an <i>RRCRelease</i> message to release RRC connection and move to RRC_IDLE.	<-	NR RRC: <i>RRCRelease</i>	-	-
10	The SS re-adjusts the SS/PBCH EPRE levels according to row "T3" in table 6.1.2.17.3.2-1/2.	-	-	-	-
11	Check: Does the UE initiate a random access procedure on NR Cell 4 within the next 120s?	-	-	2	F

6.1.2.17.3.3 Specific message contents

Table 6.1.2.17.3.3-1: SIB3 for NR Cell 1 (all steps, Table 6.1.2.17.3.2-3)

Derivation Path: TS 38.508-1 [4], Table 4.6.2-2			
Information Element	Value/Remark	Comment	Condition
SIB3 ::= SEQUENCE {			
intraFreqNeighCellList SEQUENCE {			
physCellId	The cell identity of NR Cell 2 defined in 38.508-1 [4] clause 4.4.2		
q-OffsetCell	dB-24		
}			
}			

Table 6.1.2.17.3.3-2: SIB3 for NR Cell 2 (all steps, Table 6.1.2.17.3.2-3)

Derivation Path: TS 38.508-1 [4], Table 4.6.2-2			
Information Element	Value/Remark	Comment	Condition
SIB3 ::= SEQUENCE {			
intraFreqBlackCellList SEQUENCE {	1 entry		
start	PhysicalCellID of NR Cell 4		
range	Not present		
}			
}			

6.1.2.18 Cell reselection, Sintrasearch, Snointrasearch

6.1.2.18.1 Test Purpose (TP)

(1)

```

with { UE in NR RRC_IDLE state, and the UE is not in high mobility state }
ensure that {
  when { Sintrasearch is non-zero in system information }
  then { UE performs measurement and reselects the highest ranked cell upon Srxlev < Sintrasearch }
}

```

(2)

```

with { UE in NR RRC_IDLE state, and the UE is not in high mobility state }
ensure that {
  when { Snonintrasearch is non-zero in system information }
  then { UE perform measurement and reselects the cell which belong to the equal priority
frequency cell upon Srxlev < Snonintrasearch }
}

```

(3)

```

with { UE in NR RRC_IDLE state, and the UE is not in high mobility state }
ensure that {
  when { Snonintrasearch is non-zero in system information }
  then { UE perform measurement and reselects the cell which belong to the high priority
frequency cell upon Srxlev > Snonintrasearch }
}

```

6.1.2.18.2 Conformance requirements

References: The conformance requirements covered in the current TC are specified in: TS 38.304, clauses 5.2.4.1, 5.2.4.5 and 5.2.4.6.

[TS 38.304, clause 5.2.4.1]

Absolute priorities of different NR frequencies or inter-RAT frequencies may be provided to the UE in the system information, in the RRCRelease message, or by inheriting from another RAT at inter-RAT cell (re)selection. In the case of system information, an NR frequency or inter-RAT frequency may be listed without providing a priority (i.e. the field cellReselectionPriority is absent for that frequency). If priorities are provided in dedicated signalling, the UE shall ignore all the priorities provided in system information. If UE is in camped on any cell state, UE shall only apply the priorities provided by system information from current cell, and the UE preserves priorities provided by dedicated signalling and deprioritisationReq received in RRCRelease unless specified otherwise. When the UE in camped normally state, has only dedicated priorities other than for the current frequency, the UE shall consider the current frequency to be the lowest priority frequency (i.e. lower than any of the network configured values).

The UE shall only perform cell reselection evaluation for NR frequencies and inter-RAT frequencies that are given in system information and for which the UE has a priority provided.

In case UE receives RRCRelease with deprioritisationReq, UE shall consider current frequency and stored frequencies due to the previously received RRCRelease with deprioritisationReq or all the frequencies of NR to be the lowest priority frequency (i.e. lower than any of the network configured values) while T325 is running irrespective of camped RAT. The UE shall delete the stored deprioritisation request(s) when a PLMN selection is performed on request by NAS (TS 23.122 [9]).

NOTE: UE should search for a higher priority layer for cell reselection as soon as possible after the change of priority. The minimum related performance requirements specified in TS 38.133 [8] are still applicable.

The UE shall delete priorities provided by dedicated signalling when:

- the UE enters a different RRC state; or
- the optional validity time of dedicated priorities (T320) expires; or
- a PLMN selection is performed on request by NAS (TS 23.122 [9]).

NOTE 2: Equal priorities between RATs are not supported.

The UE shall not consider any black listed cells as candidate for cell reselection.

The UE shall inherit the priorities provided by dedicated signalling and the remaining validity time (i.e. T320 in NR and E-UTRA), if configured, at inter-RAT cell (re)selection.

NOTE 3: The network may assign dedicated cell reselection priorities for frequencies not configured by system information.

[TS 38.304, clause 5.2.4.5]

If *threshServingLowQ* is broadcast in system information and more than 1 second has elapsed since the UE camped on the current serving cell, cell reselection to a cell on a higher priority NR frequency or inter-RAT frequency than the serving frequency shall be performed if:

- A cell of a higher priority NR or EUTRAN RAT/frequency fulfils $S_{qual} > \text{ThreshX, HighQ}$ during a time interval *TreselectionRAT*

Otherwise, cell reselection to a cell on a higher priority NR frequency or inter-RAT frequency than the serving frequency shall be performed if:

- A cell of a higher priority RAT/ frequency fulfils $S_{rxlev} > \text{ThreshX, HighP}$ during a time interval *TreselectionRAT*; and
- More than 1 second has elapsed since the UE camped on the current serving cell.

Cell reselection to a cell on an equal priority NR frequency shall be based on ranking for intra-frequency cell reselection as defined in clause 5.2.4.6.

If *threshServingLowQ* is broadcast in system information and more than 1 second has elapsed since the UE camped on the current serving cell, cell reselection to a cell on a lower priority NR frequency or inter-RAT frequency than the serving frequency shall be performed if:

- The serving cell fulfils $S_{qual} < \text{ThreshServing, LowQ}$ and a cell of a lower priority NR or E-UTRAN RAT/ frequency fulfils $S_{qual} > \text{ThreshX, LowQ}$ during a time interval *TreselectionRAT*.

Otherwise, cell reselection to a cell on a lower priority NR frequency or inter-RAT frequency than the serving frequency shall be performed if:

- The serving cell fulfils $S_{rxlev} < \text{ThreshServing, LowP}$ and a cell of a lower priority RAT/ frequency fulfils $S_{rxlev} > \text{ThreshX, LowP}$ during a time interval *TreselectionRAT*; and
- More than 1 second has elapsed since the UE camped on the current serving cell.

Cell reselection to a higher priority RAT/frequency shall take precedence over a lower priority RAT/frequency if multiple cells of different priorities fulfil the cell reselection criteria.

If more than one cell meets the above criteria, the UE shall reselect a cell as follows:

- If the highest-priority frequency is an NR frequency, the highest ranked cell among the cells on the highest priority frequency(ies) meeting the criteria according to clause 5.2.4.6;
- If the highest-priority frequency is from another RAT, the strongest cell among the cells on the highest priority frequency(ies) meeting the criteria of that RAT.

[TS 38.304, clause 5.2.4.6]

The cell-ranking criterion R_s for serving cell and R_n for neighbouring cells is defined by:

$$R_s = Q_{meas,s} + Q_{hyst} - Q_{offsettemp}$$

$$R_n = Q_{meas,n} - Q_{offset} - Q_{offsettemp}$$

where:

Q_{meas}	RSRP measurement quantity used in cell reselections.
Q_{offset}	For intra-frequency: Equals to $Q_{offset_{s,n}}$, if $Q_{offset_{s,n}}$ is valid, otherwise this equals to zero. For inter-frequency: Equals to $Q_{offset_{s,n}}$ plus $Q_{offset_{frequency}}$, if $Q_{offset_{s,n}}$ is valid, otherwise this equals to $Q_{offset_{frequency}}$.
$Q_{offsettemp}$	Offset temporarily applied to a cell as specified in TS 38.331 [3].

The UE shall perform ranking of all cells that fulfil the cell selection criterion S , which is defined in 5.2.3.2.

The cells shall be ranked according to the R criteria specified above by deriving $Q_{meas,n}$ and $Q_{meas,s}$ and calculating the R values using averaged RSRP results.

If *rangeToBestCell* is not configured, the UE shall perform cell reselection to the highest ranked cell. If this cell is found to be not-suitable, the UE shall behave according to clause 5.2.4.4.

If *rangeToBestCell* is configured, then the UE shall perform cell reselection to the cell with the highest number of beams above the threshold (i.e. *absThreshSS-BlocksConsolidation*) among the cells whose R value is within *rangeToBestCell* of the R value of the highest ranked cell. If there are multiple such cells, the UE shall perform cell reselection to the highest ranked cell among them. If this cell is found to be not-suitable, the UE shall behave according to clause 5.2.4.4.

In all cases, the UE shall reselect the new cell, only if the following conditions are met:

- the new cell is better than the serving cell according to the cell reselection criteria specified above during a time interval *TreselectionRAT*;
- more than 1 second has elapsed since the UE camped on the current serving cell.

NOTE: If *rangeToBestCell* is configured but *absThreshSS-BlocksConsolidation* is not configured on an NR frequency, the UE considers that there is one beam above the threshold for each cell on that frequency.

6.1.2.18.3 Test description

6.1.2.18.3.1 Pre-test conditions

System Simulator:

- NR Cell 1, NR Cell 2 and NR Cell 3 as defined in TS 38.508-1 [4] Table 4.4.2-2 is used.
- NR Cell 1 uses System information combination NR-3 as defined in TS 38.508-1 [4] Table 4.4.3.1.2-1 is used in NR cells.
- NR Cell 2 and NR Cell 3 uses System information combination NR-4 as defined in TS 38.508-1 [4] Table 4.4.3.1.2-1 is used in NR cells.

UE:

- None.

Preamble:

- The UE is in state 1N-A on NR Cell 1(serving cell) according to TS 38.508-1 [4] Table 4.4A.2-1.

6.1.2.18.3.2 Test procedure sequence

Table 6.1.2.18.3.2-1/2 illustrates the downlink power levels and other changing parameters to be applied for the NR cells at various time instants of the test execution. The exact instants on which these values shall be applied are described in the texts in this clause. Configurations marked "T1", "T2" and "T3" are applied at the points indicated in the Main behaviour description in Table 6.1.2.13.3.2-2.

Table 6.1.2.18.3.2-1: Time instances of cell power level and parameter changes for FR1

	Parameter	Unit	NR Cell 1	NR Cell 2	NR Cell 3	Remark
T0	SS/PBCH SSS EPRE	dBm/SCS	-88	Off	Off	The power level values are assigned to ensure the UE registered on NR Cell 1.
T1	SS/PBCH SSS EPRE	dBm/SCS	-102	-94	-118	Srxlev of NR Cell 1 is less than Sintrasearch.
	SintraSearch	dB	20	20	20	
T2	Srxlev	dB	8	16	-8	Srxlev of NR Cell 2 is less than Snonintrasearch.
	SS/PBCH SSS EPRE	dBm/SCS	-118	-102	-94	
T3	SnonIntraSearch	dB	20	20	20	Srxlev of NR Cell 3 is greater than Snonintrasearch but Cell 1 is high priority cell.
	Srxlev	dB	-8	8	16	
T4	SnonIntraSearch	dB	20	20	2	
T4	SS/PBCH SSS EPRE	dBm/SCS	-88	-118	-88	Srxlev of NR Cell 3 is greater than Snonintrasearch but Cell 1 is high priority cell.
	Srxlev	dB	22	22	22	

Note: Power level "Off" is defined in TS38.508-1 [4] Table 6.2.2.1-3.

Table 6.1.2.18.3.2-2: Time instances of cell power level and parameter changes for FR2

	Parameter	Unit	NR Cell 1	NR Cell 2	NR Cell 3	Remark
T0	SS/PBCH SSS EPRE	dBm/SCS	FFS	Off	Off	The power level values are assigned to ensure the UE registered on NR Cell 1.
T1	SS/PBCH SSS EPRE	dBm/SCS	FFS	FFS	FFS	Srxlev of NR Cell 1 is less than Sintrasearch.
	SintraSearch	dB	20	20	20	
T2	Srxlev	dB	FFS	FFS	FFS	Srxlev of NR Cell 2 is less than Snonintrasearch.
	SS/PBCH SSS EPRE	dBm/SCS	FFS	FFS	FFS	
T3	SnonIntraSearch	dB	20	20	20	Srxlev of NR Cell 3 is greater than Snonintrasearch but Cell 1 is high priority cell.
	Srxlev	dB	FFS	FFS	FFS	
T4	SnonIntraSearch	dB	20	20	2	
T4	SS/PBCH SSS EPRE	dBm/SCS	FFS	FFS	FFS	Srxlev of NR Cell 3 is greater than Snonintrasearch but Cell 1 is high priority cell.
	Srxlev	dB	FFS	FFS	FFS	

Note: The uncertain downlink signal level is specified in TS 38.508-1[4] section FFS

Table 6.1.2.18.3.2-3: Main behaviour

St	Procedure	Message Sequence		TP	Verdict
		U - S	Message		
1	The SS re-adjusts the SS/PBCH EPRE levels according to row "T1" in table 6.1.2.18.3.2-1/2.	-	-	-	-
2	Wait for 34 seconds to allow UE to recognise the change.	-	-	-	-
3	Check: Does the test result of generic test procedure in TS 38.508-1 [4] Table 4.9.4-1 indicate that the UE is camped on NR Cell 2?	-	-	1	P
4	The SS re-adjusts the SSS levels according to row "T2" in table 6.1.2.18.3.2-1/2.	-	-	-	-
5	Wait for 34 seconds to allow UE to recognise the change.	-	-	-	-
6	Check: Does the test result of generic test procedure in TS 38.508-1 [4] Table 4.9.4-1 indicate that the UE is camped on NR Cell 3?	-	-	2	P
7	The SS notifies the UE of change of System Information on NR Cell 3 by sending Short Message on PDCCH using P-RNTI.	<--	NR RRC: Paging	-	-
8	The SS changes the SnonIntraSearch for NR Cell 3 according to row "T3" in table 6.1.2.18.3.2-1/2, The ValueTag of SIB2 in the SI-SchedulingInfo of SIB1 is increased on NR Cell 3.	-	-	-	-
9	Wait for 2.1* modification period to allow the new system information to take effect.	-	-	-	-
10	The SS re-adjusts the SSS levels according to row "T4" in table 6.1.2.18.3.2-1/2.	-	-	-	-
11	Wait for 120 seconds to allow UE to recognise the change.	-	-	-	-
12	Check: Does the test result of generic test procedure in TS 38.508-1 [4] Table 4.9.4-1 indicate that the UE is camped on NR Cell 1?	-	-	3	P

6.1.2.18.3.3 Specific message contents

Table 6.1.2.18.3.3-1: Conditions for specific message contents in Tables below

Condition	Explanation
NR Cell 1	This condition applies to system information transmitted on NR Cell 1.
NR Cell 2	This condition applies to system information transmitted on NR Cell 2.
NR Cell 3	This condition applies to system information transmitted on NR Cell 3.

Table 6.1.2.18.3.3-2: SIB2 of NR Cell 1, NR Cell 2 and NR Cell 3 (preabmle and all steps, Table 6.1.2.18.3.2-3)

Derivation Path: TS 38.508-1 [4], Table 4.6.2-1			
Information Element	Value/remark	Comment	Condition
SIB2 ::= SEQUENCE {			
cellReselectionServingFreqInfo			
SEQUENCE {			
s-NonIntraSearch	10	20 dB	
cellReselectionPriority	5		NR Cell 1
}	1		NR Cell 2 and Cell 3
}			
intraFreqCellReselectionInfo SEQUENCE			
{			
s-IntraSearchP	10	20 dB	
}			
}			

Table 6.1.2.18.3.3-3: SIB4 of NR Cell 2 and NR Cell 3 (preabmle and all steps, Table 6.1.2.18.3.2-3)

Derivation Path: TS 38.508-1 [4], Table 4.6.2-3			
Information Element	Value/remark	Comment	Condition
SIB4 ::= SEQUENCE {			
interFreqCarrierFreqList SEQUENCE (SIZE (1..maxFreq)) OF InterFreqCarrierFreqInfo {	1 entry		
{		entry 1	
dl-CarrierFreq	Same downlink ARFCN as used for NR Cell 3		NR Cell 2
}	Same downlink ARFCN as used for NR Cell 1		NR Cell 3
t-ReselectionNR	1		
threshX-HighP	7	14 dBm	NR Cell 3
cellReselectionPriority	5		NR Cell 3
}	1		NR Cell 2
}			
}			

Table 6.1.2.18.3.3-4: SIB1 of NR Cell 3 (step 8, Table 6.1.2.18.3.2-3)

Derivation Path: TS 38.508-1 [4], Table 4.6.1-28			
Information Element	Value/remark	Comment	Condition
SIB1 ::= SEQUENCE {			
si-SchedulingInfo	SI-SchedulingInfo		
}			

Table 6.1.2.81.3.3-5: SI-SchedulingInfo (si-SchedulingInfo in Table 6.1.2.18.3.3-4)

Derivation Path: TS 38.508-1 [4], Table 4.6.3-173			
Information Element	Value/remark	Comment	Condition
SI-SchedulingInfo ::= SEQUENCE {			
schedulingInfoList SEQUENCE (SIZE(1..maxSI-Message)) OF SchedulingInfo {	1 entry		
SchedulingInfo[1] SEQUENCE {		entry 1	
sib-MappingInfo SEQUENCE (SIZE(1..maxSIB)) OF SIB-TypeInfo {	1 entry		
SIB-TypeInfo[1] SEQUENCE {		entry 1	
type	sibType2		
valueTag	1		
}			
}			
}			
}			
}			

Table 6.1.2.18.3.3-6: SIB2 of NR Cell 3 (step 8, Table 6.1.2.18.3.2-3)

Derivation Path: TS 38.508-1 [4], Table 4.6.2-1			
Information Element	Value/remark	Comment	Condition
SIB2 ::= SEQUENCE {			
cellReselectionServingFreqInfo SEQUENCE {			
s-NonIntraSearchP	1	20 dB	
}			
}			

6.1.2.19 Speed-dependent cell reselection

6.1.2.19.1 Test Purpose (TP)

(1)

```
with {UE in NR RRC_IDLE state and in high mobility state}
ensure that {
  when {UE detects the cell ranked as the best cell taking into account scaling factor}
  then {UE reselects the new cell}
}
```

(2)

```
with {UE in NR RRC_IDLE state and in medium mobility state}
ensure that {
  when {UE detects the cell ranked as the best cell taking into account scaling factor}
  then {UE reselects the new cell}
}
```

6.1.2.19.2 Conformance requirements

References: The conformance requirements covered in the present test case are specified in: TS 38.304, clauses 5.2.4.3.0 and 5.2.4.3.1. TS 38.133, clause 4.2.2.3. Unless otherwise stated these are Rel-15 requirements.

[TS 38.304, clause 5.2.4.3.0]

The UE mobility state is determined if the parameters (TCRmax, NCR_H, NCR_M and TCRmaxHyst) are broadcasted in system information for the serving cell.

State detection criteria:

...

Medium-mobility state criteria:

- If number of cell reselections during time period T_{CRmax} is greater than or equal to N_{CR_M} but less than or equal to N_{CR_H} .

High-mobility state criteria:

- If number of cell reselections during time period T_{CRmax} is greater than N_{CR_H} .

The UE shall not consider consecutive reselections where a cell is reselected again right after one reselection for mobility state detection criteria.

State transitions:

The UE shall:

- if the criteria for High-mobility state is detected:
 - enter High-mobility state.
- else if the criteria for Medium-mobility state is detected:
 - enter Medium-mobility state.

...

If the UE is in High- or Medium-mobility state, the UE shall apply the speed dependent scaling rules as defined in subclause 5.2.4.3.1.

[TS 38.304, clause 5.2.4.3.1]

UE shall apply the following scaling rules:

- If neither Medium- nor High-mobility state is detected:
 - no scaling is applied.
- If High-mobility state is detected:
 - Add the *sf-High* of "Speed dependent ScalingFactor for Q_{hyst} " to Q_{hyst} if broadcasted in system information;
 - For NR cells, multiply $T_{reselection_{NR}}$ by the *sf-High* of "Speed dependent ScalingFactor for $T_{reselection_{NR}}$ " if broadcasted in system information;

...

- If Medium-mobility state is detected:
 - Add the *sf-Medium* of "Speed dependent ScalingFactor for Q_{hyst} " to Q_{hyst} if broadcasted in system information;
 - For NR cells, multiply $T_{reselection_{NR}}$ by the *sf-Medium* of "Speed dependent ScalingFactor for $T_{reselection_{NR}}$ " if broadcasted in system information;

...

In case scaling is applied to any $T_{reselection_{RAT}}$ parameter, the UE shall round up the result after all scalings to the nearest second.

[TS 38.133, clause 4.2.2.3]

The UE shall be able to identify new intra-frequency cells and perform SS-RSRP and SS-RSRQ measurements of the identified intra-frequency cells without an explicit intra-frequency neighbour list containing physical layer cell identities.

The UE shall be able to evaluate whether a newly detectable intra-frequency cell meets the reselection criteria defined in TS38.304 within $T_{\text{detect,NR_Intra}}$ when that $T_{\text{reselection}}=0$. An intra frequency cell is considered to be detectable according to the conditions defined in Annex B.1.2 for a corresponding Band.

The UE shall measure SS-RSRP and SS-RSRQ at least every $T_{\text{measure,NR_Intra}}$ (see table 4.2.2.3-1) for intra-frequency cells that are identified and measured according to the measurement rules.

The UE shall filter SS-RSRP and SS-RSRQ measurements of each measured intra-frequency cell using at least 2 measurements. Within the set of measurements used for the filtering, at least two measurements shall be spaced by at least $T_{\text{measure,NR_Intra}}/2$.

The UE shall not consider a NR neighbour cell in cell reselection, if it is indicated as not allowed in the measurement control system information of the serving cell.

For an intra-frequency cell that has been already detected, but that has not been reselected to, the filtering shall be such that the UE shall be capable of evaluating that the intra-frequency cell has met reselection criterion defined [1] within $T_{\text{evaluate,NR_Intra}}$ when $T_{\text{reselection}}=0$ as specified in table 4.2.2.3-1 provided that:

- when *rangeToBestCell* is not configured, the cell has at least [3]dB in FR1 or [TBD]dB in FR2 better ranked or
- when *rangeToBestCell* is configured, the cell which has the highest number of beams above the threshold *absThreshSS-BlocksConsolidation* among the cells whose cell-ranking criterion R value as specified in TS 38.304 [1, Section 5.2.4.6] is within *rangeToBestCell* of the R value of the best cell where the best cell has at least [TBD] in FR1 or [TBD]dB in FR2 better ranked, and if there are multiple such cells the UE shall perform cell reselection to the highest ranked cell among them.

When evaluating cells for reselection, the SSB side conditions apply to both serving and non-serving intra-frequency cells.

If $T_{\text{reselection}}$ timer has a non-zero value and the intra-frequency cell is satisfied with the reselection criteria which are defined in TS38.304 [1], the UE shall evaluate this intra-frequency cell for the $T_{\text{reselection}}$ time. If this cell remains satisfied with the reselection criteria within this duration, then the UE shall reselect that cell.

Table 4.2.2.3-1: $T_{\text{detect,NR_Intra}}$, $T_{\text{measure,NR_Intra}}$ and $T_{\text{evaluate,NR_Intra}}$

DRX cycle length [s]	Scaling Factor (N1)		$T_{\text{detect,NR_Intra}}$ [s] (number of DRX cycles)	$T_{\text{measure,NR_Intra}}$ [s] (number of DRX cycles)	$T_{\text{evaluate,NR_Intra}}$ [s] (number of DRX cycles)
	FR1	FR2 ^{Note1}			
0.32	1	[8]	$11.52 \times N1 \times M2$ ($36 \times N1 \times M2$)	$1.28 \times N1 \times M2$ ($4 \times N1 \times M2$)	$5.12 \times N1 \times M2$ ($16 \times N1 \times M2$)
0.64		[5]	$17.92 \times N1$ ($28 \times N1$)	$1.28 \times N1$ ($2 \times N1$)	$5.12 \times N1$ ($8 \times N1$)
1.28		[4]	$32 \times N1$ ($25 \times N1$)	$1.28 \times N1$ ($1 \times N1$)	$6.4 \times N1$ ($5 \times N1$)
2.56		[TBD]	$58.88 \times N1$ ($23 \times N1$)	$2.56 \times N1$ ($1 \times N1$)	$7.68 \times N1$ ($3 \times N1$)
Note 1: Applies for UE supporting power class 2&3&4. For UE supporting power class 1, $N1 = [8]$ for all DRX cycle length.					
Note 2: $M2 = 1.5$ if SMTC periodicity of measured intra-frequency cell > 20 ms; otherwise $M2=1$.					

6.1.2.19.3 Test Description

6.1.2.19.3.1 Pre-test conditions

System Simulator:

- 3 NR Cells: NR Cell 1, 2 and 4 as specified in TS 38.508-1[4] table 4.4.2-3.
- System information combination NR-2 as defined in TS 38.508-1 [4] clause 4.4.3.1.3 is used in NR cell.

UE:

- None.

Preamble:

- NR Cell 1 is set to "Serving Cell" and NR Cell 2 and NR Cell 4 are set to non-suitable "Off" as defined in TS 38.508-1[4] table 6.2.2.1-3 for FR1 and table 6.2.2.2-2 for FR2.
- The UE is in NR RRC_IDLE state (state 1N-A with PDU session inactive) as defined in TS 38.508-1 [4], table 4.4A.2-1 on NR Cell 1.

6.1.2.19.3.2 Test procedure sequence

Table 6.1.2.19.3.2-1 and Table 6.1.2.19.3.2-2 illustrates the downlink power levels and other changing parameters to be applied for the cells at various time instants of the test execution. The exact instants on which these values shall be applied are described in the texts in this clause.

Table 6.1.2.19.3.2-1: Time instances of cell power level and parameter changes for FR1

	Parameter	Unit	NR Cell 1	NR Cell 2	NR Cell 4	Remark
T1	SS/PBCH SSS EPRE	dBm/SC S	-94	-88	-94	NR Cell 2 becomes the highest ranked cell.
T2	SS/PBCH SSS EPRE	dBm/SC S	-94	-94	-88	NR Cell 4 becomes the highest ranked cell.
T3	SS/PBCH SSS EPRE	dBm/SC S	-88	-94	-94	NR Cell 1 becomes the highest ranked cell.

Table 6.1.2.19.3.2-2: Time instances of cell power level and parameter changes for FR2

	Parameter	Unit	NR Cell 1	NR Cell 2	NR Cell 4	Remark
T1	SS/PBCH SSS EPRE	dBm/SC S	FFS	FFS	FFS	NR Cell 2 becomes the highest ranked cell.
T2	SS/PBCH SSS EPRE	dBm/SC S	FFS	FFS	FFS	NR Cell 4 becomes the highest ranked cell.
T3	SS/PBCH SSS EPRE	dBm/SC S	FFS	FFS	FFS	NR Cell 1 becomes the highest ranked cell.

Table 6.1.2.19.3.2-3: Main behaviour

St	Procedure	Message Sequence		TP	Verdict
		U - S	Message		
1	The SS changes the power level setting according to the row "T1".	-	-	-	-
2	Wait for 40s for FR1 or 136s for FR2 for the UE to perform cell reselection procedure. (Note 1, Note 5)	-	-	-	-
3	The SS changes the power level setting according to the row "T2".	-	-	-	-
4	Wait for 14s for FR1 or 33s for FR2 for the UE to perform cell reselection procedure. (Note 2, Note 6)	-	-	-	-
5	The SS changes the power level setting according to the row "T3".	-	-	-	-
6	Wait for 14s for FR1 or 33s for FR2 for the UE to perform cell reselection procedure. (Note 3, Note 6)	-	-	-	-
7-8	Void	-	-	-	-
9	The SS changes the TAC of NR Cell 2 to 2.	-	-	-	-
10	The SS changes the power level setting according to the row "T1".	-	-	-	-
11	Check: Does the UE send an <i>RRCSetupRequest</i> on NR Cell 2 within 3s? (Note 7)	-->	NR RRC: <i>RRCSetupRequest</i>	2	F
12	Check: Does the UE send an <i>RRCSetupRequest</i> on NR Cell 2 within 6s for FR1 and 27s for FR2 after step 11? (Note 8, Note 9)	-->	NR RRC: <i>RRCSetupRequest</i>	2	P
13-17	Steps 2 to 6 of the mobility registration updating procedure described in TS 38.508-1[4] Table 4.9.5.2.2-1 are performed on NR Cell 2.	-	-	-	-
18	Void	-	-	-	-
19	The SS changes the power level setting according to the row "T2".	-	-	-	-
20-25	Void	-	-	-	-
26	Check: Does the UE send an <i>RRCSetupRequest</i> on NR Cell 4 within 2s? (Note 12)	-->	NR RRC: <i>RRCSetupRequest</i>	1	F
27	Check: Does the UE send an <i>RRCSetupRequest</i> on NR Cell 4 within 7s for FR1 and 26s for FR2 after step 26? (Note 13)	-->	NR RRC: <i>RRCSetupRequest</i>	1	P
28-32	Steps 2 to 6 of the mobility registration updating procedure described in TS 38.508-1[4] Table 4.9.5.2.2-1 are performed on NR Cell 4.	-	-	-	-

Note 1:	N_{CR} (number of cell reselection) is 1.
Note 2:	N_{CR} is 2.
Note 3:	N_{CR} is 3 and the UE enters medium mobility state because number of cell reselections during time period T_{CRmax} equals $N_{CR,M}$.
Note 4:	Void.
Note 5:	The wait time for reselection to a newly detected intra frequency cell is selected to cover $T_{detect,NR_intra}(25*1280ms=32s$ for FR1 and $25*4*1280ms=128s$ for FR2) + $T_{reselection}$ (7s) + 320 ms system information block type scheduling = 39.32s rounded up to 40s for FR1 and 135.32s rounded up to 136s for FR2.
Note 6:	The wait time for reselection to an already detected intra frequency cell is selected to cover $T_{evaluate,NR_intra}(6.4s$ for FR1 and 25.6 for FR2) + $T_{reselection}$ (7s) + 320 ms system information block type scheduling = 13.72s rounded up to 14s for FR1 and 32.92s rounded up to 33s for FR2.
Note 7:	The wait time for evaluating an intra-frequency cell is $T_{reselection}$ after scaling (3.5s). This wait time is rounded down to nearest second (i.e. 3s in this case).
Note 8:	The wait time for cell reselection procedure is selected to cover $T_{evaluate,NR_intra}$ (6.4s for FR1 and 25.6 for FR2) + $T_{reselection}$ after scaling ($7*0.5$) + 320 ms system information block type scheduling = 10.22s rounded up to 11s for FR1 and 29.42s rounded up to 30s for FR2. The actual wait time is 6s which covers 9s - 3s (wait time in step 11) for FR1 and 27s which covers 30s - 3s (wait time in step 11) for FR2.
Note 9:	N_{CR} is 4 and the UE enters high mobility state because number of cell reselections during time period T_{CRmax} greater than $N_{CR,H}$
Note 10:	Void.
Note 11:	Void.
Note 12:	The wait time for evaluating an intra-frequency cell is $T_{reselection}$ after scaling (2s).
Note 13:	The wait time for cell reselection procedure is selected to cover $T_{evaluate,NR_intra}$ (6.4s for FR1 and 25.6 for FR2) + $T_{reselection}$ after scaling ($7*0.25$) + 320 ms system information block type scheduling = 8.47s rounded up to 9s for FR1 and 27.92s rounded up to 28s for FR2. The actual wait time is 7s which covers 9s - 2s (wait time in step 26) for FR1 and 26s which covers 28s - 2s (wait time in step 26) for FR2.

6.1.2.19.3.3 Specific message contents

Table 6.1.2.19.3.3-1: SystemInformationBlockType2 for NR Cell 1, NR Cell 2, and NR Cell 4 (preamble and all steps, Table 6.1.2.19.3.2-3)

Derivation Path: TS 38.508-1 [4], Table 4.6.2-1			
Information Element	Value/remark	Comment	Condition
SIB2 ::= SEQUENCE {			
cellReselectionInfoCommon SEQUENCE			
{			
speedStateReselectionPars SEQUENCE			
{			
MobilityStateParameters SEQUENCE {			
t-Evaluation	s240		
t-HystNormal	s240		
n-CellChangeMedium	3		
n-CellChangeHigh	3		
}			
q-HystSF SEQUENCE {			
sf-Medium	dB0		
sf-High	dB0		
}			
}			
}			
intraFreqCellReselectionInfo SEQUENCE			
{			
t-ReselectionNR	7		
t-ReselectionNR-SF SEQUENCE {			
sf-Medium	oDot50		
sf-High	oDot25		
}			
}			
}			

Table 6.1.2.19.3.3-2: SystemInformationBlockType1 for NR Cell 4 (step 9, Table 6.1.2.19.3.2-3)

Derivation Path: TS 38.508-1 [4], Table 4.6.1-5			
Information Element	Value/remark	Comment	Condition
SIB1 ::= SEQUENCE {			
cellAccessRelatedInfo SEQUENCE {			
PLMN-IdentityInfoList SEQUENCE {			
trackingAreaCode	2		
}			
}			
}			

6.1.2.20 Inter-frequency cell reselection according to cell reselection priority provided by SIBs

6.1.2.20.1 Test Purpose (TP)

(1)

```
with { UE in NR RRC_IDLE state }
ensure that {
  when { UE detects the cell re-selection criteria are met for the cell which belongs to the equal
priority frequency }
  then { UE reselects the cell which belongs to the equal priority frequency }
}
```

(2)

```
with { UE in NR RRC_IDLE state }
ensure that {
  when { UE detects the cell re-selection criteria are met for the cell which belongs to the higher
priority frequency }
  then { UE reselects the cell which belongs to the higher priority frequency }
}
```

(3)

```
with { UE in NR RRC_IDLE state }
ensure that {
  when { UE detects the cell re-selection criteria are met for the cell which belongs to the lower
priority frequency }
  then { UE reselects the cell which belongs to the lower priority frequency }
}
```

6.1.2.20.2 Conformance requirements

References: The conformance requirements covered in the present TC are specified in TS 38.304: clause 5.2.4.1, 5.2.4.2, 5.2.4.5 and 5.2.4.6. Unless otherwise stated these are Rel-15 requirements.

[TS 38.304, clause 5.2.4.1]

Absolute priorities of different NR frequencies or inter-RAT frequencies may be provided to the UE in the system information, in the *RRCRelease* message, or by inheriting from another RAT at inter-RAT cell (re)selection. In the case of system information, an NR frequency or inter-RAT frequency may be listed without providing a priority (i.e. the field *cellReselectionPriority* is absent for that frequency). If priorities are provided in dedicated signalling, the UE shall ignore all the priorities provided in system information. If UE is in *camped on any cell* state, UE shall only apply the priorities provided by system information from current cell, and the UE preserves priorities provided by dedicated signalling and *deprioritisationReq* received in *RRCRelease* unless specified otherwise. When the UE in *camped normally* state, has only dedicated priorities other than for the current frequency, the UE shall consider the current frequency to be the lowest priority frequency (i.e. lower than any of the network configured values).

The UE shall only perform cell reselection evaluation for NR frequencies and inter-RAT frequencies that are given in system information and for which the UE has a priority provided.

In case UE receives *RRCRelease* with *deprioritisationReq*, UE shall consider current frequency and stored frequencies due to the previously received *RRCRelease* with *deprioritisationReq* or all the frequencies of NR to be the lowest priority frequency (i.e. lower than any of the network configured values) while T325 is running irrespective of camped RAT. The UE shall delete the stored deprioritisation request(s) when a PLMN selection is performed on request by NAS (TS 23.122 [9]).

NOTE: UE should search for a higher priority layer for cell reselection as soon as possible after the change of priority. The minimum related performance requirements specified in TS 38.133 [8] are still applicable.

The UE shall delete priorities provided by dedicated signalling when:

- the UE enters a different RRC state; or
- the optional validity time of dedicated priorities (T320) expires; or
- a PLMN selection is performed on request by NAS (TS 23.122 [9]).

NOTE 2: Equal priorities between RATs are not supported.

The UE shall not consider any black listed cells as candidate for cell reselection.

The UE shall inherit the priorities provided by dedicated signalling and the remaining validity time (i.e. T320 in NR and E-UTRA), if configured, at inter-RAT cell (re)selection.

NOTE 3: The network may assign dedicated cell reselection priorities for frequencies not configured by system information.

[TS 38.304, clause 5.2.4.2]

Following rules are used by the UE to limit needed measurements:

- If the serving cell fulfils $S_{rxlev} > S_{intraSearchP}$ and $S_{qual} > S_{intraSearchQ}$, the UE may choose not to perform intra-frequency measurements.
- Otherwise, the UE shall perform intra-frequency measurements.
- The UE shall apply the following rules for NR inter-frequencies and inter-RAT frequencies which are indicated in system information and for which the UE has priority provided as defined in 5.2.4.1:
 - For a NR inter-frequency or inter-RAT frequency with a reselection priority higher than the reselection priority of the current NR frequency, the UE shall perform measurements of higher priority NR inter-frequency or inter-RAT frequencies according to TS 38.133 [8].
 - For a NR inter-frequency with an equal or lower reselection priority than the reselection priority of the current NR frequency and for inter-RAT frequency with lower reselection priority than the reselection priority of the current NR frequency:
 - If the serving cell fulfils $S_{rxlev} > S_{nonIntraSearchP}$ and $S_{qual} > S_{nonIntraSearchQ}$, the UE may choose not to perform measurements of NR inter-frequencies or inter-RAT frequency cells of equal or lower priority;
 - Otherwise, the UE shall perform measurements of NR inter-frequencies or inter-RAT frequency cells of equal or lower priority according to TS 38.133 [8].

[TS 38.304, clause 5.2.4.5]

If *threshServingLowQ* is broadcast in system information and more than 1 second has elapsed since the UE camped on the current serving cell, cell reselection to a cell on a higher priority NR frequency or inter-RAT frequency than the serving frequency shall be performed if:

- A cell of a higher priority NR or EUTRAN RAT/frequency fulfils $S_{qual} > Thresh_{X, HighQ}$ during a time interval $T_{reselection_{RAT}}$

Otherwise, cell reselection to a cell on a higher priority NR frequency or inter-RAT frequency than the serving frequency shall be performed if:

- A cell of a higher priority RAT/ frequency fulfils $S_{rxlev} > Thresh_{X, HighP}$ during a time interval $T_{reselection_{RAT}}$; and

- More than 1 second has elapsed since the UE camped on the current serving cell.

Cell reselection to a cell on an equal priority NR frequency shall be based on ranking for intra-frequency cell reselection as defined in clause 5.2.4.6.

If $thresh_{ServingLowQ}$ is broadcast in system information and more than 1 second has elapsed since the UE camped on the current serving cell, cell reselection to a cell on a lower priority NR frequency or inter-RAT frequency than the serving frequency shall be performed if:

- The serving cell fulfils $S_{qual} < Thresh_{Serving, LowQ}$ and a cell of a lower priority NR or E-UTRAN RAT/ frequency fulfils $S_{qual} > Thresh_{X, LowQ}$ during a time interval $T_{reselection_{RAT}}$.

Otherwise, cell reselection to a cell on a lower priority NR frequency or inter-RAT frequency than the serving frequency shall be performed if:

- The serving cell fulfils $S_{rxlev} < Thresh_{Serving, LowP}$ and a cell of a lower priority RAT/ frequency fulfils $S_{rxlev} > Thresh_{X, LowP}$ during a time interval $T_{reselection_{RAT}}$; and
- More than 1 second has elapsed since the UE camped on the current serving cell.

Cell reselection to a higher priority RAT/frequency shall take precedence over a lower priority RAT/frequency if multiple cells of different priorities fulfil the cell reselection criteria.

If more than one cell meets the above criteria, the UE shall reselect a cell as follows:

- If the highest-priority frequency is an NR frequency, the highest ranked cell among the cells on the highest priority frequency(ies) meeting the criteria according to clause 5.2.4.6;
- If the highest-priority frequency is from another RAT, the highest ranked cell among the cells on the highest priority frequency(ies) meeting the criteria of that RAT.

[TS 38.304, clause 5.2.4.6]

The cell-ranking criterion R_s for serving cell and R_n for neighbouring cells is defined by:

$$R_s = Q_{meas,s} + Q_{hyst} - Q_{offset_{temp}}$$

$$R_n = Q_{meas,n} - Q_{offset} - Q_{offset_{temp}}$$

where:

Q_{meas}	RSRP measurement quantity used in cell reselections.
Q_{offset}	For intra-frequency: Equals to $Q_{offset_{s,n}}$, if $Q_{offset_{s,n}}$ is valid, otherwise this equals to zero. For inter-frequency: Equals to $Q_{offset_{s,n}}$ plus $Q_{offset_{frequency}}$, if $Q_{offset_{s,n}}$ is valid, otherwise this equals to $Q_{offset_{frequency}}$.
$Q_{offset_{temp}}$	Offset temporarily applied to a cell as specified in TS 38.331 [3].

The UE shall perform ranking of all cells that fulfil the cell selection criterion S , which is defined in 5.2.3.2.

The cells shall be ranked according to the R criteria specified above by deriving $Q_{meas,n}$ and $Q_{meas,s}$ and calculating the R values using averaged RSRP results.

If *rangeToBestCell* is not configured, the UE shall perform cell reselection to the highest ranked cell. If this cell is found to be not-suitable, the UE shall behave according to subclause 5.2.4.4.

If *rangeToBestCell* is configured, then the UE shall perform cell reselection to the cell with the highest number of beams above the threshold (i.e. *absThreshSS-BlocksConsolidation*) among the cells whose R value is within *rangeToBestCell* of the R value of the highest ranked cell. If there are multiple such cells, the UE shall perform cell reselection to the highest ranked cell among them. If this cell is found to be not-suitable, the UE shall behave according to subclause 5.2.4.4.

In all cases, the UE shall reselect the new cell, only if the following conditions are met:

- the new cell is better than the serving cell according to the cell reselection criteria specified above during a time interval $T_{\text{reselection}_{\text{RAT}}}$;
- more than 1 second has elapsed since the UE camped on the current serving cell.

6.1.2.20.3 Test description

6.1.2.20.3.1 Pre-test conditions

System Simulator:

- NR Cell 1, NR Cell 3 and NR Cell 6.
- System information combination NR-4 as defined in TS 38.508-1 [4] Table 4.4.3.1.2-1 is used in NR cells.

UE:

None.

Preamble:

- The UE is in state 1N-A on NR Cell 1(serving cell) according to TS 38.508-1 [4] Table 4.4A.2-1.

6.1.2.20.3.2 Test procedure sequence

Table 6.1.2.20.3.2-1/2 illustrates the downlink power levels and other changing parameters to be applied for the NR cells at various time instants of the test execution. The exact instants on which these values shall be applied are described in the texts in this clause. The configuration "T0" indicates the initial conditions. Subsequent configurations marked "T1", "T2" and "T3" are applied at the points indicated in the Main behaviour description in Table 6.1.2.20.3.2-3.

Table 6.1.2.20.3.2-1: Time instances of cell power level and parameter changes for FR1

	Parameter	Unit	NR Cell 1	NR Cell 3	NR Cell 6	Remark
T0	SS/PBCH SSS EPRE	dBm/SCS	-88	Off	Off	The power level values are assigned to ensure the UE registered on NR Cell 1.
T1	SS/PBCH SSS EPRE	dBm/SCS	-88	-78	Off	The power level values are assigned to satisfy $R_{\text{NR Cell 1}} < R_{\text{NR Cell 3}}$.
T2	SS/PBCH SSS EPRE	dBm/SCS	Off	-78	-78	The power level values are assigned to satisfy $S_{\text{rxlev}_{\text{NR Cell 1}}} < 0$ and $S_{\text{rxlev}_{\text{NR Cell 6}}} > \text{Thresh}_{\text{NR Cell 6, high}}$.
T3	SS/PBCH SSS EPRE	dBm/SCS	Off	-78	-98	The power level values are assigned to satisfy $S_{\text{rxlev}_{\text{NR Cell 6}}} < \text{Thresh}_{\text{servicing, low}}$ and $S_{\text{rxlev}_{\text{NR Cell 3}}} > \text{Thresh}_{\text{NR Cell 3, low}}$, $S_{\text{rxlev}_{\text{NR Cell 1}}} < 0$.

Note: Power level "Off" is defined in TS38.508-1 [4] Table 6.2.2.1-3.

Table 6.1.2.20.3.2-2: Time instances of cell power level and parameter changes for FR2

	Parameter	Unit	NR Cell 1	NR Cell 3	NR Cell 6	Remark
T0	SS/PBCH SSS EPRE	dBm/SCS	-91	Off	Off	The power level values are assigned to ensure the UE registered on NR Cell 1.
T1	SS/PBCH SSS EPRE	dBm/SCS	-91	-82	Off	The power level values are assigned to satisfy $R_{\text{NR Cell 1}} < R_{\text{NR Cell 3}}$.
T2	SS/PBCH SSS EPRE	dBm/SCS	Off	-82	-82	The power level values are assigned to satisfy $S_{\text{rxlev}_{\text{NR Cell 1}}} < 0$ and $S_{\text{rxlev}_{\text{NR Cell 6}}} > \text{Thresh}_{\text{NR Cell 6, high}}$.
T3	SS/PBCH SSS EPRE	dBm/SCS	Off	-82	-100	The power level values are assigned to satisfy $S_{\text{rxlev}_{\text{NR Cell 6}}} < \text{Thresh}_{\text{servicing, low}}$ and $S_{\text{rxlev}_{\text{NR Cell 3}}} > \text{Thresh}_{\text{NR Cell 3, low}}$, $S_{\text{rxlev}_{\text{NR Cell 1}}} < 0$.

Table 6.1.2.20.3.2-3: Main behaviour

St	Procedure	Message Sequence		TP	Verdict
		U - S	Message		
1	The SS changes NR Cell 3 SS PBCH SSS EPRE level according to the row "T1" in table 6.1.2.20.3.2-1/2.	-	-	-	-
2	Wait for 66[FR1]/258[FR2] seconds to allow UE to recognise the change.	-	-	-	-
3	Check: Does the test result of generic test procedure in TS 38.508-1 [4] Table 4.9.4.2.2-1 indicate that the UE is camped on NR Cell 3?	-	-	1	-
4	The SS changes NR Cell 1 and NR Cell 6 SSS levels according to the row "T2" in table 6.1.2.20.3.2-1/2.	-	-	-	-
5	Wait for 34[FR1]/130[FR2] seconds to allow UE to recognise the change.	-	-	-	-
6	Check: Does the test result of generic test procedure in TS 38.508-1 [4] Table 4.9.4.2.2-1 indicate that the UE is camped on NR Cell 6?	-	-	2	-
7	The SS changes NR Cell 6 SSS level according to the row "T3" in table 6.1.2.20.3.2-1/2.	-	-	-	-
8	Wait for 8[FR1]/27[FR2] seconds to allow UE to recognise the change.	-	-	-	-
9	Check: Does the test result of generic test procedure in TS 38.508-1 [4] Table 4.9.4.2.2-1 indicate that the UE is camped on NR Cell 3?	-	-	3	-
Note: The wait time at steps 2 and 5 is $K_{\text{carrier}} \cdot T_{\text{detect, NR_Inter}}$ and at Step 8 it is $K_{\text{carrier}} \cdot T_{\text{evaluate, NR_Inter}}$ (as per TS 38.133 [30], clause 4.2.2.4) plus the time to read the system information $T_{\text{SI-NR}}$.					

6.1.2.20.3.3 Specific message contents

Table 6.1.2.20.3.3-1: Conditions for specific message contents in Tables below

Condition	Explanation
NR Cell 1	This condition applies to system information transmitted on NR Cell 1.
NR Cell 3	This condition applies to system information transmitted on NR Cell 3.
NR Cell 6	This condition applies to system information transmitted on NR Cell 6.

Table 6.1.2.20.3.3-2: SIB2 of NR Cell 6 (preamble and all steps, Table 6.1.2.20.3.2-3)

Derivation Path: TS 38.508-1 [4], Table 4.6.2-1			
Information Element	Value/remark	Comment	Condition
SIB2 ::= SEQUENCE {			
cellReselectionServingFreqInfo			
SEQUENCE {			
threshServingLowP	10	20 dB	
cellReselectionPriority	5		
}			
}			

Table 6.1.2.20.3.3-3: SIB4 of NR Cell 1, NR Cell 3 and NR Cell 6 (preamble and all steps, Table 6.1.2.20.3.2-3)

Derivation Path: TS 38.508-1 [4], Table 4.6.2-3			
Information Element	Value/remark	Comment	Condition
SIB4 ::= SEQUENCE {			
interFreqCarrierFreqList SEQUENCE	2 entry		
SIZE (1..maxFreq) OF SEQUENCE {			
dl-CarrierFreq[1]	Same downlink ARFCN as used for NR Cell 6		NR Cell 1
	Same downlink ARFCN as used for NR Cell 6		NR Cell 3
	Same downlink ARFCN as used for NR Cell 3		NR Cell 6
threshX-HighP[1]	10	20 dB	NR Cell 3 and FR1
	9	18 dB	NR Cell 3 and FR2
cellReselectionPriority[1]	5		NR Cell 1
	5		NR Cell 3
dl-CarrierFreq[2]	Same downlink ARFCN as used for NR Cell 3		NR Cell 1
cellReselectionPriority[2]	4		NR Cell 1
}			
}			

6.1.2.21 Cell reselection, SIntra SearchQ and SnonIntraSearchQ

6.1.2.21.1 Test Purpose (TP)

(1)

```
with { UE in NR RRC_IDLE state, and the UE is not in high mobility state }
ensure that {
  when { SIntraSearchQ is non-zero in system information }
  then { UE perform measurement and reselects the highest ranked cell upon Squal < SIntraSearchQ }
}
```

(2)

```
with { UE in NR RRC_IDLE state, and the UE is not in high mobility state }
ensure that {
  when { SnonIntraSearchQ is non-zero in system information }
  then { UE perform measurement and reselects the cell which belong to the equal priority
frequency cell upon Squal < SnonIntraSearchQ }
}
```

(3)

```
with { UE in NR RRC_IDLE state, and the UE is not in high mobility state }
ensure that {
  when { SnonIntraSearchQ is non-zero in system information }
  then { UE perform measurement and reselects the cell which belong to the high priority frequency
cell upon Squal > SnonIntraSearchQ }
}
```

6.1.2.21.2 Conformance requirements

References: The conformance requirements covered in the present TC are specified in TS 38.304: clause 5.2.4.1, 5.2.4.2, 5.2.4.5, 5.2.4.6 and 5.2.4.7. Unless otherwise stated these are Rel-15 requirements.

[TS 38.304, clause 5.2.4.1]

Absolute priorities of different NR frequencies or inter-RAT frequencies may be provided to the UE in the system information, in the *RRCRelease* message, or by inheriting from another RAT at inter-RAT cell (re)selection. In the case

of system information, an NR frequency or inter-RAT frequency may be listed without providing a priority (i.e. the field *cellReselectionPriority* is absent for that frequency). If priorities are provided in dedicated signalling, the UE shall ignore all the priorities provided in system information. If UE is in *camped on any cell* state, UE shall only apply the priorities provided by system information from current cell, and the UE preserves priorities provided by dedicated signalling and *deprioritisationReq* received in *RRCRelease* unless specified otherwise. When the UE in camped normally state, has only dedicated priorities other than for the current frequency, the UE shall consider the current frequency to be the lowest priority frequency (i.e. lower than any of the network configured values).

The UE shall only perform cell reselection evaluation for NR frequencies and inter-RAT frequencies that are given in system information and for which the UE has a priority provided.

In case UE receives *RRCRelease* with *deprioritisationReq*, UE shall consider current frequency and stored frequencies due to the previously received *RRCRelease* with *deprioritisationReq* or all the frequencies of NR to be the lowest priority frequency (i.e. lower than any of the network configured values) while T325 is running irrespective of camped RAT. The UE shall delete the stored deprioritisation request(s) when a PLMN selection is performed on request by NAS (TS 23.122 [9]).

NOTE: UE should search for a higher priority layer for cell reselection as soon as possible after the change of priority. The minimum related performance requirements specified in TS 38.133 [8] are still applicable.

The UE shall delete priorities provided by dedicated signalling when:

- the UE enters a different RRC state; or
- the optional validity time of dedicated priorities (T320) expires; or
- a PLMN selection is performed on request by NAS (TS 23.122 [9]).

NOTE 2: Equal priorities between RATs are not supported.

The UE shall not consider any black listed cells as candidate for cell reselection.

The UE shall inherit the priorities provided by dedicated signalling and the remaining validity time (i.e. T320 in NR and E-UTRA), if configured, at inter-RAT cell (re)selection.

NOTE 3: The network may assign dedicated cell reselection priorities for frequencies not configured by system information.

[TS 38.304, clause 5.2.4.2]

Following rules are used by the UE to limit needed measurements:

- If the serving cell fulfils $S_{rxlev} > S_{intraSearchP}$ and $S_{qual} > S_{intraSearchQ}$, the UE may choose not to perform intra-frequency measurements.
- Otherwise, the UE shall perform intra-frequency measurements.
- The UE shall apply the following rules for NR inter-frequencies and inter-RAT frequencies which are indicated in system information and for which the UE has priority provided as defined in 5.2.4.1:
 - For a NR inter-frequency or inter-RAT frequency with a reselection priority higher than the reselection priority of the current NR frequency, the UE shall perform measurements of higher priority NR inter-frequency or inter-RAT frequencies according to TS 38.133 [8].
 - For a NR inter-frequency with an equal or lower reselection priority than the reselection priority of the current NR frequency and for inter-RAT frequency with lower reselection priority than the reselection priority of the current NR frequency:
 - If the serving cell fulfils $S_{rxlev} > S_{nonIntraSearchP}$ and $S_{qual} > S_{nonIntraSearchQ}$, the UE may choose not to perform measurements of NR inter-frequencies or inter-RAT frequency cells of equal or lower priority;
 - Otherwise, the UE shall perform measurements of NR inter-frequencies or inter-RAT frequency cells of equal or lower priority according to TS 38.133 [8].

[TS 38.304, clause 5.2.4.5]

If *threshServingLowQ* is broadcast in system information and more than 1 second has elapsed since the UE camped on the current serving cell, cell reselection to a cell on a higher priority NR frequency or inter-RAT frequency than the serving frequency shall be performed if:

- A cell of a higher priority NR or EUTRAN RAT/frequency fulfils $S_{qual} > Thresh_{X, HighQ}$ during a time interval $T_{reselection_{RAT}}$

Otherwise, cell reselection to a cell on a higher priority NR frequency or inter-RAT frequency than the serving frequency shall be performed if:

- A cell of a higher priority RAT/ frequency fulfils $S_{rxlev} > Thresh_{X, HighP}$ during a time interval $T_{reselection_{RAT}}$; and
- More than 1 second has elapsed since the UE camped on the current serving cell.

Cell reselection to a cell on an equal priority NR frequency shall be based on ranking for intra-frequency cell reselection as defined in clause 5.2.4.6.

If *threshServingLowQ* is broadcast in system information and more than 1 second has elapsed since the UE camped on the current serving cell, cell reselection to a cell on a lower priority NR frequency or inter-RAT frequency than the serving frequency shall be performed if:

- The serving cell fulfils $S_{qual} < Thresh_{Serving, LowQ}$ and a cell of a lower priority NR or E-UTRAN RAT/ frequency fulfils $S_{qual} > Thresh_{X, LowQ}$ during a time interval $T_{reselection_{RAT}}$.

Otherwise, cell reselection to a cell on a lower priority NR frequency or inter-RAT frequency than the serving frequency shall be performed if:

- The serving cell fulfils $S_{rxlev} < Thresh_{Serving, LowP}$ and a cell of a lower priority RAT/ frequency fulfils $S_{rxlev} > Thresh_{X, LowP}$ during a time interval $T_{reselection_{RAT}}$; and
- More than 1 second has elapsed since the UE camped on the current serving cell.

Cell reselection to a higher priority RAT/frequency shall take precedence over a lower priority RAT/frequency if multiple cells of different priorities fulfil the cell reselection criteria.

If more than one cell meets the above criteria, the UE shall reselect a cell as follows:

- If the highest-priority frequency is an NR frequency, the highest ranked cell among the cells on the highest priority frequency(ies) meeting the criteria according to clause 5.2.4.6;
- If the highest-priority frequency is from another RAT, the highest ranked cell among the cells on the highest priority frequency(ies) meeting the criteria of that RAT.

[TS 38.304, clause 5.2.4.6]

The cell-ranking criterion R_s for serving cell and R_n for neighbouring cells is defined by:

$$R_s = Q_{meas,s} + Q_{hyst} - Q_{offset_{temp}}$$

$$R_n = Q_{meas,n} - Q_{offset} - Q_{offset_{temp}}$$

where:

Q_{meas}	RSRP measurement quantity used in cell reselections.
Q_{offset}	For intra-frequency: Equals to $Q_{offset_{s,n}}$, if $Q_{offset_{s,n}}$ is valid, otherwise this equals to zero. For inter-frequency: Equals to $Q_{offset_{s,n}}$ plus $Q_{offset_{frequency}}$, if $Q_{offset_{s,n}}$ is valid, otherwise this equals to $Q_{offset_{frequency}}$.
$Q_{offset_{temp}}$	Offset temporarily applied to a cell as specified in TS 38.331 [3].

The UE shall perform ranking of all cells that fulfil the cell selection criterion S , which is defined in 5.2.3.2.

The cells shall be ranked according to the R criteria specified above by deriving $Q_{meas,n}$ and $Q_{meas,s}$ and calculating the R values using averaged RSRP results.

If *rangeToBestCell* is not configured, the UE shall perform cell reselection to the highest ranked cell. If this cell is found to be not-suitable, the UE shall behave according to subclause 5.2.4.4.

If *rangeToBestCell* is configured, then the UE shall perform cell reselection to the cell with the highest number of beams above the threshold (i.e. *absThreshSS-BlocksConsolidation*) among the cells whose R value is within *rangeToBestCell* of the R value of the highest ranked cell. If there are multiple such cells, the UE shall perform cell reselection to the highest ranked cell among them. If this cell is found to be not-suitable, the UE shall behave according to subclause 5.2.4.4.

In all cases, the UE shall reselect the new cell, only if the following conditions are met:

- the new cell is better than the serving cell according to the cell reselection criteria specified above during a time interval $T_{\text{reselectionRAT}}$;
- more than 1 second has elapsed since the UE camped on the current serving cell.

[TS 38.304, clause 5.2.4.7]

5.2.4.7.0 General reselection parameters

Cell reselection parameters are broadcast in system information and are read from the serving cell as follows:

absThreshSS-BlocksConsolidation

This specifies minimum threshold of the beam which can be used for selection of the highest ranked cell, if *rangeToBestCell* is configured.

cellReselectionPriority

This specifies the absolute priority for NR frequency or E-UTRAN frequency.

cellReselectionSubPriority

This specifies the fractional priority value added to *cellReselectionPriority* for NR frequency or E-UTRAN frequency.

Qoffset_{s,n}

This specifies the offset between the two cells.

Qoffset_{frequency}

Frequency specific offset for equal priority NR frequencies.

Qhyst

This specifies the hysteresis value for ranking criteria.

Qoffset_{temp}

This specifies the additional offset to be used for cell selection and re-selection. It is temporarily used in case the RRC Connection Establishment fails on the cell as specified in TS 38.331 [3].

Qqualmin

This specifies the minimum required quality level in the cell in dB.

Qrxlevmin

This specifies the minimum required Rx level in the cell in dBm.

Qrxlevminoffsetcell

This specifies the cell specific Rx level offset in dB to *Qrxlevmin*.

Qqualminoffsetcell

This specifies the cell specific quality level offset in dB to *Qqualmin*.

rangeToBestCell

This specifies the R value range which the cells whose R value is within the range can be a candidate for the highest ranked cell.

Treselection_{RAT}

This specifies the cell reselection timer value. For each target NR frequency and for each RAT other than NR, a specific value for the cell reselection timer is defined, which is applicable when evaluating reselection within NR or towards other RAT (i.e. Treselection_{RAT} for NR is Treselection_{NR}, for E-UTRAN Treselection_{EUTRA}).

NOTE: Treselection_{RAT} is not broadcast in system information but used in reselection rules by the UE for each RAT.

Treselection_{NR}

This specifies the cell reselection timer value Treselection_{RAT} for NR. The parameter can be set per NR frequency as specified in TS 38.331 [3].

Treselection_{EUTRA}

This specifies the cell reselection timer value Treselection_{RAT} for E-UTRAN.

Thresh_{X, HighP}

This specifies the Srxlev threshold (in dB) used by the UE when reselecting towards a higher priority RAT/ frequency than the current serving frequency. Each frequency of NR and E-UTRAN might have a specific threshold.

Thresh_{X, HighQ}

This specifies the Squal threshold (in dB) used by the UE when reselecting towards a higher priority RAT/ frequency than the current serving frequency. Each frequency of NR and E-UTRAN might have a specific threshold.

Thresh_{X, LowP}

This specifies the Srxlev threshold (in dB) used by the UE when reselecting towards a lower priority RAT/ frequency than the current serving frequency. Each frequency of NR and E-UTRAN might have a specific threshold.

Thresh_{X, LowQ}

This specifies the Squal threshold (in dB) used by the UE when reselecting towards a lower priority RAT/ frequency than the current serving frequency. Each frequency of NR and E-UTRAN might have a specific threshold.

Thresh_{Serving, LowP}

This specifies the Srxlev threshold (in dB) used by the UE on the serving cell when reselecting towards a lower priority RAT/ frequency.

Thresh_{Serving, LowQ}

This specifies the Squal threshold (in dB) used by the UE on the serving cell when reselecting towards a lower priority RAT/ frequency.

S_{IntraSearchP}

This specifies the Srxlev threshold (in dB) for intra-frequency measurements.

S_{IntraSearchQ}

This specifies the Squal threshold (in dB) for intra-frequency measurements.

S_{nonIntraSearchP}

This specifies the Srxlev threshold (in dB) for NR inter-frequency and inter-RAT measurements.

S_{nonIntraSearchQ}

This specifies the Squal threshold (in dB) for NR inter-frequency and inter-RAT measurements.

5.2.4.7.1 Speed dependent reselection parameters

Speed dependent reselection parameters are broadcast in system information and are read from the serving cell as follows:

T_{CRmax}

This specifies the duration for evaluating allowed amount of cell reselection(s).

$N_{CR,M}$

This specifies the maximum number of cell reselections to enter Medium-mobility state.

$N_{CR,H}$

This specifies the maximum number of cell reselections to enter High-mobility state.

$T_{CRmaxHyst}$

This specifies the additional time period before the UE can enter Normal-mobility state.

Speed dependent ScalingFactor for Qhyst

This specifies scaling factor for Qhyst in *sf-High* for High-mobility state and *sf-Medium* for Medium-mobility state.

Speed dependent ScalingFactor for Treselection_{NR}

This specifies scaling factor for Treselection_{NR} in *sf-High* for High-mobility state and *sf-Medium* for Medium-mobility state.

Speed dependent ScalingFactor for Treselection_{EUTRA}

This specifies scaling factor for Treselection_{EUTRA} in *sf-High* for High-mobility state and *sf-Medium* for Medium-mobility state.

6.1.2.21.3 Test description

6.1.2.21.3.1 Pre-test conditions

System Simulator:

- NR Cell 1, NR Cell 2 and NR Cell 3
- System information combination NR-4 as defined in TS 38.508-1 [4] Table 4.4.3.1.2-1, and message contents defined in clause 4.6.1 and clause 4.6.2 with QBASED condition is used in NR cells.

UE:

None.

Preamble:

- The UE is in state 1N-A on NR Cell 1(serving cell) according to TS 38.508-1 [4] Table 4.4A.2-1.

6.1.2.21.3.2 Test procedure sequence

Table 6.1.2.21.3.2-1/2 illustrates the downlink power levels and other changing parameters to be applied for the NR cells at various time instants of the test execution. The exact instants on which these values shall be applied are described in the texts in this clause. The configuration "T0" indicates the initial conditions. Subsequent configurations marked "T1", "T2", "T3" and "T4" are applied at the points indicated in the Main behaviour description in Table 6.1.2.21.3.2-3.

Table 6.1.2.21.3.2-1: Time instances of cell power level and parameter changes for FR1

	Parameter	Unit	NR Cell 1	NR Cell 2	NR Cell 3	Remark
T0	SS/PBCH SSS EPRE	dBm/SCS	-88	Off	Off	The power level values are assigned to ensure the UE registered on NR Cell 1.
T1	SS/PBCH SSS EPRE	dBm/SCS	-94	-80	-118	Squal of NR Cell 1 is less than $S_{\text{IntraSearchQ}}$.
	RSRQ	dB	-13.78	-10.96	-34.81	
	Q_{rxlevmin}	dBm	-110	-110	-110	
	Qqualmin	dB	-20	-20	-20	
	$S_{\text{IntraSearchQ}}$	dB	20	20	20	
	Noc	dBm/SCS	-94	-94	-94	
	Srxlev	dB	16	30	-8	
	Squal	dB	6.22	9.04	-14.81	
T2	SS/PBCH SSS EPRE	dBm/SCS	-118	-94	-80	Squal of NR Cell 2 is less than $S_{\text{nonIntraSearchQ}}$.
	RSRQ	dB	-34.81	-13.78	-10.96	
	Q_{rxlevmin}	dBm	-110	-110	-110	
	Qqualmin	dB	-20	-20	-20	
	$S_{\text{nonIntraSearchQ}}$	dB	20	20	20	
	Noc	dBm/SCS	-94	-94	-94	
	Srxlev	dB	-8	16	30	
	Squal	dB	-14.81	6.22	9.04	
T3	SS/PBCH SSS EPRE	dBm/SCS	-118	-118	-80	
	RSRQ	dB	-34.81	-34.81	-10.96	
	Q_{rxlevmin}	dBm	-110	-110	-110	
	Qqualmin	dB	-20	-20	-20	
	$S_{\text{nonIntraSearchQ}}$	dB	20	20	2	
	Noc	dBm/SCS	-94	-94	-94	
	Srxlev	dB	-8	-8	30	
	Squal	dB	-14.81	-14.81	9.04	
T4	SS/PBCH SSS EPRE	dBm/SCS	-80	-118	-80	Squal of NR Cell 3 is greater than $S_{\text{nonIntraSearchQ}}$ but NR Cell 1 is high priority cell.
	RSRQ	dB	-10.96	-34.81	-10.96	
	Q_{rxlevmin}	dBm	-110	-110	-110	
	Qqualmin	dB	-20	-20	-20	
	$S_{\text{nonIntraSearchQ}}$	dB	20	20	2	
	Noc	dBm/SCS	-94	-94	-94	
	Srxlev	dB	30	-8	30	
	Squal	dB	9.04	-14.81	9.04	
Note: Power level "Off" is defined in TS38.508-1 [4] Table 6.2.2.1-3.						

Table 6.1.2.21.3.2-2: Time instances of cell power level and parameter changes for FR2

	Parameter	Unit	NR Cell 1	NR Cell 2	NR Cell 3	Remark
T0	SS/PBCH SSS EPRE	dBm/SCS	FFS	Off	Off	The power level values are assigned to ensure the UE registered on NR Cell 1.
T1	SS/PBCH SSS EPRE	dBm/SCS	FFS	FFS	FFS	Squal of NR Cell 1 is less than $S_{\text{IntraSearchQ}}$.
	RSRQ	dB	FFS	FFS	FFS	
	Q_{rxlevmin}	dBm	-	-	-	
			$110 + D_{\text{el}}(N_{\text{Rf1}})$	$110 + D_{\text{el}}(N_{\text{Rf1}})$	$110 + D_{\text{el}}(N_{\text{Rf1}})$	
	Qqualmin	dB	-20	-20	-20	
	$S_{\text{IntraSearchQ}}$	dB	20	20	20	
	Noc	dBm/SCS	FFS	FFS	FFS	
	Srxlev	dB	FFS	FFS	FFS	
T2	SS/PBCH SSS EPRE	dBm/SCS	FFS	FFS	FFS	Squal of NR Cell 2 is less than $S_{\text{nonIntraSearchQ}}$.
	RSRQ	dB	FFS	FFS	FFS	
	Q_{rxlevmin}	dBm	-	-	-	
			$110 + D_{\text{el}}(N_{\text{Rf1}})$	$110 + D_{\text{el}}(N_{\text{Rf1}})$	$110 + D_{\text{el}}(N_{\text{Rf1}})$	
	Qqualmin	dB	-20	-20	-20	
	$S_{\text{nonIntraSearchQ}}$	dB	20	20	20	
	Noc	dBm/SCS	FFS	FFS	FFS	
	Srxlev	dB	FFS	FFS	FFS	
T3	SS/PBCH SSS EPRE	dBm/SCS	FFS	FFS	FFS	
	RSRQ	dB	FFS	FFS	FFS	
	Q_{rxlevmin}	dBm	-	-	-	
			$110 + D_{\text{el}}(N_{\text{Rf1}})$	$110 + D_{\text{el}}(N_{\text{Rf1}})$	$110 + D_{\text{el}}(N_{\text{Rf1}})$	
	Qqualmin	dB	-20	-20	-20	
	$S_{\text{nonIntraSearchQ}}$	dB	20	20	2	
	Noc	dBm/SCS	FFS	FFS	FFS	
	Srxlev	dB	FFS	FFS	FFS	
T4	SS/PBCH SSS EPRE	dBm/SCS	FFS	FFS	FFS	Squal of NR Cell 3 is greater than $S_{\text{nonIntraSearchQ}}$ but NR Cell 1 is high priority cell.
	RSRQ	dB	FFS	FFS	FFS	
	Srxlev	dB	FFS	FFS	FFS	
	Q_{rxlevmin}	dBm	-	-	-	
			$110 + D_{\text{el}}(N_{\text{Rf1}})$	$110 + D_{\text{el}}(N_{\text{Rf1}})$	$110 + D_{\text{el}}(N_{\text{Rf1}})$	
	Qqualmin	dB	-20	-20	-20	
	$S_{\text{nonIntraSearchQ}}$	dB	20	20	2	
	Noc	dBm/SCS	FFS	FFS	FFS	
Squal	dB	FFS	FFS	FFS		
Note: The uncertain downlink signal level is specified in TS 38.508-1[4] section FFS						

Table 6.1.2.21.3.2-3: Main behaviour

St	Procedure	Message Sequence		TP	Verdict
		U - S	Message		
1	The SS re-adjusts the SS/PBCH EPRE levels according to row "T1" in table 6.1.2.21.3.2-1/2.	-	-	-	-
2	Wait for 34 seconds to allow UE to recognise the change.	-	-	-	-
3	Check: Does the test result of generic test procedure in TS 38.508-1 [4] Table 4.9.4-1 indicate that the UE is camped on NR Cell 2?	-	-	1	P
4	The SS re-adjusts the SSS levels according to row "T2" in table 6.1.2.21.3.2-1/2.	-	-	-	-
5	Wait for 34 seconds to allow UE to recognise the change.	-	-	-	-
6	Check: Does the test result of generic test procedure in TS 38.508-1 [4] Table 4.9.4-1 indicate that the UE is camped on NR Cell 3?	-	-	2	P
6A	The SS re-adjusts the SSS levels according to row "T3" in table 6.1.2.21.3.2-1/2.	-	-	-	-
7	Void.				
8	The SS changes the $S_{nonIntraSearchQ}$ for NR Cell 3 according to row "T3" in table 6.1.2.21.3.2-1/2, The <i>ValueTag</i> of <i>SIB2</i> in the <i>SI-SchedulingInfo</i> of <i>SIB1</i> is increased on NR Cell 3.	-	-	-	-
8A	The SS notifies the UE of change of System Information on NR Cell 3 by send Short Message on PDCCH using P-RNTI.	<--	NR RRC: <i>Paging</i>	-	-
9	Wait for 2.1* modification period to allow the new system information to take effect.	-	-	-	-
10	The SS re-adjusts the SSS levels according to row "T4" in table 6.1.2.21.3.2-1/2.	-	-	-	-
11	Wait for 120 seconds to allow UE to recognise the change.	-	-	-	-
12	Check: Does the test result of generic test procedure in TS 38.508-1 [4] Table 4.9.4-1 indicate that the UE is camped on NR Cell 1?	-	-	3	P

6.1.2.21.3.3

Specific message contents

Table 6.1.2.21.3.3-1: Conditions for specific message contents in Tables below

Condition	Explanation
NR Cell 1	This condition applies to system information transmitted on NR Cell 1.
NR Cell 2	This condition applies to system information transmitted on NR Cell 2.
NR Cell 3	This condition applies to system information transmitted on NR Cell 3.

Table 6.1.2.21.3.3-2: SIB2 of NR Cell 1, NR Cell 2 and NR Cell 3 (preabmlie, Table 6.1.2.21.3.2-3)

Derivation Path: TS 38.508-1 [4], Table 4.6.2-1			
Information Element	Value/remark	Comment	Condition
SIB2 ::= SEQUENCE {			
cellReselectionServingFreqInfo			
SEQUENCE {			
s-NonIntraSearchP	0	0 dB	
s-NonIntraSearchQ	20	20 dB	
cellReselectionPriority	5		NR Cell 1
cellReselectionPriority	1		NR Cell 2 and Cell 3
}			
intraFreqCellReselectionInfo			
SEQUENCE {			
s-IntraSearchP	0	0 dB	
s-IntraSearchQ	20	20 dB	
}			
}			

Table 6.1.2.21.3.3-3: SIB4 of NR Cell 2 and NR Cell 3 (preabmlie and all steps, Table 6.1.2.21.3.2-3)

Derivation Path: TS 38.508-1 [4], Table 4.6.2-3			
Information Element	Value/remark	Comment	Condition
SIB4 ::= SEQUENCE {			
interFreqCarrierFreqList	1 entry		
SEQUENCE (SIZE (1..maxFreq)) OF			
InterFreqCarrierFreqInfo {			
InterFreqCarrierFreqInfo[1]		entry 1	
SEQUENCE {			
dl-CarrierFreq	Same downlink ARFCN as used for NR Cell 3		NR Cell 2
dl-CarrierFreq	Same downlink ARFCN as used for NR Cell 1		NR Cell 3
}			
t-ReselectionNR	1		
threshX-HighP	7	14 dBm	NR Cell 3
threshX-Q			NR Cell 3
SEQUENCE {			
threshX-HighQ	20		
threshX-LowQ	5		
}			
cellReselectionPriority	5		NR Cell 3
cellReselectionPriority	1		NR Cell 2
}			
}			

Table 6.1.2.21.3.3-4: SIB1 of NR Cell 3 (step 8, Table 6.1.2.21.3.2-3)

Derivation Path: TS 38.508-1 [4], Table 4.6.1-28			
Information Element	Value/remark	Comment	Condition
SIB1 ::= SEQUENCE {			
si-SchedulingInfo	SI-SchedulingInfo		
}			

Table 6.1.2.21.3.3-4a: SIB4 of NR Cell 3 (step 8, Table 6.1.2.21.3.2-3)

Derivation Path: TS 38.508-1 [4], Table 4.6.2-3			
Information Element	Value/remark	Comment	Condition
SIB4 ::= SEQUENCE {			
interFreqCarrierFreqList SEQUENCE (SIZE (1..maxFreq)) OF InterFreqCarrierFreqInfo {	1 entry		
InterFreqCarrierFreqInfo[1] SEQUENCE {		entry 1	
threshX-Q SEQUENCE {			NR Cell 3
threshX-HighQ	5		
threshX-LowQ	5		
}			
}			
}			
}			

Table 6.1.2.21.3.3-5: SI-SchedulingInfo (si-SchedulingInfo in Table 6.1.2.21.3.3-4)

Derivation Path: TS 38.508-1 [4], Table 4.6.3-173			
Information Element	Value/remark	Comment	Condition
SI-SchedulingInfo ::= SEQUENCE {			
schedulingInfoList SEQUENCE (SIZE(1..maxSI-Message)) OF SchedulingInfo {	1 entry		
SchedulingInfo[1] SEQUENCE {		entry 1	
sib-MappingInfo SEQUENCE (SIZE (1..maxSIB)) OF SIB-TypeInfo {	2 entries		
SIB-TypeInfo[1] SEQUENCE {		entry 1	
type	sibType2		
valueTag	1		
}			
SIB-TypeInfo[2] SEQUENCE {		entry 2	
type	sibType4		
valueTag	1		
}			
}			
}			
}			
}			

Table 6.1.2.21.3.3-6: SIB2 of NR Cell 3 (step 8, Table 6.1.2.21.3.2-3)

Derivation Path: TS 38.508-1 [4], Table 4.6.2-1			
Information Element	Value/remark	Comment	Condition
SIB2 ::= SEQUENCE {			
cellReselectionServingFreqInfo SEQUENCE {			
s-NonIntraSearchQ	2	2 dB	
}			
}			

6.1.2.22 Inter-frequency cell reselection based on common priority information with parameters ThreshX,HighQ, ThreshX,LowQ and ThreshServing,LowQ

6.1.2.22.1 Test Purpose (TP)

(1)

with { UE in NR RRC_IDLE state }

```

ensure that {
  when { UE detects the cell re-selection criteria are met for the cell which belongs to the higher
priority frequency }
  then { UE reselects the cell which belongs to the higher priority frequency }
}

```

(2)

```

with { UE in NR RRC_IDLE state }
ensure that {
  when { UE detects the cell re-selection criteria are met for the cell which belongs to the lower
priority frequency }
  then { UE reselects the cell which belongs to the lower priority frequency }
}

```

6.1.2.22.2 Conformance requirements

References: The conformance requirements covered in the present TC are specified in TS 38.304: clause 5.2.4.5, and 5.2.4.7. Unless otherwise stated these are Rel-15 requirements.

[TS 38.304, clause 5.2.4.5]

If *threshServingLowQ* is broadcast in system information and more than 1 second has elapsed since the UE camped on the current serving cell, cell reselection to a cell on a higher priority NR frequency or inter-RAT frequency than the serving frequency shall be performed if:

- A cell of a higher priority NR or EUTRAN RAT/frequency fulfils $S_{qual} > Thresh_{X, HighQ}$ during a time interval $T_{reselection_{RAT}}$

Otherwise, cell reselection to a cell on a higher priority NR frequency or inter-RAT frequency than the serving frequency shall be performed if:

- A cell of a higher priority RAT/ frequency fulfils $S_{rxlev} > Thresh_{X, HighP}$ during a time interval $T_{reselection_{RAT}}$; and
- More than 1 second has elapsed since the UE camped on the current serving cell.

Cell reselection to a cell on an equal priority NR frequency shall be based on ranking for intra-frequency cell reselection as defined in clause 5.2.4.6.

If *threshServingLowQ* is broadcast in system information and more than 1 second has elapsed since the UE camped on the current serving cell, cell reselection to a cell on a lower priority NR frequency or inter-RAT frequency than the serving frequency shall be performed if:

- The serving cell fulfils $S_{qual} < Thresh_{Serving, LowQ}$ and a cell of a lower priority NR or E-UTRAN RAT/ frequency fulfils $S_{qual} > Thresh_{X, LowQ}$ during a time interval $T_{reselection_{RAT}}$.

Otherwise, cell reselection to a cell on a lower priority NR frequency or inter-RAT frequency than the serving frequency shall be performed if:

- The serving cell fulfils $S_{rxlev} < Thresh_{Serving, LowP}$ and a cell of a lower priority RAT/ frequency fulfils $S_{rxlev} > Thresh_{X, LowP}$ during a time interval $T_{reselection_{RAT}}$; and
- More than 1 second has elapsed since the UE camped on the current serving cell.

Cell reselection to a higher priority RAT/frequency shall take precedence over a lower priority RAT/frequency if multiple cells of different priorities fulfil the cell reselection criteria.

If more than one cell meets the above criteria, the UE shall reselect a cell as follows:

- If the highest-priority frequency is an NR frequency, the highest ranked cell among the cells on the highest priority frequency(ies) meeting the criteria according to clause 5.2.4.6;
- If the highest-priority frequency is from another RAT, the highest ranked cell among the cells on the highest priority frequency(ies) meeting the criteria of that RAT.

[TS 38.304, clause 5.2.4.7]

5.2.4.7.0 General reselection parameters

Cell reselection parameters are broadcast in system information and are read from the serving cell as follows:

absThreshSS-BlocksConsolidation

This specifies minimum threshold of the beam which can be used for selection of the highest ranked cell, if *rangeToBestCell* is configured.

cellReselectionPriority

This specifies the absolute priority for NR frequency or E-UTRAN frequency.

cellReselectionSubPriority

This specifies the fractional priority value added to *cellReselectionPriority* for NR frequency or E-UTRAN frequency.

Qoffset_{s,n}

This specifies the offset between the two cells.

Qoffset_{frequency}

Frequency specific offset for equal priority NR frequencies.

Q_{hyst}

This specifies the hysteresis value for ranking criteria.

Qoffset_{temp}

This specifies the additional offset to be used for cell selection and re-selection. It is temporarily used in case the RRC Connection Establishment fails on the cell as specified in TS 38.331 [3].

Q_{qualmin}

This specifies the minimum required quality level in the cell in dB.

Q_{rxlevmin}

This specifies the minimum required Rx level in the cell in dBm.

Q_{rxlevminoffsetcell}

This specifies the cell specific Rx level offset in dB to *Q_{rxlevmin}*.

Q_{qualminoffsetcell}

This specifies the cell specific quality level offset in dB to *Q_{qualmin}*.

rangeToBestCell

This specifies the R value range which the cells whose R value is within the range can be a candidate for the highest ranked cell.

Treselection_{RAT}

This specifies the cell reselection timer value. For each target NR frequency and for each RAT other than NR, a specific value for the cell reselection timer is defined, which is applicable when evaluating reselection within NR or towards other RAT (i.e. *Treselection_{RAT}* for NR is *Treselection_{NR}*, for E-UTRAN *Treselection_{EUTRA}*).

NOTE: *Treselection_{RAT}* is not broadcast in system information but used in reselection rules by the UE for each RAT.

Treselection_{NR}

This specifies the cell reselection timer value *Treselection_{RAT}* for NR. The parameter can be set per NR frequency as specified in TS 38.331 [3].

Treselection_{EUTRA}

This specifies the cell reselection timer value $Treselection_{RAT}$ for E-UTRAN.

Thresh_{X, HighP}

This specifies the $Srxlev$ threshold (in dB) used by the UE when reselecting towards a higher priority RAT/ frequency than the current serving frequency. Each frequency of NR and E-UTRAN might have a specific threshold.

Thresh_{X, HighQ}

This specifies the Squal threshold (in dB) used by the UE when reselecting towards a higher priority RAT/ frequency than the current serving frequency. Each frequency of NR and E-UTRAN might have a specific threshold.

Thresh_{X, LowP}

This specifies the $Srxlev$ threshold (in dB) used by the UE when reselecting towards a lower priority RAT/ frequency than the current serving frequency. Each frequency of NR and E-UTRAN might have a specific threshold.

Thresh_{X, LowQ}

This specifies the Squal threshold (in dB) used by the UE when reselecting towards a lower priority RAT/ frequency than the current serving frequency. Each frequency of NR and E-UTRAN might have a specific threshold.

Thresh_{Serving, LowP}

This specifies the $Srxlev$ threshold (in dB) used by the UE on the serving cell when reselecting towards a lower priority RAT/ frequency.

Thresh_{Serving, LowQ}

This specifies the Squal threshold (in dB) used by the UE on the serving cell when reselecting towards a lower priority RAT/ frequency.

S_{IntraSearchP}

This specifies the $Srxlev$ threshold (in dB) for intra-frequency measurements.

S_{IntraSearchQ}

This specifies the Squal threshold (in dB) for intra-frequency measurements.

S_{nonIntraSearchP}

This specifies the $Srxlev$ threshold (in dB) for NR inter-frequency and inter-RAT measurements.

S_{nonIntraSearchQ}

This specifies the Squal threshold (in dB) for NR inter-frequency and inter-RAT measurements.

5.2.4.7.1 Speed dependent reselection parameters

Speed dependent reselection parameters are broadcast in system information and are read from the serving cell as follows:

T_{CRmax}

This specifies the duration for evaluating allowed amount of cell reselection(s).

N_{CR_M}

This specifies the maximum number of cell reselections to enter Medium-mobility state.

N_{CR_H}

This specifies the maximum number of cell reselections to enter High-mobility state.

T_{CRmaxHyst}

This specifies the additional time period before the UE can enter Normal-mobility state.

Speed dependent ScalingFactor for Qhyst

This specifies scaling factor for Qhyst in *sf-High* for High-mobility state and *sf-Medium* for Medium-mobility state.

Speed dependent ScalingFactor for TreselectionNR

This specifies scaling factor for Treselection_{NR} in *sf-High* for High-mobility state and *sf-Medium* for Medium-mobility state.

Speed dependent ScalingFactor for TreselectionEUTRA

This specifies scaling factor for Treselection_{EUTRA} in *sf-High* for High-mobility state and *sf-Medium* for Medium-mobility state.

6.1.2.22.3 Test description

6.1.2.22.3.1 Pre-test conditions

System Simulator:

- NR Cell 1 and NR Cell 3.
- System information combination NR-4 as defined in TS 38.508-1 [4] Table 4.4.3.1.2-1, and message contents defined in clause 4.6.1 and clause 4.6.2 with QBASED condition is used in NR cells.

UE:

None.

Preamble:

- The UE is in state 1N-A on NR Cell 1(serving cell) according to TS 38.508-1 [4] Table 4.4A.2-1.

6.1.2.22.3.2 Test procedure sequence

Table 6.1.2.22.3.2-1/2 illustrates the downlink power levels and other changing parameters to be applied for the NR cells at various time instants of the test execution. The exact instants on which these values shall be applied are described in the texts in this clause. The configuration "T0" indicates the initial conditions. Subsequent configurations marked "T1" and "T2" are applied at the points indicated in the Main behaviour description in Table 6.1.2.22.3.2-3.

Table 6.1.2.22.3.2-1: Time instances of cell power level and parameter changes for FR1

	Parameter	Unit	NR Cell 1	NR Cell 3	Remark
T0	SS/PBCH SSS EPRE	dBm/SCS	-88	Off	The power level values are assigned to ensure the UE registered on NR Cell 1.
T1	SS/PBCH SSS EPRE	dBm/SCS	-88	-88	The power level values are assigned to satisfy $Srxlev_{NR\ Cell\ 1} > 0$, $Srxlev_{NR\ Cell\ 3} < Thresh_{NR\ Cell\ 3, highP}$, $Squal_{NR\ Cell\ 1} > 0$ and $Squal_{NR\ Cell\ 3} > Thresh_{NR\ Cell\ 3, highQ}$.
	RSRQ	dB	-10.76	-10.76	
	Qqualmin	dB	-20	-20	
	Qrxlevmin	dBm	-106	-106	
	Noc	dBm/SCS	-145	-145	

T2	SS/PBCH SSS EPRE	dBm/SCS	-88	-94	The power level values are assigned to satisfy $Srxlev_{NR\ Cell\ 3} > Thresh_{servicing, lowP}$ and $Squal_{NR\ Cell\ 1} > Thresh_{NR\ Cell\ 1, lowQ}$. But $Squal_{NR\ Cell\ 3}$ is larger than $Thresh_{servicing, lowQ}$
	RSRQ	dB	-10.76	-10.76	
	Qqualmin	dB	-20	-20	
	Qrxlevmin	dBm	-106	-106	
	Noc	dBm/SCS	-145	-145	
T3	threshServingLowQ	dB	4	26	The values are assigned to satisfy $Squal_{NR\ Cell\ 3} < Thresh_{servicing, lowQ}$ and $Squal_{NR\ Cell\ 3} < Thresh_{NR\ Cell\ 3, highQ}$.
	thresh _{NR} Cell 3 - HighQ	dB	20	-	

Note: Power level "Off" is defined in TS38.508-1 [4] Table 6.2.2.1-3.

Table 6.1.2.22.3.2-2: Time instances of cell power level and parameter changes for FR2

	Parameter	Unit	NR Cell 1	NR Cell 3	Remark
T0	SS/PBCH SSS EPRE	dBm/SCS	FFS	Off	The power level values are assigned to ensure the UE registered on NR Cell 1.
T1	SS/PBCH SSS EPRE	dBm/SCS	FFS	FFS	The power level values are assigned to satisfy $Srxlev_{NR\ Cell\ 1} > 0$, $Srxlev_{NR\ Cell\ 3} < Thresh_{NR\ Cell\ 3, highP}$, $Squal_{NR\ Cell\ 1} > 0$ and $Squal_{NR\ Cell\ 3} > Thresh_{NR\ Cell\ 3, highQ}$.
	RSRQ	dB	FFS	FFS	
	Qqualmin	dB	-20	-20	
	Qrxlevmin	dBm	-106	-106	
T2	SS/PBCH SSS EPRE	dBm/SCS	FFS	FFS	The power level values are assigned to satisfy $Srxlev_{NR\ Cell\ 3} > Thresh_{servicing, lowP}$ and $Squal_{NR\ Cell\ 1} > Thresh_{NR\ Cell\ 1, lowQ}$. But $Squal_{NR\ Cell\ 3}$ is larger than $Thresh_{servicing, lowQ}$
	RSRQ	dB	FFS	FFS	
	Qqualmin	dB	-20	-20	
	Qrxlevmin	dBm	-106	-106	
	Noc	dBm/SCS	FFS	FFS	
T3	threshServingLowQ	dB	4	26	The values are assigned to satisfy $Squal_{NR\ Cell\ 3} < Thresh_{servicing, lowQ}$ and $Squal_{NR\ Cell\ 3} < Thresh_{NR\ Cell\ 3, highQ}$.
	thresh _{NR} Cell 3 - HighQ	dB	20	-	

Note: The uncertain downlink signal level is specified in TS 38.508-1[4] section FFS.

Table 6.1.2.22.3.2-3: Main behaviour

St	Procedure	Message Sequence		TP	Verdict
		U – S	Message		
1	The SS changes NR Cell 3 SS/PBCH EPRE level according to the row "T1" in table 6.1.2.22.3.2-1/2.	-	-	-	-
2	Wait for 34 seconds to allow UE to recognise the change.	-	-	-	-
3	Check: Does the test result of generic test procedure in TS 38.508-1 [4] Table 4.9.4-1 indicate that the UE is camped on NR Cell 3?	-	-	1	
4	The SS changes the SSS level according to the row "T2" in table 6.1.2.22.3.2-1/2.	-	-	-	-
5	Wait for 8 seconds to allow UE to recognise the change.	-	-	-	-
6	The SS transmits a <i>Paging</i> message on NR Cell 1.	<--	NR RRC: <i>Paging</i>	-	-
6A	Check: Does the UE send an <i>RRCSetupRequest</i> on NR Cell 1 within the next 10s?	-->	NR RRC: <i>RRCSetupRequest</i>	2	F
7	The SS changes threshServingLowQ of NR Cell 3 according to the row "T3" in table 6.1.2.22.3.2-1/2. The <i>ValueTag</i> of <i>SIB2</i> in the SI-SchedulingInfo of <i>SIB1</i> is increased on NR Cell 3. The SS changes threshX-HighQ of NR Cell 1 according to the row "T3" in table 6.1.2.22.3.2-1/2. The <i>ValueTag</i> of <i>SIB4</i> in the SI-SchedulingInfo of <i>SIB1</i> is increased on NR Cell 1. The SS notifies the UE of change of System Information on NR Cell 3 and cell1 by send SM on PDCCH using P-RNTI.	-	-	-	-
8	Wait for 2.1* modification period to allow the new system information to take effect.	-	-	-	-
9	Check: Does the test result of generic test procedure in TS 38.508-1 [4] Table 4.9.4-1 indicate that the UE is camped on NR Cell 1?	-	-	2	

6.1.2.22.3.3 Specific message contents

Table 6.1.2.22.3.3-1: Conditions for specific message contents in Tables below

Condition	Explanation
NR Cell 1	This condition applies to system information transmitted on NR Cell 1.
NR Cell 3	This condition applies to system information transmitted on NR Cell 3.

Table 6.1.2.22.3.3-2: SIB2 of NR Cell 1 and NR Cell 3 (preamble and all steps, Table 6.1.2.22.3.2-3)

Derivation Path: TS 38.508-1 [4], Table 4.6.2-1			
Information Element	Value/remark	Comment	Condition
SIB2 ::= SEQUENCE {			
cellReselectionServingFreqInfo	1 entry		
SEQUENCE {			
threshServingLowP	1	2 dB	NR Cell 3
threshServingLowQ	4	4 dB	
cellReselectionPriority	5		NR Cell 3
}			
}			

Table 6.1.2.22.3.3-3: SIB4 of NR Cell 1 and NR Cell 3 (preamble and all steps, Table 6.1.2.22.3.2-3)

Derivation Path: TS 38.508-1 [4], Table 4.6.2-3			
Information Element	Value/remark	Comment	Condition
SIB4 ::= SEQUENCE {			
interFreqCarrierFreqList SEQUENCE (SIZE (1..maxFreq)) OF InterFreqCarrierFreqInfo {	1 entry		
InterFreqCarrierFreqInfo[1] SEQUENCE {		entry 1	
dl-CarrierFreq	Same downlink ARFCN as used for NR Cell 3		NR Cell 1
	Same downlink ARFCN as used for NR Cell 1		NR Cell 3
q-RxLevMin	-50	-100 dBm	
q-QualMin	-20	-20 dB	
t-ReselectionNR	1		
threshX-HighP	10	20 dBm	NR Cell 1
threshX-Q SEQUENCE {			
threshX-HighQ	4	4 dB	NR Cell 1
threshX-LowQ	2	2 dB	NR Cell 3
}			
cellReselectionPriority	5		NR Cell 1
	4		NR Cell 3
}			
}			

Table 6.1.2.22.3.3-4: SIB1 of NR Cell 3 (step 7, Table 6.1.2.22.3.2-3)

Derivation Path: TS 38.508-1 [4], Table 4.6.1-28			
Information Element	Value/remark	Comment	Condition
SIB1 ::= SEQUENCE {			
si-SchedulingInfo	SI-SchedulingInfo		
}			

Table 6.1.2.22.3.3-5: SI-SchedulingInfo (si-SchedulingInfo in Table 6.1.2.22.3.3-4)

Derivation Path: TS 38.508-1 [4], Table 4.6.3-173			
Information Element	Value/remark	Comment	Condition
SI-SchedulingInfo ::= SEQUENCE {			
schedulingInfoList SEQUENCE (SIZE (1..maxSI-Message)) OF SchedulingInfo {	1 entry		
SchedulingInfo[1] SEQUENCE {		entry 1	
sib-MappingInfo SEQUENCE (SIZE (1..maxSIB)) OF SIB-TypeInfo {	1 entry		
SIB-TypeInfo[1] SEQUENCE {		entry 1	
type	sibType2		
valueTag	1		
}			
}			
}			
}			

Table 6.1.2.22.3.3-6: SIB2 of NR Cell 3 (step 7, Table 6.1.2.22.3.2-3)

Derivation Path: TS 38.508-1 [4], Table 4.6.2-1			
Information Element	Value/remark	Comment	Condition
SIB2 ::= SEQUENCE {			
cellReselectionServingFreqInfo	1 entry		
SEQUENCE {			
threshServingLowQ	26	26 dB	
}			
}			

Table 6.1.2.22.3.3-7: SIB1 of NR Cell 1 (step 7, Table 6.1.2.22.3.2-3)

Derivation Path: TS 38.508-1 [4], Table 4.6.1-28			
Information Element	Value/remark	Comment	Condition
SIB1 ::= SEQUENCE {			
si-SchedulingInfo	SI-SchedulingInfo		
}			

Table 6.1.2.22.3.3-8: SI-SchedulingInfo (si-SchedulingInfo in Table 6.1.2.22.3.3-7)

Derivation Path: TS 38.508-1 [4], Table 4.6.3-173			
Information Element	Value/remark	Comment	Condition
SI-SchedulingInfo ::= SEQUENCE {			
schedulingInfoList SEQUENCE (SIZE(1..maxSI-Message)) OF SchedulingInfo {	1 entry		
SchedulingInfo[1] SEQUENCE {		entry 1	
sib-MappingInfo SEQUENCE (SIZE(1..maxSIB)) OF SIB-TypeInfo {	1 entry		
SIB-TypeInfo[1] SEQUENCE {		entry 1	
type	sibType4		
valueTag	1		
}			
}			
}			
}			
}			

Table 6.1.2.22.3.3-9: SIB4 of NR Cell 1 (step 7, Table 6.1.2.22.3.2-3)

Derivation Path: TS 38.508-1 [4], Table 4.6.2-3			
Information Element	Value/remark	Comment	Condition
SIB4 ::= SEQUENCE {			
interFreqCarrierFreqList SEQUENCE (SIZE(1..maxFreq)) OF InterFreqCarrierFreqInfo {	1 entry		
InterFreqCarrierFreqInfo[1] SEQUENCE {		entry 1	
dl-CarrierFreq	Same downlink ARFCN as used for NR Cell 3		
threshX-Q SEQUENCE {			
threshX-HighQ	20	20dB	
}			
}			
}			
}			

6.1.2.23 Cell reselection/ MFBI

6.1.2.23.1 Test Purpose (TP)

(0)

```
with { UE is switched off }
ensure that {
  when { UE is switched on a MFBI cell with the SIB1 of the first frequency band indicated in
freqBandIndicator is not supported by UE and the second frequency band indicated in
freqBandIndicator is supported by UE}
  then { the UE selects the cell}
}
```

(1)

```
with { UE in NR RRC_IDLE state }
ensure that {
  when { an equal priority NG-RAN Intra-frequency neighbouring cell which has been included in the
frequencyBandList provided by the serving cell becomes available, and, is better ranked than the
serving cell during a time interval TreselectionNR, and, more than 1 second has elapsed since the UE
camped on the current serving cell }
  then { the UE reselects the new cell}
```

(2)

```
with { UE in NR RRC_IDLE state }
ensure that {
  when { an equal priority NG-RAN Inter-frequency neighbouring cell which has been included in the
frequencyBandList provided by the serving cell becomes available, and, is better ranked than the
serving cell during a time interval TreselectionNR, and, more than 1 second has elapsed since the UE
camped on the current serving cell }
  then { the UE reselects the new cell}
```

(3)

```
with { UE in NR RRC_IDLE state }
ensure that {
  when { an equal priority NG-RAN Inter-band neighbouring cell which has been included in the
frequencyBandList provided by the serving cell becomes available, and, is better ranked than the
serving cell during a time interval TreselectionNR, and, more than 1 second has elapsed since the UE
camped on the current serving cell }
  then { the UE reselects the new cell}
```

6.1.2.23.2 Conformance requirements

References: The conformance requirements covered in the present TC are specified in: TS 38.304, clause 5.2.4.2, 5.2.4.5, 5.2.4.6 and TS 38.331, clause 5.2.2.4.2. Unless otherwise stated these are Rel-15 requirements.

[TS 38.304, clause 5.2.4.2]

Following rules are used by the UE to limit needed measurements:

- If the serving cell fulfils $S_{rxlev} > S_{IntraSearchP}$ and $S_{qual} > S_{IntraSearchQ}$, the UE may choose not to perform intra-frequency measurements.
- Otherwise, the UE shall perform intra-frequency measurements.
- The UE shall apply the following rules for NR inter-frequencies and inter-RAT frequencies which are indicated in system information and for which the UE has priority provided as defined in 5.2.4.1:
 - For a NR inter-frequency or inter-RAT frequency with a reselection priority higher than the reselection priority of the current NR frequency, the UE shall perform measurements of higher priority NR inter-frequency or inter-RAT frequencies according to TS 38.133 [8].
 - For a NR inter-frequency with an equal or lower reselection priority than the reselection priority of the current NR frequency and for inter-RAT frequency with lower reselection priority than the reselection priority of the current NR frequency:

- If the serving cell fulfils $S_{rxlev} > S_{nonIntraSearchP}$ and $S_{qual} > S_{nonIntraSearchQ}$, the UE may choose not to perform measurements of NR inter-frequencies or inter-RAT frequency cells of equal or lower priority;
- Otherwise, the UE shall perform measurements of NR inter-frequencies or inter-RAT frequency cells of equal or lower priority according to TS 38.133 [8].

[TS 38.304, clause 5.2.4.5]

If *threshServingLowQ* is broadcast in system information and more than 1 second has elapsed since the UE camped on the current serving cell, cell reselection to a cell on a higher priority NR frequency or inter-RAT frequency than the serving frequency shall be performed if:

- A cell of a higher priority NR or EUTRAN RAT/frequency fulfils $S_{qual} > Thresh_{X, HighQ}$ during a time interval $T_{reselection_{RAT}}$

Otherwise, cell reselection to a cell on a higher priority NR frequency or inter-RAT frequency than the serving frequency shall be performed if:

- A cell of a higher priority RAT/ frequency fulfils $S_{rxlev} > Thresh_{X, HighP}$ during a time interval $T_{reselection_{RAT}}$; and
- More than 1 second has elapsed since the UE camped on the current serving cell.

Cell reselection to a cell on an equal priority NR frequency shall be based on ranking for intra-frequency cell reselection as defined in clause 5.2.4.6.

If *threshServingLowQ* is broadcast in system information and more than 1 second has elapsed since the UE camped on the current serving cell, cell reselection to a cell on a lower priority NR frequency or inter-RAT frequency than the serving frequency shall be performed if:

- The serving cell fulfils $S_{qual} < Thresh_{Serving, LowQ}$ and a cell of a lower priority NR or E-UTRAN RAT/ frequency fulfils $S_{qual} > Thresh_{X, LowQ}$ during a time interval $T_{reselection_{RAT}}$.

Otherwise, cell reselection to a cell on a lower priority NR frequency or inter-RAT frequency than the serving frequency shall be performed if:

- The serving cell fulfils $S_{rxlev} < Thresh_{Serving, LowP}$ and a cell of a lower priority RAT/ frequency fulfils $S_{rxlev} > Thresh_{X, LowP}$ during a time interval $T_{reselection_{RAT}}$; and
- More than 1 second has elapsed since the UE camped on the current serving cell.

Cell reselection to a higher priority RAT/frequency shall take precedence over a lower priority RAT/frequency if multiple cells of different priorities fulfil the cell reselection criteria.

If more than one cell meets the above criteria, the UE shall reselect a cell as follows:

- If the highest-priority frequency is an NR frequency, the highest ranked cell among the cells on the highest priority frequency(ies) meeting the criteria according to clause 5.2.4.6;
- If the highest-priority frequency is from another RAT, the strongest cell among the cells on the highest priority frequency(ies) meeting the criteria of that RAT.

[TS 38.304, clause 5.2.4.6]

The cell-ranking criterion R_s for serving cell and R_n for neighbouring cells is defined by:

$$R_s = Q_{meas,s} + Q_{hyst} - Q_{offset_{temp}}$$

$$R_n = Q_{meas,n} - Q_{offset} - Q_{offset_{temp}}$$

where:

Q_{meas}	RSRP measurement quantity used in cell reselections.
Q_{offset}	For intra-frequency: Equals to $Q_{offset_{s,n}}$, if $Q_{offset_{s,n}}$ is valid, otherwise this equals to zero. For inter-frequency: Equals to $Q_{offset_{s,n}}$ plus $Q_{offset_{frequency}}$, if $Q_{offset_{s,n}}$ is valid, otherwise this equals to $Q_{offset_{frequency}}$.
$Q_{offset_{temp}}$	Offset temporarily applied to a cell as specified in TS 38.331 [3].

The UE shall perform ranking of all cells that fulfil the cell selection criterion S , which is defined in 5.2.3.2.

The cells shall be ranked according to the R criteria specified above by deriving $Q_{meas,n}$ and $Q_{meas,s}$ and calculating the R values using averaged RSRP results.

If *rangeToBestCell* is not configured, the UE shall perform cell reselection to the highest ranked cell. If this cell is found to be not-suitable, the UE shall behave according to clause 5.2.4.4.

If *rangeToBestCell* is configured, then the UE shall perform cell reselection to the cell with the highest number of beams above the threshold (i.e. *absThreshSS-BlocksConsolidation*) among the cells whose R value is within *rangeToBestCell* of the R value of the highest ranked cell. If there are multiple such cells, the UE shall perform cell reselection to the highest ranked cell among them. If this cell is found to be not-suitable, the UE shall behave according to clause 5.2.4.4.

In all cases, the UE shall reselect the new cell, only if the following conditions are met:

- the new cell is better than the serving cell according to the cell reselection criteria specified above during a time interval $T_{reselection_{RAT}}$;
- more than 1 second has elapsed since the UE camped on the current serving cell.

NOTE: If *rangeToBestCell* is configured but *absThreshSS-BlocksConsolidation* is not configured on an NR frequency, the UE considers that there is one beam above the threshold for each cell on that frequency.

[TS 38.331, clause 5.2.2.4.2]

Upon receiving the *SIB1* the UE shall:

- 1> store the acquired *SIB1*;
- ...
- 1> if in *RRC_CONNECTED* while T_{311} is not running:
 - 2> disregard the *frequencyBandList*, if received, while in *RRC_CONNECTED*;
 - 2> forward the *cellIdentity* to upper layers;
 - 2> forward the *trackingAreaCode* to upper layers;
 - 2> apply the configuration included in the *servingCellConfigCommon*;
- 1> else:
 - 2> if the UE supports one or more of the frequency bands indicated in the *frequencyBandList* for downlink, and one or more of the frequency bands indicated in the *frequencyBandList* for uplink for FDD, and they are not downlink only bands, and
 - 2> if the UE supports at least one *additionalSpectrumEmission* in the *NR-NS-PmaxList* for a supported band in the downlink and a supported band in uplink for FDD, and
 - 2> if the UE supports the bandwidth of the initial uplink BWP and of the initial downlink BWPs indicated in the *locationAndBandwidth* fields in *uplinkConfigCommon*:
 - 3> select the first frequency band in the *frequencyBandList* which the UE supports and for which the UE supports at least one of the *additionalSpectrumEmission* values in *nr-NS-PmaxList*, if present;
 - 3> forward the *cellIdentity* to upper layers;

- 3> forward the *trackingAreaCode* to upper layers;
- 3> forward the PLMN identity to upper layers;
- ...
- 2> else:
 - 3> consider the cell as barred in accordance with TS 38.304 [20]; and
 - 3> perform barring as if *intraFreqReselection* is set to *notAllowed*;

6.1.2.23.3 Test description

6.1.2.23.3.1 Pre-test conditions

System Simulator:

- NR Cell 1, NR Cell 2, NR Cell 3 and NR Cell 10 are configured according to TS 38.508-1 [4] Table 4.4.2-3. NR Cell 1, NR Cell 2 and NR Cell 3 are MFBI capable cells.
- Cell 1 belongs to the frequency which overlaps between bands controlled by IXITs *px_NR_OverlappingNotSupportedBand_MFBI* and *px_NR_PrimaryBand*.
- Cell 2 belongs to the frequency which overlaps between bands controlled by IXITs *px_NR_OverlappingNotSupportedBand_MFBI* and *px_NR_PrimaryBand*.
- Cell 3 belongs to the frequency which overlaps between bands controlled by IXITs *px_NR_OverlappingNotSupportedBand_MFBI* and *px_NR_PrimaryBand*.
- System information combination NR-4 as defined in TS 38.508 [4] clause 4.4.3.1.2 is used in NR cells.

UE:

- UE does not support the *px_NR_OverlappingNotSupportedBand_MFBI* band.

Preamble:

- UE is in state Switched OFF (state 0N-B) according to 38.508-1 [4].

6.1.2.23.3.2 Test procedure sequence

Table 6.1.2.23.3.2-1/2 illustrate the downlink power levels and other changing parameters to be applied for the cells at various time instants of the test execution. The exact instants on which these values shall be applied are described in the texts in this clause. The configuration marked "T1", "T2", "T3", "T4" and "T5" are applied at the points indicated in the Main behaviour description in Table 6.1.2.23.3.2-3.

Table 6.1.2.23.3.2-1: Time instances of cell power level and parameter changes for FR1

	Parameter	Unit	NR Cell 1	NR Cell 2	NR Cell 3	NR Cell 10	Remark
T1	SS/PBCH SSS EPRE	dBm/ SCS	-88	"Off"	"Off"	"Off"	The power level values are assigned to ensure the UE registered on NR Cell 1.
T2	SS/PBCH SSS EPRE	dBm/ SCS	-94	-88	"Off"	"Off"	The power level values are set so that $R_{Cell\ 1} < R_{Cell\ 2}$.
T3	SS/PBCH SSS EPRE	dBm/ SCS	"Off"	-94	-80	"Off"	The power level values are set so that $R_{Cell\ 1} < R_{Cell\ 3}$.
T4	SS/PBCH SSS EPRE	dBm/ SCS	"Off"	"Off"	-94	-80	The power level values are assigned to ensure the UE registered on NR Cell 10.
T5	SS/PBCH SSS EPRE	dBm/ SCS	-80	"Off"	"Off"	-94	The power level values are set so that $R_{Cell\ 10} < R_{Cell\ 1}$.

Note: Power level "Off" is defined in TS38.508-1 [4] Table 6.2.2.1-3.

Table 6.1.2.23.3.2-2: Time instances of cell power level and parameter changes for FR2

	Parameter	Unit	NR Cell 1	NR Cell 2	NR Cell 3	NR Cell 10	Remark
T1	SS/PBCH SSS EPRE	dBm/ SCS	-91	"Off"	"Off"	"Off"	The power level values are assigned to ensure the UE registered on NR Cell 1.
T2	SS/PBCH SSS EPRE	dBm/ SCS	-91	-82	"Off"	"Off"	The power level values are set so that $R_{Cell\ 1} < R_{Cell\ 2}$.
T3	SS/PBCH SSS EPRE	dBm/ SCS	"Off"	-91	-82	"Off"	The power level values are set so that $R_{Cell\ 1} < R_{Cell\ 3}$.
T4	SS/PBCH SSS EPRE	dBm/ SCS	"Off"	"Off"	-91	-82	The power level values are assigned to ensure the UE registered on NR Cell 10.
T5	SS/PBCH SSS EPRE	dBm/ SCS	-82	"Off"	"Off"	-91	The power level values are set so that $R_{Cell\ 10} < R_{Cell\ 1}$.

Note: Power level "Off" is defined in TS38.508-1 [4] Table 6.2.2.2-2.

Table 6.1.2.23.3.2-3: Main behaviour

St	Procedure	Message Sequence		TP	Verdict
		U - S	Message		
1	The SS changes the SS/PBCH EPRE level according to row "T1" in table 6.1.2.23.3.2-1/2.	-	-	-	-
2	The UE is switched on.	-	-	-	-
3-22a 1	Steps 1 to 20a1 of the registration procedure described in TS 38.508-1 [4] Table 4.5.2.2-2 are performed on NR Cell 1.	-	-	0	P
23	Wait 1 second. (to ensure than 1 second has elapsed since the UE camped on the current serving cell)	-	-	-	-
24	The SS changes the SS/PBCH EPRE level according to row "T2" in table 6.1.2.23.3.2-1/2.	-	-	-	-
24 A	Wait for 34s for FR1 or 130s for FR2 for the UE to perform cell reselection procedure. (Note 1)				
25	Check: Does the test result of generic test procedure in TS 38.508-1 [4] clause 4.9.4 indicate that the UE is camped on NR Cell 2?	-	-	1	P
26	Void				
27	Void				
28	Void				
29-48a 1	Void				
49	The SS changes the SS/PBCH EPRE level according to row "T3" in table 6.1.2.23.3.2-1/2.	-	-	-	-
50	Wait for 34s for FR1 or 130s for FR2 for the UE to perform cell reselection procedure. (Note 2)	-	-	-	-
51	Check: Does the test result of generic test procedure in TS 38.508-1 [4] clause 4.9.4 indicate that the UE is camped on NR Cell 3?	-	-	2	P
52	Void				
53	The SS changes the SS/PBCH EPRE level according to row "T4" in table 6.1.2.23.3.2-1/2.	-	-	-	-
54	Void				
55-74a 1	Void				
75	Wait for 34s for FR1 or 130s for FR2 for the UE to perform cell reselection procedure. (Note 2)	-	-	-	-
75 A	The test result of generic test procedure in TS 38.508-1 [4] clause 4.9.4 indicates that the UE is camped on NR Cell 10.				
76	The SS changes the SS/PBCH EPRE level according to row "T5" in table 6.1.2.23.3.2-1/2.	-	-	-	-
76 A	Wait for 34s for FR1 or 130s for FR2 for the UE to perform cell reselection procedure. (Note 2)				
77	Check: Does the test result of generic test procedure in TS 38.508-1 [4] clause 4.9.4 indicate that the UE is camped on NR Cell 1 belonging to the MFBI band (px_NR_PrimaryBand)?	-	-	3	P
<p>Note 1: The wait time for reselection to a newly detected intra frequency cell is selected to cover $T_{\text{detect,NR_Intra}}$ ($25 \times 1280\text{ms} = 32\text{s}$ for FR1 and $25 \times 4 \times 1280\text{ms} = 128\text{s}$ for FR2) + $T_{\text{SI-NR}}$ (1.28s for FR1 and FR2) = 33.28s rounded up to 34s for FR1 and 129.28s rounded up to 130s for FR2.</p> <p>Note 2: The wait time for reselection to a newly detected inter frequency cell is selected to cover $T_{\text{detect,NR_Inter}}$ ($25 \times 1280\text{ms} = 32\text{s}$ for FR1 and $25 \times 4 \times 1280\text{ms} = 128\text{s}$ for FR2) + $T_{\text{SI-NR}}$ (1.28s for FR1r and FR2) = 33.28s rounded up to 34s for FR1 and 129.28s rounded up to 130s for FR2.</p>					

6.1.2.23.3.3 Specific message contents

Table 6.1.2.23.3.3-1: Conditions for specific message contents in Table 6.1.2.23.3.3-4

Condition	Explanation
Cell 3	This condition applies to system information transmitted on Cell 3.
Cell 10	This condition applies to system information transmitted on Cell 10.

Table 6.1.2.23.3.3-2: SIB1 for NR Cell 1, NR Cell 2 and NR Cell 3 (preamble and all steps, Table 6.1.2.23.3.2-3)

Derivation Path: TS 38.508-1 [4], Table 4.6.1-28			
Information Element	Value/remark	Comment	Condition
SIB1 ::= SEQUENCE {			
servingCellConfigCommon SEQUENCE{			
downlinkConfigCommon SEQUENCE{			
frequencyInfoDL SEQUENCE {			
frequencyBandlist SEQUENCE (SIZE (1.. maxNrofMultiBands)) OF NR-MultiBandInfo {	2 entries		
NR-MultiBandInfo[1] SEQUENCE {		entry 1	
freqBandIndicatorNR	An overlapping not supported frequency band MFBI under test (px_NR_OverlappingNotSupportedBand_MFBI).		
}			
NR-MultiBandInfo[2] SEQUENCE {		entry 2	
freqBandIndicatorNR	An overlapping Band under test (px_NR_PrimaryBand).		
}			
}			
}			
}			
}			
}			

Table 6.1.2.23.3.3-3: SIB4 for NR Cell 1 and NR Cell 2 (preamble and all steps, Table 6.1.2.23.3.2-3)

Derivation Path: TS 38.508-1 [4], Table 4.6.2-3			
Information Element	Value/remark	Comment	Condition
SIB4 ::= SEQUENCE {			
InterFreqCarrierFreqList SEQUENCE (SIZE (1..maxFreq)) OF InterFreqCarrierFreqInfo {	2 entries		
InterFreqCarrierFreqInfo[1] SEQUENCE {		entry 1	
dl-CarrierFreq	Same downlink ARFCN as used for NR Cell 10		
}			
InterFreqCarrierFreqInfo[2] SEQUENCE {		entry 2	
dl-CarrierFreq	Same downlink ARFCN as used for NR Cell 3		
frequencyBandlist SEQUENCE (SIZE (1.. maxNrofMultiBands)) OF MultiBandInfo {	1 entry		
NR-MultiBandInfo[1] SEQUENCE {		entry 1	
freqBandIndicatorNR	An overlapping Band under test (px_NR_PrimaryBand).		
}			
}			
}			
}			
}			

Table 6.1.2.23.3.3-4: SIB4 for NR Cell 3 and NR Cell 10 (preamble and all steps, Table 6.1.2.23.3.2-3)

Derivation Path: TS 38.508-1 [4], Table 4.6.2-3			
Information Element	Value/remark	Comment	Condition
SIB4 ::= SEQUENCE {			
InterFreqCarrierFreqList SEQUENCE (SIZE (1..maxFreq)) OF InterFreqCarrierFreqInfo {	1 entry		
InterFreqCarrierFreqInfo[1] SEQUENCE {		entry 1	
dl-CarrierFreq	Same downlink ARFCN as used for NR Cell 1		NR Cell 10
	Same downlink ARFCN as used for NR Cell 10		NR Cell 3
frequencyBandList SEQUENCE (SIZE (1.. maxNrofMultiBands)) OF MultiBandInfo {	1 entry		
NR-MultiBandInfo[1] SEQUENCE {		entry 1	
freqBandIndicatorNR	An overlapping Band under test (px_NR_PrimaryBand)		NR Cell 10
	Band for interBand NR Cell 10 (px_NR_SecondaryBand).		NR Cell 3
}			
}			
}			
}			
}			

6.2 Multi-mode environment

6.2.1 Inter-RAT PLMN selection

6.2.1.1 Inter-RAT PLMN Selection / Selection of correct RAT for OPLMN / Automatic mode

6.2.1.1.1 Test Purpose (TP)

(1)

```
with { UE pre-set in Automatic network selection mode }
ensure that {
  when { UE is switched on and there are suitable NR and E-UTRAN cells some on the OPLMN list and
some not on the OPLMN list, none of them being part of the RPLMN }
  then { UE selects the highest priority OPLMN and RAT combination, attaches on the selected
cell.}
}
```

(2)

```
with { UE in Automatic network selection mode }
ensure that {
  when { UE returns to coverage and there are suitable NR and E-UTRAN cells some on the OPLMN list
and some not on the OPLMN list , none of them being part of the RPLMN }
  then { UE selects the highest priority OPLMN and RAT combination, attaches on the selected cell.
}
}
```

6.2.1.1.2 Conformance requirements

References: The conformance requirements covered in the present TC are specified in: TS 23.122 clauses 4.4.3.1 and 4.4.3.1.1. Unless otherwise stated these are Rel-15 requirements.

[TS 23.122, clause 4.4.3.1]

If successful registration is achieved, the MS indicates the selected PLMN.

...

NOTE 3: If successful registration is achieved, then the current serving PLMN becomes the registered PLMN and the MS does not store the previous registered PLMN for later use.

[TS 23.122, clause 4.4.3.1.1]

The MS selects and attempts registration on other PLMN/access technology combinations, if available and allowable, in the following order:

- i) either the HPLMN (if the EHPLMN list is not present or is empty) or the highest priority EHPLMN that is available (if the EHPLMN list is present) ;
- ii) each PLMN/access technology combination in the "User Controlled PLMN Selector with Access Technology" data file in the SIM (in priority order);
- iii) each PLMN/access technology combination in the "Operator Controlled PLMN Selector with Access Technology" data file in the SIM (in priority order);
- iv) other PLMN/access technology combinations with received high quality signal in random order;
- v) other PLMN/access technology combinations in order of decreasing signal quality.

6.2.1.1.3 Test description

6.2.1.1.3.1 Pre-test conditions

System Simulator

- 3 NR cells as specified in TS 38.508-1 [4] table 4.4.2-3. System information combination NR-1 as defined in Ts 38.508-1 [4] sub-clause 4.4.3.1.2 is applied to all the NR cells.
- 1 cell belongs to E-UTRA. System information combination 1 as defined in TS 36.508 [7] clause 4.4.3.1 is used.
- PLMN settings are defined in TS 36.523-1 [13] table 6.0.1-1.

Table 6.2.1.1.3.1-1: Cell PLMN identities

Cell	PLMN name
NR Cell 1	PLMN2
NR Cell 12	PLMN13
NR Cell 13	PLMN14
E-UTRA Cell 1	PLMN13

UE

- The UE is in Automatic PLMN selection mode.
- The HPLMN is PLMN1.
- USIM configuration 12 as specified in tables 6.4.1-12 in TS 38.508-1 [4] will be used.

Preamble

- The UE is in state Switched OFF (state 0-A) according to TS 38.508-1 [4].
- UE's Last Registered PLMN (RPLMN) needs to be cleared by using Registration Reject procedure as defined in TS 38.508-1 [4] Subclause 4.9.8.

6.2.1.1.3.2 Test procedure sequence

Table 6.2.1.1.3.2-1 for FR1 and table 6.2.1.1.3.2-2 FR2 illustrate the downlink power levels to be applied for the cells at various time instants of the test execution. Row marked "T0" denotes the initial conditions after preamble, while columns marked "T1" is to be applied subsequently in the Main behaviour. The exact instants on which these values shall be applied are described in the texts in this clause.

Table 6.2.1.1.3.2-1: Cell configuration changes over time for FR1

	Parameter	Unit	NR Cell 1	NR Cell 12	NR Cell 13	E-UTRA Cell 1	Remarks
T0	SS/PBCH SSS EPRE	dBm/SCS	-88	"Off"	-88		Power level "Off" is defined in TS 38.508-1 [4] Table 6.2.2.1-3
	RS EPRE	dBm/15kHz				-85	
T1	SS/PBCH SSS EPRE	dBm/SCS	"Off"	-88	-88		Power level "Off" is defined in TS 38.508-1 [4] Table 6.2.2.1-3
	RS EPRE	dBm/15kHz				-85	

Table 6.2.1.1.3.2-2: Cell configuration changes over time for FR2

	Parameter	Unit	NR Cell 1	NR Cell 12	NR Cell 13	E-UTRA Cell 1	Remarks
T0	SS/PBCH SSS EPRE	dBm/SCS	-82	"Off"	-82		Power level "Off" is defined in TS 38.508-1 [4] Table 6.2.2.1-3
	RS EPRE	dBm/15kHz	-	-	-	-85	
	Qrxlevmin	dBm	-91+ Delta(NRf1)	-	-91+ Delta(NRf3)	-	
T1	SS/PBCH SSS EPRE	dBm/SCS	"Off"	-82	-82		Power level "Off" is defined in TS 38.508-1 [4] Table 6.2.2.1-3
	RS EPRE	dBm/15kHz	-	-	-	-85	
	Qrxlevmin	dBm	-	-91+ Delta(NRf2)	-91+ Delta(NRf1)	-	

Table 6.2.1.1.3.2-3: Main behaviour

St	Procedure	Message Sequence		TP	Verdict
		U – S	Message		
1	The UE is switched on.	-	-	-	-
2	Check: Does the UE send <i>RRCSetupRequest</i> on NR Cell 1?	-->	NR RRC: <i>RRCSetupRequest</i>	1	P
3-20a1	Steps 3-20a1 of the registration procedure described in TS 38.508-1[4] table 4.5.2.2-2 are performed on NR Cell 1.	-	-	-	-
21	The SS adjusts cell levels according to row T1 of table 6.2.1.1.3.2-1.	-	-	-	-
22-28a1	Check: Does the test result of generic test procedure in TS 38.508-1[4] table 4.9.7.2.2-1 is performed and the UE is camped on E-UTRAN Cell 1?	-	-	2	P

6.2.1.1.3.3 Specific message contents

None.

6.2.1.2 Inter-RAT PLMN Selection / Selection of correct RAT for UPLMN / Automatic mode

6.2.1.2.1 Test Purpose (TP)

(1)

```
with { UE in Automatic network selection mode and UPLMN and OPLMN cells available on NR and E-UTRAN}
ensure that {
  when { UE is switched on}
  then { UE selects the highest priority UPLMN and RAT combination and UE attempts to register on
the selected cell }
}
```

(2)

```
with { UE in Automatic network selection mode and UPLMN and OPLMN cells available on NR and E-UTRAN}
ensure that {
  when { UE returns to coverage}
  then { UE selects the highest priority VPLMN and RAT combination and UE attempts to attach on
the selected cell }
}
```

6.2.1.2.2 Conformance requirements

References: The conformance requirements covered in the present TC are specified in: TS 23.122 clauses 4.4.3.1 and 4.4.3.1.1. Unless otherwise stated these are Rel-15 requirements.

[TS 23.122, clause 4.4.3.1]

If successful registration is achieved, the MS indicates the selected PLMN.

...

NOTE 3: If successful registration is achieved, then the current serving PLMN becomes the registered PLMN and the MS does not store the previous registered PLMN for later use.

[TS 23.122, clause 4.4.3.1.1]

The MS selects and attempts registration on other PLMN/access technology combinations, if available and allowable, in the following order:

- i) either the HPLMN (if the EHPLMN list is not present or is empty) or the highest priority EHPLMN that is available (if the EHPLMN list is present) ;
- ii) each PLMN/access technology combination in the "User Controlled PLMN Selector with Access Technology" data file in the SIM (in priority order);
- iii) each PLMN/access technology combination in the "Operator Controlled PLMN Selector with Access Technology" data file in the SIM (in priority order);
- iv) other PLMN/access technology combinations with received high quality signal in random order;
- v) other PLMN/access technology combinations in order of decreasing signal quality.

6.2.1.2.3 Test description

6.2.1.2.3.1 Pre-test conditions

System Simulator

- NR Cell 1 and NR Cell 12 as specified in TS 38.508-1 [4] table 4.4.2-3 are configured as shown in Table 6.2.1.2.3.2-1. System information combination NR-1 as defined in Ts 38.508-1 [4] sub-clause 4.4.3.1.2 is applied to all the NR cells.
- E-UTRA Cell 1 belongs to E-UTRA (defined in TS 36.508 [7]). System information combination 1 as defined in TS 36.508 [7] clause 4.4.3.1 is used.
- PLMN settings are defined in TS 36.523-1 [13] table 6.0.1-1.

Table 6.2.1.2.3.1-1: Cell PLMN identities

Cell	PLMN name
NR Cell 1	PLMN2
NR Cell 12	PLMN13
E-UTRA Cell 1	PLMN13

UE

- The UE is in Automatic PLMN selection mode.
- The HPLMN is PLMN1.
- USIM configuration 7 as specified in tables 6.4.1-7 in TS 38.508-1 [4] will be used.

Preamble

- The UE is in state Switched OFF (state 0N-B) according to TS 38.508-1[4].
- UE's Last Registered PLMN (RPLMN) needs to be cleared by using Registration Reject procedure as defined in TS 38.508-1 [4] Subclause 4.9.8.

6.2.1.2.3.2 Test procedure sequence

Table 6.2.1.2.3.2-1 for FR1 and table 6.2.1.2.3.2-2 for FR2 illustrate the downlink power levels to be applied for the cells at various time instants of the test execution. Row marked "T0" denotes the initial conditions after preamble, while columns marked "T1" is to be applied subsequently in the Main behaviour. The exact instants on which these values shall be applied are described in the texts in this clause.

Table 6.2.1.2.3.2-1: Cell configuration changes over time for FR1

	Parameter	Unit	NR Cell 1	NR Cell 12	E-UTRA Cell 1	Remarks
T0	SS/PBCH SSS EPRE	dBm/SCS	-88	-88	-	
	RS EPRE	dBm/15kHz			-85	
T1	SS/PBCH SSS EPRE	dBm/SCS	-88	"Off"	-	Power level "Off" is defined in TS 38.508-1 [4] Table 6.2.2.1-3
	RS EPRE	dBm/15kHz			-85	

Table 6.2.1.2.3.2-2: Cell configuration changes over time for FR2

	Parameter	Unit	NR Cell 1	NR Cell 12	E-UTRA Cell 1	Remarks
T0	SS/PBCH SSS EPRE	dBm/SCS	-82	-82	-	
	RS EPRE	dBm/15kHz	-	-	-85	
	Qrxlevmin	dBm	-91+ Delta(NRf1)	-91+ Delta(NRf2)	-	
T1	SS/PBCH SSS EPRE	dBm/SCS	-82	"Off"	-	Power level "Off" is defined in TS 38.508-1 [4] Table 6.2.2.1-3
	RS EPRE	dBm/15kHz	-	-	-85	
	Qrxlevmin	dBm	-91+ Delta(NRf1)	-	-	

Table 6.2.1.2.3.2-3: Main behaviour

St	Procedure	Message Sequence		TP	Verdict
		U – S	Message		
1	The UE is switched on.	-	-	-	-
2	Check: Does the UE send <i>RRCSetupRequest</i> on NR Cell 12?	-->	<i>RRCSetupRequest</i>	1	P
3-20a1	Steps 3-20a1 of the registration procedure described in TS 38.508-1[4] table 4.5.2.2-2 are performed on NR Cell 12.	-	-	-	-
21	The SS adjusts cell levels according to row T1 of table 6.2.1.2.3.2-1/2.	-	-	-	-
22	Check: Does the test result of generic test procedure in TS 38.508-1[4] table 4.9.7.2.2-1 is performed and the UE is camped on E-UTRAN Cell 1 with condition ' <i>connected without release</i> '?	-	-	2	P

6.2.1.2.3.3 Specific message contents

None.

6.2.1.3 Inter-RAT PLMN Selection / Selection of correct PLMN and RAT in shared network environment / Automatic mode

6.2.1.3.1 Test Purpose (TP)

(1)

```
with { UE in Automatic network selection mode and shared OPLMN cells available on NR and E-UTRAN }
ensure that {
  when { UE is switched on }
  then { UE selects the highest priority OPLMN and RAT combination and UE attempts to register on
the selected cell and PLMN }
}
```

(2)

```
with { UE in Automatic network selection mode and shared OPLMN cells available on NR and E-UTRAN }
ensure that {
  when { UE returns to coverage }
  then { UE selects the highest priority OPLMN and RAT combination and UE attempts to attach on
the selected cell and PLMN }
}
```

6.2.1.3.2 Conformance requirements

References: The conformance requirements covered in the present TC are specified in: TS 23.122 clauses 4.4.3, 4.4.3.1 and 4.4.3.1.1. Unless otherwise stated these are Rel-15 requirements.

[TS 23.122, clause 4.4.3]

When the MS reselects to a cell in a shared network, and the cell is a suitable cell for multiple PLMN identities received on the BCCH or on the EC-BCCH the AS indicates these multiple PLMN identities to the NAS according to 3GPP TS 44.018 [34], 3GPP TS 44.060 [39], 3GPP TS 25.304 [32] and 3GPP TS 36.304 [43]. The MS shall choose one of these PLMNs. If the registered PLMN is available among these PLMNs, the MS shall not choose a different PLMN.

[TS 23.122, clause 4.4.3.1]

If successful registration is achieved, the MS indicates the selected PLMN.

...

NOTE 3: If successful registration is achieved, then the current serving PLMN becomes the registered PLMN and the MS does not store the previous registered PLMN for later use.

[TS 23.122, clause 4.4.3.1.1]

The MS selects and attempts registration on other PLMN/access technology combinations, if available and allowable, in the following order:

- i) either the HPLMN (if the EHPLMN list is not present or is empty) or the highest priority EHPLMN that is available (if the EHPLMN list is present) ;
- ii) each PLMN/access technology combination in the "User Controlled PLMN Selector with Access Technology" data file in the SIM (in priority order);
- iii) each PLMN/access technology combination in the "Operator Controlled PLMN Selector with Access Technology" data file in the SIM (in priority order);
- iv) other PLMN/access technology combinations with received high quality signal in random order;
- v) other PLMN/access technology combinations in order of decreasing signal quality.

6.2.1.3.3 Test description

6.2.1.3.3.1 Pre-test conditions

System Simulator

- 2 NR cells as specified in TS 38.508-1[4] table 4.4.2-3 are configured as shown in Table 6.2.1.3.3.2-1. System information combination NR-1 as defined in Ts 38.508-1 [4] sub-clause 4.4.3.1.2 is applied to all the NR cells.
- 1 cell belongs to E-UTRA. System information combination 1 as defined in TS 36.508 [7] clause 4.4.3.1 is used.
- PLMN settings are defined in TS 36.523-1 [13] table 6.0.1-1.

Table 6.2.1.3.3.1-1: Cell PLMN identities

Cell	PLMN name
NR Cell 1	PLMN16
	PLMN15
NR Cell 12	PLMN16
	PLMN17
E-UTRA Cell 1	PLMN17

	PLMN16
--	--------

UE

- The UE is in Automatic PLMN selection mode.
- The HPLMN is PLMN1.
- USIM configuration 8 as specified in tables 6.4.1-8 in TS 38.508-1 [4] will be used.

Preamble

- The UE is in state Switched OFF (state 0N-B) according to TS 38.508-1[4].
- UE's Last Registered PLMN (RPLMN) needs to be cleared by using Registration Reject procedure as defined in TS 38.508-1 [4] Subclause 4.9.8

6.2.1.3.3.2 Test procedure sequence

Table 6.2.1.3.3.2-1 for FR1 and table 6.2.1.3.3.2-2 FR2 illustrate the downlink power levels to be applied for the cells at various time instants of the test execution. Row marked "T0" denotes the initial conditions after preamble, while columns marked "T1" is to be applied subsequently in the Main behaviour. The exact instants on which these values shall be applied are described in the texts in this clause.

Table 6.2.1.3.3.2-1: Cell configuration changes over time for FR1

	Parameter	Unit	NR Cell 1	NR Cell 12	E-UTRA Cell 1	Remarks
T0	SS/PBCH SSS EPRE	dBm/SCS	-88	-88		
	RS EPRE	dBm/15kHz			-85	
T1	SS/PBCH SSS EPRE	dBm/SCS	"Off"	-88		Power level "Off" is defined in TS 38.508-1 [4] Table 6.2.2.1-3
	RS EPRE	dBm/15kHz			-85	

Table 6.2.1.3.3.2-2: Cell configuration changes over time for FR2

	Parameter	Unit	NR Cell 1	NR Cell 12	E-UTRA Cell 1	Remarks
T0	SS/PBCH SSS EPRE	dBm/SCS	-82	-82		
	RS EPRE	dBm/15kHz	-	-	-85	
	Qrxlevmin	dBm	-91+ Delta(NRf1)	-91+ Delta(NRf2)	-	
T1	SS/PBCH SSS EPRE	dBm/SCS	"Off"	-82	-	Power level "Off" is defined in TS 38.508-1 [4] Table 6.2.2.1-3
	RS EPRE	dBm/15kHz	-	-	-85	
	Qrxlevmin	dBm	-	-91+ Delta(NRf2)	-	

Table 6.2.1.3.3.2-3: Main behaviour

St	Procedure	Message Sequence		TP	Verdict
		U – S	Message		
1	The UE is switched on.	-	-	-	-
2	Check: Does the UE send <i>RRCSetupRequest</i> on NR Cell 1?	-->	NR RRC: <i>RRCSetupRequest</i>	1	P
3-20a1	Steps 3-20a1 of the registration procedure described in TS 38.508-1[4] Table 4.5.2.2-2 are performed on NR Cell 1.	-	-	-	-
21	The SS adjusts cell levels according to row T1 of table 6.2.1.3.3.2-1/2.	-	-	-	-
22	Check: Does the test result of generic test procedure in TS 38.508-1[4] table 4.9.7.2.2-1 is performed and the UE is camped on E-UTRAN Cell 1 with condition ' <i>connected without release</i> '?	-	-	2	-

6.2.1.3.3.3 Specific message contents

Table 6.2.1.3.3.3-1: SIB1 for NR Cell 1(all steps, Table 6.2.1.3.3.2-3)

Derivation path: 38.508-1[4] Table 4.6.1-28			
Information Element	Value/Remark	Comment	Condition
SIB1 ::= SEQUENCE {			
CellAccessRelatedInfo SEQUENCE {			
PLMN-IdentityInfoList SEQUENCE (SIZE (1..maxPLMN)) OF PLMN-IdentityInfo {	1 entry		
PLMN-IdentityInfo[1] SEQUENCE {		entry 1	
plmn-IdentityList SEQUENCE (SIZE (1..maxPLMN)) OF PLMN-Identity {	2 entries		
PLMN-Identity[1] SEQUENCE {		entry 1	
mcc	PLMN16 MCC		
mnc	PLMN16 MNC		
}			
PLMN-Identity[2] SEQUENCE {		entry 2	
mcc	PLMN15 MCC		
mnc	PLMN15 MNC		
}			
}			
}			
}			
}			

Table 6.2.1.3.3.2-: SIB1 for NR Cell 12(all steps, Table 6.2.1.3.3.2-)

Derivation path: 38.508-1[4] Table 4.6.1-28			
Information Element	Value/Remark	Comment	Condition
SIB1 ::= SEQUENCE {			
CellAccessRelatedInfo SEQUENCE {			
PLMN-IdentityInfoList SEQUENCE (SIZE (1..maxPLMN)) OF PLMN-IdentityInfo {	1 entry		
PLMN-IdentityInfo[1] SEQUENCE {		entry 1	
plmn-IdentityList SEQUENCE (SIZE (1..maxPLMN)) OF PLMN-Identity {	2 entries		
PLMN-Identity[1] SEQUENCE {		entry 1	
mcc	PLMN16 MCC		
mnc	PLMN16 MNC		
}			
PLMN-Identity[2] SEQUENCE {		entry 2	
mcc	PLMN17 MCC		
mnc	PLMN17 MNC		
}			
}			
}			
}			
}			

Table 6.2.1.3.3.3-3: SystemInformationBlockType1 for E-UTRAN Cell 1 (all steps, Table 6.2.1.3.3.2-3)

Derivation path: 36.508[7] Table 4.4.3.2-3			
Information Element	Value/Remark	Comment	Condition
SystemInformationBlockType1 ::= SEQUENCE {			
cellAccessRelatedInfo SEQUENCE {			
plmn-IdentityList SEQUENCE (SIZE (1..6)) OF PLMN-IdentityInfo {	2 entries		
PLMN-IdentityInfo[1] SEQUENCE {		entry 1	
plmn-Identity	PLMN17		
}			
PLMN-IdentityInfo[2] SEQUENCE {		entry 2	
plmn-Identity	PLMN16		
}			
}			
}			
}			

Table 6.2.1.3.3.3-4: RRCSetupComplete (Step 6, Table 6.2.1.3.3.2-3)

Derivation Path: 38.508-1 [4] Table 4.6.1-22			
Information Element	Value/remark	Comment	Condition
RRCSetupComplete ::= SEQUENCE {			
criticalExtensions CHOICE {			
rrcSetupComplete SEQUENCE {			
selectedPLMN-Identity	2	PLMN15	
}			
}			
}			

Table 6.2.1.3.3.3-5: RRCConnectionSetupComplete (Step 22, Table 6.2.1.3.3.2-3)

Derivation Path: 36.331 [11] clause 6.2.2			
Information Element	Value/remark	Comment	Condition
RRCConnectionSetupComplete ::= SEQUENCE {			
criticalExtensions CHOICE {			
c1 CHOICE {			
rrcConnectionSetupComplete-r8 SEQUENCE {			
selectedPLMN-Identity	1	PLMN17	
}			
}			
}			
}			

6.2.1.4 Inter-RAT PLMN Selection / Selection of correct RAT from the OPLMN list / Manual mode

6.2.1.4.1 Test Purpose (TP)

(1)

```
with { UE in Manual network selection mode and OPLMN cells available on NR and E-UTRA }
ensure that {
  when { the USER selects an OPLMN }
  then { UE selects the highest priority RAT for the OPLMN and UE attempts to attach on the
selected cell and when successfully registered indicates the PLMN to the user }
}
```

(2)

```
with { UE in Manual network selection mode and OPLMN cells available on NR and E-UTRA }
ensure that {
  when { the USER selects an OPLMN and RAT combination }
  then { UE attempts to attach on the selected OPLMN and RAT combination and when successfully
registered indicates the PLMN to the user }
}
```

6.2.1.4.2 Conformance requirements

References: The conformance requirements covered in the present TC are specified in: TS 23.122 clauses 4.4.3.1.2. Unless otherwise stated these are Rel-15 requirements.

[TS 23.122, clause 4.4.3.1.2]

The MS indicates whether there are any PLMNs, which are available using all supported access technologies. This includes PLMNs in the "forbidden PLMNs" list, "forbidden PLMNs for GPRS service" list and PLMNs which only offer services not supported by the MS. An MS which supports GSM COMPACT shall also indicate GSM COMPACT PLMNs (which use PBCCH).

If displayed, PLMNs meeting the criteria above are presented in the following order:

- i)- either the HPLMN (if the EHPLMN list is not present or is empty) or, if one or more of the EHPLMNs are available then based on an optional data field on the SIM either only the highest priority available EHPLMN is to be presented to the user, or all available EHPLMNs are presented to the user in priority order. If the data field is not present on the SIM, then only the highest priority available EHPLMN is presented;
- ii)- PLMN/access technology combinations contained in the " User Controlled PLMN Selector with Access Technology " data file in the SIM (in priority order);
- iii)- PLMN/access technology combinations contained in the "Operator Controlled PLMN Selector with Access Technology" data file in the SIM (in priority order);
- iv)- other PLMN/access technology combinations with received high quality signal in random order;

v)- other PLMN/access technology combinations in order of decreasing signal quality.

...

The user may select his desired PLMN and the MS then initiates registration on this PLMN using the access technology chosen by the user for that PLMN or using the highest priority available access technology for that PLMN, if the associated access technologies have a priority order. (This may take place at any time during the presentation of PLMNs). For such a registration, the MS shall ignore the contents of the "forbidden location areas for roaming", "forbidden tracking areas for roaming", "5GS forbidden tracking areas for roaming", "forbidden location areas for regional provision of service", "forbidden tracking areas for regional provision of service", "5GS forbidden tracking areas for regional provision of service", "forbidden PLMNs for GPRS service" and "forbidden PLMNs" lists.

NOTE 1: It is an MS implementation option whether to indicate access technologies to the user. If the MS does display access technologies, then the access technology selected by the user is only used for initial registration on the selected PLMN. If the MS does not display access technologies, then the access technology chosen for a particular PLMN should be the highest priority available access technology for that PLMN, if the associated access technologies have a priority order, and is only used for initial registration.

6.2.1.4.3 Test description

6.2.1.4.3.1 Pre-test conditions

System Simulator

- 3 cells are used:
- NR Cell 1 and NR Cell 12 as specified in TS 38.508-1 [4] table 4.4.2-3 are configured as shown in Table 6.2.1.2.3.2-1. System information combination NR-1 as defined in Ts 38.508-1 [4] sub-clause 4.4.3.1.2 is applied to all the NR cells.
- E-UTRA Cell 1 belongs to E-UTRA (defined in TS 36.508 [7]). System information combination 1 as defined in TS 36.508 [7] clause 4.4.3.1 is used.
- PLMN settings are defined in TS 36.523-1 [13] table 6.0.1-1.

Table 6.2.1.4.3.1-1: Cell PLMN identities

Cell	PLMN name
NR Cell 1	PLMN2
NR Cell 12	PLMN13
E-UTRA Cell 1	PLMN2

UE

- The HPLMN is PLMN1.
- USIM configuration 13 as specified in table 6.4.1-13 in TS 38.508-1 [4] will be used.

Preamble

- The UE is attached to PLMN1 and the UE is set to Manual PLMN selection mode before it is in state Switched OFF (state ON-B) according to TS 38.508-1 [4].

6.2.1.4.3.2 Test procedure sequence

Table 6.2.1.4.3.2-1 for FR1 and table 6.2.1.4.3.2-2 for FR2 illustrate the downlink power levels to be applied for the cells at various time instants of the test execution. Row marked "T0" denotes the initial conditions after preamble. Configurations marked "T1" and "T2" are applied at the points indicated in the Main behaviour description in Table 6.2.1.4.3.2-3.

Table 6.2.1.4.3.2-1: Cell configuration changes over time for FR1

	Parameter	Unit	NR Cell 1	NR Cell 12	E-UTRA Cell 1
T0	SS/PBCH SSS EPRE	dBm/SCS	-88	-88	
	RS EPRE	dBm/15kHz			-85
T1	SS/PBCH SSS EPRE	dBm/SCS	OFF	OFF	
	RS EPRE	dBm/15kHz			-85
T2	SS/PBCH SSS EPRE	dBm/SCS	-88	OFF	
	RS EPRE	dBm/15kHz			OFF

Table 6.2.1.4.3.2-2: Cell configuration changes over time for FR1

	Parameter	Unit	NR Cell 1	NR Cell 12	E-UTRA Cell 1
T0	SS/PBCH SSS EPRE	dBm/SCS	-82	-82	-
	RS EPRE	dBm/15kHz	-	-	-85
	Qrxlevmin	dBm	-91+ Delta(NRf1)	-91+ Delta(NRf2)	-
T1	SS/PBCH SSS EPRE	dBm/SCS	OFF	OFF	
	RS EPRE	dBm/15kHz			-85
T2	SS/PBCH SSS EPRE	dBm/SCS	-82	OFF	
	RS EPRE	dBm/15kHz			OFF

Table 6.2.1.4.3.2-3: Main behaviour

St	Procedure	Message Sequence		TP	Verdict
		U – S	Message		
1	The UE is switched on.	-	-	-	-
2	Make the UE display the list of available PLMNs.	-	-	-	-
-	EXCEPTION: Steps 2a1 to 2b5 describe behaviour that depends on UE capabilities; the "lower case letter" identifies a step sequence that takes place if the condition is met.	-	-	-	-
2a1	IF pc_Available_PLMNs_Act_Ind[29] (Support of Access Technology Indication in available PLMNs list) THEN PLMN2 (E-UTRAN) is selected	-	-	-	-
2a2	Check: Does the test result of generic test procedure in TS 38.508-1[4] table 4.5.2.2-1 is performed and the UE is camped on E-UTRA Cell 1?	-	-	2	
2a3	Check: Is PLMN2 indicated as registered PLMN by the UE?	-	-	2	P
2a4	The SS adjusts the NR Cell power levels according to row "T1" in table 6.2.1.4.3.2-1/2.				
2a5	Set the UE in Automatic PLMN selection mode.				
2b1	ELSE (No Access Technology shown to the User) PLMN2 is selected				
2b2	Check: Does the test result of generic test procedure in TS 38.508-1[4] table 4.5.2.2-2 is performed and the UE is camped on NR Cell 1?	-		1	
2b3	Check: Is PLMN2 indicated as registered PLMN by the UE?	-	-	1	P
2b4	The SS adjusts the E-UTRA and NR Cell power levels according to row "T2" in table 6.2.1.4.3.2-1/2.				
2b5	Set the UE in Automatic PLMN selection mode.				
3	Wait for 300s to allow the UE to switch to automatic PLMN selection mode.	-	-	-	-

6.2.1.4.3.3 Specific message contents

None.

6.2.1.5 Inter-RAT Background HPLMN Search / Search for correct RAT for HPLMN / Automatic Mode

6.2.1.5.1 Test Purpose (TP)

```

with { UE in Automatic network selection mode is camped on a E-UTRAN VPLMN cell and HPLMN cell
available on NR}
ensure that {
  when { higher priority PLMN search timer T expires }
  then { UE detects NR cell and camps on the NR cell }
}

```

6.2.1.5.2 Conformance requirements

References: The conformance requirements covered in the present TC are specified in: TS 23.122 clauses 4.4.3.3.1. Unless otherwise stated these are Rel-15 requirements.

[TS 23.122, clause 4.4.3.3.1]

If the MS is in a VPLMN, the MS shall periodically attempt to obtain service on its HPLMN (if the EHPLMN list is not present or is empty) or one of its EHPLMNs (if the EHPLMN list is present) or a higher priority PLMN/access technology combinations listed in "user controlled PLMN selector" or "operator controlled PLMN selector" by scanning in accordance with the requirements that are applicable to i), ii) and iii) as defined in the Automatic Network Selection Mode in subclause 4.4.3.1.1. In the case that the mobile has a stored "Equivalent PLMNs" list the mobile shall only select a PLMN if it is of a higher priority than those of the same country as the current serving PLMN which are stored in the "Equivalent PLMNs" list. For this purpose, a value of timer T may be stored in the SIM. The interpretation of the stored value depends on the radio capabilities supported by the MS:

- For an MS that does not support any of the following: EC-GSM-IoT, Category M1 or Category NB1 (as defined in 3GPP TS 36.306 [54]), T is either in the range 6 minutes to 8 hours in 6 minute steps or it indicates that no periodic attempts shall be made. If no value for T is stored in the SIM, a default value of 60 minutes is used for T.
- For an MS that only supports any of the following or a combination of: EC-GSM-IoT, Category M1 or Category NB1 (as defined in 3GPP TS 36.306 [54]), T is either in the range 2 hours to 240 hours, using 2 hour steps from 2 hours to 80 hours and 4 hour steps from 84 hours to 240 hours, or it indicates that no periodic attempts shall be made. If no value for T is stored in the SIM, a default value of 72 hours is used.
- For an MS that supports both:
 - a) any of the following or a combination of: EC-GSM-IoT, Category M1 or Category NB1 (as defined in 3GPP TS 36.306 [54]); and
 - b) any access technology other than the following: EC-GSM-IoT, Category M1 or Category NB1 (as defined in 3GPP TS 36.306 [54]),

then T is interpreted depending on the access technology in use as specified below:

- 1) if the MS is using any of the following at the time of starting timer T: EC-GSM-IoT, Category M1 or Category NB1 (as defined in 3GPP TS 36.306 [54]), T is either in the range 2 hours to 240 hours, using 2 hour steps from 2 hours to 80 hours and 4 hour steps from 84 hours to 240 hours, or it indicates that no periodic attempts shall be made. If no value for T is stored in the SIM, a default value of 72 hours is used; and
- 2) if the MS is not using any of the following at the time of starting timer T: EC-GSM-IoT, Category M1 or Category NB1 (as defined in 3GPP TS 36.306 [54]), T is either in the range 6 minutes to 8 hours in 6 minute steps or it indicates that no periodic attempts shall be made. If no value for T is stored in the SIM, a default value of 60 minutes is used for T.

If the MS is configured with the MinimumPeriodicSearchTimer as specified in 3GPP TS 24.368 [50] or 3GPP TS 31.102 [40], the MS shall not use a value for T that is less than the MinimumPeriodicSearchTimer. If the value stored in the SIM, or the default value for T (when no value is stored in the SIM), is less than the MinimumPeriodicSearchTimer, then T shall be set to the MinimumPeriodicSearchTimer.

The MS does not stop timer T, as described in 3GPP TS 24.008 [23] and 3GPP TS 24.301 [23A], when it activates power saving mode (PSM) (see 3GPP TS 23.682 [27A]).

The MS can be configured for Fast First Higher Priority PLMN search as specified in 3GPP TS 31.102 [40] or 3GPP TS 24.368 [50]. Fast First Higher Priority PLMN search is enabled if the corresponding configuration parameter is present and set to enabled. Otherwise, Fast First Higher Priority PLMN search is disabled.

The attempts to access the HPLMN or an EHPLMN or higher priority PLMN shall be as specified below:

- a) The periodic attempts shall only be performed in automatic mode when the MS is roaming, and not while the MS is attached for emergency bearer services, is registered for emergency services, has a PDU session for emergency services or has a PDN connection for emergency bearer services;
- b) The MS shall make the first attempt after a period of at least 2 minutes and at most T minutes:
 - only after switch on if Fast First Higher Priority PLMN search is disabled; or
 - after switch on or upon selecting a VPLMN if Fast First Higher Priority PLMN search is enabled.
- c) The MS shall make the following attempts if the MS is on the VPLMN at time T after the last attempt;

- d) Periodic attempts shall only be performed by the MS while in idle mode;
- d1) periodic attempts may be postponed while the MS is in power saving mode (PSM) (see 3GPP TS 23.682 [27A]).
- e) If the HPLMN (if the EHPLMN list is not present or is empty) or a EHPLMN (if the list is present) or a higher priority PLMN is not found, the MS shall remain on the VPLMN.
- f) In steps i), ii) and iii) of subclause 4.4.3.1.1 the MS shall limit its attempts to access higher priority PLMN/access technology combinations to PLMN/access technology combinations of the same country as the current serving VPLMN, as defined in Annex B.
- g) Only the priority levels of Equivalent PLMNs of the same country as the current serving VPLMN, as defined in Annex B, shall be taken into account to compare with the priority level of a selected PLMN.
- h) If the PLMN of the highest priority PLMN/access technology combination available is the current VPLMN, or one of the PLMNs in the "Equivalent PLMNs" list, the MS shall remain on the current PLMN/access technology combination.

6.2.1.5.3 Test description

6.2.1.5.3.1 Pre-test conditions

System Simulator

- E-UTRA Cell 1 as specified in TS 36.508 [7]. System information combination 1 as defined in TS 36.508 [7] clause 4.4.3.1 is used.
- NR Cell 1 as specified in TS 38.508-1 [4] table 4.4.2-3. System information combination NR-1 as defined in TS 38.508-1 [4] sub-clause 4.4.3.1.2 is applied to the NR cell.
- PLMN settings are defined in TS 36.523-1 [13] table 6.0.1-1.

Table 6.2.1.5.3.1-1: Cell PLMN identities

Cell	PLMN name
NR Cell 1	PLMN1
E-UTRA Cell 1	PLMN15

UE

- USIM configuration 9 as specified in table 6.4.1-9 in TS 38.508-1 [4] will be used.

Preamble

- With E-UTRA Cell 1 "Serving cell" and NR Cell 1 "Non-suitable "Off" cell" in accordance with TS 38.508-1 [4], Table 6.2.2.1-3, the UE is brought to state RRC_IDLE Connectivity (*E*) in accordance with the procedure described in TS 38.508-1 [4], Table 4.5.2.2-1. 4G GUTI and eKSI are assigned and security context established.
- the UE is switched-off.
- With E-UTRA Cell 1 "Non-suitable "Off" cell" and NR Cell 1 "Serving cell" in accordance with TS 38.508-1 [4], Table 6.2.2.1-3, the UE is brought to state ON-B, RRC_IDLE Connectivity (NR), in accordance with the procedure described in TS 38.508-1 [4], Table 4.5.5.2-1. 5G-GUTI and ngKSI are assigned and security context established.

6.2.1.5.3.2 Test procedure sequence

Table 6.2.1.3.3.2-1 for FR1 and table 6.2.1.3.3.2-2 for FR2 illustrate the downlink power levels to be applied for the cells at various time instants of the test execution. Row marked "T0" denotes the initial conditions after preamble, while columns marked "T1" is to be applied subsequently in the Main behaviour. The exact instants on which these values shall be applied are described in the texts in this clause.

Table 6.2.1.5.3.2-1: Cell configuration changes over time for FR1

	Parameter	Unit	NR Cell 1	E-UTRA Cell 1	Remarks
T0	SS/PBCH SSS EPRE	dBm/SCS	"Off"		Power level "Off" is defined in TS 38.508-1 [4] Table 6.2.2.1-3
	RS EPRE	dBm/15kHz		-85	
T1	SS/PBCH SSS EPRE	dBm/SCS	-88		
	RS EPRE	dBm/15kHz		-85	

Table 6.2.1.5.3.2-2: Cell configuration changes over time for FR2

	Parameter	Unit	NR Cell 1	E-UTRA Cell 1	Remarks
T0	SS/PBCH SSS EPRE	dBm/SCS	"Off"		Power level "Off" is defined in TS 38.508-1 [4] Table 6.2.2.1-3
	RS EPRE	dBm/15kHz	-	-85	
	Qrxlevmin	dBm	-	-	
T1	SS/PBCH SSS EPRE	dBm/SCS	-82		
	RS EPRE	dBm/15kHz	-	-85	
	Qrxlevmin	dBm	-91+ Delta(NRf1)	-	

Table 6.2.1.5.3.2-3: Main behaviour

St	Procedure	Message Sequence		TP	Verdict
		U – S	Message		
1	Power on the UE.	-	-	-	-
2	Void	-	-	-	-
3-12b 8	Steps 1-10b8 of the registration procedure described in TS 38.508-1 [4] table 4.5.2.2-1 take place on E-UTRAN Cell 1.	-	-	-	-
13-18	Void	-	-	-	-
18A	SS starts timer of tmin = 2 minutes and tmax =6 minutes *(1+10% tolerance) (Note 1)	-	-	-	-
19	The SS adjusts cell levels according to row T1 of table 6.2.1.5.3.2-1.	-	-	-	-
20	Check: Does the UE send an <i>RRCSetupRequest</i> on NR Cell 1 after tmin but before tmax expires? (Note 1)	-->	NR RRC: <i>RRCSetupRequest</i>	1	P
20A-20B	Steps 3-4 of Table 4.5.2.2-2 of the generic procedure in TS 38.508-1 [4] are performed. (Note 2)				
-	EXCEPTION: Steps 21a1 to 21b10a1 describe behaviours which depend on procedure parameters; the "lower case letter" identifies a step sequence that take place if a procedure parameter has a particular value.	-	-	-	-
21a1-21a16a1	IF 5GS registration type is set as Initial Registration in step 20B, THEN steps 5 to 20a1 of the registration procedure described in TS 38.508-1 [4] Table 4.5.2.2-2 are performed on NR Cell 1.	-	-	-	-
21b1-21b8	ELSE IF 5GS registration type is set as Mobility Registration in step 20B, THEN steps 4 to 11 of the tracking area update procedure described in TS 38.508-1 [4] table 4.9.9.2.2-1 are performed without connection release on NR Cell 1.	-	-	-	-
21b9a1-21b10a1	Steps 19a1-20a1 of the procedure described in TS 38.508-1c [4] table 4.5.2.2-2 are performed with connection release on NR Cell 1.				
22-27a1	Void	-	-	-	-
<p>Note 1: Timers tmin and tmax in step 12b are derived from the high priority PLMN search timer T defined by EF_{HPPLMN}. The timer tmax shall be set to 396s (6 minutes *(1+10% tolerance)), where the high priority PLMN search timer T is defined in EF_{HPPLMN}.</p> <p>Note 2: The 5GS registration type shall be only set as Mobility Registration for R16 UEs according to TS 24.501 [22] subclause 5.2.3.2.5 specified in Release 16. The EXCEPTION description applies only to R15 UEs.</p>					

6.2.1.5.3.3 Specific message contents

Table 6.2.1.5.3.3-1: REGISTRATION ACCEPT (Step 21b7 of Table 6.2.1.5.3.2-3)

Derivation Path: TS 38.508-1 [4], Table 4.7.1-6.			
Information Element	Value/remark	Comment	Condition
PDU session status	0X 00 00		

6.2.2 Inter-RAT Cell Selection

6.2.2.1 Inter-RAT cell selection / From NR RRC_IDLE to EUTRA_Idle / Serving cell becomes non-suitable

6.2.2.1.1 Test Purpose (TP)

(1)

```
with { UE in NR RRC_IDLE state }
ensure that {
  when { the serving cell becomes non-suitable and there is a suitable E-UTRA neighbour cell }
  then { UE selects the suitable E-UTRA neighbour cell }
}
```

(2)

```
with { UE in NR RRC_IDLE state }
ensure that {
  when { the serving cell becomes barred and there is a suitable E-UTRA neighbour cell }
  then { UE selects the suitable E-UTRA neighbour cell }
}
```

6.2.2.1.2 Conformance requirements

References: The conformance requirements covered in the present TC are specified in: 3GPP TS 38.304, clause 5.2.1, 5.2.3.1, 5.2.3.2 and TS 36.304, clause 5.2.1, 5.2.3.1, 5.2.3.2. Unless otherwise stated these are Rel-15 requirements.

[TS 38.304, clause 5.2.1]

UE shall perform measurements for cell selection and reselection purposes as specified in TS 38.133 [8].

When evaluating S_{rxlev} and S_{qual} of non-serving cells for reselection evaluation purposes, the UE shall use parameters provided by the serving cell and for the final check on cell selection criterion, the UE shall use parameters provided by the target cell for cell reselection.

The NAS can control the RAT(s) in which the cell selection should be performed, for instance by indicating RAT(s) associated with the selected PLMN, and by maintaining a list of forbidden registration area(s) and a list of equivalent PLMNs. The UE shall select a suitable cell based on RRC_IDLE or RRC_INACTIVE state measurements and cell selection criteria.

In order to expedite the cell selection process, stored information for several RATs, if available, may be used by the UE.

When camped on a cell, the UE shall regularly search for a better cell according to the cell reselection criteria. If a better cell is found, that cell is selected. The change of cell may imply a change of RAT. Details on performance requirements for cell reselection can be found in TS 38.133 [8].

The NAS is informed if the cell selection and reselection result in changes in the received system information relevant for NAS.

For normal service, the UE shall camp on a suitable cell, monitor control channel(s) of that cell so that the UE can:

- receive system information from the PLMN or SNPN; and
- receive registration area information from the PLMN or SNPN, e.g., tracking area information; and
- receive other AS and NAS Information; and
- if registered:
 - receive paging and notification messages from the PLMN or SNPN; and
 - initiate transfer to Connected mode.

For cell selection in multi-beam operations, measurement quantity of a cell is up to UE implementation.

For cell reselection in multi-beam operations, including inter-RAT reselection from E-UTRA to NR, the measurement quantity of this cell is derived amongst the beams corresponding to the same cell based on SS/PBCH block as follows:

- if *nrofSS-BlocksToAverage* (*maxRS-IndexCellQual* in E-UTRA) is not configured in *SIB2/SIB4* (*SIB24* in E-UTRA); or
- if *absThreshSS-BlocksConsolidation* (*threshRS-Index* in E-UTRA) is not configured in *SIB2/SIB4* (*SIB24* in E-UTRA); or
- if the highest beam measurement quantity value is below or equal to *absThreshSS-BlocksConsolidation* (*threshRS-Index* in E-UTRA):
 - derive a cell measurement quantity as the highest beam measurement quantity value, where each beam measurement quantity is described in TS 38.215 [11].
- else:
 - derive a cell measurement quantity as the linear average of the power values of up to *nrofSS-BlocksToAverage* (*maxRS-IndexCellQual* in E-UTRA) of highest beam measurement quantity values above *absThreshSS-BlocksConsolidation* (*threshRS-Index* in E-UTRA).

[TS 38.304, clause 5.2.3.1]

Cell selection is performed by one of the following two procedures:

- a) Initial cell selection (no prior knowledge of which RF channels are NR frequencies):
 1. The UE shall scan all RF channels in the NR bands according to its capabilities to find a suitable cell.
 2. On each frequency, the UE need only search for the strongest cell, except for operation with shared spectrum channel access where the UE may search for the next strongest cell(s).
 3. Once a suitable cell is found, this cell shall be selected.
- b) Cell selection by leveraging stored information:
 1. This procedure requires stored information of frequencies and optionally also information on cell parameters from previously received measurement control information elements or from previously detected cells.
 2. Once the UE has found a suitable cell, the UE shall select it.
 3. If no suitable cell is found, the initial cell selection procedure in a) shall be started.

NOTE: Priorities between different frequencies or RATs provided to the UE by system information or dedicated signalling are not used in the cell selection process.

[TS 38.304, clause 5.2.3.2]

The cell selection criterion S is fulfilled when:

$$S_{rxlev} > 0 \text{ AND } S_{qual} > 0$$

where:

$$S_{rxlev} = Q_{rxlevmeas} - (Q_{rxlevmin} + Q_{rxlevminoffset}) - P_{compensation} - Q_{offsettemp}$$

$$S_{qual} = Q_{qualmeas} - (Q_{qualmin} + Q_{qualminoffset}) - Q_{offsettemp}$$

where:

Srxlev	Cell selection RX level value (dB)
Squal	Cell selection quality value (dB)
Qoffset _{temp}	Offset temporarily applied to a cell as specified in TS 38.331 [3] (dB)
Qrxlevmeas	Measured cell RX level value (RSRP)
Qqualmeas	Measured cell quality value (RSRQ)
Qrxlevmin	Minimum required RX level in the cell (dBm). If the UE supports SUL frequency for this cell, Qrxlevmin is obtained from $q\text{-RxLevMinSUL}$, if present, in <i>SIB1</i> , <i>SIB2</i> and <i>SIB4</i> , additionally, if $Q_{rxlevminoffsetcellSUL}$ is present in <i>SIB3</i> and <i>SIB4</i> for the concerned cell, this cell specific offset is added to the corresponding Qrxlevmin to achieve the required minimum RX level in the concerned cell; else Qrxlevmin is obtained from $q\text{-RxLevMin}$ in <i>SIB1</i> , <i>SIB2</i> and <i>SIB4</i> , additionally, if $Q_{rxlevminoffsetcell}$ is present in <i>SIB3</i> and <i>SIB4</i> for the concerned cell, this cell specific offset is added to the corresponding Qrxlevmin to achieve the required minimum RX level in the concerned cell.
Qqualmin	Minimum required quality level in the cell (dB). Additionally, if $Q_{qualminoffsetcell}$ is signalled for the concerned cell, this cell specific offset is added to achieve the required minimum quality level in the concerned cell.
Qrxlevminoffset	Offset to the signalled Qrxlevmin taken into account in the Srxlev evaluation as a result of a periodic search for a higher priority PLMN while camped normally in a VPLMN, as specified in TS 23.122 [9].
Qqualminoffset	Offset to the signalled Qqualmin taken into account in the Squal evaluation as a result of a periodic search for a higher priority PLMN while camped normally in a VPLMN, as specified in TS 23.122 [9].
P _{compensation}	For FR1, if the UE supports the additionalPmax in the NR-NS-PmaxList, if present, in <i>SIB1</i> , <i>SIB2</i> and <i>SIB4</i> : $\max(P_{EMAX1} - P_{PowerClass}, 0) - (\min(P_{EMAX2}, P_{PowerClass}) - \min(P_{EMAX1}, P_{PowerClass}))$ (dB); else: $\max(P_{EMAX1} - P_{PowerClass}, 0)$ (dB) For FR2, P _{compensation} is set to 0.
P _{EMAX1} , P _{EMAX2}	Maximum TX power level of a UE may use when transmitting on the uplink in the cell (dBm) defined as P _{EMAX} in TS 38.101 [15]. If UE supports SUL frequency for this cell, P _{EMAX1} and P _{EMAX2} are obtained from the $p\text{-Max}$ for SUL in <i>SIB1</i> and <i>NR-NS-PmaxList</i> for SUL respectively in <i>SIB1</i> , <i>SIB2</i> and <i>SIB4</i> as specified in TS 38.331 [3], else P _{EMAX1} and P _{EMAX2} are obtained from the $p\text{-Max}$ and <i>NR-NS-PmaxList</i> respectively in <i>SIB1</i> , <i>SIB2</i> and <i>SIB4</i> for normal UL as specified in TS 38.331 [3].
P _{PowerClass}	Maximum RF output power of the UE (dBm) according to the UE power class as defined in TS 38.101-1 [15].

The signalled values $Q_{rxlevminoffset}$ and $Q_{qualminoffset}$ are only applied when a cell is evaluated for cell selection as a result of a periodic search for a higher priority PLMN while camped normally in a VPLMN (TS 23.122 [9]). During this periodic search for higher priority PLMN, the UE may check the S criteria of a cell using parameter values stored from a different cell of this higher priority PLMN.

[TS 36.304, clause 5.2.1]

UE shall perform measurements for cell selection and reselection purposes as specified in TS 36.133 [10].

The NAS can control the RAT(s) in which the cell selection should be performed, for instance by indicating RAT(s) associated with the selected PLMN, and by maintaining a list of forbidden registration area(s) and a list of equivalent PLMNs. The UE shall select a suitable cell based on idle mode measurements and cell selection criteria.

In order to speed up the cell selection process, stored information for several RATs may be available in the UE.

When camped on a cell, the UE shall regularly search for a better cell according to the cell reselection criteria. If a better cell is found, that cell is selected. The change of cell may imply a change of RAT, or if the current and selected cell are both E-UTRA cells, a change of the CN type. Details on performance requirements for cell reselection can be found in TS 36.133 [10].

The NAS is informed if the cell selection and reselection results in changes in the received system information relevant for NAS.

For normal service, the UE shall camp on a suitable cell, tune to that cell's control channel(s) so that the UE can:

- Receive system information from the PLMN; and
- receive registration area information from the PLMN, e.g., tracking area information; and
- receive other AS and NAS Information; and
- if registered:
 - receive paging and notification messages from the PLMN; and
 - initiate transfer to connected mode.

[TS 36.304, clause 5.2.3.1]

The UE shall use one of the following two cell selection procedures:

a) Initial Cell Selection

This procedure requires no prior knowledge of which RF channels are E-UTRA or NB-IoT carriers. The UE shall scan all RF channels in the E-UTRA bands according to its capabilities to find a suitable cell. On each carrier frequency, the UE need only search for the strongest cell. Once a suitable cell is found this cell shall be selected.

b) Stored Information Cell Selection

This procedure requires stored information of carrier frequencies and optionally also information on cell parameters, from previously received measurement control information elements or from previously detected cells. Once the UE has found a suitable cell the UE shall select it. If no suitable cell is found the Initial Cell Selection procedure shall be started.

NOTE 1: Priorities between different frequencies or RATs provided to the UE by system information or dedicated signalling are not used in the cell selection process.

NOTE 2: If BL UE, UE in enhanced coverage or NB-IoT UE has been provisioned with EARFCN, the UE may use this information during Initial Cell Selection and Stored Information Cell Selection to find a suitable cell.

[TS 36.304, clause 5.2.3.2]

For NB-IoT the cell selection criterion is defined in clause 5.2.3.2a.

The cell selection criterion S in normal coverage is fulfilled when:

$$S_{rxlev} > 0 \text{ AND } S_{qual} > 0$$

where:

$$S_{rxlev} = Q_{rxlevmeas} - (Q_{rxlevmin} + Q_{rxlevminoffset}) - P_{compensation} - Q_{offsettemp}$$

$$S_{qual} = Q_{qualmeas} - (Q_{qualmin} + Q_{qualminoffset}) - Q_{offsettemp}$$

where:

Srxlev	Cell selection RX level value (dB)
Squal	Cell selection quality value (dB)
Qoffset _{temp}	Offset temporarily applied to a cell as specified in TS 36.331 [3] (dB)
Q _{rxlevmeas}	Measured cell RX level value (RSRP)
Q _{qualmeas}	Measured cell quality value (RSRQ)
Q _{rxlevmin}	Minimum required RX level in the cell (dBm)
Q _{qualmin}	Minimum required quality level in the cell (dB)
Q _{rxlevminoffset}	Offset to the signalled Q _{rxlevmin} taken into account in the Srxlev evaluation as a result of a periodic search for a higher priority PLMN while camped normally in a VPLMN TS 23.122 [5]
Q _{qualminoffset}	Offset to the signalled Q _{qualmin} taken into account in the Squal evaluation as a result of a periodic search for a higher priority PLMN while camped normally in a VPLMN TS 23.122 [5]
P _{compensation}	If the UE supports the <i>additionalPmax</i> in the <i>NS-PmaxList</i> , if present, in SIB1, SIB3 and SIB5: $\max(P_{EMAX1} - P_{PowerClass}, 0) - (\min(P_{EMAX2}, P_{PowerClass}) - \min(P_{EMAX1}, P_{PowerClass}))$ (dB); else: if P _{PowerClass} is 14 dBm: $\max(P_{EMAX1} - (P_{PowerClass} - P_{offset}), 0)$ (dB); else: $\max(P_{EMAX1} - P_{PowerClass}, 0)$ (dB)
P _{EMAX1} , P _{EMAX2}	Maximum TX power level an UE may use when transmitting on the uplink in the cell (dBm) defined as P _{EMAX} in TS 36.101 [33]. P _{EMAX1} and P _{EMAX2} are obtained from the <i>p-Max</i> and the <i>NS-PmaxList</i> respectively in SIB1, SIB3 and SIB5 as specified in TS 36.331 [3].
P _{PowerClass}	Maximum RF output power of the UE (dBm) according to the UE power class as defined in TS 36.101 [33]

The signalled values Q_{rxlevminoffset} and Q_{qualminoffset} are only applied when a cell is evaluated for cell selection as a result of a periodic search for a higher priority PLMN while camped normally in a VPLMN TS 23.122 [5]. During this periodic search for higher priority PLMN the UE may check the S criteria of a cell using parameter values stored from a different cell of this higher priority PLMN.

If cell selection criterion S in normal coverage is not fulfilled for a cell, UE shall consider itself to be in enhanced coverage if the cell selection criterion S for enhanced coverage is fulfilled, where:

Q _{rxlevmin}	UE applies coverage specific value Q _{rxlevmin_CE} (dBm)
Q _{qualmin}	UE applies coverage specific value Q _{qualmin_CE} (dB)

If cell selection criteria S in normal coverage is fulfilled for a cell, UE [may] consider itself to be in enhanced coverage if *SystemInformationBlockType1* cannot be acquired but UE is able to acquire *MasterInformationBlock*, *SystemInformationBlockType1-BR* and *SystemInformationBlockType2*.

If cell selection criterion S in normal coverage is not fulfilled for a cell and UE does not consider itself in enhanced coverage based on coverage specific values Q_{rxlevmin_CE} and Q_{qualmin_CE}, UE shall consider itself to be in enhanced coverage if UE supports CE Mode B and CE mode B is not restricted by upper layers and the cell selection criterion S for enhanced coverage is fulfilled, where:

Q _{rxlevmin}	UE applies coverage specific value Q _{rxlevmin_CE1} (dBm)
Q _{qualmin}	UE applies coverage specific value Q _{qualmin_CE1} (dB)

For the UE in enhanced coverage, coverage specific values Q_{rxlevmin_CE} and Q_{qualmin_CE} (or Q_{rxlevmin_CE1} and Q_{qualmin_CE1}) are only applied for the suitability check in enhanced coverage (i.e. not used for measurement and reselection thresholds).

6.2.2.1.3 Test description

6.2.2.1.3.1 Pre-test conditions

System Simulator:

- E-UTRA Cell 1, NR Cell 1.

- System information combination 31 as defined in TS 36.508-1 [7] clause 4.4.3.1 is used in E-UTRA Cell.
- System information combination NR-6 as defined in TS 38.508-1 [4] clause 4.4.3.1.3 is used in NR Cell.

UE:

- None.

Preamble:

- With E-UTRA Cell 1 "Serving cell" and NR Cell 1 "Non-suitable "Off" cell" in accordance with TS 38.508-1 [4], Table 6.2.2.1-3, the UE is brought to state RRC_IDLE Connectivity (*E-UTRA/EPC*) in accordance with the procedure described in TS 38.508-1 [4], Table 4.5.2.2-1. 4G GUTI and eKSI are assigned and security context established.
- the UE is switched-off.
- With E-UTRA Cell 1 "Non-suitable "Off" cell" and NR Cell 1 "Serving cell" in accordance with TS 38.508-1 [4], Table 6.2.2.1-3, the UE is brought to state 1N-A, RRC_IDLE Connectivity (NR), in accordance with the procedure described in TS 38.508-1 [4], Table 4.5.2.2-2. 5G-GUTI and ngKSI are assigned and security context established.

6.2.2.1.3.2 Test procedure sequence

Table 6.2.2.1.3.2-1/2 illustrate the downlink power levels and other changing parameters to be applied for the cell at various time instants of the test execution. The exact instants on which these values shall be applied are described in the texts in this clause. Row marked "T0" denotes the conditions in the preamble. Configurations marked "T1", "T2" and "T3" are applied at the points indicated in the Main behaviour description in Table 6.2.2.1.3.2-3.

Table 6.2.2.1.3.2-1: Time instances of cell power level and parameter changes for E-UTRA Cell 1 and NR Cell 1 in FR1

	Parameter	Unit	E-UTRA Cell 1	NR Cell 1	Remark
T0	Cell-specific RS EPRE	dBm/15kHz	Off	-	The power level values are assigned to ensure UE registered on NR cell 1
	SS/PBCH SSS EPRE	dBm/SCS	-	-85	
T1	Cell-specific RS EPRE	dBm/15kHz	-85	-	The power level value is such to satisfy $S_{rxlev}^{NR\ cell\ 1} < 0$ and ensure UE registered on E-UTRA cell 1
	SS/PBCH SSS EPRE	dBm/SCS	-	-115	
T2	Cell-specific RS EPRE	dBm/15kHz	Off	-	The power level values are assigned to ensure UE registered on NR cell 1
	SS/PBCH SSS EPRE	dBm/SCS	-	-85	
T3	Cell-specific RS EPRE	dBm/15kHz	-85	-	The power level values are assigned to ensure UE registered on E-UTRA cell 1
	SS/PBCH SSS EPRE	dBm/SCS	-	-85	

Note1: Power level "Off" is defined in TS 38.508-1 [4] Table 6.2.2.1-3.

Table 6.2.2.1.3.2-2: Time instances of cell power level and parameter changes for E-UTRA Cell 1 and NR Cell 1 in FR2

	Parameter	Unit	E-UTRA Cell 1	NR Cell 1	Remark
T0	Cell-specific RS EPRE	dBm/15kHz	Off	-	The power level values are assigned to ensure UE registered on NR cell 1
	SS/PBCH SSS EPRE	dBm/SCS	-	FFS	

T1	Cell-specific RS EPRE	dBm/15kHz	FFS	-	The power level value is such to satisfy $S_{rxlev_{NR, cell 1}} < 0$ and ensure UE registered on E-UTRA cell 1
	SS/PBCH SSS EPRE	dBm/SCS	-	FFS	
T2	Cell-specific RS EPRE	dBm/15kHz	Off	-	The power level values are assigned to ensure UE registered on NR cell 1
	SS/PBCH SSS EPRE	dBm/SCS	-	FFS	
T3	Cell-specific RS EPRE	dBm/15kHz	FFS	-	The power level values are assigned to ensure UE registered on E-UTRA cell 1
	SS/PBCH SSS EPRE	dBm/SCS	-	FFS	
Note1: Power level "Off" is defined in TS 38.508-1 [4] Table 6.2.2.1-3.					

Table 6.2.2.1.3.2-3: Main behaviour

St	Procedure	Message Sequence		TP	Verdict
		U - S	Message		
1	The SS adjusts the E-UTRA and NR Cells power levels according to row "T1" in table 6.2.2.1.3.2-1/2.	-	-	-	-
2	Check: Does the test result of generic test procedure in TS 38.508-1 [4] Table 4.9.7.2.2-1 indicate that the UE is camped on E-UTRA Cell 1?	-	-	1	P
3	The SS adjusts the E-UTRA and NR Cells power levels according to row "T2" in table 6.2.2.1.3.2-1/2.	-	-	-	-
4	The test result of generic test procedure in TS 38.508-1 [4] Table 4.9.9.2.2-1 indicate that the UE is camped on NR Cell 1. (NOTE 1)	-	-	-	-
5	The SS changes SIB1 of NR Cell 1 according to table 6.2.2.1.3.3-3 and notifies the UE of change of System Information on NR Cell 1 by sending Short Message on PDCCH using P-RNTI.	<--	PDCCH (DCI 1_0): Short Message	-	-
6	Wait for 2.1* modification period to allow the new system information to take effect.	-	-	-	-
7	The SS adjusts the NR and E-UTRAN Cell power levels according to row "T3" in table 6.2.2.1.3.2-1/2.	-	-	-	-
8	Check: Does the test result of generic test procedure in TS 38.508-1 [4] Table 4.9.7.2.2-1 indicate that the UE is camped on E-UTRA Cell 1?	-	-	2	P
Note 1: This is the first time in this test case that the UE moves from S1 to N1.					

6.2.2.1.3.3 Specific message contents

Table 6.2.2.1.3.3-1: SIB5 of NR Cell 1 (preamble and all steps, Table 6.2.2.1.3.2-3)

Derivation Path: TS 38.508-1 [4], Table 4.6.2-4			
Information Element	Value/remark	Comment	Condition
SIB5 ::= SEQUENCE {			
carrierFreqListEUTRA SEQUENCE (SIZE (1..maxEUTRA-Carrier)) OF CarrierFreqEUTRA {	1 entry		
CarrierFreqEUTRA{1} SEQUENCE {		entry 1	
carrierFreq	Downlink EUTRA ARFCN as E-UTRA Cell 1 used		
}			
}			
}			

Table 6.2.2.1.3.3-2: SystemInformationBlockType24 of EUTRA Cell 1 (preamble and all steps, Table 6.2.2.1.3.2-3)

Derivation path: TS 36.508 [7], Table 4.4.3.3-20			
Information Element	Value/Remark	Comment	Condition
SystemInformationBlockType24-r15 ::= SEQUENCE {			
carrierFreqListNR-r15 SEQUENCE (SIZE (1..maxFreq)) OF CarrierFreqNR-r15 {	1 entry		
CarrierFreqNR-r15[1] SEQUENCE {		entry 1	
carrierFreq-r15	Same downlink SSB ARFCN as used for NR Cell 1		
}			
}			
}			

Table 6.2.2.1.3.3-3: SIB1 for NR Cell 1 (step 5, Table 6.2.2.1.3.2-3)

Derivation Path: TS 38.508-1 [4], Table 4.6.1-28			
Information Element	Value/remark	Comment	Condition
SIB1 ::= SEQUENCE {			
cellAccessRelatedInfo SEQUENCE {			
cellReservedForOtherUse	true	The UE shall treat this cell as if cell status is "barred"	
}			
}			

Table 6.2.2.1.3.3-4: REGISTRATION REQUEST (step 4, Table 6.2.2.1.3.2-3)

Derivation Path: TS 38.508-1 [4], Table 4.9.9.2.3-1.			
Information Element	Value/remark	Comment	Condition
EPS NAS message container	TRACKING AREA UPDATE REQUEST message	See Table 6.2.2.1.3.3-5	

Table 6.2.2.1.3.3-5: TRACKING AREA UPDATE REQUEST (Table 6.2.2.1.3.3-4)

Derivation Path: TS 38.508-1 [4], Table 4.9.9.2.3-2 with condition Mapped EPS security context.

6.2.2.2 Inter-RAT cell selection / From E-UTRA_Idle to NR RRC_IDLE / Serving cell becomes non-suitable

6.2.2.2.1 Test Purpose (TP)

(1)

```
with { UE in E-UTRA RRC_IDLE state }
ensure that {
  when { the serving cell becomes non-suitable and there is a suitable NR neighbour cell }
  then { UE selects the suitable NR neighbour cell }
}
```

(2)

```
with { UE in E-UTRA RRC_IDLE state }
ensure that {
  when { the serving cell becomes barred and there is a suitable NR neighbour cell }
  then { UE selects the suitable NR neighbour cell }
}
```

6.2.2.2.2 Conformance requirements

References: The conformance requirements covered in the present TC are specified in: 3GPP TS 38.304, clause 5.2.1, 5.2.3.1, 5.2.3.2 and TS 36.304, clause 5.2.1, 5.2.3.1, 5.2.3.2. Unless otherwise stated these are Rel-15 requirements.

[TS 38.304, clause 5.2.1]

UE shall perform measurements for cell selection and reselection purposes as specified in TS 38.133 [8].

When evaluating $Srxlev$ and $Squal$ of non-serving cells for reselection evaluation purposes, the UE shall use parameters provided by the serving cell and for the final check on cell selection criterion, the UE shall use parameters provided by the target cell for cell reselection.

The NAS can control the RAT(s) in which the cell selection should be performed, for instance by indicating RAT(s) associated with the selected PLMN, and by maintaining a list of forbidden registration area(s) and a list of equivalent PLMNs. The UE shall select a suitable cell based on RRC_IDLE or RRC_INACTIVE state measurements and cell selection criteria.

In order to expedite the cell selection process, stored information for several RATs, if available, may be used by the UE.

When camped on a cell, the UE shall regularly search for a better cell according to the cell reselection criteria. If a better cell is found, that cell is selected. The change of cell may imply a change of RAT. Details on performance requirements for cell reselection can be found in TS 38.133 [8].

The NAS is informed if the cell selection and reselection result in changes in the received system information relevant for NAS.

For normal service, the UE shall camp on a suitable cell, monitor control channel(s) of that cell so that the UE can:

- receive system information from the PLMN or SNPN; and
- receive registration area information from the PLMN or SNPN, e.g., tracking area information; and
- receive other AS and NAS Information; and
- if registered:
 - receive paging and notification messages from the PLMN or SNPN; and
 - initiate transfer to Connected mode.

For cell selection in multi-beam operations, measurement quantity of a cell is up to UE implementation.

For cell reselection in multi-beam operations, including inter-RAT reselection from E-UTRA to NR, the measurement quantity of this cell is derived amongst the beams corresponding to the same cell based on SS/PBCH block as follows:

- if *nrofSS-BlocksToAverage* (*maxRS-IndexCellQual* in E-UTRA) is not configured in SIB2/SIB4 (SIB24 in E-UTRA); or
- if *absThreshSS-BlocksConsolidation* (*threshRS-Index* in E-UTRA) is not configured in SIB2/SIB4 (SIB24 in E-UTRA); or
- if the highest beam measurement quantity value is below or equal to *absThreshSS-BlocksConsolidation* (*threshRS-Index* in E-UTRA):
 - derive a cell measurement quantity as the highest beam measurement quantity value, where each beam measurement quantity is described in TS 38.215 [11].
- else:
 - derive a cell measurement quantity as the linear average of the power values of up to *nrofSS-BlocksToAverage* (*maxRS-IndexCellQual* in E-UTRA) of highest beam measurement quantity values above *absThreshSS-BlocksConsolidation* (*threshRS-Index* in E-UTRA).

[TS 38.304, clause 5.2.3.1]

Cell selection is performed by one of the following two procedures:

- a) Initial cell selection (no prior knowledge of which RF channels are NR frequencies):
1. The UE shall scan all RF channels in the NR bands according to its capabilities to find a suitable cell.
 2. On each frequency, the UE need only search for the strongest cell, except for operation with shared spectrum channel access where the UE may search for the next strongest cell(s).
 3. Once a suitable cell is found, this cell shall be selected.
- b) Cell selection by leveraging stored information:
1. This procedure requires stored information of frequencies and optionally also information on cell parameters from previously received measurement control information elements or from previously detected cells.
 2. Once the UE has found a suitable cell, the UE shall select it.
 3. If no suitable cell is found, the initial cell selection procedure in a) shall be started.

NOTE: Priorities between different frequencies or RATs provided to the UE by system information or dedicated signalling are not used in the cell selection process.

[TS 38.304, clause 5.2.3.2]

The cell selection criterion S is fulfilled when:

$$S_{rxlev} > 0 \text{ AND } S_{qual} > 0$$

where:

$$S_{rxlev} = Q_{rxlevmeas} - (Q_{rxlevmin} + Q_{rxlevminoffset}) - P_{compensation} - Q_{offsettemp}$$

$$S_{qual} = Q_{qualmeas} - (Q_{qualmin} + Q_{qualminoffset}) - Q_{offsettemp}$$

where:

Srxlev	Cell selection RX level value (dB)
Squal	Cell selection quality value (dB)
Qoffset _{temp}	Offset temporarily applied to a cell as specified in TS 38.331 [3] (dB)
Qrxlevmeas	Measured cell RX level value (RSRP)
Qqualmeas	Measured cell quality value (RSRQ)
Qrxlevmin	Minimum required RX level in the cell (dBm). If the UE supports SUL frequency for this cell, Qrxlevmin is obtained from $q\text{-RxLevMinSUL}$, if present, in <i>SIB1</i> , <i>SIB2</i> and <i>SIB4</i> , additionally, if $Q_{rxlevminoffsetcellSUL}$ is present in <i>SIB3</i> and <i>SIB4</i> for the concerned cell, this cell specific offset is added to the corresponding Qrxlevmin to achieve the required minimum RX level in the concerned cell; else Qrxlevmin is obtained from $q\text{-RxLevMin}$ in <i>SIB1</i> , <i>SIB2</i> and <i>SIB4</i> , additionally, if $Q_{rxlevminoffsetcell}$ is present in <i>SIB3</i> and <i>SIB4</i> for the concerned cell, this cell specific offset is added to the corresponding Qrxlevmin to achieve the required minimum RX level in the concerned cell.
Qqualmin	Minimum required quality level in the cell (dB). Additionally, if $Q_{qualminoffsetcell}$ is signalled for the concerned cell, this cell specific offset is added to achieve the required minimum quality level in the concerned cell.
Qrxlevminoffset	Offset to the signalled Qrxlevmin taken into account in the Srxlev evaluation as a result of a periodic search for a higher priority PLMN while camped normally in a VPLMN, as specified in TS 23.122 [9].
Qqualminoffset	Offset to the signalled Qqualmin taken into account in the Squal evaluation as a result of a periodic search for a higher priority PLMN while camped normally in a VPLMN, as specified in TS 23.122 [9].
P _{compensation}	For FR1, if the UE supports the additionalPmax in the NR-NS-PmaxList, if present, in <i>SIB1</i> , <i>SIB2</i> and <i>SIB4</i> : $\max(P_{EMAX1} - P_{PowerClass}, 0) - (\min(P_{EMAX2}, P_{PowerClass}) - \min(P_{EMAX1}, P_{PowerClass}))$ (dB); else: $\max(P_{EMAX1} - P_{PowerClass}, 0)$ (dB) For FR2, P _{compensation} is set to 0.
P _{EMAX1} , P _{EMAX2}	Maximum TX power level of a UE may use when transmitting on the uplink in the cell (dBm) defined as P _{EMAX} in TS 38.101 [15]. If UE supports SUL frequency for this cell, P _{EMAX1} and P _{EMAX2} are obtained from the $p\text{-Max}$ for SUL in <i>SIB1</i> and <i>NR-NS-PmaxList</i> for SUL respectively in <i>SIB1</i> , <i>SIB2</i> and <i>SIB4</i> as specified in TS 38.331 [3], else P _{EMAX1} and P _{EMAX2} are obtained from the $p\text{-Max}$ and <i>NR-NS-PmaxList</i> respectively in <i>SIB1</i> , <i>SIB2</i> and <i>SIB4</i> for normal UL as specified in TS 38.331 [3].
P _{PowerClass}	Maximum RF output power of the UE (dBm) according to the UE power class as defined in TS 38.101-1 [15].

The signalled values $Q_{rxlevminoffset}$ and $Q_{qualminoffset}$ are only applied when a cell is evaluated for cell selection as a result of a periodic search for a higher priority PLMN while camped normally in a VPLMN (TS 23.122 [9]). During this periodic search for higher priority PLMN, the UE may check the S criteria of a cell using parameter values stored from a different cell of this higher priority PLMN.

[TS 36.304, clause 5.2.1]

UE shall perform measurements for cell selection and reselection purposes as specified in TS 36.133 [10].

The NAS can control the RAT(s) in which the cell selection should be performed, for instance by indicating RAT(s) associated with the selected PLMN, and by maintaining a list of forbidden registration area(s) and a list of equivalent PLMNs. The UE shall select a suitable cell based on idle mode measurements and cell selection criteria.

In order to speed up the cell selection process, stored information for several RATs may be available in the UE.

When camped on a cell, the UE shall regularly search for a better cell according to the cell reselection criteria. If a better cell is found, that cell is selected. The change of cell may imply a change of RAT, or if the current and selected cell are both E-UTRA cells, a change of the CN type. Details on performance requirements for cell reselection can be found in TS 36.133 [10].

The NAS is informed if the cell selection and reselection results in changes in the received system information relevant for NAS.

For normal service, the UE shall camp on a suitable cell, tune to that cell's control channel(s) so that the UE can:

- Receive system information from the PLMN; and
- receive registration area information from the PLMN, e.g., tracking area information; and
- receive other AS and NAS Information; and
- if registered:
 - receive paging and notification messages from the PLMN; and
 - initiate transfer to connected mode.

[TS 36.304, clause 5.2.3.1]

The UE shall use one of the following two cell selection procedures:

a) Initial Cell Selection

This procedure requires no prior knowledge of which RF channels are E-UTRA or NB-IoT carriers. The UE shall scan all RF channels in the E-UTRA bands according to its capabilities to find a suitable cell. On each carrier frequency, the UE need only search for the strongest cell. Once a suitable cell is found this cell shall be selected.

b) Stored Information Cell Selection

This procedure requires stored information of carrier frequencies and optionally also information on cell parameters, from previously received measurement control information elements or from previously detected cells. Once the UE has found a suitable cell the UE shall select it. If no suitable cell is found the Initial Cell Selection procedure shall be started.

NOTE 1: Priorities between different frequencies or RATs provided to the UE by system information or dedicated signalling are not used in the cell selection process.

NOTE 2: If BL UE, UE in enhanced coverage or NB-IoT UE has been provisioned with EARFCN, the UE may use this information during Initial Cell Selection and Stored Information Cell Selection to find a suitable cell.

[TS 36.304, clause 5.2.3.2]

For NB-IoT the cell selection criterion is defined in clause 5.2.3.2a.

The cell selection criterion S in normal coverage is fulfilled when:

$$S_{rxlev} > 0 \text{ AND } S_{qual} > 0$$

where:

$$S_{rxlev} = Q_{rxlevmeas} - (Q_{rxlevmin} + Q_{rxlevminoffset}) - P_{compensation} - Q_{offset_{temp}}$$

$$S_{qual} = Q_{qualmeas} - (Q_{qualmin} + Q_{qualminoffset}) - Q_{offset_{temp}}$$

where:

Srxlev	Cell selection RX level value (dB)
Squal	Cell selection quality value (dB)
Qoffset _{temp}	Offset temporarily applied to a cell as specified in TS 36.331 [3] (dB)
Q _{rxlevmeas}	Measured cell RX level value (RSRP)
Q _{qualmeas}	Measured cell quality value (RSRQ)
Q _{rxlevmin}	Minimum required RX level in the cell (dBm)
Q _{qualmin}	Minimum required quality level in the cell (dB)
Q _{rxlevminoffset}	Offset to the signalled Q _{rxlevmin} taken into account in the Srxlev evaluation as a result of a periodic search for a higher priority PLMN while camped normally in a VPLMN TS 23.122 [5]
Q _{qualminoffset}	Offset to the signalled Q _{qualmin} taken into account in the Squal evaluation as a result of a periodic search for a higher priority PLMN while camped normally in a VPLMN TS 23.122 [5]
P _{compensation}	If the UE supports the <i>additionalPmax</i> in the <i>NS-PmaxList</i> , if present, in SIB1, SIB3 and SIB5: $\max(P_{EMAX1} - P_{PowerClass}, 0) - (\min(P_{EMAX2}, P_{PowerClass}) - \min(P_{EMAX1}, P_{PowerClass}))$ (dB); else: if P _{PowerClass} is 14 dBm: $\max(P_{EMAX1} - (P_{PowerClass} - P_{offset}), 0)$ (dB); else: $\max(P_{EMAX1} - P_{PowerClass}, 0)$ (dB)
P _{EMAX1} , P _{EMAX2}	Maximum TX power level an UE may use when transmitting on the uplink in the cell (dBm) defined as P _{EMAX} in TS 36.101 [33]. P _{EMAX1} and P _{EMAX2} are obtained from the <i>p-Max</i> and the <i>NS-PmaxList</i> respectively in SIB1, SIB3 and SIB5 as specified in TS 36.331 [3].
P _{PowerClass}	Maximum RF output power of the UE (dBm) according to the UE power class as defined in TS 36.101 [33]

The signalled values Q_{rxlevminoffset} and Q_{qualminoffset} are only applied when a cell is evaluated for cell selection as a result of a periodic search for a higher priority PLMN while camped normally in a VPLMN TS 23.122 [5]. During this periodic search for higher priority PLMN the UE may check the S criteria of a cell using parameter values stored from a different cell of this higher priority PLMN.

If cell selection criterion S in normal coverage is not fulfilled for a cell, UE shall consider itself to be in enhanced coverage if the cell selection criterion S for enhanced coverage is fulfilled, where:

Q _{rxlevmin}	UE applies coverage specific value Q _{rxlevmin_CE} (dBm)
Q _{qualmin}	UE applies coverage specific value Q _{qualmin_CE} (dB)

If cell selection criteria S in normal coverage is fulfilled for a cell, UE [may] consider itself to be in enhanced coverage if *SystemInformationBlockType1* cannot be acquired but UE is able to acquire *MasterInformationBlock*, *SystemInformationBlockType1-BR* and *SystemInformationBlockType2*.

If cell selection criterion S in normal coverage is not fulfilled for a cell and UE does not consider itself in enhanced coverage based on coverage specific values Q_{rxlevmin_CE} and Q_{qualmin_CE}, UE shall consider itself to be in enhanced coverage if UE supports CE Mode B and CE mode B is not restricted by upper layers and the cell selection criterion S for enhanced coverage is fulfilled, where:

Q _{rxlevmin}	UE applies coverage specific value Q _{rxlevmin_CE1} (dBm)
Q _{qualmin}	UE applies coverage specific value Q _{qualmin_CE1} (dB)

For the UE in enhanced coverage, coverage specific values Q_{rxlevmin_CE} and Q_{qualmin_CE} (or Q_{rxlevmin_CE1} and Q_{qualmin_CE1}) are only applied for the suitability check in enhanced coverage (i.e. not used for measurement and reselection thresholds).

6.2.2.2.3 Test description

6.2.2.2.3.1 Pre-test conditions

System Simulator:

- E-UTRA Cell 1, NR Cell 1.

- System information combination 31 as defined in TS 36.508-1 [7] clause 4.4.3.1 is used in E-UTRA Cell.
- System information combination NR-6 as defined in TS 38.508-1 [4] clause 4.4.3.1.3 is used in NR Cell.

UE:

- None.

Preamble:

- With E-UTRA Cell 1 "Non-suitable "Off" cell" and NR Cell 1 "Serving cell" in accordance with TS 38.508-1 [4], Table 6.2.2.2-3, the UE is brought to state IN-A, RRC_IDLE Connectivity (NR), in accordance with the procedure described in TS 38.508-1 [4], Table 4.5.2.2-2. 5G-GUTI and ngKSI are assigned and security context established.
- The UE is switched-off
- With E-UTRA Cell 1 "Serving cell" and NR Cell 1 "Non-suitable "Off" cell" in accordance with TS 38.508-1 [4], Table 6.2.2.2-3, the UE is brought to state RRC_IDLE Connectivity (E-UTRA) in accordance with the procedure described in TS 38.508-1 [4], Table 4.5.2.2-1. 4G GUTI and eKSI are assigned and security context established.

6.2.2.2.3.2 Test procedure sequence

Table 6.2.2.2.3.2-1/2 illustrate the downlink power levels and other changing parameters to be applied for the cell at various time instants of the test execution. The exact instants on which these values shall be applied are described in the texts in this clause. Row marked "T0" denotes the conditions in the preamble. Configurations marked "T1", "T2" and "T3" are applied at the points indicated in the Main behaviour description in Table 6.2.2.2.3-3.

Table 6.2.2.2.3.2-1: Time instances of cell power level and parameter changes for E-UTRA Cell 1 and NR Cell 1 in FR1

	Parameter	Unit	E-UTRA Cell 1	NR Cell 1	Remark
T0	Cell-specific RS EPRE	dBm/15kHz	-85	-	The power level values are assigned to ensure UE registered on E-UTRA cell 1
	SS/PBCH SSS EPRE	dBm/SCS	-	Off	
T1	Cell-specific RS EPRE	dBm/15kHz	-115	-	The power level value is such to satisfy $S_{rxlevE-UTRA\ cell\ 1} < 0$ and ensure UE registered on NR cell 1
	SS/PBCH SSS EPRE	dBm/SCS	-	-85	
T2	Cell-specific RS EPRE	dBm/15kHz	-85	-	The power level values are assigned to ensure UE registered on E-UTRA cell 1
	SS/PBCH SSS EPRE	dBm/SCS	-	Off	
T3	Cell-specific RS EPRE	dBm/15kHz	-85	-	The power level values are assigned to ensure UE registered on NR cell 1
	SS/PBCH SSS EPRE	dBm/SCS	-	-85	
Note1: Power level "Off" is defined in TS 38.508-1 [4] Table 6.2.2.1-3.					

Table 6.2.2.2.3.2-2: Time instances of cell power level and parameter changes for E-UTRA Cell 1 and NR Cell 1 in FR2

	Parameter	Unit	E-UTRA Cell 1	NR Cell 1	Remark
T0	Cell-specific RS EPRE	dBm/15kHz	FFS	-	The power level values are assigned to ensure UE registered on E-UTRA cell 1
	SS/PBCH SSS EPRE	dBm/SCS	-	Off	

T1	Cell-specific RS EPRE	dBm/15kHz	FFS	-	The power level value is such to satisfy $Srxlev_{E-UTRA, cell 1} < 0$ and ensure UE registered on NR cell 1
	SS/PBCH SSS EPRE	dBm/SCS	-	FFS	
T2	Cell-specific RS EPRE	dBm/15kHz	FFS	-	The power level values are assigned to ensure UE registered on E-UTRA cell 1
	SS/PBCH SSS EPRE	dBm/SCS	-	Off	
T3	Cell-specific RS EPRE	dBm/15kHz	FFS	-	The power level values are assigned to ensure UE registered on NR cell 1
	SS/PBCH SSS EPRE	dBm/SCS	-	FFS	
Note1: Power level "Off" is defined in TS 38.508-1 [4] Table 6.2.2.1-3.					

Table 6.2.2.3.2-3: Main behaviour

St	Procedure	Message Sequence		TP	Verdict
		U - S	Message		
1	The SS adjusts the E-UTRA and NR Cells power levels according to row "T1" in table 6.2.2.3.2-1/2.	-	-	-	-
2	Check: Does the test result of generic test procedure in TS 38.508-1 [4] Table 4.9.9.2.2-1 indicate that the UE is camped on NR Cell 1? (NOTE 1)	-	-	1	P
3	The SS adjusts the E-UTRA and NR Cells power levels according to row "T2" in table 6.2.2.3.2-1/2.	-	-	-	-
4	The test result of generic test procedure in TS 38.508-1 [4] Table 4.9.7.2.2-1 indicate that the UE is camped on E-UTRA Cell 1.	-	-	-	-
5	The SS changes <i>SystemInformationBlockType1</i> of E-UTRA Cell 1 according to table 6.2.2.3.3-3 and notifies the UE of change of System Information on E-UTRA Cell 1.	<--	<i>Paging</i>	-	-
6	The SS adjusts the E-UTRA and NR Cells power levels according to row "T3" in table 6.2.2.3.2-1/2.	-	-	-	-
7	Check: Does the test result of generic test procedure in TS 38.508-1 [4] Table 4.9.9.2.2-1 indicate that the UE is camped on NR Cell 1?	-	-	2	P
Note 1: This is the first time in this test case that the UE moves from S1 to N1.					

6.2.2.3.3 Specific message contents

Table 6.2.2.3.3-1: SIB5 of NR Cell 1(preamble and all steps, Table 6.2.2.3.2-3)

Derivation Path: TS 38.508-1 [4], Table 4.6.2-4			
Information Element	Value/remark	Comment	Condition
SIB5 ::= SEQUENCE {			
carrierFreqListEUTRA SEQUENCE (SIZE (1..maxEUTRA-Carrier)) OF CarrierFreqEUTRA {			
CarrierFreqEUTRA[1] SEQUENCE {		entry 1	
carrierFreq	Downlink EUTRA ARFCN as E-UTRA Cell 1 used		
}			
}			
}			

Table 6.2.2.3.3-2: SystemInformationBlockType24 of EUTRA Cell 1 (preamble and all steps, Table 6.2.2.3.2-3)

Derivation path: TS 36.508 [7], Table 4.4.3.3-20			
Information Element	Value/Remark	Comment	Condition
SystemInformationBlockType24-r15 ::= SEQUENCE {			
carrierFreqListNR-r15 SEQUENCE (SIZE (1..maxFreq)) OF CarrierFreqNR-r15 {	1 entry		
CarrierFreqNR-r15[1] SEQUENCE {		entry 1	
carrierFreq-r15	Same downlink SSB ARFCN as used for NR Cell 1		
}			
}			
}			

Table 6.2.2.3.3-3: SystemInformationBlockType1 for E-UTRA Cell 1 (step 5, Table 6.2.2.3.2-3)

Derivation Path: TS 36.508-1 [7], Table 4.4.3.2-3			
Information Element	Value/remark	Comment	Condition
SystemInformationBlockType1 ::= SEQUENCE {			
cellAccessRelatedInfo SEQUENCE {			
cellBarred	barred		
}			
}			

Table 6.2.2.3.3-4: REGISTRATION REQUEST (step 4, Table 6.2.2.3.2-3)

Derivation Path: TS 38.508-1 [4], Table 4.9.9.2.3-1.			
Information Element	Value/remark	Comment	Condition
EPS NAS message container	TRACKING AREA UPDATE REQUEST message	See Table 6.2.2.3.3-5	

Table 6.2.2.3.3-5: TRACKING AREA UPDATE REQUEST (Table 6.2.2.3.3-4)

Derivation Path: TS 38.508-1 [4], Table 4.9.9.2.3-2 with condition Mapped EPS security context.

6.2.3 Inter-RAT Cell Reselection

6.2.3.1 Inter-RAT cell reselection / From E-UTRA_Idle to NR RRC_IDLE (lower priority & higher priority, Srxlev based)

6.2.3.1.1 Test Purpose (TP)

(1)

```
with { UE in E-UTRA RRC_Idle state }
ensure that {
  when { UE detects the cell re-selection criteria are met for the cell which belongs to the lower
priority inter-RAT NR cell }
  then { UE reselects the cell which belongs to the lower priority inter-RAT NR cell }
}
```

(2)

```
with { UE in E-UTRA RRC_Idle state }
ensure that {
  when { UE detects the cell re-selection criteria are met for the cell which belongs to the higher
priority inter-RAT NR cell }
```

```

then { UE reselects the cell which belongs to the higher priority inter-RAT NR cell }
}

```

6.2.3.1.2 Conformance requirements

References: The conformance requirements covered in the present TC are specified in: 3GPP TS 36.304, clause 5.2.4.1, 5.2.4.2 and 5.2.4.5. Unless otherwise stated these are Rel-15 requirements.

[TS 36.304, clause 5.2.4.1]

Absolute priorities of different E-UTRAN frequencies or inter-RAT frequencies may be provided to the UE in the system information, in the *RRConnectionRelease* message, or by inheriting from another RAT at inter-RAT cell (re)selection. In the case of system information, an E-UTRAN frequency or inter-RAT frequency may be listed without providing a priority (i.e. the field *cellReselectionPriority* is absent for that frequency). If priorities are provided in dedicated signalling, the UE shall ignore all the priorities provided in system information. If UE is in *camped on any cell* state, UE shall only apply the priorities provided by system information from current cell, and the UE preserves priorities provided by dedicated signalling and *deprioritisationReq* received in *RRConnectionReject* unless specified otherwise. When the UE in *camped normally* state, has only dedicated priorities other than for the current frequency, the UE shall consider the current frequency to be the lowest priority frequency (i.e. lower than any of the network configured values). While the UE is camped on a suitable CSG cell in normal coverage, the UE shall always consider the current frequency to be the highest priority frequency (i.e. higher than any of the network configured values), irrespective of any other priority value allocated to this frequency. When the HSDN capable UE is in High-mobility state, the UE shall always consider the HSDN cells to be the highest priority (i.e. higher than any other network configured priorities). When the HSDN capable UE is not in High-mobility state, the UE shall always consider HSDN cells to be the lowest priority (i.e. lower than network configured priorities). If the UE capable of sidelink communication is configured to perform sidelink communication and can only perform the sidelink communication while camping on a frequency, the UE may consider that frequency to be the highest priority. If the UE capable of V2X sidelink communication is configured to perform V2X sidelink communication and can only perform the V2X sidelink communication while camping on a frequency, the UE may consider that frequency to be the highest priority. If the UE capable of V2X sidelink communication is configured to perform V2X sidelink communication and can only use pre-configuration while not camping on a frequency, the UE may consider the frequency providing inter-carrier V2X sidelink configuration to be the highest priority. If the UE capable of sidelink discovery is configured to perform Public Safety related sidelink discovery and can only perform the Public Safety related sidelink discovery while camping on a frequency, the UE may consider that frequency to be the highest priority.

NOTE 1: The prioritization among the frequencies which UE considers to be the highest priority frequency is left to UE implementation.

If the UE is capable either of MBMS Service Continuity or of SC-PTM reception and is receiving or interested to receive an MBMS service and can only receive this MBMS service while camping on a frequency on which it is provided, the UE may consider that frequency to be the highest priority during the MBMS session TS 36.300 [2] as long as the two following conditions are fulfilled:

1) Either:

- the UE is capable of MBMS service continuity and the reselected cell is broadcasting SIB13; or
- the UE is capable of SC-PTM reception and the reselected cell is broadcasting SIB20;

2) Either:

- SIB15 of the serving cell indicates for that frequency one or more MBMS SAIs included and associated with that frequency in the MBMS User Service Description (USD) TS 26.346 [22] of this service; or
- SIB15 is not broadcast in the serving cell and that frequency is included in the USD of this service.

If the UE is capable either of MBMS Service Continuity or of SC-PTM reception and is receiving or interested to receive an MBMS service provided on a downlink only MBMS frequency, on a frequency used by dedicated MBMS cells, on a frequency used by FeMBMS/Unicast-mixed cells as defined in TS 36.300 [2], or on a frequency belonging to PLMN different from its registered PLMN, the UE may consider cell reselection candidate frequencies at which it can not receive the MBMS service to be of the lowest priority during the MBMS session TS 36.300 [2], as long as the above mentioned condition 1) is fulfilled for the cell on the MBMS frequency which the UE monitors or this cell broadcasts SIB1-MBMS and as long as the above mentioned condition 2) is fulfilled for the serving cell.

NOTE 2: Example scenarios in which the previous down-prioritisation may be needed concerns the cases where camping is not possible, while the UE can only receive this MBMS frequency when camping on a subset of cell reselection candidate frequencies, e.g. the MBMS frequency is a downlink only carrier, the MBMS frequency is used by dedicated MBMS cells, the MBMS frequency is used by FeMBMS/Unicast-mixed cells TS 36.300 [2], or the MBMS frequency belongs to a PLMN different from UE's registered PLMN.

If the UE is not capable of MBMS Service Continuity but has knowledge on which frequency an MBMS service of interest is provided, it may consider that frequency to be the highest priority during the MBMS session TS 36.300 [2] as long as the reselected cell is broadcasting SIB13.

If the UE is not capable of MBMS Service Continuity but has knowledge on which downlink only frequency, on which frequency used by dedicated MBMS cells, on which frequency used by FeMBMS/Unicast-mixed cells as defined in TS 36.300 [2] or on which frequency belonging to PLMN different from its registered PLMN an MBMS service of interest is provided, it may consider cell reselection candidate frequencies at which it can not receive the MBMS service to be of the lowest priority during the MBMS session TS 36.300 [2] as long as the cell on the MBMS frequency which the UE monitors is broadcasting SIB13 or SIB1-MBMS.

NOTE 3: The UE considers that the MBMS session is ongoing using the session start and end times as provided by upper layers in the USD i.e. the UE does not verify if the session is indicated on MCCH.

In case UE receives *RRCConnectionReject* with *deprioritisationReq*, UE shall consider current carrier frequency and stored frequencies due to the previously received *RRCConnectionReject* with *deprioritisationReq* or all the frequencies of EUTRA to be the lowest priority frequency (i.e. lower than any of the network configured values) while T325 is running irrespective of camped RAT. The UE shall delete the stored deprioritisation request(s) when a PLMN selection is performed on request by NAS TS 23.122 [5].

NOTE 4: Connecting to CDMA2000 does not imply PLMN selection.

NOTE 5: UE should search for a higher priority layer for cell reselection as soon as possible after the change of priority. The minimum related performance requirements specified in TS 36.133 [10] are still applicable.

The UE shall delete priorities provided by dedicated signalling when:

- the UE enters a different RRC state; or
- the optional validity time of dedicated priorities (T320) expires; or
- a PLMN selection is performed on request by NAS TS 23.122 [5].

NOTE 6: Equal priorities between RATs are not supported.

The UE shall only perform cell reselection evaluation for E-UTRAN frequencies and inter-RAT frequencies that are given in system information and for which the UE has a priority provided.

The UE shall not consider any black listed cells as candidate for cell reselection.

The UE shall inherit the priorities provided by dedicated signalling and the remaining validity time (i.e., T320 in E-UTRA and NR, T322 in UTRA and T3230 in GERAN), if configured, at inter-RAT cell (re)selection.

NOTE 7: The network may assign dedicated cell reselection priorities for frequencies not configured by system information.

While T360 is running, redistribution target is considered to be the highest priority (i.e. higher than any of the network configured values). UE shall continue to consider the serving frequency as the highest priority until completion of E-UTRAN Inter-frequency Redistribution procedure specified in 5.2.4.10 if triggered on T360 expiry/ stop.

[TS 36.304, clause 5.2.4.2]

For NB-IoT measurement rules for cell re-selection is defined in sub-clause 5.2.4.2.a.

When evaluating *Srxlev* and *Squal* of non-serving cells for reselection purposes, the UE shall use parameters provided by the serving cell.

Following rules are used by the UE to limit needed measurements:

- If the serving cell fulfils $S_{rxlev} > S_{IntraSearchP}$ and $S_{qual} > S_{IntraSearchQ}$, the UE may choose not to perform intra-frequency measurements.
- Otherwise, the UE shall perform intra-frequency measurements.
- The UE shall apply the following rules for E-UTRAN inter-frequencies and inter-RAT frequencies which are indicated in system information and for which the UE has priority provided as defined in 5.2.4.1:
 - For an E-UTRAN inter-frequency or inter-RAT frequency with a reselection priority higher than the reselection priority of the current E-UTRA frequency the UE shall perform measurements of higher priority E-UTRAN inter-frequency or inter-RAT frequencies according to TS 36.133 [10].
 - For an E-UTRAN inter-frequency with an equal or lower reselection priority than the reselection priority of the current E-UTRA frequency and for inter-RAT frequency with lower reselection priority than the reselection priority of the current E-UTRAN frequency:
 - If the serving cell fulfils $S_{rxlev} > S_{nonIntraSearchP}$ and $S_{qual} > S_{nonIntraSearchQ}$, the UE may choose not to perform measurements of E-UTRAN inter-frequencies or inter-RAT frequency cells of equal or lower priority unless the UE is triggered to measure an E-UTRAN inter-frequency which is configured with *redistributionInterFreqInfo*.
 - Otherwise, the UE shall perform measurements of E-UTRAN inter-frequencies or inter-RAT frequency cells of equal or lower priority according to TS 36.133 [10].
- If the UE supports relaxed monitoring and *s-SearchDeltaP* is present in *SystemInformationBlockType3*, the UE may further limit the needed measurements, as specified in sub-clause 5.2.4.12.

[TS 36.304, clause 5.2.4.5]

For NB-IoT inter-frequency cell reselection shall be based on ranking as defined in sub-clause 5.2.4.6.

If *threshServingLowQ* is provided in *SystemInformationBlockType3* and more than 1 second has elapsed since the UE camped on the current serving cell, cell reselection to a cell on a higher priority E-UTRAN frequency or inter-RAT frequency than the serving frequency shall be performed if:

- A cell of a higher priority EUTRAN, NR or UTRAN FDD RAT/ frequency fulfils $S_{qual} > Thresh_{X, HighQ}$ during a time interval $T_{reselection_{RAT}}$; or
- A cell of a higher priority UTRAN TDD, GERAN or CDMA2000 RAT/ frequency fulfils $S_{rxlev} > Thresh_{X, HighP}$ during a time interval $T_{reselection_{RAT}}$.

Otherwise, cell reselection to a cell on a higher priority E-UTRAN frequency or inter-RAT frequency than the serving frequency shall be performed if:

- A cell of a higher priority RAT/ frequency fulfils $S_{rxlev} > Thresh_{X, HighP}$ during a time interval $T_{reselection_{RAT}}$; and
- More than 1 second has elapsed since the UE camped on the current serving cell.

Cell reselection to a cell on an equal priority E-UTRAN frequency shall be based on ranking for Intra-frequency cell reselection as defined in sub-clause 5.2.4.6.

If *threshServingLowQ* is provided in *SystemInformationBlockType3* and more than 1 second has elapsed since the UE camped on the current serving cell, cell reselection to a cell on a lower priority E-UTRAN frequency or inter-RAT frequency than the serving frequency shall be performed if:

- The serving cell fulfils $S_{qual} < Thresh_{Serving, LowQ}$ and a cell of a lower priority EUTRAN, NR or UTRAN FDD RAT/ frequency fulfils $S_{qual} > Thresh_{X, LowQ}$ during a time interval $T_{reselection_{RAT}}$; or
- The serving cell fulfils $S_{qual} < Thresh_{Serving, LowQ}$ and a cell of a lower priority UTRAN TDD, GERAN or CDMA2000 RAT/ frequency fulfils $S_{rxlev} > Thresh_{X, LowP}$ during a time interval $T_{reselection_{RAT}}$.

Otherwise, cell reselection to a cell on a lower priority E-UTRAN frequency or inter-RAT frequency than the serving frequency shall be performed if:

- The serving cell fulfils $Srxlev < Thresh_{Serving, LowP}$ and a cell of a lower priority RAT/ frequency fulfils $Srxlev > Thresh_{X, LowP}$ during a time interval $T_{reselection_{RAT}}$; and
- More than 1 second has elapsed since the UE camped on the current serving cell.

Cell reselection to a higher priority RAT/ frequency shall take precedence over a lower priority RAT/ frequency, if multiple cells of different priorities fulfil the cell reselection criteria.

The UE shall not perform cell reselection to NR or UTRAN FDD cells for which the cell selection criterion S is not fulfilled.

For cdma2000 RATs, $Srxlev$ is equal to $-FLOOR(-2 \times 10 \times \log_{10} Ec/Io)$ in units of 0.5 dB, as defined in [18], with Ec/Io referring to the value measured from the evaluated cell.

For cdma2000 RATs, $Thresh_{X, HighP}$ and $Thresh_{X, LowP}$ are equal to -1 times the values signalled for the corresponding parameters in the system information.

In all the above criteria the value of $T_{reselection_{RAT}}$ is scaled when the UE is in the medium or high mobility state as defined in subclause 5.2.4.3.1. If more than one cell meets the above criteria, the UE shall reselect a cell as follows:

- If the highest-priority frequency is an E-UTRAN frequency, a cell ranked as the best cell among the cells on the highest priority frequency(ies) meeting the criteria according to clause 5.2.4.6;
- If the highest-priority frequency is from another RAT, a cell ranked as the best cell among the cells on the highest priority frequency(ies) meeting the criteria of that RAT.

Cell reselection to another RAT, for which Squal based cell reselection parameters are broadcast in system information, shall be performed based on the Squal criteria if the UE supports Squal (RSRQ) based cell reselection to E-UTRAN from all the other RATs provided by system information which UE supports. Otherwise, cell reselection to another RAT shall be performed based on $Srxlev$ criteria.

Cell reselection to NR, for which a cell reselection parameter, $q-RxLevMinSUL$ is broadcast in system information and the UE supports SUL, shall be performed based on $Srxlev$ criteria taking the parameter into account.

6.2.3.1.3 Test description

6.2.3.1.3.1 Pre-test conditions

System Simulator:

- E-UTRA Cell 1, NR Cell 1.
- System information combination 31 as defined in TS 36.508-1 [7] clause 4.4.3.1 is used in E-UTRA Cell.
- System information combination NR-6 as defined in TS 38.508-1 [4] clause 4.4.3.1.3 is used in NR Cell.

UE:

- None.

Preamble:

- With E-UTRA Cell 1 "Non-suitable "Off" cell" and NR Cell 1 "Serving cell" in accordance with TS 38.508-1 [4], Table 6.2.2.1-3, the UE is brought to state 1N-A, RRC_IDLE Connectivity (NR), in accordance with the procedure described in TS 38.508-1 [4], Table 4.5.2.2-2. 5G-GUTI and ngKSI are assigned and security context established.
- the UE is switched-off
- With E-UTRA Cell 1 "Serving cell" and NR Cell 1 "Non-suitable "Off" cell" in accordance with TS 38.508-1 [4], Table 6.2.2.1-3, the UE is brought to state RRC_IDLE Connectivity (E) in accordance with the procedure described in TS 38.508-1 [4], Table 4.5.2.2-1. 4G GUTI and eKSI are assigned and security context established.

6.2.3.1.3.2 Test procedure sequence

Table 6.2.3.1.3.2-1/2 illustrate the downlink power levels and other changing parameters to be applied for the cell at various time instants of the test execution. The exact instants on which these values shall be applied are described in the texts in this clause. Row marked "T0" denotes the conditions in the preamble. Configurations marked "T1", "T2" and "T3" are applied at the points indicated in the Main behaviour description in Table 6.2.3.1.3.2-3.

Table 6.2.3.1.3.2-1: Time instances of cell power level and parameter changes for E-UTRA Cell 1 and NR Cell 1 in FR1

	Parameter	Unit	E-UTRA Cell 1	NR Cell 1	Remark
T0	Cell-specific RS EPRE	dBm/15kHz	-85	-	The power level values are assigned to ensure UE registered on E-UTRA cell 1
	SS/PBCH SSS EPRE	dBm/SCS	-	Off	
T1	Cell-specific RS EPRE	dBm/15kHz	-95	-	The power level values are assigned to satisfy both $Srxlev_{NR\ Cell\ 1} > Thresh_{x, low}$ and $Srxlev_{E-UTRA\ Cell\ 1} < Thresh_{serving, low}$
	SS/PBCH SSS EPRE	dBm/SCS	-	-80	
T2	Cell-specific RS EPRE	dBm/15kHz	-80	-	The power level values are assigned to ensure UE registered on E-UTRA cell 1, $Srxlev_{E-UTRA\ Cell\ 1} > Thresh_{x, high}$
	SS/PBCH SSS EPRE	dBm/SCS	-	-95	
T3	Cell-specific RS EPRE	dBm/15kHz	-95	-	The Priority and power level values are assigned to satisfy $Srxlev_{NR\ Cell\ 1} > Thresh_{x, high}$
	SS/PBCH SSS EPRE	dBm/SCS	-	-80	
Note1: Power level "Off" is defined in TS 38.508-1 [4] Table 6.2.2.1-3.					

Table 6.2.3.1.3.2-2: Time instances of cell power level and parameter changes for E-UTRA Cell 1 and NR Cell 1 in FR2

	Parameter	Unit	E-UTRA Cell 1	NRCell 1	Remark
T0	Cell-specific RS EPRE	dBm/15kHz	FFS	-	The power level values are assigned to ensure UE registered on E-UTRA cell 1
	SS/PBCH SSS EPRE	dBm/SCS	-	Off	
T1	Cell-specific RS EPRE	dBm/15kHz	FFS	-	The power level values are assigned to satisfy both $Srxlev_{NR\ Cell\ 1} > Thresh_{x, low}$ and $Srxlev_{E-UTRA\ Cell\ 1} < Thresh_{serving, low}$
	SS/PBCH SSS EPRE	dBm/SCS	-	FFS	
T2	Cell-specific RS EPRE	dBm/15kHz	FFS	-	The power level values are assigned to ensure UE registered on E-UTRA cell 1, $Srxlev_{E-UTRA\ Cell\ 1} > Thresh_{x, high}$
	SS/PBCH SSS EPRE	dBm/SCS	-	FFS	
T3	Cell-specific RS EPRE	dBm/15kHz	FFS	-	The Priority and power level values are assigned to satisfy $Srxlev_{NR\ Cell\ 1} > Thresh_{x, high}$
	SS/PBCH SSS EPRE	dBm/SCS	-	FFS	
Note1: Power level "Off" is defined in TS 38.508-1 [4] Table 6.2.2.1-3.					

Table 6.2.3.1.3.2-3: Main behaviour

St	Procedure	Message Sequence		TP	Verdict
		U - S	Message		
1	The SS adjusts the E-UTRAN and NR Cell power levels according to row "T1" in table 6.2.3.1.3.2-1/2.	-	-	-	-
2	Wait for 1 second to allow UE to recognise the change.	-	-	-	-
3	Check: Does the test result of generic test procedure in TS 38.508-1 [4] Table 4.9.9.2.2-1 indicate that the UE is camped on NR Cell 1?	-	-	1	P
4	Void.	-	-	-	-
5	The SS adjusts the E-UTRAN and NR Cell power levels according to row "T2" in table 6.2.3.1.3.2-1/2.	-	-	-	-
6	Wait for 1 second to allow UE to recognise the change.	-	-	-	-
7	The test result of generic test procedure in TS 38.508-1 [4] Table 4.9.7.2.2-1 indicate that the UE is camped on E-UTRAN Cell 1.	-	-	-	-
8	The SS notifies the UE of change of System Information on E-UTRAN Cell 1.	<--	<i>Paging</i>	-	-
9	The SS changes <i>Priority</i> of NR cell 1 in <i>SystemInformationBlockType24</i> . And the <i>systemInfoValueTag</i> in the <i>SystemInformationBlockType1</i> of E-UTRA Cell 1 is increased.	-	-	-	-
10	Wait for 6 s for UE to receive system information.	-	-	-	-
11	The SS re-adjusts the E-UTRAN and NR Cell levels according to row "T3" in table 6.2.3.1.3.2-1/2.	-	-	-	-
12	Check: Does the test result of generic test procedure in TS 38.508-1 [4] Table 4.9.9.2.2-1 indicate that the UE is camped on NR Cell 1?	-	-	2	P
13	Void.	-	-	-	-

6.2.3.1.3.3 Specific message contents

Table 6.2.3.1.3.3-1: *SystemInformationBlockType3* of EUTRA Cell 1 (preamble and all steps, Table 6.2.3.1.3.2-3)

Derivation Path: TS 36.508 [7], Table 4.4.3.3-2			
Information Element	Value/remark	Comment	Condition
<i>SystemInformationBlockType3</i> ::= SEQUENCE {			
<i>cellReselectionServingFreqInfo</i> SEQUENCE {			
<i>threshServingLow</i>	10	20 dB	
}			
}			

Table 6.2.3.1.3.3-2: SystemInformationBlockType24 of EUTRA Cell 1 (preamble, Table 6.2.3.1.3.2-3)

Derivation path: TS 36.508 [7], Table 4.4.3.3-20			
Information Element	Value/Remark	Comment	Condition
SystemInformationBlockType24-r15 ::= SEQUENCE {			
carrierFreqListNR-r15 SEQUENCE (SIZE (1..maxFreq)) OF CarrierFreqNR-r15 {	1 entry		
CarrierFreqNR-r15[1] SEQUENCE {		entry 1	
carrierFreq-r15	Downlink NR ARFCN of SSB for NR Cell 1		
cellReselectionPriority-r15	3		
threshX-High-r15	20	40 dB	
threshX-Low-r15	10	20 dB	
}			
}			
t-ReselectionNR-r15	7		
}			

Table 6.2.3.1.3.3-3: SIB2 of NR Cell 1(preamble and all steps, Table 6.2.3.1.3.2-3)

Derivation Path: TS 38.508-1 [4], Table 4.6.2-1			
Information Element	Value/remark	Comment	Condition
SIB2 ::= SEQUENCE {			
cellReselectionServingFreqInfo SEQUENCE {			
threshServingLowP	10	20 dB	
cellReselectionPriority	3		
}			
}			

Table 6.2.3.1.3.3-4: SIB5 of NR Cell 1(preamble and all steps, Table 6.2.3.1.3.2-3)

Derivation Path: TS 38.508-1 [4], Table 4.6.2-4			
Information Element	Value/remark	Comment	Condition
SIB5 ::= SEQUENCE {			
carrierFreqListEUTRA SEQUENCE (SIZE (1..maxEUTRA-Carrier)) OF CarrierFreqEUTRA {	1 entry		
CarrierFreqEUTRA[1] SEQUENCE {		entry 1	
carrierFreq	Downlink EUTRA ARFCN as E-UTRA Cell 1 used		
cellReselectionPriority	5		
threshX-High	10	20 dB	
threshX-Low	20	40 dB	
}			
}			
t-ReselectionEUTRA	7		
}			

Table 6.2.3.1.3.3-5: Paging (step 8, Table 6.2.3.1.3.2-3)

Derivation path: TS 36.508 [7], Table 4.6.1-7			
Information Element	Value/Remark	Comment	Condition
Paging ::= SEQUENCE {			
systemInfoModification	True		
}			

Table 6.2.3.1.3.3-6: SystemInformationBlockType1 of EUTRA Cell 1 (step 9, Table 6.2.3.1.3.2-3)

Derivation Path: TS 36.508 [7], Table 4.4.3.2-3			
Information Element	Value/remark	Comment	Condition
SystemInformationBlockType1 ::= SEQUENCE {			
systemInfoValueTag	1	Previous value is 0	
}			

Table 6.2.3.1.3.3-7: SystemInformationBlockType24 of EUTRA Cell 1 (step 9, Table 6.2.3.1.3.2-3)

Derivation path: TS 36.508 [7], Table 4.4.3.2-20			
Information Element	Value/Remark	Comment	Condition
SystemInformationBlockType24-r15 ::= SEQUENCE {			
carrierFreqListNR-r15 SEQUENCE (SIZE (1..maxFreq)) OF CarrierFreqNR-r15 {	1 entry		
CarrierFreqNR-r15[1] SEQUENCE {		entry 1	
carrierFreq-r15	Same downlink SSB ARFCN as used for NR Cell 1		
cellReselectionPriority-r15	5		
threshX-High-r15	10	20 dB	
threshX-Low-r15	20	40 dB	
}			
}			
t-ReselectionNR-r15	7	7 Seconds	
}			

Table 6.2.3.1.3.3-8: TRACKING AREA UPDATE REQUEST (Step 7, Table 6.2.3.1.3.2-3)

Derivation Path: TS 38.508-1 [4], Table 4.9.7.2.3-1			
Information Element	Value/remark	Comment	Condition
EPS update type			
EPS update type Value	'010'B	Combined TA/LA updating	combined_TA_LA
	'000'B	TA updating	TA_only
NOTE: The message shall be integrity protected using the 5GS security context available in the UE.			

Condition	Explanation
TA_only	This condition applies if the UE is configured to initiate EPS attach or if explicitly specified.
combined_TA_LA	This condition applies if the UE is configured to initiate combined EPS/IMSI attach or if explicitly specified.

Table 6.2.3.1.3.3-9: REGISTRATION REQUEST (Step 12, Table 6.2.3.1.3.2-3)

Derivation Path: TS 38.508-1 [4], Table 4.7.1-6.			
Information Element	Value/remark	Comment	Condition
EPS NAS message container	TRACKING AREA UPDATE REQUEST message	See Table 6.2.3.1.3.3-10	

Table 6.2.3.1.3.3-10: TRACKING AREA UPDATE REQUEST (Table 6.2.3.1.3.3-9)

Derivation Path: TS 38.508-1 [4], Table 4.9.9.2.3-2 with condition Mapped EPS security context			
--	--	--	--

6.2.3.2 Inter-RAT cell reselection / From E-UTRA_Idle to NR RRC_IDLE (lower priority & higher priority, Squal based)

6.2.3.2.1 Test Purpose (TP)

(1)

```
with { UE in E-UTRA RRC_IDLE state }
ensure that {
  when { UE detects the cell re-selection criteria are met for the cell which belongs to the lower
priority inter-RAT NR cell}
  then { UE reselects the cell which belongs to the lower priority inter-RAT NR cell }
}
```

(2)

```
with { UE in E-UTRA RRC_IDLE state }
ensure that {
  when { UE detects the cell re-selection criteria are met for the cell which belongs to the higher
priority inter-RAT NR cell}
  then { UE reselects the cell which belongs to the higher priority inter-RAT NR cell }
}
```

6.2.3.2.2 Conformance requirements

References: The conformance requirements covered in the present TC are specified in: 3GPP TS 36.304, clause 5.2.4.1, 5.2.4.2 and 5.2.4.5. Unless otherwise stated these are Rel-15 requirements.

[TS 36.304, clause 5.2.4.1]

Absolute priorities of different E-UTRAN frequencies or inter-RAT frequencies may be provided to the UE in the system information, in the *RRCCConnectionRelease* message, or by inheriting from another RAT at inter-RAT cell (re)selection. In the case of system information, an E-UTRAN frequency or inter-RAT frequency may be listed without providing a priority (i.e. the field *cellReselectionPriority* is absent for that frequency). If priorities are provided in dedicated signalling, the UE shall ignore all the priorities provided in system information. If UE is in *camped on any cell* state, UE shall only apply the priorities provided by system information from current cell, and the UE preserves priorities provided by dedicated signalling and *deprioritisationReq* received in *RRCCConnectionReject* unless specified otherwise. When the UE in *camped normally* state, has only dedicated priorities other than for the current frequency, the UE shall consider the current frequency to be the lowest priority frequency (i.e. lower than any of the network configured values). While the UE is camped on a suitable CSG cell in normal coverage, the UE shall always consider the current frequency to be the highest priority frequency (i.e. higher than any of the network configured values), irrespective of any other priority value allocated to this frequency. When the HSDN capable UE is in High-mobility state, the UE shall always consider the HSDN cells to be the highest priority (i.e. higher than any other network configured priorities). When the HSDN capable UE is not in High-mobility state, the UE shall always consider HSDN cells to be the lowest priority (i.e. lower than network configured priorities). If the UE capable of sidelink communication is configured to perform sidelink communication and can only perform the sidelink communication while camping on a frequency, the UE may consider that frequency to be the highest priority. If the UE capable of V2X sidelink communication is configured to perform V2X sidelink communication and can only perform the V2X sidelink communication while camping on a frequency, the UE may consider that frequency to be the highest priority. If the UE capable of V2X sidelink communication is configured to perform V2X sidelink communication and can only use pre-configuration while not camping on a frequency, the UE may consider the frequency providing inter-carrier V2X sidelink configuration to be the highest priority. If the UE capable of sidelink discovery is configured to perform Public Safety related sidelink discovery and can only perform the Public Safety related sidelink discovery while camping on a frequency, the UE may consider that frequency to be the highest priority.

NOTE 1: The prioritization among the frequencies which UE considers to be the highest priority frequency is left to UE implementation.

If the UE is capable either of MBMS Service Continuity or of SC-PTM reception and is receiving or interested to receive an MBMS service and can only receive this MBMS service while camping on a frequency on which it is provided, the UE may consider that frequency to be the highest priority during the MBMS session TS 36.300 [2] as long as the two following conditions are fulfilled:

1) Either:

- the UE is capable of MBMS service continuity and the reselected cell is broadcasting SIB13; or
- the UE is capable of SC-PTM reception and the reselected cell is broadcasting SIB20;

2) Either:

- SIB15 of the serving cell indicates for that frequency one or more MBMS SAIs included and associated with that frequency in the MBMS User Service Description (USD) TS 26.346 [22] of this service; or
- SIB15 is not broadcast in the serving cell and that frequency is included in the USD of this service.

If the UE is capable either of MBMS Service Continuity or of SC-PTM reception and is receiving or interested to receive an MBMS service provided on a downlink only MBMS frequency, on a frequency used by dedicated MBMS cells, on a frequency used by FeMBMS/Unicast-mixed cells as defined in TS 36.300 [2], or on a frequency belonging to PLMN different from its registered PLMN, the UE may consider cell reselection candidate frequencies at which it can not receive the MBMS service to be of the lowest priority during the MBMS session TS 36.300 [2], as long as the above mentioned condition 1) is fulfilled for the cell on the MBMS frequency which the UE monitors or this cell broadcasts SIB1-MBMS and as long as the above mentioned condition 2) is fulfilled for the serving cell.

NOTE 2: Example scenarios in which the previous down-prioritisation may be needed concerns the cases where camping is not possible, while the UE can only receive this MBMS frequency when camping on a subset of cell reselection candidate frequencies, e.g. the MBMS frequency is a downlink only carrier, the MBMS frequency is used by dedicated MBMS cells, the MBMS frequency is used by FeMBMS/Unicast-mixed cells TS 36.300 [2], or the MBMS frequency belongs to a PLMN different from UE's registered PLMN.

If the UE is not capable of MBMS Service Continuity but has knowledge on which frequency an MBMS service of interest is provided, it may consider that frequency to be the highest priority during the MBMS session TS 36.300 [2] as long as the reselected cell is broadcasting SIB13.

If the UE is not capable of MBMS Service Continuity but has knowledge on which downlink only frequency, on which frequency used by dedicated MBMS cells, on which frequency used by FeMBMS/Unicast-mixed cells as defined in TS 36.300 [2] or on which frequency belonging to PLMN different from its registered PLMN an MBMS service of interest is provided, it may consider cell reselection candidate frequencies at which it can not receive the MBMS service to be of the lowest priority during the MBMS session TS 36.300 [2] as long as the cell on the MBMS frequency which the UE monitors is broadcasting SIB13 or SIB1-MBMS.

NOTE 3: The UE considers that the MBMS session is ongoing using the session start and end times as provided by upper layers in the USD i.e. the UE does not verify if the session is indicated on MCCH.

In case UE receives *RRCConnectionReject* with *deprioritisationReq*, UE shall consider current carrier frequency and stored frequencies due to the previously received *RRCConnectionReject* with *deprioritisationReq* or all the frequencies of EUTRA to be the lowest priority frequency (i.e. lower than any of the network configured values) while T325 is running irrespective of camped RAT. The UE shall delete the stored deprioritisation request(s) when a PLMN selection is performed on request by NAS TS 23.122 [5].

NOTE 4: Connecting to CDMA2000 does not imply PLMN selection.

NOTE 5: UE should search for a higher priority layer for cell reselection as soon as possible after the change of priority. The minimum related performance requirements specified in TS 36.133 [10] are still applicable.

The UE shall delete priorities provided by dedicated signalling when:

- the UE enters a different RRC state; or
- the optional validity time of dedicated priorities (T320) expires; or
- a PLMN selection is performed on request by NAS TS 23.122 [5].

NOTE 6: Equal priorities between RATs are not supported.

The UE shall only perform cell reselection evaluation for E-UTRAN frequencies and inter-RAT frequencies that are given in system information and for which the UE has a priority provided.

The UE shall not consider any black listed cells as candidate for cell reselection.

The UE shall inherit the priorities provided by dedicated signalling and the remaining validity time (i.e., T320 in E-UTRA and NR, T322 in UTRA and T3230 in GERAN), if configured, at inter-RAT cell (re)selection.

NOTE 7: The network may assign dedicated cell reselection priorities for frequencies not configured by system information.

While T360 is running, redistribution target is considered to be the highest priority (i.e. higher than any of the network configured values). UE shall continue to consider the serving frequency as the highest priority until completion of E-UTRAN Inter-frequency Redistribution procedure specified in 5.2.4.10 if triggered on T360 expiry/ stop.

[TS 36.304, clause 5.2.4.2]

Following rules are used by the UE to limit needed measurements:

- If the serving cell fulfils $S_{rxlev} > S_{IntraSearchP}$ and $S_{qual} > S_{IntraSearchQ}$, the UE may choose not to perform intra-frequency measurements.
- Otherwise, the UE shall perform intra-frequency measurements.
- The UE shall apply the following rules for NR inter-frequencies and inter-RAT frequencies which are indicated in system information and for which the UE has priority provided as defined in 5.2.4.1:
 - For a NR inter-frequency or inter-RAT frequency with a reselection priority higher than the reselection priority of the current NR frequency, the UE shall perform measurements of higher priority NR inter-frequency or inter-RAT frequencies according to TS 38.133 [8].
 - For a NR inter-frequency with an equal or lower reselection priority than the reselection priority of the current NR frequency and for inter-RAT frequency with lower reselection priority than the reselection priority of the current NR frequency:
 - If the serving cell fulfils $S_{rxlev} > S_{nonIntraSearchP}$ and $S_{qual} > S_{nonIntraSearchQ}$, the UE may choose not to perform measurements of NR inter-frequencies or inter-RAT frequency cells of equal or lower priority;
 - Otherwise, the UE shall perform measurements of NR inter-frequencies or inter-RAT frequency cells of equal or lower priority according to TS 38.133 [8].

[TS 36.304, clause 5.2.4.5]

For NB-IoT inter-frequency cell reselection shall be based on ranking as defined in sub-clause 5.2.4.6.

If *threshServingLowQ* is provided in *SystemInformationBlockType3* and more than 1 second has elapsed since the UE camped on the current serving cell, cell reselection to a cell on a higher priority E-UTRAN frequency or inter-RAT frequency than the serving frequency shall be performed if:

- A cell of a higher priority EUTRAN, NR or UTRAN FDD RAT/ frequency fulfils $S_{qual} > Thresh_{X, HighQ}$ during a time interval $T_{reselection_{RAT}}$; or
- A cell of a higher priority UTRAN TDD, GERAN or CDMA2000 RAT/ frequency fulfils $S_{rxlev} > Thresh_{X, HighP}$ during a time interval $T_{reselection_{RAT}}$.

Otherwise, cell reselection to a cell on a higher priority E-UTRAN frequency or inter-RAT frequency than the serving frequency shall be performed if:

- A cell of a higher priority RAT/ frequency fulfils $S_{rxlev} > Thresh_{X, HighP}$ during a time interval $T_{reselection_{RAT}}$; and
- More than 1 second has elapsed since the UE camped on the current serving cell.

Cell reselection to a cell on an equal priority E-UTRAN frequency shall be based on ranking for Intra-frequency cell reselection as defined in sub-clause 5.2.4.6.

If *threshServingLowQ* is provided in *SystemInformationBlockType3* and more than 1 second has elapsed since the UE camped on the current serving cell, cell reselection to a cell on a lower priority E-UTRAN frequency or inter-RAT frequency than the serving frequency shall be performed if:

- The serving cell fulfils $S_{qual} < \text{Thresh}_{\text{Serving,LowQ}}$ and a cell of a lower priority EUTRAN, NR or UTRAN FDD RAT/ frequency fulfils $S_{qual} > \text{Thresh}_{X,LowQ}$ during a time interval $\text{Treselection}_{\text{RAT}}$; or
- The serving cell fulfils $S_{qual} < \text{Thresh}_{\text{Serving,LowQ}}$ and a cell of a lower priority UTRAN TDD, GERAN or CDMA2000 RAT/ frequency fulfils $S_{rxlev} > \text{Thresh}_{X,LowP}$ during a time interval $\text{Treselection}_{\text{RAT}}$.

Otherwise, cell reselection to a cell on a lower priority E-UTRAN frequency or inter-RAT frequency than the serving frequency shall be performed if:

- The serving cell fulfils $S_{rxlev} < \text{Thresh}_{\text{Serving,LowP}}$ and a cell of a lower priority RAT/ frequency fulfils $S_{rxlev} > \text{Thresh}_{X,LowP}$ during a time interval $\text{Treselection}_{\text{RAT}}$; and
- More than 1 second has elapsed since the UE camped on the current serving cell.

Cell reselection to a higher priority RAT/ frequency shall take precedence over a lower priority RAT/ frequency, if multiple cells of different priorities fulfil the cell reselection criteria.

The UE shall not perform cell reselection to NR or UTRAN FDD cells for which the cell selection criterion S is not fulfilled.

For cdma2000 RATs, S_{rxlev} is equal to $-\text{FLOOR}(-2 \times 10 \times \log_{10} E_c/I_o)$ in units of 0.5 dB, as defined in [18], with E_c/I_o referring to the value measured from the evaluated cell.

For cdma2000 RATs, $\text{Thresh}_{X,HighP}$ and $\text{Thresh}_{X,LowP}$ are equal to -1 times the values signalled for the corresponding parameters in the system information.

In all the above criteria the value of $\text{Treselection}_{\text{RAT}}$ is scaled when the UE is in the medium or high mobility state as defined in subclause 5.2.4.3.1. If more than one cell meets the above criteria, the UE shall reselect a cell as follows:

- If the highest-priority frequency is an E-UTRAN frequency, a cell ranked as the best cell among the cells on the highest priority frequency(ies) meeting the criteria according to clause 5.2.4.6;
- If the highest-priority frequency is from another RAT, a cell ranked as the best cell among the cells on the highest priority frequency(ies) meeting the criteria of that RAT.

Cell reselection to another RAT, for which S_{qual} based cell reselection parameters are broadcast in system information, shall be performed based on the S_{qual} criteria if the UE supports S_{qual} (RSRQ) based cell reselection to E-UTRAN from all the other RATs provided by system information which UE supports. Otherwise, cell reselection to another RAT shall be performed based on S_{rxlev} criteria.

Cell reselection to NR, for which a cell reselection parameter, $q\text{-}RxLevMinSUL$ is broadcast in system information and the UE supports SUL, shall be performed based on S_{rxlev} criteria taking the parameter into account.

6.2.3.2.3 Test description

6.2.3.2.3.1 Pre-test conditions

System Simulator:

- E-UTRA Cell 1 and NR Cell 1.
- System information combination 31 as defined in TS 36.508 [7] clause 4.4.3.1, and message contents defined in clause 4.4.3.3 with QBASED condition is used in E-UTRA cell.
- System information combination NR-6 as defined in TS 38.508-1 [4] clause 4.4.3.1.3, and message contents defined in clause 4.6.1 and clause 4.6.2 with QBASED condition is used in NR Cell.

UE:

None.

Preamble:

-

With E-UTRA Cell 1 "Non-suitable "Off" cell" and NR Cell 1 "Serving cell" in accordance with TS 38.508-1 [4], Table 6.2.2.1-3, the UE is brought to state 1N-A, RRC_IDLE Connectivity (NR), in accordance with the procedure described in TS 38.508-1 [4], Table 4.5.2.2-2. 5G-GUTI and ngKSI are assigned and security context established.

The UE is switched-off.

With E-UTRA Cell 1 "Serving cell" and NR Cell 1 "Non-suitable "Off" cell" in accordance with TS 38.508-1 [4], Table 6.2.2.1-3, the UE is brought to state RRC_IDLE Connectivity (E) in accordance with the procedure described in TS 38.508-1 [4], Table 4.5.2.2-1. 4G-GUTI and eKSI are assigned and security context established.

6.2.3.2.3.2 Test procedure sequence

Table 6.2.3.2.3.2-1/2 illustrate the downlink power levels and other changing parameters to be applied for the cell at various time instants of the test execution. The exact instants on which these values shall be applied are described in the texts in this clause. Configurations marked "T1", "T2" and "T3" are applied at the points indicated in the Main behaviour description in Table 6.2.3.2.3.2-3.

Table 6.2.3.2.3.2-1: Time instances of cell power level and parameter changes for E-UTRA Cell and NR Cell in FR1

	Parameter	Unit	E-UTRA Cell 1	NR Cell 1	Remark
T1	Cell-specific RS EPRE	dBm/15kHz	-95	-	The power level values are assignen to ensure UE reselected to NR Cell 1: both $Squal_{ServingCell, E-UTRA Cell1} < Thresh_{Serving, LowQ}$ and $Squal_{nonServingCell, NR Cell1} > Thresh_{NR Cell1, LowQ}$
	SS/PBCH SSS EPRE	dBm/SCS	-	-80	
	RSRQ	dB	-11.46	-11.17	
	Qqualmin	dB	-20	-25	
	NOCE-UTRA	dBm/15kHz	-95	-	
	NOCNR	dBm/SCS	-	-90	
T2	Cell-specific RS EPRE	dBm/15kHz	-80	-	The power level values are assignen to ensure UE reselected back to E-UTRA Cell 1: $Squal_{nonServingCell, E-UTRA Cell1} > Thresh_{E-UTRA Cell1, HighQ}$
	SS/PBCH SSS EPRE	dBm/SCS	-	-95	
	RSRQ	dB	-3.76	-16.98	
	Qqualmin	dB	-20	-25	
	NOCE-UTRA	dBm/15kHz	-95	-	
	NOCNR	dBm/SCS	-	-90	
T3	Cell-specific RS EPRE	dBm/15kHz	-95	-	The power level values are assignen to ensure UE reselected to NR Cell 1: $Squal_{nonServingCell, NR Cell1} > Thresh_{NR Cell1, HighQ}$
	SS/PBCH SSS EPRE	dBm/SCS	-	-80	
	RSRQ	dB	-11.46	-11.17	
	Qqualmin	dB	-20	-25	
	NOCE-UTRA	dBm/15kHz	-95	-	
	NOCNR	dBm/SCS	-	-90	

Table 6.2.3.2.3.2-2: Time instances of cell power level and parameter changes for E-UTRA Cell and NR Cell in FR2

	Parameter	Unit	E-UTRA Cell 1	NR Cell 1	Remark
T1	Cell-specific RS EPRE	dBm/15kHz	FFS	-	The power level values are assignen to ensure UE reselected to NR Cell 1: both $Squal_{ServingCell, E-UTRA Cell1} < Thresh_{Serving, LowQ}$ and $Squal_{nonServingCell, NR Cell1} > Thresh_{NR Cell1, LowQ}$
	SS/PBCH SSS EPRE	dBm/SCS	-	FFS	
	RSRQ	dB	FFS	FFS	
	Qqualmin	dB	-20	-25	
	NOCE-UTRA	dBm/15kHz	FFS	-	
	NOCNR	dBm/SCS	-	FFS	

T2	Cell-specific RS EPRE	dBm/15kHz	FFS	-	The power level values are assignen to ensure UE reselected back to E-UTRA Cell 1: $Squal_{nonServingCell, E-UTRA Cell1} > Thresh_{E-UTRA Cell1, HighQ}$
	SS/PBCH SSS EPRE	dBm/SCS	-	FFS	
	RSRQ	dB	FFS	FFS	
	Qqualmin	dB	-20	-25	
	NoCE-UTRA	dBm/15kHz	FFS	-	
	NoCNr	dBm/SCS	-	FFS	
T3	Cell-specific RS EPRE	dBm/15kHz	FFS	-	The power level values are assignen to ensure UE reselected to NR Cell 1: $Squal_{nonServingCell, NR Cell1} > Thresh_{NR Cell1, HighQ}$
	SS/PBCH SSS EPRE	dBm/SCS	-	FFS	
	RSRQ	dB	FFS	FFS	
	Qqualmin	dB	-20	-25	
	NoCE-UTRA	dBm/15kHz	FFS	-	
	NoCNr	dBm/SCS	-	FFS	

Table 6.2.3.2.3.2-3: Main behaviour

St	Procedure	Message Sequence		TP	Verdict
		U - S	Message		
1	The SS changes Cell-specific RS EPRE level for E-UTRA Cell 1 and SS/PBCH SSS EPRE level for NR Cell 1 according to row "T1" in table 6.2.3.2.3.2-1/2.	-	-	-	-
2	Check: Does the test result of generic test procedure in TS 38.508-1 [4] Table 4.9.9.2.2-1 indicate that the UE is camped on NR Cell 1?			1	-
3	The SS transmits an <i>RRCRRelease</i> message on NR Cell 1.	<--	NR RRC: <i>RRCRRelease</i>		
4	The SS changes Cell-specific RS EPRE level for E-UTRA Cell 1 and SS/PBCH SSS EPRE level for NR Cell 1 according to row "T2" in table 6.2.3.2.3.2-1/2.	-	-	-	-
5	The UE selects E-UTRAN Cell 1 and performs the generic test procedure in TS 38.508-1 [4] Table 4.9.7.2.2 from steps 1-6.	-	-	-	-
6	The SS transmits an <i>RRCCOnnectionRelease</i> message to release RRC connection and move to RRC_IDLE on E-UTRAN Cell 1.	<--	E-UTRA RRC: <i>RRCCOnnectionRelease</i>	-	-
7	The SS changes the NR cell priority broadcast in system information on E-UTRAN Cell 1.	-	-	-	-
8	Notify UE change of System Information on E-UTRAN Cell 1.	<--	E-UTRA RRC: <i>Paging</i>		
9	Wait for 6 s for UE to receive system information.	-	-	-	-
10	The SS changes Cell-specific RS EPRE level for E-UTRA Cell 1 and SS/PBCH SSS EPRE level for NR Cell 1 according to row "T3" in table 6.2.3.2.3.2-1/2.	-	-	-	-
11	Check: Does the test result of generic test procedure in TS 38.508-1 [4] Table 4.9.9.2.2-1 indicate that the UE is camped on NR Cell 1? NOTE: This is the first time in this test case that the UE moves from S1 to N1.	-	-	2	-
12	Void.	-	-	-	-

6.2.3.2.3.3 Specific message contents

Table 6.2.3.2.3.3-1: SystemInformationBlockType1 for E-UTRA Cell 1 (preamble and all steps, Table 6.2.3.2.3.2-3)

Derivation path: TS 36.508-1 [7], Table 4.4.3.2-3			
Information Element	Value/Remark	Comment	Condition
SystemInformationBlockType1 ::= SEQUENCE {			
nonCriticalExtension SEQUENCE {			
nonCriticalExtension SEQUENCE {			
cellSelectionInfo-v920 SEQUENCE {			
q-QualMin-r9	-20		
}			
}			
}			
}			

Table 6.2.3.2.3.3-2: SystemInformationBlockType3 for E-UTRA Cell 1 (preamble and all steps, Table 6.2.3.2.3.2-3)

Derivation path: TS 36.508 [7], Table 4.4.3.3-2			
Information Element	Value/Remark	Comment	Condition
SystemInformationBlockType3 ::= SEQUENCE {			
lateNonCriticalExtension {			
q-QualMin-r9	-20		
threshServingLowQ-r9	12		
}			
}			

Table 6.2.3.2.3.3-3: SystemInformationBlockType24 for E-UTRA Cell 1 (preamble, Table 6.2.3.2.3.2-3)

Derivation path: TS 36.508 [7], Table 4.4.3.3-20			
Information Element	Value/remark	Comment	Condition
SystemInformationBlockType24-r15 ::= SEQUENCE {			
carrierFreqListNR-r15 SEQUENCE (SIZE (1..maxFreq)) OF CarrierFreqNR-r15 {	1 entry		
CarrierFreqNR-r15[1] SEQUENCE {		entry 1	
carrierFreq-r15	Downlink NR ARFCN of SSB for NR Cell 1		
cellReselectionPriority-r15	3		
threshX-Q-r15 SEQUENCE {			
threshX-HighQ-r15	20		
threshX-LowQ-r15	5		
}			
q-QualMin-r15	-25		
}			
t-ReselectionNR-r15	7		
}			

Table 6.2.3.2.3.3-4: SIB1 for NR Cell 1 (preamble and all steps, Table 6.2.3.2.3.2-3)

Derivation path: TS 38.508-1 [4], Table 4.6.1-28			
Information Element	Value/Remark	Comment	Condition
SIB1 ::= SEQUENCE {			
cellSelectionInfo SEQUENCE {			
q-QualMin	-25	-25dB	
}			
}			

Table 6.2.3.2.3.3-5: SIB2 for NR Cell 1 (preamble and all steps, Table 6.2.3.2.3.2-3)

Derivation path: TS 38.508-1 [4], Table 4.6.2-1			
Information Element	Value/Remark	Comment	Condition
SIB2 ::= SEQUENCE {			
cellReselectionServingFreqInfo SEQUENCE {			
threshServingLowQ	26		
}			
}			

Table 6.2.3.2.3.3-6: SIB5 for NR Cell 1 (preamble and all steps, Table 6.2.3.2.3.2-3)

Derivation path: TS 38.508-1 [4], Table 4.6.2-4			
Information Element	Value/Remark	Comment	Condition
SIB5 ::= SEQUENCE {			
carrierFreqListEUTRA SEQUENCE (SIZE (1..maxEUTRA-Carrier)) OF CarrierFreqEUTRA {	1 entry		
CarrierFreqEUTRA[1] SEQUENCE {		entry 1	
carrierFreq	Downlink EUTRA ARFCN as E-UTRA Cell 1 used		
}			
cellReselectionPriority	5		
threshX-Q SEQUENCE {			
threshX-HighQ	12		
threshX-LowQ	5		
}			
}			
t-ReselectionEUTRA	7		
}			

Table 6.2.3.2.3.3-7: SystemInformationBlockType24 for E-UTRA Cell 1 (step 7, Table 6.2.3.2.3.2-3)

Derivation path: TS 36.508 [7], Table 4.4.3.3-20			
Information Element	Value/remark	Comment	Condition
SystemInformationBlockType24-r15 ::= SEQUENCE {			
carrierFreqListNR-r15 SEQUENCE (SIZE (1..maxFreq)) OF CarrierFreqNR-r15 {	1 entry		
CarrierFreqNR-r15[1] SEQUENCE {		entry 1	
carrierFreq-r15	Downlink NR ARFCN of SSB for NR Cell 1		
}			
cellReselectionPriority-r15	5		
threshX-Q-r15 SEQUENCE {			
threshX-HighQ-r15	5		
threshX-LowQ-r15	20		
}			
q-QualMin-r15	-25		
}			
t-ReselectionNR-r15	7		
}			

Table 6.2.3.2.3.3-8: Paging for E-UTRA Cell 1 (step 8, Table 6.2.3.2.3.2-3)

Derivation path: TS 36.508 [7], Table 4.6.1-7			
Information Element	Value/Remark	Comment	Condition
Paging ::= SEQUENCE {			
pagingRecordList	Not present		
systemInfoModification	True		
etws-PrimaryNotificationIndication	Not present		
nonCriticalExtension	Not present		
}			

Table 6.2.3.2.3.3-9: SystemInformationBlockType1 for E-UTRA Cell 1 (step 9, Table 6.2.3.2.3.2-3)

Derivation path: TS 36.508-1 [7], Table 4.4.3.2-3			
Information Element	Value/Remark	Comment	Condition
SystemInformationBlockType1 ::= SEQUENCE {			
systemInfoValueTag	1		
}			

Table 6.2.3.2.3.3-10: REGISTRATION REQUEST (Step 11, Table 6.2.3.2.3.2-3)

Derivation Path: TS 38.508-1 [4], Table 4.7.1-6.			
Information Element	Value/remark	Comment	Condition
EPS NAS message container	TRACKING AREA UPDATE REQUEST message	See Table 6.2.3.2.3.3-11	

Table 6.2.3.2.3.3-11: TRACKING AREA UPDATE REQUEST (Table 6.2.3.2.3.3-10)

Derivation Path: TS 38.508-1 [4], Table 4.9.9.2.3-2 with condition Mapped EPS security context
--

6.2.3.3 Inter-RAT cell reselection / From NR RRC_IDLE to E-UTRA_IDLE (lower priority & higher priority, Srxlev based)

6.2.3.3.1 Test Purpose (TP)

(1)

```
with { UE in NR RRC_Idle state }
ensure that {
  when { UE detects the cell re-selection criteria are met for the cell which belongs to the higher
priority E-UTRA frequency }
  then { UE reselects to the E-UTRA cell }
}
```

(2)

```
with { UE in NR RRC_Idle state }
ensure that {
  when { UE detects the cell re-selection criteria are met for the neighbour cell which belongs to
the lower priority E-UTRA frequency }
  then { UE reselects to the E-UTRA cell }
}
```

6.2.3.3.2 Conformance requirements

References: The conformance requirements covered in the present TC are specified in: 3GPP TS 38.304, clause 5.2.4.1, 5.2.4.2 and 5.2.4.5. Unless otherwise stated these are Rel-15 requirements.

[TS 38.304, clause 5.2.4.1]

Absolute priorities of different NR frequencies or inter-RAT frequencies may be provided to the UE in the system information, in the *RRCRelease* message, or by inheriting from another RAT at inter-RAT cell (re)selection. In the case of system information, an NR frequency or inter-RAT frequency may be listed without providing a priority (i.e. the field *cellReselectionPriority* is absent for that frequency). If priorities are provided in dedicated signalling, the UE shall ignore all the priorities provided in system information. If UE is in *camped on any cell* state, UE shall only apply the priorities provided by system information from current cell, and the UE preserves priorities provided by dedicated signalling and *deprioritisationReq* received in *RRCRelease* unless specified otherwise. When the UE in camped normally state, has only dedicated priorities other than for the current frequency, the UE shall consider the current frequency to be the lowest priority frequency (i.e. lower than any of the network configured values).

The UE shall only perform cell reselection evaluation for NR frequencies and inter-RAT frequencies that are given in system information and for which the UE has a priority provided.

In case UE receives *RRCRelease* with *deprioritisationReq*, UE shall consider current frequency and stored frequencies due to the previously received *RRCRelease* with *deprioritisationReq* or all the frequencies of NR to be the lowest priority frequency (i.e. lower than any of the network configured values) while T325 is running irrespective of camped RAT. The UE shall delete the stored deprioritisation request(s) when a PLMN selection is performed on request by NAS (TS 23.122 [9]).

NOTE: UE should search for a higher priority layer for cell reselection as soon as possible after the change of priority. The minimum related performance requirements specified in TS 38.133 [8] are still applicable.

The UE shall delete priorities provided by dedicated signalling when:

- the UE enters a different RRC state; or
- the optional validity time of dedicated priorities (T320) expires; or
- a PLMN selection is performed on request by NAS (TS 23.122 [9]).

NOTE 2: Equal priorities between RATs are not supported.

The UE shall not consider any black listed cells as candidate for cell reselection.

The UE shall inherit the priorities provided by dedicated signalling and the remaining validity time (i.e. T320 in NR and E-UTRA), if configured, at inter-RAT cell (re)selection.

NOTE 3: The network may assign dedicated cell reselection priorities for frequencies not configured by system information.

[TS 38.304, clause 5.2.4.1]

Following rules are used by the UE to limit needed measurements:

- If the serving cell fulfils $S_{rxlev} > S_{IntraSearchP}$ and $S_{qual} > S_{IntraSearchQ}$, the UE may choose not to perform intra-frequency measurements.
- Otherwise, the UE shall perform intra-frequency measurements.
- The UE shall apply the following rules for NR inter-frequencies and inter-RAT frequencies which are indicated in system information and for which the UE has priority provided as defined in 5.2.4.1:
 - For a NR inter-frequency or inter-RAT frequency with a reselection priority higher than the reselection priority of the current NR frequency, the UE shall perform measurements of higher priority NR inter-frequency or inter-RAT frequencies according to TS 38.133 [8].
 - For a NR inter-frequency with an equal or lower reselection priority than the reselection priority of the current NR frequency and for inter-RAT frequency with lower reselection priority than the reselection priority of the current NR frequency:
 - If the serving cell fulfils $S_{rxlev} > S_{nonIntraSearchP}$ and $S_{qual} > S_{nonIntraSearchQ}$, the UE may choose not to perform measurements of NR inter-frequencies or inter-RAT frequency cells of equal or lower priority;
 - Otherwise, the UE shall perform measurements of NR inter-frequencies or inter-RAT frequency cells of equal or lower priority according to TS 38.133 [8].

[TS 38.304, clause 5.2.4.5]

If *threshServingLowQ* is broadcast in system information and more than 1 second has elapsed since the UE camped on the current serving cell, cell reselection to a cell on a higher priority NR frequency or inter-RAT frequency than the serving frequency shall be performed if:

- A cell of a higher priority NR or EUTRAN RAT/frequency fulfils $S_{qual} > Thresh_{X, HighQ}$ during a time interval $T_{reselection_{RAT}}$

Otherwise, cell reselection to a cell on a higher priority NR frequency or inter-RAT frequency than the serving frequency shall be performed if:

- A cell of a higher priority RAT/ frequency fulfils $S_{rxlev} > Thresh_{X, HighP}$ during a time interval $T_{reselection_{RAT}}$; and
- More than 1 second has elapsed since the UE camped on the current serving cell.

Cell reselection to a cell on an equal priority NR frequency shall be based on ranking for intra-frequency cell reselection as defined in sub-clause 5.2.4.6.

If *threshServingLowQ* is broadcast in system information and more than 1 second has elapsed since the UE camped on the current serving cell, cell reselection to a cell on a lower priority NR frequency or inter-RAT frequency than the serving frequency shall be performed if:

- The serving cell fulfils $S_{qual} < Thresh_{Serving, LowQ}$ and a cell of a lower priority NR or E-UTRAN RAT/ frequency fulfils $S_{qual} > Thresh_{X, LowQ}$ during a time interval $T_{reselection_{RAT}}$.

Otherwise, cell reselection to a cell on a lower priority NR frequency or inter-RAT frequency than the serving frequency shall be performed if:

- The serving cell fulfils $S_{rxlev} < Thresh_{Serving, LowP}$ and a cell of a lower priority RAT/ frequency fulfils $S_{rxlev} > Thresh_{X, LowP}$ during a time interval $T_{reselection_{RAT}}$; and
- More than 1 second has elapsed since the UE camped on the current serving cell.

Cell reselection to a higher priority RAT/frequency shall take precedence over a lower priority RAT/frequency if multiple cells of different priorities fulfil the cell reselection criteria.

If more than one cell meets the above criteria, the UE shall reselect a cell as follows:

- If the highest-priority frequency is an NR frequency, the highest ranked cell among the cells on the highest priority frequency(ies) meeting the criteria according to clause 5.2.4.6;
- If the highest-priority frequency is from another RAT, the highest ranked cell among the cells on the highest priority frequency(ies) meeting the criteria of that RAT.

6.2.3.3.3 Test description

6.2.3.3.3.1 Pre-test conditions

System Simulator:

- NR Cell 1, E-UTRA Cell 1 is different priority inter-RAT Cell.
- System information combination NR-6 as defined in TS 38.508-1 [4] clause 4.4.3.1.3 is used in NR Cell.
- System information combination 31 as defined in TS 36.508-1 [18] clause 4.4.3.1 is used in E-UTRA Cell.

UE:

None.

Preamble:

- With E-UTRA Cell 1 "Serving cell" and NR Cell 1 "Non-suitable "Off" cell" in accordance with TS 38.508-1 [4], Table 6.2.2.1-3, the UE is brought to state RRC_IDLE Connectivity (*E-UTRA/EPC*) in accordance with the procedure described in TS 38.508-1 [4], Table 4.5.2.2-1. 4G GUTI and eKSI are assigned and security context established.
- the UE is switched-off.
- With E-UTRA Cell 1 "Non-suitable "Off" cell" and NR Cell 1 "Serving cell" in accordance with TS 38.508-1 [4], Table 6.2.2.1-3, the UE is brought to state 1N-A, RRC_IDLE Connectivity (NR), in accordance with the procedure described in TS 38.508-1 [4], Table 4.5.2.2-2. 5G-GUTI and ngKSI are assigned and security context established.

6.2.3.3.3.2 Test procedure sequence

Table 6.2.3.3.3.2-1/2 illustrate the downlink power levels and other changing parameters to be applied for the cell at various time instants of the test execution. The exact instants on which these values shall be applied are described in the texts in this clause. Row marked "T0" denotes the conditions in the preamble. Configurations marked "T1", "T2" and "T3" are applied at the points indicated in the Main behaviour description in Table 6.2.3.3.3.2-3.

Table 6.2.3.3.3.2-1: Time instances of cell power level and parameter changes for E-UTRA Cell 1 and NR Cell 1 in FR1

	Parameter	Unit	NR Cell 1	E-UTRA Cell 1	Remark
T0	Cell-specific RS EPRE	dBm/15kHz	-	-Off	The power level values are assigned to ensure UE registered on NR Cell 1
	SS/PBCH SSS EPRE	dBm/SCS	-88	-	
T1	Cell-specific RS EPRE	dBm/15kHz	-	-75	The power level values are assigned to satisfy $Srxle^{E-UTRA\ Cell\ 1} > Thresh_{x, high}$
	SS/PBCH SSS EPRE	dBm/SCS	-95	-	
T2	Cell-specific RS EPRE	dBm/15kHz	-	-95	The power level values are assigned to ensure UE reselected back to NR Cell 1: both $Srxle^{E-UTRA\ Cell\ 1} < Thresh_{serv, low}$ and $Srxle^{NR\ Cell\ 1} > Thresh_{x, low}$.
	SS/PBCH SSS EPRE	dBm/SCS	-78	-	
T3	Cell-specific RS EPRE	dBm/15kHz	-	-75	The power level values are assigned to satisfy both $Srxle^{NR\ Cell\ 1} < Thresh_{serv, low}$ and $Srxle^{E-UTRA\ Cell\ 1} > Thresh_{x, low}$.
	SS/PBCH SSS EPRE	dBm/SCS	-95	-	

Table 6.2.3.3.3.2-2: Time instances of cell power level and parameter changes for E-UTRA Cell 1 and NR Cell 1 in FR2

	Parameter	Unit	NR Cell 1	E-UTRA Cell 1	Remark
T0	Cell-specific RS EPRE	dBm/15kHz	-	-Off	The power level values are assigned to ensure UE registered on NR Cell 1
	SS/PBCH SSS EPRE	dBm/SCS	FFS	-	
T1	Cell-specific RS EPRE	dBm/15kHz	-	-75	The power level values are assigned to satisfy $Srxle^{E-UTRA\ Cell\ 1} > Thresh_{x, high}$
	SS/PBCH SSS EPRE	dBm/SCS	FFS	-	
T2	Cell-specific RS EPRE	dBm/15kHz	-	-95	The power level values are assigned to ensure UE reselected back to NR Cell 1: both $Srxle^{E-UTRA\ Cell\ 1} < Thresh_{serv, low}$ and $Srxle^{NR\ Cell\ 1} > Thresh_{x, low}$.
	SS/PBCH SSS EPRE	dBm/SCS	FFS	-	

T3	Cell-specific RS EPRE	dBm/15kHz	-	-75	The power level values are assigned to satisfy both $Srxlev_{NR\ Cell\ 1} < Thresh_{serving, low}$ and $Srxlev_{E-UTRA\ Cell\ 1} > Thresh_{x, low}$.
	SS/PBCH SSS EPRE	dBm/SCS	FFS	-	

Table 6.2.3.3.3.2-3: Main behaviour

St	Procedure	Message Sequence		TP	Verdict
		U - S	Message		
1	The SS adjusts the NR and E-UTRAN Cell power levels according to row "T1" in table 6.2.3.3.3.2-1/2.	-	-	-	-
2	Void	-	-	-	-
3	Check: Does the test result of generic test procedure in TS 38.508-1 [4] Table 4.9.7.2.2-1 is performed and the UE is camped on E-UTRAN Cell 1?	-	-	1	-
4	The SS adjusts the NR and E-UTRAN Cell power levels according to row "T2" in table 6.2.3.3.3.2-1/2.	-	-	-	-
5	Void	-	-	-	-
6	Generic test procedure in TS 38.508-1 [4] Table 4.9.9.2.2-1 take place and UE is camped on NR Cell 1	-	-	-	-
7	The SS transmits RRCRelease message on NR Cell 1.	<-	NR:RRCRelease		
8	The SS notifies the UE of change of System Information on NR Cell 1 by send Short Message on PDCCH using P-RNTI.	<-	NR: ShortMessage	-	-
9	The SS changes <i>Priority</i> of E-UTRA cell 1 in the <i>SIB5</i> of NR Cell 1, The <i>Value Tag</i> of <i>SIB5</i> in the <i>SIB1</i> is increased on NR Cell 1.	-	-	-	-
10	Wait for 2.1* modification period to allow the new system information to take effect.	-	-	-	-
11	The SS adjusts the NR and E-UTRAN Cell power levels according to row "T3" in table 6.2.3.3.3.2-1/2.	-	-	-	-
12	Void	-	-	-	-
13	Check: Does the test result of generic test procedure in TS 38.508-1 [4] Table 4.9.7.2.2-1 is performed and the UE is camped on E-UTRAN Cell 1?	-	-	2	-

6.2.3.3.3.3 Specific message contents

Table 6.2.3.3.3.3-1: SIB2 of NR Cell 1(preamble and all steps, Table 6.2.3.3.3.2-3)

Derivation Path: TS 38.508-1 [4], Table 4.6.2-1			
Information Element	Value/remark	Comment	Condition
SIB2 ::= SEQUENCE {			
cellReselectionServingFreqInfo SEQUENCE {			
threshServingLowP	10	20 dB	
}			
}			

Table 6.2.3.3.3.2-: SIB5 of NR Cell 1(preamble and all steps, Table 6.2.3.3.3.2-3)

Derivation Path: TS 38.508-1 [4], Table 4.6.2-4			
Information Element	Value/remark	Comment	Condition
SIB5 ::= SEQUENCE {			
carrierFreqListEUTRA SEQUENCE (SIZE (1..maxEUTRA-Carrier)) OF CarrierFreqEUTRA {	1 entry		
CarrierFreqEUTRA[1] SEQUENCE {		entry 1	
carrierFreq	Downlink EUTRA ARFCN as E-UTRA Cell 1 used		
cellReselectionPriority	5		
threshX-High	10	20 dB	
threshX-Low	20	40 dB	
}			
}			
t-ReselectionEUTRA	7	7 Seconds	
}			

Table 6.2.3.3.3.3-3: SystemInformationBlockType3 of EUTRA Cell 1 (preamble and all steps, Table 6.2.3.3.3.2-3)

Derivation Path: TS 36.508 [7], Table 4.4.3.3-2			
Information Element	Value/remark	Comment	Condition
SystemInformationBlockType3 ::= SEQUENCE {			
cellReselectionServingFreqInfo SEQUENCE {			
threshServingLow	10	20 dB	
}			
}			

Table 6.2.3.3.3.3-4: SystemInformationBlockType24 of EUTRA Cell 1 (preamble and all steps, Table 6.2.3.3.3.2-3)

Derivation path: TS 36.508 [7], Table 4.4.3.3-20			
Information Element	Value/Remark	Comment	Condition
SystemInformationBlockType24-r15 ::= SEQUENCE {			
carrierFreqListNR-r15 SEQUENCE (SIZE (1..maxFreq)) OF CarrierFreqNR-r15 {	1 entry		
CarrierFreqNR-r15[1] SEQUENCE {		entry 1	
carrierFreq-r15	Same downlink SSB ARFCN as used for NR Cell 1		
cellReselectionPriority-r15	3		
threshX-High-r15	20	40 dB	
threshX-Low-r15	10	20 dB	
}			
}			
t-ReselectionNR-r15	7	7 Seconds	
}			

Table 6.2.3.3.3.3-5: SIB5 of NR Cell 1 (Step 9, Table 6.2.3.3.3.2-3)

Derivation Path: TS 38.508-1 [4], Table 4.6.2-4			
Information Element	Value/remark	Comment	Condition
SIB5 ::= SEQUENCE {			
carrierFreqListEUTRA SEQUENCE (SIZE (1..maxEUTRA-Carrier)) OF CarrierFreqEUTRA {	1 entry		
CarrierFreqEUTRA[1] SEQUENCE {		entry 1	
carrierFreq	Downlink EUTRA ARFCN as E-UTRA Cell 1 used		
cellReselectionPriority	3		
threshX-High	20	40 dB	
threshX-Low	10	20 dB	
}			
}			
t-ReselectionEUTRA	7	7 Seconds	
}			

Table 6.2.3.3.3.3-6: SIB1 of NR Cell 1 (step 9, Table 6.2.3.3.3.2-3)

Derivation Path: TS 38.508-1 [4], Table 4.6.1-5			
Information Element	Value/remark	Comment	Condition
SIB1 ::= SEQUENCE {			
si-SchedulingInfo	SI-SchedulingInfo		
}			

Table 6.2.3.3.3.3-7: SI-SchedulingInfo (si-SchedulingInfo in Table 6.2.3.3.3.3-6)

Derivation Path: TS 38.508-1 [4], Table 4.6.3-130A			
Information Element	Value/remark	Comment	Condition
SI-SchedulingInfo ::= SEQUENCE {			
schedulingInfoList SEQUENCE (SIZE(1..maxSI-Message)) OF SchedulingInfo {	1 entry		
SchedulingInfo[1] SEQUENCE {		entry 1	
sib-MappingInfo SEQUENCE (SIZE (1..maxSIB)) OF SIB-TypeInfo {	1 entry		
SIB-TypeInfo[1] SEQUENCE {		entry 1	
type	sibType5		
valueTag	1		
}			
}			
}			
}			
}			

Table 6.2.3.3.3.3-8: TRACKING AREA UPDATE REQUEST (Step 3, Table 6.2.3.3.3.2-3)

Derivation Path: TS 38.508-1 [4], Table 4.9.7.2.3-1 with condition First-N1-to-S1 = TRUE
--

Table 6.2.3.3.3.3-9: TRACKING AREA UPDATE REQUEST (Step 13, Table 6.2.3.3.3.2-3)

Derivation Path: TS 38.508-1 [4], Table 4.9.7.2.3-1 with condition First-N1-to-S1 = FALSE

Table 6.2.3.3.3-10: REGISTRATION REQUEST (Step 6, Table 6.2.3.3.3-3)

Derivation Path: TS 38.508-1 [4], Table 4.7.1-6.			
Information Element	Value/remark	Comment	Condition
EPS NAS message container	TRACKING AREA UPDATE REQUEST message	See Table 6.2.3.3.3-12	

Table 6.2.3.3.3-11: TRACKING AREA UPDATE REQUEST (Table 6.2.3.3.3-10)

Derivation Path: TS 36.508 [2], Table 4.7.2-27.			
Information Element	Value/remark	Comment	Condition
EPS update type			
EPS update type Value	'000'B	TA updating	
"Active" flag	'0'B	No bearer establishment requested	
NAS key set identifier			
NAS key set identifier	the eKSI value for the current mapped EPS security context		
TSC	'1'B	mapped security context	

6.2.3.4 Inter-RAT cell reselection / From NR RRC_Idle to E-UTRA_IDLE (lower priority & higher priority, Squal based)

6.2.3.4.1 Test Purpose (TP)

(1)

```
with { UE in NR RRC_Idle state }
ensure that {
  when { UE detects the cell re-selection criteria are met for the cell which belongs to the lower
priority inter-RAT E-UTRA cell }
  then { UE reselects the cell which belongs to the lower priority inter-RAT E-UTRA cell }
}
```

(2)

```
with { UE in NR RRC_Idle state }
ensure that {
  when { UE detects the cell re-selection criteria are met for the cell which belongs to the higher
priority inter-RAT E-UTRA cell }
  then { UE reselects the cell which belongs to the higher priority inter-RAT E-UTRA cell }
}
```

6.2.3.4.2 Conformance requirements

References: The conformance requirements covered in the present TC are specified in: 3GPP TS 38.304, clause 5.2.4.1, 5.2.4.2 and 5.2.4.5. Unless otherwise stated these are Rel-15 requirements.

[TS 38.304, clause 5.2.4.1]

Absolute priorities of different NR frequencies or inter-RAT frequencies may be provided to the UE in the system information, in the *RRCRelease* message, or by inheriting from another RAT at inter-RAT cell (re)selection. In the case of system information, an NR frequency or inter-RAT frequency may be listed without providing a priority (i.e. the field *cellReselectionPriority* is absent for that frequency). If priorities are provided in dedicated signalling, the UE shall ignore all the priorities provided in system information. If UE is in *camped on any cell* state, UE shall only apply the priorities provided by system information from current cell, and the UE preserves priorities provided by dedicated signalling and *deprioritisationReq* received in *RRCRelease* unless specified otherwise. When the UE in camped normally state, has only dedicated priorities other than for the current frequency, the UE shall consider the current frequency to be the lowest priority frequency (i.e. lower than any of the network configured values).

The UE shall only perform cell reselection evaluation for NR frequencies and inter-RAT frequencies that are given in system information and for which the UE has a priority provided.

In case UE receives *RRCRelease* with *deprioritisationReq*, UE shall consider current frequency and stored frequencies due to the previously received *RRCRelease* with *deprioritisationReq* or all the frequencies of NR to be the lowest priority frequency (i.e. lower than any of the network configured values) while T325 is running irrespective of camped RAT. The UE shall delete the stored deprioritisation request(s) when a PLMN selection is performed on request by NAS (TS 23.122 [9]).

NOTE: UE should search for a higher priority layer for cell reselection as soon as possible after the change of priority. The minimum related performance requirements specified in TS 38.133 [8] are still applicable.

The UE shall delete priorities provided by dedicated signalling when:

- the UE enters a different RRC state; or
- the optional validity time of dedicated priorities (T320) expires; or
- a PLMN selection is performed on request by NAS (TS 23.122 [9]).

NOTE 2: Equal priorities between RATs are not supported.

The UE shall not consider any black listed cells as candidate for cell reselection.

The UE shall inherit the priorities provided by dedicated signalling and the remaining validity time (i.e. T320 in NR and E-UTRA), if configured, at inter-RAT cell (re)selection.

NOTE 3: The network may assign dedicated cell reselection priorities for frequencies not configured by system information.

[TS 38.304, clause 5.2.4.1]

Following rules are used by the UE to limit needed measurements:

- If the serving cell fulfils $S_{rxlev} > S_{IntraSearchP}$ and $S_{qual} > S_{IntraSearchQ}$, the UE may choose not to perform intra-frequency measurements.
- Otherwise, the UE shall perform intra-frequency measurements.
- The UE shall apply the following rules for NR inter-frequencies and inter-RAT frequencies which are indicated in system information and for which the UE has priority provided as defined in 5.2.4.1:
 - For a NR inter-frequency or inter-RAT frequency with a reselection priority higher than the reselection priority of the current NR frequency, the UE shall perform measurements of higher priority NR inter-frequency or inter-RAT frequencies according to TS 38.133 [8].
 - For a NR inter-frequency with an equal or lower reselection priority than the reselection priority of the current NR frequency and for inter-RAT frequency with lower reselection priority than the reselection priority of the current NR frequency:
 - If the serving cell fulfils $S_{rxlev} > S_{nonIntraSearchP}$ and $S_{qual} > S_{nonIntraSearchQ}$, the UE may choose not to perform measurements of NR inter-frequencies or inter-RAT frequency cells of equal or lower priority;
 - Otherwise, the UE shall perform measurements of NR inter-frequencies or inter-RAT frequency cells of equal or lower priority according to TS 38.133 [8].

[TS 38.304, clause 5.2.4.5]

If *threshServingLowQ* is broadcast in system information and more than 1 second has elapsed since the UE camped on the current serving cell, cell reselection to a cell on a higher priority NR frequency or inter-RAT frequency than the serving frequency shall be performed if:

- A cell of a higher priority NR or EUTRAN RAT/frequency fulfils $S_{qual} > Thresh_{X, HighQ}$ during a time interval $T_{reselection_{RAT}}$

Otherwise, cell reselection to a cell on a higher priority NR frequency or inter-RAT frequency than the serving frequency shall be performed if:

- A cell of a higher priority RAT/ frequency fulfils $Srxlev > Thresh_{X, HighP}$ during a time interval $Treselection_{RAT}$; and
- More than 1 second has elapsed since the UE camped on the current serving cell.

Cell reselection to a cell on an equal priority NR frequency shall be based on ranking for intra-frequency cell reselection as defined in sub-clause 5.2.4.6.

If $thresh_{ServingLowQ}$ is broadcast in system information and more than 1 second has elapsed since the UE camped on the current serving cell, cell reselection to a cell on a lower priority NR frequency or inter-RAT frequency than the serving frequency shall be performed if:

- The serving cell fulfils $Squal < Thresh_{Serving, LowQ}$ and a cell of a lower priority NR or E-UTRAN RAT/ frequency fulfils $Squal > Thresh_{X, LowQ}$ during a time interval $Treselection_{RAT}$.

Otherwise, cell reselection to a cell on a lower priority NR frequency or inter-RAT frequency than the serving frequency shall be performed if:

- The serving cell fulfils $Srxlev < Thresh_{Serving, LowP}$ and a cell of a lower priority RAT/ frequency fulfils $Srxlev > Thresh_{X, LowP}$ during a time interval $Treselection_{RAT}$; and
- More than 1 second has elapsed since the UE camped on the current serving cell.

Cell reselection to a higher priority RAT/frequency shall take precedence over a lower priority RAT/frequency if multiple cells of different priorities fulfil the cell reselection criteria.

If more than one cell meets the above criteria, the UE shall reselect a cell as follows:

- If the highest-priority frequency is an NR frequency, the highest ranked cell among the cells on the highest priority frequency(ies) meeting the criteria according to clause 5.2.4.6;
- If the highest-priority frequency is from another RAT, the highest ranked cell among the cells on the highest priority frequency(ies) meeting the criteria of that RAT.

6.2.3.4.3 Test description

6.2.3.4.3.1 Pre-test conditions

System Simulator:

- NR Cell 1 and E-UTRA Cell 1
- System information combination NR-6 as defined in TS 38.508-1 [7] clause 4.4.3.1, and message contents defined in clause 4.6.1 and clause 4.6.2 with QBASED condition is used in NR cell.
- System information combination 31 as defined in TS 36.508 [7] clause 4.4.3.1, and message contents defined in clause 4.4.3.3 with QBASED condition is used in E-UTRA cell.

UE:

None.

Preamble:

With E-UTRA Cell 1 "Serving cell" and NR Cell 1 "Non-suitable "Off" cell" in accordance with TS 38.508-1 [4], Table 6.2.2.1-3, the UE is brought to state RRC_IDLE Connectivity (E) in accordance with the procedure described in TS 38.508-1 [4], Table 4.5.2.2-1. 4G-GUTI and eKSI are assigned and security context established

The UE is switched-off.

With E-UTRA Cell 1 "Non-suitable "Off" cell" and NR Cell 1 "Serving cell" in accordance with TS 38.508-1 [4], Table 6.2.2.1-3, the UE is brought to state 1N-A, RRC_IDLE Connectivity (NR), in accordance with the procedure described in TS 38.508-1 [4], Table 4.5.2.2-2. 5G-GUTI and ngKSI are assigned and security context established..

6.2.3.4.3.2 Test procedure sequence

Table 6.2.3.4.3.2-1/2 illustrate the downlink power levels and other changing parameters to be applied for the cell at various time instants of the test execution. The exact instants on which these values shall be applied are described in the texts in this clause. Configurations marked "T1", "T2" and "T3" are applied at the points indicated in the Main behaviour description in Table 6.2.3.4.3.2-3.

Table 6.2.3.4.3.2-1: Time instances of cell power level and parameter changes for NR Cell (FR1)

	Parameter	Unit	NR Cell 1	E-UTRA Cell 1	Remark
T1	Cell-specific RS EPRE	dBm/15kHz	-	-80	The power level values are assigned to ensure UE reselected to E-UTRA Cell 1: both $Squal_{\text{ServingCell, NR Cell1}} < \text{Thresh}_{\text{Serving, LowQ}}$ and $Squal_{\text{nonServingCell, E-UTRA Cell1}} > \text{Thresh}_{\text{X, LowQ}}$
	SS/PBCH SSS EPRE	dBm/SCS	-95	-	
	RSRQ	dB	-21.20	-3.76	
	Qqualmin	dB	-25	-20	
	NoCE-UTRA	dBm/15kHz	-	-95	
	NoCNR	dBm/SCS	-85	-	
T2	Cell-specific RS EPRE	dBm/15kHz	-	-95	The power level values are assigned to ensure UE reselected back to NR Cell 1: $Squal_{\text{nonServingCell, E-UTRA Cell1}} > \text{Thresh}_{\text{X, HighQ}}$
	SS/PBCH SSS EPRE	dBm/SCS	-80	-	
	RSRQ	dB	-11.96	-11.46	
	Qqualmin	dB	-25	-20	
	NoCE-UTRA	dBm/15kHz	-	-95	
	NoCNR	dBm/SCS	-85	-	
T3	Cell-specific RS EPRE	dBm/15kHz	-	-80	The power level values are assigned to ensure UE reselected to E-UTRA Cell 1: $Squal_{\text{nonServingCell, NR Cell1}} > \text{Thresh}_{\text{X, HighQ}}$
	SS/PBCH SSS EPRE	dBm/SCS	-95	-	
	RSRQ	dB	-21.20	-3.76	
	Qqualmin	dB	-25	-20	
	NoCE-UTRA	dBm/15kHz	-	-95	
	NoCNR	dBm/SCS	-85	-	

Table 6.2.3.4.3.2-2: Time instances of cell power level and parameter changes for NR Cell (FR2)

	Parameter	Unit	NR Cell 1	E-UTRA Cell 1	Remark
T1	Cell-specific RS EPRE	dBm/15kHz	-	FFS	The power level values are assigned to ensure UE reselected to E-UTRA Cell 1: both $Squal_{\text{ServingCell, NR Cell1}} < \text{Thresh}_{\text{Serving, LowQ}}$ and $Squal_{\text{nonServingCell, E-UTRA Cell1}} > \text{Thresh}_{\text{X, LowQ}}$
	SS/PBCH SSS EPRE	dBm/SCS	FFS	-	
	RSRQ	dB	FFS	FFS	
	Qqualmin	dB	-25	-20	
	NoCE-UTRA	dBm/15kHz	-	FFS	
	NoCNR	dBm/SCS	FFS	-	
T2	Cell-specific RS EPRE	dBm/15kHz	-	FFS	The power level values are assigned to ensure UE reselected back to NR Cell 1: $Squal_{\text{nonServingCell, E-UTRA Cell1}} > \text{Thresh}_{\text{X, HighQ}}$
	SS/PBCH SSS EPRE	dBm/SCS	FFS	-	
	RSRQ	dB	FFS	FFS	
	Qqualmin	dB	-25	-20	
	NoCE-UTRA	dBm/15kHz	-	FFS	
	NoCNR	dBm/SCS	FFS	-	
T3	Cell-specific RS EPRE	dBm/15kHz	-	FFS	The power level values are assigned to ensure UE reselected to E-UTRA Cell 1: $Squal_{\text{nonServingCell, NR Cell1}} > \text{Thresh}_{\text{X, HighQ}}$
	SS/PBCH SSS EPRE	dBm/SCS	FFS	-	
	RSRQ	dB	FFS	FFS	
	Qqualmin	dB	-25	-20	
	NoCE-UTRA	dBm/15kHz	-	FFS	
	NoCNR	dBm/SCS	FFS	-	

Table 6.2.3.4.3.2-3: Main behaviour

St	Procedure	Message Sequence		TP	Verdict
		U - S	Message		
1	The SS changes SS/PBCH SSS EPRE level for NR Cell 1 and Cell-specific RS EPRE level for E-UTRA Cell 1 according to row "T1" in table 6.2.3.4.3.2-1/2/3.	-	-	-	-
2	Check: Does the test result of test steps 1 to 6 of generic test procedure in TS 38.508-1 [4] Table 4.9.7.2.2 indicate that the UE is camped on E-UTRA Cell 1?	-	-	1	-
3	The SS transmits an <i>RRCConnectionRelease</i> message to release RRC connection and move to RRC_IDLE on E-UTRAN Cell 1.	<--	E-UTRA RRC: <i>RRCConnectionRelease</i>	-	-
4	The SS changes SS/PBCH SSS EPRE level for NR Cell 1 and Cell-specific RS EPRE level for E-UTRA Cell 1 according to row "T2" in table 6.2.3.4.3.2-1/2/3.	-	-	-	-
5	The UE selects NR Cell 1 and performs the generic test procedure in TS 38.508-1 Table 4.9.9.2.2-1 with condition ' <i>connected without release</i> '.	-	-	-	-
6	The SS transmits an <i>RRCRelease</i> message on NR Cell 1.	<--	NR RRC: <i>RRCRelease</i>	-	-
7	The SS changes the E-UTRA cell priority broadcast in system information on NR Cell 1.	-	-	-	-
8	Notify UE change of System Information on NR Cell 1.	<--	NR RRC: <i>ShortMessage</i>		
9	Wait for 6 s for UE to receive system information.	-	-	-	-
10	The SS changes SS/PBCH SSS EPRE level for NR Cell 1 and Cell-specific RS EPRE level for E-UTRA Cell 1 according to row "T3" in table 6.2.3.4.3.2-1/2/3.	-	-	-	-
11	Check: Does the test result of test steps 1 to 6 of generic test procedure in TS 38.508-1 [4] Table 4.9.7.2.2 indicate that the UE is camped on E-UTRA Cell 1?	-	-	2	-
12	The SS transmits an <i>RRCConnectionRelease</i> message to release RRC connection and move to RRC_IDLE on E-UTRAN Cell 1.	<--	E-UTRA RRC: <i>RRCConnectionRelease</i>	-	-

6.2.3.4.3.3 Specific message contents

Table 6.2.3.4.3.3-1: SIB1 for NR Cell 1 (preamble and all steps, Table 6.2.3.4.3.2-3)

Derivation path: TS 38.508-1 [4], Table 4.6.1-28			
Information Element	Value/Remark	Comment	Condition
SIB1 ::= SEQUENCE {			
cellSelectionInfo SEQUENCE {			
q-QualMin	-20		
}			
}			

Table 6.2.3.4.3.3-2: SIB2 for NR Cell 1 (preamble and all steps, Table 6.2.3.4.3.2-3)

Derivation path: TS 38.508-1 [4], Table 4.6.2-1			
Information Element	Value/Remark	Comment	Condition
SIB2 ::= SEQUENCE {			
cellReselectionServingFreqInfo SEQUENCE {			
threshServingLowQ	26		
}			
}			

Table 6.2.3.4.3.3-3: SIB5 NR Cell 1 (preamble, Table 6.2.3.4.3.2-3)

Derivation path: TS 38.508-1 [4], Table 4.6.2-4			
Information Element	Value/remark	Comment	Condition
SIB5 ::= SEQUENCE {			
carrierFreqListEUTRA SEQUENCE (SIZE (1..maxEUTRA-Carrier)) OF CarrierFreqEUTRA {	1 entry		
CarrierFreqEUTRA[1] SEQUENCE {		entry 1	
carrierFreq	Downlink E-UTRA ARFCN for E-UTRA Cell 1		
}			
}			
threshX-Q SEQUENCE {			
threshX-HighQ	20		
threshX-LowQ	5		
}			
}			
}			
t-ReselectionEUTRA	7		
}			

Table 6.2.3.4.3.3-4: SystemInformationBlockType1 for E-UTRA Cell 1 (preamble and all steps, Table 6.2.3.4.3.2-3)

Derivation path: TS 36.508-1 [7], Table 4.4.3.2-3			
Information Element	Value/Remark	Comment	Condition
SystemInformationBlockType1 ::= SEQUENCE {			
nonCriticalExtension SEQUENCE {			
nonCriticalExtension SEQUENCE {			
cellSelectionInfo-v920 SEQUENCE {			
q-QualMin-r9	-20		
}			
}			
}			
}			

Table 6.2.3.4.3.3-5: SystemInformationBlockType3 for E-UTRA Cell 1 preamble and all steps, Table 6.2.3.4.3.2-3)

Derivation path: TS 36.508 [7], Table 4.4.3.3-2			
Information Element	Value/Remark	Comment	Condition
SystemInformationBlockType3 ::= SEQUENCE {			
lateNonCriticalExtension {			
q-QualMin-r9	-20		
threshServingLowQ-r9	26		
}			
}			

Table 6.2.3.4.3.3-6: SystemInformationBlockType24 for E-UTRA Cell 1 (preamble and all steps, Table 6.2.3.4.3.2-3)

Derivation path: TS 36.508 [7], Table 4.4.3.3-20			
Information Element	Value/remark	Comment	Condition
SystemInformationBlockType24-r15 ::= SEQUENCE {			
carrierFreqListNR-r15 SEQUENCE (SIZE (1..maxFreq)) OF CarrierFreqNR-r15 {	1 entry		
CarrierFreqNR-r15[1] SEQUENCE {		entry 1	
carrierFreq-r15	Downlink NR ARFCN of SSB for NR Cell 1		
cellReselectionPriority-r15	5		
threshX-Q-r15 SEQUENCE {			
threshX-HighQ-r15	8		
threshX-LowQ-r15	20		
}			
q-QualMin-r15	-25		
}			
t-ReselectionNR-r15	7		
}			

Table 6.2.3.4.3.3-7: SIB5 NR Cell 1 (step 7, Table 6.2.3.4.3.2-3)

Derivation path: TS 38.508-1 [4], Table 4.6.2-4			
Information Element	Value/remark	Comment	Condition
SIB5 ::= SEQUENCE {			
carrierFreqListEUTRA SEQUENCE (SIZE (1..maxEUTRA-Carrier)) OF CarrierFreqEUTRA {	1 entry		
CarrierFreqEUTRA[1] SEQUENCE {		entry 1	
carrierFreq	Downlink E-UTRA ARFCN for E-UTRA Cell 1		
cellReselectionPriority	5		
q-QualMin	-20		
threshX-Q SEQUENCE {			
threshX-HighQ	5		
threshX-LowQ	20		
}			
}			
t-ReselectionEUTRA	7		
}			

Table 6.2.3.4.3.3-8: SIB1 of NR Cell 1 (step 9, Table 6.2.3.4.3.2-3)

Derivation Path: TS 38.508-1 [4], Table 4.6.1-5			
Information Element	Value/remark	Comment	Condition
SIB1 ::= SEQUENCE {			
si-SchedulingInfo	SI-SchedulingInfo		
}			

Table 6.2.3.4.3.3-9: SI-SchedulingInfo (si-SchedulingInfo in Table 6.2.3.4.3.3-6)

Derivation Path: TS 38.508-1 [4], Table 4.6.3-130A			
Information Element	Value/remark	Comment	Condition
SI-SchedulingInfo ::= SEQUENCE {			
schedulingInfoList SEQUENCE (SIZE(1..maxSI-Message)) OF SchedulingInfo {	1 entry		
SchedulingInfo[1] SEQUENCE {		entry 1	
sib-MappingInfo SEQUENCE (SIZE (1..maxSIB)) OF SIB-TypeInfo {	1 entry		
SIB-TypeInfo[1] SEQUENCE {		entry 1	
type	sibType5		
valueTag	1		
}			
}			
}			
}			
}			

Table 6.2.3.4.3.3-10: REGISTRATION REQUEST (Step 5, Table 6.2.3.4.3.2-3)

Derivation Path: TS 38.508-1 [4], Table 4.7.1-6.			
Information Element	Value/remark	Comment	Condition
EPS NAS message container	TRACKING AREA UPDATE REQUEST message	See Table 6.2.3.4.3.3-11	

Table 6.2.3.4.3.3-11: TRACKING AREA UPDATE REQUEST (Table 6.2.3.4.3.3-10)

Derivation Path: TS 38.508-1 [4], Table 4.9.9.2.3-2 with condition Mapped EPS security context
--

6.2.3.5 Inter-RAT cell reselection/From NR RRC_IDLE to E-UTRA_Idle according to RAT priority provided by dedicated signalling (RRCRelease)

6.2.3.5.1 Test Purpose (TP)

(1)

```
with { UE in NR RRC_IDLE state having received an RRCRelease message including
cellReselectionPriorities }
ensure that {
  when { UE detects the cell re-selection criteria are met for the cell which belongs to the higher
priority RAT }
  then { UE reselects the cell which belongs to the higher priority RAT }
}
```

(2)

```
with { UE in NR RRC_IDLE state having received an RRCRelease message including a
cellReselectionPriorities }
ensure that {
  when { UE detects the cell re-selection criteria are met for the cell which belongs to the lower
priority RAT }
  then { UE reselects the cell which belongs to the lower priority RAT }
}
```

(3)

```
with { UE in NR RRC_IDLE state having received an RRCRelease message including a
cellReselectionPriorities }
ensure that {
```

```

when { T320 expires }
then { UE reselects a cell by applying the cellReselectionPriority broadcast in the system
information }
}

```

(4)

```

with { UE in NR RRC_IDLE state and reselection priorities have been provided in dedicated
signalling }
ensure that {
when { T320 has not expired }
then { The UE shall ignore all the priorities provided in system information, and not perform
cell reselection evaluation for NR frequencies and E-UTRA frequencies for which the UE doesn't have
a priority provided }
}
}

```

6.2.3.5.2 Conformance requirements

References: The conformance requirements covered in the present TC are specified in: 3GPP TS 38.304: clause 5.2.4.1 and 5.2.4.5, 3GPP TS 38.331: clause 5.3.8.3 and 5.3.8.4. Unless otherwise stated these are Rel-15 requirements.

[TS 38.304, clause 5.2.4.1]

Absolute priorities of different NR frequencies or inter-RAT frequencies may be provided to the UE in the system information, in the *RRCRelease* message, or by inheriting from another RAT at inter-RAT cell (re)selection. In the case of system information, an NR frequency or inter-RAT frequency may be listed without providing a priority (i.e. the field *cellReselectionPriority* is absent for that frequency). If priorities are provided in dedicated signalling, the UE shall ignore all the priorities provided in system information. If UE is in *camped on any cell* state, UE shall only apply the priorities provided by system information from current cell, and the UE preserves priorities provided by dedicated signalling and *deprioritisationReq* received in *RRCRelease* unless specified otherwise. When the UE in camped normally state, has only dedicated priorities other than for the current frequency, the UE shall consider the current frequency to be the lowest priority frequency (i.e. lower than any of the network configured values).

The UE shall only perform cell reselection evaluation for NR frequencies and inter-RAT frequencies that are given in system information and for which the UE has a priority provided.

In case UE receives *RRCRelease* with *deprioritisationReq*, UE shall consider current frequency and stored frequencies due to the previously received *RRCRelease* with *deprioritisationReq* or all the frequencies of NR to be the lowest priority frequency (i.e. lower than any of the network configured values) while T325 is running irrespective of camped RAT. The UE shall delete the stored deprioritisation request(s) when a PLMN selection is performed on request by NAS (TS 23.122 [9]).

NOTE: UE should search for a higher priority layer for cell reselection as soon as possible after the change of priority. The minimum related performance requirements specified in TS 38.133 [8] are still applicable.

The UE shall delete priorities provided by dedicated signalling when:

- the UE enters a different RRC state; or
- the optional validity time of dedicated priorities (T320) expires; or
- a PLMN selection is performed on request by NAS (TS 23.122 [9]).

NOTE 2: Equal priorities between RATs are not supported.

The UE shall not consider any black listed cells as candidate for cell reselection.

The UE shall inherit the priorities provided by dedicated signalling and the remaining validity time (i.e. T320 in NR and E-UTRA), if configured, at inter-RAT cell (re)selection.

NOTE 3: The network may assign dedicated cell reselection priorities for frequencies not configured by system information.

[TS 38.304, clause 5.2.4.2]

Following rules are used by the UE to limit needed measurements:

- If the serving cell fulfils $S_{rxlev} > S_{IntraSearchP}$ and $S_{qual} > S_{IntraSearchQ}$, the UE may choose not to perform intra-frequency measurements.
- Otherwise, the UE shall perform intra-frequency measurements.
- The UE shall apply the following rules for NR inter-frequencies and inter-RAT frequencies which are indicated in system information and for which the UE has priority provided as defined in 5.2.4.1:
 - For a NR inter-frequency or inter-RAT frequency with a reselection priority higher than the reselection priority of the current NR frequency, the UE shall perform measurements of higher priority NR inter-frequency or inter-RAT frequencies according to TS 38.133 [8].
 - For a NR inter-frequency with an equal or lower reselection priority than the reselection priority of the current NR frequency and for inter-RAT frequency with lower reselection priority than the reselection priority of the current NR frequency:
 - If the serving cell fulfils $S_{rxlev} > S_{nonIntraSearchP}$ and $S_{qual} > S_{nonIntraSearchQ}$, the UE may choose not to perform measurements of NR inter-frequencies or inter-RAT frequency cells of equal or lower priority;
 - Otherwise, the UE shall perform measurements of NR inter-frequencies or inter-RAT frequency cells of equal or lower priority according to TS 38.133 [8].

[TS 38.331, clause 5.3.8.3]

The UE shall:

- 1> delay the following actions defined in this sub-clause 60 ms from the moment the *RRCRelease* message was received or optionally when lower layers indicate that the receipt of the *RRCRelease* message has been successfully acknowledged, whichever is earlier;
 - 1> stop timer T380, if running;
 - 1> stop timer T320, if running;
 - 1> if T390 is running:
 - 2> stop timer T390 for all access categories;
 - 2> perform the actions as specified in 5.3.14.4;
 - 1> if the AS security is not activated, perform the actions upon going to RRC_IDLE as specified in 5.3.11 with the release cause 'other' upon which the procedure ends;
 - 1> if the *RRCRelease* message includes *redirectedCarrierInfo* indicating redirection to *eutra*:
 - 2> if *cnType* is included:
 - 3> after the cell selection, indicate the available CN Type(s) and the received *cnType* to upper layers;
- NOTE: Handling the case if the E-UTRA cell selected after the redirection does not support the core network type specified by the *cnType*, is up to UE implementation.
- 1> if the *RRCRelease* message includes the *cellReselectionPriorities*:
 - 2> store the cell reselection priority information provided by the *cellReselectionPriorities*;
 - 2> if the *t320* is included:
 - 3> start timer T320, with the timer value set according to the value of *t320*;
 - 1> else:
 - 2> apply the cell reselection priority information broadcast in the system information;
 - 1> if *deprioritisationReq* is included:
 - 2> start or restart timer T325 with the timer value set to the *deprioritisationTimer* signalled;

- 2> store the *deprioritisationReq* until T325 expiry;
- 1> if the *RRCRelease* includes *suspendConfig*:
 - 2> apply the received *suspendConfig*;
 - 2> reset MAC and release the default MAC Cell Group configuration, if any;
 - 2> re-establish RLC entities for SRB1;
 - 2> if the *RRCRelease* message with *suspendConfig* was received in response to an *RRCResumeRequest* or an *RRCResumeRequest1*:
 - 3> stop the timer T319 if running;
 - 3> in the stored UE Inactive AS context:
 - 4> replace the K_{gNB} and K_{RRCint} keys with the current K_{gNB} and K_{RRCint} keys;
 - 4> replace the C-RNTI with the temporary C-RNTI in the cell the UE has received the *RRCRelease* message;
 - 4> replace the *cellIdentity* with the *cellIdentity* of the cell the UE has received the *RRCRelease* message;
 - 4> replace the physical cell identity with the physical cell identity of the cell the UE has received the *RRCRelease* message;
 - 4> replace the *suspendConfig* with the current *suspendConfig*;
 - 2> else:
 - 3> store in the UE Inactive AS Context the configured *suspendConfig*, the current K_{gNB} and K_{RRCint} keys, the ROHC state, the C-RNTI used in the source PCell, the *cellIdentity* and the physical cell identity of the source PCell, and all other parameters configured except with *ReconfigurationWithSync*;
 - 2> suspend all SRB(s) and DRB(s), except SRB0;
 - 2> indicate PDCP suspend to lower layers of all DRBs;
 - 2> if the *t380* is included:
 - 3> start timer T380, with the timer value set to *t380*;
 - 2> if the *RRCRelease* message is including the *waitTime*:
 - 3> start timer T302 with the value set to the *waitTime*;
 - 3> inform the upper layer that access barring is applicable for all access categories except categories '0' and '2';
 - 2> indicate the suspension of the RRC connection to upper layers;
 - 2> enter RRC_INACTIVE and perform cell selection as specified in TS 38.304 [20];
- 1> else
 - 2> perform the actions upon going to RRC_IDLE as specified in 5.3.11, with the release cause 'other'.

[TS 38.331, clause 5.3.8.4]

The UE shall:

- 1> if T320 expires:
 - 2> if stored, discard the cell reselection priority information provided by the *cellReselectionPriorities* or inherited from another RAT;
 - 2> apply the cell reselection priority information broadcast in the system information.

6.2.3.5.3 Test description

6.2.3.5.3.1 Pre-test conditions

System Simulator:

- NR Cell 1, E-UTRA Cell 1 is inter-RAT cell.
- System information combination NR-6 as defined in TS 38.508-1 [4] clause 4.4.3.1.3 is used in NR Cell.
- System information combination 31 as defined in TS 36.508-1 [18] clause 4.4.3.1 is used in E-UTRA Cell.

UE:

None.

Preamble:

- With E-UTRA Cell 1 "Serving cell" and NR Cell 1 "Non-suitable "Off" cell" in accordance with TS 38.508-1 [4], Table 6.2.2.1-3, the UE is brought to state RRC_IDLE Connectivity (E-UTRA/EPC) in accordance with the procedure described in TS 38.508-1 [4], Table 4.5.2.2-1. 4G GUTI and eKSI are assigned and security context established.
- the UE is switched-off.
- With E-UTRA Cell 1 "Non-suitable "Off" cell" and NR Cell 1 "Serving cell" in accordance with TS 38.508-1 [4], Table 6.2.2.1-3, the UE is brought to state 3N-A, RRC_CONNECTED Connectivity (NR), in accordance with the procedure described in TS 38.508-1 [4], Table 4.5.4.2-3. 5G-GUTI and ngKSI are assigned and security context established.

6.2.3.5.3.2 Test procedure sequence

Table 6.2.3.5.3.2-1/2 illustrate the downlink power levels and other changing parameters to be applied for the cell at various time instants of the test execution. The exact instants on which these values shall be applied are described in the texts in this clause. Row marked "T0" denotes the conditions in the preamble. Configurations marked "T1", "T2" and so on are applied at the points indicated in the Main behaviour description in Table 6.1.3.5.3.2-3.

Table 6.2.3.5.3.2-1: Time instances of cell power level and parameter changes for E-UTRA cell 1 and NR cell 1 in FR1

	Parameter	Unit	NR Cell 1	E-UTRA Cell 1	Remark
T0	Cell-specific RS EPRE	dBm/15kHz	-	OFF	The power level values are assigned to satisfy $Srxlev_{NR\ Cell\ 1} > 0$ and $Srxlev_{E-UTRA\ Cell\ 1} < 0$. And UE camping on NR Cell 1 is guaranteed.
	SS/PBCH SSS EPRE	dBm/SCS	-88	-	
T1	Cell-specific RS EPRE	dBm/15kHz	-	-70	The power level values are assigned to satisfy $Srxlev_{E-UTRA\ cell\ 1} > Thresh_{x,high}$.
	SS/PBCH SSS EPRE	dBm/SCS	-90	-	
T2	Cell-specific RS EPRE	dBm/15kHz	-	-104	The power level values are such that camping on NR Cell 1 is guaranteed.
	SS/PBCH SSS EPRE	dBm/SCS	-78	-	
T3	Cell-specific RS EPRE	dBm/15kHz	-	-88	The power level values are assigned to satisfy both $Srxlev_{NR\ Cell\ 1} < Thresh_{serving, low}$ and $Srxlev_{E-UTRA\ Cell\ 1} > Thresh_{x, low}$.
	SS/PBCH SSS EPRE	dBm/SCS	-104	-	
T4	Cell-specific RS EPRE	dBm/15kHz	-	-104	The power level values are such that camping on NR Cell 1 is guaranteed.
	SS/PBCH SSS EPRE	dBm/SCS	-78	-	

T5	Cell-specific RS EPRE	dBm/15kHz	-	-70	The power level values are assigned to satisfy $Srxlev_{NR\ cell\ 1} > Thresh_{serving, low}$ and $Srxlev_{E-UTRA\ cell\ 1} > Thresh_{x, high}$.
	SS/PBCH SSS EPRE	dBm/SCS	-90	-	

Table 6.2.3.5.3.2-2: Time instances of cell power level and parameter changes for E-UTRA Cell 1 and NR Cell 1 in FR2

	Parameter	Unit	NR Cell 1	E-UTRA Cell 1	Remark
T0	Cell-specific RS EPRE	dBm/15kHz	-	OFF	The power level values are assigned to satisfy $Srxlev_{NR\ Cell\ 1} > 0$ and $Srxlev_{E-UTRA\ Cell\ 1} < 0$. And UE camping on NR Cell 1 is guaranteed.
	SS/PBCH SSS EPRE	dBm/SCS	FFS	-	
T1	Cell-specific RS EPRE	dBm/15kHz	-	-70	The power level values are assigned to satisfy $Srxlev_{E-UTRA\ cell\ 1} > Thresh_{x, high}$.
	SS/PBCH SSS EPRE	dBm/SCS	FFS	-	
T2	Cell-specific RS EPRE	dBm/15kHz	-	-104	The power level values are such that camping on NR Cell 1 is guaranteed.
	SS/PBCH SSS EPRE	dBm/SCS	FFS	-	
T3	Cell-specific RS EPRE	dBm/15kHz	-	-88	The power level values are assigned to satisfy both $Srxlev_{NR\ Cell\ 1} < Thresh_{serving, low}$ and $Srxlev_{E-UTRA\ Cell\ 1} > Thresh_{x, low}$.
	SS/PBCH SSS EPRE	dBm/SCS	FFS	-	
T4	Cell-specific RS EPRE	dBm/15kHz	-	-104	The power level values are such that camping on NR Cell 1 is guaranteed.
	SS/PBCH SSS EPRE	dBm/SCS	FFS	-	
T5	Cell-specific RS EPRE	dBm/15kHz	-	-70	The power level values are assigned to satisfy $Srxlev_{NR\ cell\ 1} > Thresh_{serving, low}$ and $Srxlev_{E-UTRA\ cell\ 1} > Thresh_{x, high}$.
	SS/PBCH SSS EPRE	dBm/SCS	FFS	-	

Table 6.2.3.5.3.2-3: Main behaviour

St	Procedure	Message Sequence		TP	Verdict
		U - S	Message		
1	The SS transmits RRCRelease message including cellReselectionPriorities on NR Cell 1.	-	NR:RRCRelease	-	-
2	The SS adjusts the NR and E-UTRAN Cell power levels according to row "T1" in table 6.2.3.5.3.2-1/2.	-	-	-	-
3	Check: Does the UE transmit an RRC CONNECTION REQUEST on E-UTRA Cell 1 within the next 30 Seconds?	-	-	4	F
4	The test steps 1 to 8 of generic test procedure in TS 38.508-1 [4] Table 4.5.4.2-3 are performed on NR Cell 1.	-	-	-	-
5	The SS transmits RRCRelease message including cellReselectionPriorities on NR Cell 1.	<--	NR:RRCRelease	-	-
6	Check: Does the test result of generic test procedure in TS 38.508-1 [4] Table 4.9.7.2.2-1 is performed and the UE is camped on E-UTRAN Cell 1?	-	-	1	-
7	The SS adjusts the NR and E-UTRAN Cell power levels according to row "T2" in table 6.2.3.5.3.2-1/2.	-	-	-	-
8	Generic test procedure in TS 38.508-1 [4] Table 4.9.9.2.2-1 take place and the UE is camped on NR Cell 1.	-	-	-	-
9	The SS adjusts the NR and E-UTRAN Cell power levels according to row "T3" in table 6.2.3.5.3.2-1/2.	-	-	-	-
10	The SS transmits RRCRelease message including cellReselectionPriorities on NR Cell 1.	<--	NR:RRCRelease	-	-
11	Check: Does the test result of generic test procedure in TS 38.508-1 [4] Table 4.9.7.2.2-1 is performed and the UE is camped on E-UTRAN Cell 1?	-	-	2	-
12	The SS adjusts the NR and E-UTRAN Cell power levels according to row "T4" in table 6.2.3.5.3.2-1/2.	-	-	-	-
13	Generic test procedure in TS 38.508-1 [4] Table 4.9.9.2.2-1 take place and the UE is camped on NR Cell 1.	-	-	-	-
14	The SS transmits RRCRelease message including cellReselectionPriorities on NR Cell 1.	<--	NR:RRCRelease	-	-
15	The SS adjusts the NR and E-UTRAN Cell power levels according to row "T5" in table 6.2.3.5.3.2-1/2.	-	-	-	-
16	Wait for 5 minutes from step 17 to ensure that T320 expires.	-	-	-	-
17	Check: Does the test result of generic test procedure in TS 38.508-1 [4] Table 4.9.7.2.2-1 is performed and the UE is camped on E-UTRAN Cell 1?	-	-	3	-

6.2.3.5.3.3 Specific message contents

Table 6.2.3.5.3.3-1: SIB2 of NR Cell 1 (preamble and all steps, Table 6.2.3.5.3.2-3)

Derivation Path: TS 38.508-1 [4], Table 4.6.2-1			
Information Element	Value/remark	Comment	Condition
SIB2 ::= SEQUENCE {			
cellReselectionServingFreqInfo SEQUENCE {			
threshServingLowP	5	10dB	
}			
}			

Table 6.2.3.5.3.3-2: SIB5 of NR Cell 1 (preamble and all steps, Table 6.2.3.5.3.2-3)

Derivation Path: TS 38.508-1 [4], Table 4.6.2-4			
Information Element	Value/remark	Comment	Condition
SIB5 ::= SEQUENCE {			
carrierFreqListEUTRA SEQUENCE (SIZE (1..maxEUTRA-Carrier)) OF CarrierFreqEUTRA {	1 entry		
CarrierFreqEUTRA[1] SEQUENCE {		entry 1	
carrierFreq	Downlink EARFCN as E-UTRA Cell 1 used		
cellReselectionPriority	5		
threshX-High	13	26 dB	
threshX-Low	5	10 dB	
}			
}			
t-ReselectionEUTRA	7	7 Seconds	
}			

Table 6.2.3.5.3.3-3: SystemInformationBlockType3 for EUTRA Cell 1 (preamble and all steps, Table 6.2.3.5.3.2-3)

Derivation Path: TS 36.508 [7], Table 4.4.3.2			
Information Element	Value/remark	Comment	Condition
SystemInformationBlockType3 ::= SEQUENCE {			
cellReselectionServingFreqInfo SEQUENCE {			
threshServingLow	5	10dB	
}			
}			

Table 6.2.3.5.3.3-4: SystemInformationBlockType24 for EUTRA Cell 1 (preamble and all steps, Table 6.2.3.5.3.2-3)

Derivation path: TS 36.508 [7], Table 4.4.3.3-20			
Information Element	Value/Remark	Comment	Condition
SystemInformationBlockType24-r15 ::= SEQUENCE {			
carrierFreqListNR-r15 SEQUENCE (SIZE (1..maxFreq)) OF CarrierFreqNR-r15 {	1 entry		
CarrierFreqNR-r15[1] SEQUENCE {		entry 1	
carrierFreq-r15	Same downlink SSB ARFCN as used for NR Cell 1		
cellReselectionPriority-r15	3		
threshX-High-r15	20	40dB	
threshX-Low-r15	10	20dB	
}			
}			
t-ReselectionNR-r15	7	7 Seconds	
}			

Table 6.2.3.5.3.3-5 RRCRelease (step1, Table 6.2.3.5.3.2-3)

Derivation Path: TS 38.508-1 [4], Table 4.6.1-16			
Information Element	Value/remark	Comment	Condition
RRCRelease ::= SEQUENCE {			
criticalExtensions CHOICE {			
rrcRelease SEQUENCE {			
cellReselectionPriorities SEQUENCE {			
freqPriorityListEUTRA	Not present		Step1
freqPriorityListEUTRA SEQUENCE (SIZE (1..maxFreq)) OF FreqPriorityEUTRA {	1 entry		
FreqPriorityListEUTRA[1] SEQUENCE {		entry 1	
carrierFreq	Downlink ARFCN of E-UTRA Cell 1		
cellReselectionPriority	5		Step5
	3		Step10
	3		Step14
}			
}			
freqPriorityListNR SEQUENCE (SIZE (1..maxFreq)) OF FreqPriorityNR {	1 entry		
FreqPriorityNR[1] SEQUENCE {		entry 1	
carrierFreq	Downlink SSB ARFCN of NR Cell 1		
cellReselectionPriority	4		Step1
	4		Step5
	4		Step10
	4		Step14
}			
}			
t320	Not present		Step1
	Not present		Step5
	Not present		Step10
	min5	5 minutes	Step14
}			
}			
}			
}			

Table 6.2.3.5.3.3-6: REGISTRATION REQUEST (Step 8 and Step13, Table 6.2.3.5.3.2-3)

Derivation Path: TS 38.508-1 [4], Table 4.7.1-6.			
Information Element	Value/remark	Comment	Condition
EPS NAS message container	TRACKING AREA UPDATE REQUEST message	See Table 6.2.3.5.3.3-7	

Table 6.2.3.5.3.3-7: TRACKING AREA UPDATE REQUEST (Table 6.2.3.5.3.3-6)

Derivation Path: TS 38.508-1 [4], Table 4.9.9.2.3-2 with condition Mapped EPS security context
--

6.2.3.6 Inter-RAT cell reselection / From E-UTRA_Idle to NR RRC_IDLE according to RAT priority provided by dedicated signalling (RRCConnRelease)

6.2.3.6.1 Test Purpose (TP)

(1)

with { UE in E-UTRA RRC_Idle state having received RRCConnectionRelease including IdleModeMobilityControlInfo containing cellReselectionPriority for NR cell}
ensure that {

```

when { UE detects the cell re-selection criteria are met for the cell which belongs to the lower
priority inter-RAT NR cell based on the configured RAT priority provided by dedicated signaling}
  then { UE reselects the cell which belongs to the lower priority inter-RAT NR cell}
}

```

(2)

```

with { UE in NR RRC_IDLE state having inherit RAT priority provided by dedicated signaling with the
remaining validity time}
ensure that {
  when { UE discard the inherit RAT priority upon connection establishment}
  then { UE reselects a cell by applying the cellReselectionPriority broadcast in the system
information}
}

```

6.2.3.6.2 Conformance requirements

References: The conformance requirements covered in the present TC are specified in: 3GPP TS 36.304, clause 5.2.4.1, and 3GPP TS 38.304, clause 5.2.4.1. Unless otherwise stated these are Rel-15 requirements.

[TS 36.304, clause 5.2.4.1]

Absolute priorities of different E-UTRAN frequencies or inter-RAT frequencies may be provided to the UE in the system information, in the *RRCCConnectionRelease* message, or by inheriting from another RAT at inter-RAT cell (re)selection. In the case of system information, an E-UTRAN frequency or inter-RAT frequency may be listed without providing a priority (i.e. the field *cellReselectionPriority* is absent for that frequency). If priorities are provided in dedicated signalling, the UE shall ignore all the priorities provided in system information. If UE is in *camped on any cell* state, UE shall only apply the priorities provided by system information from current cell, and the UE preserves priorities provided by dedicated signalling and *deprioritisationReq* received in *RRCCConnectionReject* unless specified otherwise. When the UE in *camped normally* state, has only dedicated priorities other than for the current frequency, the UE shall consider the current frequency to be the lowest priority frequency (i.e. lower than any of the network configured values). While the UE is camped on a suitable CSG cell in normal coverage, the UE shall always consider the current frequency to be the highest priority frequency (i.e. higher than any of the network configured values), irrespective of any other priority value allocated to this frequency. When the HSDN capable UE is in High-mobility state, the UE shall always consider the HSDN cells to be the highest priority (i.e. higher than any other network configured priorities). When the HSDN capable UE is not in High-mobility state, the UE shall always consider HSDN cells to be the lowest priority (i.e. lower than network configured priorities). If the UE capable of sidelink communication is configured to perform sidelink communication and can only perform the sidelink communication while camping on a frequency, the UE may consider that frequency to be the highest priority. If the UE capable of V2X sidelink communication is configured to perform V2X sidelink communication and can only perform the V2X sidelink communication while camping on a frequency, the UE may consider that frequency to be the highest priority. If the UE capable of V2X sidelink communication is configured to perform V2X sidelink communication and can only use pre-configuration while not camping on a frequency, the UE may consider the frequency providing inter-carrier V2X sidelink configuration to be the highest priority. If the UE capable of sidelink discovery is configured to perform Public Safety related sidelink discovery and can only perform the Public Safety related sidelink discovery while camping on a frequency, the UE may consider that frequency to be the highest priority.

NOTE 1: The prioritization among the frequencies which UE considers to be the highest priority frequency is left to UE implementation.

If the UE is capable either of MBMS Service Continuity or of SC-PTM reception and is receiving or interested to receive an MBMS service and can only receive this MBMS service while camping on a frequency on which it is provided, the UE may consider that frequency to be the highest priority during the MBMS session TS 36.300 [2] as long as the two following conditions are fulfilled:

1) Either:

- the UE is capable of MBMS service continuity and the reselected cell is broadcasting SIB13; or
- the UE is capable of SC-PTM reception and the reselected cell is broadcasting SIB20;

2) Either:

- SIB15 of the serving cell indicates for that frequency one or more MBMS SAIs included and associated with that frequency in the MBMS User Service Description (USD) TS 26.346 [22] of this service; or
- SIB15 is not broadcast in the serving cell and that frequency is included in the USD of this service.

If the UE is capable either of MBMS Service Continuity or of SC-PTM reception and is receiving or interested to receive an MBMS service provided on a downlink only MBMS frequency, on a frequency used by dedicated MBMS cells, on a frequency used by FeMBMS/Unicast-mixed cells as defined in TS 36.300 [2], or on a frequency belonging to PLMN different from its registered PLMN, the UE may consider cell reselection candidate frequencies at which it can not receive the MBMS service to be of the lowest priority during the MBMS session TS 36.300 [2], as long as the above mentioned condition 1) is fulfilled for the cell on the MBMS frequency which the UE monitors or this cell broadcasts SIB1-MBMS and as long as the above mentioned condition 2) is fulfilled for the serving cell.

NOTE 2: Example scenarios in which the previous down-prioritisation may be needed concerns the cases where camping is not possible, while the UE can only receive this MBMS frequency when camping on a subset of cell reselection candidate frequencies, e.g. the MBMS frequency is a downlink only carrier, the MBMS frequency is used by dedicated MBMS cells, the MBMS frequency is used by FeMBMS/Unicast-mixed cells TS 36.300 [2], or the MBMS frequency belongs to a PLMN different from UE's registered PLMN.

If the UE is not capable of MBMS Service Continuity but has knowledge on which frequency an MBMS service of interest is provided, it may consider that frequency to be the highest priority during the MBMS session TS 36.300 [2] as long as the reselected cell is broadcasting SIB13.

If the UE is not capable of MBMS Service Continuity but has knowledge on which downlink only frequency, on which frequency used by dedicated MBMS cells, on which frequency used by FeMBMS/Unicast-mixed cells as defined in TS 36.300 [2] or on which frequency belonging to PLMN different from its registered PLMN an MBMS service of interest is provided, it may consider cell reselection candidate frequencies at which it can not receive the MBMS service to be of the lowest priority during the MBMS session TS 36.300 [2] as long as the cell on the MBMS frequency which the UE monitors is broadcasting SIB13 or SIB1-MBMS.

NOTE 3: The UE considers that the MBMS session is ongoing using the session start and end times as provided by upper layers in the USD i.e. the UE does not verify if the session is indicated on MCCH.

In case UE receives *RRCCConnectionReject* with *deprioritisationReq*, UE shall consider current carrier frequency and stored frequencies due to the previously received *RRCCConnectionReject* with *deprioritisationReq* or all the frequencies of EUTRA to be the lowest priority frequency (i.e. lower than any of the network configured values) while T325 is running irrespective of camped RAT. The UE shall delete the stored deprioritisation request(s) when a PLMN selection is performed on request by NAS TS 23.122 [5].

NOTE 4: Connecting to CDMA2000 does not imply PLMN selection.

NOTE 5: UE should search for a higher priority layer for cell reselection as soon as possible after the change of priority. The minimum related performance requirements specified in TS 36.133 [10] are still applicable.

The UE shall delete priorities provided by dedicated signalling when:

- the UE enters a different RRC state; or
- the optional validity time of dedicated priorities (T320) expires; or
- a PLMN selection is performed on request by NAS TS 23.122 [5].

NOTE 6: Equal priorities between RATs are not supported.

The UE shall only perform cell reselection evaluation for E-UTRAN frequencies and inter-RAT frequencies that are given in system information and for which the UE has a priority provided.

The UE shall not consider any black listed cells as candidate for cell reselection.

The UE shall inherit the priorities provided by dedicated signalling and the remaining validity time (i.e., T320 in E-UTRA and NR, T322 in UTRA and T3230 in GERAN), if configured, at inter-RAT cell (re)selection.

NOTE 7: The network may assign dedicated cell reselection priorities for frequencies not configured by system information.

While T360 is running, redistribution target is considered to be the highest priority (i.e. higher than any of the network configured values). UE shall continue to consider the serving frequency as the highest priority until completion of E-UTRAN Inter-frequency Redistribution procedure specified in 5.2.4.10 if triggered on T360 expiry/ stop.

[TS 38.304, clause 5.2.4.1]

Absolute priorities of different NR frequencies or inter-RAT frequencies may be provided to the UE in the system information, in the *RRCRelease* message, or by inheriting from another RAT at inter-RAT cell (re)selection. In the case of system information, an NR frequency or inter-RAT frequency may be listed without providing a priority (i.e. the field *cellReselectionPriority* is absent for that frequency). If priorities are provided in dedicated signalling, the UE shall ignore all the priorities provided in system information. If UE is in *camped on any cell* state, UE shall only apply the priorities provided by system information from current cell, and the UE preserves priorities provided by dedicated signalling and *deprioritisationReq* received in *RRCRelease* unless specified otherwise. When the UE in *camped normally* state, has only dedicated priorities other than for the current frequency, the UE shall consider the current frequency to be the lowest priority frequency (i.e. lower than any of the network configured values).

The UE shall only perform cell reselection evaluation for NR frequencies and inter-RAT frequencies that are given in system information and for which the UE has a priority provided.

In case UE receives *RRCRelease* with *deprioritisationReq*, UE shall consider current frequency and stored frequencies due to the previously received *RRCRelease* with *deprioritisationReq* or all the frequencies of NR to be the lowest priority frequency (i.e. lower than any of the network configured values) while T325 is running irrespective of *camped* RAT. The UE shall delete the stored *deprioritisationReq* request(s) when a PLMN selection is performed on request by NAS (TS 23.122 [9]).

NOTE: UE should search for a higher priority layer for cell reselection as soon as possible after the change of priority. The minimum related performance requirements specified in TS 38.133 [8] are still applicable.

The UE shall delete priorities provided by dedicated signalling when:

- the UE enters a different RRC state; or
- the optional validity time of dedicated priorities (T320) expires; or
- a PLMN selection is performed on request by NAS (TS 23.122 [9]).

NOTE 2: Equal priorities between RATs are not supported.

The UE shall not consider any black listed cells as candidate for cell reselection.

The UE shall inherit the priorities provided by dedicated signalling and the remaining validity time (i.e. T320 in NR and E-UTRA), if configured, at inter-RAT cell (re)selection.

NOTE 3: The network may assign dedicated cell reselection priorities for frequencies not configured by system information.

6.2.3.6.3 Test description

6.2.3.6.3.1 Pre-test conditions

System Simulator:

- E-UTRA Cell 1, NR Cell 1 is different priority inter-RAT NR cell.
- System information combination 31 as defined in TS 36.508-1 [7] clause 4.4.3.1 is used in E-UTRA Cell.
- System information combination NR-6 as defined in TS 38.508-1 [4] clause 4.4.3.1.3 is used in NR Cell.

UE:

- None.

Preamble:

- With E-UTRA Cell 1 "Non-suitable "Off" cell" and NR Cell 1 "Serving cell" in accordance with TS 38.508-1 [4], Table 6.2.2.1-3, the UE is brought to state 1N-A, RRC_IDLE Connectivity (NR), in accordance with the procedure described in TS 38.508-1 [4], Table 4.5.2.2-2. 5G-GUTI and ngKSI are assigned and security context established.
- the UE is switched-off.

- With E-UTRA Cell 1 "Serving cell" and NR Cell 1 "Non-suitable "Off" cell" in accordance with TS 38.508-1 [4], Table 6.2.2.1-3, the UE is brought to state RRC_CONNECTED Connectivity (*E*) in accordance with the procedure described in TS 38.508-1 [4], Table 4.5.4.2-1. 4G GUTI and eKSI are assigned and security context established.

6.2.3.6.3.2 Test procedure sequence

Table 6.2.3.6.3.2-1/2 illustrate the downlink power levels and other changing parameters to be applied for the cell at various time instants of the test execution. The exact instants on which these values shall be applied are described in the texts in this clause. Row marked "T0" denotes the conditions in the preamble. Configurations marked "T1", "T2" and "T3" are applied at the points indicated in the Main behaviour description in Table 6.2.3.6.3.2-3.

Table 6.2.3.6.3.2-1: Time instances of cell power level and parameter changes for E-UTRA Cell 1 and NR Cell 1 in FR1

	Parameter	Unit	E-UTRA Cell 1	NR Cell 1	Remark
T0	Cell-specific RS EPRE	dBm/15kHz	-85	-	The power level values are assigned to ensure UE registered on E-UTRA cell 1
	SS/PBCH SSS EPRE	dBm/SCS	-	Off	
T1	Cell-specific RS EPRE	dBm/15kHz	-95	-	The power level values are assigned to satisfy both $Srxlev_{E-UTRA\ Cell\ 1} < Thresh_{serving, low}$ and $Srxlev_{NR\ Cell\ 1} > Thresh_{x, low}$.
	SS/PBCH SSS EPRE	dBm/SCS	-	-80	
T2	Cell-specific RS EPRE	dBm/15kHz	-80	-	The power level values are assigned to satisfy both $Srxlev_{NR\ Cell\ 1} < Thresh_{serving, low}$ and $Srxlev_{E-UTRA\ Cell\ 1} > Thresh_{x, low}$.
	SS/PBCH SSS EPRE	dBm/SCS	-	-95	

Table 6.2.3.6.3.2-2: Time instances of cell power level and parameter changes for E-UTRA Cell 1 and NR Cell 1 in FR2

	Parameter	Unit	E-UTRA Cell 1	NR Cell 1	Remark
T0	Cell-specific RS EPRE	dBm/15kHz	FFS	-	The power level values are assigned to ensure UE registered on E-UTRA cell 1
	SS/PBCH SSS EPRE	dBm/SCS	-	Off	
T1	Cell-specific RS EPRE	dBm/15kHz	FFS	-	The power level values are assigned to satisfy both $Srxlev_{E-UTRA\ Cell\ 1} < Thresh_{serving, low}$ and $Srxlev_{NR\ Cell\ 1} > Thresh_{x, low}$.
	SS/PBCH SSS EPRE	dBm/SCS	-	FFS	
T2	Cell-specific RS EPRE	dBm/15kHz	FFS	-	The power level values are assigned to satisfy both $Srxlev_{NR\ Cell\ 1} < Thresh_{serving, low}$ and $Srxlev_{E-UTRA\ Cell\ 1} > Thresh_{x, low}$.
	SS/PBCH SSS EPRE	dBm/SCS	-	FFS	

Table 6.2.3.6.3.2-3: Main behaviour

St	Procedure	Message Sequence		TP	Verdict
		U - S	Message		
1	The SS transmits <i>RRCCONNECTIONRELEASE</i> message with dedicated priority information and validity timer to the UE on E-UTRA cell 1.	<-	E-UTRA: <i>RRCCONNECTIONRELEASE</i>	-	-
2	The SS adjusts the E-UTRAN and NR Cell power levels according to row "T1" in table 6.2.3.6.3.2-1/2.	-	-	-	-
3	Check: Does the test result of generic test procedure in TS 38.508-1 [4] Table 4.9.9.2.2-1 indicate that the UE is camped on NR Cell 1? NOTE: This is the first time in this test case that the UE moves from S1 to N1.	-	-	1	-
4	Void.	-	-	-	-
5	The SS adjusts the E-UTRAN and NR Cell power levels according to row "T2" in table 6.2.3.6.3.2-1/2.	-	-	-	-
6	Check: Does the test result of generic test procedure in TS 38.508-1 [4] Table 4.9.7.2.2-1 is performed and the UE is camped on E-UTRAN Cell 1?	-	-	2	-

6.2.3.6.3.3 Specific message contents

Table 6.2.3.6.3.3-1: *SystemInformationBlockType3* of EUTRA Cell 1 (preamble and all steps, Table 6.2.3.6.3.2-3)

Derivation Path: TS 36.508 [7], Table 4.4.3.3-2			
Information Element	Value/remark	Comment	Condition
<i>SystemInformationBlockType3</i> ::= SEQUENCE {			
<i>cellReselectionServingFreqInfo</i> SEQUENCE {			
<i>threshServingLow</i>	10	20 dB	
}			
}			

Table 6.2.3.6.3.3-2: *SystemInformationBlockType24* of EUTRA Cell 1 (preamble and all steps, Table 6.2.3.6.3.2-3)

Derivation path: TS 36.508 [7], Table 4.4.3.3-20			
Information Element	Value/Remark	Comment	Condition
<i>SystemInformationBlockType24-r15</i> ::= SEQUENCE {			
<i>carrierFreqListNR-r15</i> SEQUENCE (SIZE (1.. <i>maxFreq</i>)) OF <i>CarrierFreqNR-r15</i> {	1 entry		
<i>CarrierFreqNR-r15</i> [1] SEQUENCE {		entry 1	
<i>carrierFreq-r15</i>	Same downlink SSB ARFCN as used for NR Cell 1		
<i>cellReselectionPriority-r15</i>	5		
<i>threshX-High-r15</i>	20	40 dB	
<i>threshX-Low-r15</i>	10	20 dB	
}			
}			
<i>t-ReselectionNR-r15</i>	7	7 Seconds	
}			

Table 6.2.3.6.3.3-3: SIB2 of NR Cell 1(preamble and all steps, Table 6.2.3.6.3.2-3)

Derivation Path: TS 38.508-1 [4], Table 4.6.2-1			
Information Element	Value/remark	Comment	Condition
SIB2 ::= SEQUENCE {			
cellReselectionServingFreqInfo SEQUENCE {			
threshServingLowP	10	20 dB	
}			
}			

Table 6.2.3.6.3.3-4: SIB5 of NR Cell 1(preamble and all steps, Table 6.2.3.7.3.2-3)

Derivation Path: TS 38.508-1 [4], Table 4.6.2-4			
Information Element	Value/remark	Comment	Condition
SIB5 ::= SEQUENCE {			
carrierFreqListEUTRA SEQUENCE (SIZE (1..maxEUTRA-Carrier)) OF CarrierFreqEUTRA {	1 entry		
CarrierFreqEUTRA[1] SEQUENCE {		entry 1	
carrierFreq	Downlink EUTRA ARFCN as E-UTRA Cell 1 used		
threshX-High	20	40 dB	
threshX-Low	10	20 dB	
}			
}			
t-ReselectionEUTRA	7	7 Seconds	
}			

Table 6.2.3.6.3.3-5: RRCConnectionRelease message for EUTRA Cell 1 (step 1 of Table 6.2.3.6.3.2-3)

Derivation path: TS 36.508 [7], Table 4.6.1-15			
Information Element	Value/Remark	Comment	Condition
RRCConnectionRelease ::= SEQUENCE {			
criticalExtensions CHOICE {			
c1 CHOICE {			
rrcConnectionRelease-r8 SEQUENCE {			
idleModeMobilityControlInfo SEQUENCE {			
freqPriorityListEUTRA SEQUENCE (SIZE (1..maxFreq)) OF FreqPriorityEUTRA {	1 entry		
freqPriorityListEUTRA[1] SEQUENCE {		entry 1	
carrierFreq	DownLink ARFCN-Value of E-UTRA cell 1		
cellReselectionPriority	4		
}			
}			
t320	Not present		
freqPriorityListNR-r15 SEQUENCE (SIZE (1..maxFreq)) OF FreqPriorityNR-r15 {	1 entry		
FreqPriorityNR-r15[1] SEQUENCE {		entry 1	
carrierFreq-r15	Same Downlink SSB ARFCN as used for NR Cell 1		
cellReselectionPriority-r15	3		
}			
}			
}			
}			
}			
}			

6.2.3.7 Inter-RAT cell reselection/From NR RRC_IDLE to E-UTRA RRC_IDLE, Snonintrasearch

6.2.3.7.1 Test Purpose (TP)

(1)

```
with { UE in NR RRC_IDLE state, and the UE is not in high mobility state }
ensure that {
  when { Snonintrasearch is non-zero in system information }
  then { UE perform measurement and reselects to cell which belongs to the high priority E-UTRA
cell even if  $S_{rxlev} > S_{nonintrasearch}$  }
}
```

6.2.3.7.2 Conformance requirements

References: The conformance requirements covered in the present TC are specified in: 3GPP TS 38.304, clause 5.2.4.1, 5.2.4.2 and 5.2.4.5. Unless otherwise stated these are Rel-15 requirements.

[TS 38.304, clause 5.2.4.1]

Absolute priorities of different NR frequencies or inter-RAT frequencies may be provided to the UE in the system information, in the *RRCRelease* message, or by inheriting from another RAT at inter-RAT cell (re)selection. In the case of system information, an NR frequency or inter-RAT frequency may be listed without providing a priority (i.e. the field *cellReselectionPriority* is absent for that frequency). If priorities are provided in dedicated signalling, the UE shall ignore all the priorities provided in system information. If UE is in *camped on any cell* state, UE shall only apply the priorities provided by system information from current cell, and the UE preserves priorities provided by dedicated signalling and *deprioritisationReq* received in *RRCRelease* unless specified otherwise. When the UE in camped normally state, has only dedicated priorities other than for the current frequency, the UE shall consider the current frequency to be the lowest priority frequency (i.e. lower than any of the network configured values).

The UE shall only perform cell reselection evaluation for NR frequencies and inter-RAT frequencies that are given in system information and for which the UE has a priority provided.

In case UE receives *RRCRelease* with *deprioritisationReq*, UE shall consider current frequency and stored frequencies due to the previously received *RRCRelease* with *deprioritisationReq* or all the frequencies of NR to be the lowest priority frequency (i.e. lower than any of the network configured values) while T325 is running irrespective of camped RAT. The UE shall delete the stored deprioritisation request(s) when a PLMN selection is performed on request by NAS (TS 23.122 [9]).

NOTE: UE should search for a higher priority layer for cell reselection as soon as possible after the change of priority. The minimum related performance requirements specified in TS 38.133 [8] are still applicable.

The UE shall delete priorities provided by dedicated signalling when:

- the UE enters a different RRC state; or
- the optional validity time of dedicated priorities (T320) expires; or
- a PLMN selection is performed on request by NAS (TS 23.122 [9]).

NOTE 2: Equal priorities between RATs are not supported.

The UE shall not consider any black listed cells as candidate for cell reselection.

The UE shall inherit the priorities provided by dedicated signalling and the remaining validity time (i.e. T320 in NR and E-UTRA), if configured, at inter-RAT cell (re)selection.

NOTE 3: The network may assign dedicated cell

[TS 38.304, clause 5.2.4.2]

Following rules are used by the UE to limit needed measurements:

- If the serving cell fulfils $S_{rxlev} > S_{IntraSearchP}$ and $S_{qual} > S_{IntraSearchQ}$, the UE may choose not to perform intra-frequency measurements.

- Otherwise, the UE shall perform intra-frequency measurements.
- The UE shall apply the following rules for NR inter-frequencies and inter-RAT frequencies which are indicated in system information and for which the UE has priority provided as defined in 5.2.4.1:
 - For a NR inter-frequency or inter-RAT frequency with a reselection priority higher than the reselection priority of the current NR frequency, the UE shall perform measurements of higher priority NR inter-frequency or inter-RAT frequencies according to TS 38.133 [8].
 - For a NR inter-frequency with an equal or lower reselection priority than the reselection priority of the current NR frequency and for inter-RAT frequency with lower reselection priority than the reselection priority of the current NR frequency:
 - If the serving cell fulfils $S_{rxlev} > S_{nonIntraSearchP}$ and $S_{qual} > S_{nonIntraSearchQ}$, the UE may choose not to perform measurements of NR inter-frequencies or inter-RAT frequency cells of equal or lower priority;
- Otherwise, the UE shall perform measurements of NR inter-frequencies or inter-RAT frequency cells of equal or lower priority according to TS 38.133 [8].

[TS 38.304, clause 5.2.4.5]

If *threshServingLowQ* is broadcast in system information and more than 1 second has elapsed since the UE camped on the current serving cell, cell reselection to a cell on a higher priority NR frequency or inter-RAT frequency than the serving frequency shall be performed if:

- A cell of a higher priority NR or EUTRAN RAT/frequency fulfils $S_{qual} > Thresh_{X, HighQ}$ during a time interval $T_{reselection_{RAT}}$

Otherwise, cell reselection to a cell on a higher priority NR frequency or inter-RAT frequency than the serving frequency shall be performed if:

- A cell of a higher priority RAT/ frequency fulfils $S_{rxlev} > Thresh_{X, HighP}$ during a time interval $T_{reselection_{RAT}}$; and
- More than 1 second has elapsed since the UE camped on the current serving cell.

Cell reselection to a cell on an equal priority NR frequency shall be based on ranking for intra-frequency cell reselection as defined in sub-clause 5.2.4.6.

If *threshServingLowQ* is broadcast in system information and more than 1 second has elapsed since the UE camped on the current serving cell, cell reselection to a cell on a lower priority NR frequency or inter-RAT frequency than the serving frequency shall be performed if:

- The serving cell fulfils $S_{qual} < Thresh_{Serving, LowQ}$ and a cell of a lower priority NR or E-UTRAN RAT/ frequency fulfils $S_{qual} > Thresh_{X, LowQ}$ during a time interval $T_{reselection_{RAT}}$.

Otherwise, cell reselection to a cell on a lower priority NR frequency or inter-RAT frequency than the serving frequency shall be performed if:

- The serving cell fulfils $S_{rxlev} < Thresh_{Serving, LowP}$ and a cell of a lower priority RAT/ frequency fulfils $S_{rxlev} > Thresh_{X, LowP}$ during a time interval $T_{reselection_{RAT}}$; and
- More than 1 second has elapsed since the UE camped on the current serving cell.

Cell reselection to a higher priority RAT/frequency shall take precedence over a lower priority RAT/frequency if multiple cells of different priorities fulfil the cell reselection criteria.

If more than one cell meets the above criteria, the UE shall reselect a cell as follows:

- If the highest-priority frequency is an NR frequency, the highest ranked cell among the cells on the highest priority frequency(ies) meeting the criteria according to clause 5.2.4.6;
- If the highest-priority frequency is from another RAT, the highest ranked cell among the cells on the highest priority frequency(ies) meeting the criteria of that RAT.

6.2.3.7.3 Test description

6.2.3.7.3.1 Pre-test conditions

System Simulator:

- NR Cell 1, E-UTRA Cell 1 is higher priority inter-RAT cell.
- System information combination NR-6 as defined in TS 38.508-1 [4] clause 4.4.3.1.3 is used in NR Cell.
- System information combination 31 as defined in TS 36.508-1 [7] clause 4.4.3.1 is used in E-UTRA Cell.

UE:

None.

Preamble:

- With E-UTRA Cell 1 "Serving cell" and NR Cell 1 "Non-suitable "Off" cell" in accordance with TS 38.508-1 [4], Table 6.2.2.1-3, the UE is brought to state RRC_IDLE Connectivity (E-UTRA/EPC) in accordance with the procedure described in TS 38.508-1 [4], Table 4.5.2.2-1. 4G GUTI and eKSI are assigned and security context established.
- the UE is switched-off.
- With E-UTRA Cell 1 "Non-suitable "Off" cell" and NR Cell 1 "Serving cell" in accordance with TS 38.508-1 [4], Table 6.2.2.1-3, the UE is brought to state IN-A, RRC_IDLE Connectivity (NR), in accordance with the procedure described in TS 38.508-1 [4], Table 4.5.2.2-2. 5G-GUTI and ngKSI are assigned and security context established.

6.2.3.7.3.2 Test procedure sequence

Table 6.2.3.7.3.2-1/2 illustrate the downlink power levels and other changing parameters to be applied for the cell at various time instants of the test execution. The exact instants on which these values shall be applied are described in the texts in this clause. Row marked "T0" denotes the conditions in the preamble. Configurations marked "T1" is applied at the points indicated in the Main behaviour description in Table 6.2.3.7.3.2-3.

Table 6.2.3.7.3.2-1: Time instances of cell power level and parameter changes for E-UTRA Cell 1 and NR Cell 1 in FR1

	Parameter	Unit	NR Cell 1	E-UTRA Cell 1	Remark
T0	Cell-specific RS EPRE	dBm/15kHz	-	Off	The power level values are assigned to ensure UE registered on NR Cell 1
	SS/PBCH SSS EPRE	dBm/SCS	-88	-	
T1	Cell-specific RS EPRE	dBm/15kHz	-	-75	The power level values are assigned to satisfy $Srxlev_{NR\ Cell\ 1} > S_{nonintrasearch}$ and $Srxlev_{E-UTRA\ Cell\ 1} > Thresh_{x, high}$.
	SS/PBCH SSS EPRE	dBm/SCS	-90	-	

Table 6.2.3.7.3.2-2: Time instances of cell power level and parameter changes for E-UTRA Cell 1 and NR Cell 1 in FR2

	Parameter	Unit	NR Cell 1	E-UTRA Cell 1	Remark
T0	Cell-specific RS EPRE	dBm/15kHz	-	Off	The power level values are assigned to ensure UE registered on NR Cell 1
	SS/PBCH SSS EPRE	dBm/SCS	FFS	-	

T1	Cell-specific RS EPRE	dBm/15kHz	-	-75	The power level values are assigned to satisfy $S_{rxlev}^{NR \text{ Cell } 1} > S_{nonintra\text{search}}$ and $S_{rxlev}^{E-UTRA \text{ Cell } 1} > \text{Thresh}_x, \text{high}$.
	SS/PBCH SSS EPRE	dBm/SCS	FFS	-	

Table 6.2.3.7.3.2-3: Main behaviour

St	Procedure	Message Sequence		TP	Verdict
		U - S	Message		
1	The SS adjusts the NR and E-UTRAN Cell power levels according to row "T1" in table 6.2.3.7.3.2-1/2.	-	-	-	-
2	Check: Does the test result of generic test procedure in TS 38.508-1 [4] Table 4.9.7.2.2-1 is performed and the UE is camped on E-UTRAN Cell 1?	-	-	1	-

6.2.3.7.3.3 Specific message contents

Table 6.2.3.7.3.3-1: SIB2 of NR Cell 1 (preabmlle and all steps, Table 6.2.3.7.3.2-3)

Derivation Path: TS 38.508-1 [4], Table 4.6.2-1			
Information Element	Value/remark	Comment	Condition
SIB2 ::= SEQUENCE {			
cellReselectionServingFreqInfo			
SEQUENCE {			
s-NonIntraSearchP	3	6 dB	
threshServingLowP	3	6 dB	
}			
}			

Table 6.2.3.7.3.3-2: SIB5 of NR Cell 1 (preamble and all steps, Table 6.2.3.7.3.2-3)

Derivation Path: TS 38.508-1 [4], Table 4.6.2-4			
Information Element	Value/remark	Comment	Condition
SIB5 ::= SEQUENCE {			
carrierFreqListEUTRA SEQUENCE (SIZE (1..maxEUTRA-Carrier)) OF CarrierFreqEUTRA {	1 entry		
CarrierFreqEUTRA[1] SEQUENCE {		entry 1	
carrierFreq	Downlink EUTRA ARFCN as E-UTRA Cell 1 used		
cellReselectionPriority	5		
threshX-High	10	20 dB	
threshX-Low	20	40 dB	
}			
}			
t-ReselectionEUTRA	7	7 Seconds	
}			

Table 6.2.3.7.3.3-3: SystemInformationBlockType3 of EUTRA Cell 1 (preamble and all steps, Table 6.2.3.7.3.2-3)

Derivation Path: TS 36.508 [7], Table 4.4.3.3-2			
Information Element	Value/remark	Comment	Condition
SystemInformationBlockType3 ::= SEQUENCE {			
cellReselectionServingFreqInfo SEQUENCE {			
threshServingLow	3	6 dB	
}			
}			

Table 6.2.3.7.3.3-4: SystemInformationBlockType24 for EUTRA Cell 1 (preamble and all steps, Table 6.2.3.7.3.2-3)

Derivation path: TS 36.508 [7], Table 4.4.3.3-20			
Information Element	Value/Remark	Comment	Condition
SystemInformationBlockType24-r15 ::= SEQUENCE {			
carrierFreqListNR-r15 SEQUENCE (SIZE (1..maxFreq)) OF CarrierFreqNR-r15 {	1 entry		
CarrierFreqNR-r15[1] SEQUENCE {		entry 1	
carrierFreq-r15	Same downlink SSB ARFCN as used for NR Cell 1		
cellReselectionPriority-r15	3		
threshX-High-r15	15	30 dB	
threshX-Low-r15	15	30 dB	
}			
t-ReselectionNR-r15	7	7 Seconds	
}			

6.2.3.8 Inter-RAT cell reselection/From E-UTRA RRC_IDLE to NR RRC_Idle, Snonintrasearch

6.2.3.8.1 Test Purpose (TP)

(1)

```
with { UE in E-UTRA RRC_Idle state, and the UE is not in high mobility state }
ensure that {
  when { Snonintrasearch is non-zero in system information }
  then { UE perform measurement and reselects to cell which belongs to the high priority NR cell
even if Srxlev>Snonintrasearch }
}
```

6.2.3.8.2 Conformance requirements

References: The conformance requirements covered in the present TC are specified in: 3GPP TS 36.304, clause 5.2.4.1, 5.2.4.2 and 5.2.4.5. Unless otherwise stated these are Rel-15 requirements.

[TS 36.304, clause 5.2.4.1]

Absolute priorities of different E-UTRAN frequencies or inter-RAT frequencies may be provided to the UE in the system information, in the *RRCCConnectionRelease* message, or by inheriting from another RAT at inter-RAT cell (re)selection. In the case of system information, an E-UTRAN frequency or inter-RAT frequency may be listed without providing a priority (i.e. the field *cellReselectionPriority* is absent for that frequency). If priorities are provided in dedicated signalling, the UE shall ignore all the priorities provided in system information. If UE is in *camped on any cell* state, UE shall only apply the priorities provided by system information from current cell, and the UE preserves priorities provided by dedicated signalling and *deprioritisationReq* received in *RRCCConnectionReject* unless specified otherwise. When the UE in *camped normally* state, has only dedicated priorities other than for the current frequency, the UE shall consider the current frequency to be the lowest priority frequency (i.e. lower than any of the network configured values). While the UE is camped on a suitable CSG cell in normal coverage, the UE shall always consider the current frequency to be the highest priority frequency (i.e. higher than any of the network configured values), irrespective of any other priority value allocated to this frequency. When the HSDN capable UE is in High-mobility state, the UE shall always consider the HSDN cells to be the highest priority (i.e. higher than any other network configured priorities). When the HSDN capable UE is not in High-mobility state, the UE shall always consider HSDN cells to be the lowest priority (i.e. lower than network configured priorities). If the UE capable of sidelink communication is configured to perform sidelink communication and can only perform the sidelink communication while camping on a frequency, the UE may consider that frequency to be the highest priority. If the UE capable of V2X sidelink communication is configured to perform V2X sidelink communication and can only perform the V2X sidelink communication while camping on a frequency, the UE may consider that frequency to be the highest priority. If the UE capable of V2X sidelink communication is configured to perform V2X sidelink communication and can only use pre-configuration while not camping on a frequency, the UE may consider the frequency providing inter-carrier V2X sidelink configuration to be the highest priority. If the UE capable of sidelink discovery is configured to perform Public

Safety related sidelink discovery and can only perform the Public Safety related sidelink discovery while camping on a frequency, the UE may consider that frequency to be the highest priority.

NOTE 1: The prioritization among the frequencies which UE considers to be the highest priority frequency is left to UE implementation.

If the UE is capable either of MBMS Service Continuity or of SC-PTM reception and is receiving or interested to receive an MBMS service and can only receive this MBMS service while camping on a frequency on which it is provided, the UE may consider that frequency to be the highest priority during the MBMS session TS 36.300 [2] as long as the two following conditions are fulfilled:

1) Either:

- the UE is capable of MBMS service continuity and the reselected cell is broadcasting SIB13; or
- the UE is capable of SC-PTM reception and the reselected cell is broadcasting SIB20;

2) Either:

- SIB15 of the serving cell indicates for that frequency one or more MBMS SAIs included and associated with that frequency in the MBMS User Service Description (USD) TS 26.346 [22] of this service; or
- SIB15 is not broadcast in the serving cell and that frequency is included in the USD of this service.

If the UE is capable either of MBMS Service Continuity or of SC-PTM reception and is receiving or interested to receive an MBMS service provided on a downlink only MBMS frequency, on a frequency used by dedicated MBMS cells, on a frequency used by FeMBMS/Unicast-mixed cells as defined in TS 36.300 [2], or on a frequency belonging to PLMN different from its registered PLMN, the UE may consider cell reselection candidate frequencies at which it can not receive the MBMS service to be of the lowest priority during the MBMS session TS 36.300 [2], as long as the above mentioned condition 1) is fulfilled for the cell on the MBMS frequency which the UE monitors or this cell broadcasts SIB1-MBMS and as long as the above mentioned condition 2) is fulfilled for the serving cell.

NOTE 2: Example scenarios in which the previous down-prioritisation may be needed concerns the cases where camping is not possible, while the UE can only receive this MBMS frequency when camping on a subset of cell reselection candidate frequencies, e.g. the MBMS frequency is a downlink only carrier, the MBMS frequency is used by dedicated MBMS cells, the MBMS frequency is used by FeMBMS/Unicast-mixed cells TS 36.300 [2], or the MBMS frequency belongs to a PLMN different from UE's registered PLMN.

If the UE is not capable of MBMS Service Continuity but has knowledge on which frequency an MBMS service of interest is provided, it may consider that frequency to be the highest priority during the MBMS session TS 36.300 [2] as long as the reselected cell is broadcasting SIB13.

If the UE is not capable of MBMS Service Continuity but has knowledge on which downlink only frequency, on which frequency used by dedicated MBMS cells, on which frequency used by FeMBMS/Unicast-mixed cells as defined in TS 36.300 [2] or on which frequency belonging to PLMN different from its registered PLMN an MBMS service of interest is provided, it may consider cell reselection candidate frequencies at which it can not receive the MBMS service to be of the lowest priority during the MBMS session TS 36.300 [2] as long as the cell on the MBMS frequency which the UE monitors is broadcasting SIB13 or SIB1-MBMS.

NOTE 3: The UE considers that the MBMS session is ongoing using the session start and end times as provided by upper layers in the USD i.e. the UE does not verify if the session is indicated on MCCH.

In case UE receives *RRConnectionReject* with *deprioritisationReq*, UE shall consider current carrier frequency and stored frequencies due to the previously received *RRConnectionReject* with *deprioritisationReq* or all the frequencies of EUTRA to be the lowest priority frequency (i.e. lower than any of the network configured values) while T325 is running irrespective of camped RAT. The UE shall delete the stored deprioritisation request(s) when a PLMN selection is performed on request by NAS TS 23.122 [5].

NOTE 4: Connecting to CDMA2000 does not imply PLMN selection.

NOTE 5: UE should search for a higher priority layer for cell reselection as soon as possible after the change of priority. The minimum related performance requirements specified in TS 36.133 [10] are still applicable.

The UE shall delete priorities provided by dedicated signalling when:

- the UE enters a different RRC state; or

- the optional validity time of dedicated priorities (T320) expires; or
- a PLMN selection is performed on request by NAS TS 23.122 [5].

NOTE 6: Equal priorities between RATs are not supported.

The UE shall only perform cell reselection evaluation for E-UTRAN frequencies and inter-RAT frequencies that are given in system information and for which the UE has a priority provided.

The UE shall not consider any black listed cells as candidate for cell reselection.

The UE shall inherit the priorities provided by dedicated signalling and the remaining validity time (i.e., T320 in E-UTRA and NR, T322 in UTRA and T3230 in GERAN), if configured, at inter-RAT cell (re)selection.

NOTE 7: The network may assign dedicated cell reselection priorities for frequencies not configured by system information.

While T360 is running, redistribution target is considered to be the highest priority (i.e. higher than any of the network configured values). UE shall continue to consider the serving frequency as the highest priority until completion of E-UTRAN Inter-frequency Redistribution procedure specified in 5.2.4.10 if triggered on T360 expiry/ stop.

[TS 36.304, clause 5.2.4.2]

For NB-IoT measurement rules for cell re-selection is defined in sub-clause 5.2.4.2.a.

When evaluating S_{rxlev} and S_{qual} of non-serving cells for reselection purposes, the UE shall use parameters provided by the serving cell.

Following rules are used by the UE to limit needed measurements:

- If the serving cell fulfils $S_{rxlev} > S_{IntraSearchP}$ and $S_{qual} > S_{IntraSearchQ}$, the UE may choose not to perform intra-frequency measurements.
- Otherwise, the UE shall perform intra-frequency measurements.
- The UE shall apply the following rules for E-UTRAN inter-frequencies and inter-RAT frequencies which are indicated in system information and for which the UE has priority provided as defined in 5.2.4.1:
 - For an E-UTRAN inter-frequency or inter-RAT frequency with a reselection priority higher than the reselection priority of the current E-UTRA frequency the UE shall perform measurements of higher priority E-UTRAN inter-frequency or inter-RAT frequencies according to TS 36.133 [10].
 - For an E-UTRAN inter-frequency with an equal or lower reselection priority than the reselection priority of the current E-UTRA frequency and for inter-RAT frequency with lower reselection priority than the reselection priority of the current E-UTRAN frequency:
 - If the serving cell fulfils $S_{rxlev} > S_{nonIntraSearchP}$ and $S_{qual} > S_{nonIntraSearchQ}$, the UE may choose not to perform measurements of E-UTRAN inter-frequencies or inter-RAT frequency cells of equal or lower priority unless the UE is triggered to measure an E-UTRAN inter-frequency which is configured with *redistributionInterFreqInfo*.
 - Otherwise, the UE shall perform measurements of E-UTRAN inter-frequencies or inter-RAT frequency cells of equal or lower priority according to TS 36.133 [10].
- If the UE supports relaxed monitoring and *s-SearchDeltaP* is present in *SystemInformationBlockType3*, the UE may further limit the needed measurements, as specified in sub-clause 5.2.4.12.

[TS 36.304, clause 5.2.4.5]

For NB-IoT inter-frequency cell reselection shall be based on ranking as defined in sub-clause 5.2.4.6.

If *threshServingLowQ* is provided in *SystemInformationBlockType3* and more than 1 second has elapsed since the UE camped on the current serving cell, cell reselection to a cell on a higher priority E-UTRAN frequency or inter-RAT frequency than the serving frequency shall be performed if:

- A cell of a higher priority EUTRAN, NR or UTRAN FDD RAT/ frequency fulfils $S_{qual} > Thresh_{X, HighQ}$ during a time interval $T_{reselection_{RAT}}$; or

- A cell of a higher priority UTRAN TDD, GERAN or CDMA2000 RAT/ frequency fulfils $Srxlev > Thresh_{X, HighP}$ during a time interval $Treselection_{RAT}$.

Otherwise, cell reselection to a cell on a higher priority E-UTRAN frequency or inter-RAT frequency than the serving frequency shall be performed if:

- A cell of a higher priority RAT/ frequency fulfils $Srxlev > Thresh_{X, HighP}$ during a time interval $Treselection_{RAT}$; and
- More than 1 second has elapsed since the UE camped on the current serving cell.

Cell reselection to a cell on an equal priority E-UTRAN frequency shall be based on ranking for Intra-frequency cell reselection as defined in sub-clause 5.2.4.6.

If *threshServingLowQ* is provided in *SystemInformationBlockType3* and more than 1 second has elapsed since the UE camped on the current serving cell, cell reselection to a cell on a lower priority E-UTRAN frequency or inter-RAT frequency than the serving frequency shall be performed if:

- The serving cell fulfils $Squal < Thresh_{Serving, LowQ}$ and a cell of a lower priority EUTRAN, NR or UTRAN FDD RAT/ frequency fulfils $Squal > Thresh_{X, LowQ}$ during a time interval $Treselection_{RAT}$; or
- The serving cell fulfils $Squal < Thresh_{Serving, LowQ}$ and a cell of a lower priority UTRAN TDD, GERAN or CDMA2000 RAT/ frequency fulfils $Srxlev > Thresh_{X, LowP}$ during a time interval $Treselection_{RAT}$.

Otherwise, cell reselection to a cell on a lower priority E-UTRAN frequency or inter-RAT frequency than the serving frequency shall be performed if:

- The serving cell fulfils $Srxlev < Thresh_{Serving, LowP}$ and a cell of a lower priority RAT/ frequency fulfils $Srxlev > Thresh_{X, LowP}$ during a time interval $Treselection_{RAT}$; and
- More than 1 second has elapsed since the UE camped on the current serving cell.

Cell reselection to a higher priority RAT/ frequency shall take precedence over a lower priority RAT/ frequency, if multiple cells of different priorities fulfil the cell reselection criteria.

The UE shall not perform cell reselection to NR or UTRAN FDD cells for which the cell selection criterion S is not fulfilled.

For cdma2000 RATs, $Srxlev$ is equal to $-FLOOR(-2 \times 10 \times \log_{10} Ec/I_0)$ in units of 0.5 dB, as defined in [18], with Ec/I_0 referring to the value measured from the evaluated cell.

For cdma2000 RATs, $Thresh_{X, HighP}$ and $Thresh_{X, LowP}$ are equal to -1 times the values signalled for the corresponding parameters in the system information.

In all the above criteria the value of $Treselection_{RAT}$ is scaled when the UE is in the medium or high mobility state as defined in subclause 5.2.4.3.1. If more than one cell meets the above criteria, the UE shall reselect a cell as follows:

- If the highest-priority frequency is an E-UTRAN frequency, a cell ranked as the best cell among the cells on the highest priority frequency(ies) meeting the criteria according to clause 5.2.4.6;
- If the highest-priority frequency is from another RAT, a cell ranked as the best cell among the cells on the highest priority frequency(ies) meeting the criteria of that RAT.

Cell reselection to another RAT, for which $Squal$ based cell reselection parameters are broadcast in system information, shall be performed based on the $Squal$ criteria if the UE supports $Squal$ (RSRQ) based cell reselection to E-UTRAN from all the other RATs provided by system information which UE supports. Otherwise, cell reselection to another RAT shall be performed based on $Srxlev$ criteria.

Cell reselection to NR, for which a cell reselection parameter, *q-RxLevMinSUL* is broadcast in system information and the UE supports SUL, shall be performed based on $Srxlev$ criteria taking the parameter into account.

6.2.3.8.3 Test description

6.2.3.8.3.1 Pre-test conditions

System Simulator:

- E-UTRA Cell 1, NR Cell 1 is higher priority inter-RAT NR cell.
- System information combination 31 as defined in TS 36.508-1 [7] clause 4.4.3.1 is used in E-UTRA Cell.
- System information combination NR-6 as defined in TS 38.508-1 [4] clause 4.4.3.1.3 is used in NR Cell.

UE:

- None.

Preamble:

- With E-UTRA Cell 1 "Non-suitable "Off" cell" and NR Cell 1 "Serving cell" in accordance with TS 38.508-1 [4], Table 6.2.2.1-3, the UE is brought to state 1N-A, RRC_IDLE Connectivity (NR), in accordance with the procedure described in TS 38.508-1 [4], Table 4.5.2.2-2. 5G-GUTI and ngKSI are assigned and security context established.
- the UE is switched-off.
- With E-UTRA Cell 1 "Serving cell" and NR Cell 1 "Non-suitable "Off" cell" in accordance with TS 38.508-1 [4], Table 6.2.2.1-3, the UE is brought to state RRC_IDLE Connectivity (E) in accordance with the procedure described in TS 38.508-1 [4], Table 4.5.2.2-1. 4G GUTI and eKSI are assigned and security context established.

6.2.3.8.3.2 Test procedure sequence

Table 6.2.3.8.3.2-1/2 illustrate the downlink power levels and other changing parameters to be applied for the cell at various time instants of the test execution. The exact instants on which these values shall be applied are described in the texts in this clause. Row marked "T0" denotes the conditions in the preamble. Configurations marked "T1" is applied at the points indicated in the Main behaviour description in Table 6.2.3.8.3.2-3.

Table 6.2.3.8.3.2-1: Time instances of cell power level and parameter changes for E-UTRA Cell and NR Cell in FR1

	Parameter	Unit	E-UTRA Cell 1	NR Cell 1	Remark
T0	Cell-specific RS EPRE	dBm/15kHz	-85	-	The power level values are assigned to ensure UE registered on E-UTRA Cell 1
	SS/PBCH SSS EPRE	dBm/SCS	-	Off	
T1	Cell-specific RS EPRE	dBm/15kHz	-90	-	The power level values are assigned to satisfy $S_{rxlev\ E-UTRA\ Cell\ 1} > S_{noninrasearch}$ and $S_{rxlev\ NR\ Cell\ 1} > Thresh_{x, high}$.
	SS/PBCH SSS EPRE	dBm/SCS	-	-80	

Table 6.2.3.8.3.2-2: Time instances of cell power level and parameter changes for E-UTRA Cell and NR Cell in FR2

	Parameter	Unit	E-UTRA Cell 1	NR Cell 1	Remark
T0	Cell-specific RS EPRE	dBm/15kHz	FFS	-	The power level values are assigned to ensure UE registered on E-UTRA Cell 1
	SS/PBCH SSS EPRE	dBm/SCS	-	Off	
T1	Cell-specific RS EPRE	dBm/15kHz	FFS	-	The power level values are assigned to satisfy $S_{rxlev\ E-UTRA\ Cell\ 1} > S_{noninrasearch}$ and $S_{rxlev\ NR\ Cell\ 1} > Thresh_{x, high}$.
	SS/PBCH SSS EPRE	dBm/SCS	-	FFS	

Table 6.2.3.8.3.2-3: Main behaviour

St	Procedure	Message Sequence		TP	Verdict
		U - S	Message		
1	The SS adjusts the E-UTRAN and NR Cell power levels according to row "T1" in table 6.2.3.8.3.2-1/2.	-	-	-	-
2	Check: Does the test result of generic test procedure in TS 38.508-1 [4] Table 4.9.9.2.2-1 indicate that the UE is camped on NR Cell 1? NOTE: This is the first time in this test case that the UE moves from S1 to N1.	-	-	1	-
3	Void.	-	-	-	-

6.2.3.8.3.3 Specific message contents

Table 6.2.3.8.3.3-1: SystemInformationBlockType3 of EUTRA Cell 1 (preamble and all steps, Table 6.2.3.8.3.2-3)

Derivation Path: TS 36.508 [7], Table 4.4.3.3-2			
Information Element	Value/remark	Comment	Condition
SystemInformationBlockType3 ::= SEQUENCE {			
cellReselectionServingFreqInfo SEQUENCE {			
s-NonIntraSearch	3	6 dB	
threshServingLow	3	6 dB	
}			

Table 6.2.3.8.3.3-2: SystemInformationBlockType24 of EUTRA Cell 1 (preamble and all steps, Table 6.2.3.8.3.2-3)

Derivation path: TS 36.508 [7], Table 4.4.3.3-20			
Information Element	Value/Remark	Comment	Condition
SystemInformationBlockType24-r15 ::= SEQUENCE {			
carrierFreqListNR-r15 SEQUENCE (SIZE (1..maxFreq)) OF CarrierFreqNR-r15 {	1 entry		
CarrierFreqNR-r15[1] SEQUENCE {		entry 1	
carrierFreq-r15	Same downlink SSB ARFCN as used for NR Cell 1		
}			
cellReselectionPriority-r15	5		
threshX-High-r15	10	20 dB	
threshX-Low-r15	20	40 dB	
}			
}			
t-ReselectionNR-r15	7	7 Seconds	
}			

Table 6.2.3.8.3.3-3: SIB2 of NR Cell 1 (preabmle and all steps, Table 6.2.3.8.3.2-3)

Derivation Path: TS 38.508-1 [4], Table 4.6.2-1			
Information Element	Value/remark	Comment	Condition
SIB2 ::= SEQUENCE {			
cellReselectionServingFreqInfo SEQUENCE {			
threshServingLowP	3	6 dB	
}			
}			

Table 6.2.3.8.3.3-4: SIB5 of NR Cell 1(preamble and all steps, Table 6.2.3.8.3.2-3)

Derivation Path: TS 38.508 [6], Table 4.6.2-4			
Information Element	Value/remark	Comment	Condition
SIB5 ::= SEQUENCE {			
carrierFreqListEUTRA SEQUENCE (SIZE (1..maxEUTRA-Carrier)) OF CarrierFreqEUTRA {	1 entry		
CarrierFreqEUTRA[1] SEQUENCE {		entry 1	
carrierFreq	Downlink EUTRA ARFCN as E-UTRA Cell 1 used		
cellReselectionPriority	3		
threshX-High	15	30 dB	
threshX-Low	15	30 dB	
}			
}			
t-ReselectionEUTRA	7	7 Seconds	
}			

6.2.3.9 Speed Dependent Cell Reselection (NR RRC_IDLE to E-UTRA RRC_IDLE)

6.2.3.9.1 Test Purpose (TP)

(1)

```
with { UE in NR RRC_IDLE state and in high mobility state }
ensure that {
  when { UE detects higher priority E-UTRA cell as candidate for reselection }
  then { UE reselects to the new cell taking into account the scaling factor }
}
```

Editor's Note: 38.304 is not clear on whether inter-RAT cell changes shall be counted for mobility state estimation.

6.2.3.9.2 Conformance requirements

References: The conformance requirements covered in the present TC are specified in TS 38.304: clause 5.2.4.3 and 5.2.4.3.1 and TS 38.133 clause 4.2.2.3 and 4.2.2.5 and TS 36.133 clause 4.2.2.5.6. Unless otherwise stated these are Rel-15 requirements.

[TS 38.304, clause1]

The present document applies to all UEs that support at least NR Radio Access, including multi-RAT UEs as described in 3GPP specifications, in the following cases:

- When the UE is camped on a NR cell;
- When the UE is searching for a cell to camp on;

NOTE: When the UE is camped on or searching for a cell to camp on belonging to other RATs, the UE behaviour is described in the specifications of the other RATs.

[TS 38.304, clause 5.2.4.3]

The UE mobility state is determined if the parameters (T_{CRmax} , $N_{CR,H}$, $N_{CR,M}$ and $T_{CRmaxHyst}$) are broadcasted in system information for the serving cell.

State detection criteria:

Normal-mobility state criteria:

- If number of cell reselections during time period T_{CRmax} is less than $N_{CR,M}$.

Medium-mobility state criteria:

- If number of cell reselections during time period T_{CRmax} is greater than or equal to N_{CR_M} but less than or equal to N_{CR_H} .

High-mobility state criteria:

- If number of cell reselections during time period T_{CRmax} is greater than N_{CR_H} .

The UE shall not consider consecutive reselections where a cell is reselected again right after one reselection for mobility state detection criteria.

State transitions:

The UE shall:

- if the criteria for High-mobility state is detected:
 - enter High-mobility state.
- else if the criteria for Medium-mobility state is detected:
 - enter Medium-mobility state.
- else if criteria for either Medium- or High-mobility state is not detected during time period $T_{CRmaxHyst}$:
 - enter Normal-mobility state.

[TS 38.304, clause 5.2.4.3.1]

UE shall apply the following scaling rules:

- If neither Medium- nor High-mobility state is detected:
 - no scaling is applied.
- If High-mobility state is detected:
 - Add the *sf-High* of "Speed dependent ScalingFactor for Q_{hyst} " to Q_{hyst} if broadcasted in system information;
 - For NR cells, multiply $T_{reselection_{NR}}$ by the *sf-High* of "Speed dependent ScalingFactor for $T_{reselection_{NR}}$ " if broadcasted in system information;
 - For EUTRA cells, multiply $T_{reselection_{EUTRA}}$ by the *sf-High* of "Speed dependent ScalingFactor for $T_{reselection_{EUTRA}}$ " if broadcasted in system information.

...

In case scaling is applied to any $T_{reselection_{RAT}}$ parameter, the UE shall round up the result after all scalings to the nearest second.

[TS 38.133, clause 4.2.2.3]

The UE shall be able to identify new intra-frequency cells and perform SS-RSRP and SS-RSRQ measurements of the identified intra-frequency cells without an explicit intra-frequency neighbour list containing physical layer cell identities.

The UE shall be able to evaluate whether a newly detectable intra-frequency cell meets the reselection criteria defined in TS 38.304 within T_{detect, NR_Intra} when that $T_{reselection} = 0$. An intra frequency cell is considered to be detectable according to the conditions defined in Annex B.1.2 for a corresponding Band.

The UE shall measure SS-RSRP and SS-RSRQ at least every $T_{measure, NR_Intra}$ (see table 4.2.2.3-1) for intra-frequency cells that are identified and measured according to the measurement rules.

The UE shall filter SS-RSRP and SS-RSRQ measurements of each measured intra-frequency cell using at least 2 measurements. Within the set of measurements used for the filtering, at least two measurements shall be spaced by at least $T_{measure, NR_Intra}/2$.

The UE shall not consider a NR neighbour cell in cell reselection, if it is indicated as not allowed in the measurement control system information of the serving cell.

For an intra-frequency cell that has been already detected, but that has not been reselected to, the filtering shall be such that the UE shall be capable of evaluating that the intra-frequency cell has met reselection criterion defined [1] within $T_{\text{evaluate,NR_Intra}}$ when $T_{\text{reselection}} = 0$ as specified in table 4.2.2.3-1 provided that:

- when *rangeToBestCell* is not configured, the cell has at least [3]dB in FR1 or [TBD]dB in FR2 better ranked or
- when *rangeToBestCell* is configured, the cell which has the highest number of beams above the threshold *absThreshSS-BlocksConsolidation* among the cells whose cell-ranking criterion R value as specified in TS 38.304 [1, Section 5.2.4.6] is within *rangeToBestCell* of the R value of the best cell where the best cell has at least [TBD] in FR1 or [TBD]dB in FR2 better ranked, and if there are multiple such cells the UE shall perform cell reselection to the highest ranked cell among them.

When evaluating cells for reselection, the SSB side conditions apply to both serving and non-serving intra-frequency cells.

If $T_{\text{reselection}}$ timer has a non zero value and the intra-frequency cell is satisfied with the reselection criteria which are defined in TS38.304 [1], the UE shall evaluate this intra-frequency cell for the $T_{\text{reselection}}$ time. If this cell remains satisfied with the reselection criteria within this duration, then the UE shall reselect that cell.

Table 4.2.2.3-1: $T_{\text{detect,NR_Intra}}$, $T_{\text{measure,NR_Intra}}$ and $T_{\text{evaluate,NR_Intra}}$

DRX cycle length [s]	Scaling Factor (N1)		$T_{\text{detect,NR_Intra}}$ [s] (number of DRX cycles)	$T_{\text{measure,NR_Intra}}$ [s] (number of DRX cycles)	$T_{\text{evaluate,NR_Intra}}$ [s] (number of DRX cycles)
	FR1	FR2 ^{Note1}			
0.32	1	8	$11.52 \times N1 \times M2$ (36 x N1 x M2)	$1.28 \times N1 \times M2$ (4 x N1 x M2)	$5.12 \times N1 \times M2$ (16 x N1 x M2)
0.64		5	$17.92 \times N1$ (28 x N1)	$1.28 \times N1$ (2 x N1)	$5.12 \times N1$ (8 x N1)
1.28		4	$32 \times N1$ (25 x N1)	$1.28 \times N1$ (1 x N1)	$6.4 \times N1$ (5 x N1)
2.56		3	$58.88 \times N1$ (23 x N1)	$2.56 \times N1$ (1 x N1)	$7.68 \times N1$ (3 x N1)
Note 1: Applies for UE supporting power class 2&3&4. For UE supporting power class 1, N1 = 8 for all DRX cycle length.					
Note 2: M2 = 1.5 if SMTC periodicity of measured intra-frequency cell > 20 ms; otherwise M2=1.					

[TS 38.133, clause 4.2.2.5]

If $S_{\text{rxlev}} > S_{\text{nonIntraSearchP}}$ and $S_{\text{qual}} > S_{\text{nonIntraSearchQ}}$ then the UE shall search for inter-RAT E-UTRAN layers of higher priority at least every $T_{\text{higher_priority_search}}$ where $T_{\text{higher_priority_search}}$ is described in clause 4.2.2

If $S_{\text{rxlev}} \leq S_{\text{nonIntraSearchP}}$ or $S_{\text{qual}} \leq S_{\text{nonIntraSearchQ}}$ then the UE shall search for and measure inter-RAT E-UTRAN layers of higher, lower priority in preparation for possible reselection. In this scenario, the minimum rate at which the UE is required to search for and measure higher priority inter-RAT E-UTRAN layers shall be the same as that defined below for lower priority RATs.

The requirements in this section apply for inter-RAT E-UTRAN FDD measurements and E-UTRA TDD measurements. When the measurement rules indicate that inter-RAT E-UTRAN cells are to be measured, the UE shall measure RSRP and RSRQ of detected E-UTRA cells in the neighbour frequency list at the minimum measurement rate specified in this section. The parameter $N_{\text{EUTRA_carrier}}$ is the total number of configured E-UTRA carriers in the neighbour frequency list. The UE shall filter RSRP and RSRQ measurements of each measured E-UTRA cell using at least 2 measurements. Within the set of measurements used for the filtering, at least two measurements shall be spaced by at least $T_{\text{measure,EUTRAN}}/2$.

An inter-RAT E-UTRA cell is considered to be detectable provided the following conditions are fulfilled:

- the same conditions as for inter-frequency RSRP measurements specified in TS 36.133 [15, Annex B.1.2] are fulfilled for a corresponding Band, and
- the same conditions as for inter-frequency RSRQ measurements specified in TS 36.133 [15, Annex B.1.2] are fulfilled for a corresponding Band.
- SCH conditions specified in TS 36.133 [15, Annex B.1.2] are fulfilled for a corresponding Band

The UE shall be able to evaluate whether a newly detectable inter-RAT E-UTRAN cell meets the reselection criteria defined in TS38.304 within $(N_{\text{EUTRA_carrier}}) * T_{\text{detect,EUTRAN}}$ when $S_{\text{rxlev}} \leq S_{\text{nonIntraSearchP}}$ or $S_{\text{qual}} \leq S_{\text{nonIntraSearchQ}}$ when

$T_{\text{reselection}} = 0$ provided that the reselection criteria is met by a margin of at least 6dB for RSRP reselections based on absolute priorities or 4dB for RSRQ reselections based on absolute priorities.

Cells which have been detected shall be measured at least every $(N_{\text{EUTRA_carrier}}) * T_{\text{measure,EUTRAN}}$ when $S_{\text{rxlev}} \leq S_{\text{nonIntraSearchP}}$ or $S_{\text{qual}} \leq S_{\text{nonIntraSearchQ}}$.

When higher priority cells are found by the higher priority search, they shall be measured at least every $T_{\text{measure,EUTRAN}}$. If, after detecting a cell in a higher priority search, it is determined that reselection has not occurred then the UE is not required to continuously measure the detected cell to evaluate the ongoing possibility of reselection. However, the minimum measurement filtering requirements specified later in this section shall still be met by the UE before it makes any determination that it may stop measuring the cell.

If the UE detects on an inter-RAT E-UTRAN carrier a cell whose physical identity is indicated as not allowed for that carrier in the measurement control system information of the serving cell, the UE is not required to perform measurements on that cell.

The UE shall not consider an inter-RAT E-UTRA cell in cell reselection, if it is indicated as not allowed in the measurement control system information of the serving cell.

For a cell that has been already detected, but that has not been reselected to, the filtering shall be such that the UE shall be capable of evaluating that an already identified inter-RAT E-UTRA cell has met reselection criterion defined in TS 38.304 [1] within $(N_{\text{EUTRA_carrier}}) * T_{\text{evaluate,EUTRAN}}$ when $T_{\text{reselection}} = 0$ as specified in table 4.2.2.5-1 provided that the reselection criteria is met by a margin of at least 6dB for RSRP reselections based on absolute priorities or 4dB for RSRQ reselections based on absolute priorities.

If $T_{\text{reselection}}$ timer has a non zero value and the inter-RAT E-UTRA cell is satisfied with the reselection criteria which are defined in [1], the UE shall evaluate this E-UTRA cell for the $T_{\text{reselection}}$ time. If this cell remains satisfied with the reselection criteria within this duration, then the UE shall reselect that cell.

Table 4.2.2.5-1: $T_{\text{detect,EUTRAN}}$, $T_{\text{measure,EUTRAN}}$, and $T_{\text{evaluate,EUTRAN}}$

DRX cycle length [s]	$T_{\text{detect,EUTRAN}}$ [s] (number of DRX cycles)	$T_{\text{measure,EUTRAN}}$ [s] (number of DRX cycles)	$T_{\text{evaluate,EUTRAN}}$ [s] (number of DRX cycles)
0.32	11.52 (36)	1.28 (4)	5.12 (16)
0.64	17.92 (28)	1.28 (2)	5.12 (8)
1.28	32(25)	1.28 (1)	6.4 (5)
2.56	58.88 (23)	2.56 (1)	7.68 (3)

[TS 36.133, clause 4.2.2.5.6]

If $S_{\text{rxlev}} > S_{\text{nonIntraSearchP}}$ and $S_{\text{qual}} > S_{\text{nonIntraSearchQ}}$ then the UE shall search for inter-RAT NR layers of higher priority at least every $T_{\text{higher_priority_search}}$ where $T_{\text{higher_priority_search}}$ is described in clause 4.2.2.

If $S_{\text{rxlev}} \leq S_{\text{nonIntraSearchP}}$ or $S_{\text{qual}} \leq S_{\text{nonIntraSearchQ}}$ then the UE shall search for and measure inter-RAT NR layers of higher, lower priority in preparation for possible reselection. In this scenario, the minimum rate at which the UE is required to search for and measure higher priority inter-RAT NR layers shall be the same as that defined below for lower priority RATs.

The requirements in this section apply for inter-RAT NR measurements. When the measurement rules indicate that inter-RAT NR cells are to be measured, the UE shall measure SS-RSRP and SS-RSRQ of detected NR cells in the neighbour frequency list at the minimum measurement rate specified in this section. The parameter $N_{\text{NR_carrier}}$ is the total number of configured NR carriers in the neighbour frequency list. The UE shall filter SS-RSRP and SS-RSRQ measurements of each measured NR cell using at least 2 measurements. Within the set of measurements used for the filtering, at least two measurements shall be spaced by at least half the minimum specified measurement period.

The UE shall be able to evaluate whether a newly detectable inter-RAT NR cell meets the reselection criteria defined in TS 36.304 [1] within $(N_{\text{NR_carrier}}) * T_{\text{detectNR}}$ when $S_{\text{rxlev}} \leq S_{\text{nonIntraSearchP}}$ or $S_{\text{qual}} \leq S_{\text{nonIntraSearchQ}}$ when $T_{\text{reselection}} = 0$ provided that the reselection criteria is met by a margin of at least [5] dB in FR1 or [TBD] dB in FR2 for reselections based on ranking or [6] dB in FR1 or [TBD] dB in FR2 for SS-RSRP reselections based on absolute priorities or [4] dB in FR1 and [TBD] dB in FR2 for SS-RSRQ reselections based on absolute priorities.

When higher priority cells are found by the higher priority search, they shall be measured at least every $T_{\text{measure,NR}}$. If, after detecting a cell in a higher priority search, it is determined that reselection has not occurred then the UE is not required to continuously measure the detected cell to evaluate the ongoing possibility of reselection. However, the minimum measurement filtering requirements specified later in this section shall still be met by the UE before it makes any determination that it may stop measuring the cell.

If the UE detects on an inter-RAT NR carrier a cell whose physical identity is indicated as not allowed for that carrier in the measurement control system information of the serving cell, the UE is not required to perform measurements on that cell.

The UE shall not consider an inter-RAT NR cell in cell reselection, if it is indicated as not allowed in the measurement control system information of the serving cell.

Cells which have been detected shall be measured at least every $(N_{\text{NR_carrier}}) * T_{\text{measureNR}}$ when $S_{\text{rxlev}} \leq S_{\text{nonIntraSearchP}}$ or $S_{\text{qual}} \leq S_{\text{nonIntraSearchQ}}$.

For a cell that has been already detected, but that has not been reselected to, the filtering shall be such that the UE shall be capable of evaluating that an already identified inter-RAT NR cell has met reselection criterion defined in TS 36.304 [1] within $(N_{\text{NR_carrier}}) * T_{\text{evaluateNR}}$ when $T_{\text{reselection}} = 0$ as specified in Table 4.2.2.5.6-1 provided that the reselection criteria is met by a margin of at least 5 dB in FR1 or [TBD] dB in FR2 for reselections based on ranking or 6 dB in FR1 or [TBD] dB in FR2 for SS-RSRP reselections based on absolute priorities or 4dB in FR1 and [TBD] in FR2 for SS-RSRQ reselections based on absolute priorities.

If $T_{\text{reselection}}$ timer has a non zero value and the inter-RAT NR cell is satisfied with the reselection criteria which are defined in TS 36.304 [1], the UE shall evaluate this NR cell for the $T_{\text{reselection}}$ time. If this cell remains satisfied with the reselection criteria within this duration, then the UE shall reselect that cell.

Table 4.2.2.5.6-1: $T_{\text{detect,NR}}$, $T_{\text{measureNR}}$, and $T_{\text{evaluate,NR}}$

DRX cycle length [s]	Scaling Factor (N1)		$T_{\text{detect,NR}}$ [s] (number of DRX cycles)	$T_{\text{measure,NR}}$ [s] (number of DRX cycles)	$T_{\text{evaluate,NR}}$ [s] (number of DRX cycles)
	FR1	FR2 ^{Note1}			
0.32	1	8	$11.52 \times 1.5 \times N1$ ($36 \times 1.5 \times N1$)	$1.28 \times 1.5 \times N1$ ($4 \times 1.5 \times N1$)	$5.12 \times 1.5 \times N1$ ($16 \times 1.5 \times N1$)
0.64		5	$17.92 \times N1$ ($28 \times N1$)	$1.28 \times N1$ ($2 \times N1$)	$5.12 \times N1$ ($8 \times N1$)
1.28		4	$32 \times N1$ ($25 \times N1$)	$1.28 \times N1$ ($1 \times N1$)	$6.4 \times N1$ ($5 \times N1$)
2.56		3	$58.88 \times N1$ ($23 \times N1$)	$2.56 \times N1$ ($1 \times N1$)	$7.68 \times N1$ ($3 \times N1$)
NOTE 1: Applies for UE supporting power class 2&3&4. For UE supporting power class 1, N1 = 8 for all DRX cycle length.					

6.2.3.9.3 Test description

6.2.3.9.3.1 Pre-test conditions

System Simulator:

- 2 NR Cells: NR Cell 1 and 2 as specified in TS 38.508-1 [4] table 4.4.2-3.
- System information combination NR-6 as defined in TS 38.508-1 [4] Table 4.4.3.1.2-1 is used in NR cells.
- E-UTRA Cell 1 as specified in TS 36.508-1 [7] table 4.4.2-2.
- System information combination 31 as defined in TS 36.508 [7] Table 4.4.3.1.1-1 is used in E-UTRA cell.

UE:

- None.

Preamble:

- With E-UTRA Cell 1 "Serving cell" and NR Cell 2 "Non-suitable "Off" cell" in accordance with TS 38.508-1 [4], Table 6.2.2.1-3, the UE is brought to state RRC_IDLE Connectivity (E) in accordance with the procedure described in TS 38.508-1 [4], Table 4.5.2.2-1. 4G GUTI and eKSI are assigned and security context established
- the UE is switched-off
- With E-UTRA Cell 1 "Non-suitable "Off" cell" and NGC Cell2 "Serving cell" in accordance with TS 38.508-1 [4], Table 6.2.2.1-3, the UE is brought to state 1N-A, RRC_IDLE Connectivity (NR), in accordance with the procedure described in TS 38.508-1 [4], Table 4.5.2.2-2. 5G-GUTI and ngKSI are assigned and security context established.

6.2.3.9.3.2 Test procedure sequence

Table 6.2.3.9.3.2-1/2 illustrates the downlink power levels and other changing parameters to be applied for the NR cells at various time instants of the test execution. The exact instants on which these values shall be applied are described in the texts in this clause. The configuration "T1" indicates the initial conditions. Subsequent configurations marked "T2", "T3" and "T4" are applied at the points indicated in the Main behaviour description in Table 6.2.3.9.3.2-3.

Table 6.2.3.9.3.2-1: Time instances of cell power level and parameter changes for FR1

	Parameter	Unit	NR Cell 1	NR Cell 2	E-UTRA Cell 1	Remark
T1	Cell-specific RS EPRE	dBm/15kHz	-	-	-98	The power level values are assigned to ensure the UE registered on NR Cell 2.
	SS/PBCH SSS EPRE	dBm/SCS	-98	-84	-	
T2	Cell-specific RS EPRE	dBm/15kHz	-	-	-84	E-UTRA Cell 1 becomes the highest ranked cell.
	SS/PBCH SSS EPRE	dBm/SCS	-115	-106	-	
T3	Cell-specific RS EPRE	dBm/15kHz	-	-	-98	NR Cell 1 becomes the highest ranked cell.
	SS/PBCH SSS EPRE	dBm/SCS	-84	-98	-	
T4	Cell-specific RS EPRE	dBm/15kHz	-	-	-84	E-UTRA Cell 1 becomes the highest ranked cell.
	SS/PBCH SSS EPRE	dBm/SCS	-115	-106	-	
Note 1: Power level "Off" of NR cell is defined in TS 38.508-1 [4] Table 6.2.2.1-3.						
Note 2: Power level "Off" of E-UTRA cell is defined in TS 36.508 [7] Table 6.2.2.1-3.						

Table 6.2.3.9.3.2-2: Time instances of cell power level and parameter changes for FR2

	Parameter	Unit	NR Cell 1	NR Cell 2	E-UTRA Cell 1	Remark
T1	Cell-specific RS EPRE	dBm/15kHz	-	-	FFS	The power level values are assigned to ensure the UE registered on NR Cell 2.
	SS/PBCH SSS EPRE	dBm/SCS	FFS	FFS	-	
T2	Cell-specific RS EPRE	dBm/15kHz	-	-	FFS	E-UTRA Cell 1 becomes the highest ranked cell.
	SS/PBCH SSS EPRE	dBm/SCS	FFS	FFS	-	
T3	Cell-specific RS EPRE	dBm/15kHz	-	-	FFS	NR Cell 1 becomes the highest ranked cell.
	SS/PBCH SSS EPRE	dBm/SCS	FFS	FFS	-	
T4	Cell-specific RS EPRE	dBm/15kHz	-	-	FFS	E-UTRA Cell 1 becomes the highest ranked cell.
	SS/PBCH SSS EPRE	dBm/SCS	FFS	FFS	-	
Note 1: The uncertain downlink signal level is specified in TS 38.508-1 [4] section FFS.						

Table 6.2.3.9.3.2-3: Main behaviour

St	Procedure	Message Sequence		TP	Verdict
		U - S	Message		
1-2	Void	-	-	-	-
3	The SS changes the power level setting according to the row "T2" in table 6.2.3.9.3.2-1 for FR1 and table 6.2.3.9.3.2-2 for FR2.	-	-	-	-
4	Wait for 40s for the UE to perform cell reselection procedure. (Note 1, Note 3)	-	-	-	-
5	The SS changes the power level setting according to the row "T3" in table 6.2.3.9.3.2-1 for FR1 and table 6.2.3.9.3.2-2 for FR2.	-	-	-	-
6	Wait for 41s for FR1 or 137s for FR2 for the UE to perform cell reselection procedure. (Note 2, Note 4)	-	-	-	-
7	The SS changes the TAC of NR Cell 2 to 2 according to table 6.2.3.9.3.3-2 and waits for 6 s to ensure that SIB1 is modified.	-	-	-	-
8	The SS changes the power level setting according to the row "T1" in table 6.2.3.9.3.2-1 for FR1 and table 6.2.3.9.3.2-2 for FR2.	-	-	-	-
9-14	Steps 1 to 6 of the mobility registration updating procedure described in TS 38.508-1 [4] Table 4.9.5.2.2-1 are performed on NR Cell 2. (Note 5)	-	-	-	-
15	The SS changes the power level setting according to the row "T4" in table 6.2.3.9.3.2-1 for FR1 and table 6.2.3.9.3.2-2 for FR2.	-	-	-	-
16	Check: Does the UE transmit an <i>RRCCoNNECTIONRequest</i> message on E-UTRA cell 1 within 2s? (Note 6)	-->	E-UTRAN RRC: <i>RRCCoNNECTIONRequest</i>	1	F
17	Check: Does the UE send an <i>RRCCoNNECTIONRequest</i> on E-UTRA Cell 1 within 33s for after step 16? (Note 7)	-->	E-UTRAN RRC: <i>RRCCoNNECTIONRequest</i>	1	P
18-22	Steps 2 to 6 of the generic test procedure in TS 38.508-1 [4] Table 4.9.7.2.2-1 are performed on E-UTRA cell 1.	-	-	-	-
<p>Note 1: NCR (number of cell reselection) is 1.</p> <p>Note 2: NCR is 2.</p> <p>Note 3: The wait time for reselection to a newly detected Inter-RAT E-UTRA cell is selected to cover $T_{\text{detect, EUTRAN}} (32\text{s}) + T_{\text{reselection}} (7\text{s}) + 640 \text{ ms system information blocks scheduling} = 39.64\text{s}$ rounded up to 40s.</p> <p>Note 4: The wait time for reselection to a newly detected Inter-RAT NR cell is selected to cover $T_{\text{detect, NR}} (32\text{s for FR1 and } 4 \times 32\text{s} = 128\text{s for FR2}) + T_{\text{reselection}} (7\text{s}) + 1280 \text{ ms system information block type scheduling} = 40.28\text{s}$ rounded up to 41s for FR1 and 136.28s rounded up to 137s for FR2.</p> <p>Note 5: NCR is 3 and the UE enters high mobility state because number of cell reselections during time period T_{CRmax} is greater than NCR_H.</p> <p>Note 6: The wait time for evaluating an inter-RAT cell is $T_{\text{reselection after scaling}} (2\text{s})$.</p> <p>Note 7: The wait time for cell reselection procedure is selected to cover $T_{\text{detect, EUTRAN}} (32\text{s}) + T_{\text{reselection after scaling}} (7\text{s} \times 0.25) + 640 \text{ ms system information blocks scheduling} = 34.39\text{s}$ rounded up to 35s. The actual wait time is 33s which covers 35s - 2s (wait time in step 16).</p>					

6.2.3.9.3.3 Specific message contents

Table 6.2.3.9.3.3-1: SIB2 for NR Cell 1 and NR Cell 2 (preamble and all steps, Table 6.2.3.9.3.2-3)

Derivation Path: TS 38.508-1 [4], Table 4.6.2-1			
Information Element	Value/remark	Comment	Condition
SIB2 ::= SEQUENCE {			
cellReselectionInfoCommon SEQUENCE {			
speedStateReselectionPars			
SEQUENCE {			
MobilityStateParameters SEQUENCE {			
t-Evaluation	s240		
t-HystNormal	s240		
n-CellChangeMedium	2		
n-CellChangeHigh	2		
}			
}			
q-HystSF SEQUENCE {			
sf-Medium	dB0		
sf-High	dB0		
}			
}			
cellReselectionServingFreqInfo			NR Cell 2
SEQUENCE {			
threshServingLowP	5	10dB	
}			
intraFreqCellReselectionInfo SEQUENCE {			
t-ReselectionNR	7		
}			
}			

Table 6.2.3.9.3.3-2: SIB1 for NR Cell 2 (step 7, Table 6.2.3.9.3.2-3)

Derivation Path: TS 38.508-1 [4], Table 4.6.1-28			
Information Element	Value/remark	Comment	Condition
SIB1 ::= SEQUENCE {			
cellAccessRelatedInfo SEQUENCE {			
PLMN-IdentityInfoList SEQUENCE {			
trackingAreaCode	2		
}			
}			
}			

Table 6.2.3.9.3.3-3: SIB5 for NR Cell 2 (preamble and all steps, Table 6.2.3.9.3.2-3)

Derivation Path: TS 38.508-1 [4], Table 4.6.2-4			
Information Element	Value/remark	Comment	Condition
SIB5 ::= SEQUENCE {			
carrierFreqListEUTRA SEQUENCE (SIZE (1..maxEUTRA-Carrier)) OF CarrierFreqEUTRA {	1 entry		
CarrierFreqEUTRA[1] SEQUENCE {		entry 1	
carrierFreq	Same downlink ARFCN as used for E-UTRA Cell 1		
}			
}			
t-ReselectionEUTRA	7		
t-ReselectionEUTRA-SF SEQUENCE {			
sf-Medium	oDot25		
sf-High	oDot25		
}			
}			

Table 6.2.3.9.3.3-4: SystemInformationBlockType24 for E-UTRA Cell 1 (preamble and all steps, Table 6.2.3.9.3.2-3)

Derivation Path: TS 36.508 [7], Table 4.4.3.3-20			
Information Element	Value/remark	Comment	Condition
SystemInformationBlockType24-r15 ::= SEQUENCE {			
carrierFreqListNR-r15 SEQUENCE (SIZE (1..maxFreq)) OF CarrierFreqNR-r15 {	1 entry		
CarrierFreqNR-r15[1] SEQUENCE {		entry 1	
carrierFreq-r15	Same downlink ARFCN as used for NR Cell 1		
cellReselectionPriority-r15	5		
threshX-High-r15	5	10dB	
}			
}			
t-ReselectionNR-r15	7		
}			

Table 6.2.3.9.3.3-5: REGISTRATION REQUEST (Step 6, Table 6.2.3.9.3.2-3)

Derivation Path: TS 38.508-1 [4], Table 4.7.1-6.			
Information Element	Value/remark	Comment	Condition
EPS NAS message container	TRACKING AREA UPDATE REQUEST message	See Table 6.2.3.9.3.3-6	

Table 6.2.3.9.3.3-6: TRACKING AREA UPDATE REQUEST (Table 6.2.3.9.3.3-5)

Derivation Path: TS 38.508-1 [4], Table 4.9.9.2.3-2 with condition Mapped EPS security context
--

6.2.3.10 Inter-RAT cell reselection / From E-UTRA_Idle to NR RRC_IDLE / schedulingInfoList-v12j0

6.2.3.10.1 Test Purpose (TP)

(1)

with { the UE is in E-UTRA IDLE state and *SystemInformationBlockType24* scheduled by optional extended field *schedulingInfoList-v12j0* in *SystemInformationBlockType1* is broadcasted }
ensure that {

```

when { UE detects higher priority NR cell as candidate for reselection }
then { UE reselects the NR cell }

```

6.2.3.10.2 Conformance requirements

References: The conformance requirements covered in the current TC are specified in: TS 36.331, clause 5.2.3 and 5.2.3a and TS 36.304, clause 5.2.4.1, 5.2.4.2 and 5.2.4.5. Unless otherwise stated these are Rel-15 requirements.

[TS 36.331, clause 5.2.3]

When acquiring an SI message, the UE shall:

- 1> determine the start of the SI-window for the concerned SI message as follows:
 - 2> if the concerned SI message is configured in the *schedulingInfoList*, *schedulingInfoListExt* (if present) or if the concerned SI message is configured in the *pos-schedulingInfoList* and *si-posOffset* is not configured;
 - 3> for the concerned SI message, determine the number n which corresponds to the order of entry in the concatenated list of SI messages configured by *schedulingInfoList*, *schedulingInfoListExt* (if present) and *posSchedulingInfoList* in *SystemInformationBlockType1*;
 - 3> determine the integer value $x = (n - 1) * w$, where w is the *si-WindowLength*;
 - 3> the SI-window starts at the subframe $\#a$, where $a = x \bmod 10$, in the radio frame for which $\text{SFN} \bmod T = \text{FLOOR}(x/10)$, where T is the *si-Periodicity* of the concerned SI message;
- 2> else if the concerned SI message is configured by the *posSchedulingInfoList* and *si-posOffset* is configured determine the start of the SI-window for the concerned SI message as follows:
 - 3> determine the number m which corresponds to the number of SI messages with an associated *si-Periodicity* of 8 radio frames (80 ms), configured by *schedulingInfoList* and *schedulingInfoListExt* (if present) in *SystemInformationBlockType1*;
 - 3> for the concerned SI message, determine the number n which corresponds to the order of entry in the list of SI messages configured by *posSchedulingInfoList* in *SystemInformationBlockType1*;
 - 3> determine the integer value $x = m * w + (n - 1) * w$, where w is the *si-WindowLength*
 - 3> the SI-window starts at the subframe $\#a$, where $a = x \bmod 10$, in the radio frame for which $\text{SFN} \bmod T = \text{FLOOR}(x/10) + 8$, where T is the *si-posPeriodicity* of the concerned SI message;

NOTE: E-UTRAN should configure an SI-window of 1 ms only if all SIs are scheduled before subframe $\#5$ in radio frames for which $\text{SFN} \bmod 2 = 0$.

- 1> receive DL-SCH using the SI-RNTI from the start of the SI-window and continue until the end of the SI-window whose absolute length in time is given by *si-WindowLength*, or until the SI message was received, excluding the following subframes:
 - 2> subframe $\#5$ in radio frames for which $\text{SFN} \bmod 2 = 0$;
 - 2> any MBSFN subframes;
 - 2> any uplink subframes in TDD;
- 1> if the SI message was not received by the end of the SI-window, repeat reception at the next SI-window occasion for the concerned SI message;

[TS 36.331, clause 5.2.3a]

When acquiring an SI message, the BL UE or UE in CE or NB-IoT UE shall:

- 1> determine the start of the SI-window for the concerned SI message as follows:
 - 2> if the concerned SI message is configured in the *schedulingInfoList*, *schedulingInfoListExt* (if present) or if the concerned SI message is configured in the *pos-schedulingInfoList* and *si-posOffset* is not configured;

- 3> for the concerned SI message, determine the number n which corresponds to the order of entry in the concatenated list of SI messages configured by *schedulingInfoList*, *schedulingInfoListExt* (if present) in *SystemInformationBlockType1-BR* (or *SystemInformationBlockType1-NB* in NB-IoT) and *posSchedulingInfoList* in *SystemInformationBlockType1-BR*;
- 3> determine the integer value $x = (n - 1) * w$, where w is the *si-WindowLength-BR* (or *si-WindowLength* in NB-IoT);
- 2> else if the concerned SI message is configured by the *posSchedulingInfoList* and *si-posOffset* is configured determine the start of the SI-window for the concerned SI message as follows:
 - 3> determine the number m which corresponds to the number of SI messages with an associated *si-Periodicity* of 8 radio frames (80 ms), configured by *schedulingInfoList* and *schedulingInfoListExt* (if present) in *SystemInformationBlockType1-BR*;
 - 3> for the concerned SI message, determine the number n which corresponds to the order of entry in the list of SI messages configured by *posSchedulingInfoList* in *SystemInformationBlockType1-BR*;
 - 3> determine the integer value $x = m * w + (n - 1) * w$, where w is the *si-WindowLength-BR*;
 - 3> the SI-window starts at the subframe $\#a$, where $a = x \bmod 10$, in the radio frame for which $\text{SFN} \bmod T = \text{FLOOR}(x/10) + 8$, where T is the *si-posPeriodicity* of the concerned SI message;
- 2> if the UE is a NB-IoT UE:
 - 3> the SI-window starts at the subframe $\#0$ in the radio frame for which $(\text{H-SFN} * 1024 + \text{SFN}) \bmod T = \text{FLOOR}(x/10) + \text{Offset}$, where T is the *si-Periodicity* of the concerned SI message and, *Offset* is the offset of the start of the SI-Window (*si-RadioFrameOffset*);
- 2> else:
 - 3> the SI-window starts at the subframe $\#0$ in the radio frame for which $\text{SFN} \bmod T = \text{FLOOR}(x/10)$, where T is the *si-Periodicity* of the concerned SI message;
- 1> if the UE is a NB-IoT UE:
 - 2> receive and accumulate SI message transmissions on DL-SCH from the start of the SI-window and continue until the end of the SI-window whose absolute length in time is given by *si-WindowLength*, starting from the radio frames as provided in *si-RepetitionPattern* and in subframes as provided in *downlinkBitmap*, or until successful decoding of the accumulated SI message transmissions excluding the subframes used for transmission of NPSS, NSSS, *MasterInformationBlock-NB/ MasterInformationBlock-TDD-NB* and *SystemInformationBlockType1-NB*. If there are not enough subframes for one SI message transmission in the radio frames as provided in *si-RepetitionPattern*, the UE shall continue to receive the SI message transmission in the radio frames following the radio frame indicated in *si-RepetitionPattern*;
- 1> else:
 - 2> receive and accumulate SI message transmissions on DL-SCH on narrowband provided by *si-Narrowband*, from the start of the SI-window and continue until the end of the SI-window whose absolute length in time is given by *si-WindowLength-BR*, only in radio frames as provided in *si-RepetitionPattern* and subframes as provided in *fdd-DownlinkOrTddSubframeBitmapBR* in *bandwidthReducedAccessRelatedInfo*, or until successful decoding of the accumulated SI message transmissions;
 - 1> if the SI message was not possible to decode from the accumulated SI message transmissions by the end of the SI-window, continue reception and accumulation of SI message transmissions on DL-SCH in the next SI-window occasion for the concerned SI message;

[TS 36.304, clause 5.2.4.1]

Absolute priorities of different E-UTRAN frequencies or inter-RAT frequencies may be provided to the UE in the system information, in the *RRConnectionRelease* message, or by inheriting from another RAT at inter-RAT cell (re)selection. In the case of system information, an E-UTRAN frequency or inter-RAT frequency may be listed without providing a priority (i.e. the field *cellReselectionPriority* is absent for that frequency). If priorities are provided in dedicated signalling, the UE shall ignore all the priorities provided in system information. If UE is in *camped on any cell* state, UE shall only apply the priorities provided by system information from current cell, and the UE preserves

priorities provided by dedicated signalling and *deprioritisationReq* received in *RRCCConnectionReject* unless specified otherwise. When the UE in *camped normally* state, has only dedicated priorities other than for the current frequency, the UE shall consider the current frequency to be the lowest priority frequency (i.e. lower than any of the network configured values). While the UE is camped on a suitable CSG cell in normal coverage, the UE shall always consider the current frequency to be the highest priority frequency (i.e. higher than any of the network configured values), irrespective of any other priority value allocated to this frequency. When the HSDN capable UE is in High-mobility state, the UE shall always consider the HSDN cells to be the highest priority (i.e. higher than any other network configured priorities). When the HSDN capable UE is not in High-mobility state, the UE shall always consider HSDN cells to be the lowest priority (i.e. lower than network configured priorities). If the UE capable of sidelink communication is configured to perform sidelink communication and can only perform the sidelink communication while camping on a frequency, the UE may consider that frequency to be the highest priority. If the UE capable of V2X sidelink communication is configured to perform V2X sidelink communication and can only perform the V2X sidelink communication while camping on a frequency, the UE may consider that frequency to be the highest priority. If the UE capable of V2X sidelink communication is configured to perform V2X sidelink communication and can only use pre-configuration while not camping on a frequency, the UE may consider the frequency providing inter-carrier V2X sidelink configuration to be the highest priority. If the UE capable of sidelink discovery is configured to perform Public Safety related sidelink discovery and can only perform the Public Safety related sidelink discovery while camping on a frequency, the UE may consider that frequency to be the highest priority.

NOTE 1: The prioritization among the frequencies which UE considers to be the highest priority frequency is left to UE implementation.

If the UE is capable either of MBMS Service Continuity or of SC-PTM reception and is receiving or interested to receive an MBMS service and can only receive this MBMS service while camping on a frequency on which it is provided, the UE may consider that frequency to be the highest priority during the MBMS session TS 36.300 [2] as long as the two following conditions are fulfilled:

1) Either:

- the UE is capable of MBMS service continuity and the reselected cell is broadcasting SIB13; or
- the UE is capable of SC-PTM reception and the reselected cell is broadcasting SIB20;

2) Either:

- SIB15 of the serving cell indicates for that frequency one or more MBMS SAIs included and associated with that frequency in the MBMS User Service Description (USD) TS 26.346 [22] of this service; or
- SIB15 is not broadcast in the serving cell and that frequency is included in the USD of this service.

If the UE is capable either of MBMS Service Continuity or of SC-PTM reception and is receiving or interested to receive an MBMS service provided on a downlink only MBMS frequency, on a frequency used by dedicated MBMS cells, on a frequency used by FeMBMS/Unicast-mixed cells as defined in TS 36.300 [2], or on a frequency belonging to PLMN different from its registered PLMN, the UE may consider cell reselection candidate frequencies at which it cannot receive the MBMS service to be of the lowest priority during the MBMS session TS 36.300 [2], as long as the above mentioned condition 1) is fulfilled for the cell on the MBMS frequency which the UE monitors or this cell broadcasts SIB1-MBMS and as long as the above mentioned condition 2) is fulfilled for the serving cell.

NOTE 2: Example scenarios in which the previous down-prioritisation may be needed concerns the cases where camping is not possible, while the UE can only receive this MBMS frequency when camping on a subset of cell reselection candidate frequencies, e.g. the MBMS frequency is a downlink only carrier, the MBMS frequency is used by dedicated MBMS cells, the MBMS frequency is used by FeMBMS/Unicast-mixed cells TS 36.300 [2], or the MBMS frequency belongs to a PLMN different from UE's registered PLMN.

If the UE is not capable of MBMS Service Continuity but has knowledge on which frequency an MBMS service of interest is provided, it may consider that frequency to be the highest priority during the MBMS session TS 36.300 [2] as long as the reselected cell is broadcasting SIB13.

If the UE is not capable of MBMS Service Continuity but has knowledge on which downlink only frequency, on which frequency used by dedicated MBMS cells, on which frequency used by FeMBMS/Unicast-mixed cells as defined in TS 36.300 [2] or on which frequency belonging to PLMN different from its registered PLMN an MBMS service of interest is provided, it may consider cell reselection candidate frequencies at which it cannot receive the MBMS service to be of the lowest priority during the MBMS session TS 36.300 [2] as long as the cell on the MBMS frequency which the UE monitors is broadcasting SIB13 or SIB1-MBMS.

NOTE 3: The UE considers that the MBMS session is ongoing using the session start and end times as provided by upper layers in the USD i.e. the UE does not verify if the session is indicated on MCCH.

In case UE receives *RRConnectionReject* with *deprioritisationReq*, UE shall consider current carrier frequency and stored frequencies due to the previously received *RRConnectionReject* with *deprioritisationReq* or all the frequencies of EUTRA to be the lowest priority frequency (i.e. lower than any of the network configured values) while T325 is running irrespective of camped RAT. The UE shall delete the stored deprioritisation request(s) when a PLMN selection is performed on request by NAS TS 23.122 [5].

NOTE 4: Connecting to CDMA2000 does not imply PLMN selection.

NOTE 5: UE should search for a higher priority layer for cell reselection as soon as possible after the change of priority. The minimum related performance requirements specified in TS 36.133 [10] are still applicable.

The UE shall delete priorities provided by dedicated signalling when:

- the UE enters a different RRC state; or
- the optional validity time of dedicated priorities (T320) expires; or
- a PLMN selection is performed on request by NAS TS 23.122 [5].

NOTE 6: Equal priorities between RATs are not supported.

The UE shall only perform cell reselection evaluation for E-UTRAN frequencies and inter-RAT frequencies that are given in system information and for which the UE has a priority provided.

The UE shall not consider any black listed cells as candidate for cell reselection.

The UE shall inherit the priorities provided by dedicated signalling and the remaining validity time (i.e., T320 in E-UTRA and NR, T322 in UTRA and T3230 in GERAN), if configured, at inter-RAT cell (re)selection.

NOTE 7: The network may assign dedicated cell reselection priorities for frequencies not configured by system information.

While T360 is running, redistribution target is considered to be the highest priority (i.e. higher than any of the network configured values). UE shall continue to consider the serving frequency as the highest priority until completion of E-UTRAN Inter-frequency Redistribution procedure specified in 5.2.4.10 if triggered on T360 expiry/ stop.

[TS 36.304, clause 5.2.4.2]

For NB-IoT measurement rules for cell re-selection is defined in sub-clause 5.2.4.2.a.

When evaluating S_{rxlev} and S_{qual} of non-serving cells for reselection purposes, the UE shall use parameters provided by the serving cell.

Following rules are used by the UE to limit needed measurements:

- If the serving cell fulfils $S_{rxlev} > S_{IntraSearchP}$ and $S_{qual} > S_{IntraSearchQ}$, the UE may choose not to perform intra-frequency measurements.
- Otherwise, the UE shall perform intra-frequency measurements.
- The UE shall apply the following rules for E-UTRAN inter-frequencies and inter-RAT frequencies which are indicated in system information and for which the UE has priority provided as defined in 5.2.4.1:
 - For an E-UTRAN inter-frequency or inter-RAT frequency with a reselection priority higher than the reselection priority of the current E-UTRA frequency the UE shall perform measurements of higher priority E-UTRAN inter-frequency or inter-RAT frequencies according to TS 36.133 [10].
 - For an E-UTRAN inter-frequency with an equal or lower reselection priority than the reselection priority of the current E-UTRA frequency and for inter-RAT frequency with lower reselection priority than the reselection priority of the current E-UTRAN frequency:
 - If the serving cell fulfils $S_{rxlev} > S_{nonIntraSearchP}$ and $S_{qual} > S_{nonIntraSearchQ}$, the UE may choose not to perform measurements of E-UTRAN inter-frequencies or inter-RAT frequency cells of equal or lower

priority unless the UE is triggered to measure an E-UTRAN inter-frequency which is configured with *redistributionInterFreqInfo*.

- Otherwise, the UE shall perform measurements of E-UTRAN inter-frequencies or inter-RAT frequency cells of equal or lower priority according to TS 36.133 [10].
- If the UE supports relaxed monitoring and *s-SearchDeltaP* is present in *SystemInformationBlockType3*, the UE may further limit the needed measurements, as specified in sub-clause 5.2.4.12.

[TS 36.304, clause 5.2.4.5]

For NB-IoT inter-frequency cell reselection shall be based on ranking as defined in sub-clause 5.2.4.6.

If *threshServingLowQ* is provided in *SystemInformationBlockType3* and more than 1 second has elapsed since the UE camped on the current serving cell, cell reselection to a cell on a higher priority E-UTRAN frequency or inter-RAT frequency than the serving frequency shall be performed if:

- A cell of a higher priority EUTRAN, NR or UTRAN FDD RAT/ frequency fulfils $S_{qual} > Thresh_{X, HighQ}$ during a time interval $T_{reselection_{RAT}}$; or
- A cell of a higher priority UTRAN TDD, GERAN or CDMA2000 RAT/ frequency fulfils $S_{rxlev} > Thresh_{X, HighP}$ during a time interval $T_{reselection_{RAT}}$.

Otherwise, cell reselection to a cell on a higher priority E-UTRAN frequency or inter-RAT frequency than the serving frequency shall be performed if:

- A cell of a higher priority RAT/ frequency fulfils $S_{rxlev} > Thresh_{X, HighP}$ during a time interval $T_{reselection_{RAT}}$; and
- More than 1 second has elapsed since the UE camped on the current serving cell.

Cell reselection to a cell on an equal priority E-UTRAN frequency shall be based on ranking for Intra-frequency cell reselection as defined in sub-clause 5.2.4.6.

If *threshServingLowQ* is provided in *SystemInformationBlockType3* and more than 1 second has elapsed since the UE camped on the current serving cell, cell reselection to a cell on a lower priority E-UTRAN frequency or inter-RAT frequency than the serving frequency shall be performed if:

- The serving cell fulfils $S_{qual} < Thresh_{Serving, LowQ}$ and a cell of a lower priority EUTRAN, NR or UTRAN FDD RAT/ frequency fulfils $S_{qual} > Thresh_{X, LowQ}$ during a time interval $T_{reselection_{RAT}}$; or
- The serving cell fulfils $S_{qual} < Thresh_{Serving, LowQ}$ and a cell of a lower priority UTRAN TDD, GERAN or CDMA2000 RAT/ frequency fulfils $S_{rxlev} > Thresh_{X, LowP}$ during a time interval $T_{reselection_{RAT}}$.

Otherwise, cell reselection to a cell on a lower priority E-UTRAN frequency or inter-RAT frequency than the serving frequency shall be performed if:

- The serving cell fulfils $S_{rxlev} < Thresh_{Serving, LowP}$ and a cell of a lower priority RAT/ frequency fulfils $S_{rxlev} > Thresh_{X, LowP}$ during a time interval $T_{reselection_{RAT}}$; and
- More than 1 second has elapsed since the UE camped on the current serving cell.

Cell reselection to a higher priority RAT/ frequency shall take precedence over a lower priority RAT/ frequency, if multiple cells of different priorities fulfil the cell reselection criteria.

The UE shall not perform cell reselection to NR or UTRAN FDD cells for which the cell selection criterion S is not fulfilled.

For cdma2000 RATs, S_{rxlev} is equal to $-FLOOR(-2 \times 10 \times \log_{10} E_c/I_o)$ in units of 0.5 dB, as defined in [18], with E_c/I_o referring to the value measured from the evaluated cell.

For cdma2000 RATs, $Thresh_{X, HighP}$ and $Thresh_{X, LowP}$ are equal to -1 times the values signalled for the corresponding parameters in the system information.

In all the above criteria the value of $T_{reselection_{RAT}}$ is scaled when the UE is in the medium or high mobility state as defined in subclause 5.2.4.3.1. If more than one cell meets the above criteria, the UE shall reselect a cell as follows:

- If the highest-priority frequency is an E-UTRAN frequency, a cell ranked as the best cell among the cells on the highest priority frequency(ies) meeting the criteria according to clause 5.2.4.6;
- If the highest-priority frequency is from another RAT, a cell ranked as the best cell among the cells on the highest priority frequency(ies) meeting the criteria of that RAT.

Cell reselection to another RAT, for which Squal based cell reselection parameters are broadcast in system information, shall be performed based on the Squal criteria if the UE supports Squal (RSRQ) based cell reselection to E-UTRAN from all the other RATs provided by system information which UE supports. Otherwise, cell reselection to another RAT shall be performed based on *Srxlev* criteria.

Cell reselection to NR, for which a cell reselection parameter, *q-RxLevMinSUL* is broadcast in system information and the UE supports SUL, shall be performed based on *Srxlev* criteria taking the parameter into account.

6.2.3.10.3 Test description

6.2.3.10.3.1 Pre-test conditions

System Simulator:

- E-UTRA Cell 1, NR Cell 1.
- System information combination 1 as defined in TS 36.508 [7] clause 4.4.3.1 is used in E-UTRA Cell 1. *SystemInformationBlockType1* is broadcasted with extended fields as specified in Table 6.2.3.10.3.3-1. And *SystemInformationBlockType24* is broadcasted according to scheduling information specified in Table 6.2.3.10.3.3-1.
- System information combination NR-1 defined in TS 38.508-1 [4] clause 4.4.3.1.3 is used in NR Cell 1.

UE:

- None.

Preamble:

- With E-UTRA Cell 1 "Non-suitable "Off" cell" and NR Cell 1 "Serving cell" in accordance with TS 38.508-1 [4], Table 6.2.2.1-3, the UE is brought to state 1N-A, RRC_IDLE Connectivity (NR), in accordance with the procedure described in TS 38.508-1 [4], Table 4.5.2.2-2. 5G-GUTI and ngKSI are assigned and security context established.
- The UE is switched-off
- With E-UTRA Cell 1 "Serving cell" and NR Cell 1 "Non-suitable "Off" cell" in accordance with TS 38.508-1 [4], Table 6.2.2.1-3, the UE is brought to state RRC_IDLE Connectivity (*E*) in accordance with the procedure described in TS 38.508-1 [4], Table 4.5.2.2-1. 4G GUTI and eKSI are assigned and security context established.

6.2.3.10.3.2 Test procedure sequence

Table 6.2.3.10.3.2-1/2 illustrate the downlink power levels and other changing parameters to be applied for the cell at various time instants of the test execution. The exact instants on which these values shall be applied are described in the texts in this clause. Row marked "T0" denotes the conditions in the preamble. Configurations marked "T1", "T2" and "T3" are applied at the points indicated in the Main behaviour description in Table 6.2.3.10.3.2-3.

Table 6.2.3.10.3.2-1: Time instances of cell power level and parameter changes for E-UTRA Cell 1 and NR Cell 1 in FR1

	Parameter	Unit	E-UTRA Cell 1	NR Cell 1	Remark
T0	Cell-specific RS EPRE	dBm/15kHz	-85	-	The power level values are assigned to ensure UE registered on E-UTRA cell 1
	SS/PBCH SSS EPRE	dBm/SCS	-	Off	

T1	Cell-specific RS EPRE	dBm/15kHz	-95	-	The power level values are assigned to satisfy both $Srxlev_{NR\ Cell\ 1} > Thresh_{x, low}$ and $Srxlev_{E-UTRA\ Cell\ 1} < Thresh_{serving, low}$
	SS/PBCH SSS EPRE	dBm/SCS	-	-80	
Note1: Power level "Off" is defined in TS 38.508-1 [4] Table 6.2.2.1-3.					

Table 6.2.3.10.3.2-2: Time instances of cell power level and parameter changes for E-UTRA Cell 1 and NR Cell 1 in FR2

	Parameter	Unit	E-UTRA Cell 1	NR Cell 1	Remark
T0	Cell-specific RS EPRE	dBm/15kHz	-82	-	The power level values are assigned to ensure UE registered on E-UTRA cell 1
	SS/PBCH SSS EPRE	dBm/SCS	-	Off	
T1	Cell-specific RS EPRE	dBm/15kHz	-98	-	The power level values are assigned to satisfy both $Srxlev_{NR\ Cell\ 1} > Thresh_{x, low}$ and $Srxlev_{E-UTRA\ Cell\ 1} < Thresh_{serving, low}$
	SS/PBCH SSS EPRE	dBm/SCS	-	-78	
Note1: Power level "Off" is defined in TS 38.508-1 [4] Table 6.2.2.1-3.					

Table 6.2.3.10.3.2-3: Main behaviour

St	Procedure	Message Sequence		TP	Verdict
		U - S	Message		
1	The SS adjusts the E-UTRAN and NR Cell power levels according to row "T1" in table 6.2.3.10.3.2-1/2.	-	-	-	-
2	Check: Does the test result of generic test procedure in TS 38.508-1 [4] Table 4.9.9.2.2-1 indicate that the UE is camped on NR Cell 1 within 34s for FR1 or 130s for FR2? (Note 1)	-	-	1	P
Note 1: The wait time for reselection to an newly detected Inter-RAT NR cell is selected to cover $T_{detect, NR}$ (32s for FR1 and $4 \cdot 32s = 128s$ for FR2) + T_{SI-NR} (1280 ms system information block type scheduling) = 33.28s rounded up to 34s for FR1 and 129.28s rounded up to 130s for FR2.					

6.2.3.10.3.3 Specific message contents

Table 6.2.3.10.3.3-1: SystemInformationBlockType1 for cell 1 (preamble and all steps, Table 6.2.3.11.3.2-3)

Derivation Path: TS 36.508 [7], Table 4.4.3.2-3			
Information Element	Value/Remark	Comment	Condition
SystemInformationBlockType1 ::= SEQUENCE {			
nonCriticalExtension SEQUENCE {			
lateNonCriticalExtension SEQUENCE {			
nonCriticalExtension SEQUENCE {			
nonCriticalExtension SEQUENCE {			
nonCriticalExtension SEQUENCE {			
nonCriticalExtension SEQUENCE {			
schedulingInfoList-v12j0 SEQUENCE (SIZE (1..maxSI-Message)) OF SEQUENCE {	2 entries	It includes the same number of entries, and listed in the same order, as in <i>schedulingInfoList</i> (without suffix).	
SchedulingInfo-v12j0[1] SEQUENCE {		entry 1	
SIB-MappingInfo-v12j0	Not present		
}			
SchedulingInfo-v12j0[2] SEQUENCE {		entry 2	
SIB-MappingInfo-v12j0 SEQUENCE (SIZE (1..maxSIB-1)) OF SIB-Type-v12j0 {	1 entry		
SIB-Type-v12j0[1]	sibType24-v1530	entry 2, SIB24 is mapped into the SI message scheduled via the second entry of <i>schedulingInfoList</i> (without suffix)	
}			
}			
}			
}			
}			
}			
}			
}			
}			

Table 6.2.3.10.3.3-2: SystemInformationBlockType3 of EUTRA Cell 1 (preamble and all steps, Table 6.2.3.10.3.2-3)

Derivation Path: TS 36.508 [7], Table 4.4.3.3-2			
Information Element	Value/remark	Comment	Condition
SystemInformationBlockType3 ::= SEQUENCE {			
cellReselectionServingFreqInfo SEQUENCE {			
threshServingLow	10	20 dB	
}			
}			

- 3> determine the integer value $x = m*w + (n - 1)*w$, where w is the *si-WindowLength*
- 3> the SI-window starts at the subframe $\#a$, where $a = x \bmod 10$, in the radio frame for which $\text{SFN} \bmod T = \text{FLOOR}(x/10) + 8$, where T is the *si-posPeriodicity* of the concerned SI message;

NOTE: E-UTRAN should configure an SI-window of 1 ms only if all SIs are scheduled before subframe #5 in radio frames for which $\text{SFN} \bmod 2 = 0$.

- 1> receive DL-SCH using the SI-RNTI from the start of the SI-window and continue until the end of the SI-window whose absolute length in time is given by *si-WindowLength*, or until the SI message was received, excluding the following subframes:
 - 2> subframe #5 in radio frames for which $\text{SFN} \bmod 2 = 0$;
 - 2> any MBSFN subframes;
 - 2> any uplink subframes in TDD;
- 1> if the SI message was not received by the end of the SI-window, repeat reception at the next SI-window occasion for the concerned SI message;

[TS 36.331, clause 5.2.3a]

When acquiring an SI message, the BL UE or UE in CE or NB-IoT UE shall:

- 1> determine the start of the SI-window for the concerned SI message as follows:
 - 2> if the concerned SI message is configured in the *schedulingInfoList*, *schedulingInfoListExt* (if present) or if the concerned SI message is configured in the *pos-schedulingInfoList* and *si-posOffset* is not configured;
 - 3> for the concerned SI message, determine the number n which corresponds to the order of entry in the concatenated list of SI messages configured by *schedulingInfoList*, *schedulingInfoListExt* (if present) in *SystemInformationBlockType1-BR* (or *SystemInformationBlockType1-NB* in NB-IoT) and *posSchedulingInfoList* in *SystemInformationBlockType1-BR*;
 - 3> determine the integer value $x = (n - 1)*w$, where w is the *si-WindowLength-BR* (or *si-WindowLength* in NB-IoT);
 - 2> else if the concerned SI message is configured by the *posSchedulingInfoList* and *si-posOffset* is configured determine the start of the SI-window for the concerned SI message as follows:
 - 3> determine the number m which corresponds to the number of SI messages with an associated *si-Periodicity* of 8 radio frames (80 ms), configured by *schedulingInfoList* and *schedulingInfoListExt* (if present) in *SystemInformationBlockType1-BR*;
 - 3> for the concerned SI message, determine the number n which corresponds to the order of entry in the list of SI messages configured by *posSchedulingInfoList* in *SystemInformationBlockType1-BR*;
 - 3> determine the integer value $x = m*w + (n - 1)*w$, where w is the *si-WindowLength-BR*;
 - 3> the SI-window starts at the subframe $\#a$, where $a = x \bmod 10$, in the radio frame for which $\text{SFN} \bmod T = \text{FLOOR}(x/10) + 8$, where T is the *si-posPeriodicity* of the concerned SI message;
 - 2> if the UE is a NB-IoT UE:
 - 3> the SI-window starts at the subframe #0 in the radio frame for which $(\text{H-SFN} * 1024 + \text{SFN}) \bmod T = \text{FLOOR}(x/10) + \text{Offset}$, where T is the *si-Periodicity* of the concerned SI message and, Offset is the offset of the start of the SI-Window (*si-RadioFrameOffset*);
 - 2> else:
 - 3> the SI-window starts at the subframe #0 in the radio frame for which $\text{SFN} \bmod T = \text{FLOOR}(x/10)$, where T is the *si-Periodicity* of the concerned SI message;
- 1> if the UE is a NB-IoT UE:

2> receive and accumulate SI message transmissions on DL-SCH from the start of the SI-window and continue until the end of the SI-window whose absolute length in time is given by *si-WindowLength*, starting from the radio frames as provided in *si-RepetitionPattern* and in subframes as provided in *downlinkBitmap*, or until successful decoding of the accumulated SI message transmissions excluding the subframes used for transmission of NPSS, NSSS, *MasterInformationBlock-NB/ MasterInformationBlock-TDD-NB* and *SystemInformationBlockType1-NB*. If there are not enough subframes for one SI message transmission in the radio frames as provided in *si-RepetitionPattern*, the UE shall continue to receive the SI message transmission in the radio frames following the radio frame indicated in *si-RepetitionPattern*;

1> else:

2> receive and accumulate SI message transmissions on DL-SCH on narrowband provided by *si-Narrowband*, from the start of the SI-window and continue until the end of the SI-window whose absolute length in time is given by *si-WindowLength-BR*, only in radio frames as provided in *si-RepetitionPattern* and subframes as provided in *fdd-DownlinkOrTddSubframeBitmapBR* in *bandwidthReducedAccessRelatedInfo*, or until successful decoding of the accumulated SI message transmissions;

1> if the SI message was not possible to decode from the accumulated SI message transmissions by the end of the SI-window, continue reception and accumulation of SI message transmissions on DL-SCH in the next SI-window occasion for the concerned SI message;

[TS 36.304, clause 5.2.4.1]

Absolute priorities of different E-UTRAN frequencies or inter-RAT frequencies may be provided to the UE in the system information, in the *RRCCConnectionRelease* message, or by inheriting from another RAT at inter-RAT cell (re)selection. In the case of system information, an E-UTRAN frequency or inter-RAT frequency may be listed without providing a priority (i.e. the field *cellReselectionPriority* is absent for that frequency). If priorities are provided in dedicated signalling, the UE shall ignore all the priorities provided in system information. If UE is in *camped on any cell* state, UE shall only apply the priorities provided by system information from current cell, and the UE preserves priorities provided by dedicated signalling and *deprioritisationReq* received in *RRCCConnectionReject* unless specified otherwise. When the UE in *camped normally* state, has only dedicated priorities other than for the current frequency, the UE shall consider the current frequency to be the lowest priority frequency (i.e. lower than any of the network configured values). While the UE is camped on a suitable CSG cell in normal coverage, the UE shall always consider the current frequency to be the highest priority frequency (i.e. higher than any of the network configured values), irrespective of any other priority value allocated to this frequency. When the HSDN capable UE is in High-mobility state, the UE shall always consider the HSDN cells to be the highest priority (i.e. higher than any other network configured priorities). When the HSDN capable UE is not in High-mobility state, the UE shall always consider HSDN cells to be the lowest priority (i.e. lower than network configured priorities). If the UE capable of sidelink communication is configured to perform sidelink communication and can only perform the sidelink communication while camping on a frequency, the UE may consider that frequency to be the highest priority. If the UE capable of V2X sidelink communication is configured to perform V2X sidelink communication and can only perform the V2X sidelink communication while camping on a frequency, the UE may consider that frequency to be the highest priority. If the UE capable of V2X sidelink communication is configured to perform V2X sidelink communication and can only use pre-configuration while not camping on a frequency, the UE may consider the frequency providing inter-carrier V2X sidelink configuration to be the highest priority. If the UE capable of sidelink discovery is configured to perform Public Safety related sidelink discovery and can only perform the Public Safety related sidelink discovery while camping on a frequency, the UE may consider that frequency to be the highest priority.

NOTE 1: The prioritization among the frequencies which UE considers to be the highest priority frequency is left to UE implementation.

If the UE is capable either of MBMS Service Continuity or of SC-PTM reception and is receiving or interested to receive an MBMS service and can only receive this MBMS service while camping on a frequency on which it is provided, the UE may consider that frequency to be the highest priority during the MBMS session TS 36.300 [2] as long as the two following conditions are fulfilled:

1) Either:

- the UE is capable of MBMS service continuity and the reselected cell is broadcasting SIB13; or
- the UE is capable of SC-PTM reception and the reselected cell is broadcasting SIB20;

2) Either:

- SIB15 of the serving cell indicates for that frequency one or more MBMS SAIs included and associated with that frequency in the MBMS User Service Description (USD) TS 26.346 [22] of this service; or
- SIB15 is not broadcast in the serving cell and that frequency is included in the USD of this service.

If the UE is capable either of MBMS Service Continuity or of SC-PTM reception and is receiving or interested to receive an MBMS service provided on a downlink only MBMS frequency, on a frequency used by dedicated MBMS cells, on a frequency used by FeMBMS/Unicast-mixed cells as defined in TS 36.300 [2], or on a frequency belonging to PLMN different from its registered PLMN, the UE may consider cell reselection candidate frequencies at which it cannot receive the MBMS service to be of the lowest priority during the MBMS session TS 36.300 [2], as long as the above mentioned condition 1) is fulfilled for the cell on the MBMS frequency which the UE monitors or this cell broadcasts SIB1-MBMS and as long as the above mentioned condition 2) is fulfilled for the serving cell.

NOTE 2: Example scenarios in which the previous down-prioritisation may be needed concerns the cases where camping is not possible, while the UE can only receive this MBMS frequency when camping on a subset of cell reselection candidate frequencies, e.g. the MBMS frequency is a downlink only carrier, the MBMS frequency is used by dedicated MBMS cells, the MBMS frequency is used by FeMBMS/Unicast-mixed cells TS 36.300 [2], or the MBMS frequency belongs to a PLMN different from UE's registered PLMN.

If the UE is not capable of MBMS Service Continuity but has knowledge on which frequency an MBMS service of interest is provided, it may consider that frequency to be the highest priority during the MBMS session TS 36.300 [2] as long as the reselected cell is broadcasting SIB13.

If the UE is not capable of MBMS Service Continuity but has knowledge on which downlink only frequency, on which frequency used by dedicated MBMS cells, on which frequency used by FeMBMS/Unicast-mixed cells as defined in TS 36.300 [2] or on which frequency belonging to PLMN different from its registered PLMN an MBMS service of interest is provided, it may consider cell reselection candidate frequencies at which it cannot receive the MBMS service to be of the lowest priority during the MBMS session TS 36.300 [2] as long as the cell on the MBMS frequency which the UE monitors is broadcasting SIB13 or SIB1-MBMS.

NOTE 3: The UE considers that the MBMS session is ongoing using the session start and end times as provided by upper layers in the USD i.e. the UE does not verify if the session is indicated on MCCH.

In case UE receives *RRConnectionReject* with *deprioritisationReq*, UE shall consider current carrier frequency and stored frequencies due to the previously received *RRConnectionReject* with *deprioritisationReq* or all the frequencies of EUTRA to be the lowest priority frequency (i.e. lower than any of the network configured values) while T325 is running irrespective of camped RAT. The UE shall delete the stored deprioritisation request(s) when a PLMN selection is performed on request by NAS TS 23.122 [5].

NOTE 4: Connecting to CDMA2000 does not imply PLMN selection.

NOTE 5: UE should search for a higher priority layer for cell reselection as soon as possible after the change of priority. The minimum related performance requirements specified in TS 36.133 [10] are still applicable.

The UE shall delete priorities provided by dedicated signalling when:

- the UE enters a different RRC state; or
- the optional validity time of dedicated priorities (T320) expires; or
- a PLMN selection is performed on request by NAS TS 23.122 [5].

NOTE 6: Equal priorities between RATs are not supported.

The UE shall only perform cell reselection evaluation for E-UTRAN frequencies and inter-RAT frequencies that are given in system information and for which the UE has a priority provided.

The UE shall not consider any black listed cells as candidate for cell reselection.

The UE shall inherit the priorities provided by dedicated signalling and the remaining validity time (i.e., T320 in E-UTRA and NR, T322 in UTRA and T3230 in GERAN), if configured, at inter-RAT cell (re)selection.

NOTE 7: The network may assign dedicated cell reselection priorities for frequencies not configured by system information.

While T360 is running, redistribution target is considered to be the highest priority (i.e. higher than any of the network configured values). UE shall continue to consider the serving frequency as the highest priority until completion of E-UTRAN Inter-frequency Redistribution procedure specified in 5.2.4.10 if triggered on T360 expiry/ stop.

[TS 36.304, clause 5.2.4.2]

For NB-IoT measurement rules for cell re-selection is defined in sub-clause 5.2.4.2.a.

When evaluating S_{rxlev} and S_{qual} of non-serving cells for reselection purposes, the UE shall use parameters provided by the serving cell.

Following rules are used by the UE to limit needed measurements:

- If the serving cell fulfils $S_{rxlev} > S_{IntraSearchP}$ and $S_{qual} > S_{IntraSearchQ}$, the UE may choose not to perform intra-frequency measurements.
- Otherwise, the UE shall perform intra-frequency measurements.
- The UE shall apply the following rules for E-UTRAN inter-frequencies and inter-RAT frequencies which are indicated in system information and for which the UE has priority provided as defined in 5.2.4.1:
 - For an E-UTRAN inter-frequency or inter-RAT frequency with a reselection priority higher than the reselection priority of the current E-UTRA frequency the UE shall perform measurements of higher priority E-UTRAN inter-frequency or inter-RAT frequencies according to TS 36.133 [10].
 - For an E-UTRAN inter-frequency with an equal or lower reselection priority than the reselection priority of the current E-UTRA frequency and for inter-RAT frequency with lower reselection priority than the reselection priority of the current E-UTRAN frequency:
 - If the serving cell fulfils $S_{rxlev} > S_{nonIntraSearchP}$ and $S_{qual} > S_{nonIntraSearchQ}$, the UE may choose not to perform measurements of E-UTRAN inter-frequencies or inter-RAT frequency cells of equal or lower priority unless the UE is triggered to measure an E-UTRAN inter-frequency which is configured with *redistributionInterFreqInfo*.
 - Otherwise, the UE shall perform measurements of E-UTRAN inter-frequencies or inter-RAT frequency cells of equal or lower priority according to TS 36.133 [10].
- If the UE supports relaxed monitoring and *s-SearchDeltaP* is present in *SystemInformationBlockType3*, the UE may further limit the needed measurements, as specified in sub-clause 5.2.4.12.

[TS 36.304, clause 5.2.4.5]

For NB-IoT inter-frequency cell reselection shall be based on ranking as defined in sub-clause 5.2.4.6.

If *threshServingLowQ* is provided in *SystemInformationBlockType3* and more than 1 second has elapsed since the UE camped on the current serving cell, cell reselection to a cell on a higher priority E-UTRAN frequency or inter-RAT frequency than the serving frequency shall be performed if:

- A cell of a higher priority EUTRAN, NR or UTRAN FDD RAT/ frequency fulfils $S_{qual} > Thresh_{X, HighQ}$ during a time interval $T_{reselection_{RAT}}$; or
- A cell of a higher priority UTRAN TDD, GERAN or CDMA2000 RAT/ frequency fulfils $S_{rxlev} > Thresh_{X, HighP}$ during a time interval $T_{reselection_{RAT}}$.

Otherwise, cell reselection to a cell on a higher priority E-UTRAN frequency or inter-RAT frequency than the serving frequency shall be performed if:

- A cell of a higher priority RAT/ frequency fulfils $S_{rxlev} > Thresh_{X, HighP}$ during a time interval $T_{reselection_{RAT}}$; and
- More than 1 second has elapsed since the UE camped on the current serving cell.

Cell reselection to a cell on an equal priority E-UTRAN frequency shall be based on ranking for Intra-frequency cell reselection as defined in sub-clause 5.2.4.6.

If *threshServingLowQ* is provided in *SystemInformationBlockType3* and more than 1 second has elapsed since the UE camped on the current serving cell, cell reselection to a cell on a lower priority E-UTRAN frequency or inter-RAT frequency than the serving frequency shall be performed if:

- The serving cell fulfils $Squal < Thresh_{Serving, LowQ}$ and a cell of a lower priority EUTRAN, NR or UTRAN FDD RAT/ frequency fulfils $Squal > Thresh_{X, LowQ}$ during a time interval $Treselection_{RAT}$; or
- The serving cell fulfils $Squal < Thresh_{Serving, LowQ}$ and a cell of a lower priority UTRAN TDD, GERAN or CDMA2000 RAT/ frequency fulfils $Srxlev > Thresh_{X, LowP}$ during a time interval $Treselection_{RAT}$.

Otherwise, cell reselection to a cell on a lower priority E-UTRAN frequency or inter-RAT frequency than the serving frequency shall be performed if:

- The serving cell fulfils $Srxlev < Thresh_{Serving, LowP}$ and a cell of a lower priority RAT/ frequency fulfils $Srxlev > Thresh_{X, LowP}$ during a time interval $Treselection_{RAT}$; and
- More than 1 second has elapsed since the UE camped on the current serving cell.

Cell reselection to a higher priority RAT/ frequency shall take precedence over a lower priority RAT/ frequency, if multiple cells of different priorities fulfil the cell reselection criteria.

The UE shall not perform cell reselection to NR or UTRAN FDD cells for which the cell selection criterion S is not fulfilled.

For cdma2000 RATs, $Srxlev$ is equal to $-FLOOR(-2 \times 10 \times \log_{10} Ec/I_0)$ in units of 0.5 dB, as defined in [18], with Ec/I_0 referring to the value measured from the evaluated cell.

For cdma2000 RATs, $Thresh_{X, HighP}$ and $Thresh_{X, LowP}$ are equal to -1 times the values signalled for the corresponding parameters in the system information.

In all the above criteria the value of $Treselection_{RAT}$ is scaled when the UE is in the medium or high mobility state as defined in subclause 5.2.4.3.1. If more than one cell meets the above criteria, the UE shall reselect a cell as follows:

- If the highest-priority frequency is an E-UTRAN frequency, a cell ranked as the best cell among the cells on the highest priority frequency(ies) meeting the criteria according to clause 5.2.4.6;
- If the highest-priority frequency is from another RAT, a cell ranked as the best cell among the cells on the highest priority frequency(ies) meeting the criteria of that RAT.

Cell reselection to another RAT, for which $Squal$ based cell reselection parameters are broadcast in system information, shall be performed based on the $Squal$ criteria if the UE supports $Squal$ (RSRQ) based cell reselection to E-UTRAN from all the other RATs provided by system information which UE supports. Otherwise, cell reselection to another RAT shall be performed based on $Srxlev$ criteria.

Cell reselection to NR, for which a cell reselection parameter, *q-RxLevMinSUL* is broadcast in system information and the UE supports SUL, shall be performed based on $Srxlev$ criteria taking the parameter into account.

6.2.3.11.3 Test description

6.2.3.11.3.1 Pre-test conditions

System Simulator:

- E-UTRA Cell 1, NR Cell 1.
- System information combination 1 as defined in TS 36.508 [7] clause 4.4.3.1 is used in E-UTRA Cell 1. *SystemInformationBlockType1* is broadcasted with extended fields as specified in Table 6.2.3.11.3.3-1. And *SystemInformationBlockType24* is broadcasted according to scheduling information specified in Table 6.2.3.11.3.3-1.
- System information combination NR-1 as defined in TS 38.508-1 [4] clause 4.4.3.1.3 is used in NR Cell 1.

UE:

- None.

Preamble:

- With E-UTRA Cell 1 "Non-suitable "Off" cell" and NR Cell 1 "Serving cell" in accordance with TS 38.508-1 [4], Table 6.2.2.1-3, the UE is brought to state 1N-A, RRC_IDLE Connectivity (NR), in accordance with the procedure described in TS 38.508-1 [4], Table 4.5.2.2-2. 5G-GUTI and ngKSI are assigned and security context established.
- the UE is switched-off
- With E-UTRA Cell 1 "Serving cell" and NR Cell 1 "Non-suitable "Off" cell" in accordance with TS 38.508-1 [4], Table 6.2.2.1-3, the UE is brought to state RRC_IDLE Connectivity (*E*) in accordance with the procedure described in TS 38.508-1 [4], Table 4.5.2.2-1. 4G GUTI and eKSI are assigned and security context established.

6.2.3.11.3.2 Test procedure sequence

Table 6.2.3.11.3.2-1/2 illustrate the downlink power levels and other changing parameters to be applied for the cell at various time instants of the test execution. The exact instants on which these values shall be applied are described in the texts in this clause. Row marked "T0" denotes the conditions in the preamble. Configurations marked "T1", "T2" and "T3" are applied at the points indicated in the Main behaviour description in Table 6.2.3.11.3.2-3.

Table 6.2.3.11.3.2-1: Time instances of cell power level and parameter changes for E-UTRA Cell 1 and NR Cell 1 in FR1

	Parameter	Unit	E-UTRA Cell 1	NR Cell 1	Remark
T0	Cell-specific RS EPRE	dBm/15kHz	-85	-	The power level values are assigned to ensure UE registered on E-UTRA cell 1
	SS/PBCH SSS EPRE	dBm/SCS	-	Off	
T1	Cell-specific RS EPRE	dBm/15kHz	-95	-	The power level values are assigned to satisfy both $Srxlev_{NR\ Cell\ 1} > Thresh_{x, low}$ and $Srxlev_{E-UTRA\ Cell\ 1} < Thresh_{serving, low}$
	SS/PBCH SSS EPRE	dBm/SCS	-	-80	
Note1: Power level "Off" is defined in TS 38.508-1 [4] Table 6.2.2.1-3.					

Table 6.2.3.11.3.2-2: Time instances of cell power level and parameter changes for E-UTRA Cell 1 and NR Cell 1 in FR2

	Parameter	Unit	E-UTRA Cell 1	NRCell 1	Remark
T0	Cell-specific RS EPRE	dBm/15kHz	-82	-	The power level values are assigned to ensure UE registered on E-UTRA cell 1
	SS/PBCH SSS EPRE	dBm/SCS	-	Off	
T1	Cell-specific RS EPRE	dBm/15kHz	-98	-	The power level values are assigned to satisfy both $Srxlev_{NR\ Cell\ 1} > Thresh_{x, low}$ and $Srxlev_{E-UTRA\ Cell\ 1} < Thresh_{serving, low}$
	SS/PBCH SSS EPRE	dBm/SCS	-	-78	
Note1: Power level "Off" is defined in TS 38.508-1 [4] Table 6.2.2.1-3.					

Table 6.2.3.11.3.2-3: Main behaviour

St	Procedure	Message Sequence		TP	Verdict
		U - S	Message		
1	The SS adjusts the E-UTRAN and NR Cell power levels according to row "T1" in table 6.2.3.11.3.2-1/2.	-	-	-	-
2	Check: Does the test result of generic test procedure in TS 38.508-1 [4] Table 4.9.9.2.2-1 indicate that the UE is camped on NR Cell 1 within 34s for FR1 or 130s for FR2? (Note 1)	-	-	1	P
Note 1: The wait time for reselection to a newly detected Inter-RAT NR cell is selected to cover $T_{\text{detect,NR}}$ (32s for FR1 and $4 \times 32\text{s} = 128\text{s}$ for FR2) + $T_{\text{SI-NR}}$ (1280 ms system information block type scheduling) = 33.28s rounded up to 34s for FR1 and 129.28s rounded up to 130s for FR2.					

6.2.3.11.3.3 Specific message contents

Table 6.2.3.11.3.3-1: SystemInformationBlockType1 for E-UTRA Cell 1 (Preamble and all steps)

Derivation Path: TS 36.508 [7], Table 4.4.3.2-3			
Information Element	Value/Remark	Comment	Condition
SystemInformationBlockType1 ::= SEQUENCE {			
nonCriticalExtension SEQUENCE {			
lateNonCriticalExtension SEQUENCE {			
nonCriticalExtension SEQUENCE {			
nonCriticalExtension SEQUENCE {			
nonCriticalExtension SEQUENCE {			
nonCriticalExtension SEQUENCE {			
nonCriticalExtension SEQUENCE {			
nonCriticalExtension SEQUENCE {			
schedulingInfoListExt-r12 SEQUENCE (SIZE (1..maxSI-Message)) OF SchedulingInfoExt-r12 {	1 entry		
SchedulingInfoExt-r12[1] SEQUENCE {		entry 1	
si-Periodicity-r12	rf64		
SIB-MappingInfo-v12j0 SEQUENCE (SIZE (1..maxSIB-1)) OF SIB-Type-v12j0 {	1 entry		
SIB-Type-v12j0[1]	sibType24-v1530	entry 1	
}			
}			
}			
}			
}			
}			
}			

Table 6.2.3.11.3.3-2: SystemInformationBlockType3 of E-UTRA Cell 1 (preamble and all steps , Table 6.2.3.11.3.2-3)

Derivation Path: TS 36.508 [7], Table 4.4.3.3-2			
Information Element	Value/remark	Comment	Condition
SystemInformationBlockType3 ::= SEQUENCE {			
cellReselectionServingFreqInfo SEQUENCE {			
threshServingLow	10	20 dB	
}			
}			

- if the UDM has not requested an acknowledgement from the UE and the ME receives a USAT REFRESH command qualifier (3GPP TS 31.111 [41]) of type "Steering of Roaming" it shall perform items a), b) and c) of the procedure for steering of roaming in subclause 4.4.6 and if the UE has a list of available and allowable PLMNs in the area and based on this list the UE determines that there is a higher priority PLMN than the currently camped chosen VPLMN and the UE is in automatic network selection mode, then the UE shall either:
 - i) release the current N1 NAS signalling connection locally and then attempt to obtain service on a higher priority PLMN as specified in subclause 4.4.3.3 by acting as if timer T that controls periodic attempts has expired. In this case, steps 8 to 11 are skipped; or
 - ii) not release the current N1 NAS signalling connection locally and skip steps 8 to 10;
- b) if the steering of roaming information contains the list of preferred PLMN/access technology combinations, the ME shall replace the highest priority entries in the "Operator Controlled PLMN Selector with Access Technology" list stored in the ME with the received list of preferred PLMN/access technology combinations. Additionally, if the UDM has not requested an acknowledgement from the UE and if the UE has a list of available and allowable PLMNs in the area and based on this list the UE determines that there is a higher priority PLMN than the currently camped chosen VPLMN and the UE is in automatic network selection mode, then the UE shall send the REGISTRATION COMPLETE message to the serving AMF without including an SOR transparent container and then either:
 - i) release the current N1 NAS signalling connection locally and then attempt to obtain service on a higher priority PLMN as specified in subclause 4.4.3.3 by acting as if timer T that controls periodic attempts has expired. In this case, steps 8 to 11 are skipped; or
 - ii) not release the current N1 NAS signalling connection locally and skip steps 8 and 10;

8) If:

- a) the UE's USIM is configured with indication that the UE is to receive the steering of roaming information due to initial registration in a VPLMN, but neither the list of preferred PLMN/access technology combinations nor the secured packet nor the HPLMN indication that 'no change of the "Operator Controlled PLMN Selector with Access Technology" list stored in the UE is needed and thus no list of preferred PLMN/access technology combinations is provided' is received in the REGISTRATION ACCEPT message, when the UE performs initial registration in a VPLMN or if the steering of roaming information is received but the security check is not successful; and
- b) the current chosen VPLMN is not contained in the list of "PLMNs where registration was aborted due to SOR", not part of "User Controlled PLMN Selector with Access Technology" list, the UE is not in manual mode of operation and the PDU session for emergency services is not pending to be activated;

then the UE shall send the REGISTRATION COMPLETE message to the serving AMF without including an SOR transparent container, release the current N1 NAS signalling connection locally, store the PLMN identity in the list of "PLMNs where registration was aborted due to SOR" and attempt to obtain service on a higher priority PLMN as specified in subclause 4.4.3.3 by acting as if timer T that controls periodic attempts has expired, with an exception that the current PLMN is considered as lowest priority, and skip steps 9 to 12;

NOTE 2: When the UE is in the manual mode of operation or the current chosen VPLMN is part of the "User Controlled PLMN Selector with Access Technology" list, the UE stays on the VPLMN.

9) The UE to the VPLMN AMF: If the UDM has requested an acknowledgement from the UE:

the UE verified that the steering of roaming information has been provided by the HPLMN in step 7, the UE sends the REGISTRATION COMPLETE message to the serving AMF with an SOR transparent container including the UE acknowledgement; and

if the steering of roaming information contained a secured packet and the security check was successful, then when the UE receives the USAT REFRESH command qualifier of type "Steering of Roaming", it performs items a), b) and c) of the procedure for steering of roaming in subclause 4.4.6.

10) The AMF to the UDM: If an SOR transparent container is received in the REGISTRATION COMPLETE message, the AMF uses the Nudm_SDM_Info service operation to provide the received SOR transparent container to the UDM. If the HPLMN decided that the UE is to acknowledge the successful security check of the

received steering of roaming information in step 4, the UDM verifies that the acknowledgement is provided by the UE as specified in 3GPP TS 33.501 [66];

11) If the UE has a list of available PLMNs in the area and based on this list the UE determines that there is a higher priority PLMN than the currently camped chosen VPLMN and the UE is in automatic network selection mode, then the UE shall attempt to obtain service on a higher priority PLMN as specified in subclause 4.4.3.3 by acting as if timer T that controls periodic attempts has expired after the release of the N1 NAS signalling connection. If the N1 NAS signaling connection is not released after implementation dependent time, the UE may locally release the N1 signaling connection except when the UE is registered for emergency services or the UE has an established emergency PDU session (see 3GPP TS 24.501 [64]); and

12) The UE deletes the list of "PLMNs where registration was aborted due to SOR".

The list of "PLMNs where registration was aborted due to SOR" is deleted when the UE is switched off or the USIM is removed.

6.3.1.1.3 Test Description

6.3.1.1.3.1 Pre-test conditions

System Simulator:

Three inter-frequency multi-PLMN NR Cells as specified in TS 38.508-1 [4] Table 4.4.2-1 are configured broadcasting PLMNs as indicated in Table 6.3.1.1.3.1-1.

The PLMNs are identified in the test by the identifiers in Table 6.3.1.1.3.1-1. The MCC and MNC values corresponding to the PLMN identifier shall understood as those specified in TS 36.523-1 [42], Table 6.0.1-1.

Table 6.3.1.1.3.1-1: PLMN identifiers

NR Cell	PLMN names
NR Cell 11	PLMN2
NR Cell 12	PLMN13
NR Cell 13	PLMN14

NR Cell 11 is set to "Serving Cell";

NR Cell 12 is set to "Serving Cell";

NR Cell 13 is set to "Serving Cell";

-System Information Combination NR-4 as defined in TS 38.508-1 [4] clause 4.4.3.1.3 is used in NR cells

UE:

- The UE is in Automatic PLMN selection mode.
- USIM configuration as defined in Table 6.4.1-10 in TS 38.508-1 [4] will be used.

Preamble:

- The UE is in Switched OFF (State 0-A) as defined in TS 38.508-1 [4] Table 4.4A.2-0.
- UE's Last Registered PLMN (RPLMN) needs to be cleared by using Registration Reject procedure as defined in TS 38.508-1 [4] Subclause 4.9.8.

6.3.1.1.4 Test procedure sequence

Table 6.3.1.1.4-1: Main behaviour

St	Procedure	Message Sequence		TP	Verdict
		U - S	Message		
1	Power on the UE	-		-	-
2-14	Steps 1 to 13 of the registration procedure described in TS 38.508-1 [4] subclause 4.5.2.2-2 are performed on NR Cell 13	-	-	-	-
15	The SS transmits an <i>DLInformationTransfer</i> message and an REGISTRATION ACCEPT message containing steering of roaming information indicating list of preferred PLMN/access technology combination provided with acknowledgment requested from the UE for successful reception	<--	NR RRC: <i>DLInformationTransfer</i> 5G MM: REGISTRATION ACCEPT	-	-
16	SS starts timer of $t_{max} = (6 \text{ minutes} + \text{cell selection time})$ (Note 1, 2 and 3)				
17	The UE transmits an <i>ULInformationTransfer</i> message and REGISTRATION COMPLETE message carrying acknowledgement of successful reception of the steering of roaming information	-->	NR RRC: <i>ULInformationTransfer</i> 5G MM: REGISTRATION COMPLETE	1	P
18a1-18a5a1	Step16-20a1 of the registration procedure described in TS 38.508-1 [4] Table 4.5.2.2-2 are performed.	-	-	-	-
19	Check: Does the UE transmits an <i>RRCSetupRequest</i> on NR Cell 11 before t_{max} expires? (Note 1, 2 and 3)	-->	NR RRC: <i>RRCSetupRequest</i>	1	P
20-21	Steps 3-4 of Table 4.5.2.2-2 of the generic procedure in TS 38.508-1 [4] are performed. (Note 4)	-	-	-	-
-	EXCEPTION: Steps 22a1 to 22b5a1 describe behaviours which depend on procedure parameters; the "lower case letter" identifies a step sequence that take place if a procedure parameter has a particular value.	-	-	-	-
22a1-22a16a1	IF 5GS registration type is set as Initial Registration in step 21, THEN steps 5 to 20a1 of the registration procedure described in TS 38.508-1 [4] Table 4.5.2.2-2 are performed on NR Cell 11.	-	-	-	-
22b1-22b2	Void	-	-	-	-
22b3-22b5a1	ELSE IF 5GS registration type is set as Mobility Registration in step 21, THEN steps 4 to 6a1 of the generic test procedure in TS 38.508-1 [4] Table 4.9.5.2.2-1 are performed on NR Cell 11.	-	-	-	-
<p>Note 1: Timer t_{max} in step 16 and 19 are derived from the high priority PLMN search timer T defined by EFHPPLMN</p> <p>Note 2: Following attempts to access the HPLMN/EHPLMN/higher priority PLMN in VPLMN is operator specific setting (Refer to TS 23.122 Rel-12). Hence, window between 120s to T+Tolerance is being used, where the high priority PLMN search timer T defined by EFHPPLMN</p> <p>Note 3: Tolerance of 5min is added to allow time for the UE to find the proper PLMN</p> <p>Note 4: The 5GS registration type shall be only set as Mobility Registration for R16 UEs according to TS 24.501 [22] subclause 5.2.3.2.5 specified in Release 16. The EXCEPTION description applies only to R15 UEs.</p>					

6.3.1.1.5 Specific message contents

Table 6.3.1.1.5-1: REGISTRATION ACCEPT for NR Cell 13 (step 15, Table 6.3.1.1.4-1)

Derivation Path: 38.508-1 Table 4.7.1-7			
Information Element	Value/remark	Comment	Condition
SOR Transparent Container	Present	The SOR transparent container carries steering of roaming information.	
SoR-MAC-I _{AUS}	Set to match the calculated SoR-MAC-I _{AUS} as the way defined in TS 33.501 A.17		
CounterSOR	Value generated as per TS 33.501 Cl 6.14.2.3		
SOR data type	0	The SOR transparent container carries steering of roaming information.	
List indication value	1	List of preferred PLMN/access technology combinations is provided	
List type	1	The list type is a PLMN ID and access technology list	
Acknowledgement (ACK) value	1	Acknowledgement requested	
PLMN ID 1	PLMN2		
Access Technology Identifier 1	NG-RAN		

Table 6.3.1.1.5-2: Void**Table 6.3.1.1.5-3: REGISTRATION COMPLETE for NR Cell 13 (step 17, Table 6.3.1.1.4-1)**

Derivation Path: 38.508-1 Table 4.7.1-8			
Information Element	Value/remark	Comment	Condition
SOR Transparent Container	Present	The SOR transparent container carries acknowledgement of successful reception of the steering of roaming information.	
SOR data type	1	The SOR transparent container carries acknowledgement of successful reception of the steering of roaming information.	

Table 6.3.1.1.5-4: Void

Table 6.3.1.1.5-5: REGISTRATION ACCEPT for NR Cell 11 (step 22a10, Table 6.3.1.1.4-1)

Derivation Path: 38.508-1 Table 4.7.1-7			
Information Element	Value/remark	Comment	Condition
SOR Transparent Container	Present	The SOR transparent container carries steering of roaming information.	
SoR-MAC-IAUS	Set to match the calculated SoR-MAC-IAUS as the way defined in TS 33.501 A.17		
CounterSOR	Value generated as per TS 33.501 Cl 6.14.2.3		
SOR data type	0	The SOR transparent container carries steering of roaming information.	
List indication value	1	List of preferred PLMN/access technology combinations is provided	
List type	1	The list type is a PLMN ID and access technology list	
Acknowledgement (ACK) value	1	Acknowledgement requested	
PLMN ID 1	PLMN2		
Access Technology Identifier 1	NG-RAN		

Table 6.3.1.1.5-6: REGISTRATION COMPLETE for NR Cell 11 (step 22a11, Table 6.3.1.1.4-1)

Derivation Path: 38.508-1 Table 4.7.1-8			
Information Element	Value/remark	Comment	Condition
SOR Transparent Container	Present	The SOR transparent container carries acknowledgement of successful reception of the steering of roaming information.	
SOR data type	1	The SOR transparent container carries acknowledgement of successful reception of the steering of roaming information.	

6.3.1.2 Steering of UE in roaming during registration/security check successful but SOR Transparent container indicates ACK has been NOT been requested

6.3.1.2.1 Test Purpose (TP)

(1)

with {UE being in automatic PLMN selection mode, current VPLMN not part of "PLMNs where registration was aborted due to SOR" List and not part of "User Controlled PLMN Selector with Access Technology" list and UE's USIM configured with indication that the UE is to receive Steering of Roaming information due to initial registration in a VPLMN}

ensure that {

when {SOR Transparent container indicates ACK has NOT been requested & List Type indicates PLMN ID and Access technology list in REGISTRATION ACCEPT and security check is successful and if the UE has a list of available and allowable PLMNs in the area and based on this list the UE determines that there is a higher priority PLMN than the currently camped chosen VPLMN}

then {the UE shall send the REGISTRATION COMPLETE message to the serving AMF without including an SOR transparent container and then either releases N1 NAS Signaling connection locally and then attempt to obtain service on a higher priority PLMN or optionally wait for network release of the NAS signalling connection and then selects higher priority PLMN}

}

6.3.1.2.2 Conformance requirements

References: The conformance requirements covered in the present TC are specified in: TS 23.122, clause C.2, TS 24.501 clause 4.4.4.2 and 5.5.1.2.4. Unless otherwise stated these are Rel-15 requirements.

[TS 23.122, clause C.2]

- 6) The VPLMN AMF to the UE: The VPLMN AMF shall transparently send the received steering of roaming information to the UE in the REGISTRATION ACCEPT message;
- 7) If the steering of roaming information is received and the security check is successful, then:
 - a) if the steering of roaming information contains a secured packet (see 3GPP TS 31.115 [67]):
 - if the UDM has not requested an acknowledgement from the UE the UE shall send the REGISTRATION COMPLETE message;
 - the ME shall upload the secured packet to the USIM using procedures in 3GPP TS 31.111 [41].

NOTE 1: How the ME handles UICC responses and failures in communication between the ME and UICC is implementation specific and out of scope of this release of the specification.

- if the UDM has not requested an acknowledgement from the UE and the ME receives a USAT REFRESH command qualifier (3GPP TS 31.111 [41]) of type "Steering of Roaming" it shall perform items a), b) and c) of the procedure for steering of roaming in subclause 4.4.6 and if the UE has a list of available and allowable PLMNs in the area and based on this list the UE determines that there is a higher priority PLMN than the currently camped chosen VPLMN and the UE is in automatic network selection mode, then the UE shall either:
 - i) release the current N1 NAS signalling connection locally and then attempt to obtain service on a higher priority PLMN as specified in subclause 4.4.3.3 by acting as if timer T that controls periodic attempts has expired. In this case, steps 8 to 11 are skipped; or
 - ii) not release the current N1 NAS signalling connection locally and skip steps 8 to 10;
- b) if the steering of roaming information contains the list of preferred PLMN/access technology combinations, the ME shall replace the highest priority entries in the "Operator Controlled PLMN Selector with Access Technology" list stored in the ME with the received list of preferred PLMN/access technology combinations. Additionally, if the UDM has not requested an acknowledgement from the UE and if the UE has a list of available and allowable PLMNs in the area and based on this list the UE determines that there is a higher priority PLMN than the currently camped chosen VPLMN and the UE is in automatic network selection mode, then the UE shall send the REGISTRATION COMPLETE message to the serving AMF without including an SOR transparent container and then either:

- i) release the current N1 NAS signalling connection locally and then attempt to obtain service on a higher priority PLMN as specified in subclause 4.4.3.3 by acting as if timer T that controls periodic attempts has expired. In this case, steps 8 to 11 are skipped; or
- ii) not release the current N1 NAS signalling connection locally and skip steps 8 and 10;

8) If:

- a) the UE's USIM is configured with indication that the UE is to receive the steering of roaming information due to initial registration in a VPLMN, but neither the list of preferred PLMN/access technology combinations nor the secured packet nor the HPLMN indication that 'no change of the "Operator Controlled PLMN Selector with Access Technology" list stored in the UE is needed and thus no list of preferred PLMN/access technology combinations is provided' is received in the REGISTRATION ACCEPT message, when the UE performs initial registration in a VPLMN or if the steering of roaming information is received but the security check is not successful; and
- b) the current chosen VPLMN is not contained in the list of "PLMNs where registration was aborted due to SOR", not part of "User Controlled PLMN Selector with Access Technology" list, the UE is not in manual mode of operation and the PDU session for emergency services is not pending to be activated;

then the UE shall send the REGISTRATION COMPLETE message to the serving AMF without including an SOR transparent container, release the current N1 NAS signalling connection locally, store the PLMN identity in the list of "PLMNs where registration was aborted due to SOR" and attempt to obtain service on a higher priority PLMN as specified in subclause 4.4.3.3 by acting as if timer T that controls periodic attempts has expired, with an exception that the current PLMN is considered as lowest priority, and skip steps 9 to 12;

NOTE 2: When the UE is in the manual mode of operation or the current chosen VPLMN is part of the "User Controlled PLMN Selector with Access Technology" list, the UE stays on the VPLMN.

9) The UE to the VPLMN AMF: If the UDM has requested an acknowledgement from the UE:

the UE verified that the steering of roaming information has been provided by the HPLMN in step 7, the UE sends the REGISTRATION COMPLETE message to the serving AMF with an SOR transparent container including the UE acknowledgement; and

if the steering of roaming information contained a secured packet and the security check was successful, then when the UE receives the USAT REFRESH command qualifier of type "Steering of Roaming", it performs items a), b) and c) of the procedure for steering of roaming in subclause 4.4.6.

10) The AMF to the UDM: If an SOR transparent container is received in the REGISTRATION COMPLETE message, the AMF uses the Nudm_SDM_Info service operation to provide the received SOR transparent container to the UDM. If the HPLMN decided that the UE is to acknowledge the successful security check of the received steering of roaming information in step 4, the UDM verifies that the acknowledgement is provided by the UE as specified in 3GPP TS 33.501 [66];

11) If the UE has a list of available PLMNs in the area and based on this list the UE determines that there is a higher priority PLMN than the currently camped chosen VPLMN and the UE is in automatic network selection mode, then the UE shall attempt to obtain service on a higher priority PLMN as specified in subclause 4.4.3.3 by acting as if timer T that controls periodic attempts has expired after the release of the N1 NAS signalling connection. If the N1 NAS signaling connection is not released after implementation dependent time, the UE may locally release the N1 signaling connection except when the UE is registered for emergency services or the UE has an established emergency PDU session (see 3GPP TS 24.501 [64]); and

12) The UE deletes the list of "PLMNs where registration was aborted due to SOR".

The list of "PLMNs where registration was aborted due to SOR" is deleted when the UE is switched off or the USIM is removed.

[TS 24.501 clause 4.4.4.2]

...

The network can provide the SOR transparent container IE during the registration procedure to the UE in the REGISTRATION ACCEPT message. The SOR transparent container IE is integrity protected by the HPLMN as specified in 3GPP TS 33.501 [24].

...

[TS 24.501 clause 5.5.1.2.4]

...

If the REGISTRATION ACCEPT message includes the SOR transparent container IE and the SOR transparent container IE successfully passes the integrity check (see 3GPP TS 33.501 [24]):

- a) the UE shall proceed with the behaviour as specified in 3GPP TS 23.122 [5] annex C; and
- b) if the registration procedure is performed over 3GPP access and the UE attempts obtaining service on another PLMNs as specified in 3GPP TS 23.122 [5] annex C, then the UE may locally release the established N1 NAS signalling connection after sending a REGISTRATION COMPLETE message. Otherwise the UE shall send a REGISTRATION COMPLETE message and not release the current N1 NAS signalling connection locally. If an acknowledgement is requested in the SOR transparent container IE of the REGISTRATION ACCEPT message, the UE acknowledgement is included in the SOR transparent container IE of the REGISTRATION COMPLETE message.

If the SOR transparent container IE successfully passes the integrity check (see 3GPP TS 33.501 [24]), indicates list of preferred PLMN/access technology combinations is provided and the list type indicates:

- a) "PLMN ID and access technology list", then the ME shall replace the highest priority entries in the "Operator Controlled PLMN Selector with Access Technology" list stored in the ME and shall proceed with the behaviour as specified in 3GPP TS 23.122 [5] annex C; or
- b) "secured packet", then the ME shall behave as if a SMS is received with protocol identifier set to SIM data download, data coding scheme set to class 2 message and SMS payload as secured packet contents of SOR transparent container IE. The SMS payload is forwarded to UICC as specified in 3GPP TS 23.040 [4A] and the ME shall proceed with the behaviour as specified in 3GPP TS 23.122 [5] annex C.

...

6.3.1.2.3 Test Description

6.3.1.2.3.1 Pre-test conditions

System Simulator:

- Three inter-frequency multi-PLMN NR Cells as specified in TS 38.508-1 [4] Table 4.4.2-1 are configured broadcasting PLMNs as indicated in Table 6.3.1.2.3.1-1.
- The PLMNs are identified in the test by the identifiers in Table 6.3.1.2.3.1-1. The MCC and MNC values corresponding to the PLMN identifier shall understood as those specified in TS 36.523-1 [42], Table 6.0.1-1.

Table 6.3.1.2.3.1-1: PLMN identifiers

NR Cell	PLMN names
NR Cell 11	PLMN2
NR Cell 12	PLMN13
NR Cell 13	PLMN14

NR Cell 11 is set to "Serving Cell";

NR Cell 12 is set to "Serving Cell";

NR Cell 13 is set to "Serving Cell";

System Information Combination NR-4 as defined in TS38.508-1 [4] clause 4.4.3.1.3 is used in NR cells.

UE:

- The UE is in Automatic PLMN selection mode.

- USIM configuration as defined in Table 6.4.1-10 in TS 38.508-1 [4] will be used.

Preamble:

- The UE is in Switched OFF (State 0-A) as defined in TS 38.508-1 [4] Table 4.4A.2-0.
- UE's Last Registered PLMN (RPLMN) needs to be cleared by using Registration Reject procedure as defined in TS 38.508-1 [4] Subclause 4.9.8.

6.3.1.2.4 Test procedure sequence

Table 6.3.1.2.4-1: Main behaviour

St	Procedure	Message Sequence		TP	Verdict
		U - S	Message		
1	Power on the UE.	-		-	-
2-14	Steps 1 to 13 of the registration procedure described in TS 38.508-1 [4] subclause 4.5.2.2-2 are performed on NR Cell 13.	-	-	-	-
15	The SS transmits an <i>DLInformationTransfer</i> message and a REGISTRATION ACCEPT message containing steering of roaming information indicating that acknowledgment is not requested from the UE for successful reception.	<-	NR RRC: <i>DLInformationTransfer</i> 5G MM: REGISTRATION ACCEPT	-	-
16	The SS also starts timer of $t_{max} = (6 \text{ minutes} + \text{cell selection time})$ (Note 1, 2 and 3)	-	-	-	-
17	The UE transmits an <i>ULInformationTransfer</i> message and REGISTRATION COMPLETE message without Steering of Roaming Transparent container.	-->	NR RRC: <i>ULInformationTransfer</i> 5G MM: REGISTRATION COMPLETE	-1	-
-	EXCEPTION: Step 18a1-18b1 describes behaviour depending UE implementation; the "lower case letter" identifies a step sequence that take place if the UE performs a specific action.	-	-	-	-
18a1-18a5a1	Steps 16-20a1 of the registration procedure described in TS 38.508-1 [4] Table 4.5.2.2-2 is performed.	-	-	-	-
18b1	The SS locally releases the RRC connection.	-	-	-	-
19	Void	-	-	-	-
20	Check: Does the UE transmits an <i>RRCSetupRequest</i> message on NR Cell 11 before t_{max} expires? (Note 1, 2 and 3)	-->	NR RRC: <i>RRCSetupRequest</i>	1	P
21	The SS transmits an <i>RRCSetup</i> message on NR Cell 11.	<-	NR RRC: <i>RRCSetup</i>	-	-
22	The UE transmits an <i>RRCSetupComplete</i> message and a REGISTRATION REQUEST message on NR Cell 11. (Note 4)	-->	NR RRC: <i>RRCSetupComplete</i> 5GMM: REGISTRATION REQUEST	-	-
-	EXCEPTION: Steps 23a1 to 23b5a1 describe behaviours which depend on procedure parameters; the "lower case letter" identifies a step sequence that take place if a procedure parameter has a particular value	-	-	-	-
23a1-23a15a1	IF 5GS registration type is set as Initial Registration in step 22, THEN steps 5 to 20a1 of the registration procedure described in TS 38.508-1 [4] Table 4.5.2.2-2 are performed on NR Cell 11.	-	-	-	-
23b1-23b2	Void	-	-	-	-
23b3-23b5a1	ELSE IF 5GS registration type is set as Mobility Registration in step 22, THEN steps 4 to 6a1 of the generic test procedure in TS 38.508-1 [4] Table 4.9.5.2.2-1 are performed on NR Cell 11.	-	-	-	-
24-26	Void	-	-	-	-

Note 1:	Timer tmax in step 16 and 20 are derived from the high priority PLMN search timer T defined by EFHPPLMN
Note 2:	Following attempts to access the HPLMN/EHPLMN/higher priority PLMN in VPLMN is operator specific setting (Refer to TS 23.122 Rel-12). Hence, window between 120s to T+Tolerance is being used, where the high priority PLMN search timer T defined by EFHPPLMN
Note 3:	Tolerance of 5min is added to allow time for the UE to find the proper PLMN
Note 4:	The 5GS registration type shall be only set as Mobility Registration for Rel-16 UEs according to TS 24.501 subclause 5.2.3.2.5 specified in Release 16. The EXCEPTION description applies only to Rel-15 UEs.

6.3.1.2.5 Specific message contents

Table 6.3.1.2.5-1: REGISTRATION ACCEPT for NR Cell 12 (step 15, Table 6.3.1.2.4-1)

Derivation Path: 38.508-1 Table 4.7.1-7			
Information Element	Value/remark	Comment	Condition
SOR Transparent Container	Present	The SOR transparent container carries steering of roaming information.	
SoR-MAC-I _{AUS}	Set to match the calculated SoR-MAC-I _{AUS} as the way defined in TS 33.501 A.17		
CounterSOR	Value generated as per TS 33.501 Cl 6.14.2.3		
SOR data type	0	The SOR transparent container carries steering of roaming information.	
List indication value	1	List of preferred PLMN/access technology combinations is provided	
List type	1	The list type is a PLMN ID and access technology list	
Acknowledgement (ACK) value	0	Acknowledgement is NOT requested	
PLMN ID 1	PLMN2		
Access Technology Identifier 1	NG-RAN		
PLMN ID 2	PLMN13		
Access Technology Identifier 2	NG-RAN		
PLMN ID 3	PLMN14		
Access Technology Identifier 3	NG-RAN		

Table 6.3.1.2.5-2: Void

Table 6.3.1.2.5-3: REGISTRATION COMPLETE for NR Cell 13 (step 17, Table 6.3.1.2.4-1)

Derivation Path: 38.508-1 Table 4.7.1-8			
Information Element	Value/remark	Comment	Condition
SOR Transparent Container	Not Present	The SOR transparent container should not be present when ACK is not requested by UDM.	

Table 6.3.1.2.5-4: REGISTRATION ACCEPT for NR Cell 11 (step 23a10, Table 6.3.1.2.4-1)

Derivation Path: 38.508-1 Table 4.7.1-7			
Information Element	Value/remark	Comment	Condition
SOR Transparent Container	Present	The SOR transparent container carries steering of roaming information.	
SoR-MAC-IAUS	Set to match the calculated SoR-MAC-IAUS as the way defined in TS 33.501 A.17		
CounterSOR	Value generated as per TS 33.501 Cl 6.14.2.3		
SOR data type	0	The SOR transparent container carries steering of roaming information.	
List indication value	1	List of preferred PLMN/access technology combinations is provided	
List type	1	The list type is a PLMN ID and access technology list	
Acknowledgement (ACK) value	0	Acknowledgement is NOT requested	
PLMN ID 1	PLMN2		
Access Technology Identifier 1	NG-RAN		
PLMN ID 2	PLMN13		
Access Technology Identifier 2	NG-RAN		
PLMN ID 3	PLMN14		
Access Technology Identifier 3	NG-RAN		

6.3.1.3 Steering of UE in roaming during registration/security check unsuccessful/Automatic mode

6.3.1.3.1 Test Purpose (TP)

(1)

with {UE being in automatic PLMN selection mode and current VPLMN not part of "PLMNs where registration was aborted due to SOR" List and not part of "User Controlled PLMN Selector with Access Technology" list and UE's USIM configured with indication that the UE is to receive Steering of Roaming information due to initial registration in a VPLMN}

```

ensure that {
  when {Security check on the steering of roaming information SOR Transparent container is
  unsuccessful}
  then {UE sends REGISTRATION COMPLETE message to the serving AMF without including an SOR
  transparent container and releases the current N1 NAS signalling connection locally and attempts to
  obtain service on a higher priority PLMN}
}

```

6.3.1.3.2 Conformance requirements

References: The conformance requirements covered in the present TC are specified in: TS 23.122, clause C.2. Unless otherwise stated these are Rel-15 requirements.

[TS 23.122, clause C.2]

- 6) The VPLMN AMF to the UE: The VPLMN AMF shall transparently send the received steering of roaming information to the UE in the REGISTRATION ACCEPT message;
- 7) If the steering of roaming information is received and the security check is successful, then:
 - a) if the steering of roaming information contains a secured packet (see 3GPP TS 31.115 [67]):
 - if the UDM has not requested an acknowledgement from the UE the UE shall send the REGISTRATION COMPLETE message;
 - the ME shall upload the secured packet to the USIM using procedures in 3GPP TS 31.111 [41];

NOTE 1: How the ME handles UICC responses and failures in communication between the ME and UICC is implementation specific and out of scope of this release of the specification.

- if the UDM has not requested an acknowledgement from the UE and the ME receives a USAT REFRESH command qualifier (3GPP TS 31.111 [41]) of type "Steering of Roaming" it shall perform items a), b) and c) of the procedure for steering of roaming in subclause 4.4.6 and if the UE has a list of available and allowable PLMNs in the area and based on this list the UE determines that there is a higher priority PLMN than the currently camped chosen VPLMN and the UE is in automatic network selection mode, then the UE shall either:
 - i) release the current N1 NAS signalling connection locally and then attempt to obtain service on a higher priority PLMN as specified in subclause 4.4.3.3 by acting as if timer T that controls periodic attempts has expired. In this case, steps 8 to 11 are skipped; or
 - ii) not release the current N1 NAS signalling connection locally and skip steps 8 to 10;
 - b) if the steering of roaming information contains the list of preferred PLMN/access technology combinations, the ME shall replace the highest priority entries in the "Operator Controlled PLMN Selector with Access Technology" list stored in the ME with the received list of preferred PLMN/access technology combinations. Additionally, if the UDM has not requested an acknowledgement from the UE and if the UE has a list of available and allowable PLMNs in the area and based on this list the UE determines that there is a higher priority PLMN than the currently camped chosen VPLMN and the UE is in automatic network selection mode, then the UE shall send the REGISTRATION COMPLETE message to the serving AMF without including an SOR transparent container and then either:
 - i) release the current N1 NAS signalling connection locally and then attempt to obtain service on a higher priority PLMN as specified in subclause 4.4.3.3 by acting as if timer T that controls periodic attempts has expired. In this case, steps 8 to 11 are skipped; or
 - ii) not release the current N1 NAS signalling connection locally and skip steps 8 to 10;
- 8) If:
 - a) the UE's USIM is configured with indication that the UE is to receive the steering of roaming information due to initial registration in a VPLMN, but neither the list of preferred PLMN/access technology combinations nor the secured packet nor the HPLMN indication that 'no change of the "Operator Controlled PLMN Selector with Access Technology" list stored in the UE is needed and thus no list of preferred PLMN/access technology combinations is provided' is received in the REGISTRATION ACCEPT message,

when the UE performs initial registration in a VPLMN or if the steering of roaming information is received but the security check is not successful; and

- b) the current chosen VPLMN is not contained in the list of "PLMNs where registration was aborted due to SOR", not part of "User Controlled PLMN Selector with Access Technology" list, the UE is not in manual mode of operation and the PDU session for emergency services is not pending to be activated;

then the UE shall send the REGISTRATION COMPLETE message to the serving AMF without including an SOR transparent container, release the current N1 NAS signalling connection locally, store the PLMN identity in the list of "PLMNs where registration was aborted due to SOR" and attempt to obtain service on a higher priority PLMN as specified in subclause 4.4.3.3 by acting as if timer T that controls periodic attempts has expired, with an exception that the current PLMN is considered as lowest priority, and skip steps 9 to 12;

NOTE 2: When the UE is in the manual mode of operation or the current chosen VPLMN is part of the "User Controlled PLMN Selector with Access Technology" list, the UE stays on the VPLMN.

- 9) The UE to the VPLMN AMF: If the UDM has requested an acknowledgement from the UE:

the UE verified that the steering of roaming information has been provided by the HPLMN in step 7, the UE sends the REGISTRATION COMPLETE message to the serving AMF with an SOR transparent container including the UE acknowledgement; and

if the steering of roaming information contained a secured packet and the security check was successful, then when the UE receives the USAT REFRESH command qualifier of type "Steering of Roaming", it performs items a), b) and c) of the procedure for steering of roaming in subclause 4.4.6.

- 10) The AMF to the UDM: If an SOR transparent container is received in the REGISTRATION COMPLETE message, the AMF uses the Nudm_SDM_Info service operation to provide the received SOR transparent container to the UDM. If the HPLMN decided that the UE is to acknowledge the successful security check of the received steering of roaming information in step 4, the UDM verifies that the acknowledgement is provided by the UE as specified in 3GPP TS 33.501 [66];

- 11) If the UE has a list of available PLMNs in the area and based on this list the UE determines that there is a higher priority PLMN than the currently camped chosen VPLMN and the UE is in automatic network selection mode, then the UE shall attempt to obtain service on a higher priority PLMN as specified in subclause 4.4.3.3 by acting as if timer T that controls periodic attempts has expired after the release of the N1 NAS signalling connection. If the N1 NAS signalling connection is not released after implementation dependent time, the UE may locally release the N1 signalling connection except when the UE is registered for emergency services or the UE has an established emergency PDU session (see 3GPP TS 24.501 [64]); and

- 12) The UE deletes the list of "PLMNs where registration was aborted due to SOR".

The list of "PLMNs where registration was aborted due to SOR" is deleted when the UE is switched off or the USIM is removed.

6.3.1.3.3 Test Description

6.3.1.3.3.1 Pre-test conditions

System Simulator:

- Three inter-frequency multi-PLMN NR Cells as specified in TS 38.508-1 [4] Table 4.4.2-1 are configured broadcasting PLMNs as indicated in Table 6.3.1.3.3.1-1.
- The PLMNs are identified in the test by the identifiers in Table 6.3.1.3.3.1-1. The MCC and MNC values corresponding to the PLMN identifier shall understood as those specified in TS 36.523-1 [42], Table 6.0.1-1.

Table 6.3.1.3.3.1-1: PLMN identifiers

NR Cell	PLMN names
NR Cell 11	PLMN2
NR Cell 12	PLMN13
NR Cell 13	PLMN14

NR Cell 11 is set to "Serving Cell";

NR Cell 12 is set to "Serving Cell";

NR Cell 13 is set to "Serving Cell";

System Information Combination NR-4 as defined in TS 38.508-1 [4] clause 4.4.3.1.3 is used in NR cells.

UE:

- The UE is in Automatic PLMN selection mode.
- USIM configuration as defined in Table 6.4.1-10 of TS 38.508-1 [4] will be used.

Preamble:

- The UE is in Switched OFF (State 0-A) as defined in TS 38.508-1 [4] Table 4.4A.2-0.
- UE's Last Registered PLMN (RPLMN) needs to be cleared by using Registration Reject procedure as defined in TS 38.508-1 [4] Subclause 4.9.8.

6.3.1.3.4 Test procedure sequence

Table 6.3.1.3.4-1: Main behaviour

St	Procedure	Message Sequence		TP	Verdict
		U - S	Message		
1	Power on the UE	-	-	-	-
2-14	Steps 1 to 13 of the registration procedure described in TS 38.508-1 [4] Table 4.5.2.2-2 are performed on NR Cell 13	-	-	-	-
15	The SS transmits a <i>DLInformationTransfer</i> message and a REGISTRATION ACCEPT message containing steering of roaming information, includes unmatched SOR-MAC-I _{AUSF} that will result in unsuccessful security check while on UE reception	<--	NR RRC: <i>DLInformationTransfer</i> 5G MM: REGISTRATION ACCEPT	-	-
16	SS starts timer of t _{max} =(6 minutes + cell selection time) (Note 1, 2 and 3)	-	-	-	-
17	The UE transmits an <i>ULInformationTransfer</i> message and REGISTRATION COMPLETE message without including an SOR transparent container	-->	NR RRC: <i>ULInformationTransfer</i> 5G MM: REGISTRATION COMPLETE	1	P
18-21a1	Void	-	-	-	-
22	The SS locally releases the RRC connection.	-	-	-	-
23	Check: Does the UE transmits an <i>RRCSetupRequest</i> message on NR Cell 12 before t _{max} expires? (Note 1, 2 and 3)	-->	NR RRC: <i>RRCSetupRequest</i>	1	P
24	The SS transmits an <i>RRCSetup</i> message on NR Cell 12.	<--	NR RRC: <i>RRCSetup</i>	-	-
25	The UE transmits an <i>RRCSetupComplete</i> message and a REGISTRATION REQUEST message on NR Cell 12. (Note 4)	-->	NR RRC: <i>RRCSetupComplete</i> 5GMM: REGISTRATION REQUEST	-	-
-	EXCEPTION: Steps 26a1 to 26b5a1 describe behaviours which depend on procedure parameters; the "lower case letter" identifies a step sequence that take place if a procedure parameter has a particular value	-	-	-	-
26a1-26a15a1	IF 5GS registration type is set as Initial Registration in step 25, THEN steps 5 to 20a1 of the registration procedure described in TS 38.508-1 [4] Table 4.5.2.2-2 are performed on NR Cell 12.	-	-	-	-
26b1-26b2	Void	-	-	-	-
26b3-26b5a1	ELSE IF 5GS registration type is set as Mobility Registration in step 25, THEN steps 4 to 6a1 of the generic test procedure in TS 38.508-1 [4] Table 4.9.5.2.2-1 are performed on NR Cell 12.	-	-	-	-
27-28a1	Void.	-	-	-	-
<p>Note 1: Timer t_{max} in step 16 and 23 are derived from the high priority PLMN search timer T defined by EF_{HPLMN}</p> <p>Note 2: Following attempts to access the HPLMN/EHPLMN/higher priority PLMN in VPLMN is operator specific setting (Refer to TS 23.122 Rel-12). Hence, window between 120s to T+Tolerance is being used , where the high priority PLMN search timer T defined by EF_{HPLMN}</p> <p>Note 3: Tolerance of 5min is added to allow time for the UE to find the proper PLMN</p> <p>Note 4: The 5GS registration type shall be only set as Mobility Registration for Rel-16 UEs according to TS 24.501 subclause 5.2.3.2.5 specified in Release 16. The EXCEPTION description applies only to Rel-15 UEs.</p>					

6.3.1.3.5 Specific message contents

Table 6.3.1.3.5-1: REGISTRATION ACCEPT for NR Cell 13 (step 15, Table 6.3.1.3.4-1)

Derivation Path: TS 38.508-1 [4] Table 4.7.1-7			
Information Element	Value/remark	Comment	Condition
SOR Transparent Container	Present	The SOR transparent container carries steering of roaming information.	
SoR-MAC-IAUS	Set to mismatch the calculated SoR-MAC-IAUS as the way defined in TS 33.501 A.17		
CounterSOR	Value generated as per TS 33.501 Cl 6.14.2.3		
SOR data type	0	The SOR transparent container carries steering of roaming information.	
List indication value	1	List of preferred PLMN/access technology combinations is provided	
List type	1	The list type is a PLMN ID and access technology list	
Acknowledgement (ACK) value	1	Acknowledgement requested	
PLMN ID 1	PLMN2		
Access Technology Identifier 1	NG-RAN		

Table 6.3.1.3.5-2: Void**Table 6.3.1.3.5-3: REGISTRATION COMPLETE for NR Cell 13 (step 17, Table 6.3.1.3.4-1)**

Derivation Path: TS 38.508-1 [4] Table 4.7.1-8			
Information Element	Value/remark	Comment	Condition
SOR Transparent Container	Not Present	The SOR transparent container is not included in REGISTRATION COMPLETE message	

Table 6.3.1.3.5-4: REGISTRATION ACCEPT for NR Cell 13 (step 26a10, Table 6.3.1.3.4-1)

Derivation Path: TS 38.508-1 [4] Table 4.7.1-7			
Information Element	Value/remark	Comment	Condition
SOR Transparent Container	Present	The SOR transparent container carries steering of roaming information.	
SoR-MAC-IAUS	Set to match the calculated SoR-MAC-IAUS as the way defined in TS 33.501 A.17		
Counter _{SOR}	Value generated as per TS 33.501 Cl 6.14.2.3		
SOR data type	0	The SOR transparent container carries steering of roaming information.	
List indication value	1	List of preferred PLMN/access technology combinations is provided	
List type	1	The list type is a PLMN ID and access technology list	
Acknowledgement (ACK) value	1	Acknowledgement requested	
PLMN ID 1	PLMN13		
Access Technology Identifier 1	NG-RAN		

Table 6.3.1.3.5-5: REGISTRATION COMPLETE for NR Cell 13 (step 26a11, Table 6.3.1.3.4-1)

Derivation Path: 38.508-1 Table 4.7.1-8			
Information Element	Value/remark	Comment	Condition
SOR Transparent Container	Present	The SOR transparent container carries acknowledgement of successful reception of the steering of roaming information.	
SOR data type	1	The SOR transparent container carries acknowledgement of successful reception of the steering of roaming information.	

6.3.1.4 Steering of UE in roaming during registration/security check unsuccessful/
Manual mode

6.3.1.4.1 Test Purpose (TP)

(1)

with {UE being in manual PLMN selection mode **and** current VPLMN not part of "PLMNs where registration was aborted due to SOR" List and not part of "User Controlled PLMN Selector with Access Technology" list **and** UE's USIM configured with indication that the UE is to receive Steering of Roaming information due to initial registration in a VPLMN}

ensure that {

when {Security check on the steering of roaming information SOR Transparent container is unsuccessful}

then {UE sends REGISTRATION COMPLETE message to the serving AMF without including an SOR transparent container **and** stays on this VPLMN}

}

6.3.1.4.2 Conformance requirements

References: The conformance requirements covered in the present TC are specified in: TS 23.122, clause C.2. Unless otherwise stated these are Rel-15 requirements.

[TS 23.122, clause C.2]

- 6) The VPLMN AMF to the UE: The VPLMN AMF shall transparently send the received steering of roaming information to the UE in the REGISTRATION ACCEPT message;
- 7) If the steering of roaming information is received and the security check is successful, then:
 - a) if the steering of roaming information contains a secured packet (see 3GPP TS 31.115 [67]):
 - if the UDM has not requested an acknowledgement from the UE the UE shall send the REGISTRATION COMPLETE message;
 - the ME shall upload the secured packet to the USIM using procedures in 3GPP TS 31.111 [41];

NOTE 1: How the ME handles UICC responses and failures in communication between the ME and UICC is implementation specific and out of scope of this release of the specification.

- if the UDM has not requested an acknowledgement from the UE and the ME receives a USAT REFRESH command qualifier (3GPP TS 31.111 [41]) of type "Steering of Roaming" it shall perform items a), b) and c) of the procedure for steering of roaming in subclause 4.4.6 and if the UE has a list of available and allowable PLMNs in the area and based on this list the UE determines that there is a higher priority PLMN than the currently camped chosen VPLMN and the UE is in automatic network selection mode, then the UE shall either:
 - i) release the current N1 NAS signalling connection locally and then attempt to obtain service on a higher priority PLMN as specified in subclause 4.4.3.3 by acting as if timer T that controls periodic attempts has expired. In this case, steps 8 to 11 are skipped; or
 - ii) not release the current N1 NAS signalling connection locally and skip steps 8 to 10;
- b) if the steering of roaming information contains the list of preferred PLMN/access technology combinations, the ME shall replace the highest priority entries in the "Operator Controlled PLMN Selector with Access Technology" list stored in the ME with the received list of preferred PLMN/access technology combinations. Additionally, if the UDM has not requested an acknowledgement from the UE and if the UE has a list of available and allowable PLMNs in the area and based on this list the UE determines that there is a higher priority PLMN than the currently camped chosen VPLMN and the UE is in automatic network selection mode, then the UE shall send the REGISTRATION COMPLETE message to the serving AMF without including an SOR transparent container and then either:
 - i) release the current N1 NAS signalling connection locally and then attempt to obtain service on a higher priority PLMN as specified in subclause 4.4.3.3 by acting as if timer T that controls periodic attempts has expired. In this case, steps 8 to 11 are skipped; or
 - ii) not release the current N1 NAS signalling connection locally and skip steps 8 to 10;

8) If:

- a) the UE's USIM is configured with indication that the UE is to receive the steering of roaming information due to initial registration in a VPLMN, but neither the list of preferred PLMN/access technology combinations nor the secured packet nor the HPLMN indication that 'no change of the "Operator Controlled PLMN Selector with Access Technology" list stored in the UE is needed and thus no list of preferred PLMN/access technology combinations is provided' is received in the REGISTRATION ACCEPT message, when the UE performs initial registration in a VPLMN or if the steering of roaming information is received but the security check is not successful; and
- b) the current chosen VPLMN is not contained in the list of "PLMNs where registration was aborted due to SOR", not part of "User Controlled PLMN Selector with Access Technology" list, the UE is not in manual mode of operation and the PDU session for emergency services is not pending to be activated;

then the UE shall send the REGISTRATION COMPLETE message to the serving AMF without including an SOR transparent container, release the current N1 NAS signalling connection locally, store the PLMN identity in the list of "PLMNs where registration was aborted due to SOR" and attempt to obtain service on a higher priority PLMN as specified in subclause 4.4.3.3 by acting as if timer T that controls periodic attempts has expired, with an exception that the current PLMN is considered as lowest priority, and skip steps 9 to 12;

NOTE 2: When the UE is in the manual mode of operation or the current chosen VPLMN is part of the "User Controlled PLMN Selector with Access Technology" list, the UE stays on the VPLMN.

- 9) The UE to the VPLMN AMF: If the UDM has requested an acknowledgement from the UE:

the UE verified that the steering of roaming information has been provided by the HPLMN in step 7, the UE sends the REGISTRATION COMPLETE message to the serving AMF with an SOR transparent container including the UE acknowledgement; and

if the steering of roaming information contained a secured packet and the security check was successful, then when the UE receives the USAT REFRESH command qualifier of type "Steering of Roaming", it performs items a), b) and c) of the procedure for steering of roaming in subclause 4.4.6.

- 10) The AMF to the UDM: If an SOR transparent container is received in the REGISTRATION COMPLETE message, the AMF uses the Nudm_SDM_Info service operation to provide the received SOR transparent container to the UDM. If the HPLMN decided that the UE is to acknowledge the successful security check of the received steering of roaming information in step 4, the UDM verifies that the acknowledgement is provided by the UE as specified in 3GPP TS 33.501 [66];

- 11) If the UE has a list of available PLMNs in the area and based on this list the UE determines that there is a higher priority PLMN than the currently camped chosen VPLMN and the UE is in automatic network selection mode, then the UE shall attempt to obtain service on a higher priority PLMN as specified in subclause 4.4.3.3 by acting as if timer T that controls periodic attempts has expired after the release of the N1 NAS signalling connection. If the N1 NAS signalling connection is not released after implementation dependent time, the UE may locally release the N1 signalling connection except when the UE is registered for emergency services or the UE has an established emergency PDU session (see 3GPP TS 24.501 [64]); and

- 12) The UE deletes the list of "PLMNs where registration was aborted due to SOR".

The list of "PLMNs where registration was aborted due to SOR" is deleted when the UE is switched off or the USIM is removed.

6.3.1.4.3 Test Description

6.3.1.4.3.1 Pre-test conditions

System Simulator:

- Two inter-frequency multi-PLMN NR Cells as specified in TS 38.508-1 [4] Table 4.4.2-1 are configured broadcasting PLMNs as indicated in Table 6.3.1.4.3.1-1.
- The PLMNs are identified in the test by the identifiers in Table 6.3.1.4.3.1-1. The MCC and MNC values corresponding to the PLMN identifier shall be understood as those specified in TS 36.523-1 [42], Table 6.0.1-1.

Table 6.3.1.4.3.1-1: PLMN identifiers

NR Cell	PLMN names
NR Cell 11	PLMN2
NR Cell 12	PLMN13

NR Cell 11 is set to "Serving Cell";

NR Cell 12 is set to "Serving Cell";

- System Information Combination NR-4 as defined in TS 38.508 [4] clause 4.4.3.1.3 is used in NR cells.

UE:

- The UE is in Manual PLMN selection mode.
- USIM configuration as defined in Table 6.4.1-10 in TS 38.508-1 [4] will be used.

Preamble:

- The UE is in Switched OFF (State 0-A) as defined in TS 38.508-1 [4] Table 4.4A.2-0
- UE's Last Registered PLMN (RPLMN) needs to be cleared by using Registration Reject procedure as defined in TS 38.508-1 [4] Subclause 4.9.8

6.3.1.4.4 Test procedure sequence

Table 6.3.1.4.4-1: Main behaviour

St	Procedure	Message Sequence		TP	Verdict
		U - S	Message		
1	Power on the UE	-	-	-	-
2	PLMN13 is manually selected	-	-	-	-
3-15	Steps 1 to 13 of the registration procedure described in TS 38.508-1 [4] Table 4.5.2.2-2 are performed on NR Cell 12	-	-	-	-
16	The SS transmits a <i>DLInformationTransfer</i> message and a REGISTRATION ACCEPT message containing steering of roaming information, includes unmatched SOR-MAC-IAUSF that will result in unsuccessful security check while on UE reception	<--	NR RRC: <i>DLInformationTransfer</i> 5G MM: REGISTRATION ACCEPT	-	-
17	The UE transmits an <i>ULInformationTransfer</i> message and REGISTRATION COMPLETE message without including an SOR transparent container	-->	NR RRC: <i>ULInformationTransfer</i> 5G MM: REGISTRATION COMPLETE	1	P
18-21a1	Steps 16 to 19a1 of the registration procedure described in TS 38.508-1 [4] Table 4.5.2.2-2	-	-	-	-
22	The SS transmits an <i>RRRelease</i> message	<--	NR RRC: <i>RRRelease</i>	-	-
23	SS starts timer of 1 minute and waits this timer expires	-	-	-	-
24	Check: Does the UE is in state 5GC RRC_IDLE on NR Cell 12 as specified in TS 38.508-1 [4] Table 4.9.4.2.2-1?	-	-	1	P
25	The SS configures: - NR Cell 11 as a "Non-Suitable "off" cell ".	-	-	-	-
26	The user sets the UE in Automatic PLMN selection mode.	-	-	-	-

6.3.1.4.5 Specific message contents

Table 6.3.1.4.5-1: REGISTRATION ACCEPT for NR Cell 12 (step 16, Table 6.3.1.4.4-1)

Derivation Path: TS 38.508-1 [4] Table 4.7.1-7			
Information Element	Value/remark	Comment	Condition
SOR Transparent Container	Present	The SOR transparent container carries steering of roaming information.	

Table 6.3.1.4.5-2: SOR Transparent Container in REGISTRATION ACCEPT for NR Cell 12 (step 16, Table 6.3.1.4.4-1)

Derivation Path: TS 24.501 [22] Figure 9.11.3.51.1			
Information Element	Value/remark	Comment	Condition
SoR-MAC-I _{AUS}	Set to mismatch the calculated SoR-MAC-I _{AUS} as the way defined in TS 33.501 A.17		
Counter _{SOR}	Value generated as per TS 33.501 Cl 6.14.2.3		
SOR data type	0	The SOR transparent container carries steering of roaming information.	
List indication value	1	List of preferred PLMN/access technology combinations is provided	
List type	1	The list type is a PLMN ID and access technology list	
Acknowledgement (ACK) value	1	Acknowledgement requested	
PLMN ID 1	PLMN2		
Access Technology Identifier 1	NG-RAN		

Table 6.3.1.4.5-3: REGISTRATION COMPLETE for NR Cell 12 (step 17, Table 6.3.1.4.4-1)

Derivation Path: 38.508-1 [4] Table 4.7.1-8			
Information Element	Value/remark	Comment	Condition
SOR Transparent Container	Not Present	The SOR transparent container is not included in REGISTRATION COMPLETE message	

6.3.1.5 Steering of UE in roaming during registration/UE configured to receive Steering of Roaming information but does not receive Steering of Roaming from Network

6.3.1.5.1 Test Purpose (TP)

(1)

```

with {the UE in Automatic PLMN Selection mode, VPLMN not part of "PLMNs where registration was
aborted due to SOR" List and not part of "User Controlled PLMN Selector with Access Technology" &
UE's USIM configured with indication that the UE is to receive Steering of Roaming information due
to initial registration in a VPLMN and the PDU session for emergency services is not pending to be
activated}
ensure that {
  when {neither the list of preferred PLMN/access technology combinations nor the HPLMN indication
that "no change of the 'Operator Controlled PLMN Selector with Access Technology' list stored in the
UE is needed and thus no list of preferred PLMN/access technology combinations is provided" is
received in the REGISTRATION ACCEPT message}
  then {UE releases N1 NAS Signalling connection locally, adds PLMN to "PLMNs where registration
was aborted due to SOR" and performs PLMN selection with current VPLMN considered as lowest
priority}
}

```

6.3.1.5.2 Conformance requirements

References: The conformance requirements covered in the present TC are specified in: TS 23.122, clauses C.1 and C.2. Unless otherwise stated these are Rel-15 requirements.

[TS 23.122, clause C.1]

If:

- the UE's USIM is configured to indicate that the UE shall expect to receive the steering of roaming information during initial registration procedure but did not receive it or security check on the steering of roaming information fails;
- the current chosen VPLMN is not contained in the list of "PLMNs where registration was aborted due to SOR";
- the current chosen VPLMN is not part of "User Controlled PLMN Selector with Access Technology" list; and
- the UE is not in manual mode of operation;

then the UE will perform PLMN selection with the current VPLMN considered as lowest priority.

[TS 23.122, clause C.2]

- 6) The VPLMN AMF to the UE: The VPLMN AMF shall transparently send the received steering of roaming information to the UE in the REGISTRATION ACCEPT message;
- 7) If the steering of roaming information is received and the security check is successful, then:
 - a) if the steering of roaming information contains a secured packet (see 3GPP TS 31.115 [67]):
 - if the UDM has not requested an acknowledgement from the UE the UE shall send the REGISTRATION COMPLETE message;
 - the ME shall upload the secured packet to the USIM using procedures in 3GPP TS 31.111 [41];

NOTE 1: How the ME handles UICC responses and failures in communication between the ME and UICC is implementation specific and out of scope of this release of the specification.

- if the UDM has not requested an acknowledgement from the UE and the ME receives a USAT REFRESH command qualifier (3GPP TS 31.111 [41]) of type "Steering of Roaming" it shall perform items a), b) and c) of the procedure for steering of roaming in subclause 4.4.6 and if the UE has a list of available and allowable PLMNs in the area and based on this list the UE determines that there is a higher priority PLMN than the currently camped chosen VPLMN and the UE is in automatic network selection mode, then the UE shall either:

- i) release the current N1 NAS signalling connection locally and then attempt to obtain service on a higher priority PLMN as specified in subclause 4.4.3.3 by acting as if timer T that controls periodic attempts has expired. In this case, steps 8 to 11 are skipped; or
 - ii) not release the current N1 NAS signalling connection locally and skip steps 8 to 10;
 - b) if the steering of roaming information contains the list of preferred PLMN/access technology combinations, the ME shall replace the highest priority entries in the "Operator Controlled PLMN Selector with Access Technology" list stored in the ME with the received list of preferred PLMN/access technology combinations. Additionally, if the UDM has not requested an acknowledgement from the UE and if the UE has a list of available and allowable PLMNs in the area and based on this list the UE determines that there is a higher priority PLMN than the currently camped chosen VPLMN and the UE is in automatic network selection mode, then the UE shall send the REGISTRATION COMPLETE message to the serving AMF without including an SOR transparent container and then either:
 - i) release the current N1 NAS signalling connection locally and then attempt to obtain service on a higher priority PLMN as specified in subclause 4.4.3.3 by acting as if timer T that controls periodic attempts has expired. In this case, steps 8 to 11 are skipped; or
 - ii) not release the current N1 NAS signalling connection locally and skip steps 8 to 10;
- 8) If:
- a) the UE's USIM is configured with indication that the UE is to receive the steering of roaming information due to initial registration in a VPLMN, but neither the list of preferred PLMN/access technology combinations nor the secured packet nor the HPLMN indication that 'no change of the "Operator Controlled PLMN Selector with Access Technology" list stored in the UE is needed and thus no list of preferred PLMN/access technology combinations is provided' is received in the REGISTRATION ACCEPT message, when the UE performs initial registration in a VPLMN or if the steering of roaming information is received but the security check is not successful; and
 - b) the current chosen VPLMN is not contained in the list of "PLMNs where registration was aborted due to SOR", not part of "User Controlled PLMN Selector with Access Technology" list, the UE is not in manual mode of operation and the PDU session for emergency services is not pending to be activated;
- then the UE shall send the REGISTRATION COMPLETE message to the serving AMF without including an SOR transparent container, release the current N1 NAS signalling connection locally, store the PLMN identity in the list of "PLMNs where registration was aborted due to SOR" and attempt to obtain service on a higher priority PLMN as specified in subclause 4.4.3.3 by acting as if timer T that controls periodic attempts has expired, with an exception that the current PLMN is considered as lowest priority, and skip steps 9 to 12;
- NOTE 2: When the UE is in the manual mode of operation or the current chosen VPLMN is part of the "User Controlled PLMN Selector with Access Technology" list, the UE stays on the VPLMN.
- 9) The UE to the VPLMN AMF: If the UDM has requested an acknowledgement from the UE:
- the UE verified that the steering of roaming information has been provided by the HPLMN in step 7, the UE sends the REGISTRATION COMPLETE message to the serving AMF with an SOR transparent container including the UE acknowledgement; and
- if the steering of roaming information contained a secured packet and the security check was successful, then when the UE receives the USAT REFRESH command qualifier of type "Steering of Roaming", it performs items a), b) and c) of the procedure for steering of roaming in subclause 4.4.6.
- 10) The AMF to the UDM: If an SOR transparent container is received in the REGISTRATION COMPLETE message, the AMF uses the Nudm_SDM_Info service operation to provide the received SOR transparent container to the UDM. If the HPLMN decided that the UE is to acknowledge the successful security check of the received steering of roaming information in step 4, the UDM verifies that the acknowledgement is provided by the UE as specified in 3GPP TS 33.501 [66];
- 11) If the UE has a list of available PLMNs in the area and based on this list the UE determines that there is a higher priority PLMN than the currently camped chosen VPLMN and the UE is in automatic network selection mode, then the UE shall attempt to obtain service on a higher priority PLMN as specified in subclause 4.4.3.3 by acting as if timer T that controls periodic attempts has expired after the release of the N1 NAS signalling connection. If the N1 NAS signalling connection is not released after implementation dependent time, the UE may locally

release the N1 signalling connection except when the UE is registered for emergency services or the UE has an established emergency PDU session (see 3GPP TS 24.501 [64]); and

12) The UE deletes the list of "PLMNs where registration was aborted due to SOR".

The list of "PLMNs where registration was aborted due to SOR" is deleted when the UE is switched off or the USIM is removed.

6.3.1.5.3 Test Description

6.3.1.5.3.1 Pre-test conditions

System Simulator:

- Three inter-frequency multi-PLMN NR Cells as specified in TS 38.508-1 [4] Table 4.4.2-1 are configured broadcasting PLMNs as indicated in Table 6.3.1.5.3.1-1.
- The PLMNs are identified in the test by the identifiers in Table 6.3.1.5.3.1-1. The MCC and MNC values corresponding to the PLMN identifier shall understood as those specified in TS 36.523-1 [42], Table 6.0.1-1.

Table 6.3.1.5.3.1-1: PLMN identifiers

NR Cell	PLMN names
NR Cell 11	PLMN2
NR Cell 12	PLMN13
NR Cell 13	PLMN14

NR Cell 11 is set to "Serving Cell";

NR Cell 12 is set to "Serving Cell";

NR Cell 13 is set to "Serving Cell";

System Information Combination NR-4 as defined in TS 38.508-1 [4] clause 4.4.3.1.3 is used in NR cells.

UE:

- The UE is in Automatic PLMN selection mode.
- USIM configuration as defined in Table 6.4.1-10 of TS 38.508-1 [4] will be used.

Preamble:

- The UE is in Switched OFF (State 0-A) as defined in TS 38.508-1 [4] Table 4.4A.2-0.
- UE's Last Registered PLMN (RPLMN) needs to be cleared by using Registration Reject procedure as defined in TS 38.508-1 [4] Subclause 4.9.8.

6.3.1.5.4 Test procedure sequence

Table 6.3.1.5.4-1: Main behaviour

St	Procedure	Message Sequence		TP	Verdict
		U - S	Message		
1	Power on the UE	-	-	-	-
2-15	Steps 1 to 14 of the registration procedure described in TS 38.508-1 [4] Table 4.5.2.2-2 are performed on NR Cell 13	-	-	-	-
16	SS starts timer of $t_{max} = (6 \text{ minutes} + \text{cell selection time})$ (Note 1, 2 and 3)	-	-	-	-
17	The UE transmits an <i>ULInformationTransfer</i> message and REGISTRATION COMPLETE message without including an SOR transparent container	-->	NR RRC: <i>ULInformationTransfer</i> 5G MM: REGISTRATION COMPLETE	-	-
18	The SS locally releases the RRC connection.	-	-	-	-
19	Check: Does the UE transmits an <i>RRCSetupRequest</i> message on NR Cell 13 before t_{max} expires? (Note 1, 2 and 3)	-->	NR RRC: <i>RRCSetupRequest</i>	1	F
20	Check: Does the UE transmits an <i>RRCSetupRequest</i> message on NR Cell 12 before t_{max} expires? (Note 1, 2 and 3)	-->	NR RRC: <i>RRCSetupRequest</i>	1	P
21	The SS transmits an <i>RRCSetup</i> message on NR Cell 12.	<--	NR RRC: <i>RRCSetup</i>	-	-
22	The UE transmits an <i>RRCSetupComplete</i> message and a REGISTRATION REQUEST message on NR Cell 12. (Note 4)	-->	NR RRC: <i>RRCSetupComplete</i> 5GMM: REGISTRATION REQUEST	-	-
-	EXCEPTION: Steps 23a1 to 23b5a1 describe behaviours which depend on procedure parameters; the "lower case letter" identifies a step sequence that take place if a procedure parameter has a particular value	-	-	-	-
23a1-23a15a1	IF 5GS registration type is set as Initial Registration in step 22, THEN steps 5 to 20a1 of the registration procedure described in TS 38.508-1 [4] Table 4.5.2.2-2 are performed on NR Cell 12.	-	-	-	-
23b1-23b2	Void	-	-	-	-
23b3-23b5a1	ELSE IF 5GS registration type is set as Mobility Registration in step 22, THEN steps 4 to 6a1 of the generic test procedure in TS 38.508-1 [4] Table 4.9.5.2.2-1 are performed on NR Cell 12.	-	-	-	-
Note 1:	Timer t_{max} in step 16, 19 and 20 are derived from the high priority PLMN search timer T defined by EF_{HPPLMN}				
Note 2:	Following attempts to access the HPLMN/EHPLMN/higher priority PLMN in VPLMN is operator specific setting (Refer to TS 23.122 Rel-12). Hence, window between $120s + T + \text{Tolerance}$ is being used, where the high priority PLMN search timer T defined by EF_{HPPLMN}				
Note 3:	Tolerance of 5min is added to allow time for the UE to find the proper PLMN				
Note 4:	The 5GS registration type shall be only set as Mobility Registration for Rel-16 UEs according to TS 24.501 subclause 5.2.3.2.5 specified in Release 16. The EXCEPTION description applies only to Rel-15 UEs.				

6.3.1.5.5 Specific message contents

Table 6.3.1.5.5-1: REGISTRATION COMPLETE for NR Cell 13 (step 17 Table 6.3.1.5.4-1)

Derivation Path: TS 38.508-1 [4] Table 4.7.1-8			
Information Element	Value/remark	Comment	Condition
SOR Transparent Container	Not Present	The SOR transparent container is not included in REGISTRATION COMPLETE message	

Table 6.3.1.5.5-1A: REGISTRATION ACCEPT for NR Cell 13 (step 23a10 Table 6.3.1.5.4-1)

Derivation Path: 38.508-1 Table 4.7.1-7			
Information Element	Value/remark	Comment	Condition
SOR Transparent Container	Present	The SOR transparent container carries steering of roaming information.	
SoR-MAC-IAUS	Set to match the calculated SoR-MAC-IAUS as the way defined in TS 33.501 A.17		
CounterSOR	Value generated as per TS 33.501 Cl 6.14.2.3		
SOR data type	0	The SOR transparent container carries steering of roaming information.	
List indication value	1	List of preferred PLMN/access technology combinations is provided	
List type	1	The list type is a PLMN ID and access technology list	
Acknowledgement (ACK) value	0	Acknowledgement is NOT requested	
PLMN ID 1	PLMN13		
Access Technology Identifier 1	NG-RAN		
PLMN ID 2	PLMN14		
Access Technology Identifier 2	NG-RAN		
PLMN ID 3	PLMN2		
Access Technology Identifier 3	NG-RAN		

Table 6.3.1.5.5-2: Void

6.3.1.6

6.3.1.7 Steering of UE in roaming during registration/security check unsuccessful but emergency service pending to be activated

6.3.1.7.1 Test Purpose (TP)

(1)

```

with {the UE in Automatic PLMN Selection mode and current VPLMN not part of "PLMNs where
registration was aborted due to SOR" List and not part of "User Controlled PLMN Selector with Access
Technology" list and UE's USIM configured with indication that the UE is to receive Steering of
Roaming information due to initial registration in a VPLMN and there is a PDU session for emergency
services pending to be activated}
ensure that {
  when {Steering of information is received but security check is unsuccessful}
  then {UE will continue with the registration procedure on the VPLMN so as to be able to
establish the emergency PDU session}
}

```

6.3.1.7.2 Conformance requirements

References: The conformance requirements covered in the present TC are specified in: TS 23.122, clause C.2. Unless otherwise stated these are Rel-15 requirements.

[TS 23.122, clause C.2]

- 6) The VPLMN AMF to the UE: The VPLMN AMF shall transparently send the received steering of roaming information to the UE in the REGISTRATION ACCEPT message;
- 7) If the steering of roaming information is received and the security check is successful, then:
 - a) if the steering of roaming information contains a secured packet (see 3GPP TS 31.115 [67]):
 - if the UDM has not requested an acknowledgement from the UE the UE shall send the REGISTRATION COMPLETE message;
 - the ME shall upload the secured packet to the USIM using procedures in 3GPP TS 31.111 [41];

NOTE 1: How the ME handles UICC responses and failures in communication between the ME and UICC is implementation specific and out of scope of this release of the specification.

- if the UDM has not requested an acknowledgement from the UE and the ME receives a USAT REFRESH command qualifier (3GPP TS 31.111 [41]) of type "Steering of Roaming" it shall perform items a), b) and c) of the procedure for steering of roaming in subclause 4.4.6 and if the UE has a list of available and allowable PLMNs in the area and based on this list the UE determines that there is a higher priority PLMN than the currently camped chosen VPLMN and the UE is in automatic network selection mode, then the UE shall either:
 - i) release the current N1 NAS signalling connection locally and then attempt to obtain service on a higher priority PLMN as specified in subclause 4.4.3.3 by acting as if timer T that controls periodic attempts has expired. In this case, steps 8 to 11 are skipped; or
 - ii) not release the current N1 NAS signalling connection locally and skip steps 8 to 10;
- b) if the steering of roaming information contains the list of preferred PLMN/access technology combinations, the ME shall replace the highest priority entries in the "Operator Controlled PLMN Selector with Access Technology" list stored in the ME with the received list of preferred PLMN/access technology combinations. Additionally, if the UDM has not requested an acknowledgement from the UE and if the UE has a list of available and allowable PLMNs in the area and based on this list the UE determines that there is a higher priority PLMN than the currently camped chosen VPLMN and the UE is in automatic network selection

mode, then the UE shall send the REGISTRATION COMPLETE message to the serving AMF without including an SOR transparent container and then either:

- i) release the current N1 NAS signalling connection locally and then attempt to obtain service on a higher priority PLMN as specified in subclause 4.4.3.3 by acting as if timer T that controls periodic attempts has expired. In this case, steps 8 to 11 are skipped; or
- ii) not release the current N1 NAS signalling connection locally and skip steps 8 to 10;

8) If:

- a) the UE's USIM is configured with indication that the UE is to receive the steering of roaming information due to initial registration in a VPLMN, but neither the list of preferred PLMN/access technology combinations nor the secured packet nor the HPLMN indication that 'no change of the "Operator Controlled PLMN Selector with Access Technology" list stored in the UE is needed and thus no list of preferred PLMN/access technology combinations is provided' is received in the REGISTRATION ACCEPT message, when the UE performs initial registration in a VPLMN or if the steering of roaming information is received but the security check is not successful; and
- b) the current chosen VPLMN is not contained in the list of "PLMNs where registration was aborted due to SOR", not part of "User Controlled PLMN Selector with Access Technology" list, the UE is not in manual mode of operation and the PDU session for emergency services is not pending to be activated;

then the UE shall send the REGISTRATION COMPLETE message to the serving AMF without including an SOR transparent container, release the current N1 NAS signalling connection locally, store the PLMN identity in the list of "PLMNs where registration was aborted due to SOR" and attempt to obtain service on a higher priority PLMN as specified in subclause 4.4.3.3 by acting as if timer T that controls periodic attempts has expired, with an exception that the current PLMN is considered as lowest priority, and skip steps 9 to 12;

NOTE 2: When the UE is in the manual mode of operation or the current chosen VPLMN is part of the "User Controlled PLMN Selector with Access Technology" list, the UE stays on the VPLMN.

9) The UE to the VPLMN AMF: If the UDM has requested an acknowledgement from the UE:

the UE verified that the steering of roaming information has been provided by the HPLMN in step 7, the UE sends the REGISTRATION COMPLETE message to the serving AMF with an SOR transparent container including the UE acknowledgement; and

if the steering of roaming information contained a secured packet and the security check was successful, then when the UE receives the USAT REFRESH command qualifier of type "Steering of Roaming", it performs items a), b) and c) of the procedure for steering of roaming in subclause 4.4.6.

10) The AMF to the UDM: If an SOR transparent container is received in the REGISTRATION COMPLETE message, the AMF uses the Nudm_SDM_Info service operation to provide the received SOR transparent container to the UDM. If the HPLMN decided that the UE is to acknowledge the successful security check of the received steering of roaming information in step 4, the UDM verifies that the acknowledgement is provided by the UE as specified in 3GPP TS 33.501 [66];

11) If the UE has a list of available PLMNs in the area and based on this list the UE determines that there is a higher priority PLMN than the currently camped chosen VPLMN and the UE is in automatic network selection mode, then the UE shall attempt to obtain service on a higher priority PLMN as specified in subclause 4.4.3.3 by acting as if timer T that controls periodic attempts has expired after the release of the N1 NAS signalling connection. If the N1 NAS signalling connection is not released after implementation dependent time, the UE may locally release the N1 signalling connection except when the UE is registered for emergency services or the UE has an established emergency PDU session (see 3GPP TS 24.501 [64]); and

12) The UE deletes the list of "PLMNs where registration was aborted due to SOR".

The list of "PLMNs where registration was aborted due to SOR" is deleted when the UE is switched off or the USIM is removed.

When the UE performs registration procedure for emergency services (see 3GPP TS 24.501 [64] and 3GPP TS 23.502 [63]) while the UE has a valid USIM and the AMF performs the authentication procedure, then based on HPLMN policy, the SOR procedure described in this subclause may apply.

NOTE 3: The HPLMN/UDM cannot distinguish between "initial registration" and "emergency registration" thus SOR implicitly applies for emergency registration.

6.3.1.7.3 Test Description

6.3.1.7.3.1 Pre-test conditions

System Simulator:

- One inter-frequency multi-PLMN NR Cell as specified in TS 38.508-1 [4] Table 4.4.2-1 are configured broadcasting PLMNs as indicated in Table 6.3.1.7.3.1-1.
- The PLMNs are identified in the test by the identifiers in Table 6.3.1.7.3.1-1. The MCC and MNC values corresponding to the PLMN identifier shall understood as those specified in TS 36.523-1 [42], Table 6.0.1-1.

Table 6.3.1.7.3.1-1: PLMN identifiers

NR Cell	PLMN names
NR Cell 11	PLMN2

NR Cell 11 is set to "Serving Cell";

System Information Combination NR-4 as defined in TS 38.508-1 [4] clause 4.4.3.1.3 is used in NR cells.

UE:

- The UE is in Automatic PLMN selection mode.
- USIM configuration as defined in Table 6.4.1-10 of TS 38.508-1 [4] will be used.

Preamble:

- The UE is in Switched OFF (State 0-A) as defined in TS 38.508-1 [4] Table 4.4A.2-0.

6.3.1.7.4 Test procedure sequence

Table 6.3.1.7.4-1: Main behaviour

St	Procedure	Message Sequence		TP	Verdict
		U - S	Message		
1	Power on the UE	-	-	-	-
1A 1- 1A 13	Steps 1 to 13 of the registration procedure described in TS 38.508-1 [4] Table 4.5.2.2-2 are performed on NR Cell 11.	-	-	-	-
1B	SS transmits a REGISTRATION REJECT message with cause #22 (Congestion) and T3346 set to 3 minutes. (Note 1)	<--	NR RRC: <i>DLInformationTransfer</i> 5GMM: REGISTRATION REJECT	-	-
1C	The SS releases the RRC connection.	-	-	-	-
2	The UE is made to establish an Emergency PDU session. (Note 2)	-	-	-	-
3	The UE transmits an RRCSetupRequest message on NR Cell 11 with establishmentCause set to 'emergency'.	-->	NR RRC: RRCSetupRequest	-	-
4-5	Steps 3 to 4 of the registration procedure described in TS 38.508-1 [4] Table 4.5.2.2-2 are performed.	-	-	-	-
6	The UE transmit a REGISTRATION REQUEST message. (Note 3)	-->	5G MM: REGISTRATION REQUEST	-	-
7- 14	Steps 5 to 13 of the registration procedure described in TS 38.508-1 [4] Table 4.5.2.2-2 are performed on NR Cell 11	-	-	-	-
15	The SS transmits a <i>DLInformationTransfer</i> message and a REGISTRATION ACCEPT message containing steering of roaming information, includes unmatched SOR-MAC-I _{AUSF} that will result in unsuccessful security check while on UE reception	<--	NR RRC: <i>DLInformationTransfer</i> 5G MM: REGISTRATION ACCEPT	-	-
16	The UE transmits an <i>ULInformationTransfer</i> message and REGISTRATION COMPLETE message without including an SOR transparent container	-->	NR RRC: <i>ULInformationTransfer</i> 5G MM: REGISTRATION COMPLETE	-	-
17	Check: Does the UE transmit an UL NAS TRANSPORT message with "Request type" set to "initial emergency request", and a PDU SESSION ESTABLISHMENT REQUEST message on NR Cell 11	-->	5GMM: UL NAS TRANSPORT 5GSM: PDU SESSION ESTABLISHMENT REQUEST	1	P
18	The SS transmits a PDU SESSION ESTABLISHMENT ACCEPT message.	<--	5GMM: DL NAS TRANSPORT 5GSM: PDU SESSION ESTABLISHMENT ACCEPT	-	-
Note 1: T3346 is set to 3 minutes.This is checked for 3 minutes less tolerance.					
Note 2: This can be done by an AT/MMI command.					
Note 3: 5GS registration type can set to either "initial registration" according to TS 24.501 clause 5.5.1.2.6A or "emergency registration" according to TS 24.501 clause 5.5.1.2.					

6.3.1.7.5 Specific message contents

Table 6.3.1.7.5-0: REGISTRATION REJECT for NR Cell 11 (step 1B Table 6.3.1.7.4-1)

Derivation Path: TS 38.508-1 [4], Table 4.7.1-9			
Information Element	Value/remark	Comment	Condition
5GMM cause	'00010110'B	Cause #22 (Congestion)	
T3346 value	'00100011'B	3 minutes	

Table 6.3.1.7.5-1: Void

Table 6.3.1.7.5-2: REGISTRATION ACCEPT for NR Cell 11 11 (step 15, Table 6.3.1.7.4-1)

Derivation Path: TS 38.508-1 [4] Table 4.7.1-7			
Information Element	Value/remark	Comment	Condition
SOR Transparent Container	Present	The SOR transparent container carries steering of roaming information.	

Table 6.3.1.7.5-3: SOR Transparent Container in REGISTRATION ACCEPT for NR Cell 13 (step 15, Table 6.3.1.7.4-1)

Derivation Path: TS 24.501 [22] Figure 9.11.3.51.1			
Information Element	Value/remark	Comment	Condition
SoR-MAC-IaUS	Set to mismatch the calculated SoR-MAC-IaUS as the way defined in TS 33.501 A.17		
Counter _{SOR}	Value generated as per TS 33.501 Cl 6.14.2.3		
SOR data type	0	The SOR transparent container carries steering of roaming information.	
List indication value	1	List of preferred PLMN/access technology combinations is provided	
List type	1	The list type is a PLMN ID and access technology list	
Acknowledgement (ACK) value	1	Acknowledgement requested	
PLMN ID 1	PLMN2		
Access Technology Identifier 1	NG-RAN		

Table 6.3.1.7.5-4: REGISTRATION COMPLETE for NR Cell 11 (step 16 Table 6.3.1.7.4-1)

Derivation Path: TS 38.508-1 [4] Table 4.7.1-8			
Information Element	Value/remark	Comment	Condition
SOR Transparent Container	Not Present	The SOR transparent container is not included in REGISTRATION COMPLETE message	

Table 6.3.1.7.5-5: UL NAS TRANSPORT (step 17, Table 6.3.1.7.4-1)

Derivation Path: TS 38.508-1 [4] Table 4.7.1-10, condition INITIAL_PDU_REQUEST.			
Information Element	Value/remark	Comment	Condition
Request type	'011'B	initial emergency request	
S-NSSAI	Not Present		
DNN	Not Present		

Table 6.3.1.7.5-6: PDU SESSION ESTABLISHMENT REQUEST (step 17, Table 6.3.1.7.4-1)

Derivation Path: TS 38.508-1 [4] Table 4.7.2-1.			
Information Element	Value/remark	Comment	Condition
PDU session ID	A value that is not currently being used by another PDU session		
PTI	A value currently not used		
SSC mode	'001'B	SSC mode 1	

6.3.1.8 Steering of UE in roaming after registration/Automatic PLMN selection mode

6.3.1.8.1 Test Purpose (TP)

(1)

```
with {UE being in automatic PLMN selection mode and UE has registered onto a VPLMN}
ensure that {
  when {SOR transparent container included in DL NAS TRANSPORT message contains steering of roaming information and indicates ACK has been requested and security check is successful}
  then {UE sends an SOR transparent container with ACK in UL NAS TRANSPORT message and waits until it moves to idle mode or 5GMM-CONNECTED mode with RRC inactive indication before attempting to obtain service on a higher priority PLMN}
}
```

6.3.1.8.2 Conformance requirements

References: The conformance requirements covered in the present TC are specified in: TS 23.122, clause C.3. Unless otherwise stated these are Rel-15 requirements

[TS 23.122, clause C.3]

- 2) The AMF to the UE: the AMF sends a DL NAS TRANSPORT message to the served UE. The AMF includes in the DL NAS TRANSPORT message the steering of roaming information received from the UDM.
- 3) Upon receiving the steering of roaming information, the UE shall perform a security check on the list of preferred PLMN/access technology combinations included in the DL NAS TRANSPORT message to verify that the list of preferred PLMN/access technology combinations is provided by HPLMN, and:
 - a) if the security check is successful and:
 - if the steering of roaming information contains a secured packet (see 3GPP TS 31.115 [67]), the ME shall upload the secured packet to the USIM using procedures in 3GPP TS 31.111 [41];

NOTE 1: How the ME handles UICC responses and failures in communication between the ME and UICC is implementation specific and out of scope of this release of the specification.

When the ME receives a USAT REFRESH command qualifier (see 3GPP TS 31.111 [41]) of type "Steering of Roaming" it performs the procedure for steering of roaming in subclause 4.4.6 with an exception that if the UE is in automatic network selection mode, then the UE shall wait until it moves to idle mode or 5GMM-CONNECTED mode with RRC inactive indication (see 3GPP TS 24.501 [64]) before attempting to obtain service on a higher priority PLMN (specified in subclause 4.4.6 bullet d);

- otherwise, the ME shall replace the highest priority entries in the "Operator Controlled PLMN Selector with Access Technology" list stored in the ME with the received list of preferred PLMN/access technology combinations. If the UE is in automatic network selection mode, then the UE shall wait until it moves to idle mode or 5GMM-CONNECTED mode with RRC inactive indication (see 3GPP TS 24.501 [64]) before attempting to obtain service on a higher priority PLMN as specified in subclause 4.4.3.3 by acting as if timer T that controls periodic attempts has expired.

If the last established PDU session is an emergency PDU session then the UE shall attempt to perform the PLMN selection after the release of the emergency PDU session and expiration of timer T.

If the UDM has not requested an acknowledgement from the UE then steps 4 and 5 are skipped; and

- b) if the security check is not successful and the UE is in automatic network selection mode, then the UE shall wait until it moves to idle mode or 5GMM-CONNECTED mode with RRC inactive indication (see 3GPP TS 24.501 [64]) before attempting to obtain service on a higher priority PLMN as specified in subclause 4.4.3.3 by acting as if timer T that controls periodic attempts has expired, with an exception that the current PLMN is considered as lowest priority. If the last established PDU session is an emergency PDU session then the UE shall attempt to perform the PLMN selection after the release of the emergency PDU session and expiration of timer T.

If the UDM has not requested an acknowledgement from the UE then steps 4 and 5 are skipped;

NOTE 2: When the UE is in the manual mode of operation or the current chosen VPLMN is part of the "User Controlled PLMN Selector with Access Technology" list, the UE stays on the VPLMN.

- 4) The UE to the AMF: if the UDM has requested an acknowledgement from the UE in the DL NAS TRANSPORT message and the security check in step 2 was successful, the UE sends an UL NAS TRANSPORT message to the serving AMF with an SOR transparent container including the UE acknowledgement;

6.3.1.8.3 Test Description

6.3.1.8.3.1 Pre-test conditions

System Simulator:

- Three inter-frequency multi-PLMN NR Cells as specified in TS 38.508-1 [4] Table 4.4.2-1 are configured broadcasting PLMNs as indicated in Table 6.3.1.8.3.1-1.
- The PLMNs are identified in the test by the identifiers in Table 6.3.1.8.3.1-1. The MCC and MNC values of PLMN identifiers are specified in TS 36.523-1 [13], Table 6.0.1-1.

Table 6.3.1.8.3.1-1: PLMN identifiers

NR Cell	PLMN names
NR Cell 11	PLMN2
NR Cell 12	PLMN13
NR Cell 13	PLMN14

NR Cell 11 is set to "Serving Cell";

NR Cell 12 is set to "Serving Cell";

NR Cell 13 is set to "Serving Cell";

System Information Combination NR-4 as defined in TS 38.508-1 [4] clause 4.4.3.1.3 is used in NR cells

UE:

- The UE is in Automatic PLMN selection mode.
- USIM configuration as defined in Table 6.4.1-21 of TS 38.508-1 [4] will be used.

Preamble:

- The UE is in Switched OFF (State 0-A) as defined in TS 38.508-1 [4] Table 4.4A.2-0
- UE's Last Registered PLMN (RPLMN) needs to be cleared by using Registration Reject procedure as defined in TS 38.508-1 [4] Subclause 4.9.8

6.3.1.8.4 Test procedure sequence

Table 6.3.1.8.4-1: Main behaviour

St	Procedure	Message Sequence		TP	Verdict
		U - S	Message		
1	Power on the UE	-	-	-	-
2	Whole registration procedure described in TS 38.508-1 [4] Table 4.5.2.2-2 are performed on NR Cell 13, with "connected without release"	-	-	-	-
3	The SS transmits an DLInformationTransfer message containing steering of roaming information indicating list of preferred PLMN/access technology combination provided with acknowledgment requested from the UE for successful reception	<--	NR RRC: <i>DLInformationTransfer</i> 5GMM: DL NAS TRANSPORT	-	-
4	SS starts timer of tmax =(6 minutes + cell selection time) (Note 1, 2 and 3)	-	-	-	-
5	The UE transmits an ULInformationTransfer message carrying acknowledgement of successful reception of the steering of roaming information	-->	NR RRC: <i>ULInformationTransfer</i> 5GMM:UL NAS TRANSPORT	1	P
6	The SS transmits an <i>RRCRelease</i> message	<--	NR RRC: <i>RRCRelease</i>	-	-
7	Check: Does the UE transmits an <i>RRCSetupRequest</i> on NR Cell 11 before tmax expires? (Note 1, 2 and 3)	-->	NR RRC: <i>RRCSetupRequest</i>	1	P
8-9	Steps 3-4 of Table 4.5.2.2-2 of the generic procedure in TS 38.508-1 [4] are performed. (Note 4)	-	-	-	-
-	EXCEPTION: Steps 10a1 to 10b5a1 describe behaviours which depend on procedure parameters; the "lower case letter" identifies a step sequence that take place if a procedure parameter has a particular value	-	-	-	-
10a 1- 10a 15a 1	IF 5GS registration type is set as Initial Registration in step 9, THEN steps 5 to 20a1 of the registration procedure described in TS 38.508-1 [4] Table 4.5.2.2-2 are performed on NR Cell 11.	-	-	-	-
10b 1- 10b 2	Void.	-	-	-	-
10b 3- 10b 5a1	ELSE IF 5GS registration type is set as Mobility Registration in step 9, THEN steps 4 to 6a1 of the generic test procedure in TS 38.508-1 [4] Table 4.9.5.2.2-1 are performed on NR Cell 11.	-	-	-	-
11- 12a 1	Void.	-	-	-	-

Note 1:	Timer tmax in step 4 and 7 are derived from the high priority PLMN search timer T defined by EF _{HPPLMN}
Note 2:	Following attempts to access the HPLMN/EHPLMN/higher priority PLMN in VPLMN is operator specific setting (Refer to TS 23.122 Rel-12). Hence, window between 120s to T+Tolerance is being used , where the high priority PLMN search timer T defined by EF _{HPPLMN}
Note 3:	Tolerance of 5min is added to allow time for the UE to find the proper PLMN
Note 4:	The 5GS registration type shall be only set as Mobility Registration for R16 UEs according to TS 24.501 subclause 5.2.3.2.5 specified in Release 16. The EXCEPTION description applies only to R15 UEs.

6.3.1.8.5 Specific message contents

Table 6.3.1.8.5-1: DL NAS TRANSPORT Message for NR Cell 13 (step 3, Table 6.3.1.8.4-1)

Derivation Path: TS 38.508-1 [4] Table 4.7.1-11			
Information Element	Value/remark	Comment	Condition
Payload Container	Present	The SOR transparent container in the payload container IE carries steering of roaming information.	
SoR-MAC-IAUS	Set to match the calculated SoR-MAC-IAUS as the way defined in TS 33.501 A.17		
CounterSOR	Value generated as per TS 33.501 Cl 6.14.2.3		
SOR data type	0	The SOR transparent container carries steering of roaming information.	
List indication value	1	List of preferred PLMN/access technology combinations is provided	
List type	1	The list type is a PLMN ID and access technology list	
Acknowledgement (ACK) value	1	Acknowledgement requested	
PLMN ID 1	PLMN2		
Access Technology Identifier 1	NG-RAN		

Table 6.3.1.8.5-2: Void

Table 6.3.1.8.5-3: UL NAS TRANSPORT Message for NR Cell 13 (step 5, Table 6.3.1.8.4-1)

Derivation Path: TS 38.508-1 [4] Table 4.7.1-10			
Information Element	Value/remark	Comment	Condition
Payload Container	Present	The SOR transparent container in the payload container IE carries acknowledgement of successful reception of the steering of roaming information.	
SOR data type	1	The SOR transparent container carries acknowledgement of successful reception of the steering of roaming information.	

Table 6.3.1.8.5-4: Void

6.3.1.9 Steering of UE in roaming after registration/Manual PLMN selection mode

6.3.1.9.1 Test Purpose (TP)

(1)

```

with {UE being in manual PLMN selection mode and UE has registered onto a VPLMN}
ensure that {
  when {SOR Transparent container included in DL NAS TRANSPORT message contains steering of roaming
information and indicates ACK has been requested and security check is successful}
  then {UE sends an SOR transparent container with ACK in UL NAS TRANSPORT message and stays on
the VPLMN
}

```

6.3.1.9.2 Conformance requirements

References: The conformance requirements covered in the present TC are specified in: TS 23.122, clause C.3. Unless otherwise stated these are Rel-15 requirements.

[TS 23.122, clause C.3]

- 2) The AMF to the UE: the AMF sends a DL NAS TRANSPORT message to the served UE. The AMF includes in the DL NAS TRANSPORT message the steering of roaming information received from the UDM.
- 3) Upon receiving the steering of roaming information, the UE shall perform a security check on the list of preferred PLMN/access technology combinations included in the DL NAS TRANSPORT message to verify that the list of preferred PLMN/access technology combinations is provided by HPLMN, and:

- a) if the security check is successful and:
 - if the steering of roaming information contains a secured packet (see 3GPP TS 31.115 [67]), the ME shall upload the secured packet to the USIM using procedures in 3GPP TS 31.111 [41];

NOTE 1: How the ME handles UICC responses and failures in communication between the ME and UICC is implementation specific and out of scope of this release of the specification.

When the ME receives a USAT REFRESH command qualifier (see 3GPP TS 31.111 [41]) of type "Steering of Roaming" it performs the procedure for steering of roaming in subclause 4.4.6 with an

exception that if the UE is in automatic network selection mode, then the UE shall wait until it moves to idle mode or 5GMM-CONNECTED mode with RRC inactive indication (see 3GPP TS 24.501 [64]) before attempting to obtain service on a higher priority PLMN (specified in subclause 4.4.6 bullet d);

- otherwise, the ME shall replace the highest priority entries in the "Operator Controlled PLMN Selector with Access Technology" list stored in the ME with the received list of preferred PLMN/access technology combinations. If the UE is in automatic network selection mode, then the UE shall wait until it moves to idle mode or 5GMM-CONNECTED mode with RRC inactive indication (see 3GPP TS 24.501 [64]) before attempting to obtain service on a higher priority PLMN as specified in subclause 4.4.3.3 by acting as if timer T that controls periodic attempts has expired.

If the last established PDU session is an emergency PDU session then the UE shall attempt to perform the PLMN selection after the release of the emergency PDU session and expiration of timer T.

If the UDM has not requested an acknowledgement from the UE then steps 4 and 5 are skipped; and

- b) if the security check is not successful and the UE is in automatic network selection mode, then the UE shall wait until it moves to idle mode or 5GMM-CONNECTED mode with RRC inactive indication (see 3GPP TS 24.501 [64]) before attempting to obtain service on a higher priority PLMN as specified in subclause 4.4.3.3 by acting as if timer T that controls periodic attempts has expired, with an exception that the current PLMN is considered as lowest priority. If the last established PDU session is an emergency PDU session then the UE shall attempt to perform the PLMN selection after the release of the emergency PDU session and expiration of timer T.

If the UDM has not requested an acknowledgement from the UE then steps 4 and 5 are skipped;

NOTE 2: When the UE is in the manual mode of operation or the current chosen VPLMN is part of the "User Controlled PLMN Selector with Access Technology" list, the UE stays on the VPLMN.

- 4) The UE to the AMF: if the UDM has requested an acknowledgement from the UE in the DL NAS TRANSPORT message and the security check in step 2 was successful, the UE sends an UL NAS TRANSPORT message to the serving AMF with an SOR transparent container including the UE acknowledgement;

6.3.1.9.3 Test Description

6.3.1.9.3.1 Pre-test conditions

System Simulator:

- Two inter-frequency multi-PLMN NR Cells as specified in TS 38.508-1 [4] Table 4.4.2-1 are configured broadcasting PLMNs as indicated in Table 6.3.1.9.3.1-1.
- The PLMNs are identified in the test by the identifiers in Table 6.3.1.9.3.1-1. The MCC and MNC values of PLMN identifiers are specified in TS 36.523-1 [13], Table 6.0.1-1.

Table 6.3.1.9.3.1-1: PLMN identifiers

NR Cell	PLMN names
NR Cell 11	PLMN2
NR Cell 12	PLMN13

NR Cell 11 is set to "Serving Cell";

NR Cell 12 is set to "Serving Cell";

-System Information Combination NR-4 as defined in TS38.508 clause 4.4.3.1.3 is used in NR cells

UE:

- The UE is in Manual PLMN selection mode.
- USIM configuration as defined in Table 6.4.1-21 of TS 38.508-1 [4] will be used.

Preamble:

- The UE is in Switched OFF (State 0-A) as defined in TS 38.508-1 [4] Table 4.4A.2-0.
- UE's Last Registered PLMN (RPLMN) needs to be cleared by using Registration Reject procedure as defined in TS 38.508-1 [4] Subclause 4.9.8.

6.3.1.9.4 Test procedure sequence

Table 6.3.1.9.4-1: Main behaviour

St	Procedure	Message Sequence		TP	Verdict
		U - S	Message		
1	Power on the UE.	-	-	-	-
2	PLMN13 is manually selected.	-	-	-	-
3	Whole registration procedure described in TS 38.508-1 [4] Table 4.5.2.2-2 are performed on NR Cell 12, with "connected without release".	-	-	-	-
4	The SS transmits an DLInformationTransfer message containing steering of roaming information indicating list of preferred PLMN/access technology combination provided with acknowledgment requested from the UE for successful reception.	<-	NR RRC: <i>DLInformationTransfer</i> 5GMM: DL NAS TRANSPORT	-	-
5	The UE transmits an ULInformationTransfer message carrying acknowledgement of successful reception of the steering of roaming information.	-->	NR RRC: <i>ULInformationTransfer</i> 5GMM:UL NAS TRANSPORT	1	P
6	The SS transmits an <i>RRCRelease</i> message.	<-	NR RRC: <i>RRCRelease</i>	-	-
7	SS starts timer of 1 minute and waits this timer expires.	-	-	-	-
8	Check: Does the UE is in state 5GC RRC_IDLE on NR Cell 12 as specified in TS 38.508-1 [4] Table 4.9.4.2.2-1?	-	-	1	P
9	The SS configures: - NR Cell 11 as a "Non-Suitable "off" cell ".	-	-	-	-
10	The user sets the UE in Automatic PLMN selection mode.	-	-	-	-

6.3.1.9.5 Specific message contents

Table 6.3.1.9.5-1: DL NAS TRANSPORT Message for NR Cell 12 (step 4, Table 6.3.1.9.4-1)

Derivation Path: TS 38.508-1 [4] Table 4.7.1-11			
Information Element	Value/remark	Comment	Condition
Payload Container	Present	The SOR transparent container in the payload container IE carries steering of roaming information.	

Table 6.3.1.9.5-2: SoR Transparent Container in Payload Container IE of DL NAS TRANSPORT Message for NR Cell 12 (step 4, Table 6.3.1.9.4-1)

Derivation Path: TS 24.501 [22] Figure 9.11.3.51.1			
Information Element	Value/remark	Comment	Condition
SoR-MAC-I _{AUS}	Set to match the calculated SoR-MAC-I _{AUS} as the way defined in TS 33.501 A.17		
Counter _{SoR}	Value generated as per TS 33.501 Cl 6.14.2.3		
SoR data type	0	The SoR transparent container carries steering of roaming information.	
List indication value	1	List of preferred PLMN/access technology combinations is provided	
List type	1	The list type is a PLMN ID and access technology list	
Acknowledgement (ACK) value	1	Acknowledgement requested	
PLMN ID 1	PLMN2		
Access Technology Identifier 1	NG-RAN		

Table 6.3.1.9.5-3: UL NAS TRANSPORT Message for NR Cell 12 (step 5, Table 6.3.1.9.4-1)

Derivation Path: TS 38.508-1 [4] Table 4.7.1-10			
Information Element	Value/remark	Comment	Condition
Payload Container	Present	The SoR transparent container in the payload container IE carries acknowledgement of successful reception of the steering of roaming information.	

Table 6.3.1.9.5-4: SoR Transparent Container in Payload Container IE of UL NAS TRANSPORT Message for NR Cell 12 (step 5, Table 6.3.1.9.4-1)

Derivation Path: TS 24.501 [22] Figure 9.11.3.51.4			
Information Element	Value/remark	Comment	Condition
SoR data type	1	The SoR transparent container carries acknowledgement of successful reception of the steering of roaming information.	

6.4 UE Procedures in RRC_INACTIVE state

6.4.1 NG-RAN Only PLMN Selection in RRC_INACTIVE state

6.4.1.1 PLMN Selection/Higher priority/HPLMN in Automatic PLMN Selection Mode

6.4.1.1.1 Test Purpose (TP)

(1)

```
with { UE in NR RRC_INACTIVE state on an NG-RAN VPLMN cell }
ensure that {
  when { UE performs PLMN Selection to a PLMN that is equivalent PLMN of the registered PLMN }
  then { UE remains in RRC_INACTIVE state after moving to the Equivalent PLMN cell. }
}
```

(2)

```
with { UE in NR RRC_INACTIVE state on an NG-RAN VPLMN cell and cells of a higher priority NG-RAN
PLMN available }
ensure that {
  when { Higher priority PLMN search timer T expires }
  then { UE selects the higher priority PLMN cell, moves to RRC_IDLE and attempts Registration
with mobility on the selected cell. }
}
```

6.4.1.1.2 Conformance requirements

References: The conformance requirements covered in the current TC are specified in: TS 23.122 clauses 4.4.3.3, TS 38.304 clauses 4.1 and clauses 4.2 and TS 24.501 clauses 5.3.1.4. Unless otherwise stated these are Rel-15 requirements.

[TS 23.122, clause 4.4.3.3]

If the MS is in a VPLMN, the MS shall periodically attempt to obtain service on its HPLMN (if the EHPLMN list is not present or is empty) or one of its EHPLMNs (if the EHPLMN list is present) or a higher priority PLMN/access technology combinations listed in "user controlled PLMN selector" or "operator controlled PLMN selector" by scanning in accordance with the requirements that are applicable to i), ii) and iii) as defined in the Automatic Network Selection Mode in subclause 4.4.3.1.1. In the case that the mobile has a stored "Equivalent PLMNs" list the mobile shall only select a PLMN if it is of a higher priority than those of the same country as the current serving PLMN which are stored in the "Equivalent PLMNs" list. For this purpose, a value of timer T may be stored in the SIM. The interpretation of the stored value depends on the radio capabilities supported by the MS:

- For an MS that does not support any of the following: EC-GSM-IoT, Category M1 or Category NB1 (as defined in 3GPP TS 36.306 [54]), T is either in the range 6 minutes to 8 hours in 6 minute steps or it indicates that no periodic attempts shall be made. If no value for T is stored in the SIM, a default value of 60 minutes is used for T.
- For an MS that only supports any of the following or a combination of: EC-GSM-IoT, Category M1 or Category NB1 (as defined in 3GPP TS 36.306 [54]), T is either in the range 2 hours to 240 hours, using 2 hour steps from 2 hours to 80 hours and 4 hour steps from 84 hours to 240 hours, or it indicates that no periodic attempts shall be made. If no value for T is stored in the SIM, a default value of 72 hours is used.
- For an MS that supports both:
 - a) any of the following or a combination of: EC-GSM-IoT, Category M1 or Category NB1 (as defined in 3GPP TS 36.306 [54]); and
 - b) any access technology other than the following: EC-GSM-IoT, Category M1 or Category NB1 (as defined in 3GPP TS 36.306 [54]),

then T is interpreted depending on the access technology in use as specified below:

- 1) if the MS is using any of the following at the time of starting timer T: EC-GSM-IoT, Category M1 or Category NB1 (as defined in 3GPP TS 36.306 [54]), T is either in the range 2 hours to 240 hours, using 2 hour steps from 2 hours to 80 hours and 4 hour steps from 84 hours to 240 hours, or it indicates that no periodic attempts shall be made. If no value for T is stored in the SIM, a default value of 72 hours is used; and
- 2) if the MS is not using any of the following at the time of starting timer T: EC-GSM-IoT, Category M1 or Category NB1 (as defined in 3GPP TS 36.306 [54]), T is either in the range 6 minutes to 8 hours in 6 minute steps or it indicates that no periodic attempts shall be made. If no value for T is stored in the SIM, a default value of 60 minutes is use

for T.

If the MS is configured with the `MinimumPeriodicSearchTimer` as specified in 3GPP TS 24.368 [50] or 3GPP TS 31.102 [40], the MS shall not use a value for T that is less than the `MinimumPeriodicSearchTimer`. If the value stored in the SIM, or the default value for T (when no value is stored in the SIM), is less than the `MinimumPeriodicSearchTimer`, then T shall be set to the `MinimumPeriodicSearchTimer`.

The MS does not stop timer T, as described in 3GPP TS 24.008 [23] and 3GPP TS 24.301 [23A], when it activates power saving mode (PSM) (see 3GPP TS 23.682 [27A]).

The MS can be configured for Fast First Higher Priority PLMN search as specified in 3GPP TS 31.102 [40] or 3GPP TS 24.368 [50]. Fast First Higher Priority PLMN search is enabled if the corresponding configuration parameter is present and set to enabled. Otherwise, Fast First Higher Priority PLMN search is disabled.

The attempts to access the HPLMN or an EHPLMN or higher priority PLMN shall be as specified below:

- a) The periodic attempts shall only be performed in automatic mode when the MS is roaming, and not while the MS is attached for emergency bearer services, is registered for emergency services, has a PDU session for emergency services or has a PDN connection for emergency bearer services;
- b) The MS shall make the first attempt after a period of at least 2 minutes and at most T minutes:
 - only after switch on if Fast First Higher Priority PLMN search is disabled; or
 - after switch on or upon selecting a VPLMN if Fast First Higher Priority PLMN search is enabled.
- c) The MS shall make the following attempts if the MS is on the VPLMN at time T after the last attempt;
- d) Periodic attempts shall only be performed by the MS while in idle mode;
- d1) Periodic attempts may be postponed while the MS is in power saving mode (PSM) (see 3GPP TS 23.682 [27A]).
- d2) Periodic attempts may be postponed while the MS is receiving eMBMS transport service in idle mode (see 3GPP TS 23.246 [68]).
- e) If the HPLMN (if the EHPLMN list is not present or is empty) or a EHPLMN (if the list is present) or a higher priority PLMN is not found, the MS shall remain on the VPLMN.
- f) In steps i), ii) and iii) of subclause 4.4.3.1.1 the MS shall limit its attempts to access higher priority PLMN/access technology combinations to PLMN/access technology combinations of the same country as the current serving VPLMN, as defined in Annex B.
- g) Only the priority levels of Equivalent PLMNs of the same country as the current serving VPLMN, as defined in Annex B, shall be taken into account to compare with the priority level of a selected PLMN.
- h) If the PLMN of the highest priority PLMN/access technology combination available is the current VPLMN, or one of the PLMNs in the "Equivalent PLMNs" list, the MS shall remain on the current PLMN/access technology combination.

[TS 38.304, clause 4.1]

The `RRC_IDLE` state and `RRC_INACTIVE` state tasks can be subdivided into three processes:

- PLMN selection;

- Cell selection and reselection;
- Location registration and RNA update.

PLMN selection, cell reselection procedures, and location registration are common for both RRC_IDLE state and RRC_INACTIVE state. RNA update is only applicable for RRC_INACTIVE state. When UE selects a new PLMN, UE transitions from RRC_INACTIVE to RRC_IDLE, as specified in TS 24.501 [14].

When a UE is switched on, a public land mobile network (PLMN) is selected by NAS. For the selected PLMN, associated RAT(s) may be set, as specified in TS 23.122 [9]. The NAS shall provide a list of equivalent PLMNs, if available, that the AS shall use for cell selection and cell reselection.

With cell selection, the UE searches for a suitable cell of the selected PLMN, chooses that cell to provide available services, and monitors its control channel. This procedure is defined as "camping on the cell".

The UE shall, if necessary, then register its presence, by means of a NAS registration procedure, in the tracking area of the chosen cell. As an outcome of a successful Location Registration, the selected PLMN then becomes the registered PLMN, as specified in TS 23.122 [9].

If the UE finds a more suitable cell, according to the cell reselection criteria, it reselects onto that cell and camps on it. If the new cell does not belong to at least one tracking area to which the UE is registered, location registration is performed. In RRC_INACTIVE state, if the new cell does not belong to the configured RNA, an RNA update procedure is performed.

If necessary, the UE shall search for higher priority PLMNs at regular time intervals as described in TS 23.122 [9] and search for a suitable cell if another PLMN has been selected by NAS.

If the UE loses coverage of the registered PLMN, either a new PLMN is selected automatically (automatic mode), or an indication of available PLMNs is given to the user so that a manual selection can be performed (manual mode).

Registration is not performed by UEs only capable of services that need no registration.

The purpose of camping on a cell in RRC_IDLE state and RRC_INACTIVE state is fourfold:

- a) It enables the UE to receive system information from the PLMN.
- b) When registered and if the UE wishes to establish an RRC connection or resume a suspended RRC connection, it can do this by initially accessing the network on the control channel of the cell on which it is camped.
- c) If the network needs to send a message or deliver data to the registered UE, it knows (in most cases) the set of tracking areas (in RRC_IDLE state) or RNA (in RRC_INACTIVE state) in which the UE is camped. It can then send a "paging" message for the UE on the control channels of all the cells in the corresponding set of areas. The UE will then receive the paging message and can respond.
- d) It enables the UE to receive ETWS and CMAS notifications.

When the UE is in RRC_IDLE state, upper layers may deactivate AS layer when MICO mode is activated as specified in TS 24.501 [14]. When MICO mode is activated, the AS configuration (e.g. priorities provided by dedicated signalling) is kept and all running timers continue to run but the UE need not perform any idle mode tasks. If a timer expires while MICO mode is activated it is up to the UE implementation whether it performs the corresponding action immediately or the latest when MICO mode is deactivated. When MICO mode is deactivated, the UE shall perform all idle mode tasks.

[TS 38.304, clause 4.2]

Table 4.2-1 presents the functional division between UE non-access stratum (NAS) and UE access stratum (AS) in RRC_IDLE state and RRC_INACTIVE states. The NAS part is specified in TS 23.122 [9] and the AS part in the present document.

Table 4.2-1: Functional division between AS and NAS in RRC_IDLE state and RRC_INACTIVE state

RRC_IDLE and RRC_INACTIVE state Process	UE Non-Access Stratum	UE Access Stratum
PLMN Selection	<p>Maintain a list of PLMNs in priority order according to TS 23.122 [9]. Select a PLMN using automatic or manual mode as specified in TS 23.122 [9] and request AS to select a cell belonging to this PLMN. For each PLMN, associated RAT(s) may be set.</p> <p>Evaluate reports of available PLMNs from AS for PLMN selection.</p> <p>Maintain a list of equivalent PLMN identities.</p>	<p>Search for available PLMNs.</p> <p>If associated RAT(s) is (are) set for the PLMN, search in this (these) RAT(s) and other RAT(s) for that PLMN as specified in TS 23.122 [9].</p> <p>Perform measurements to support PLMN selection.</p> <p>Synchronise to a broadcast channel to identify found PLMNs.</p> <p>Report available PLMNs with associated RAT(s) to NAS on request from NAS or autonomously.</p>
Cell Selection	<p>Control cell selection for example by indicating RAT(s) associated with the selected PLMN to be used initially in the search of a cell in the cell selection.</p> <p>Maintain a list of "Forbidden Tracking Areas" and provide the list to AS.</p>	<p>Perform measurements needed to support cell selection.</p> <p>Detect and synchronise to a broadcast channel. Receive and handle broadcast information. Forward NAS system information to NAS.</p> <p>Search for a suitable cell. The cells broadcast one or more 'PLMN identity' in the system information. Respond to NAS whether such cell is found or not.</p> <p>If associated RATs is (are) set for the PLMN, perform the search in this (these) RAT(s) and other RATs for that PLMN as specified in TS 23.122 [9].</p> <p>If a cell is found which satisfies cell selection criteria, camp on that cell.</p>
Cell Reselection	<p>Maintain a list of equivalent PLMN identities and provide the list to AS.</p> <p>Maintain a list of "Forbidden Tracking Areas" and provide the list to AS.</p>	<p>Perform measurements needed to support cell reselection.</p> <p>Detect and synchronise to a broadcast channel. Receive and handle broadcast information. Forward NAS system information to NAS.</p> <p>Change cell if a more suitable cell is found.</p>
Location registration	<p>Register the UE as active after power on.</p> <p>Register the UE's presence in a registration area, for instance regularly or when entering a new tracking area.</p> <p>Deregister UE when shutting down.</p> <p>Maintain a list of "Forbidden Tracking Areas".</p>	<p>Report registration area information to NAS.</p>
RAN Notification Area Update	<p>Not applicable.</p>	<p>Register the UE's presence in a RAN-based notification area (RNA), periodically or when entering a new RNA.</p>

[TS 24.501, clause 5.3.1.4]

This subclause is only applicable for UE's 5GMM mode over 3GPP access.

The UE is in 5GMM-CONNECTED mode with RRC inactive indication when the UE is in:

- a) 5GMM-CONNECTED mode over 3GPP access at the NAS layer; and
- b) RRC_INACTIVE state at the AS layer (see 3GPP TS 38.300 [27]).

Unless stated otherwise, the UE behaviour in 5GMM-CONNECTED mode with RRC inactive indication follows the UE behaviour in 5GMM-CONNECTED over 3GPP access, except that:

- a) the UE shall apply the mobility restrictions; and
- b) the UE shall perform the PLMN selection procedures as in 5GMM-IDLE mode over 3GPP access.

The UE shall transition from 5GMM-CONNECTED mode over 3GPP access to 5GMM-CONNECTED mode with RRC inactive indication upon receiving an indication from the lower layers that the UE has transitioned to RRC_INACTIVE state.

...

The UE shall trigger a transition from 5GMM-CONNECTED mode with RRC inactive indication to 5GMM-IDLE mode upon selection of a PLMN that is not an equivalent PLMN to the registered PLMN. The UE shall not trigger a transition from 5GMM-CONNECTED mode with RRC inactive indication to 5GMM-IDLE mode upon entering a new PLMN which is in the list of equivalent PLMNs.

6.4.1.1.3 Test description

6.4.1.1.3.1 Pre-test conditions

System Simulator:

- NR Cell 12, NR Cell 13 and NR Cell 1 are configured according to TS 38.508-1 [4], Table 4.4.2-3.
- The PLMNs are identified in the test by the identifiers in Table 6.4.1.1.3.1-1 and the PLMN settings are defined in TS 36.523-1 [13] table 6.0.1-1..

Table 6.4.1.1.3.1–1: PLMN identifiers

NR Cell	PLMN name
12	PLMN15
13	PLMN16
1	PLMN1

- System information combination NR-4 as defined in TS 38.508-1 [4] clause 4.4.3.1.2-1 is used in NR cells.

UE:

- The UE is in Automatic PLMN selection mode.
- USIM configuration as defined in TS 38.508-1 [4] Table 6.4.1-1 will be loaded. The high priority PLMN search timer T defined by EF_{HPLMN} is 6min.

Preamble:

- The UE is registered on NR Cell 12 except that the REGISTRATION ACCEPT message indicates the PLMN of NR Cell 13 in the Equivalent PLMN list as described in Table 6.4.1.1.3.3-3.
- The UE is in state 2N-A as defined in TS 38.508-1 [4], Table 4.4A.2-2 on NR Cell 12.

6.4.1.1.3.2 Test procedure sequence

Table 6.4.1.1.3.2-1 for FR1 and Table 6.4.1.1.3.2-2 for FR2 illustrates the downlink power levels and other changing parameters to be applied for the cells at various time instants of the test execution. Row marked "T0" denotes the initial conditions after preamble, while column marked "T1" is to be applied subsequently in the Main behaviour. The exact instants on which these values shall be applied are described in the texts in this clause.

Table 6.4.1.1.3.2-1: Cell configuration changes over time for FR1

	Parameter	Unit	NR Cell 12	NR Cell 13	NR Cell 1	Remarks
T0	SS/PBCH SSS EPRE	dBm/SCS	-115	-78	"Off"	Power level "Off" is defined in TS 38.508-1 [4] Table 6.2.2.1-3
T1	SS/PBCH SSS EPRE	dBm/SCS	"Off"	-88	-88	Power level "Off" is defined in TS 38.508-1 [4] Table 6.2.2.1-3

Table 6.4.1.1.3.2-2: Cell configuration changes over time for FR2

	Parameter	Unit	NR Cell 12	NR Cell 13	NR Cell 1	Remarks
T0	SS/PBCH SSS EPRE	dBm/SCS	FFS	FFS	"Off"	Power level "Off" is defined in TS 38.508-1 [4] Table 6.2.2.2-2
T1	SS/PBCH SSS EPRE	dBm/SCS	"Off"	FFS	FFS	Power level "Off" is defined in TS 38.508-1 [4] Table 6.2.2.2-2

Table 6.4.1.1.3.2-3: Main behaviour

St	Procedure	Message Sequence		TP	Verdict
		U - S	Message		
1	SS adjusts cell levels according to row T0 of table 6.4.1.1.3.2-1/2.	-	-	-	-
2	Check: Does the UE transmit an <i>RRCResumeRequest</i> message on NR Cell 13?	-	NR RRC: <i>RRCResumeRequest</i>	1	P
3	The SS transmits an <i>RRCResume</i> message.	<--	NR RRC: <i>RRCResume</i>	-	-
4	The UE transmits an <i>RRCResumeComplete</i> message and a REGISTRATION REQUEST message indicating "mobility registration updating" is sent to update the registration of NR Cell13.	-->	NR RRC: <i>RRCResumComplete</i> 5GMM: REGISTRATION REQUEST	-	-
4A-4B	Steps 4 to 5 of the generic test procedure in TS 38.508-1 [4] Table 4.9.5.2.2-1 with condition MOBILITY are performed.	-	-	-	-
5	The SS transmits an <i>RRCRelease</i> message with suspend.	<--	NR RRC: <i>RRCRelease</i>	-	-
6	SS starts timers of tmin = 2min and tmax = (6 min + 5min) (Note 1).	-	-	-	-
7	The SS transmits a <i>Paging</i> message including a matched identity (correct <i>fullI-RNTI</i>) on NR Cell 13.	<--	NR RRC: <i>Paging</i>	-	-
8	Check: Does the UE transmit an <i>RRCResumeRequest</i> message to resume RRC Connection by setting <i>resumIdentity</i> to the stored <i>shortI-RNTI</i> value on NR Cell 13?	-->	NR RRC: <i>RRCResumeRequest</i>	1	P
9	The SS transmits an <i>RRCResume</i> message.	<--	NR RRC: <i>RRCResume</i>	-	-
10	The UE transmits an <i>RRCResumeComplete</i> message.	-->	NR RRC: <i>RRCResumeComplete</i>	-	-
11	The SS transmits an <i>RRCRelease</i> message with suspend.	<--	NR RRC: <i>RRCRelease</i>	-	-
12	SS adjusts cell levels according to row T1 of table 6.4.1.1.3.2-1/2.	-	-	-	-
13	Check: Does the UE send an <i>RRCSetupRequest</i> message on NR Cell 1 after tmin expires but before tmax expires (Note 1)?	-->	NR RRC: <i>RRCSetupRequest</i>	2	P
14	Steps 3-4 of Table 4.5.2.2-2 of the generic procedure in TS 38.508-1 [4] are performed	-	-	2	P
-	EXCEPTION: Steps 14a1 to 14b5a1 describe behaviours which depend on procedure parameters; the "lower case letter" identifies a step sequence that take place if a procedure parameter has a particular value.	-	-	-	-
14a1-14a16a1	IF 5GS registration type is set as Initial Registration in step 14, THEN steps 5 to 20a1 of the registration procedure described in TS 38.508-1 [4] Table 4.5.2.2-2 are performed on NR Cell 1. Note 2	-	-	-	-
14b1-14b5a1	ELSE IF 5GS registration type is set as Mobility Registration in step 14, THEN steps 4 to 6a1 of the generic test procedure in TS 38.508-1 [4] Table 4.9.5.2.2-1 are performed on NR Cell 1. Note 2	-	-	-	-
Note 1:	Following attempts to access the HPLMN/EHPLMN/higher priority PLMN in VPLMN is operator specific setting (Refer to TS 23.122 [38] Rel-15).Hence, window between 2min to T+Tolerance is being used, where the high priority PLMN search timer T defined by EF _{HPPLMN} . Tolerance of 5min is added to allow time for the UE to find the proper PLMN.				
Note 2:	The 5GS registration type shall be only set as Mobility Registration for R16 UEs according to TS 24.501 [22] subclause 5.2.3.2.5 specified in Release 16. The EXCEPTION description applies only to R15 UEs.				

6.4.1.1.3.3 Specific message contents

Table 6.4.1.1.3.3-1: SIB4 for NR Cell 12 (preamble and all steps, Table 6.4.1.1.3.2-3)

Derivation path: TS 38.508-1 [4], Table 4.6.2-3			
Information Element	Value/Remark	Comment	Condition
SIB4 ::= SEQUENCE {			
interFreqCarrierFreqList SEQUENCE (SIZE (1..maxFreq)) OF InterFreqCarrierFreqInfo {	2 entries		
InterFreqCarrierFreqInfo[1] SEQUENCE {		entry 1	
dl-CarrierFreq	Same downlink NR ARFCN as used for NR Cell 13		
cellReselectionPriority	4		
}			
InterFreqCarrierFreqInfo[2] SEQUENCE {		entry 2	
dl-CarrierFreq	Same downlink NR ARFCN as used for NR Cell 1		
cellReselectionPriority	4		
}			
}			
}			

Table 6.4.1.1.3.3-2: SIB4 for NR Cell 13 (preamble and all steps, Table 6.4.1.1.3.2-3)

Derivation path: TS 38.508-1 [4], Table 4.6.2-3			
Information Element	Value/Remark	Comment	Condition
SIB4 ::= SEQUENCE {			
interFreqCarrierFreqList SEQUENCE (SIZE (1..maxFreq)) OF InterFreqCarrierFreqInfo {	2 entries		
InterFreqCarrierFreqInfo[1] SEQUENCE {		entry 1	
dl-CarrierFreq	Same downlink NR ARFCN as used for NR Cell 12		
cellReselectionPriority	4		
}			
InterFreqCarrierFreqInfo[2] SEQUENCE {		entry 2	
dl-CarrierFreq	Same downlink NR ARFCN as used for NR Cell 1		
cellReselectionPriority	4		
}			
}			
}			

Table 6.4.1.1.3.3-3: REGISTRATION ACCEPT for NR Cell 12 (preamble)

Derivation path: TS 38.508-1 [4], Table 4.7.1-7			
Information Element	Value/Remark	Comment	Condition
Equivalent PLMNs	PLMN16		

6.4.1.2 Cell reselection of ePLMN in manual mode

6.4.1.2.1 Test Purpose (TP)

(1)

```

with { UE in NR RRC_INACTIVE state on a NR cell in manual PLMN Selection mode and network has
downloaded a list of equivalent PLMNs during the Registration procedure }
ensure that {
  when { Higher ranked cell is a cell of a PLMN in the downloaded equivalent PLMN list }

```

```

    then { UE reselects to the equivalent PLMN cell , and attempts Registration with mobility on the
    selected cell. }
    }

```

(2)

```

with { UE in NR RRC_INACTIVE state on a cell and network has downloaded a list of equivalent PLMNs
during Registration procedure for mobility }
ensure that {
    when { Highest ranked cell is a cell of a PLMN not in the downloaded equivalent PLMN list }
    then { UE does not reselect to the cell. }
}

```

6.4.1.2.2 Conformance requirements

References: The conformance requirements covered in the current TC are specified in: TS 23.122 clauses 4.4.3.1.2 and TS 38.304, clauses 4.1 and clauses 4.2. Unless otherwise stated these are Rel-15 requirements.

[TS 23.122, clause 4.4.3.1.2]

The MS indicates whether there are any PLMNs, which are available using all supported access technologies. This includes PLMNs in the "forbidden PLMNs" list, "forbidden PLMNs for GPRS service" list and PLMNs which only offer services not supported by the MS. An MS which supports GSM COMPACT shall also indicate GSM COMPACT PLMNs (which use PBCCH).

If displayed, PLMNs meeting the criteria above are presented in the following order:

- i)- either the HPLMN (if the EHPLMN list is not present or is empty) or, if one or more of the EHPLMNs are available then based on an optional data field on the SIM either only the highest priority available EHPLMN is to be presented to the user or all available EHPLMNs are presented to the user in priority order. If the data field is not present on the SIM, then only the highest priority available EHPLMN is presented;
- ii)- PLMN/access technology combinations contained in the " User Controlled PLMN Selector with Access Technology " data file in the SIM (in priority order);
- iii)- PLMN/access technology combinations contained in the "Operator Controlled PLMN Selector with Access Technology" data file in the SIM (in priority order);
- iv)- other PLMN/access technology combinations with received high quality signal in random order;
- v)- other PLMN/access technology combinations in order of decreasing signal quality.

In ii and iii, an MS using a SIM without access technology information storage (i.e. the "User Controlled PLMN Selector with Access Technology" and the "Operator Controlled PLMN Selector with Access Technology" data files are not present) shall instead present the PLMNs contained in the "PLMN Selector" data file in the SIM (in priority order).

In v, requirement h) in subclause 4.4.3.1.1 applies.

In i to v, requirements j), k) and l) in subclause 4.4.3.1.1 apply.

In GSM COMPACT, the non support of voice services shall be indicated to the user.

The HPLMN may provide on the SIM additional information on the available PLMNs. If this information is provided then the MS shall indicate it to the user. This information, provided as free text may include:

- preferred partner,
- roaming agreement status,
- supported services

Furthermore, the MS may indicate whether the available PLMNs are present on the EHPLMN list, the Forbidden list, the User Controlled PLMN List or the Operator Controlled PLMN List. The MS may also indicate that the PLMN is not present on any of these lists.

The user may select his desired PLMN and the MS then initiates registration on this PLMN using the access technology chosen by the user for that PLMN or using the highest priority available access technology for that PLMN, if the

associated access technologies have a priority order. (This may take place at any time during the presentation of PLMNs). For such a registration, the MS shall ignore the contents of the "forbidden location areas for roaming", "forbidden tracking areas for roaming", "5GS forbidden tracking areas for roaming", "forbidden location areas for regional provision of service", "forbidden tracking areas for regional provision of service", "5GS forbidden tracking areas for regional provision of service", "forbidden PLMNs for GPRS service" and "forbidden PLMNs" lists.

NOTE 1: It is an MS implementation option whether to indicate access technologies to the user. If the MS does display access technologies, then the access technology selected by the user is only used for initial registration on the selected PLMN. If the MS does not display access technologies, then the access technology chosen for a particular PLMN should be the highest priority available access technology for that PLMN, if the associated access technologies have a priority order, and is only used for initial registration.

Once the MS has registered on a PLMN selected by the user, the MS shall not automatically register on a different PLMN unless:

- i) the new PLMN is declared as an equivalent PLMN by the registered PLMN;
- ii) the user selects automatic mode;
- iii) the user initiates an emergency call while the MS is in limited service state and either the network does not broadcast the indication of support of emergency calls in limited service state, the registration request for emergency services is rejected by the network or the attach request for emergency bearer services is rejected by the network; or
- iv) the user initiates access to RLOS, while the MS is in limited service state and either the network does not broadcast the indication of support of RLOS in limited service state, or the EPS attach request for access to RLOS is rejected by the network.

NOTE 2: If case iii) or iv) occurs, the MS can provide an indication to the upper layers that the MS has exited manual network selection mode.

If the user does not select a PLMN, the selected PLMN shall be the one that was selected before the PLMN selection procedure started. If no such PLMN was selected or that PLMN is no longer available, then the MS shall attempt to camp on any acceptable cell and enter the limited service state.

NOTE 3: High quality signal is defined in the appropriate AS specification.

[TS 38.304, clause 4.1]

The RRC_IDLE state and RRC_INACTIVE state tasks can be subdivided into three processes:

- PLMN selection;
- Cell selection and reselection;
- Location registration and RNA update.

PLMN selection, cell reselection procedures, and location registration are common for both RRC_IDLE state and RRC_INACTIVE state. RNA update is only applicable for RRC_INACTIVE state. When UE selects a new PLMN, UE transitions from RRC_INACTIVE to RRC_IDLE, as specified in TS 24.501 [14].

When a UE is switched on, a public land mobile network (PLMN) is selected by NAS. For the selected PLMN, associated RAT(s) may be set, as specified in TS 23.122 [9]. The NAS shall provide a list of equivalent PLMNs, if available, that the AS shall use for cell selection and cell reselection.

With cell selection, the UE searches for a suitable cell of the selected PLMN, chooses that cell to provide available services, and monitors its control channel. This procedure is defined as "camping on the cell".

The UE shall, if necessary, then register its presence, by means of a NAS registration procedure, in the tracking area of the chosen cell. As an outcome of a successful Location Registration, the selected PLMN then becomes the registered PLMN, as specified in TS 23.122 [9].

If the UE finds a more suitable cell, according to the cell reselection criteria, it reselects onto that cell and camps on it. If the new cell does not belong to at least one tracking area to which the UE is registered, location registration is

performed. In RRC_INACTIVE state, if the new cell does not belong to the configured RNA, an RNA update procedure is performed.

If necessary, the UE shall search for higher priority PLMNs at regular time intervals as described in TS 23.122 [9] and search for a suitable cell if another PLMN has been selected by NAS.

If the UE loses coverage of the registered PLMN, either a new PLMN is selected automatically (automatic mode), or an indication of available PLMNs is given to the user so that a manual selection can be performed (manual mode).

Registration is not performed by UEs only capable of services that need no registration.

The purpose of camping on a cell in RRC_IDLE state and RRC_INACTIVE state is fourfold:

- a) It enables the UE to receive system information from the PLMN.
- b) When registered and if the UE wishes to establish an RRC connection or resume a suspended RRC connection, it can do this by initially accessing the network on the control channel of the cell on which it is camped.
- c) If the network needs to send a message or deliver data to the registered UE, it knows (in most cases) the set of tracking areas (in RRC_IDLE state) or RNA (in RRC_INACTIVE state) in which the UE is camped. It can then send a "paging" message for the UE on the control channels of all the cells in the corresponding set of areas. The UE will then receive the paging message and can respond.
- d) It enables the UE to receive ETWS and CMAS notifications.

When the UE is in RRC_IDLE state, upper layers may deactivate AS layer when MICO mode is activated as specified in TS 24.501 [14]. When MICO mode is activated, the AS configuration (e.g. priorities provided by dedicated signalling) is kept and all running timers continue to run but the UE need not perform any idle mode tasks. If a timer expires while MICO mode is activated it is up to the UE implementation whether it performs the corresponding action immediately or the latest when MICO mode is deactivated. When MICO mode is deactivated, the UE shall perform all idle mode tasks.

[TS 38.304, clause 4.2]

Table 4.2-1 presents the functional division between UE non-access stratum (NAS) and UE access stratum (AS) in RRC_IDLE state and RRC_INACTIVE states. The NAS part is specified in TS 23.122 [9] and the AS part in the present document.

Table 4.2-1: Functional division between AS and NAS in RRC_IDLE state and RRC_INACTIVE state

RRC_IDLE and RRC_INACTIVE state Process	UE Non-Access Stratum	UE Access Stratum
PLMN Selection	<p>Maintain a list of PLMNs in priority order according to TS 23.122 [9]. Select a PLMN using automatic or manual mode as specified in TS 23.122 [9] and request AS to select a cell belonging to this PLMN. For each PLMN, associated RAT(s) may be set.</p> <p>Evaluate reports of available PLMNs from AS for PLMN selection.</p> <p>Maintain a list of equivalent PLMN identities.</p>	<p>Search for available PLMNs.</p> <p>If associated RAT(s) is (are) set for the PLMN, search in this (these) RAT(s) and other RAT(s) for that PLMN as specified in TS 23.122 [9].</p> <p>Perform measurements to support PLMN selection.</p> <p>Synchronise to a broadcast channel to identify found PLMNs.</p> <p>Report available PLMNs with associated RAT(s) to NAS on request from NAS or autonomously.</p>
Cell Selection	<p>Control cell selection for example by indicating RAT(s) associated with the selected PLMN to be used initially in the search of a cell in the cell selection.</p> <p>Maintain a list of "Forbidden Tracking Areas" and provide the list to AS.</p>	<p>Perform measurements needed to support cell selection.</p> <p>Detect and synchronise to a broadcast channel. Receive and handle broadcast information. Forward NAS system information to NAS.</p> <p>Search for a suitable cell. The cells broadcast one or more 'PLMN identity' in the system information. Respond to NAS whether such cell is found or not.</p> <p>If associated RATs is (are) set for the PLMN, perform the search in this (these) RAT(s) and other RATs for that PLMN as specified in TS 23.122 [9].</p> <p>If a cell is found which satisfies cell selection criteria, camp on that cell.</p>
Cell Reselection	<p>Maintain a list of equivalent PLMN identities and provide the list to AS.</p> <p>Maintain a list of "Forbidden Tracking Areas" and provide the list to AS.</p>	<p>Perform measurements needed to support cell reselection.</p> <p>Detect and synchronise to a broadcast channel. Receive and handle broadcast information. Forward NAS system information to NAS.</p> <p>Change cell if a more suitable cell is found.</p>
Location registration	<p>Register the UE as active after power on.</p> <p>Register the UE's presence in a registration area, for instance regularly or when entering a new tracking area.</p> <p>Deregister UE when shutting down.</p> <p>Maintain a list of "Forbidden Tracking Areas".</p>	<p>Report registration area information to NAS.</p>
RAN Notification Area Update	<p>Not applicable.</p>	<p>Register the UE's presence in a RAN-based notification area (RNA), periodically or when entering a new RNA.</p>

6.4.1.2.3 Test description

6.4.1.2.3.1 Pre-test conditions

System Simulator:

- NR Cell 1, NR Cell 12 and NR Cell 13 are configured according to TS 38.508-1, Table 4.4.2-3.
- System information combination NR-4 as defined in TS 38.508-1 [4] clause 4.4.3.1.2-1 is used in NR cell 1 and NR cell 12.
- System information combination NR-1 as defined in TS 38.508-1 [4] clause 4.4.3.1.2-1 is used in NR cell 13.

UE:

- The UE is in Manual PLMN selection mode.

Preamble:

- The UE is registered on NR Cell 1 except that the REGISTRATION ACCEPT message indicates the PLMN of NR Cell 12 in the Equivalent PLMN list as described in Table 6.4.1.2.3.3-4.
- The UE is in state 2N-A as defined in TS 38.508-1 [4], Table 4.4A.2-2 on NR Cell 1.

6.4.1.2.3.2 Test procedure sequence

Table 6.4.1.2.3.2-1 for FR1 and Table 6.4.1.2.3.2-2 for FR2 illustrates the downlink power levels and other changing parameters to be applied for the cells at various time instants of the test execution. Row marked "T0" denotes the initial conditions after preamble, while columns marked "T1", "T2" and "T3" are to be applied subsequently in the Main behaviour. The exact instants on which these values shall be applied are described in the texts in this clause.

Table 6.4.1.2.3.2-1: Cell configuration changes over time for FR1

	Parameter	Unit	NR Cell 1	NR Cell 12	NR Cell 13	Remarks
T0	SS/PBCH SSS EPRE	dBm/SCS	-99	-88	-78	
T1	SS/PBCH SSS EPRE	dBm/SCS	"Off"	"Off"	"Off"	Power level "Off" is defined in TS 38.508-1 [4] Table 6.2.2.1-3

Table 6.4.1.2.3.2-2: Cell configuration changes over time for FR2

	Parameter	Unit	NR Cell 1	NR Cell 12	NR Cell 13	Remarks
T0	SS/PBCH SSS EPRE	dBm/SCS	FFS	FFS	FFS	
T1	SS/PBCH SSS EPRE	dBm/SCS	"Off"	"Off"	"Off"	Power level "Off" is defined in TS 38.508-1 [4] Table 6.2.2.2-2

Table 6.4.1.2.3.2-3: Main behaviour

St	Procedure	Message Sequence		TP	Verdict
		U - S	Message		
1	SS adjusts cell levels according to row T0 of table 6.4.1.2.3.2-1/2.	-	-	-	-
2	Check: Does the UE transmit an <i>RRCResumeRequest</i> message on NR Cell 12?	-->	NR RRC: <i>RRCResumeRequest</i>	1	P
3-6	Steps 2 to 5 of the generic test procedure in TS 38.508-1 Table 4.9.5.2.2-1 with condition MOBILITY are performed. (Note 1)	-	-	-	-
7	The SS transmits an <i>RRCRelease</i> message with suspend.	-->	NR RRC: <i>RRCRelease</i>	-	-
8	Check: Does the UE send an <i>RRCResumeRequest</i> on NR Cell 13 and NR Cell 1 within 60s?	-->	NR RRC: <i>RRCResumeRequest</i>	2	F
9	SS adjusts cell levels according to row T1 of table 6.4.1.2.3.2-1/2.	-	-	-	-
10	Set UE to Automatic PLMN selection mode. (Note 2)	-	-	-	-
Note 1: The REGISTRATION REQUEST is accepted with the PLMN of NR Cell 1 listed as an Equivalent PLMN.					
Note 2: Steps 10 is to ensure UE is set back to automatic PLMN selection mode for the next test case.					

6.4.1.2.3.3 Specific message contents

Table 6.4.1.2.3.3-1: SIB4 for NR Cell 1 (preamble and all steps, Table 6.4.1.2.3.2-2)

Derivation path: 38.508-1 [4] Table 4.6.2-3			
Information Element	Value/Remark	Comment	Condition
SIB4 ::= SEQUENCE {			
interFreqCarrierFreqList SEQUENCE (SIZE (1..maxFreq)) OF InterFreqCarrierFreqInfo {	2 entries		
InterFreqCarrierFreqInfo[1] SEQUENCE {		entry 1	
dl-CarrierFreq	Same downlink NR ARFCN as used for NR Cell 12		
cellReselectionPriority	4		
}			
InterFreqCarrierFreqInfo[2] SEQUENCE {		entry 2	
dl-CarrierFreq	Same downlink NR ARFCN as used for NR Cell 13		
cellReselectionPriority	4		
}			
}			
}			

Table 6.4.1.2.3.3-2: SIB4 for NR Cell 12 (preamble and all steps, Table 6.4.1.2.3.2-2)

Derivation path: 38.508-1 [4] Table 4.6.2-3			
Information Element	Value/Remark	Comment	Condition
SIB4 ::= SEQUENCE {			
interFreqCarrierFreqList SEQUENCE (SIZE (1..maxFreq)) OF InterFreqCarrierFreqInfo {	2 entries		
InterFreqCarrierFreqInfo[1] SEQUENCE {		entry 1	
dl-CarrierFreq	Same downlink NR ARFCN as used for NR Cell 1		
cellReselectionPriority	4		
}			
InterFreqCarrierFreqInfo[2] SEQUENCE {		entry 2	
dl-CarrierFreq	Same downlink NR ARFCN as used for NR Cell 13		
cellReselectionPriority	4		
}			
}			
}			

Table 6.4.1.2.3.3-3: REGISTRATION ACCEPT for NR Cell 1 (preamble)

Derivation path: 38.508-1 [4] Table 4.7.1-7			
Information Element	Value/Remark	Comment	Condition
Equivalent PLMNs	The PLMN of NR Cell 12		

Table 6.4.1.2.3.3-4: REGISTRATION ACCEPT for NR Cell 12 (step 5, Table 6.4.1.2.3.2-2)

Derivation path: 38.508-1 [4] Table 4.7.1-7			
Information Element	Value/Remark	Comment	Condition
Equivalent PLMNs	The PLMN of NR Cell 1		

Table 6.4.1.2.3.3-5: RRCRelease (step 7, Table 6.4.1.2.3.2-2)

Derivation Path: 38.508-1 [4], Table 4.6.1-4B			
Information Element	Value/remark	Comment	Condition
RRCRelease ::= SEQUENCE {			
criticalExtensions CHOICE {			
rrcRelease SEQUENCE {			
suspendConfig SEQUENCE {			NR_RRC_I NACTIVE
ran-NotificationAreaInfo CHOICE {			
cellList SEQUENCE {			
plmn-Identity		PLMN ID of NR Cell 12	
ran-AreaCells SEQUENCE {			
cellIdentity	See Table 4.4.2-2 and 4.4.2-3 in TS 38.508-1 [4]	Cell Identity of NR Cell 12	
}			
}			
}			
}			

6.4.2 Cell Selection/Qrxlevmin & Cell Reselection (Intra NR in RRC_INACTIVE state)

6.4.2.1 Cell Selection/Qrxlevmin & Cell Reselection (Intra NR in RRC_INACTIVE state)

6.4.2.1.1 Test Purpose (TP)

(1)

```
with { UE in NR RRC_INACTIVE state }
ensure that {
  when { serving cell fulfils all requirements for a suitable cell except the cell selection
  criteria which are not fulfilled (Srxlev<0) }
  then { UE does not consider the cell as suitable , leaves RRC_INACTIVE state and does not remain
  camped on that cell }
}
```

(2)

```
with { UE in NR RRC_INACTIVE state }
ensure that {
  when { UE detects a cell ranked as the best cell }
  then { UE reselects to the new cell and continues to remain in RRC_INACTIVE state }
}
```

6.4.2.1.2 Conformance requirements

References: The conformance requirements covered in the present TC are specified in: TS 38.300, clause 9.2.1.1, and TS 38.304, clause 4.1, 4.5, 5.2.1, 5.2.3.1 and 5.2.3.2. Unless otherwise stated these are Rel-15 requirements.

[TS 38.300, clause 9.2.1.1]

The principles of PLMN selection in NR are based on the 3GPP PLMN selection principles. Cell selection is required on transition from RM-DEREGISTERED to RM-REGISTERED, from CM-IDLE to CM-CONNECTED and from CM-CONNECTED to CM-IDLE and is based on the following principles:

- The UE NAS layer identifies a selected PLMN and equivalent PLMNs;
- Cell selection is always based on CD-SSBs located on the synchronization raster (see subclause 5.2.4):
 - The UE searches the NR frequency bands and for each carrier frequency identifies the strongest cell as per the CD-SSB. It then reads cell system information broadcast to identify its PLMN(s):
 - The UE may search each carrier in turn ("initial cell selection") or make use of stored information to shorten the search ("stored information cell selection").
- The UE seeks to identify a suitable cell; if it is not able to identify a suitable cell it seeks to identify an acceptable cell. When a suitable cell is found or if only an acceptable cell is found it camps on that cell and commence the cell reselection procedure:
 - A suitable cell is one for which the measured cell attributes satisfy the cell selection criteria; the cell PLMN is the selected PLMN, registered or an equivalent PLMN; the cell is not barred or reserved and the cell is not part of a tracking area which is in the list of "forbidden tracking areas for roaming";
 - An acceptable cell is one for which the measured cell attributes satisfy the cell selection criteria and the cell is not barred.

Transition to RRC_IDLE:

On transition from RRC_CONNECTED or RRC_INACTIVE to RRC_IDLE, a UE should camp on a cell as result of cell selection according to the frequency be assigned by RRC in the state transition message if any.

Recovery from out of coverage:

The UE should attempt to find a suitable cell in the manner described for stored information or initial cell selection above. If no suitable cell is found on any frequency or RAT, the UE should attempt to find an acceptable cell.

In multi-beam operations, the cell quality is derived amongst the beams corresponding to the same cell (see subclause 9.2.4).

[TS 38.304, clause 4.1]

The RRC_IDLE state and RRC_INACTIVE state tasks can be subdivided into three processes:

- PLMN selection;
- Cell selection and reselection;
- Location registration and RNA update.

PLMN selection, cell reselection procedures, and location registration are common for both RRC_IDLE state and RRC_INACTIVE state. RNA update is only applicable for RRC_INACTIVE state. When UE selects a new PLMN, UE transitions from RRC_INACTIVE to RRC_IDLE, as specified in TS 24.501 [14].

When a UE is switched on, a public land mobile network (PLMN) is selected by NAS. For the selected PLMN, associated RAT(s) may be set, as specified in TS 23.122 [9]. The NAS shall provide a list of equivalent PLMNs, if available, that the AS shall use for cell selection and cell reselection.

With cell selection, the UE searches for a suitable cell of the selected PLMN, chooses that cell to provide available services, and monitors its control channel. This procedure is defined as "camping on the cell".

The UE shall, if necessary, then register its presence, by means of a NAS registration procedure, in the tracking area of the chosen cell. As an outcome of a successful Location Registration, the selected PLMN then becomes the registered PLMN, as specified in TS 23.122 [9].

If the UE finds a more suitable cell, according to the cell reselection criteria, it reselects onto that cell and camps on it. If the new cell does not belong to at least one tracking area to which the UE is registered, location registration is performed. In RRC_INACTIVE state, if the new cell does not belong to the configured RNA, an RNA update procedure is performed.

...

The purpose of camping on a cell in RRC_IDLE state and RRC_INACTIVE state is fourfold:

- a) It enables the UE to receive system information from the PLMN.
- b) When registered and if the UE wishes to establish an RRC connection or resume a suspended RRC connection, it can do this by initially accessing the network on the control channel of the cell on which it is camped.
- c) If the network needs to send a message or deliver data to the registered UE, it knows (in most cases) the set of tracking areas (in RRC_IDLE state) or RNA (in RRC_INACTIVE state) in which the UE is camped. It can then send a "paging" message for the UE on the control channels of all the cells in the corresponding set of areas. The UE will then receive the paging message and can respond.
- d) It enables the UE to receive ETWS and CMAS notifications.

When the UE is in RRC_IDLE state, upper layers may deactivate AS layer when MICO mode is activated as specified in TS 24.501 [14]. When MICO mode is activated, the AS configuration (e.g. priorities provided by dedicated signalling) is kept and all running timers continue to run but the UE need not perform any idle mode tasks. If a timer expires while MICO mode is activated it is up to the UE implementation whether it performs the corresponding action immediately or the latest when MICO mode is deactivated. When MICO mode is deactivated, the UE shall perform all idle mode tasks.

[TS 38.304, clause 4.5]

The cells are categorised according to which services they offer:

acceptable cell:

An "acceptable cell" is a cell on which the UE may camp to obtain limited service (originate emergency calls and receive ETWS and CMAS notifications). Such a cell shall fulfil the following requirements, which is the minimum set of requirements to initiate an emergency call and to receive ETWS and CMAS notification in an NR network:

- The cell is not barred, see subclause 5.3.1;
- The cell selection criteria are fulfilled, see subclause 5.2.3.2.

suitable cell:

A cell is considered as suitable if the following conditions are fulfilled:

- The cell is part of either the selected PLMN or the registered PLMN or PLMN of the Equivalent PLMN list and *trackingAreaCode* is provided for that PLMN;
- The cell selection criteria are fulfilled, see subclause 5.2.3.2.

According to the latest information provided by NAS:

- The cell is not barred, see subclause 5.3.1;
- The cell is part of at least one TA that is not part of the list of "Forbidden Tracking Areas" (TS 22.261 [12]), which belongs to a PLMN that fulfils the first bullet above.

barred cell:

A cell is barred if it is so indicated in the system information, as specified in TS 38.331 [3].

reserved cell:

A cell is reserved if it is so indicated in system information, as specified in TS 38.331 [3].

Following exception to these definitions are applicable for UEs:

- if a UE has an ongoing emergency call, all acceptable cells of that PLMN are treated as suitable for the duration of the emergency call.
- camped on a cell that belongs to a registration area that is forbidden for regional provision of service; a cell that belongs to a registration area that is forbidden for regional provision service (TS 23.122 [9], TS 24.501 [14]) is suitable but provides only limited service.

[TS 38.304, clause 5.2.1]

UE shall perform measurements for cell selection and reselection purposes as specified in TS 38.133 [8].

When evaluating *Srxlev* and *Squal* of non-serving cells for reselection evaluation purposes, the UE shall use parameters provided by the serving cell and for the final check on cell selection criterion, the UE shall use parameters provided by the target cell for cell reselection.

The NAS can control the RAT(s) in which the cell selection should be performed, for instance by indicating RAT(s) associated with the selected PLMN, and by maintaining a list of forbidden registration area(s) and a list of equivalent PLMNs. The UE shall select a suitable cell based on *RRC_IDLE* or *RRC_INACTIVE* state measurements and cell selection criteria.

In order to expedite the cell selection process, stored information for several RATs, if available, may be used by the UE.

When camped on a cell, the UE shall regularly search for a better cell according to the cell reselection criteria. If a better cell is found, that cell is selected. The change of cell may imply a change of RAT. Details on performance requirements for cell reselection can be found in TS 38.133 [8].

The NAS is informed if the cell selection and reselection result in changes in the received system information relevant for NAS.

For normal service, the UE shall camp on a suitable cell, monitor control channel(s) of that cell so that the UE can:

- receive system information from the PLMN; and

- receive registration area information from the PLMN, e.g., tracking area information; and
- receive other AS and NAS Information; and
- if registered:
 - receive paging and notification messages from the PLMN; and
 - initiate transfer to Connected mode.

For cell selection in multi-beam operations, measurement quantity of a cell is up to UE implementation.

For cell reselection in multi-beam operations, the measurement quantity of this cell is derived amongst the beams corresponding to the same cell based on SS/PBCH block as follows:

- if *nrofSS-BlocksToAverage* is not configured in *SIB2/SIB4*; or
- if *absThreshSS-BlocksConsolidation* is not configured in *SIB2/SIB4*; or
- if the highest beam measurement quantity value is below or equal to *absThreshSS-BlocksConsolidation*:
 - derive a cell measurement quantity as the highest beam measurement quantity value, where each beam measurement quantity is described in TS 38.215 [11].
- else:
 - derive a cell measurement quantity as the linear average of the power values of up to *nrofSS-BlocksToAverage* of highest beam measurement quantity values above *absThreshSS-BlocksConsolidation*.

[TS 38.304, clause 5.2.3.1]

Cell selection is performed by one of the following two procedures:

- a) Initial cell selection (no prior knowledge of which RF channels are NR frequencies):
 1. The UE shall scan all RF channels in the NR bands according to its capabilities to find a suitable cell.
 2. On each frequency, the UE need only search for the strongest cell.
 3. Once a suitable cell is found, this cell shall be selected.
- b) Cell selection by leveraging stored information:
 1. This procedure requires stored information of frequencies and optionally also information on cell parameters from previously received measurement control information elements or from previously detected cells.
 2. Once the UE has found a suitable cell, the UE shall select it.
 3. If no suitable cell is found, the initial cell selection procedure in a) shall be started.

NOTE: Priorities between different frequencies or RATs provided to the UE by system information or dedicated signalling are not used in the cell selection process.

[TS 38.304, clause 5.2.3.2]

The cell selection criterion S is fulfilled when:

$$S_{rxlev} > 0 \text{ AND } S_{qual} > 0$$

where:

$$S_{rxlev} = Q_{rxlevmeas} - (Q_{rxlevmin} + Q_{rxlevminoffset}) - P_{compensation} - Q_{offsettemp}$$

$$S_{qual} = Q_{qualmeas} - (Q_{qualmin} + Q_{qualminoffset}) - Q_{offsettemp}$$

where:

Srxlev	Cell selection RX level value (dB)
Squal	Cell selection quality value (dB)
Qoffsettemp	Offset temporarily applied to a cell as specified in TS 38.331 [3] (dB)
Qrxlevmeas	Measured cell RX level value (RSRP)
Qqualmeas	Measured cell quality value (RSRQ)
Qrxlevmin	Minimum required RX level in the cell (dBm). If the UE supports SUL frequency for this cell, Qrxlevmin is obtained from $q-RxLevMinSUL$, if present, in <i>SIB1</i> , <i>SIB2</i> and <i>SIB4</i> , additionally, if $Q_{rxlevminoffsetcellSUL}$ is present in <i>SIB3</i> and <i>SIB4</i> for the concerned cell, this cell specific offset is added to the corresponding Qrxlevmin to achieve the required minimum RX level in the concerned cell; else Qrxlevmin is obtained from $q-RxLevMin$ in <i>SIB1</i> , <i>SIB2</i> and <i>SIB4</i> , additionally, if $Q_{rxlevminoffsetcell}$ is present in <i>SIB3</i> and <i>SIB4</i> for the concerned cell, this cell specific offset is added to the corresponding Qrxlevmin to achieve the required minimum RX level in the concerned cell.
Qqualmin	Minimum required quality level in the cell (dB). Additionally, if $Q_{qualminoffsetcell}$ is signalled for the concerned cell, this cell specific offset is added to achieve the required minimum quality level in the concerned cell.
Qrxlevminoffset	Offset to the signalled Qrxlevmin taken into account in the Srxlev evaluation as a result of a periodic search for a higher priority PLMN while camped normally in a VPLMN, as specified in TS 23.122 [9].
Qqualminoffset	Offset to the signalled Qqualmin taken into account in the Squal evaluation as a result of a periodic search for a higher priority PLMN while camped normally in a VPLMN, as specified in TS 23.122 [9].
Pcompensation	If the UE supports the additionalPmax in the NR-NS-PmaxList, if present, in <i>SIB1</i> , <i>SIB2</i> and <i>SIB4</i> : $max(P_{EMAX1} - P_{PowerClass}, 0) - (min(P_{EMAX2}, P_{PowerClass}) - min(P_{EMAX1}, P_{PowerClass}))$ (dB); else: $max(P_{EMAX1} - P_{PowerClass}, 0)$ (dB)
P _{EMAX1} , P _{EMAX2}	Maximum TX power level of a UE may use when transmitting on the uplink in the cell (dBm) defined as P _{EMAX} in TS 38.101 [15]. If UE supports SUL frequency for this cell, P _{EMAX1} and P _{EMAX2} are obtained from the <i>p-Max</i> for SUL in <i>SIB1</i> and <i>NR-NS-PmaxList</i> for SUL respectively in <i>SIB1</i> , <i>SIB2</i> and <i>SIB4</i> as specified in TS 38.331 [3], else P _{EMAX1} and P _{EMAX2} are obtained from the <i>p-Max</i> and <i>NR-NS-PmaxList</i> respectively in <i>SIB1</i> , <i>SIB2</i> and <i>SIB4</i> for normal UL as specified in TS 38.331 [3].
P _{PowerClass}	Maximum RF output power of the UE (dBm) according to the UE power class as defined in TS 38.101-1 [15].

The signalled values $Q_{rxlevminoffset}$ and $Q_{qualminoffset}$ are only applied when a cell is evaluated for cell selection as a result of a periodic search for a higher priority PLMN while camped normally in a VPLMN (TS 23.122 [9]). During this periodic search for higher priority PLMN, the UE may check the S criteria of a cell using parameter values stored from a different cell of this higher priority PLMN.

6.4.2.1.3 Test description

6.4.2.1.3.1 Pre-test conditions

System Simulator:

- NR Cell 1, NR Cell 2.
- System information combination NR-3 as defined in TS 38.508-1 [4] Table 4.4.3.1.2-1 is used in NR cells.

UE:

None.

Preamble:

- The UE is in state 2N-A on NR Cell 1 (serving cell) according to TS 38.508-1 [4] Table 4.4A.2-2.

6.4.2.1.3.2 Test procedure sequence

Table 6.4.2.1.3.2-1/2 illustrates the downlink power levels and other changing parameters to be applied for the NR cells at various time instants of the test execution. The exact instants on which these values shall be applied are described in the texts in this clause. The configuration "T0" indicates the initial conditions. Subsequent configurations marked "T1" and "T2" are applied at the points indicated in the Main behaviour description in Table 6.4.2.1.3.2-3.

Table 6.4.2.1.3.2-1: Time instances of cell power level and parameter changes for FR1

	Parameter	Unit	NR Cell 1	NR Cell 2	Remark
T0	SS/PBCH SSS EPRE	dBm/SCS	-88	Off	The power level values are assigned to ensure the UE registered on NR Cell 1.
T1	SS/PBCH SSS EPRE	dBm/SCS	-115	Off	The power level values are assigned to satisfy $S_{rxlev, NR Cell 1} < 0$.
T2	SS/PBCH SSS EPRE	dBm/SCS	-88	-78	The power level values are assigned to satisfy $R_{NR Cell 2} > R_{NR Cell 1}$.
Note 1: Power level "Off" is defined in TS 38.508-1 [4] Table 6.2.2.1-3.					

Table 6.4.2.1.3.2-2: Time instances of cell power level and parameter changes for FR2

	Parameter	Unit	NR Cell 1	NR Cell 2	Remark
T0	SS/PBCH SSS EPRE	dBm/SCS	FFS	Off	The power level values are assigned to ensure the UE registered on NR Cell 1.
T1	SS/PBCH SSS EPRE	dBm/SCS	FFS	Off	The power level values are assigned to satisfy $S_{rxlev, NR Cell 1} < 0$.
T2	SS/PBCH SSS EPRE	dBm/SCS	FFS	FFS	The power level values are assigned to satisfy $R_{NR Cell 2} > R_{NR Cell 1}$.
Note 1: The uncertain downlink signal level is specified in TS 38.508-1 [4] section FFS.					

Table 6.4.2.1.3.2-3: Main behaviour

St	Procedure	Message Sequence		TP	Verdict
		U - S	Message		
1	The SS changes NR Cell 1 SSS level according to the row "T1" in table 6.4.2.1.3.2-1/2.	-	-	-	-
2	Void	-	-	-	-
2A	Wait 15s. (Note 1)	-	-	-	-
3	The SS transmits a <i>Paging</i> message.	<-	NR RRC: <i>Paging</i>	-	-
4	Check: Does the UE attempt to transmit an uplink message within the next 10s?	-	-	1	F
5	The SS changes NR Cell 1 SSS levels according to the row "T0" in table 6.4.2.1.3.2-1/2.	-	-	-	-
6	Void	-	-	-	-
6A	Void	-	-	-	-
6B	The UE is switched off.	-	-	-	-
6C	The UE is switched on.	-	-	-	-
7	Generic procedure specified in TS 38.508-1 Table 4.5.3.2-1 are performed, in which the RRCRelease message includes the suspendConfig with NR_RRC_INACTIVE condition thereby moving the UE to RRC_INACTIVE.	-	-	-	-
8-15	Void	-	-	-	-
16	The SS changes NR Cell 2 SSS level according to the row "T2" in table 6.4.2.1.3.2-1/2.	-	-	-	-
17	Void	-	-	-	-
18	Check: Does the UE transmit an <i>RRCResumeRequest</i> message on the NR Cell 2?	-->	NR RRC: <i>RRCResumeRequest</i>	2	P
18A	The SS transmits an <i>RRCResume</i> message.	<-	NR RRC: <i>RRCResume</i>	-	-
18B	The UE transmit an <i>RRCResumeComplete</i> message.	-->	NR RRC: <i>RRCResumeComplete</i>	-	-
19	The SS transmits an <i>RRCRelease</i> message including <i>suspendConfig</i> with NR_RRC_INACTIVE condition.	<-	NR RRC: <i>RRCRelease</i>	-	-
Note 1:	As specified in TS 38.133 [30] clause 4.2.2.2, UE will wait DRXCycle * 2 to evaluate serving cell. If the UE in RRC_IDLE has not found any new suitable cell based on searches and measurements using the intra-frequency, inter-frequency and inter-RAT information indicated in the system information for 10 s, the UE shall initiate cell selection procedures for the selected PLMN. The wait time is selected to cover DRXCycle * 2 = 1280ms * 2 = 2.56s + 10s = 12.56s rounded up to 13s. Therefore, the actual wait time is selected to 15s, in order to be greater than 13s.				

6.4.2.1.3.3 Specific message contents

Table 6.4.2.1.3.3-1: SIB3 of NR Cell 1 (preamble and all steps, Table 6.4.2.1.3.2-3)

Derivation Path: TS 38.508-1 [4], Table 4.6.2-2			
Information Element	Value/remark	Comment	Condition
SIB3 ::= SEQUENCE {			
intraFreqNeighCellList SEQUENCE (SIZE (1..maxCellIntra)) OF IntraFreqNeighCellInfo {	1 entry		
IntraFreqNeighCellInfo[1] SEQUENCE{		entry 1	
physCellId	Physical cell identity of NR Cell 2		
q-OffsetCell	0		
}			
}			
}			

Table 6.4.2.1.3.3-2: RRCResume (step 18A, Table 6.4.2.1.3.2-3)

Derivation Path: TS 38.508-1 [4], Table 4.6.1-17			
Information Element	Value/remark	Comment	Condition
RRCResume ::= SEQUENCE {			
criticalExtensions CHOICE {			
rrcResume SEQUENCE {			
masterCellGroup := SEQUENCE {	CellGroupConfig	Table 6.4.2.1.3.3-3	
}			
}			
}			

Table 6.4.2.1.3.3-3: CellGroupConfig (Table 6.4.2.1.3.3-2)

Derivation Path: 38.508-1 [4], Table 4.6.3-19 with condition RESUME			
Information Element	Value/remark	Comment	Condition
CellGroupConfig ::= SEQUENCE {			
spCellConfigDedicated	ServingCellConfig		
}			

Table 6.4.2.1.3.3-4: ServingCellConfig (Table 6.4.2.1.3.3-3: CellGroupConfig)

Derivation Path: TS 38.508-1 [4], Table 4.6.3-167 with condition RESUME			
Information Element	Value/remark	Comment	Condition
ServingCellConfig ::= SEQUENCE {			
initialDownlinkBWP	BWP-DownlinkDedicated		
}			

Table 6.4.2.1.3.3-5: BWP-DownlinkDedicated (Table 6.4.2.1.3.3-4: ServingCellConfig)

Derivation Path: TS 38.508-1 [4], Table 4.6.3-11			
Information Element	Value/remark	Comment	Condition
BWP-DownlinkDedicated ::= SEQUENCE {			
pdccch-Config	Not present		
pdsch-Config CHOICE {			
setup	PDSCH-Config		
}			
}			

Table 6.4.2.1.3.3-6: PDSCH-Config (Table 6.4.2.1.3.3-5: BWP-DownlinkDedicated)

Derivation Path: TS 38.508-1 [4], Table 4.6.3-100			
Information Element	Value/remark	Comment	Condition
PDSCH-Config ::= SEQUENCE {			
dmrs-DownlinkForPDSCH-MappingTypeA	Not present		
tci-StatesToAddModList SEQUENCE(SIZE (1.. maxNrofTCI-States)) OF TCI-State {	1 entry		
TCI-State[1] SEQUENCE {		entry 1	
tci-StateId	0		
qcl-type1 SEQUENCE {			
referenceSignal CHOICE {			
ssb	SSB index #n	SSB index of NR Cell 2	
}			
}			
}			
prb-BundlingType	Not present		
}			

6.4.2.2 Inter-frequency cell reselection according to cell reselection priority provided by SIBs in RRC_INACTIVE state

6.4.2.2.1 Test Purpose (TP)

(1)

```
with { UE in NR RRC_INACTIVE state }
ensure that {
  when { UE detects the cell re-selection criteria are met for the cell which belongs to the equal
priority frequency }
  then { UE reselects to the cell which belongs to the equal priority frequency and remains in
RRC_INACTIVE state }
}
```

(2)

```
with { UE in NR RRC_INACTIVE state }
ensure that {
  when { UE detects the cell re-selection criteria are met for the cell which belongs to the higher
priority frequency }
  then { UE reselects to the cell which belongs to the higher priority frequency and remains in
RRC_INACTIVE state }
}
```

(3)

```
with { UE in NR RRC_INACTIVE state }
ensure that {
  when { UE detects the cell re-selection criteria are met for the cell which belongs to the lower
priority frequency }
  then { UE reselects to the cell which belongs to the lower priority frequency and remains in
RRC_INACTIVE state }
}
```

6.4.2.2.2 Conformance requirements

References: The conformance requirements covered in the present TC are specified in TS 38.304: clause 4.1, 5.2.4.1, 5.2.4.2 and 5.2.4.5. Unless otherwise stated these are Rel-15 requirements.

[TS 38.304, clause 4.1]

The RRC_IDLE state and RRC_INACTIVE state tasks can be subdivided into three processes:

- PLMN selection;
- Cell selection and reselection;
- Location registration and RNA update.

PLMN selection, cell reselection procedures, and location registration are common for both RRC_IDLE state and RRC_INACTIVE state. RNA update is only applicable for RRC_INACTIVE state. When UE selects a new PLMN, UE transitions from RRC_INACTIVE to RRC_IDLE, as specified in TS 24.501 [14].

...

If the UE finds a more suitable cell, according to the cell reselection criteria, it reselects onto that cell and camps on it. If the new cell does not belong to at least one tracking area to which the UE is registered, location registration is performed. In RRC_INACTIVE state, if the new cell does not belong to the configured RNA, an RNA update procedure is performed.

If necessary, the UE shall search for higher priority PLMNs at regular time intervals as described in TS 23.122 [9] and search for a suitable cell if another PLMN has been selected by NAS.

If the UE loses coverage of the registered PLMN, either a new PLMN is selected automatically (automatic mode), or an indication of available PLMNs is given to the user so that a manual selection can be performed (manual mode).

Registration is not performed by UEs only capable of services that need no registration.

The purpose of camping on a cell in RRC_IDLE state and RRC_INACTIVE state is fourfold:

- a) It enables the UE to receive system information from the PLMN.
- b) When registered and if the UE wishes to establish an RRC connection or resume a suspended RRC connection, it can do this by initially accessing the network on the control channel of the cell on which it is camped.
- c) If the network needs to send a message or deliver data to the registered UE, it knows (in most cases) the set of tracking areas (in RRC_IDLE state) or RNA (in RRC_INACTIVE state) in which the UE is camped. It can then send a "paging" message for the UE on the control channels of all the cells in the corresponding set of areas. The UE will then receive the paging message and can respond.
- d) It enables the UE to receive ETWS and CMAS notifications.

When the UE is in RRC_IDLE state, upper layers may deactivate AS layer when MICO mode is activated as specified in TS 24.501 [14]. When MICO mode is activated, the AS configuration (e.g. priorities provided by dedicated signalling) is kept and all running timers continue to run but the UE need not perform any idle mode tasks. If a timer expires while MICO mode is activated it is up to the UE implementation whether it performs the corresponding action immediately or the latest when MICO mode is deactivated. When MICO mode is deactivated, the UE shall perform all idle mode tasks.

[TS 38.304, clause 5.2.4.1]

Absolute priorities of different NR frequencies or inter-RAT frequencies may be provided to the UE in the system information, in the *RRCRelease* message, or by inheriting from another RAT at inter-RAT cell (re)selection. In the case of system information, an NR frequency or inter-RAT frequency may be listed without providing a priority (i.e. the field *cellReselectionPriority* is absent for that frequency). If priorities are provided in dedicated signalling, the UE shall ignore all the priorities provided in system information. If UE is in *camped on any cell* state, UE shall only apply the priorities provided by system information from current cell, and the UE preserves priorities provided by dedicated signalling and *deprioritisationReq* received in *RRCRelease* unless specified otherwise. When the UE in camped normally state, has only dedicated priorities other than for the current frequency, the UE shall consider the current frequency to be the lowest priority frequency (i.e. lower than any of the network configured values).

The UE shall only perform cell reselection evaluation for NR frequencies and inter-RAT frequencies that are given in system information and for which the UE has a priority provided.

In case UE receives *RRCRelease* with *deprioritisationReq*, UE shall consider current frequency and stored frequencies due to the previously received *RRCRelease* with *deprioritisationReq* or all the frequencies of NR to be the lowest priority frequency (i.e. lower than any of the network configured values) while T325 is running irrespective of camped RAT. The UE shall delete the stored deprioritisation request(s) when a PLMN selection is performed on request by NAS (3GPP TS 23.122 [9]).

NOTE: UE should search for a higher priority layer for cell reselection as soon as possible after the change of priority. The minimum related performance requirements specified in TS 38.133 [8] are still applicable.

The UE shall delete priorities provided by dedicated signalling when:

- the UE enters a different RRC state; or
- the optional validity time of dedicated priorities (T320) expires; or
- a PLMN selection is performed on request by NAS (3GPP TS 23.122 [9]).

NOTE 2: Equal priorities between RATs are not supported.

The UE shall not consider any black listed cells as candidate for cell reselection.

The UE shall inherit the priorities provided by dedicated signalling and the remaining validity time (i.e. T320 in NR and E-UTRA), if configured, at inter-RAT cell (re)selection.

NOTE 3: The network may assign dedicated cell reselection priorities for frequencies not configured by system information.

[TS 38.304, clause 5.2.4.2]

When evaluating S_{rxlev} and S_{qual} of non-serving cells for reselection purposes, the UE shall use parameters provided by the serving cell.

Following rules are used by the UE to limit needed measurements:

- If the serving cell fulfils $S_{rxlev} > S_{intraSearchP}$ and $S_{qual} > S_{intraSearchQ}$, the UE may choose not to perform intra-frequency measurements.
- Otherwise, the UE shall perform intra-frequency measurements.
- The UE shall apply the following rules for NR inter-frequencies and inter-RAT frequencies which are indicated in system information and for which the UE has priority provided as defined in 5.2.4.1:
 - For a NR inter-frequency or inter-RAT frequency with a reselection priority higher than the reselection priority of the current NR frequency, the UE shall perform measurements of higher priority NR inter-frequency or inter-RAT frequencies according to TS 38.133 [8].
 - For a NR inter-frequency with an equal or lower reselection priority than the reselection priority of the current NR frequency and for inter-RAT frequency with lower reselection priority than the reselection priority of the current NR frequency:
 - If the serving cell fulfils $S_{rxlev} > S_{nonIntraSearchP}$ and $S_{qual} > S_{nonIntraSearchQ}$, the UE may choose not to perform measurements of NR inter-frequencies or inter-RAT frequency cells of equal or lower priority;
 - Otherwise, the UE shall perform measurements of NR inter-frequencies or inter-RAT frequency cells of equal or lower priority according to TS 38.133 [8].

[TS 38.304, clause 5.2.4.5]

If $thresh_{ServingLowQ}$ is broadcast in system information and more than 1 second has elapsed since the UE camped on the current serving cell, cell reselection to a cell on a higher priority NR frequency or inter-RAT frequency than the serving frequency shall be performed if:

- A cell of a higher priority NR or EUTRAN RAT/frequency fulfils $S_{qual} > Thresh_{X, HighQ}$ during a time interval $T_{reselection_{RAT}}$

Otherwise, cell reselection to a cell on a higher priority NR frequency or inter-RAT frequency than the serving frequency shall be performed if:

- A cell of a higher priority RAT/ frequency fulfils $S_{rxlev} > Thresh_{X, HighP}$ during a time interval $T_{reselection_{RAT}}$; and
- More than 1 second has elapsed since the UE camped on the current serving cell.

Cell reselection to a cell on an equal priority NR frequency shall be based on ranking for intra-frequency cell reselection as defined in sub-clause 5.2.4.6.

If $thresh_{ServingLowQ}$ is broadcast in system information and more than 1 second has elapsed since the UE camped on the current serving cell, cell reselection to a cell on a lower priority NR frequency or inter-RAT frequency than the serving frequency shall be performed if:

- The serving cell fulfils $S_{qual} < Thresh_{Serving, LowQ}$ and a cell of a lower priority NR or E-UTRAN RAT/ frequency fulfils $S_{qual} > Thresh_{X, LowQ}$ during a time interval $T_{reselection_{RAT}}$.

Otherwise, cell reselection to a cell on a lower priority NR frequency or inter-RAT frequency than the serving frequency shall be performed if:

- The serving cell fulfils $S_{rxlev} < Thresh_{Serving, LowP}$ and a cell of a lower priority RAT/ frequency fulfils $S_{rxlev} > Thresh_{X, LowP}$ during a time interval $T_{reselection_{RAT}}$; and
- More than 1 second has elapsed since the UE camped on the current serving cell.

Cell reselection to a higher priority RAT/frequency shall take precedence over a lower priority RAT/frequency if multiple cells of different priorities fulfil the cell reselection criteria.

If more than one cell meets the above criteria, the UE shall reselect a cell as follows:

- If the highest-priority frequency is an NR frequency, a cell ranked as the best cell among the cells on the highest priority frequency(ies) meeting the criteria according to section 5.2.4.6;
- If the highest-priority frequency is from another RAT, a cell ranked as the best cell among the cells on the highest priority frequency(ies) meeting the criteria of that RAT.

6.4.2.2.3 Test description

6.4.2.2.3.1 Pre-test conditions

System Simulator:

- NR Cell 1, NR Cell 3 and NR Cell 6.
- System information combination NR-4 as defined in TS 38.508-1 [4] Table 4.4.3.1.2-1 is used in NR cells.

UE:

- None.

Preamble:

- The UE is in state 2N-A on NR Cell 1(serving cell) according to TS 38.508-1 [4] Table 4.4.A.2-2.

6.4.2.2.3.2 Test procedure sequence

Table 6.4.2.2.3.2-1/2 illustrates the downlink power levels and other changing parameters to be applied for the NR cells at various time instants of the test execution. The exact instants on which these values shall be applied are described in the texts in this clause. The configuration "T0" indicates the initial conditions. Subsequent configurations marked "T1", "T2" and "T3" are applied at the points indicated in the Main behaviour description in Table 6.4.2.2.3.2-3.

Table 6.4.2.2.3.2-1: Time instances of cell power level and parameter changes for FR1

	Parameter	Unit	NR Cell 1	NR Cell 3	NR Cell 6	Remark
T0	SS/PBCH SSS EPRE	dBm/SCS	-88	Off	Off	The power level values are assigned to ensure the UE registered on NR Cell 1.
T1	SS/PBCH SSS EPRE	dBm/SCS	-88	-78	Off	The power level values are assigned to satisfy $R_{NR\ Cell\ 1} < R_{NR\ Cell\ 3}$.
T2	SS/PBCH SSS EPRE	dBm/SCS	Off	-78	-78	The power level values are assigned to satisfy $Srxlev_{NR\ Cell\ 1} < 0$ and $Srxlev_{NR\ Cell\ 6} > Thresh_{NR\ Cell\ 6,\ highP}$.
T3	SS/PBCH SSS EPRE	dBm/SCS	Off	-78	-98	The power level values are assigned to satisfy $Srxlev_{NR\ Cell\ 6} < Thresh_{serving,\ lowP}$ and $Srxlev_{NR\ Cell\ 3} > Thresh_{NR\ Cell\ 3,\ lowP}$, $Srxlev_{NR\ Cell\ 1} < 0$.

Note 1: Power level "Off" is defined in TS 38.508-1 [4] Table 6.2.2.1-3.

Table 6.4.2.3.2-2: Time instances of cell power level and parameter changes for FR2

	Parameter	Unit	NR Cell 1	NR Cell 3	NR Cell 6	Remark
T0	SS/PBCH SSS EPRE	dBm/SCS	FFS	Off	Off	The power level values are assigned to ensure the UE registered on NR Cell 1.
T1	SS/PBCH SSS EPRE	dBm/SCS	FFS	FFS	Off	The power level values are assigned to satisfy $R_{NR\ Cell\ 1} < R_{NR\ Cell\ 3}$.
T2	SS/PBCH SSS EPRE	dBm/SCS	Off	FFS	FFS	The power level values are assigned to satisfy $Srxlev_{NR\ Cell\ 1} < 0$ and $Srxlev_{NR\ Cell\ 6} > Thresh_{NR\ Cell\ 6, highP}$.
T3	SS/PBCH SSS EPRE	dBm/SCS	Off	FFS	FFS	The power level values are assigned to satisfy $Srxlev_{NR\ Cell\ 6} < Thresh_{serving, lowP}$ and $Srxlev_{NR\ Cell\ 3} > Thresh_{NR\ Cell\ 3, lowP}$, $Srxlev_{NR\ Cell\ 1} < 0$.
Note 1: The uncertain downlink signal level is specified in TS 38.508-1 [4] section FFS.						

Table 6.4.2.3.2-3: Main behaviour

St	Procedure	Message Sequence		TP	Verdict
		U - S	Message		
1	The SS changes NR Cell 3 SSS level according to the row "T1" in table 6.4.2.3.2-1/2.	-	-	-	-
2	Void	-	-	-	-
3	Check: Does the UE transmit an <i>RRCResumeRequest</i> message on the cell 3?	-->	NR RRC: <i>RRCResumeRequest</i>	1	P
4	The SS transmits an <i>RRCRelease</i> message including <i>suspendConfig</i> with NR_RRC_INACTIVE condition.	<--	NR RRC: <i>RRCRelease</i>	-	-
5	The SS changes NR Cell 1 and NR Cell 6 SSS levels according to the row "T2" in table 6.4.2.3.2-1/2.	-	-	-	-
6	Void	-	-	-	-
7	Check: Does the UE transmit an <i>RRCResumeRequest</i> message on the cell 6?	-->	NR RRC: <i>RRCResumeRequest</i>	2	P
8	The SS transmits an <i>RRCRelease</i> message including <i>suspendConfig</i> with NR_RRC_INACTIVE condition.	<--	NR RRC: <i>RRCRelease</i>	-	-
9	The SS changes NR Cell 6 SSS level according to the row "T3" in table 6.4.2.3.2-1/2.	-	-	-	-
10	Void	-	-	-	-
11	Check: Does the UE transmit an <i>RRCResumeRequest</i> message on the cell 3?	-->	NR RRC: <i>RRCResumeRequest</i>	3	P
12	The SS transmits an <i>RRCRelease</i> message including <i>suspendConfig</i> with NR_RRC_INACTIVE condition.	<--	NR RRC: <i>RRCRelease</i>	-	-

6.4.2.3.3 Specific message contents

Table 6.4.2.3.3-1: Conditions for specific message contents in Tables below

Condition	Explanation
NR Cell 1	This condition applies to system information transmitted on NR Cell 1.
NR Cell 3	This condition applies to system information transmitted on NR Cell 3.
NR Cell 6	This condition applies to system information transmitted on NR Cell 6.

Table 6.4.2.3.3-2: SIB2 of NR Cell 6 (preamble and all steps, Table 6.4.2.3.2-3)

Derivation Path: TS 38.508-1 [4], Table 4.6.2-1			
Information Element	Value/remark	Comment	Condition
SIB2 ::= SEQUENCE {			
cellReselectionServingFreqInfo			
SEQUENCE {			
threshServingLowP	10	20 dB	
cellReselectionPriority	5		
}			
}			

Table 6.4.2.3.3-3: SIB4 of NR Cell 1, NR Cell 3 and NR Cell 6 (preamble and all steps, Table 6.4.2.3.2-3)

Derivation Path: TS 38.508-1 [4], Table 4.6.2-3			
Information Element	Value/remark	Comment	Condition
SIB4 ::= SEQUENCE {			
interFreqCarrierFreqList SEQUENCE	2 entries		NR Cell 1
SIZE (1..maxFreq) OF SEQUECNCNE {	1 entry		NR Cell 3 and NR Cell 6
dl-CarrierFreq[1]	Same downlink ARFCN as used for NR Cell 6		NR Cell 1
	Same downlink ARFCN as used for NR Cell 6		NR Cell 3
	Same downlink ARFCN as used for NR Cell 3		NR Cell 6
threshX-HighP[1]	10	20 dB	NR Cell 3
cellReselectionPriority[1]	5		NR Cell 1
	5		NR Cell 3
	4		NR Cell 6
dl-CarrierFreq[2]	Same downlink ARFCN as used for NR Cell 3		NR Cell 1
cellReselectionPriority[2]	4		NR Cell 1
}			
}			

6.4.3 Inter-RAT Cell Reselection

6.4.3.1 Inter-RAT cell reselection From NR RRC_INACTIVE to E-UTRA RRC_IDLE (lower priority & higher priority, Srxlev based)

6.4.3.1.1 Test Purpose (TP)

(1)

```
with { UE in NR RRC_INACTIVE state }
ensure that {
  when { UE detects the cell re-selection criteria are met for the neighbour cell which belongs to
the higher priority E-UTRA frequency }
  then { UE reselects to the E-UTRA cell and transitions to E-UTRA RRC_IDLE State }
}
```

(2)

```
with { UE in NR RRC_INACTIVE state }
ensure that {
  when { UE detects the cell re-selection criteria are met for the neighbour cell which belongs to
the lower priority E-UTRA frequency }
  then { UE reselects to the E-UTRA cell and transitions to E-UTRA RRC_IDLE State }
}
```

6.4.3.1.2 Conformance requirements

References: The conformance requirements covered in the present TC are specified in TS 38.304: clause 4.1, 5.2.4.1, 5.2.4.2 and 5.2.4.5. Unless otherwise stated these are Rel-15 requirements.

[TS 38.304, clause 4.1]

The RRC_IDLE state and RRC_INACTIVE state tasks can be subdivided into three processes:

- PLMN selection;
- Cell selection and reselection;
- Location registration and RNA update.

PLMN selection, cell reselection procedures, and location registration are common for both RRC_IDLE state and RRC_INACTIVE state. RNA update is only applicable for RRC_INACTIVE state. When UE selects a new PLMN, UE transitions from RRC_INACTIVE to RRC_IDLE, as specified in TS 24.501 [14].

...

If the UE finds a more suitable cell, according to the cell reselection criteria, it reselects onto that cell and camps on it. If the new cell does not belong to at least one tracking area to which the UE is registered, location registration is performed. In RRC_INACTIVE state, if the new cell does not belong to the configured RNA, an RNA update procedure is performed.

If necessary, the UE shall search for higher priority PLMNs at regular time intervals as described in TS 23.122 [9] and search for a suitable cell if another PLMN has been selected by NAS.

If the UE loses coverage of the registered PLMN, either a new PLMN is selected automatically (automatic mode), or an indication of available PLMNs is given to the user so that a manual selection can be performed (manual mode).

Registration is not performed by UEs only capable of services that need no registration.

The purpose of camping on a cell in RRC_IDLE state and RRC_INACTIVE state is fourfold:

- a) It enables the UE to receive system information from the PLMN.
- b) When registered and if the UE wishes to establish an RRC connection or resume a suspended RRC connection, it can do this by initially accessing the network on the control channel of the cell on which it is camped.
- c) If the network needs to send a message or deliver data to the registered UE, it knows (in most cases) the set of tracking areas (in RRC_IDLE state) or RNA (in RRC_INACTIVE state) in which the UE is camped. It can then send a "paging" message for the UE on the control channels of all the cells in the corresponding set of areas. The UE will then receive the paging message and can respond.
- d) It enables the UE to receive ETWS and CMAS notifications.

When the UE is in RRC_IDLE state, upper layers may deactivate AS layer when MICO mode is activated as specified in TS 24.501 [14]. When MICO mode is activated, the AS configuration (e.g. priorities provided by dedicated signalling) is kept and all running timers continue to run but the UE need not perform any idle mode tasks. If a timer expires while MICO mode is activated it is up to the UE implementation whether it performs the corresponding action immediately or the latest when MICO mode is deactivated. When MICO mode is deactivated, the UE shall perform all idle mode tasks.

[TS 38.304, clause 5.2.4.1]

Absolute priorities of different NR frequencies or inter-RAT frequencies may be provided to the UE in the system information, in the *RRCRelease* message, or by inheriting from another RAT at inter-RAT cell (re)selection. In the case of system information, an NR frequency or inter-RAT frequency may be listed without providing a priority (i.e. the field *cellReselectionPriority* is absent for that frequency). If priorities are provided in dedicated signalling, the UE shall ignore all the priorities provided in system information. If UE is in *camped on any cell* state, UE shall only apply the priorities provided by system information from current cell, and the UE preserves priorities provided by dedicated signalling and *deprioritisationReq* received in *RRCRelease* unless specified otherwise. When the UE in camped normally state, has only dedicated priorities other than for the current frequency, the UE shall consider the current frequency to be the lowest priority frequency (i.e. lower than any of the network configured values).

The UE shall only perform cell reselection evaluation for NR frequencies and inter-RAT frequencies that are given in system information and for which the UE has a priority provided.

In case UE receives *RRCRelease* with *deprioritisationReq*, UE shall consider current frequency and stored frequencies due to the previously received *RRCRelease* with *deprioritisationReq* or all the frequencies of NR to be the lowest priority frequency (i.e. lower than any of the network configured values) while T325 is running irrespective of camped RAT. The UE shall delete the stored deprioritisation request(s) when a PLMN selection is performed on request by NAS (3GPP TS 23.122 [9]).

NOTE: UE should search for a higher priority layer for cell reselection as soon as possible after the change of priority. The minimum related performance requirements specified in TS 38.133 [8] are still applicable.

The UE shall delete priorities provided by dedicated signalling when:

- the UE enters a different RRC state; or
- the optional validity time of dedicated priorities (T320) expires; or
- a PLMN selection is performed on request by NAS (3GPP TS 23.122 [9]).

NOTE 2: Equal priorities between RATs are not supported.

The UE shall not consider any black listed cells as candidate for cell reselection.

The UE shall inherit the priorities provided by dedicated signalling and the remaining validity time (i.e. T320 in NR and E-UTRA), if configured, at inter-RAT cell (re)selection.

NOTE 3: The network may assign dedicated cell reselection priorities for frequencies not configured by system information.

[TS 38.304, clause 5.2.4.2]

When evaluating *Srxlev* and *Squal* of non-serving cells for reselection purposes, the UE shall use parameters provided by the serving cell.

Following rules are used by the UE to limit needed measurements:

- If the serving cell fulfils $S_{rxlev} > S_{intraSearchP}$ and $S_{qual} > S_{intraSearchQ}$, the UE may choose not to perform intra-frequency measurements.
- Otherwise, the UE shall perform intra-frequency measurements.
- The UE shall apply the following rules for NR inter-frequencies and inter-RAT frequencies which are indicated in system information and for which the UE has priority provided as defined in 5.2.4.1:
 - For a NR inter-frequency or inter-RAT frequency with a reselection priority higher than the reselection priority of the current NR frequency, the UE shall perform measurements of higher priority NR inter-frequency or inter-RAT frequencies according to TS 38.133 [8].
 - For a NR inter-frequency with an equal or lower reselection priority than the reselection priority of the current NR frequency and for inter-RAT frequency with lower reselection priority than the reselection priority of the current NR frequency:
 - If the serving cell fulfils $S_{rxlev} > S_{nonIntraSearchP}$ and $S_{qual} > S_{nonIntraSearchQ}$, the UE may choose not to perform measurements of NR inter-frequencies or inter-RAT frequency cells of equal or lower priority;
 - Otherwise, the UE shall perform measurements of NR inter-frequencies or inter-RAT frequency cells of equal or lower priority according to TS 38.133 [8].

[TS 38.304, clause 5.2.4.5]

If *threshServingLowQ* is broadcast in system information and more than 1 second has elapsed since the UE camped on the current serving cell, cell reselection to a cell on a higher priority NR frequency or inter-RAT frequency than the serving frequency shall be performed if:

- A cell of a higher priority NR or EUTRAN RAT/frequency fulfils $S_{qual} > Thresh_{X, HighQ}$ during a time interval $T_{reselection_{RAT}}$

Otherwise, cell reselection to a cell on a higher priority NR frequency or inter-RAT frequency than the serving frequency shall be performed if:

- A cell of a higher priority RAT/ frequency fulfils $Srxlev > Thresh_{X, HighP}$ during a time interval $Treselection_{RAT}$; and
- More than 1 second has elapsed since the UE camped on the current serving cell.

Cell reselection to a cell on an equal priority NR frequency shall be based on ranking for intra-frequency cell reselection as defined in sub-clause 5.2.4.6.

If $thresh_{ServingLowQ}$ is broadcast in system information and more than 1 second has elapsed since the UE camped on the current serving cell, cell reselection to a cell on a lower priority NR frequency or inter-RAT frequency than the serving frequency shall be performed if:

- The serving cell fulfils $Squal < Thresh_{Serving, LowQ}$ and a cell of a lower priority NR or E-UTRAN RAT/ frequency fulfils $Squal > Thresh_{X, LowQ}$ during a time interval $Treselection_{RAT}$.

Otherwise, cell reselection to a cell on a lower priority NR frequency or inter-RAT frequency than the serving frequency shall be performed if:

- The serving cell fulfils $Srxlev < Thresh_{Serving, LowP}$ and a cell of a lower priority RAT/ frequency fulfils $Srxlev > Thresh_{X, LowP}$ during a time interval $Treselection_{RAT}$; and
- More than 1 second has elapsed since the UE camped on the current serving cell.

Cell reselection to a higher priority RAT/frequency shall take precedence over a lower priority RAT/frequency if multiple cells of different priorities fulfil the cell reselection criteria.

If more than one cell meets the above criteria, the UE shall reselect a cell as follows:

- If the highest-priority frequency is an NR frequency, a cell ranked as the best cell among the cells on the highest priority frequency(ies) meeting the criteria according to section 5.2.4.6;
- If the highest-priority frequency is from another RAT, a cell ranked as the best cell among the cells on the highest priority frequency(ies) meeting the criteria of that RAT.

6.4.3.1.3 Test description

6.4.3.1.3.1 Pre-test conditions

System Simulator:

- NR Cell 1.
- System information combination NR-6 as defined in TS 38.508-1 [4] Table 4.4.3.1.2-1 is used in NR cell.
- E-UTRA Cell 1 and E-UTRA Cell 3.
- System information combination 31 as defined in TS 36.508 [7] Table 4.4.3.1.1-1 is used in E-UTRA cell 1 and E-UTRA cell 3.

UE:

- None.

Preamble:

- With E-UTRA Cell 1 "Serving cell" and NR Cell 1 "Non-suitable "Off" cell" in accordance with TS 38.508-1 [4], Table 6.2.2.1-3, the UE is brought to state RRC_IDLE Connectivity (E) in accordance with the procedure described in TS 38.508-1 [4], Table 4.5.2.2-1. 4G GUTI and eKSI are assigned and security context established
- the UE is switched-off

- With E-UTRA Cell 1 "Non-suitable "Off" cell" and NR Cell 1 "Serving cell" in accordance with TS 38.508-1 [4], Table 6.2.2.1-3, the UE is brought to state 2N-A, RRC_INACTIVE Connectivity (NR), in accordance with the procedure described in TS 38.508-1 [4], Table 4.5.3.2-1. 5G-GUTI and ngKSI are assigned and security context established.

6.4.3.1.3.2 Test procedure sequence

Table 6.4.3.1.3.2-1/2 illustrates the downlink power levels and other changing parameters to be applied for the NR cells at various time instants of the test execution. The exact instants on which these values shall be applied are described in the texts in this clause. The configuration "T0" indicates the initial conditions. Subsequent configurations marked "T1" and "T2" are applied at the points indicated in the Main behaviour description in Table 6.4.3.1.3.2-3.

Table 6.4.3.1.3.2-1: Time instances of cell power level and parameter changes for FR1

	Parameter	Unit	NR Cell 1	E-UTRA Cell 1	E-UTRA Cell 3	Remark
T0	Cell-specific RS EPRE	dBm/15kHz	-	Off	Off	The power level values are assigned to ensure the UE registered on NR Cell 1.
	SS/PBCH SSS EPRE	dBm/SCS	-88	-	-	
T1	Cell-specific RS EPRE	dBm/15kHz	-	-78	Off	The power level values are assigned to satisfy $Srxlev_{E-UTRA\ Cell\ 1} > Thresh_{E-UTRA\ Cell\ 1, HighP}$.
	SS/PBCH SSS EPRE	dBm/SCS	-88	-	-	
T2	Cell-specific RS EPRE	dBm/15kHz	-	Off	-76	The power level values are assigned to satisfy $Srxlev_{NR\ Cell\ 1} < Thresh_{serving, LowP}$, $Srxlev_{E-UTRA\ Cell\ 3} > Thresh_{E-UTRA\ Cell\ 3, lowP}$, and $Srxlev_{E-UTRA\ Cell\ 1} < 0$.
	SS/PBCH SSS EPRE	dBm/SCS	-98	-	-	
Note 1: Power level "Off" of NR cell is defined in TS 38.508-1 [4] Table 6.2.2.1-3.						
Note 2: Power level "Off" of E-UTRA cell is defined in TS 36.508 [7] Table 6.2.2.1-3.						

Table 6.4.3.1.3.2-2: Time instances of cell power level and parameter changes for FR2

	Parameter	Unit	NR Cell 1	E-UTRA Cell 1	E-UTRA Cell 3	Remark
T0	Cell-specific RS EPRE	dBm/15kHz	-	Off	Off	The power level values are assigned to ensure the UE registered on NR Cell 1.
	SS/PBCH SSS EPRE	dBm/SCS	FFS	-	-	
T1	Cell-specific RS EPRE	dBm/15kHz	-	FFS	Off]	The power level values are assigned to satisfy $Srxlev_{E-UTRA\ Cell\ 1} > Thresh_{E-UTRA\ Cell\ 1, HighP}$.
	SS/PBCH SSS EPRE	dBm/SCS	FFS	-	-	
T2	Cell-specific RS EPRE	dBm/15kHz	-	Off	FFS	The power level values are assigned to satisfy $Srxlev_{NR\ Cell\ 1} < Thresh_{serving, LowP}$, $Srxlev_{E-UTRA\ Cell\ 3} > Thresh_{E-UTRA\ Cell\ 3, lowP}$, and $Srxlev_{E-UTRA\ Cell\ 1} < 0$.
	SS/PBCH SSS EPRE	dBm/SCS	FFS	-	-	
Note 1: The uncertain downlink signal level is specified in TS 38.508-1 [4] section FFS.						

Table 6.4.3.1.3.2-3: Main behaviour

St	Procedure	Message Sequence		TP	Verdict
		U - S	Message		
1	The SS changes E-UTRA Cell 1 SSS level according to the row "T1" in table 6.4.3.1.3.2-1/2.	-	-	-	-
2	Void	-	-	-	-
3	Check: Does the test result of generic test procedure in TS 38.508-1 [4] Table 4.9.7.2.2-1 indicate that the UE is camped on E-UTRA Cell 1?	-	-	1	P
4	The SS changes NR Cell 1 SSS levels according to the row "T0" in table 6.4.3.1.3.2-1/2.	-	-	-	-
5	Void	-	-	-	-
6	Steps of the generic test procedure in TS 38.508-1 [4] Table 4.9.9.2.2-1 are performed on NR Cell 1.	-	-	-	-
7	The SS transmits an <i>RRCRelease</i> message including <i>suspendConfig</i> with <i>NR_RRC_INACTIVE</i> condition.	<--	NR RRC: <i>RRCRelease</i>	-	-
8	The SS changes NR Cell 1, E-UTRA Cell 1 and E-UTRA Cell 3 SSS level according to the row "T2" in table 6.4.3.1.3.2-1/2.	-	-	-	-
9	Void	-	-	-	-
10	Check: Does the test result of generic test procedure in TS 38.508-1 [4] Table 4.9.7.2.2-1 indicate that the UE is camped on E-UTRA Cell 3 with condition ' <i>connected without release</i> '?	-	-	2	P

6.4.3.1.3.3 Specific message contents

Table 6.4.3.1.3.3-1: *SIB2* of NR Cell 1 (preamble and all steps, Table 6.4.3.1.3.2-3)

Derivation Path: TS 38.508-1 [4], Table 4.6.2-1			
Information Element	Value/remark	Comment	Condition
<i>SIB2</i> ::= SEQUENCE {			
<i>cellReselectionServingFreqInfo</i>			
SEQUENCE {			
<i>threshServingLowP</i>	10	20 dB	
<i>cellReselectionPriority</i>	5		
}			
}			

Table 6.4.3.1.3.3-2: SIB5 of NR Cell 1 (preamble and all steps, Table 6.4.3.1.3.2-3)

Derivation Path: TS 38.508-1 [4], Table 4.6.2-4			
Information Element	Value/remark	Comment	Condition
SIB5 ::= SEQUENCE {			
carrierFreqListEUTRA SEQUENCE (SIZE (1..maxEUTRA-Carrier)) OF	2 entries		
CarrierFreqEUTRA {		entry 1	
carrierFreq	Same downlink ARFCN as used for E-UTRA Cell 1		
cellReselectionPriority	6		
}			
CarrierFreqEUTRA[2] SEQUENCE {		entry 2	
carrierFreq	Same downlink ARFCN as used for E-UTRA Cell 3		
cellReselectionPriority	4		
}			
}			
}			

Table 6.4.3.1.3.3-3: SystemInformationBlockType24 for E-UTRA Cell 1 (preamble and all steps, Table 6.4.3.1.3.2-3)

Derivation path: 36.508 [7] table 4.4.3.3-20			
Information Element	Value/Remark	Comment	Condition
SystemInformationBlockType24-r15 ::= SEQUENCE {			
carrierFreqListNR-r15 SEQUENCE (SIZE (1..maxFreq)) OF CarrierFreqNR-r15 {	1 entry		
CarrierFreqNR-r15[1] SEQUENCE {		entry 1	
carrierFreq-r15	Same downlink ARFCN as used for NR Cell 1		
cellReselectionPriority-r15	5		
}			
}			
}			

Table 6.4.3.1.3.3-4: TRACKING AREA UPDATE REQUEST (Step 3, Table 6.4.3.1.3.2-3)

Derivation Path: TS 38.508-1 [4], Table 4.9.7.2.3-1			
Information Element	Value/remark	Comment	Condition
EPS update type			
EPS update type Value	'010'B	Combined TA/LA updating with IMSI attach	combined_TA_LA
	'000'B	TA updating	TA_only
NOTE: The message shall be integrity protected using the 5GS security context available in the UE.			

Table 6.4.3.1.3.3-5: TRACKING AREA UPDATE REQUEST (Step 10, Table 6.4.3.1.3.2-3)

Derivation Path: TS 38.508-1 [4], Table 4.9.7.2.3-1			
Information Element	Value/remark	Comment	Condition
EPS update type			
EPS update type Value	'001'B	Combined TA/LA updating	combined_TA_LA
	'000'B	TA updating	TA_only
UE radio capability information update needed	Not Check	UE radio capability information update needed	
NOTE: The message shall be integrity protected using the 5GS security context available in the UE.			

Condition	Explanation
TA_only	This condition applies if the UE is configured to initiate EPS attach or if explicitly specified.
combined_TA_LA	This condition applies if the UE is configured to initiate combined EPS/MSI attach or if explicitly specified.

Table 6.4.3.1.3.3-6: REGISTRATION REQUEST (Step 6, Table 6.4.3.1.3.2-3)

Derivation Path: TS 38.508-1 [4], Table 4.7.1-6.			
Information Element	Value/remark	Comment	Condition
EPS NAS message container	TRACKING AREA UPDATE REQUEST message	See Table 6.4.3.1.3.3-7	

Table 6.4.3.1.3.3-7: TRACKING AREA UPDATE REQUEST (Table 6.4.3.1.3.3-6)

Derivation Path: TS 38.508-1 [4], Table 4.9.9.2.3-2 with condition Mapped EPS security contextE

7 Layer 2

7.1 NR Layer 2

7.1.0 Common test case specific values for Layer 2

For all layer 2 test cases, default values for periodicBSR-Timer, retxBSR-Timer and phr-Config shall be taken according to the table 7.1.0-1 unless test case specific values are given in the test case.

Table 7.1.0-1: MAC-CellGroupConfig

Derivation Path: TS 38.308 [6], clause Table 4.6.3-49			
Information Element	Value/remark	Comment	Condition
MAC-CellGroupConfig ::= SEQUENCE {			
bsr-Config SEQUENCE {			
periodicBSR-Timer	infinity		
retxBSR-Timer	sf10240		
}			
phr-Config CHOICE {			
release	NULL		
}			
}			

7.1.1 MAC

7.1.1.0 Default Pre-Test Conditions for all MAC test cases

The following pre-test conditions shall be applied in all MAC test cases until the test case explicitly over writes these conditions

System Simulator:

- The SS configures the test environment in accordance to the execution conditions in Table 7.1.1.0-1.

UE:

- None

Preamble:

- The SS performs the generic procedure in [4] to get UE in state RRC_CONNECTED in accordance to the execution conditions in Table 7.1.1.0-2 and using the message condition UE TEST LOOP MODE A to return one PDCP SDU per DL PDCP SDU.

Table 7.1.1.0-1: Test environment

Execution Condition	Cell configuration	System Information Combination
IF pc_NG_RAN_NR	NR Cell 1	NR: System information Combination NR-1
ELSE IF pc_EN_DC	E-UTRA Cell 1 is PCell, NR Cell 1 is PSCell	EUTRA: System information Combination 1 NR: N/A
ELSE IF pc_NGEN_DC	NG-RAN E-UTRA Cell 1 is PCell, NR Cell 1 is PSCell	EUTRA: System information Combination 1 NR: N/A

Table 7.1.1.0-2: Preamble parameters

Execution Condition	Multi-PDN / Multi-PDU Sessions Condition	Generic Procedure Parameters	Primary DRB used for Data testing
IF pc_NG_RAN_NR	FALSE	Connectivity(NR), Test loop function(On) One DRB	Default DRB of the first PDU session on NR Cell
	TRUE	Connectivity(NR), Test loop function(On) N DRBs ($N \geq 2$)	
ELSE IF pc_EN_DC	FALSE	Connectivity(EN-DC), DC bearer(One MN Terminated MCG bearer and One SN terminated SCG bearer), Test loop function(On)	SN Terminated SCG bearer unless explicitly specified in test case
	TRUE	Connectivity(EN-DC), DC bearer(Two MN Terminated MCG bearer and One SN terminated SCG bearer), Test loop function(On)	
ELSE IF pc_NGEN_DC	FALSE	Connectivity(NGEN-DC), DC bearer(One MN Terminated MCG bearer and One SN terminated SCG bearer), Test loop function(On)	SN Terminated SCG bearer unless explicitly specified in test case
	TRUE	Connectivity(EN-DC), DC bearer(Two MN Terminated MCG bearer and One SN terminated SCG bearer), Test loop function(On)	

Table 7.1.1.0-3: Message conditions

Execution Condition	Message condition exceptions
IF pc_NG_RAN_NR	Message with condition AM is used for step 7 in 4.5.4.2 according to [4]
ELSE IF pc_EN_DC	Message condition MCG_and_SCG with condition AM is used for step 7 in 4.5.4.2 according to [4]
ELSE IF pc_NGEN_DC	Message condition MCG_and_SCG with condition AM is used for step 7 in 4.5.4.2 according to [4]

Table 7.1.1.0-4: SDAP Configuration Settings for pc_NG_RAN_NR

Parameter	Value DRB1	Value DRB2	Value DRB3
default DRB	true	false	false
mappedQoS-FlowsToAdd	QFI 1 in Table 4.8.2.3-1 according to TS38.508-1	QFI 2 in Table 4.8.2.3-2 according to TS38.508-1	QFI 3 in Table 4.8.2.3-3 according to TS38.508-1

7.1.1.1 Random Access Procedures

7.1.1.1.1 Correct selection of RACH parameters / Random access preamble and PRACH resource explicitly signalled to the UE by RRC / contention free random access procedure

7.1.1.1.1.1 Test Purpose (TP)

(1)

```
with { UE in RRC_Connected }
ensure that {
  when { SS sends an RRCReconfiguration message including RACH-ConfigDedicated information element }
  then { UE sends a prach preamble given in the RACH-ConfigDedicated on the target cell }
}
```

(2)

```
with { UE in RRC_Connected state after transmission of a PRACH preamble on NR SpCell received in RACH-ConfigDedicated on the target cell }
ensure that {
  when { UE does not receive a matching Random Access response in ra-ResponseWindowSize (hence considers RACH attempt as failed) and PREAMBLE_TRANSMISSION_COUNTER is less than PREAMBLE_TRANS_MAX }
  then { UE retransmits a PRACH preamble received in RACH-ConfigDedicated on the target cell }
}
```

7.1.1.1.1.2 Conformance requirements

References: The conformance requirements covered in the present test case are specified in: TS 38.321, clauses 5.1.2, 5.1.4. Unless otherwise stated these are Rel-15 requirements.

[TS 38.321, clause 5.1.2]

The MAC entity shall:

...

1> else if the *ra-PreambleIndex* has been explicitly provided by PDCCH; and

1> if the *ra-PreambleIndex* is not 0b000000:

2> set the *PREAMBLE_INDEX* to the signalled *ra-PreambleIndex*;

2> select the SSB signalled by PDCCH.

1> else if the contention-free Random Access Resources associated with SSBs have been explicitly provided in *rach-ConfigDedicated* and at least one SSB with SS-RSRP above *rsrp-ThresholdSSB* amongst the associated SSBs is available:

2> select an SSB with SS-RSRP above *rsrp-ThresholdSSB* amongst the associated SSBs;

2> set the *PREAMBLE_INDEX* to a *ra-PreambleIndex* corresponding to the selected SSB.

...

- 1> else if an SSB is selected above:
 - 2> determine the next available PRACH occasion from the PRACH occasions corresponding to the selected SSB permitted by the restrictions given by the *ra-ssb-OccasionMaskIndex* if configured or indicated by PDCCH (the MAC entity shall select a PRACH occasion randomly with equal probability amongst the consecutive PRACH occasions according to clause 8.1 of TS 38.213 [6], corresponding to the selected SSB; the MAC entity may take into account the possible occurrence of measurement gaps when determining the next available PRACH occasion corresponding to the selected SSB).
- 1> else if a CSI-RS is selected above:
 - 2> if there is no contention-free Random Access Resource associated with the selected CSI-RS:
 - 3> determine the next available PRACH occasion from the PRACH occasions, permitted by the restrictions given by the *ra-ssb-OccasionMaskIndex* if configured, corresponding to the SSB in *candidateBeamRSList* which is quasi-collocated with the selected CSI-RS as specified in TS 38.214 [7] (the MAC entity shall select a PRACH occasion randomly with equal probability amongst the consecutive PRACH occasions according to clause 8.1 of TS 38.213 [6], corresponding to the SSB which is quasi-collocated with the selected CSI-RS; the MAC entity may take into account the possible occurrence of measurement gaps when determining the next available PRACH occasion corresponding to the SSB which is quasi-collocated with the selected CSI-RS).
 - 2> else:
 - 3> determine the next available PRACH occasion from the PRACH occasions in *ra-OccasionList* corresponding to the selected CSI-RS (the MAC entity shall select a PRACH occasion randomly with equal probability amongst the PRACH occasions occurring simultaneously but on different subcarriers, corresponding to the selected CSI-RS; the MAC entity may take into account the possible occurrence of measurement gaps when determining the next available PRACH occasion corresponding to the selected CSI-RS).
- 1> perform the Random Access Preamble transmission procedure (see clause 5.1.3).

NOTE: When the UE determines if there is an SSB with SS-RSRP above *rsrp-ThresholdSSB* or a CSI-RS with CSI-RSRP above *rsrp-ThresholdCSI-RS*, the UE uses the latest unfiltered L1-RSRP measurement.

[TS 38.321, clause 5.1.4]

Once the Random Access Preamble is transmitted and regardless of the possible occurrence of a measurement gap, the MAC entity shall:

- 1> if the contention-free Random Access Preamble for beam failure recovery request was transmitted by the MAC entity:
 - 2> start the *ra-ResponseWindow* configured in *BeamFailureRecoveryConfig* at the first PDCCH occasion as specified in TS 38.213 [6] from the end of the Random Access Preamble transmission;
 - 2> monitor for a PDCCH transmission on the search space indicated by *recoverySearchSpaceId* of the SpCell identified by the C-RNTI while *ra-ResponseWindow* is running.
- 1> else:
 - 2> start the *ra-ResponseWindow* configured in *RACH-ConfigCommon* at the first PDCCH occasion as specified in TS 38.213 [6] from the end of the Random Access Preamble transmission;
 - 2> monitor the PDCCH of the SpCell for Random Access Response(s) identified by the RA-RNTI while the *ra-ResponseWindow* is running.
- 1> if notification of a reception of a PDCCH transmission on the search space indicated by *recoverySearchSpaceId* is received from lower layers on the Serving Cell where the preamble was transmitted; and
- 1> if PDCCH transmission is addressed to the C-RNTI; and
- 1> if the contention-free Random Access Preamble for beam failure recovery request was transmitted by the MAC entity:

- 2> consider the Random Access procedure successfully completed.
- 1> else if a downlink assignment has been received on the PDCCH for the RA-RNTI and the received TB is successfully decoded:
 - 2> if the Random Access Response contains a MAC subPDU with Backoff Indicator:
 - 3> set the *PREAMBLE_BACKOFF* to value of the BI field of the MAC subPDU using Table 7.2-1, multiplied with *SCALING_FACTOR_BI*.
 - 2> else:
 - 3> set the *PREAMBLE_BACKOFF* to 0 ms.
 - 2> if the Random Access Response contains a MAC subPDU with Random Access Preamble identifier corresponding to the transmitted *PREAMBLE_INDEX* (see clause 5.1.3):
 - 3> consider this Random Access Response reception successful.
 - 2> if the Random Access Response reception is considered successful:
 - 3> if the Random Access Response includes a MAC subPDU with RAPID only:
 - 4> consider this Random Access procedure successfully completed;
 - 4> indicate the reception of an acknowledgement for SI request to upper layers.
 - 3> else:
 - 4> apply the following actions for the Serving Cell where the Random Access Preamble was transmitted:
 - 5> process the received Timing Advance Command (see clause 5.2);
 - 5> indicate the *preambleReceivedTargetPower* and the amount of power ramping applied to the latest Random Access Preamble transmission to lower layers (i.e. $(PREAMBLE_POWER_RAMPING_COUNTER - 1) \times PREAMBLE_POWER_RAMPING_STEP$);
 - 5> if the Random Access procedure for an SCell is performed on uplink carrier where *pusch-Config* is not configured:
 - 6> ignore the received UL grant.
 - 5> else:
 - 6> process the received UL grant value and indicate it to the lower layers.
 - 4> if the Random Access Preamble was not selected by the MAC entity among the contention-based Random Access Preamble(s):
 - 5> consider the Random Access procedure successfully completed.
 - 4> else:
 - 5> set the *TEMPORARY_C-RNTI* to the value received in the Random Access Response;
 - 5> if this is the first successfully received Random Access Response within this Random Access procedure:
 - 6> if the transmission is not being made for the CCCH logical channel:
 - 7> indicate to the Multiplexing and assembly entity to include a C-RNTI MAC CE in the subsequent uplink transmission.
 - 6> obtain the MAC PDU to transmit from the Multiplexing and assembly entity and store it in the Msg3 buffer.

NOTE: If within a Random Access procedure, an uplink grant provided in the Random Access Response for the same group of contention-based Random Access Preambles has a different size than the first uplink grant allocated during that Random Access procedure, the UE behaviour is not defined.

- 1> if *ra-ResponseWindow* configured in *BeamFailureRecoveryConfig* expires and if a PDCCH transmission on the search space indicated by *recoverySearchSpaceId* addressed to the C-RNTI has not been received on the Serving Cell where the preamble was transmitted; or
- 1> if *ra-ResponseWindow* configured in *RACH-ConfigCommon* expires, and if the Random Access Response containing Random Access Preamble identifiers that matches the transmitted *PREAMBLE_INDEX* has not been received:
 - 2> consider the Random Access Response reception not successful;
 - 2> increment *PREAMBLE_TRANSMISSION_COUNTER* by 1;
 - 2> if *PREAMBLE_TRANSMISSION_COUNTER* = *preambleTransMax* + 1:
 - 3> if the Random Access Preamble is transmitted on the SpCell:
 - 4> indicate a Random Access problem to upper layers;
 - 4> if this Random Access procedure was triggered for SI request:
 - 5> consider the Random Access procedure unsuccessfully completed.
 - 3> else if the Random Access Preamble is transmitted on an SCell:
 - 4> consider the Random Access procedure unsuccessfully completed.
 - 2> if the Random Access procedure is not completed:
 - 3> select a random backoff time according to a uniform distribution between 0 and the *PREAMBLE_BACKOFF*;
 - 3> if the criteria (as defined in clause 5.1.2) to select contention-free Random Access Resources is met during the backoff time:
 - 4> perform the Random Access Resource selection procedure (see clause 5.1.2);
 - 3> else:
 - 4> perform the Random Access Resource selection procedure (see clause 5.1.2) after the backoff time.

The MAC entity may stop *ra-ResponseWindow* (and hence monitoring for Random Access Response(s)) after successful reception of a Random Access Response containing Random Access Preamble identifiers that matches the transmitted *PREAMBLE_INDEX*.

HARQ operation is not applicable to the Random Access Response reception.

7.1.1.1.1.3 Test description

7.1.1.1.1.3.1 Pre-test conditions

Same Pre-test conditions as in clause 7.1.1.0 except the following:

- 2 NR cells (NR Cell 1 and NR Cell 2) are configured.
- Test loop function(*Off*)

7.1.1.1.1.3.2 Test procedure sequence

Table 7.1.1.1.1.3.2-1: Main behaviour

St	Procedure	Message Sequence		TP	Verdict
		U - S	Message		
1	The SS transmits an <i>RRCReconfiguration</i> message to handover NR Cell 1 to target NR Cell 2, including RACH-ConfigDedicated information element (Note 1, Note 3)	<--	<i>RRCReconfiguration</i>	-	-
2	Void				
3	Check: Does the UE transmit Preamble on PRACH corresponding to <i>ra-PreambleIndex</i> in step 1 on NR Cell2?	-->	(PRACH Preamble)	1	P
4	Check: Does the UE re-transmits Preamble on PRACH corresponding to <i>ra-PreambleIndex</i> in step 1 on NR Cell2?	-->	(PRACH Preamble)	2	P
5	The SS transmits Random Access Response on NR cell 2, with RAPID corresponding to <i>ra-PreambleIndex</i> in step 1	<--	Random Access Response	-	-
6	Check: Does the UE transmit an <i>RRCReconfigurationComplete</i> message? (Note 2)	-->	<i>RRCReconfigurationComplete</i>	-	-
Note 1: For EN-DC the NR <i>RRCReconfiguration</i> message is contained in <i>RRCConnectionReconfiguration</i> 36.508 [7], Table 4.6.1-8 using condition EN-DC_PSCell_HO AND RBConfig_NoKeyChange. Note 2: For EN-DC the NR <i>RRCReconfigurationComplete</i> message is contained in <i>RRCConnectionReconfigurationComplete</i> . Note 3: For FR1, PRACH preamble format 0 as per TS 38.211[24] Table 6.3.3.1-1 is configured (real network deployment).					

7.1.1.1.1.3.3 Specific message contents

Table 7.1.1.1.1.3.3-1: Void

Table 7.1.1.1.1.3.3-2: *RRCReconfiguration* for EN-DC (step 1, Table 7.1.1.1.1.3.2-1)

Derivation Path: 38.508-1 [4], Table 4.6.1-13 with condition EN-DC_HO.			
Information Element	Value/remark	Comment	Condition
<i>RRCReconfiguration</i> ::= SEQUENCE {			
<i>criticalExtensions</i> CHOICE {			
<i>rrcReconfiguration</i> ::= SEQUENCE {			
<i>secondaryCellGroup</i>	CellGroupConfig		
}			
}			
}			

Table 7.1.1.1.1.3.3-2A: RRCReconfiguration for NR/5GC (step 1, Table 7.1.1.1.1.3.2-1)

Derivation Path: 38.508-1 [4], Table 4.6.1-13			
Information Element	Value/remark	Comment	Condition
RRCReconfiguration ::= SEQUENCE {			
criticalExtensions CHOICE {			
radioBearerConfig	RadioBearerConfig as per TS 38.508-1[4] Table 4.6.3-132 with conditions DRBn and Recover_PDCP	n set to the default DRB of the first PDU session	NR
rrcReconfiguration ::= SEQUENCE {			
nonCriticalExtension SEQUENCE {			
masterCellGroup	CellGroupConfig		
}			
}			
}			
}			

Table 7.1.1.1.1.3.3-3: CellGroupConfig for EN-DC (Table 7.1.1.1.1.3.3-2)

Derivation Path: 38.508-1 [4], Table 4.6.3-19 with condition PSCell_change			
Information Element	Value/remark	Comment	Condition
CellGroupConfig ::= SEQUENCE {			
spCellConfig SEQUENCE {			
spCellConfigCommon	ServingCellConfigCommon		
reconfigurationWithSync SEQUENCE {			
rach-ConfigDedicated CHOICE {			
uplink	RACH-ConfigDedicated		
}			
newUE-Identity	UE identity different from NR cell 1 UE identity		
}			
}			
}			

Table 7.1.1.1.1.3.3-3A: CellGroupConfig for NR/5GC (Table 7.1.1.1.1.3.3-2A)

Derivation Path: 38.508-1 [4], Table 4.6.3-19 with condition PCell_change			
Information Element	Value/remark	Comment	Condition
CellGroupConfig ::= SEQUENCE {			
spCellConfig SEQUENCE {			
reconfigurationWithSync SEQUENCE {			
spCellConfigCommon	ServingCellConfigCommon		
rach-ConfigDedicated CHOICE {			
uplink	RACH-ConfigDedicated		
}			
newUE-Identity	UE identity different from NR cell 1 UE identity		
}			
}			
}			

Table 7.1.1.1.1.3.3-4: RACH-ConfigDedicated (Table 7.1.1.1.1.3.3-3 and Table 7.1.1.1.1.3.3-3A)

Derivation Path: TS 38.508-1 [4], Table 4.6.3-129			
Information Element	Value/remark	Comment	Condition
RACH-ConfigDedicated ::= SEQUENCE {			
cfra SEQUENCE {			
occasions SEQUENCE {			
rach-ConfigGeneric	RACH-ConfigGeneric		FR1, PRACH Preamble format 0 used
}			
resources CHOICE {			
ssb SEQUENCE {			
ssb-ResourceList SEQUENCE (SIZE(1..maxRA-SSB-Resources)) OF CFRA-SSB-Resource {	1 entry		
CFRA-SSB-Resource[1] SEQUENCE {		entry 1	
ssb	0		
ra-PreambleIndex	52	Randomly selected	
}			
}			
}			
}			
}			

Table 7.1.1.1.1.3.3-5: RACH-ConfigGeneric (Table 7.1.1.1.1.3.3-4)

Derivation Path: TS 38.508-1 [4], Table 4.6.3-129			
Information Element	Value/remark	Comment	Condition
RACH-ConfigDedicated ::= SEQUENCE {			
prach-ConfigurationIndex	14		FR1
	149		FR2
zeroCorrelationZoneConfig	12		FR1
	15		FR2
}			

Table 7.1.1.1.1.3.3-6: ServingCellConfigCommon (Table 7.1.1.1.1.3.3-3 and Table 7.1.1.1.1.3.3-3A)

Derivation Path: TS 38.508-1 [4], Table 4.6.3-168			
Information Element	Value/remark	Comment	Condition
ServingCellConfigCommon ::= SEQUENCE {			
uplinkConfigCommon SEQUENCE {			
initialUplinkBWP	BWP-UplinkCommon		
}			
tdd-UL-DL-ConfigurationCommon	TDD-UL-DL- ConfigCommon		
}			

Table 7.1.1.1.1.3.3-7: BWP-UplinkCommon (Table 7.1.1.1.1.3.3-6)

Derivation Path: TS 38.508-1 [4], Table 4.6.3-10			
Information Element	Value/remark	Comment	Condition
BWP-UplinkCommon ::= SEQUENCE {			
rach-ConfigCommon CHOICE {			
setup	RACH-ConfigCommon		
}			
}			

Table 7.1.1.1.1.3.3-8: *RACH-ConfigCommon* (Table 7.1.1.1.1.3.3-7)

Derivation Path: TS 38.508-1 [4], Table 4.6.3-128			
Information Element	Value/remark	Comment	Condition
RACH-ConfigCommon ::= SEQUENCE {			
rach-ConfigGeneric	RACH-ConfigGeneric		
ssb_perRACH_OccasionAndCB_PreamblesPerSSB CHOICE {			
one	n36		
}			
prach-RootSequenceIndex CHOICE {			
1139	Set according to table 4.4.2-2 in TS 38.508-1 [4] for the NR Cell..		
1839	Set according to table 4.4.2-2 in TS 38.508-1 [4] for the NR Cell.	PRACH Preamble format 0 used	FR1,
}			
}			

Table 7.1.1.1.1.3.3-9: *TDD-UL-DL-ConfigCommon* (Table 7.1.1.1.1.3.3-6)

Derivation Path: TS 38.508-1 [4], Table 4.6.3-192			
Information Element	Value/remark	Comment	Condition
TDD-UL-DL-ConfigCommon ::= SEQUENCE {			
referenceSubcarrierSpacing	SubcarrierSpacing		
pattern1 SEQUENCE {			
dl-UL-TransmissionPeriodicity	ms5		FR1
	ms0p625		FR2
nrofDownlinkSlots	3		FR1
	3		FR2
nrofDownlinkSymbols	6		FR1
	10		FR2
nrofUplinkSlots	2		FR1
	1		FR2
nrofUplinkSymbols	4		FR1
	2		FR2
dl-UL-TransmissionPeriodicity-v1530	ms3		FR1
}			
pattern2	Not present		
pattern2 SEQUENCE {			FR1
dl-UL-TransmissionPeriodicity	ms2		
nrofDownlinkSlots	4		
nrofDownlinkSymbols	0		
nrofUplinkSlots	0		
nrofUplinkSymbols	0		
}			
}			

7.1.1.1.1a Correct selection of RACH parameters / Random access preamble and PRACH resource explicitly signalled to the UE by PDCCH Order / contention free random access procedure

7.1.1.1.1a.1 Test Purpose (TP)

(1)

```
with { UE in RRC_Connected }
ensure that {
  when { PDCCH control command is received in NR SpCell providing Random Access Preamble }
  then { UE sends a PRACH preamble given in the PDCCH Order in NR SpCell }
}
```

(2)

```

with { UE in RRC_Connected state after transmission of a PRACH preamble on NR SpCell received in
PDCCH control command on NR SpCell }
ensure that {
  when { UE does not receive a matching Random Access response in ra-ResponseWindowSize (hence
considers RACH attempt as failed) and PREAMBLE_TRANSMISSION_COUNTER is less than PREAMBLE_TRANS_MAX
}
  then { UE retransmits a PRACH preamble received in PDCCH control command on NR SpCell }
}

```

7.1.1.1.1a.2 Conformance requirements

References: The conformance requirements covered in the present test case are specified in: TS 38.321, clauses 5.1.2, 5.1.4 and TS 38.212 clause 7.3.1.2.1. Unless otherwise stated these are Rel-15 requirements.

[TS 38.321, clause 5.1.2]

The MAC entity shall:

...

- 1> else if the *ra-PreambleIndex* has been explicitly provided by either PDCCH or RRC; and
- 1> if the *ra-PreambleIndex* is not 0b000000; and
- 1> if contention-free Random Access Resource associated with SSBs or CSI-RS have not been explicitly provided by RRC:
 - 2> set the *PREAMBLE_INDEX* to the signalled *ra-PreambleIndex*.

...

- 1> if an SSB is selected above and an association between PRACH occasions and SSBs is configured:
 - 2> determine the next available PRACH occasion from the PRACH occasions corresponding to the selected SSB permitted by the restrictions given by the *ra-ssb-OccasionMaskIndex* if configured (the MAC entity may take into account the possible occurrence of measurement gaps when determining the next available PRACH occasion corresponding to the selected SSB).
- 1> else if a CSI-RS is selected above and an association between PRACH occasions and CSI-RSs is configured:
 - 2> determine the next available PRACH occasion from the PRACH occasions in *ra-OccasionList* corresponding to the selected CSI-RS (the MAC entity may take into account the possible occurrence of measurement gaps when determining the next available PRACH occasion corresponding to the selected CSI-RS).
- 1> else:
 - 2> determine the next available PRACH occasion (the MAC entity may take into account the possible occurrence of measurement gaps when determining the next available PRACH occasion).
- 1> perform the Random Access Preamble transmission procedure (see clause 5.1.3).

[TS 38.321, clause 5.1.4]

Once the Random Access Preamble is transmitted and regardless of the possible occurrence of a measurement gap, the MAC entity shall:

...

- 1> else:
 - 2> start the *ra-ResponseWindow* configured in *RACH-ConfigCommon* at the first PDCCH occasion as specified in TS 38.213 [6] from the end of the Random Access Preamble transmission;
 - 2> monitor the PDCCH of the SpCell for Random Access Response(s) identified by the RA-RNTI while the *ra-ResponseWindow* is running.

- 1> if notification of a reception of a PDCCH transmission is received from lower layers; and
- 1> if PDCCH transmission is addressed to the C-RNTI; and
- ...
- 1> else if a downlink assignment has been received on the PDCCH for the RA-RNTI and the received TB is successfully decoded:
 - 2> if the Random Access Response contains a Backoff Indicator subheader:
 - 3> set the *PREAMBLE_BACKOFF* to value of the BI field of the Backoff Indicator subheader using Table 7.2-1.
 - 2> else:
 - 3> set the *PREAMBLE_BACKOFF* to 0 ms.
 - 2> if the Random Access Response contains a Random Access Preamble identifier corresponding to the transmitted *PREAMBLE_INDEX* (see subclause 5.1.3):
 - 3> consider this Random Access Response reception successful.
 - 2> if the Random Access Response reception is considered successful:
 - 3> if the Random Access Response includes RAPID only:
 - 4> consider this Random Access procedure successfully completed;
 - 4> indicate the reception of an acknowledgement for the SI request to upper layers.
 - 3> else:
 - 4> apply the following actions for the Serving Cell where the Random Access Preamble was transmitted:
 - 5> process the received Timing Advance Command (see subclause 5.2);
 - 5> indicate the *preambleReceivedTargetPower* and the amount of power ramping applied to the latest Random Access Preamble transmission to lower layers (i.e. $(PREAMBLE_POWER_RAMPING_COUNTER - 1) \times preamblePowerRampingStep$);
 - 5> if the Serving Cell for the Random Access procedure is SRS-only SCell:
 - 6> ignore the received UL grant.
 - 5> else:
 - 6> process the received UL grant value and indicate it to the lower layers.
 - 4> if the Random Access Preamble was not selected by the MAC entity among the contention-based Random Access Preamble(s):
 - 5> consider the Random Access procedure successfully completed.
 - ...
 - 1> if *ra-ResponseWindow* configured in *RACH-ConfigCommon* expires, and if the Random Access Response containing Random Access Preamble identifiers that matches the transmitted *PREAMBLE_INDEX* has not been received; or:
 - 1> if *ra-ResponseWindow* configured in *BeamFailureRecoveryConfig* expires and if the PDCCH addressed to the C-RNTI has not been received:
 - 2> consider the Random Access Response reception not successful;
 - 2> increment *PREAMBLE_TRANSMISSION_COUNTER* by 1;
 - 2> if *PREAMBLE_TRANSMISSION_COUNTER* = *preambleTxMax* + 1:

- 3> if the Random Access Preamble is transmitted on the SpCell:
 - 4> indicate a Random Access problem to upper layers.
- 3> else if the Random Access Preamble is transmitted on a SCell:
 - 4> consider the Random Access procedure unsuccessfully completed.
- 2> if in this Random Access procedure, the Random Access Preamble was selected by MAC among the contention-based Random Access Preambles:
 - 3> select a random backoff time according to a uniform distribution between 0 and the *PREAMBLE_BACKOFF*;
 - 3> delay the subsequent Random Access Preamble transmission by the backoff time.
- 2> perform the Random Access Resource selection procedure (see subclause 5.1.2).

The MAC entity may stop *ra-ResponseWindow* (and hence monitoring for Random Access Response(s)) after successful reception of a Random Access Response containing Random Access Preamble identifiers that matches the transmitted *PREAMBLE_INDEX*.

HARQ operation is not applicable to the Random Access Response transmission.

[TS 38.212, 7.3.1.2.1]

If the CRC of the DCI format 1_0 is scrambled by C-RNTI and the "Frequency domain resource assignment" field are of all ones, the DCI format 1_0 is for random access procedure initiated by a PDCCH order, with all remaining fields set as follows:

- Random Access Preamble index – 6 bits according to *ra-PreambleIndex* in Subclause 5.1.2 of [8, TS38.321]
- UL/SUL indicator – 1 bit. If the value of the "Random Access Preamble index" is not all zeros and if the UE is configured with SUL in the cell, this field indicates which UL carrier in the cell to transmit the PRACH according to Table 7.3.1.1.1-1; otherwise, this field is reserved
- SS/PBCH index – 6 bits. If the value of the "Random Access Preamble index" is not all zeros, this field indicates the SS/PBCH that shall be used to determine the RACH occasion for the PRACH transmission; otherwise, this field is reserved.
- PRACH Mask index – 4 bits. If the value of the "Random Access Preamble index" is not all zeros, this field indicates the RACH occasion associated with the SS/PBCH indicated by "SS/PBCH index" for the PRACH transmission, according to Subclause 5.1.1 of [8, TS38.321]; otherwise, this field is reserved
- Reserved bits – 10 bits

7.1.1.1.1a.3 Test description

7.1.1.1.1a.3.1 Pre-test conditions

Same Pre-test conditions as in clause 7.1.1.0 except that Test loop function(*Off*).

7.1.1.1.1a.3.2 Test procedure sequence

Table 7.1.1.1.1a.3.2-1: Main behaviour

St	Procedure	Message Sequence		TP	Verdict
		U - S	Message		
0A	SS transmits an RRCReconfiguration message to configure specific parameters. Note 1, Note 3	<--	RRCReconfiguration	-	-
0B	The UE transmits RRCReconfigurationComplete message. Note 2	-->	RRCReconfigurationComplete	-	-
1	The SS transmits a PDCCH order providing Random Access Preamble ID 37 on NR SpCell.	<--	(PDCCH Order)	-	-
2	Check: Does the UE transmit Preamble on PRACH corresponding to <i>ra-PreambleIndex</i> in step 1?	-->	(PRACH Preamble)	1	P
3	Check: Does the UE re-transmits Preamble on PRACH corresponding to <i>ra-PreambleIndex</i> in step 1?	-->	(PRACH Preamble)	2	P
4	Check: Does the UE transmit Preamble on PRACH corresponding to <i>ra-PreambleIndex</i> in step 1?	-->	(PRACH Preamble)	2	P
5	Check: Does the UE re-transmits Preamble on PRACH corresponding to <i>ra-PreambleIndex</i> in step 1?	-->	(PRACH Preamble)	2	P
6	The SS transmits Random Access Response on NR SpCell, with RAPID corresponding to <i>ra-PreambleIndex</i> in step 1	<--	Random Access Response	-	-
Note 1: for EN-DC the NR <i>RRCReconfiguration</i> message is contained in <i>RRCConnectionReconfiguration</i> . Note 2: for EN-DC the NR <i>RRCReconfigurationComplete</i> message is contained in <i>RRCConnectionReconfigurationComplete</i> . Note 3: For FR1, PRACH preamble format 0 as per TS 38.211[24] Table 6.3.3.1-1 is configured in order to provide coverage for PRACH preamble format 0 testing					

7.1.1.1.1a.3.3 Specific message contents

Table 7.1.1.1.1a.3.3-1: *RRCReconfiguration* (step 0A, Table 7.1.1.1.1a.3.2-1)

Derivation Path: TS 38.508-1 [4], Table 4.6.1-13			
Information Element	Value/remark	Comment	Condition
RRCReconfiguration ::= SEQUENCE {			
		TS 38.508-1 [4], 2	
criticalExtensions CHOICE {			
rrcReconfiguration ::= SEQUENCE {			
secondaryCellGroup	CellGroupConfig	OCTET STRING (CONTAINING CellGroupConfig)	EN-DC
nonCriticalExtension SEQUENCE {			NR
masterCellGroup	CellGroupConfig	OCTET STRING (CONTAINING CellGroupConfig)	
}			
}			
}			

Table 7.1.1.1.1a.3.3-2: CellGroupConfig (Table 7.1.1.1.1a.3.3-1)

Derivation Path: TS 38.508-1 [4], Table 4.6.3-19			
Information Element	Value/remark	Comment	Condition
CellGroupConfig ::= SEQUENCE {			
spCellConfig SEQUENCE {			
reconfigurationWithSync SEQUENCE {			
spCellConfigCommon	ServingCellConfigCommon		
newUE-Identity	RNTI-Value		
t304	ms2000		
rach-ConfigDedicated	Not Present		
spCellConfigDedicated	ServingCellConfig		
}			

Table 7.1.1.1.1a.3.3-3: ServingCellConfigCommon (Table 7.1.1.1.1a.3.3-2)

Derivation Path: TS 38.508-1 [4], Table 4.6.3-168			
Information Element	Value/remark	Comment	Condition
ServingCellConfigCommon ::= SEQUENCE {			
uplinkConfigCommon SEQUENCE {			
initialUplinkBWP	BWP-UplinkCommon		
}			
tdd-UL-DL-ConfigurationCommon	TDD-UL-DL-ConfigCommon		
}			

Table 7.1.1.1.1a.3.3-4: BWP-UplinkCommon (Table 7.1.1.1.1a.3.3-3)

Derivation Path: TS 38.508-1 [4], Table 4.6.3-10			
Information Element	Value/remark	Comment	Condition
BWP-UplinkCommon ::= SEQUENCE {			
rach-ConfigCommon CHOICE {			
setup	RACH-ConfigCommon		
}			
}			

Table 7.1.1.1.1a.3.3-5: RACH-ConfigCommon (Table 7.1.1.1.1a.3.3-4)

Derivation Path: TS 38.508-1 [4], Table 4.6.3-128			
Information Element	Value/remark	Comment	Condition
RACH-ConfigCommon ::= SEQUENCE {			
rach-ConfigGeneric	RACH-ConfigGeneric		
ssb_perRACH_OccasionAndCB_PreamblesPerSSB CHOICE {			
one	n36		
}			
prach-RootSequenceIndex CHOICE {			
1139	Set according to table 4.4.2-2 in TS 38.508-1 [4] for the NR Cell		
1839	Set according to table 4.4.2-2 in TS 38.508-1 [4] for the NR Cell.	PRACH Preamble format 0 used	FR1,
}			
}			

Table 7.1.1.1.1a.3.3-6: RACH-ConfigGeneric (Table 7.1.1.1.1a.3.3-5)

Derivation Path: TS 38.508-1 [4], Table 4.6.3-130			
Information Element	Value/remark	Comment	Condition
RACH-ConfigGeneric ::= SEQUENCE {			
preambleTransMax	n4		
prach-ConfigurationIndex	14		FR1
	149		FR2
zeroCorrelationZoneConfig	12		FR1
	15		FR2
}			

Table 7.1.1.1.1a.3.3-7: TDD-UL-DL-ConfigCommon (Table 7.1.1.1.1a.3.3-3)

Derivation Path: TS 38.508-1 [4], Table 4.6.3-192			
Information Element	Value/remark	Comment	Condition
TDD-UL-DL-ConfigCommon ::= SEQUENCE {			
referenceSubcarrierSpacing	SubcarrierSpacing		
pattern1 SEQUENCE {			
dl-UL-TransmissionPeriodicity	ms5		FR1
	ms0p625		FR2
nrofDownlinkSlots	3		FR1_30kHz
	1		FR1_15kHz
	3		FR2
nrofDownlinkSymbols	6		FR1
	10		FR2
nrofUplinkSlots	2		FR1_30kHz
	1		FR1_15kHz
	1		FR2
nrofUplinkSymbols	4		
	2		FR2
dl-UL-TransmissionPeriodicity-v1530	ms3		FR1
}			
pattern2	Not present		
pattern2 SEQUENCE {			FR1
dl-UL-TransmissionPeriodicity	ms2		
nrofDownlinkSlots	4		FR1_30kHz
	2		FR1_15kHz
nrofDownlinkSymbols	0		
nrofUplinkSlots	0		
nrofUplinkSymbols	0		
}			
}			

Table 7.1.1.1.1a.3.3-8: ServingCellConfig (Table 7.1.1.1.1a.3.3-2)

Derivation Path: TS 38.508-1 [4], Table 4.6.3-167			
Information Element	Value/remark	Comment	Condition
ServingCellConfig ::= SEQUENCE {			
uplinkConfig SEQUENCE {			
initialUplinkBWP	BWP-UplinkDedicated		
}			
}			

Table 7.1.1.1.1a.3.3-9: BWP-UplinkDedicated (Table 7.1.1.1.1a.3.3-8)

Derivation Path: TS 38.508-1 [4], Table 4.6.3-15			
Information Element	Value/remark	Comment	Condition
BWP-UplinkDedicated ::= SEQUENCE {			
pucch-Config CHOICE {			
setup	PUCCH-Config		
}			
}			

Table 7.1.1.1.1a.3.3-10: PUCCH-Config (Table 7.1.1.1.1a.3.3-9)

Derivation Path: TS 38.508-1 [4], Table 4.6.3-112			
Information Element	Value/remark	Comment	Condition
PUCCH-Config ::= SEQUENCE {			
schedulingRequestResourceToAddModList	1 entry		
SEQUENCE (SIZE (1..maxNrofSR-Resources)) OF			
SchedulingRequestResourceConfig {			
SchedulingRequestResourceConfig	SchedulingRequestResourceConfig	entry 1	
}			
}			

Table 7.1.1.1.1a.3.3-11: SchedulingRequestResourceConfig (Table 7.1.1.1.1a.3.3-10)

Derivation Path: TS 38.508-1 [4], Table 4.6.3-112			
Information Element	Value/remark	Comment	Condition
SchedulingRequestResourceConfig ::= SEQUENCE {			
periodicityAndOffset CHOICE {			
sl10	2	With SCS = kHz15 results in repetition every 10 ms	SCS_15kHz
sl20	5	With SCS = kHz30 results in repetition every 10 ms	SCS_30kHz
sl80	4	With SCS = kHz120 results in repetition every 10 ms	SCS_120kHz
}			
}			

7.1.1.1.2 Random access procedure / Successful / C-RNTI Based / Preamble selected by MAC itself

7.1.1.1.2.1 Test Purpose (TP)

(1)

```
with { UE in RRC_Connected NR SpCell TimeAlignmentTimer expired, and has UL Data to send }
ensure that {
  when { the UL MAC PDU Size is less than messageSizeGroupA }
  then { UE transmits a random access preamble using a preamble in group A of random access
preambles }
}
```

(2)

```
with { UE in RRC_Connected state after transmission of a PRACH preamble on NR SpCell }
ensure that {
```

```

when { SS does not answer with a matching Random Access Response within ra-ResponseWindowSize }
then { UE retransmits a PRACH preamble from same group }
}

```

(3)

```

with { UE in RRC_Connected state after transmission of a PRACH preamble on NR SpCell }
ensure that {
  when { UE receives while ra-ResponseWindowSizeTimer is running MAC PDU containing multiple RARs
but none of the subheaders contains a RAPID corresponding to the UE }
  then { UE retransmits a PRACH preamble from same group }
}

```

(4)

```

with { UE in RRC_Connected state after transmission of a PRACH preamble on NR SpCell }
ensure that {
  when { SS sends a Random Access Response including a Backoff Indicator and the Random Access
Preamble identifier is different from the value received from the UE }
  then { UE triggers RA preamble after a random time between 0 and the indicated Backoff parameter
from same group }
}

```

(5)

```

with { UE in RRC_Connected state after transmission of a PRACH preamble on NR SpCell }
ensure that {
  when { UE receives while ra-ResponseWindowSizeTimer is running MAC PDU containing multiple RARs
and one of the subheaders contains a RAPID corresponding to the UE and containing Backoff Indicator
}
  then { UE stores Backoff Indicator UE transmits RACH procedure MSG3 }
}

```

(6)

```

with { UE in RRC_Connected state after transmission of Msg3 on NR SpCell without dedicated preamble
}
ensure that {
  when { The SS does not schedule any PDCCH transmission addressed to UE C-RNTI before Contention
resolution timer expiry }
  then { UE transmits a random access preamble using a preamble in the same group of random access
preambles as used for the first transmission of Msg3 }
}

```

(7)

```

with { UE in RRC_Connected state after transmission of Msg3 on NR SpCell without dedicated preamble
}
ensure that {
  when { UE receive PDCCH transmission addressed to its C-RNTI before Contention resolution timer
expiry }
  then { UE considers RACH procedure as complete }
}

```

(8)

```

with { UE in RRC_CONNECTED state and Random Access Preambles group B is configured }
ensure that {
  when { UE has data available for transmission and the MAC PDU Size carrying this data is greater
than ra-Msg3SizeGroupA and TimeAlignmentTimer expires }
  then {UE transmits a random access preamble using a preamble in group B of random access
preambles}
}

```

(9)

```

with { UE in RRC_Connected state and having initiated a random access procedure in NR SpCell }
ensure that {
  when { The SS transmits a Timing Advance Command in a Random Access Response message }
  then {the UE applies the received Timing Advance value in the next transmitted MAC PDU }
}

```

7.1.1.1.2.2 Conformance requirements

References: The conformance requirements covered in the present test case are specified in: TS 38.321, clauses 5.1.2, 5.1.3, 5.1.4, 5.1.5, 5.2, 6.1.3.2, 6.1.5 and 6.2.3. Unless otherwise stated these are Rel-15 requirements.

[TS 38.321, clause 5.1.2]

The MAC entity shall:

...

1> else (i.e. for the contention-based Random Access preamble selection):

2> if at least one of the SSBs with SS-RSRP above $rsrp-ThresholdSSB$ is available:

3> select an SSB with SS-RSRP above $rsrp-ThresholdSSB$.

2> else:

3> select any SSB.

2> if Msg3 has not yet been transmitted:

3> if Random Access Preambles group B is configured:

4> if the potential Msg3 size (UL data available for transmission plus MAC header and, where required, MAC CEs) is greater than $ra-Msg3SizeGroupA$ and the pathloss is less than $PCMAX$ (of the Serving Cell performing the Random Access Procedure) $-preambleReceivedTargetPower - msg3-DeltaPreamble - messagePowerOffsetGroupB$; or

4> if the Random Access procedure was initiated for the CCCH logical channel and the CCCH SDU size plus MAC subheader is greater than $ra-Msg3SizeGroupA$: 5> select the Random Access Preambles group B.

4> else:

5> select the Random Access Preambles group A.

3> else:

4> select the Random Access Preambles group A.

2> else (i.e. Msg3 is being retransmitted):

3> select the same group of Random Access Preambles as was used for the Random Access Preamble transmission attempt corresponding to the first transmission of Msg3.

2> if the association between Random Access Preambles and SSBs is configured:

3> select a Random Access Preamble randomly with equal probability from the Random Access Preambles associated with the selected SSB and the selected Random Access Preambles group.

2> else:

3> select a Random Access Preamble randomly with equal probability from the Random Access Preambles within the selected Random Access Preambles group.

2> set the *PREAMBLE_INDEX* to the selected *ra-PreambleIndex*.

...

1> if the Random Access procedure was initiated for SI request (as specified in TS 38.331 [5]); and

1> if *ra-AssociationPeriodIndex* and *si-RequestPeriod* are configured:

2> determine the next available PRACH occasion from the PRACH occasions corresponding to the selected SSB in the association period given by *ra-AssociationPeriodIndex* in the *si-RequestPeriod* permitted by the restrictions given by the *ra-ssb-OccasionMaskIndex* (the MAC entity shall select a PRACH occasion

randomly with equal probability amongst the consecutive PRACH occasions according to subclause 8.1 of TS 38.213 [6] corresponding to the selected SSB).

- 1> else if an SSB is selected above:
 - 2> determine the next available PRACH occasion from the PRACH occasions corresponding to the selected SSB permitted by the restrictions given by the *ra-ssb-OccasionMaskIndex* if configured (the MAC entity shall select a PRACH occasion randomly with equal probability amongst the consecutive PRACH occasions according to subclause 8.1 of TS 38.213 [6], corresponding to the selected SSB; the MAC entity may take into account the possible occurrence of measurement gaps when determining the next available PRACH occasion corresponding to the selected SSB).
- 1> else if a CSI-RS is selected above:
 - 2> if there is no contention-free Random Access Resource associated with the selected CSI-RS:
 - 3> determine the next available PRACH occasion from the PRACH occasions, permitted by the restrictions given by the *ra-ssb-OccasionMaskIndex* if configured, corresponding to the SSB in *candidateBeamRSList* which is quasi-collocated with the selected CSI-RS as specified in TS 38.214 [7] (the MAC entity may take into account the possible occurrence of measurement gaps when determining the next available PRACH occasion corresponding to the SSB which is quasi-collocated with the selected CSI-RS).
 - 2> else:
 - 3> determine the next available PRACH occasion from the PRACH occasions in *ra-OccasionList* corresponding to the selected CSI-RS (the MAC entity shall select a PRACH occasion randomly with equal probability amongst the PRACH occasions occurring simultaneously but on different subcarriers, corresponding to the selected CSI-RS; the MAC entity may take into account the possible occurrence of measurement gaps when determining the next available PRACH occasion corresponding to the selected CSI-RS).
- 1> perform the Random Access Preamble transmission procedure (see subclause 5.1.3).

[TS 38.321, clause 5.1.3]

The MAC entity shall, for each Random Access Preamble:

- 1> if *PREAMBLE_TRANSMISSION_COUNTER* is greater than one; and
- 1> if the notification of suspending power ramping counter has not been received from lower layers; and
- 1> if SSB selected is not changed (i.e. same as the previous Random Access Preamble transmission):
 - 2> increment *PREAMBLE_POWER_RAMPING_COUNTER* by 1.
- 1> select the value of *DELTA_PREAMBLE* according to subclause 7.3;
- 1> set *PREAMBLE_RECEIVED_TARGET_POWER* to $\text{preambleReceivedTargetPower} + \text{DELTA_PREAMBLE} + (\text{PREAMBLE_POWER_RAMPING_COUNTER} - 1) \times \text{PREAMBLE_POWER_RAMPING_STEP}$;
- 1> except for contention-free Random Access Preamble for beam failure recovery request, compute the RA-RNTI associated with the PRACH occasion in which the Random Access Preamble is transmitted;
- 1> instruct the physical layer to transmit the Random Access Preamble using the selected PRACH, corresponding RA-RNTI (if available), *PREAMBLE_INDEX* and *PREAMBLE_RECEIVED_TARGET_POWER*.

The RA-RNTI associated with the PRACH in which the Random Access Preamble is transmitted, is computed as:

$$\text{RA-RNTI} = 1 + s_id + 14 \times t_id + 14 \times 80 \times f_id + 14 \times 80 \times 8 \times ul_carrier_id$$

where *s_id* is the index of the first OFDM symbol of the specified PRACH ($0 \leq s_id < 14$), *t_id* is the index of the first slot of the specified PRACH in a system frame ($0 \leq t_id < 80$), *f_id* is the index of the specified PRACH in the frequency domain ($0 \leq f_id < 8$), and *ul_carrier_id* is the UL carrier used for Msg1 transmission (0 for NUL carrier, and 1 for SUL carrier).

[TS 38.321, clause 5.1.4]

Once the Random Access Preamble is transmitted and regardless of the possible occurrence of a measurement gap, the MAC entity shall:

...

1> else:

2> start the *ra-ResponseWindow* configured in *RACH-ConfigCommon* at the first PDCCH occasion as specified in TS 38.213 [6] from the end of the Random Access Preamble transmission;

2> monitor the PDCCH of the SpCell for Random Access Response(s) identified by the RA-RNTI while the *ra-ResponseWindow* is running.

1> if notification of a reception of a PDCCH transmission is received from lower layers on the Serving Cell where the preamble was transmitted; and

1> if PDCCH transmission is addressed to the C-RNTI; and

1> if the contention-free Random Access Preamble for beam failure recovery request was transmitted by the MAC entity:

2> consider the Random Access procedure successfully completed.

1> else if a downlink assignment has been received on the PDCCH for the RA-RNTI and the received TB is successfully decoded:

2> if the Random Access Response contains a MAC subPDU with Backoff Indicator:

3> set the *PREAMBLE_BACKOFF* to value of the BI field of the MAC subPDU using Table 7.2-1, multiplied with *SCALING_FACTOR_BI*.

2> else:

3> set the *PREAMBLE_BACKOFF* to 0 ms.

2> if the Random Access Response contains a MAC subPDU with Random Access Preamble identifier corresponding to the transmitted *PREAMBLE_INDEX* (see subclause 5.1.3):

3> consider this Random Access Response reception successful.

2> if the Random Access Response reception is considered successful:

3> if the Random Access Response includes RAPID only:

4> consider this Random Access procedure successfully completed;

4> indicate the reception of an acknowledgement for the SI request to upper layers.

3> else:

4> apply the following actions for the Serving Cell where the Random Access Preamble was transmitted:

5> process the received Timing Advance Command (see subclause 5.2);

5> indicate the *preambleReceivedTargetPower* and the amount of power ramping applied to the latest Random Access Preamble transmission to lower layers (i.e. $(PREAMBLE_POWER_RAMPING_COUNTER - 1) \times preamblePowerRampingStep$).

5> if the Serving Cell for the Random Access procedure is SRS-only SCell:

6> ignore the received UL grant.

5> else:

6> process the received UL grant value and indicate it to the lower layers.

4> if the Random Access Preamble was not selected by the MAC entity among the contention-based Random Access Preamble(s):

- 5> consider the Random Access procedure successfully completed.
- 4> else:
 - 5> set the *TEMPORARY_C-RNTI* to the value received in the Random Access Response;
- ...
- 1> if *ra-ResponseWindow* configured in *RACH-ConfigCommon* expires, and if the Random Access Response containing Random Access Preamble identifiers that matches the transmitted *PREAMBLE_INDEX* has not been received; or
- 1> if *ra-ResponseWindow* configured in *BeamFailureRecoveryConfig* expires and if the PDCCH addressed to the C-RNTI has not been received on the Serving Cell where the preamble was transmitted:
 - 2> consider the Random Access Response reception not successful;
 - 2> increment *PREAMBLE_TRANSMISSION_COUNTER* by 1;
 - 2> if *PREAMBLE_TRANSMISSION_COUNTER* = *preambleTxMax* + 1:
 - 3> if the Random Access Preamble is transmitted on the SpCell:
 - 4> indicate a Random Access problem to upper layers.
 - 4> if this Random Access procedure was triggered for SI request:
 - 5> consider the Random Access procedure unsuccessfully completed.
 - > else if the Random Access Preamble is transmitted on a SCell:
 - 4> consider the Random Access procedure unsuccessfully completed.
 - 2> if the Random Access procedure is not completed:
 - 3> select a random backoff time according to a uniform distribution between 0 and the *PREAMBLE_BACKOFF*;
 - 3> if the criteria (as defined in subclause 5.1.2) to select contention-free Random Access Resources is met during the backoff time:
 - 4> perform the Random Access Resource selection procedure (see subclause 5.1.2);
 - 3> else:
 - 4> perform the Random Access Resource selection procedure (see subclause 5.1.2) after the backoff time.

The MAC entity may stop *ra-ResponseWindow* (and hence monitoring for Random Access Response(s)) after successful reception of a Random Access Response containing Random Access Preamble identifiers that matches the transmitted *PREAMBLE_INDEX*.

HARQ operation is not applicable to the Random Access Response transmission.

[TS 38.321, clause 5.1.5]

Once Msg3 is transmitted, the MAC entity shall:

- 1> start the *ra-ContentionResolutionTimer* and restart the *ra-ContentionResolutionTimer* at each HARQ retransmission in the first symbol after the end of the Msg3 transmission;
- 1> monitor the PDCCH while the *ra-ContentionResolutionTimer* is running regardless of the possible occurrence of a measurement gap;
- 1> if notification of a reception of a PDCCH transmission of the SpCell is received from lower layers:
 - 2> if the C-RNTI MAC CE was included in Msg3:

- 3> if the Random Access procedure was initiated by the MAC sublayer itself or by the RRC sublayer and the PDCCH transmission is addressed to the C-RNTI and contains a UL grant for a new transmission; or
- 3> if the Random Access procedure was initiated by a PDCCH order and the PDCCH transmission is addressed to the C-RNTI; or
- 3> if the Random Access procedure was initiated by a beam failure indication from lower layer and the PDCCH transmission is addressed to the C-RNTI:
 - 4> consider this Contention Resolution successful;
 - 4> stop *ra-ContentionResolutionTimer*;
 - 4> discard the *TEMPORARY_C-RNTI*;
 - 4> consider this Random Access procedure successfully completed.

...

- 1> if *ra-ContentionResolutionTimer* expires:
 - 2> discard the *TEMPORARY_C-RNTI*;
 - 2> consider the Contention Resolution not successful.
- 1> if the Contention Resolution is considered not successful:
 - 2> flush the HARQ buffer used for transmission of the MAC PDU in the Msg3 buffer;
 - 2> increment *PREAMBLE_TRANSMISSION_COUNTER* by 1;
 - 2> if *PREAMBLE_TRANSMISSION_COUNTER* = *preambleTxMax* + 1:
 - 3> indicate a Random Access problem to upper layers.
 - 3> if this Random Access procedure was triggered for SI request:
 - 4> consider the Random Access procedure unsuccessfully completed.
 - 2> if the Random Access procedure is not completed:
 - 3> select a random backoff time according to a uniform distribution between 0 and the *PREAMBLE_BACKOFF*;
 - 3> if the criteria (as defined in subclause 5.1.2) to select contention-free Random Access Resources is met during the backoff time:
 - 4> perform the Random Access Resource selection procedure (see subclause 5.1.2);
 - 3> else:
 - 4> perform the Random Access Resource selection procedure (see subclause 5.1.2) after the backoff time.

[TS 38.321, clause 5.2]

RRC configures the following parameters for the maintenance of UL time alignment:

- *timeAlignmentTimer* (per TAG) which controls how long the MAC entity considers the Serving Cells belonging to the associated TAG to be uplink time aligned.

The MAC entity shall:

- 1> when a Timing Advance Command MAC CE is received, and if a N_{TA} (as defined in TS 38.211 [8]) has been maintained with the indicated TAG:
- 2> apply the Timing Advance Command for the indicated TAG;

2> start or restart the *timeAlignmentTimer* associated with the indicated TAG.

...

1> when a *timeAlignmentTimer* expires:

2> if the *timeAlignmentTimer* is associated with the PTAG:

- 3> flush all HARQ buffers for all Serving Cells;
- 3> notify RRC to release PUCCH for all Serving Cells, if configured;
- 3> notify RRC to release SRS for all Serving Cells, if configured;
- 3> clear any configured downlink assignments and configured uplink grants;
- 3> clear any PUSCH resource for semi-persistent CSI reporting;
- 3> consider all running *timeAlignmentTimers* as expired;
- 3> maintain N_{TA} (defined in TS 38.211 [8]) of all TAGs.

2> else if the *timeAlignmentTimer* is associated with an STAG, then for all Serving Cells belonging to this TAG:

- 3> flush all HARQ buffers;
- 3> notify RRC to release PUCCH, if configured;
- 3> notify RRC to release SRS, if configured;
- 3> clear any configured downlink assignments and configured uplink grants;
- 3> clear any PUSCH resource for semi-persistent CSI reporting;
- 3> maintain N_{TA} (defined in TS 38.211 [8]) of this TAG.

When the MAC entity stops uplink transmissions for an SCell due to the fact that the maximum uplink transmission timing difference between TAGs of the MAC entity or the maximum uplink transmission timing difference between TAGs of any MAC entity of the UE is exceeded, the MAC entity considers the *timeAlignmentTimer* associated with the SCell as expired.

The MAC entity shall not perform any uplink transmission on a Serving Cell except the Random Access Preamble transmission when the *timeAlignmentTimer* associated with the TAG to which this Serving Cell belongs is not running. Furthermore, when the *timeAlignmentTimer* associated with the pTAG is not running, the MAC entity shall not perform any uplink transmission on any Serving Cell except the Random Access Preamble transmission on the SpCell.

[TS 38.321, clause 6.1.3.2]

The C-RNTI MAC CE is identified by MAC PDU subheader with LCID as specified in Table 6.2.1-2.

It has a fixed size and consists of a single field defined as follows (Figure 6.1.3.2-1):

- C-RNTI: This field contains the C-RNTI of the MAC entity. The length of the field is 16 bits.

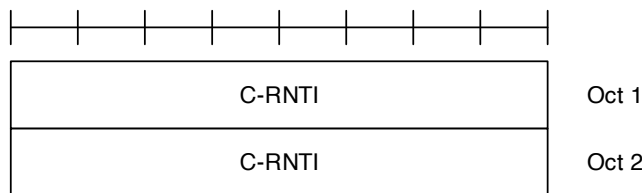

Figure 6.1.3.2-1: C-RNTI MAC CE

[TS 38.321, clause 6.1.5]

A MAC PDU consists of one or more MAC subPDUs and optionally padding. Each MAC subPDU consists one of the following:

- a MAC subheader with Backoff Indicator only;
- a MAC subheader with RAPID only (i.e. acknowledgment for SI request);
- a MAC subheader with RAPID and MAC RAR.

A MAC subheader with Backoff Indicator consists of five header fields E/T/R/R/BI as described in Figure 6.1.5-1. A MAC subPDU with Backoff Indicator only is placed at the beginning of the MAC PDU, if included. 'MAC subPDU(s) with RAPID only' and 'MAC subPDU(s) with RAPID and MAC RAR' can be placed anywhere between MAC subPDU with Backoff Indicator only (if any) and padding (if any).

A MAC subheader with RAPID consists of three header fields E/T/RAPID as described in Figure 6.1.5-2.

Padding is placed at the end of the MAC PDU if present. Presence and length of padding is implicit based on TB size, size of MAC subPDU(s).

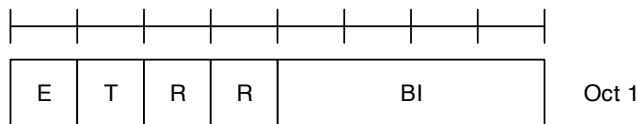

Figure 6.1.5-1: E/T/R/R/BI MAC subheader

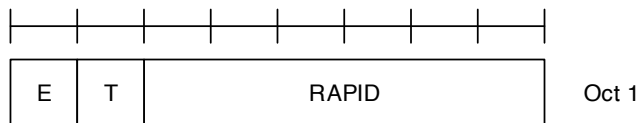

Figure 6.1.5-2: E/T/RAPID MAC subheader

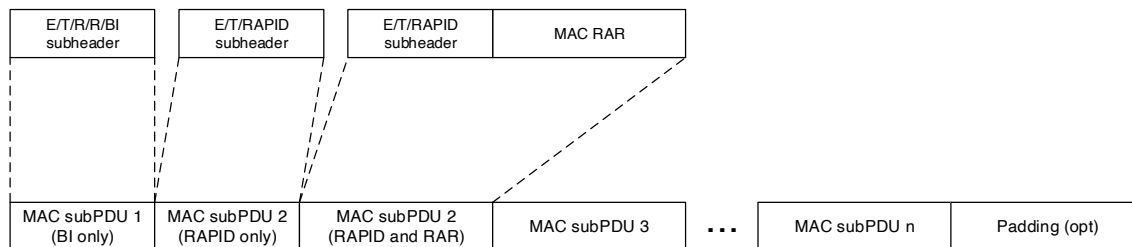

Figure 6.1.5-3: Example of MAC PDU consisting of MAC RARs

[TS 38.321, clause 6.2.3]

The MAC RAR is of fixed size as depicted in Figure 6.2.3-1, and consists of the following fields:

- R: Reserved bit, set to "0";
- Timing Advance Command: The Timing Advance Command field indicates the index value T_A used to control the amount of timing adjustment that the MAC entity has to apply in TS 38.213 [6]. The size of the Timing Advance Command field is 12 bits;
- UL Grant: The Uplink Grant field indicates the resources to be used on the uplink in TS 38.213 [6]. The size of the UL Grant field is 27 bits;

- Temporary C-RNTI: The Temporary C-RNTI field indicates the temporary identity that is used by the MAC entity during Random Access. The size of the Temporary C-RNTI field is 16 bits.

The MAC RAR is octet aligned.

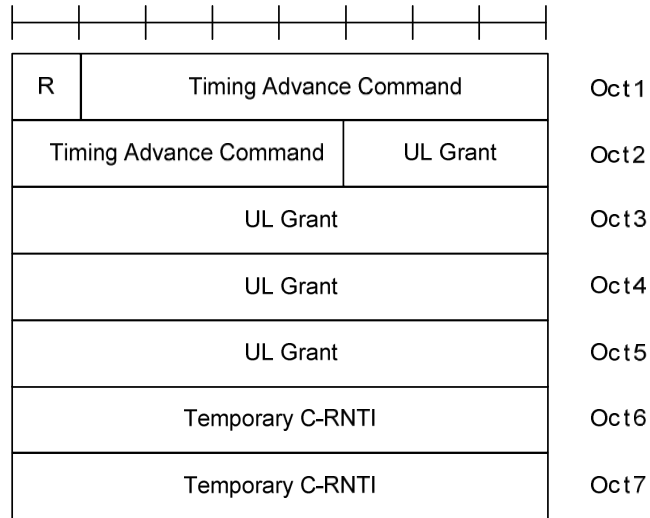

Figure 6.2.3-1: MAC RAR

7.1.1.1.2.3 Test description

7.1.1.1.2.3.1 Pre-test conditions

Same Pre-test conditions as in clause 7.1.1.0.

7.1.1.1.2.3.2 Test procedure sequence

Table 7.1.1.1.2.3.2-1: Main behaviour

St	Procedure	Message Sequence		TP	Verdict
		U - S	Message		
-	EXCEPTION: Step 0AA is performed IF pc_NG_RAN_NR only.	-	-	-	-
0AA	The SS transmits an updated system information as specified in Table 7.1.1.1.2.3.3-1A.	-	-	-	-
0A	SS transmits an RRCReconfiguration message to configure specific parameters. Note 1	<--	RRCReconfiguration	-	-
0B	The UE transmits RRCReconfigurationComplete message. Note 2	-->	RRCReconfigurationComplete	-	-
1	SS transmits Timing Advance command to SpCell. SS does not send any subsequent timing alignments. Start Timer_T1 = Time Alignment timer value on SS.	<--	MAC PDU (Timing Advance Command MAC Control Element)	-	-
2	40 to 50 TTI before Timer_T1 expires the SS transmits a MAC PDU containing a PDCP SDU of size 56 bits, less than ra-Msg3SizeGroupA(208 bits) on SpCell . (Note 3)	<--	MAC PDU	-	-
3	The SS ignores scheduling requests and does not allocate any uplink grant.	-	-	-	-
4	Check: Does the UE transmit preamble on PRACH using a preamble in group A defined in CellGroupConfig in RRCReconfiguration (totalNumberOfRA-Preambles, ssb-perRACH-OccasionAndCB-PreamblesPerSSB and numberOfRA-PreamblesGroupA) on SpCell in frame number X meeting condition $n_{SFN} \bmod 8 = 1$, subframe number 2,6,9 (FDD FR1), frame number X meeting condition $n_{SFN} \bmod 2 = 1$, subframe number 4,9 (FR1 TDD) and frame number X meeting condition $n_{SFN} \bmod 4 = 1$ and slot number 8, 9, 18, 19, 28, 29, 38, 39, 48, 49, 58, 59, 68, 69, 78, 79 (FR2 120 kHz)?	-->	PRACH Preamble	1	P
5	Check: does the UE transmit a preamble on PRACH, in frame number X+8 subframe number 2,6,9 (FDD FR1), in frame number X or X+2 in subframe number 4,9 (FR1 TDD) and frame number X or X+4 and slot number 8, 9, 18, 19, 28, 29, 38, 39, 48, 49, 58, 59, 68, 69, 78, 79 (FR2 120 kHz) using the same group A?	-->	PRACH Preamble	2	P
6	The SS transmits a MAC PDU addressed to UE RA-RNTI, containing multiple RARs but none of the MAC sub headers contains a matching RAPID on SpCell	<--	Random Access Response	-	-
-	EXCEPTION: In parallel with step 7, parallel behaviour defined in table 7.1.1.1.2.3.2-2 is executed	-	-	-	-
7	Check: Does the UE re-transmit a preamble on PRACH on SpCell using the same group A?	-->	PRACH Preamble	3	P
8	The SS transmits a Random Access Response with the back off parameter set to value Index field '12' and with the Random Access Preamble identifier different from the value received from the UE in the Random Access Preamble. The SS sets Timer_T2 to the Back off value '960' associated with the Index value '12' and starts Timer_T2.	<--	Random Access Response(BI, RAPID)	-	-

9	Check: Does UE send a Random Access Preamble on SpCell while Timer_T2 is running ?	-->	Random Access Preamble	4	P
10	SS sends Random Access Response with an UL Grant of 56-bits, a back off parameter set to value Index field '13' and the Random Access Preamble identifier value set to the same value as received from the UE in the Random Access Preamble. (Note 4)	<--	Random Access Response(BI, RAPID)	-	-
11	Check: Does UE sends a msg3 in the grant associated to the Random Access 'Response received in step 10 on SpCell?	-->	msg3 (C-RNTI MAC CONTROL ELEMENT)	5	P
12	SS does not schedule any PDCCH transmission for UE C-RNTI. The SS sets Timer_T3 to the Back off value '1920' associated with the Index value '13' plus Contention Resolution Timer and starts Timer_T3.	-	-	-	-
13	Check: Does the UE transmit preamble on PRACH using a preamble belonging to group A for time equal to Timer_T3 on SpCell?	-->	PRACH Preamble	6	P
14	The SS transmits Random Access Response with an UL Grant of 56-bits and RAPID corresponding to the transmitted Preamble in step 13, including T-CRNTI.	<--	Random Access Response	-	-
15	UE sends a msg3 using the grant associated to the Random Access 'Response received in step 14 on SpCell?	-->	msg3 (C-RNTI MAC CONTROL ELEMENT)	-	-
16	SS schedules PDCCH transmission for UE C_RNTI and allocate uplink grant.	<--	Contention Resolution	-	-
-	EXCEPTION: In parallel with step 17, parallel behaviour defined in table 7.1.1.1.2.3.2-3 is executed	-	-	-	-
17	The UE transmits a MAC PDU with C-RNTI containing looped back PDCP SDU	-->	MAC PDU	7	P
-	EXCEPTION: Step 17AA is performed IF pc_NG_RAN_NR only.	-	-	-	-
17A A	The SS transmits an updated system information as specified in Table 7.1.1.1.2.3.3-1A.	-	-	-	-
17A	The SS transmits an RRCReconfiguration message to configure specific parameters. Note 1.	<--	NR RRC: RRCReconfiguration	-	-
17B	The UE transmits an RRCReconfigurationComplete message. Note 2	-->	NR RRC: RRCReconfigurationComplete	-	-
18	SS transmits Timing Advance command to SpCell. SS does not send any subsequent timing alignments. Start Timer_T4 = Time Alignment timer value on SS	<--	MAC PDU (Timing Advance Command MAC Control Element)	-	-
19	40 to 50 TTI before Timer_T4 expires the SS transmits a MAC PDU containing a PDCP SDU of size > ra-Msg3SizeGroupA(208 bits)	<--	MAC PDU	-	-
20	The SS ignores scheduling requests and does not allocate any uplink grant.	-	-	-	-
21	Check: Does the UE transmit preamble on PRACH using a preamble in group B defined in CellGroupConfig in RRCReconfiguration (ssb-perRACH-OccasionAndCB-PreamblesPerSSB, numberOfRA-PreamblesGroupA and numberOfRA-Preambles) on SpCell?	-->	PRACH Preamble	8	P
22	The SS transmits Random Access Response with an UL Grant of 56-bits and RAPID corresponding to the transmitted Preamble in step 21, including T-CRNTI.	<--	Random Access Response	-	-

23	UE sends a msg3 using the grant associated to the Random Access Response received in step 22 on SpCell?	-->	msg3 (C-RNTI MAC CONTROL ELEMENT)	-	-
23A	SS schedules PDCCH transmission for UE C-RNTI and allocate uplink grant.	<--	Contention Resolution	-	-
24	The UE transmits a MAC PDU with C-RNTI containing looped back PDCP SDU	-->	MAC PDU	9	P
<p>Note 1: for EN-DC the NR <i>RRCReconfiguration</i> message is contained in <i>RRCConnectionReconfiguration</i>.</p> <p>Note 2: for EN-DC the NR <i>RRCReconfigurationComplete</i> message is contained in <i>RRCConnectionReconfigurationComplete</i>.</p> <p>Note 3: MAC PDU size of 56bits is selected to allow UE send status PDU and still stays below the limit of <i>ra-Msg3SizeGroupA</i>.</p> <p>Note 4: UL grant of 56bits is to make UE not send any loopback data in uplink with msg3.</p>					

Table 7.1.1.1.2.3.2-2: Parallel behaviour

St	Procedure	Message Sequence		TP	Verdict
		U - S	Message		
1	Check: Does the UE transmit msg3 message on SpCell?	-->	msg3 (C-RNTI MAC CONTROL ELEMENT)	-	F

Table 7.1.1.1.2.3.2-3: Parallel behaviour

St	Procedure	Message Sequence		TP	Verdict
		U - S	Message		
1	Check: Does the UE transmit an PRACH preamble on SpCell?	-->	PRACH Preamble	-	F

7.1.1.1.2.3.3 Specific message contents

Table 7.1.1.1.2.3.3-1: MAC-CellGroupConfig (preamble)

Derivation Path: TS 38.508-1 [4], Table 4.6.3-68			
Information Element	Value/remark	Comment	Condition
MAC-CellGroupConfig ::= SEQUENCE {			
tag-Config SEQUENCE {			
tag-ToAddModList SEQUENCE (SIZE (1..maxNrofTAGs)) OF TAG {	1 entry		
TAG[1] SEQUENCE {		entry 1	
timeAlignmentTimer	ms750		
}			
}			
}			
}			

Table 7.1.1.1.2.3.3-1A: SystemInformationBlockType1 (step 0AA and 17AA, Table 7.1.1.1.2.3.2-1)

Derivation path: 38.508-1 [4] table 4.6.1-28			
Information Element	Value/Remark	Comment	Condition
SIB1 ::= SEQUENCE {			
servingCellConfigCommon	ServingCellConfigCommon	Same contents as in Table 7.1.1.1.2.3.3-4	
}			

Table 7.1.1.1.2.3.3-2: RRCReconfiguration (step 0A and step 17A, Table 7.1.1.1.2.3.2-1)

Derivation Path: TS 38.508-1 [4], Table 4.6.1-13			
Information Element	Value/remark	Comment	Condition
RRCReconfiguration ::= SEQUENCE {			
criticalExtensions CHOICE {		TS 38.508-1 [4], 2.	
rrcReconfiguration ::= SEQUENCE {			
secondaryCellGroup	CellGroupConfig	OCTET STRING (CONTAINING CellGroupConfig)	EN-DC
nonCriticalExtension SEQUENCE {			NR
masterCellGroup	CellGroupConfig	OCTET STRING (CONTAINING CellGroupConfig)	
}			
}			
}			
}			

Table 7.1.1.1.2.3.3-3: CellGroupConfig (Table 7.1.1.1.2.3.3-2)

Derivation Path: TS 38.508-1 [4], Table 4.6.3-19			
Information Element	Value/remark	Comment	Condition
CellGroupConfig ::= SEQUENCE {			
spCellConfig SEQUENCE {			
reconfigurationWithSync SEQUENCE {			
spCellConfigCommon	ServingCellConfigCommon		
newUE-Identity	RNTI-Value		
t304	ms2000		
rach-ConfigDedicated	Not Present		
}			

Table 7.1.1.1.2.3.3-4: ServingCellConfigCommon (Table 7.1.1.1.2.3.3-3, Table 7.1.1.1.2.3.3-1A)

Derivation Path: TS 38.508-1 [4], Table 4.6.3-168			
Information Element	Value/remark	Comment	Condition
ServingCellConfigCommon ::= SEQUENCE {			
uplinkConfigCommon SEQUENCE {			
initialUplinkBWP	BWP-UplinkCommon		
}			
}			

Table 7.1.1.1.2.3.3-5: BWP-UplinkCommon (Table 7.1.1.1.2.3.3-4)

Derivation Path: TS 38.508-1 [4], Table 4.6.3-10			
Information Element	Value/remark	Comment	Condition
BWP-UplinkCommon ::= SEQUENCE {			
rach-ConfigCommon CHOICE {			
setup	RACH-ConfigCommon		
}			
}			

Table 7.1.1.1.2.3.3-6: *RACH-ConfigCommon* (Table 7.1.1.1.2.3.3-4)

Derivation Path: TS 38.508-1 [4], Table 4.6.3-128			
Information Element	Value/remark	Comment	Condition
RACH-ConfigCommon ::= SEQUENCE {			
rach-ConfigGeneric	RACH-ConfigGeneric		
totalNumberOfRA-Preambles	42		
ssb-perRACH-OccasionAndCB-PreamblesPerSSB			
CHOICE {			
One	n32		
}			
groupBconfigured SEQUENCE {			
ra-Msg3SizeGroupA	b208		
messagePowerOffsetGroupB	minusinfinity		
numberOfRA-PreamblesGroupA	28		
}			
ra-ContentionResolutionTimer	sf48		
}			

Table 7.1.1.1.2.3.3-7: RACH-ConfigGeneric (Table 7.1.1.1.2.3.3-5)

Derivation Path: TS 38.508-1 [4], Table 4.6.3-130			
Information Element	Value/remark	Comment	Condition
RACH-ConfigGeneric ::= SEQUENCE { prach-ConfigurationIndex	119	As per Table 6.3.3.2-2: of TS 38.211 [24], this results in PRACH preamble transmission in a radio frame meeting $n_{SFN} \bmod 2=1$, subframe number 2, 6, 9 and starting symbol 0 using preamble Format A2.	FR1 FDD
prach-ConfigurationIndex	94	As per Table 6.3.3.2-3: of TS 38.211 [24], this results in PRACH preamble transmission in a radio frame meeting $n_{SFN} \bmod 2=1$, subframe number 4, 9 and starting symbol 0 using preamble Format A2.	FR1 TDD
prach-ConfigurationIndex	6	As per Table 6.3.3.2-4: of TS 38.211 [24] and clause 5.3.2 of TS 38.211 this results in PRACH preamble transmission in radio frame meeting $n_{SFN} \bmod 4 = 1$, slot number 8, 9, 18, 19, 28, 29, 38, 39, 48, 49, 58, 59, 68, 69, 78, 79 and starting symbol 0 using preamble format A1.	FR2 (120 kHz)
preambleReceivedTargetPower	dBm-104		
preambleTransMax	n10		
powerRampingStep	dB2		
ra-ResponseWindow	sl8		FR1 FDD and FR2 (120 kHz)
	sl20		FR1 TDD
}			

Table 7.1.1.1.2.3.3-8: SystemInformationBlockType1 (step 0A and step 17A, Table 7.1.1.1.2.3.2-1)

Derivation path: 38.508-1 [4] table 4.6.1-28			
Information Element	Value/Remark	Comment	Condition
SIB1 ::= SEQUENCE { servingCellConfigCommon	ServingCellConfigCommon	Same contents as in Table 7.1.1.1.2.3.3-3	
}			

7.1.1.1.3 Random access procedure / Successful / SI request

7.1.1.1.3.1 Test Purpose (TP)

(1)

```
with { UE in RRC_Idle State and need for Updated System information }
ensure that {
  when { UE transmitted PRACH preamble and ra-ResponseWindow has expired}
  then { UE retransmits the PRACH Preamble }
}
```

(2)

```
with { UE in RRC_Idle State and transmitted PRACH preamble for System information request }
ensure that {
  when { UE received a RAR message addressed to RA-RNTI and including matching RAPID only }
  then { UE considers the RACH procedure to be successfully completed and informs the upper layer }
}
```

(3)

```
with { UE in NR RRC_IDLE state }
ensure that {
  when { UE receives a short message transmitted on PDCCH using P-RNTI indicating a
systemInfoModification }
  then {UE re-acquires and applies the new system information }
}
```

7.1.1.1.3.2 Conformance requirements

References: The conformance requirements covered in the present TC are specified in: 3GPP TS 38.321, clause 5.1.2, 5.1.3, 5.1.4, and 6.1., 3GPP TS 38.331 clause 5.2.2.2.25. Unless otherwise stated these are Rel-15 requirements.

[TS 38.321, clause 5.1.2]

The MAC entity shall:

- 1> if the Random Access procedure was initiated for beam failure recovery (as specified in subclause 5.17); and
- 1> if the *beamFailureRecoveryTimer* (in subclause 5.17) is either running or not configured; and
- 1> if the contention-free Random Access Resources for beam failure recovery request associated with any of the SSBs and/or CSI-RSs have been explicitly provided by RRC; and
- 1> if at least one of the SSBs with SS-RSRP above *rsrp-ThresholdSSB* amongst the SSBs in *candidateBeamRSList* or the CSI-RSs with CSI-RSRP above *rsrp-ThresholdCSI-RS* amongst the CSI-RSs in *candidateBeamRSList* is available:
 - 2> select an SSB with SS-RSRP above *rsrp-ThresholdSSB* amongst the SSBs in *candidateBeamRSList* or a CSI-RS with CSI-RSRP above *rsrp-ThresholdCSI-RS* amongst the CSI-RSs in *candidateBeamRSList*;
- 2> if CSI-RS is selected, and there is no *ra-PreambleIndex* associated with the selected CSI-RS:

- 3> set the *PREAMBLE_INDEX* to a *ra-PreambleIndex* corresponding to the SSB in *candidateBeamRSList* which is quasi-collocated with the selected CSI-RS as specified in TS 38.214 [7].
- 2> else:
 - 3> set the *PREAMBLE_INDEX* to a *ra-PreambleIndex* corresponding to the selected SSB or CSI-RS from the set of Random Access Preambles for beam failure recovery request.
- 1> else if the *ra-PreambleIndex* has been explicitly provided by either PDCCH or RRC; and
- 1> if the *ra-PreambleIndex* is not 0b000000; and
- 1> if contention-free Random Access Resource associated with SSBs or CSI-RSs have not been explicitly provided by RRC:
 - 2> set the *PREAMBLE_INDEX* to the signalled *ra-PreambleIndex*.
- 1> else if the contention-free Random Access Resources associated with SSBs have been explicitly provided by RRC and at least one SSB with SS-RSRP above *rsrp-ThresholdSSB* amongst the associated SSBs is available:
 - 2> select an SSB with SS-RSRP above *rsrp-ThresholdSSB* amongst the associated SSBs;
 - 2> set the *PREAMBLE_INDEX* to a *ra-PreambleIndex* corresponding to the selected SSB.
- 1> else if the contention-free Random Access Resources associated with CSI-RSs have been explicitly provided by RRC and at least one CSI-RS with CSI-RSRP above *rsrp-ThresholdCSI-RS* amongst the associated CSI-RSs is available:
 - 2> select a CSI-RS with CSI-RSRP above *rsrp-ThresholdCSI-RS* amongst the associated CSI-RSs;
 - 2> set the *PREAMBLE_INDEX* to a *ra-PreambleIndex* corresponding to the selected CSI-RS.
- 1> else:
 - 2> if at least one of the SSBs with SS-RSRP above *rsrp-ThresholdSSB* is available:
 - 3> select an SSB with SS-RSRP above *rsrp-ThresholdSSB*.
 - 2> else:
 - 3> select any SSB.
 - 2> if Msg3 has not yet been transmitted:
 - 3> if Random Access Preambles group B is configured:
 - 4> if the potential Msg3 size (UL data available for transmission plus MAC header and, where required, MAC CEs) is greater than *ra-Msg3SizeGroupA* and the pathloss is less than $PCMAX$ (of the Serving Cell performing the Random Access Procedure) – $preambleReceivedTargetPower - msg3-DeltaPreamble - messagePowerOffsetGroupB$; or
 - 4> if the Random Access procedure was initiated for the CCCH logical channel and the CCCH SDU size plus MAC subheader is greater than *ra-Msg3SizeGroupA*:
 - 5> select the Random Access Preambles group B.
 - 4> else:
 - 5> select the Random Access Preambles group A.
 - 3> else:
 - 4> select the Random Access Preambles group A.
- 2> else (i.e. Msg3 is being retransmitted):
 - 3> select the same group of Random Access Preambles as was used for the Random Access Preamble transmission attempt corresponding to the first transmission of Msg3.

- 2> if the association between Random Access Preambles and SSBs is configured:
 - 3> select a *ra-PreambleIndex* randomly with equal probability from the Random Access Preambles associated with the selected SSB and the selected Random Access Preambles group.
- 2> else:
 - 3> select a *ra-PreambleIndex* randomly with equal probability from the Random Access Preambles within the selected Random Access Preambles group.
- 2> set the *PREAMBLE_INDEX* to the selected *ra-PreambleIndex*.
- 1> if an SSB is selected above and an association between PRACH occasions and SSBs is configured:
 - 2> determine the next available PRACH occasion from the PRACH occasions corresponding to the selected SSB permitted by the restrictions given by the *ra-ssb-OccasionMaskIndex* if configured (the MAC entity shall select a PRACH occasion randomly with equal probability amongst the PRACH occasions occurring simultaneously but on different subcarriers, corresponding to the selected SSB; the MAC entity may take into account the possible occurrence of measurement gaps when determining the next available PRACH occasion corresponding to the selected SSB).
- 1> else if a CSI-RS is selected above and an association between PRACH occasions and CSI-RSs is configured:
 - 2> determine the next available PRACH occasion from the PRACH occasions in *ra-OccasionList* corresponding to the selected CSI-RS (the MAC entity shall select a PRACH occasion randomly with equal probability amongst the PRACH occasions occurring simultaneously but on different subcarriers, corresponding to the selected CSI-RS; the MAC entity may take into account the possible occurrence of measurement gaps when determining the next available PRACH occasion corresponding to the selected CSI-RS).
- 1> else if Random Access procedure was initiated for beam failure recovery; and
- 1> if a CSI-RS is selected above and there is no contention-free Random Access Resource associated with the selected CSI-RS:
 - 2> determine the next available PRACH occasion from the PRACH occasions, permitted by the restrictions given by the *ra-ssb-OccasionMaskIndex* if configured, corresponding to the SSB in *candidateBeamRSList* which is quasi-collocated with the selected CSI-RS as specified in TS 38.214 [7] (the MAC entity may take into account the possible occurrence of measurement gaps when determining the next available PRACH occasion corresponding to the SSB which is quasi-collocated with the selected CSI-RS).
- 1> else:
 - 2> determine the next available PRACH occasion (the MAC entity shall select a PRACH occasion randomly with equal probability amongst the PRACH occasions occurring simultaneously but on different subcarriers; the MAC entity may take into account the possible occurrence of measurement gaps when determining the next available PRACH occasion).
- 1> perform the Random Access Preamble transmission procedure (see subclause 5.1.3).

[TS 38.321, clause 5.1.3]

The MAC entity shall, for each Random Access Preamble:

- 1> if *PREAMBLE_TRANSMISSION_COUNTER* is greater than one; and
- 1> if the notification of suspending power ramping counter has not been received from lower layers; and
- 1> if SSB selected is not changed (i.e. same as the previous Random Access Preamble transmission):
 - 2> increment *PREAMBLE_POWER_RAMPING_COUNTER* by 1.
- 1> select the value of *DELTA_PREAMBLE* according to subclause 7.3;
- 1> set *PREAMBLE_RECEIVED_TARGET_POWER* to $\text{preambleReceivedTargetPower} + \text{DELTA_PREAMBLE} + (\text{PREAMBLE_POWER_RAMPING_COUNTER} - 1) \times \text{PREAMBLE_POWER_RAMPING_STEP}$;

- 1> except for contention-free Random Access Preamble for beam failure recovery request, compute the RA-RNTI associated with the PRACH occasion in which the Random Access Preamble is transmitted;
- 1> instruct the physical layer to transmit the Random Access Preamble using the selected PRACH, corresponding RA-RNTI (if available), *PREAMBLE_INDEX* and *PREAMBLE_RECEIVED_TARGET_POWER*.

The RA-RNTI associated with the PRACH in which the Random Access Preamble is transmitted, is computed as:

$$\text{RA-RNTI} = 1 + s_id + 14 \times t_id + 14 \times 80 \times f_id + 14 \times 80 \times 8 \times ul_carrier_id$$

where *s_id* is the index of the first OFDM symbol of the specified PRACH ($0 \leq s_id < 14$), *t_id* is the index of the first slot of the specified PRACH in a system frame ($0 \leq t_id < 80$), *f_id* is the index of the specified PRACH in the frequency domain ($0 \leq f_id < 8$), and *ul_carrier_id* is the UL carrier used for Msg1 transmission (0 for NUL carrier, and 1 for SUL carrier).

[TS 38.321, clause 5.1.4]

Once the Random Access Preamble is transmitted and regardless of the possible occurrence of a measurement gap, the MAC entity shall:

- 1> if the contention-free Random Access Preamble for beam failure recovery request was transmitted by the MAC entity:
 - 2> start the *ra-ResponseWindow* configured in *BeamFailureRecoveryConfig* at the first PDCCH occasion as specified in TS 38.213 [6] from the end of the Random Access Preamble transmission;
 - 2> monitor the PDCCH of the SpCell for response to beam failure recovery request identified by the C-RNTI while *ra-ResponseWindow* is running.
- 1> else:
 - 2> start the *ra-ResponseWindow* configured in *RACH-ConfigCommon* at the first PDCCH occasion as specified in TS 38.213 [6] from the end of the Random Access Preamble transmission;
 - 2> monitor the PDCCH of the SpCell for Random Access Response(s) identified by the RA-RNTI while the *ra-ResponseWindow* is running.
- 1> if notification of a reception of a PDCCH transmission is received from lower layers; and
- 1> if PDCCH transmission is addressed to the C-RNTI; and
- 1> if the contention-free Random Access Preamble for beam failure recovery request was transmitted by the MAC entity:
 - 2> consider the Random Access procedure successfully completed.
- 1> else if a downlink assignment has been received on the PDCCH for the RA-RNTI and the received TB is successfully decoded:
 - 2> if the Random Access Response contains a MAC subPDU with Backoff Indicator:
 - 3> set the *PREAMBLE_BACKOFF* to value of the BI field of the MAC subPDU using Table 7.2-1, multiplied with *SCALING_FACTOR_BI*.
 - 2> else:
 - 3> set the *PREAMBLE_BACKOFF* to 0 ms.
 - 2> if the Random Access Response contains a MAC subPDU with Random Access Preamble identifier corresponding to the transmitted *PREAMBLE_INDEX* (see subclause 5.1.3):
 - 3> consider this Random Access Response reception successful.
 - 2> if the Random Access Response reception is considered successful:
 - 3> if the Random Access Response includes a MAC subPDU with RAPID only:

- 4> consider this Random Access procedure successfully completed;
- 4> indicate the reception of an acknowledgement for SI request to upper layers.
- 3> else:
 - 4> apply the following actions for the Serving Cell where the Random Access Preamble was transmitted:
 - 5> process the received Timing Advance Command (see subclause 5.2);
 - 5> indicate the *preambleReceivedTargetPower* and the amount of power ramping applied to the latest Random Access Preamble transmission to lower layers (i.e. $(PREAMBLE_POWER_RAMPING_COUNTER - 1) \times PREAMBLE_POWER_RAMPING_STEP$);
 - 5> if the Serving Cell for the Random Access procedure is SRS-only SCell:
 - 6> ignore the received UL grant.
 - 5> else:
 - 6> process the received UL grant value and indicate it to the lower layers.
 - 4> if the Random Access Preamble was not selected by the MAC entity among the contention-based Random Access Preamble(s):
 - 5> consider the Random Access procedure successfully completed.
 - 4> else:
 - 5> set the *TEMPORARY_C-RNTI* to the value received in the Random Access Response;
 - 5> if this is the first successfully received Random Access Response within this Random Access procedure:
 - 6> if the transmission is not being made for the CCCH logical channel:
 - 7> indicate to the Multiplexing and assembly entity to include a C-RNTI MAC CE in the subsequent uplink transmission.
 - 6> obtain the MAC PDU to transmit from the Multiplexing and assembly entity and store it in the Msg3 buffer.
- 1> if *ra-ResponseWindow* configured in *RACH-ConfigCommon* expires, and if the Random Access Response containing Random Access Preamble identifiers that matches the transmitted *PREAMBLE_INDEX* has not been received; or
- 1> if *ra-ResponseWindow* configured in *BeamFailureRecoveryConfig* expires and if the PDCCH addressed to the C-RNTI has not been received:
 - 2> consider the Random Access Response reception not successful;
 - 2> increment *PREAMBLE_TRANSMISSION_COUNTER* by 1;
 - 2> if *PREAMBLE_TRANSMISSION_COUNTER* = *preambleTransMax* + 1:
 - 3> if the Random Access Preamble is transmitted on the SpCell:
 - 4> indicate a Random Access problem to upper layers;
 - 4> if this Random Access procedure was triggered for SI request:
 - 5> consider the Random Access procedure unsuccessfully completed.
 - 3> else if the Random Access Preamble is transmitted on a SCell:
 - 4> consider the Random Access procedure unsuccessfully completed.
 - 2> if the Random Access procedure is not completed:

- 3> if in this Random Access procedure, the Random Access Preamble was selected by MAC among the contention-based Random Access Preambles:
 - 4> select a random backoff time according to a uniform distribution between 0 and the *PREAMBLE_BACKOFF*;
 - 4> delay the subsequent Random Access Preamble transmission by the backoff time.
- 3> perform the Random Access Resource selection procedure (see subclause 5.1.2).

The MAC entity may stop *ra-ResponseWindow* (and hence monitoring for Random Access Response(s)) after successful reception of a Random Access Response containing Random Access Preamble identifiers that matches the transmitted *PREAMBLE_INDEX*.

HARQ operation is not applicable to the Random Access Response transmission.

[TS 38.321, clause 6.1.5]

A MAC PDU consists of one or more MAC subPDUs and optionally padding. Each MAC subPDU consists one of the following:

- a MAC subheader with Backoff Indicator only;
- a MAC subheader with RAPID only (i.e. acknowledgment for SI request);
- a MAC subheader with RAPID and MAC RAR.

A MAC subheader with Backoff Indicator consists of five header fields E/T/R/R/BI as described in Figure 6.1.5-1. A MAC subPDU with Backoff Indicator only is placed at the beginning of the MAC PDU, if included. 'MAC subPDU(s) with RAPID only' and 'MAC subPDU(s) with RAPID and MAC RAR' can be placed anywhere between MAC subPDU with Backoff Indicator only (if any) and padding (if any).

A MAC subheader with RAPID consists of three header fields E/T/RAPID as described in Figure 6.1.5-2.

Padding is placed at the end of the MAC PDU if present. Presence and length of padding is implicit based on TB size, size of MAC subPDU(s).

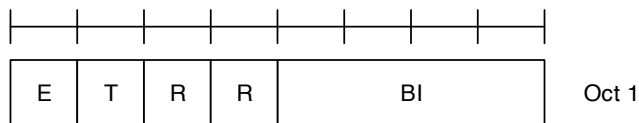

Figure 6.1.5-1: E/T/R/R/BI MAC subheader

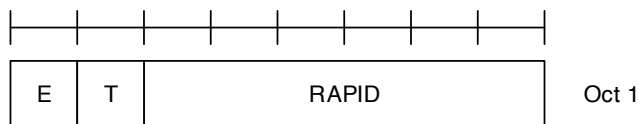

Figure 6.1.5-2: E/T/RAPID MAC subheader

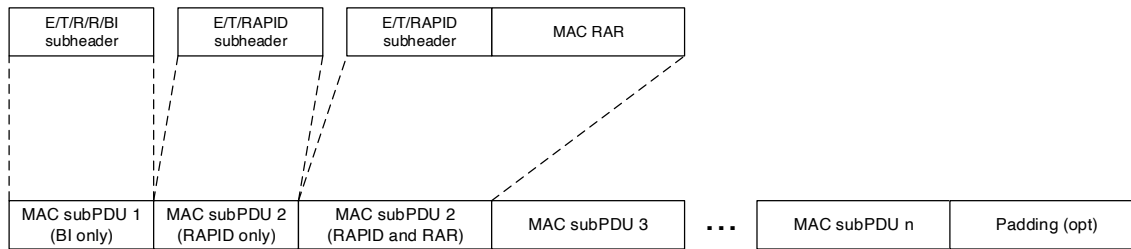

Figure 6.1.5-3: Example of MAC PDU consisting of MAC RARs

[38.331, clause 5.2.2.2.2]

UEs in RRC_IDLE or in RRC_INACTIVE shall monitor for SI change indication in its own paging occasion every DRX cycle. UEs in RRC_CONNECTED shall monitor for SI change indication in any paging occasion at least once per modification period if the UE is provided with common search space on the active BWP to monitor paging, as specified in TS 38.213 [13], clause 13.

ETWS or CMAS capable UEs in RRC_IDLE or in RRC_INACTIVE shall monitor for indications about PWS notification in its own paging occasion every DRX cycle. ETWS or CMAS capable UEs in RRC_CONNECTED shall monitor for indication about PWS notification in any paging occasion at least once every *defaultPagingCycle* if the UE is provided with common search space on the active BWP to monitor paging.

For Short Message reception in a paging occasion, the UE monitors the PDCCH monitoring occasion(s) for paging as specified in TS 38.304 [20] and TS 38.213 [13].

If the UE receives a Short Message, the UE shall:

- 1> if the UE is ETWS capable or CMAS capable, the *etwsAndCmasIndication* bit of Short Message is set, and the UE is provided with *searchSpaceOtherSystemInformation* on the active BWP:
 - 2> immediately re-acquire the *SIB1*;
 - 2> if the UE is ETWS capable and *si-SchedulingInfo* includes scheduling information for *SIB6*:
 - 3> acquire *SIB6*, as specified in clause 5.2.2.3.2, immediately;
 - 2> if the UE is ETWS capable and *si-SchedulingInfo* includes scheduling information for *SIB7*:
 - 3> acquire *SIB7*, as specified in clause 5.2.2.3.2, immediately;
 - 2> if the UE is CMAS capable and *si-SchedulingInfo* includes scheduling information for *SIB8*:
 - 3> acquire *SIB8*, as specified in sub-clause 5.2.2.3.2, immediately;
- 1> if the *systemInfoModification* bit of Short Message is set:
- 2> apply the SI acquisition procedure as defined in sub-clause 5.2.2.3 from the start of the next modification period.

7.1.1.1.3.3 Test description

7.1.1.1.3.3.1 Pre-test conditions

System Simulator:

- NR Cell 1 and NR Cell 11.
- System information combination NR-3 as defined in TS 38.508-1 [4] clause 4.4.3.1.3 is used in NR Cell 1.

UE:

- None.

Preamble:

- The UE is in NR RRC_Idle mode (state 1N-A) on NR Cell 1 according to 38.508-1 [4] Table 4.4A.2-1.

7.1.1.1.3.3.2 Test procedure sequence

Table 7.1.1.1.3.3.2-1/2 illustrate the downlink power levels and other changing parameters to be applied for the cell at various time instants of the test execution. The exact instants on which these values shall be applied are described in the texts in this clause. Configurations marked "T0" is applied for Preamble. Configurations marked "T1" and "T2" are applied at the points indicated in the Main behaviour description in Table 7.1.1.1.3.3.2-3.

Table 7.1.1.1.3.3.2-1: Time instances of cell power level and parameter changes for FR1

	Parameter	Unit	NR Cell 1	NR Cell 11	Remark
T0	SS/PBCH SSS EPRE	dBm/SC S	-90	Off	The power level is such that $Srxlev_{NRCell1} > 0$
	Qrxlevmin	dBm	-106	-	
	Qrxlevminoffset	dB	0	-	
	Pcompensation	dB	0	-	
	Qoffset	dB	16	-	
T1	SS/PBCH SSS EPRE	dBm/SC S	-90	-84	The power level values are assigned to satisfy $R_{NRCell1} > R_{NRCell11}$
	Qrxlevmin	dBm	-106	-106	
	Qrxlevminoffset	dB	0	0	
	Pcompensation	dB	0	0	
	Qoffset	dB	16	-	
T2	SS/PBCH SSS EPRE	dBm/SC S	-90	-84	The power level values are assigned to satisfy $R_{NRCell1} < R_{NRCell11}$
	Qrxlevmin	dBm	-106	-106	
	Qrxlevminoffset	dB	0	0	
	Pcompensation	dB	0	0	
	Qoffset	dB	-10	-	
Note: The downlink signal level uncertainty is specified in TS 38.508-1 [4] clause 6.2.2.1.					

Table 7.1.1.1.3.3.2-2: Time instances of cell power level and parameter changes for FR2

	Parameter	Unit	NR Cell 1	NR Cell 11	Remark
T0	SS/PBCH SSS EPRE	dBm/SC S	-91	Off	The power level is such that $Srxlev_{NRCell1} > 0$
	Qrxlevmin	dBm	$2^* \text{ROUND}((-110 + \Delta(NRfs))/2)$	-	
	Qrxlevminoffset	dB	0	-	
	Pcompensation	dB	0	-	
	Qoffset	dB	16	-	

T1	SS/PBCH SSS EPRE	dBm/SC S	-91	-82	The power level values are assigned to satisfy $R_{NRCell 1} > R_{NRCell 11}$
	Qrxlevmin	dBm	$2^* \text{ROUND}((-110 + \Delta (NRfs))/2)$	$2^* \text{ROUND}((-110 + \Delta (NRfs))/2)$	
	Qrxlevminoffset	dB	0	0	
	Pcompensation	dB	0	0	
	Qoffset	dB	16	-	
T2	SS/PBCH SSS EPRE	dBm/SC S	-91	-82	The power level values are assigned to satisfy $R_{NRCell 1} < R_{NRCell 11}$
	Qrxlevmin	dBm	$2^* \text{ROUND}((-110 + \Delta (NRfs))/2)$	$2^* \text{ROUND}((-110 + \Delta (NRfs))/2)$	
	Qrxlevminoffset	dB	0	0	
	Pcompensation	dB	0	0	
	Qoffset	dB	-10	-	
Note: The downlink signal level uncertainty is specified in TS 38.508-1 [4] section 6.2.2.2.					

Table 7.1.1.1.3.3.2-3: Main behaviour

St	Procedure	Message Sequence		TP	Verdict
		U - S	Message		
1	The SS changes SS/PBCH EPRE level of NR Cell 11 according to the row "T1" in Table 7.1.1.1.3.3.2-1/2.	-	-	-	-
2	Wait 60s to ensure UE detects NR Cell 11.	-	-	-	-
3	SS transmits Short Message on PDCCH addressed to P-RNTI using Short Message field in DCI format 1_0. Bit 1 of Short Message field is set to 1 to indicate the SI modification.	<--	(Short Message)	-	-
4	The SS changes the parameter 'Qoffset' in SIB3 of NR Cell 1 according to the row "T2" in Table 7.1.1.1.3.3.2-1/2. The valueTag for SIB3 in the SIB1 message is increased and si-BroadcastStatus for SIB3 is set to 'notBroadcasted'.	<--		-	-
5	Check: Does the UE transmit a preamble on PRACH using the preamble indicated by ra-PreambleStartIndex defined in SI-RequestConfig in SIB1 in Table 7.1.1.1.3.3.3-1?	-->	PRACH Preamble	1	P
6	Check: Does the UE re-transmit a preamble on PRACH after ra-ResponseWindow using the preamble indicated by ra-PreambleStartIndex defined in SI-RequestConfig in SIB1 in Table 7.1.1.1.3.3.3-1?	-->	PRACH Preamble	1	P
7	Check: Does the UE re-transmit a preamble on PRACH after ra-ResponseWindow using the preamble indicated by ra-PreambleStartIndex defined in SI-RequestConfig in SIB1 in Table 7.1.1.1.3.3.3-1?	-->	PRACH Preamble	1	P
8	Check: Does the UE re-transmit a preamble on PRACH after ra-ResponseWindow using the preamble indicated by ra-PreambleStartIndex defined in SI-RequestConfig in SIB1 in Table 7.1.1.1.3.3.3-1?	-->	PRACH Preamble	1	P
9	The SS transmits a RAR message addressed to UE RA-RNTI including a MAC subPDU with a matching RAPID only. (Note 1)	<--	Random Access Response	-	-
10	Check: Does UE send Msg3 containing an RRCSetupRequest message in the grant associated to the Random Access Response received in step 9?	-->	RRCSetupRequest	2	F
11	Check: Does the test result of generic test procedure in TS 38.508-1 [4] Table 4.9.5.2.2-1 indicate that the UE is camped on NR Cell 11 belonging to a new TA?	-	-	2	P
Note 1: The UE will indicate the reception of an acknowledgement for SI request to upper layers after UE receives the RAR message including a MAC subPDU with a matching RAPID only, according to TS 38.321 [18] clause 5.1.4.					

7.1.1.1.3.3.3 Specific message contents

Table 7.1.1.1.3.3.3-1: SIB1 on NR Cell 1 (Step 4, Table 7.1.1.1.3.3.2-3)

Derivation Path: TS 38.508-1 [4], Table 4.6.1-28			
Information Element	Value/remark	Comment	Condition
SIB1 ::= SEQUENCE {			
si-SchedulingInfo SEQUENCE {			
schedulingInfoList SEQUENCE {	2 entries		
si-BroadcastStatus[1]	Broadcasting		
si-Periodicity[1]	rf32		
sib-MappingInfo[1] SEQUENCE {			
type	SibType2		
valueTag	0		
areaScope	Not present		
}			
si-BroadcastStatus[2]	notBroadcasting		
si-Periodicity[2]	rf64		
sib-MappingInfo[2] SEQUENCE {			
type	SibType3		
valueTag	1		
areaScope	Not present		
}			
}			
si-Request-Config SEQUENCE {			
rach-OccasionsSI SEQUENCE {			
rach-ConfigSI	RACH-ConfigGeneric	TS 38.508-1 [4], Table 4.6.3-130	
ssb-perRACH-Occasion	one		
}			
si-RequestPeriod	two		
si-RequestResources SEQUENCE {			
ra-PreambleStartIndex	52		
ra-AssociationPeriodIndex	0		
ra-ssb-OccasionMaskIndex	0		
}			
}			
si-Request-ConfigSUL	Not present		
}			
}			

Table 7.1.1.1.3.3.3-2: SIB3 on NR Cell 1 (Preamble and Step 4, Table 7.1.1.1.3.3.2-3)

Derivation Path: TS 38.508-1 [4], Table 4.6.2-2			
Information Element	Value/remark	Comment	Condition
SIB3 ::= SEQUENCE {			
intraFreqNeighCellList SEQUENCE {			
physCellId	The cell identity of NR Cell 11 defined in 38.508-1 [4] clause 4.4.2		
q-OffsetCell	16	Preamble	
	-10	Step 4	
}			
}			

7.1.1.1.4 Random access procedure / Successful / Beam Failure / Preamble selected by MAC itself / Non Contention Free RACH procedure

7.1.1.1.4.1 Test Purpose (TP)

(1)

```
with { UE in RRC_CONNECTED state with no failureDetectionResources configured and RACH procedure due to beam failure is triggered }
ensure that {
  when { contention free random access resources for beam failure recovery request associated with SS blocks are not provided by RRC }
  then { UE selects initiates the non-contention free Random Access Procedure }
}
```

(2)

```
with { UE in RRC_CONNECTED state and RACH procedure due to beam failure is triggered }
ensure that {
  when { contention free random access resources for beam failure recovery request associated with SS blocks are explicitly provided by RRC }
  then { UE selects the PREAMBLE_INDEX to a ra-PreambleIndex corresponding to the selected SS block and initiates the contention free Random Access Procedure }
}
```

(3)

```
with { UE in RRC_CONNECTED state and RACH procedure due to beam failure is triggered }
ensure that {
  when { contention free random access resources for beam failure recovery request associated with CSI-RS are explicitly provided by RRC }
  then { UE selects the PREAMBLE_INDEX to a ra-PreambleIndex corresponding to the selected CSI-RS and initiates the contention free Random Access Procedure }
}
```

(4)

```
with { UE in RRC_CONNECTED state with Preamble transmitted for contention free RACH procedure for beam failure }
ensure that {
  when { ra-ResponseWindowBFR expires and the PDCCH addressed to the C-RNTI has not been received }
  then { UE retransmits the PRACH Preamble }
}
```

(5)

```
with { UE in RRC_CONNECTED state with Preamble transmitted for contention free RACH procedure for beam failure }
ensure that {
  when { before expiry of ra-ResponseWindowBFR the PDCCH addressed to the C-RNTI is received }
  then { UE considers the RACH procedure to be successfully completed and stops retransmitting PRACH preambles }
}
```

7.1.1.1.4.2 Conformance requirements

References: The conformance requirements covered in the present test case are specified in: TS 38.321, clause 5.1.2, 5.1.3, 5.1.4 and 5.17. Unless otherwise stated these are Rel-15 requirements.

[TS 38.321, clause 5.1.2]

The MAC entity shall:

- 1> if the Random Access procedure was initiated for beam failure recovery (as specified in subclause 5.17); and
- 1> if the *beamFailureRecoveryTimer* (in subclause 5.17) is either running or not configured; and
- 1> if the contention-free Random Access Resources for beam failure recovery request associated with any of the SSBs and/or CSI-RSs have been explicitly provided by RRC; and

- 1> if at least one of the SSBs with SS-RSRP above *rsrp-ThresholdSSB* amongst the SSBs in *candidateBeamRSList* or the CSI-RSs with CSI-RSRP above *rsrp-ThresholdCSI-RS* amongst the CSI-RSs in *candidateBeamRSList* is available:
 - 2> select an SSB with SS-RSRP above *rsrp-ThresholdSSB* amongst the SSBs in *candidateBeamRSList* or a CSI-RS with CSI-RSRP above *rsrp-ThresholdCSI-RS* amongst the CSI-RSs in *candidateBeamRSList*;
 - 2> if CSI-RS is selected, and there is no *ra-PreambleIndex* associated with the selected CSI-RS:
 - 3> set the *PREAMBLE_INDEX* to a *ra-PreambleIndex* corresponding to the SSB in *candidateBeamRSList* which is quasi-collocated with the selected CSI-RS as specified in TS 38.214 [7].
 - 2> else:
 - 3> set the *PREAMBLE_INDEX* to a *ra-PreambleIndex* corresponding to the selected SSB or CSI-RS from the set of Random Access Preambles for beam failure recovery request.
- 1> else if the *ra-PreambleIndex* has been explicitly provided by PDCCH; and
- 1> if the *ra-PreambleIndex* is not 0b000000:
 - 2> set the *PREAMBLE_INDEX* to the signalled *ra-PreambleIndex*;
 - 2> select the SSB signalled by PDCCH.
- 1> else if the contention-free Random Access Resources associated with SSBs have been explicitly provided by RRC and at least one SSB with SS-RSRP above *rsrp-ThresholdSSB* amongst the associated SSBs is available:
 - 2> select an SSB with SS-RSRP above *rsrp-ThresholdSSB* amongst the associated SSBs;
 - 2> set the *PREAMBLE_INDEX* to a *ra-PreambleIndex* corresponding to the selected SSB.
- 1> else if the contention-free Random Access Resources associated with CSI-RSs have been explicitly provided by RRC and at least one CSI-RS with CSI-RSRP above *rsrp-ThresholdCSI-RS* amongst the associated CSI-RSs is available:
 - 2> select a CSI-RS with CSI-RSRP above *rsrp-ThresholdCSI-RS* amongst the associated CSI-RSs;
 - 2> set the *PREAMBLE_INDEX* to a *ra-PreambleIndex* corresponding to the selected CSI-RS.
- 1> else if the Random Access procedure was initiated for SI request (as specified in TS 38.331 [5]); and
- 1> if the Random Access Resources for SI request have been explicitly provided by RRC:
 - 2> if at least one of the SSBs with SS-RSRP above *rsrp-ThresholdSSB* is available:
 - 3> select an SSB with SS-RSRP above *rsrp-ThresholdSSB*.
 - 2> else:
 - 3> select any SSB.
 - 2> select a Random Access Preamble corresponding to the selected SSB, from the Random Access Preamble(s) determined according to *ra-PreambleStartIndex* as specified in TS 38.331 [5];
 - 2> set the *PREAMBLE_INDEX* to selected Random Access Preamble.
- 1> else (i.e. for the contention-based Random Access preamble selection):
 - 2> if at least one of the SSBs with SS-RSRP above *rsrp-ThresholdSSB* is available:
 - 3> select an SSB with SS-RSRP above *rsrp-ThresholdSSB*.
 - 2> else:
 - 3> select any SSB.
 - 2> if Msg3 has not yet been transmitted:

- 3> if Random Access Preambles group B is configured:
 - 4> if the potential Msg3 size (UL data available for transmission plus MAC header and, where required, MAC CEs) is greater than $ra\text{-}Msg3SizeGroupA$ and the pathloss is less than $PCMAX$ (of the Serving Cell performing the Random Access Procedure) – $preambleReceivedTargetPower - msg3\text{-}DeltaPreamble - messagePowerOffsetGroupB$; or
 - 4> if the Random Access procedure was initiated for the CCCH logical channel and the CCCH SDU size plus MAC subheader is greater than $ra\text{-}Msg3SizeGroupA$:
 - 5> select the Random Access Preambles group B.
 - 4> else:
 - 5> select the Random Access Preambles group A.
- 3> else:
 - 4> select the Random Access Preambles group A.
- 2> else (i.e. Msg3 is being retransmitted):
 - 3> select the same group of Random Access Preambles as was used for the Random Access Preamble transmission attempt corresponding to the first transmission of Msg3.
- 2> if the association between Random Access Preambles and SSBs is configured:
 - 3> select a Random Access Preamble randomly with equal probability from the Random Access Preambles associated with the selected SSB and the selected Random Access Preambles group.
- 2> else:
 - 3> select a Random Access Preamble randomly with equal probability from the Random Access Preambles within the selected Random Access Preambles group.
- 2> set the *PREAMBLE_INDEX* to the selected Random Access Preamble.
- 1> if the Random Access procedure was initiated for SI request (as specified in TS 38.331 [5]); and
- 1> if *ra-AssociationPeriodIndex* and *si-RequestPeriod* are configured:
 - 2> determine the next available PRACH occasion from the PRACH occasions corresponding to the selected SSB in the association period given by *ra-AssociationPeriodIndex* in the *si-RequestPeriod* permitted by the restrictions given by the *ra-ssb-OccasionMaskIndex* (the MAC entity shall select a PRACH occasion randomly with equal probability amongst the consecutive PRACH occasions according to subclause 8.1 of TS 38.213 [6] corresponding to the selected SSB).
- 1> else if an SSB is selected above:
 - 2> determine the next available PRACH occasion from the PRACH occasions corresponding to the selected SSB permitted by the restrictions given by the *ra-ssb-OccasionMaskIndex* if configured (the MAC entity shall select a PRACH occasion randomly with equal probability amongst the consecutive PRACH occasions according to subclause 8.1 of TS 38.213 [6], corresponding to the selected SSB; the MAC entity may take into account the possible occurrence of measurement gaps when determining the next available PRACH occasion corresponding to the selected SSB).
- 1> else if a CSI-RS is selected above:
 - 2> if there is no contention-free Random Access Resource associated with the selected CSI-RS:
 - 3> determine the next available PRACH occasion from the PRACH occasions, permitted by the restrictions given by the *ra-ssb-OccasionMaskIndex* if configured, corresponding to the SSB in *candidateBeamRSList* which is quasi-collocated with the selected CSI-RS as specified in TS 38.214 [7] (the MAC entity may take into account the possible occurrence of measurement gaps when determining the next available PRACH occasion corresponding to the SSB which is quasi-collocated with the selected CSI-RS).
 - 2> else:

3> determine the next available PRACH occasion from the PRACH occasions in *ra-OccasionList* corresponding to the selected CSI-RS (the MAC entity shall select a PRACH occasion randomly with equal probability amongst the PRACH occasions occurring simultaneously but on different subcarriers, corresponding to the selected CSI-RS; the MAC entity may take into account the possible occurrence of measurement gaps when determining the next available PRACH occasion corresponding to the selected CSI-RS).

1> perform the Random Access Preamble transmission procedure (see subclause 5.1.3).

NOTE: When the UE determines if there is an SSB with SS-RSRP above *rsrp-ThresholdSSB* or a CSI-RS with CSI-RSRP above *rsrp-ThresholdCSI-RS*, the UE uses the latest unfiltered L1-RSRP measurement.

[TS 38.321, clause 5.1.4]

Once the Random Access Preamble is transmitted and regardless of the possible occurrence of a measurement gap, the MAC entity shall:

1> if the contention-free Random Access Preamble for beam failure recovery request was transmitted by the MAC entity:

2> start the *ra-ResponseWindow* configured in *BeamFailureRecoveryConfig* at the first PDCCH occasion as specified in TS 38.213 [6] from the end of the Random Access Preamble transmission;

2> monitor the PDCCH of the SpCell for response to beam failure recovery request identified by the C-RNTI while *ra-ResponseWindow* is running.

1> else:

2> start the *ra-ResponseWindow* configured in *RACH-ConfigCommon* at the first PDCCH occasion as specified in TS 38.213 [6] from the end of the Random Access Preamble transmission;

2> monitor the PDCCH of the SpCell for Random Access Response(s) identified by the RA-RNTI while the *ra-ResponseWindow* is running.

1> if notification of a reception of a PDCCH transmission is received from lower layers on the Serving Cell where the preamble was transmitted; and

1> if PDCCH transmission is addressed to the C-RNTI; and

1> if the contention-free Random Access Preamble for beam failure recovery request was transmitted by the MAC entity:

2> consider the Random Access procedure successfully completed.

1> else if a downlink assignment has been received on the PDCCH for the RA-RNTI and the received TB is successfully decoded:

2> if the Random Access Response contains a MAC subPDU with Backoff Indicator:

3> set the *PREAMBLE_BACKOFF* to value of the BI field of the MAC subPDU using Table 7.2-1, multiplied with *SCALING_FACTOR_BI*.

2> else:

3> set the *PREAMBLE_BACKOFF* to 0 ms.

2> if the Random Access Response contains a MAC subPDU with Random Access Preamble identifier corresponding to the transmitted *PREAMBLE_INDEX* (see subclause 5.1.3):

3> consider this Random Access Response reception successful.

2> if the Random Access Response reception is considered successful:

3> if the Random Access Response includes a MAC subPDU with RAPID only:

4> consider this Random Access procedure successfully completed;

4> indicate the reception of an acknowledgement for SI request to upper layers.

3> else:

4> apply the following actions for the Serving Cell where the Random Access Preamble was transmitted:

5> process the received Timing Advance Command (see subclause 5.2);

5> indicate the *preambleReceivedTargetPower* and the amount of power ramping applied to the latest Random Access Preamble transmission to lower layers (i.e. $(PREAMBLE_POWER_RAMPING_COUNTER - 1) \times PREAMBLE_POWER_RAMPING_STEP$);

5> if the Serving Cell for the Random Access procedure is SRS-only SCell:

6> ignore the received UL grant.

5> else:

6> process the received UL grant value and indicate it to the lower layers.

4> if the Random Access Preamble was not selected by the MAC entity among the contention-based Random Access Preamble(s):

5> consider the Random Access procedure successfully completed.

4> else:

5> set the *TEMPORARY_C-RNTI* to the value received in the Random Access Response;

5> if this is the first successfully received Random Access Response within this Random Access procedure:

6> if the transmission is not being made for the CCCH logical channel:

7> indicate to the Multiplexing and assembly entity to include a C-RNTI MAC CE in the subsequent uplink transmission.

6> obtain the MAC PDU to transmit from the Multiplexing and assembly entity and store it in the *Msg3* buffer.

1> if *ra-ResponseWindow* configured in *RACH-ConfigCommon* expires, and if the Random Access Response containing Random Access Preamble identifiers that matches the transmitted *PREAMBLE_INDEX* has not been received; or

1> if *ra-ResponseWindow* configured in *BeamFailureRecoveryConfig* expires and if the PDCCH addressed to the C-RNTI has not been received on the Serving Cell where the preamble was transmitted:

2> consider the Random Access Response reception not successful;

2> increment *PREAMBLE_TRANSMISSION_COUNTER* by 1;

2> if *PREAMBLE_TRANSMISSION_COUNTER* = *preambleTransMax* + 1:

3> if the Random Access Preamble is transmitted on the SpCell:

4> indicate a Random Access problem to upper layers;

4> if this Random Access procedure was triggered for SI request:

5> consider the Random Access procedure unsuccessfully completed.

3> else if the Random Access Preamble is transmitted on a SCell:

4> consider the Random Access procedure unsuccessfully completed.

2> if the Random Access procedure is not completed:

- 3> select a random backoff time according to a uniform distribution between 0 and the *PREAMBLE_BACKOFF*;
- 3> if the criteria (as defined in subclause 5.1.2) to select contention-free Random Access Resources is met during the backoff time:
- 4> perform the Random Access Resource selection procedure (see subclause 5.1.2);
- 3> else:
- 4> perform the Random Access Resource selection procedure (see subclause 5.1.2) after the backoff time.

The MAC entity may stop *ra-ResponseWindow* (and hence monitoring for Random Access Response(s)) after successful reception of a Random Access Response containing Random Access Preamble identifiers that matches the transmitted *PREAMBLE_INDEX*.

HARQ operation is not applicable to the Random Access Response transmission.

7.1.1.1.4.3 Test description

7.1.1.1.4.3.1 Pre-test conditions

Same Pre-test conditions as in clause 7.1.1.0 except that set to return no data in uplink.

7.1.1.1.4.3.2 Test procedure sequence

Table 7.1.1.1.4.3.2-1/1A illustrates the downlink power levels and other changing parameters to be applied for the cells at various time instants of the test execution. Row marked "T0" denotes the initial conditions after preamble, while columns marked "T1" and "T2" are to be applied subsequently. The exact instants on which these values shall be applied are described in the texts in this clause.

Table 7.1.1.1.4.3.2-1: Time instances of cell power level and parameter changes for FR1

	Parameter	Unit	E-UTRA Cell 1	NR Cell 1	NR Cell 1 Beam index #1	NR Cell 1 Beam index #0	Remark
T0	Cell-specific RS EPRE	dBm/15 kHz	-85	-	-	-	Beam#1 Switch ON and Beam#0 Switch OFF
	Reference Power	dBm/SC S	-	-88	-	-	
	CSI-RS EPRE SS/PBCH SSS EPRE,	dB	-	-	0	-57	
T1	Cell-specific RS EPRE	dBm/15 kHz	-85	-	-	-	Beam#1 Switch OFF and Beam#0 Switch ON
	Reference Power	dBm/SC S	-	-88	-	-	
	CSI-RS EPRE SS/PBCH SSS EPRE,	dB	-	-	-57	0	
T2	Cell-specific RS EPRE	dBm/15 kHz	-85	-	-	-	Beam#1 Switch ON and Beam#0 Switch OFF
	Reference Power	dBm/SC S	-	-88	-	-	
	CSI-RS EPRE SS/PBCH SSS EPRE,	dB	-	-	0	-57	
NOTE: "Beam index #1" refers to transmission of the SS/PBCH block with SSB index #1 (according to the <i>ssb-PositionsInBurst</i>) and CSI-RS with index #1 (according to the <i>CSI-MeasConfig</i> being signalled to the UE at step 1/8/17); "Beam index #0" refers to transmission of the SS/PBCH block with SSB index #0 (according to the <i>ssb-PositionsInBurst</i>) and CSI-RS with index #0 (according to the <i>CSI-MeasConfig</i> being signalled to the UE at step 1/8/17).							

Table 7.1.1.1.4.3.2-1A: Time instances of cell power level and parameter changes for FR2

	Parameter	Unit	E-UTRA Cell 1	NR Cell 1	NR Cell 1 Beam index #1	NR Cell 1 Beam index #0	Remark
T0	Cell-specific RS EPRE	dBm/15 kHz	-96	-	-	-	Beam#1 Switch ON and Beam#0 Switch OFF
	Reference Power	dBm/SC S	-	-82	-	-	
	CSI-RS EPRE SS/PBCH SSS EPRE,	dB	-	-	0	-63	
T1	Cell-specific RS EPRE	dBm/15 kHz	-96	-	-	-	Beam#1 Switch OFF and Beam#0 Switch ON
	Reference Power	dBm/SC S	-	-82	-	-	
	CSI-RS EPRE SS/PBCH SSS EPRE,	dBm/SC S	-	-	-63	0	
T2	Cell-specific RS EPRE	dBm/15 kHz	-96	-	-	-	Beam#1 Switch ON and Beam#0 Switch OFF
	Reference Power	dBm/SC S	-	-82	-	-	
	CSI-RS EPRE SS/PBCH SSS EPRE,	dBm/SC S	-	-	0	-63	
NOTE: "Beam index #1" refers to transmission of the SS/PBCH block with SSB index #1 (according to the ssb-PositionsInBurst) and CSI-RS with index #1 (according to the CSI-MeasConfig being signalled to the UE at step 1/8/17); "Beam index #0" refers to transmission of the SS/PBCH block with SSB index #0 (according to the ssb-PositionsInBurst) and CSI-RS with index #0 (according to the CSI-MeasConfig being signalled to the UE at step 1/8/17).							

Table 7.1.1.1.4.3.2-2: Main behaviour

St	Procedure	Message Sequence		TP	Verdict
		U - S	Message		
1	The SS transmits an NR <i>RRCReconfiguration</i> message to configure parameters for BFR. Note 1.	<--	NR RRC: <i>RRCReconfiguration</i>	-	-
2	UE responses NR <i>RRCReconfigurationComplete</i> message. Note 2.	-->	NR RRC: <i>RRCReconfigurationComplete</i>	-	-
3	The SS changes NR Cell 1 power level according to the row "T1" in table 7.1.1.1.4.3.2-1/1A.	-	-	-	-
4	Check: Does the UE transmit a preamble on PRACH for the non-contention free Random Access Procedure on NR Cell 1 Beam index #0?	-->	PRACH Preamble	1	P
5	The SS transmits a MAC PDU addressed to UE RA-RNTI, containing multiple RAR's and one of the MAC sub headers contains a matching RAPID on NR Cell 1.	<--	Random Access Response	-	-
6	UE sends a msg3 using the grant associated to the Random Access Response received in Step 5 on NR Cell 1.	-->	msg3 (C-RNTI MAC CONTROL ELEMENT)	-	-
7	SS schedules PDCCH transmission for UE C-RNTI.	<--	Contention Resolution	-	-
8	The SS transmits an NR <i>RRCReconfiguration</i> to establish random access resources for BFR associated with SS blocks explicitly. Note 1.	<--	NR RRC: <i>RRCReconfiguration</i>	-	-
9	UE responses NR <i>RRCReconfigurationComplete</i> message. Note 2.	-->	NR RRC: <i>RRCReconfigurationComplete</i>	-	-
10	The SS changes NR Cell 1 power level according to the row "T2" in table 7.1.1.1.4.3.2-1/1A.	-	-	-	-
11	Check: Does the UE transmit preamble on PRACH using a preamble with PREAMBLE_INDEX to a ra-PreambleIndex corresponding to the selected SS block provided by RRC on NR Cell 1 Beam index #1?	-->	PRACH Preamble	2	P
12	The SS waits for ra-ResponseWindowBFR expire. NOTE: The SS does not transmit Random Access Response to the UE.	-	-	-	-
13	Check: Does the UE retransmit a preamble on PRACH with ra-PreambleIndex same as the Step 11?	-->	PRACH Preamble	4	P
14	The SS transmits a MAC PDU addressed to UE C-RNTI, containing multiple RAR's and one of the MAC sub headers contains a matching RAPID on NR Cell 1.	<--	Random Access Response	-	-
15	The SS waits for ra-ResponseWindowBFR expire.	-	-	-	-
16	Check: Does the UE retransmit a preamble on PRACH?	-	-	5	F
-	EXCEPTION: Steps 17 to 25 describe behaviour that depends on the UE capability.	-	-	-	-
17	IF pc_csi_RS_CFRA_ForHO THEN the SS transmits an NR <i>RRCReconfiguration</i> message to establish random access resources for BFR associated with CSI-RS explicitly. Note 1.	<--	NR RRC: <i>RRCReconfiguration</i>	-	-
18	UE responses NR <i>RRCReconfigurationComplete</i> message. Note 2.	-->	NR RRC: <i>RRCReconfigurationComplete</i>	-	-
19	The SS changes NR Cell 1 power level	-	-	-	-

	according to the row "T1" in table 7.1.1.1.4.3.2-1.				
20	Check: Does the UE transmit preamble on PRACH using a preamble with PREAMBLE_INDEX to a ra-PreambleIndex corresponding to the selected CSI-RS provided by RRC on NR Cell 1 Beam index #0?	-->	PRACH Preamble	3	P
21	The SS waits for ra-ResponseWindowBFR expire. NOTE: The SS does not transmit Random Access Response to the UE.	-	-	-	-
22	Check: Does the UE retransmit a preamble on PRACH with ra-PreambleIndex same as the Step 20?	-->	PRACH Preamble	4	P
23	The SS transmits a MAC PDU addressed to UE C-RNTI, containing multiple RAR's and one of the MAC sub headers contains a matching RAPID on NR Cell 1.	<--	Random Access Response	-	-
24	The SS waits for ra-ResponseWindowBFR expire.	-	-	-	-
25	Check: Does the UE retransmit a preamble on PRACH?	-	-	5	F
Note 1: for EN-DC the NR <i>RRCReconfiguration</i> message is contained in <i>RRCConnectionReconfiguration</i> 36.508 [7], Table 4.6.1-8 using condition EN-DC_EmbedNR_RRCRecon.					
Note 2: for EN-DC the NR <i>RRCReconfigurationComplete</i> message is contained in <i>RRCConnectionReconfigurationComplete</i> .					

7.1.1.1.4.3.3 Specific message contents

Table 7.1.1.1.4.3.3-1: ServingCellConfigCommon (Preamble)

Derivation Path: TS 38.508-1 [4], Table 4.6.3-168			
Information Element	Value/remark	Comment	Condition
ServingCellConfigCommon ::= SEQUENCE {			
ssb-PositionsInBurst CHOICE {			
shortBitmap	1100		(FREQ<=3G Hz AND (FR1_FDD OR NOT CASE_C)) OR (FREQ<=2.4 GHz AND FR1_TDD)
mediumBitmap	11000000		(FREQ>3G Hz AND FR1) OR (FREQ>2.4 GHz AND FR1_TDD AND CASE_C)
longBitmap	11000000000000000000 00000000000000000000 00000000000000000000 0000		FR2
}			
}			

Table 7.1.1.1.4.3.3-2: ServingCellConfigCommonSIB (Preamble)

Derivation Path: TS 38.508-1 [4], Table 4.6.3-169			
Information Element	Value/remark	Comment	Condition
ServingCellConfigCommonSIB ::= SEQUENCE {			
ssb-PositionsInBurst SEQUENCE {			
inOneGroup	'1100 0000'B	When carrier frequency is smaller than or equal to 3 GHz, only the 4 leftmost bits are valid;	
}			
}			

Table 7.1.1.1.4.3.3-3: RRCReconfiguration (Step 1, Step8, Step17 Table 7.1.1.1.4.3.2-2)

Derivation path: 38.508-1 [4], Table 4.6.1-13			
Information Element	Value/remark	Comment	Condition
RRCReconfiguration ::= SEQUENCE {			
criticalExtensions CHOICE {			
rrcReconfiguration SEQUENCE {			
secondaryCellGroup	CellGroupConfig	OCTET STRING	EN-DC
nonCriticalExtension SEQUENCE {			NR
masterCellGroup	CellGroupConfig	OCTET STRING (CONTAINING CellGroupConfig)	
}			
}			
}			

Table 7.1.1.1.4.3.3-4: CellGroupConfig (Table 7.1.1.1.4.3.3-3: RRCReconfiguration)

Derivation Path: TS 38.508-1 [4], Table 4.6.3-19			
Information Element	Value/remark	Comment	Condition
CellGroupConfig ::= SEQUENCE {			
spCellConfig SEQUENCE {			
spCellConfigDedicated	ServingCellConfig		
}			
}			

Table 7.1.1.1.4.3.3-5: ServingCellConfig (Table 7.1.1.1.4.3.3-4: CellGroupConfig)

Derivation Path: TS 38.508-1 [4], Table 4.6.3-168			
Information Element	Value/remark	Comment	Condition
ServingCellConfig ::= SEQUENCE {			
initialDownlinkBWP	BWP-DownlinkDedicated		
uplinkConfig SEQUENCE {			
initialUplinkBWP	BWP-UplinkDedicated		
}			
csi-MeasConfig CHOICE {			Step 1
setup	CSI-MeasConfig		
}			
}			

Table 7.1.1.1.4.3.3-6: BWP-DownlinkDedicated (Table 7.1.1.1.4.3.3-5: ServingCellConfig)

Derivation Path: TS 38.508-1 [4], Table 4.6.3-11			
Information Element	Value/remark	Comment	Condition
BWP-DownlinkDedicated ::= SEQUENCE {			
pdccch-Config	Not present		Step 17
pdccch-Config CHOICE {			Step 1, Step 8
setup	PDCCH-Config		
}			
pdsch-Config CHOICE {			
setup	PDSCH-Config		
}			
radioLinkMonitoringConfig CHOICE {			
setup	RadioLinkMonitoringConfig		
}			
}			

Table 7.1.1.1.4.3.3-7: RadioLinkMonitoringConfig (Table 7.1.1.1.4.3.3-6: BWP-DownlinkDedicated)

Derivation Path: TS 38.508-1 [4], Table 4.6.3-133			
Information Element	Value/remark	Comment	Condition
RadioLinkMonitoringConfig ::= SEQUENCE {			
failureDetectionResourcesToAddModList	2 entries		
SEQUENCE (SIZE(1..maxNrofFailureDetectionResources)) OF			
RadioLinkMonitoringRS {			
RadioLinkMonitoringRS[1] SEQUENCE {		entry 1	
radioLinkMonitoringRS-Id			
purpose	rif		Step 1, Step 17
	both		Step 8
detectionResource CHOICE {			
csi-rs	0	NR Cell 1 Beam index #0	
}			
}			
RadioLinkMonitoringRS[2] SEQUENCE {		entry 2	
radioLinkMonitoringRS-Id	1		
purpose	rif		Step 1, Step 8
	both		Step 17
detectionResource CHOICE {			
csi-rs	1	NR Cell 1 Beam index #1	
}			
}			
}			
beamFailureInstanceMaxCount	n1		
beamFailureDetectionTimer	pbfd1		
}			

Table 7.1.1.1.4.3.3-8: PDSCH-Config (Table 7.1.1.1.4.3.3-6: BWP-DownlinkDedicated)

Derivation Path: TS 38.508-1 [4], Table 4.6.3-100			
Information Element	Value/remark	Comment	Condition
PDSCH-Config ::= SEQUENCE {			
tci-StatesToAddModList SEQUENCE(SIZE (1..maxNrofTCI-States)) OF TCI-State {	3 entries		
TCI-State[1] SEQUENCE {		entry 1	
tci-StateId	0		
qcl-type1 SEQUENCE {			
cell	ServCellIndex of NR SpCell	Cell ID	
bwp-id	0	BWP ID	
referenceSignal CHOICE {			
ssb	1	SSB index #1	
}			
qcl-Type	type C		
}			
qcl-type2	Not present		
qcl-type2 SEQUENCE {			FR2
cell	ServCellIndex of NR SpCell	Cell ID	
bwp-id	0	BWP ID	
referenceSignal CHOICE {			
ssb	1	SSB index #1	
}			
qcl-Type	type D		
}			
TCI-State[2] SEQUENCE {		entry 2	
tci-StateId	1		
qcl-type1 SEQUENCE {			
cell	ServCellIndex of NR SpCell	Cell ID	
bwp-id	0	BWP ID	
referenceSignal CHOICE {			
ssb	0	SSB index #0	
}			
qcl-Type	type C		
}			
qcl-type2	Not present		
qcl-type2 SEQUENCE {			FR2
cell	ServCellIndex of NR SpCell	Cell ID	
bwp-id	0	BWP ID	
referenceSignal CHOICE {			
ssb	0	SSB index #0	
}			
qcl-Type	type D		
}			
TCI-State[3] SEQUENCE {		entry 3	
tci-StateId	2		
qcl-type1 SEQUENCE {			
cell	ServCellIndex of NR SpCell	Cell ID	
bwp-id	0	BWP ID	
referenceSignal CHOICE {			
csi-rs	1	Csi-Rs index #1	
}			
qcl-Type	type A		
}			
qcl-type2	Not present		
qcl-type2 SEQUENCE {			FR2
cell	ServCellIndex of NR SpCell	Cell ID	

Table 7.1.1.1.4.3.3-12: SearchSpaceBFR (Table 7.1.1.1.4.3.3-9: PDCCH-Config)

Derivation Path: TS 38.508-1 [4], Table 4.6.3-162			
Information Element	Value/remark	Comment	Condition
SearchSpace ::= SEQUENCE {			
searchSpaceId	4		
controlResourceSetId	2		
searchSpaceType CHOICE {			
ue-Specific SEQUENCE {			
dci-Formats	formats0-0-And-1-0		
}			
}			
}			

Table 7.1.1.1.4.3.3-13: CSI-MeasConfig (Table 7.1.1.1.4.3.3-5: ServingCellConfig)

Derivation Path: TS 38.508-1 [4], Table 4.6.3-38			
Information Element	Value/remark	Comment	Condition
CSI-MeasConfig ::= SEQUENCE {			
nzp-CSI-RS-ResourceToAddModList SEQUENCE {	2 entries		
Nzp-CSI-RS-Resource[1]	Nzp-CSI-RS-ResourceId0		
Nzp-CSI-RS-Resource[2]	Nzp-CSI-RS-ResourceId1		
}			
nzp-CSI-RS-ResourceSetToAddModList SEQUENCE {	1 entry		
Nzp-CSI-RS-ResourceSet[1]	Nzp-CSI-RS-ResourceSetId0		
}			
csi-IM-ResourceToAddModList	Not present		
csi-IM-ResourceSetToAddModList	Not present		
csi-SSB-ResourceSetToAddModList	Not present		
csi-ReportConfigToAddModList	Not present		
reportTriggerSize	Not present		
aperiodicTriggerStateList	Not present		
}			

Table 7.1.1.1.4.3.3-14: NZP-CSI-RS-ResourceId0 (Table 7.1.1.1.4.3.3-13: CSI-MeasConfig)

Derivation Path: TS 38.508-1 [4], Table 4.6.3-85			
Information Element	Value/remark	Comment	Condition
NZP-CSI-RS-Resource ::= SEQUENCE {			
nzp-CSI-RS-ResourceId	0		
resourceMapping	CSI-RS-ResourceMapping with condition TRS	TS 38.508-1 [4], Table 4.6.3-45	
qcl-InfoPeriodicCSI-RS	0	QCL to SSB #0	
}			

Table 7.1.1.1.4.3.3-15: NZP-CSI-RS-ResourceId1 (Table 7.1.1.1.4.3.3-13: CSI-MeasConfig)

Derivation Path: TS 38.508-1 [4], Table 4.6.3-85			
Information Element	Value/remark	Comment	Condition
NZP-CSI-RS-Resource ::= SEQUENCE {			
nzp-CSI-RS-ResourceId	1		
resourceMapping	CSI-RS-ResourceMapping with condition TRS	TS 38.508-1 [4], Table 4.6.3-45	
periodicityAndOffset	CSI-ResourcePeriodicityAndOffset_Id1		
qcl-InfoPeriodicCSI-RS	1	QCL to SSB #1	
}			

Table 7.1.1.1.4.3.3-16: CSI-ResourcePeriodicityAndOffset_Id1 (Table 7.1.1.1.4.3.3-15: NZP-CSI-RS-ResourceId1)

Derivation Path: TS 38.508-1 [4], Table 4.6.3-43			
Information Element	Value/remark	Comment	Condition
CSI-ResourcePeriodicityAndOffset ::= CHOICE {			
slots80	11		FR1
slots320	41		FR2
}			

Table 7.1.1.1.4.3.3-17: NZP-CSI-RS-ResourceSetId0 (Table 7.1.1.1.4.3.3-13: CSI-MeasConfig)

Derivation Path: TS 38.508-1 [4], Table 4.6.3-87			
Information Element	Value/remark	Comment	Condition
NZP-CSI-RS-ResourceSet ::= SEQUENCE {			
nzp-CSI-ResourceSetId	0		
nzp-CSI-RS-Resources SEQUENCE (SIZE (1..maxNrofNZP-CSI-RS-ResourcesPerSet)) OF NZP-CSI-RS-ResourceId {	2 entries		
NZP-CSI-RS-ResourceId[1]	0	entry 1	
NZP-CSI-RS-ResourceId[2]	1	entry 2	
}			
trs-Info	true		
}			

Table 7.1.1.1.4.3.3-18: BWP-UplinkDedicated (Table 7.1.1.1.4.3.3-5: ServingCellConfig)

Derivation Path: TS 38.508-1 [4], Table 4.6.3-15			
Information Element	Value/remark	Comment	Condition
BWP-UplinkDedicated ::= SEQUENCE {			
pucch-Config CHOICE {			
setup	PUCCH-Config		
}			
pusch-Config CHOICE {			
setup	PUSCH-Config		
}			
beamFailureRecoveryConfig	BeamFailureRecoveryConfig_SSB		Step8
	BeamFailureRecoveryConfig_CSIRS		Step17
	Not Present		Step1
}			

Table 7.1.1.1.4.3.3-19: BeamFailureRecoveryConfig_SSB (Table 7.1.1.1.4.3.3-18: BWP-UplinkDedicated)

Derivation Path: TS 38.508-1 [4], Table 4.6.3-12			
Information Element	Value/remark	Comment	Condition
BeamFailureRecoveryConfig ::= SEQUENCE {			
rootSequenceIndex-BFR	0	See TS 38.508-1[4] clause 4.4.2, Table 4.4.2-2	
rach-ConfigBFR	RACH-ConfigGeneric	38.508-1[4] Table 4.6.3-130	
rsrp-ThresholdSSB	57(-100dBm)		
candidateBeamRSList SEQUENCE (SIZE(1..maxNrofCandidateBeams)) OF PRACH-ResourceDedicatedBFR CHOICE{			
ssb SEQUENCE {			
ssb	1	NR Cell Beam#1	
ra-PreambleIndex	56	(0..63)	
}			
}			
ssb-perRACH-Occasion	one		
ra-ssb-OccasionMaskIndex	0		
recoverySearchSpaceID	4		
ra-Prioritization	Not Present		
beamFailureRecoveryTimer	ms200		
}			

Table 7.1.1.1.4.3.3-20: BeamFailureRecoveryConfig_CSIRS (Table 7.1.1.1.4.3.3-18: BWP-UplinkDedicated)

Derivation Path: TS 38.508-1 [4], Table 4.6.3-12			
Information Element	Value/remark	Comment	Condition
BeamFailureRecoveryConfig ::= SEQUENCE {			
rootSequenceIndex-BFR	0	See TS 38.508-1[4] clause 4.4.2, Table 4.4.2-2	
rach-ConfigBFR	RACH-ConfigGeneric	38.508-1[4] Table 4.6.3-130	
rsrp-ThresholdSSB	57(-100dBm)		
candidateBeamRSList SEQUENCE (SIZE(1..maxNrofCandidateBeams)) OF PRACH-ResourceDedicatedBFR CHOICE{			
csi-RS SEQUENCE {			
csi-RS	0		
ra-OccasionList SEQUENCE (SIZE(1..maxRA-OccasionsPerCSIRS)) OF INTEGER (0..maxRA-Occasions-1) {	1 entry		
INTEGER[1]	0	entry 1 NR Cell Beam#0	
}			
ra-PreambleIndex	59		
}			
ssb-perRACH-Occasion	Not Present		
ra-ssb-OccasionMaskIndex	Not Present		
recoverySearchSpaceID	4		
ra-Prioritization	Not Present		
beamFailureRecoveryTimer	ms200		
}			

Table 7.1.1.1.4.3.3-21: PUCCH-Config (Table 7.1.1.1.4.3.3-18: BWP-UplinkDedicated)

Derivation Path: TS 38.508-1 [4], Table 4.6.3-112			
Information Element	Value/remark	Comment	Condition
pucch-Config ::= SEQUENCE {			
pucch-PowerControl SEQUENCE {			
pathlossReferenceRSs SEQUENCE (SIZE (1..maxNrofPUCCH-PathlossReferenceRSs)) OF PUCCH-PathlossReferenceRS {	1 entry		
PUCCH-PathlossReferenceRS[1] SEQUENCE {		entry 1	
referenceSignal CHOICE {			
ssb-Index	1		Step1,Step17
	0		Step8
}			
}			
}			

Table 7.1.1.1.4.3.3-22: PUSCH-Config (Table 7.1.1.1.4.3.3-18: BWP-UplinkDedicated)

Derivation Path: TS 38.508-1 [4], Table 4.6.3-118			
Information Element	Value/remark	Comment	Condition
pusch-Config ::= SEQUENCE {			
pusch-PowerControl SEQUENCE {			
pathlossReferenceRSToAddModList SEQUENCE (SIZE (1..maxNrofPUSCH-PathlossReferenceRSs)) OF PUSCH-PathlossReferenceRS {	1 entry		
PUSCH-PathlossReferenceRS[1] SEQUENCE {		entry 1	
referenceSignal CHOICE {			
ssb-Index	1		Step1,Step17
	0		Step8
}			
}			
}			

7.1.1.1.5 Random access procedure / Successful / Supplementary Uplink

7.1.1.1.5.1 Test Purpose (TP)

(1)

```
with { UE in RRC_CONNECTED state with supplementary uplink configured and RACH procedure is triggered }
ensure that {
  when { RSRP of the downlink pathloss reference is less than rsrp-ThresholdSSB-SUL }
  then { UE performs the Random Access Procedure on the Supplementary Uplink carrier }
}
```

7.1.1.1.5.2 Conformance requirements

References: The conformance requirements covered in the present TC are specified in TS 38.321: clause 5.1.1 and clause 5.16. Unless otherwise stated these are Rel-15 requirements.

[TS 38.321, clause 5.1.1]

The Random Access procedure described in this clause is initiated by a PDCCH order, by the MAC entity itself, or by RRC for the events in accordance with TS 38.300 [2]. There is only one Random Access procedure ongoing at any

point in time in a MAC entity. The Random Access procedure on an SCell shall only be initiated by a PDCCH order with *ra-PreambleIndex* different from 0b000000.

NOTE 1: If a new Random Access procedure is triggered while another is already ongoing in the MAC entity, it is up to UE implementation whether to continue with the ongoing procedure or start with the new procedure (e.g. for SI request).

RRC configures the following parameters for the Random Access procedure:

- *prach-ConfigurationIndex*: the available set of PRACH occasions for the transmission of the Random Access Preamble;
- *preambleReceivedTargetPower*: initial Random Access Preamble power;
- *rsrp-ThresholdSSB*: an RSRP threshold for the selection of the SSB. If the Random Access procedure is initiated for beam failure recovery, *rsrp-ThresholdSSB* used for the selection of the SSB within *candidateBeamRSList* refers to *rsrp-ThresholdSSB* in *BeamFailureRecoveryConfig* IE;
- *rsrp-ThresholdCSI-RS*: an RSRP threshold for the selection of CSI-RS. If the Random Access procedure is initiated for beam failure recovery, *rsrp-ThresholdCSI-RS* is equal to *rsrp-ThresholdSSB* in *BeamFailureRecoveryConfig* IE;
- *rsrp-ThresholdSSB-SUL*: an RSRP threshold for the selection between the NUL carrier and the SUL carrier;
- *candidateBeamRSList*: a list of reference signals (CSI-RS and/or SSB) identifying the candidate beams for recovery and the associated Random Access parameters;
- *recoverySearchSpaceId*: the search space identity for monitoring the response of the beam failure recovery request;
- *powerRampingStep*: the power-ramping factor;
- *powerRampingStepHighPriority*: the power-ramping factor in case of prioritized Random Access procedure;
- *scalingFactorBI*: a scaling factor for prioritized Random Access procedure;
- *ra-PreambleIndex*: Random Access Preamble;
- *ra-ssb-OccasionMaskIndex*: defines PRACH occasion(s) associated with an SSB in which the MAC entity may transmit a Random Access Preamble (see clause 7.4);
- *ra-OccasionList*: defines PRACH occasion(s) associated with a CSI-RS in which the MAC entity may transmit a Random Access Preamble;
- *ra-PreambleStartIndex*: the starting index of Random Access Preamble(s) for on-demand SI request;
- *preambleTransMax*: the maximum number of Random Access Preamble transmission;
- *ssb-perRACH-OccasionAndCB-PreamblesPerSSB*: defines the number of SSBs mapped to each PRACH occasion and the number of contention-based Random Access Preambles mapped to each SSB;
- if *groupBconfigured* is configured, then Random Access Preambles group B is configured.
 - Amongst the contention-based Random Access Preambles associated with an SSB (as defined in TS 38.213 [6]), the first *numberOfRA-PreamblesGroupA* Random Access Preambles belong to Random Access Preambles group A. The remaining Random Access Preambles associated with the SSB belong to Random Access Preambles group B (if configured).

NOTE 2: If Random Access Preambles group B is supported by the cell Random Access Preambles group B is included for each SSB.

- if Random Access Preambles group B is configured:
 - *ra-Msg3SizeGroupA*: the threshold to determine the groups of Random Access Preambles;
 - *msg3-DeltaPreamble*: $\Delta_{\text{PREAMBLE_Msg3}}$ in TS 38.213 [6];

- *messagePowerOffsetGroupB*: the power offset for preamble selection;
- *numberOfRA-PreamblesGroupA*: defines the number of Random Access Preambles in Random Access Preamble group A for each SSB.
- the set of Random Access Preambles and/or PRACH occasions for SI request, if any;
- the set of Random Access Preambles and/or PRACH occasions for beam failure recovery request, if any;
- the set of Random Access Preambles and/or PRACH occasions for reconfiguration with sync, if any;
- *ra-ResponseWindow*: the time window to monitor RA response(s) (SpCell only);
- *ra-ContentionResolutionTimer*: the Contention Resolution Timer (SpCell only).

In addition, the following information for related Serving Cell is assumed to be available for UEs:

- if Random Access Preambles group B is configured:
 - if the Serving Cell for the Random Access procedure is configured with supplementary uplink as specified in TS 38.331 [5], and SUL carrier is selected for performing Random Access Procedure:
 - $P_{\text{CMAX},f,c}$ of the SUL carrier as specified in TS 38.101-1 [14], TS 38.101-2 [15], and TS 38.101-3 [16].
 - else:
 - $P_{\text{CMAX},f,c}$ of the NUL carrier as specified in TS 38.101-1 [14], TS 38.101-2 [15], and TS 38.101-3 [16].

The following UE variables are used for the Random Access procedure:

- *PREAMBLE_INDEX*;
- *PREAMBLE_TRANSMISSION_COUNTER*;
- *PREAMBLE_POWER_RAMPING_COUNTER*;
- *PREAMBLE_POWER_RAMPING_STEP*;
- *PREAMBLE_RECEIVED_TARGET_POWER*;
- *PREAMBLE_BACKOFF*;
- *PCMAX*;
- *SCALING_FACTOR_BI*;
- *TEMPORARY_C-RNTI*.

When the Random Access procedure is initiated on a Serving Cell, the MAC entity shall:

- 1> flush the Msg3 buffer;
- 1> set the *PREAMBLE_TRANSMISSION_COUNTER* to 1;
- 1> set the *PREAMBLE_POWER_RAMPING_COUNTER* to 1;
- 1> set the *PREAMBLE_BACKOFF* to 0 ms;
- 1> if the carrier to use for the Random Access procedure is explicitly signalled:
 - 2> select the signalled carrier for performing Random Access procedure;
 - 2> set the *PCMAX* to $P_{\text{CMAX},f,c}$ of the signalled carrier.
- 1> else if the carrier to use for the Random Access procedure is not explicitly signalled; and
- 1> if the Serving Cell for the Random Access procedure is configured with supplementary uplink as specified in TS 38.331 [5]; and

- 1> if the RSRP of the downlink pathloss reference is less than *rsrp-ThresholdSSB-SUL*:
 - 2> select the SUL carrier for performing Random Access procedure;
 - 2> set the *PCMAX* to $P_{CMAX,f,c}$ of the SUL carrier.
- 1> else:
 - 2> select the NUL carrier for performing Random Access procedure;
 - 2> set the *PCMAX* to $P_{CMAX,f,c}$ of the NUL carrier.
- 1> perform the BWP operation as specified in clause 5.15;
- 1> set *PREAMBLE_POWER_RAMPING_STEP* to *powerRampingStep*; 1> set *SCALING_FACTOR_BI* to 1;
- 1> if the Random Access procedure was initiated for beam failure recovery (as specified in clause 5.17); and
 - 1> if *beamFailureRecoveryConfig* is configured for the active UL BWP of the selected carrier:
 - 2> start the *beamFailureRecoveryTimer*, if configured;
 - 2> apply the parameters *powerRampingStep*, *preambleReceivedTargetPower*, and *preambleTransMax* configured in the *beamFailureRecoveryConfig*;
 - 2> if *powerRampingStepHighPriority* is configured in the *beamFailureRecoveryConfig*:
 - 3> set *PREAMBLE_POWER_RAMPING_STEP* to the *powerRampingStepHighPriority*.
 - 2> else:
 - 3> set *PREAMBLE_POWER_RAMPING_STEP* to *powerRampingStep*.
 - 2> if *scalingFactorBI* is configured in the *beamFailureRecoveryConfig*:
 - 3> set *SCALING_FACTOR_BI* to the *scalingFactorBI*.
 - 1> else if the Random Access procedure was initiated for handover; and
- 1> if *rach-ConfigDedicated* is configured for the selected carrier:
 - 2> if *powerRampingStepHighPriority* is configured in the *rach-ConfigDedicated*:
 - 3> set *PREAMBLE_POWER_RAMPING_STEP* to the *powerRampingStepHighPriority*.
 - 2> if *scalingFactorBI* is configured in the *rach-ConfigDedicated*:
 - 3> set *SCALING_FACTOR_BI* to the *scalingFactorBI*.
- 1> perform the Random Access Resource selection procedure (see clause 5.1.2).

[TS 38.321, clause 5.16]

The Supplementary UL (SUL) carrier can be configured as a complement to the normal UL (NUL) carrier. Switching between the NUL carrier and the SUL carrier means that the UL transmissions move from one carrier to the other carrier, which is done by:

- an indication in DCI;
- the Random Access procedure as specified in clause 5.1.1.

If the MAC entity receives a UL grant indicating an SUL switch while a Random Access procedure is ongoing, the MAC entity shall ignore the UL grant.

The Serving Cell configured with *supplementaryUplink* belongs to a single TAG.

7.1.1.1.5.3 Test description

7.1.1.1.5.3.1 Pre-test conditions

Same Pre-test conditions as in clause 7.1.1.0 except that supplementary uplink (SUL) carrier is configured on NR Cell 33.

7.1.1.1.5.3.2 Test procedure sequence

Table 7.1.1.1.5.3.2-1 illustrates the downlink power levels to be applied for the NR cells at various time instants of the test execution. Row marked "T0" denotes the initial conditions, while row marked "T1" are to be applied subsequently. The exact instants on which these values shall be applied are described in the texts in this clause.

Table 7.1.1.1.5.3.2-1: Time instances of cell power level changes

	Parameter	Unit	NR Cell 1 (NUL)	NR Cell 33 (SUL)	Remark
T0	SS/PBCH SSS EPRE	dBm/SCS	-75	N/A	NR Cell1 Power level is higher than <i>rsrp-ThresholdSSB-SUL</i> .
T1	SS/PBCH SSS EPRE	dBm/SCS	-85	N/A	NR Cell1 Power level is lower than <i>rsrp-ThresholdSSB-SUL</i> .

Table 7.1.1.1.5.3.2-2: Main behaviour

St	Procedure	Message Sequence		TP	Verdict
		U - S	Message		
1	The SS ignores scheduling requests and does not allocate any uplink grant		-	-	-
2	The SS transmits a MAC PDU containing a PDCP SDU on NR Cell 1.	<-	MAC PDU	-	-
3	The SS changes NR Cell 1's power level according to the row "T1" in table 7.1.1.1.5.3.2-1. (Note 1)	-	-	-	-
4	Void.	-	-	-	-
5	Check: Does the UE initiate the random access procedure on SUL carrier on NR Cell 33?	-->	PRACH Preamble	1	P
6	The SS transmits Random Access Response with an UL Grant of 56-bits on NR Cell 1 and RAPID corresponding to the transmitted preamble in step 5. (Note 2)	<-	Random Access Response	-	-
7	Check: Does the UE send a msg3 using the grant associated to the Random Access Response received in Step 6 on SUL carrier on NR Cell 33?	-->	Msg3 (C-RNTI MAC CE)	1	P
8	The SS schedules PDCCH transmission on NR Cell 1 for UE C-RNTI with uplink grant's UL/SUL indicator set to 1.	<-	Contention Resolution	-	-
9	Check: Does the UE transmit a MAC PDU with C-RNTI containing looped back PDCP SDU on SUL carrier on NR Cell 33?	-->	MAC PDU	1	P

Note 1: Reduce the NR Cell 1 SS/PBCH EPRE level to ensure that RSRP of the downlink pathloss reference is lower than *rsrp-ThresholdSSB-SUL*, while UE is still able to receive msg2 and msg4 correctly.

Note 2: UL grant of 56 bits is to make UE not send any loopback data in uplink with msg3, according to TS 38.321 [18] clause 5.4.3.1.

7.1.1.1.5.3.3 Specific message contents

Table 7.1.1.1.5.3.3-1: SIB1 of NR Cell 1 (preamble and all steps, Table 7.1.1.1.5.3.2-2)

Derivation Path: TS 38.508-1 [4], Table 4.6.1-28			
Information Element	Value/remark	Comment	Condition
SIB1 ::= SEQUENCE {			
servingCellConfigCommon	ServingCellConfigCommonSIB		
}			

Table 7.1.1.1.5.3.3-2: ServingCellConfigCommonSIB (Table 7.1.1.1.5.3.3-1)

Derivation Path: TS 38.508-1 [4], Table 4.6.3-169			
Information Element	Value/remark	Comment	Condition
ServingCellConfigCommonSIB ::= SEQUENCE {			
supplementaryUplink SEQUENCE {			
initialUplinkBWP	BWP-UplinkCommon		
}			
}			

Table 7.1.1.1.5.3.3-3: BWP-UplinkCommon (Table 7.1.1.1.5.3.3-2)

Derivation Path: TS 38.508-1 [4], Table 4.6.3-14			
Information Element	Value/remark	Comment	Condition
BWP-UplinkCommon ::= SEQUENCE {			
rach-ConfigCommon CHOICE {			
setup	RACH-ConfigCommon		
}			
}			

Table 7.1.1.1.5.3.3-4: RACH-ConfigCommon (Table 7.1.1.1.5.3.3-3)

Derivation Path: TS 38.508-1 [4], Table 4.6.3-128			
Information Element	Value/remark	Comment	Condition
RACH-ConfigCommon ::= SEQUENCE {			
rsrp-ThresholdSSB-SUL	76	IE value 76 means -80dBm	SUL
}			

Table 7.1.1.1.5.3.3-5: DCI Format 0-1 (Step 8 of Table 7.1.1.1.5.3.2-2)

Derivation Path: TS 38.508-1 [4], Table 4.3.6.1.1.2-1			
Information Element	Value/remark	Comment	Condition
UL/SUL indicator	1		UE configured with SUL in the cell

7.1.1.1.6 Random access procedure / Successful/ Temporary C-RNTI Based / Preamble selected by MAC itself

7.1.1.1.6.1 Test Purpose (TP)

(1)

```

with { UE in RRC Idle state has UL CCCH PDU to send and Random Access Preambles group B is
configured }
ensure that {
  when { the UL CCCH MAC PDU Size is less than messageSizeGroupA }
  then { UE transmits a random access preamble using a preamble in group A of random access
preambles }
}

```

(2)

```

with { UE in RRC Idle state initiated Random Access procedure to transmit UL CCCH PDU and
transmitted MSG3 }
ensure that {
  when { The SS schedules any PDCCH transmission addressed to UE Temporary C-RNTI before Contention
resolution timer expiry with MAC PDU does not contain a matching UE Contention Resolution Identity
MAC CE }
  then {UE re transmits a random access preamble using a preamble in the same group of random
access preambles as used for the first transmission of Msg3 }
}

```

(3)

```

with { UE in RRC Idle state initiated Random Access procedure to transmit UL CCCH PDU and
transmitted MSG3 }
ensure that {
  when { The SS does not schedule any PDCCH transmission addressed to UE Temporary C-RNTI before
Contention resolution timer expiry }
  then {UE re transmits a random access preamble using a preamble in the same group of random
access preambles as used for the first transmission of Msg3 }
}

```

(4)

```

with { UE in RRC Idle state initiated Random Access procedure to transmit UL CCCH PDU and
transmitted MSG3 }
ensure that {
  when { The SS schedules a PDCCH transmission addressed to UE Temporary C-RNTI before Contention
resolution timer expiry }
  then {UE assumes RACH procedure as complete }
}

```

7.1.1.1.6.2 Conformance requirements

References: The conformance requirements covered in the present TC are specified in: 3GPP TS 38,321, clause 5.1.2, 5.1.3, 5.1.4, 5.1.5, 5.2, 6.1.3.2, 6.1.5 and 6.2.3. Unless otherwise stated these are Rel-15 requirements.

[TS 38.321, clause 5.1.2]

The MAC entity shall:

- 1> if the Random Access procedure was initiated for beam failure recovery (as specified in subclause 5.17); and
- 1> if the *beamFailureRecoveryTimer* (in subclause 5.17) is either running or not configured; and
- 1> if the contention-free Random Access Resources for beam failure recovery request associated with any of the SSBs and/or CSI-RSs have been explicitly provided by RRC; and
- 1> if at least one of the SSBs with SS-RSRP above *rsrp-ThresholdSSB* amongst the SSBs in *candidateBeamRSList* or the CSI-RSs with CSI-RSRP above *rsrp-ThresholdCSI-RS* amongst the CSI-RSs in *candidateBeamRSList* is available:
 - 2> select an SSB with SS-RSRP above *rsrp-ThresholdSSB* amongst the SSBs in *candidateBeamRSList* or a CSI-RS with CSI-RSRP above *rsrp-ThresholdCSI-RS* amongst the CSI-RSs in *candidateBeamRSList*;
 - 2> if CSI-RS is selected, and there is no *ra-PreambleIndex* associated with the selected CSI-RS:
 - 3> set the *PREAMBLE_INDEX* to a *ra-PreambleIndex* corresponding to the SSB in *candidateBeamRSList* which is quasi-colocated with the selected CSI-RS as specified in TS 38.214 [7].
 - 2> else:
 - 3> set the *PREAMBLE_INDEX* to a *ra-PreambleIndex* corresponding to the selected SSB or CSI-RS from the set of Random Access Preambles for beam failure recovery request.
- 1> else if the *ra-PreambleIndex* has been explicitly provided by PDCCH; and

- 1> if the *ra-PreambleIndex* is not 0b000000:
 - 2> set the *PREAMBLE_INDEX* to the signalled *ra-PreambleIndex*;
 - 2> select the SSB signalled by PDCCH.
- 1> else if the contention-free Random Access Resources associated with SSBs have been explicitly provided in *rach-ConfigDedicated* and at least one SSB with SS-RSRP above *rsrp-ThresholdSSB* amongst the associated SSBs is available:
 - 2> select an SSB with SS-RSRP above *rsrp-ThresholdSSB* amongst the associated SSBs;
 - 2> set the *PREAMBLE_INDEX* to a *ra-PreambleIndex* corresponding to the selected SSB.
- 1> else if the contention-free Random Access Resources associated with CSI-RSs have been explicitly provided in *rach-ConfigDedicated* and at least one CSI-RS with CSI-RSRP above *rsrp-ThresholdCSI-RS* amongst the associated CSI-RSs is available:
 - 2> select a CSI-RS with CSI-RSRP above *rsrp-ThresholdCSI-RS* amongst the associated CSI-RSs;
 - 2> set the *PREAMBLE_INDEX* to a *ra-PreambleIndex* corresponding to the selected CSI-RS.
- 1> else if the Random Access procedure was initiated for SI request (as specified in TS 38.331 [5]); and
- 1> if the Random Access Resources for SI request have been explicitly provided by RRC:
 - 2> if at least one of the SSBs with SS-RSRP above *rsrp-ThresholdSSB* is available:
 - 3> select an SSB with SS-RSRP above *rsrp-ThresholdSSB*.
 - 2> else:
 - 3> select any SSB.
 - 2> select a Random Access Preamble corresponding to the selected SSB, from the Random Access Preamble(s) determined according to *ra-PreambleStartIndex* as specified in TS 38.331 [5];
 - 2> set the *PREAMBLE_INDEX* to selected Random Access Preamble.
- 1> else (i.e. for the contention-based Random Access preamble selection):
 - 2> if at least one of the SSBs with SS-RSRP above *rsrp-ThresholdSSB* is available:
 - 3> select an SSB with SS-RSRP above *rsrp-ThresholdSSB*.
 - 2> else:
 - 3> select any SSB.
 - 2> if Msg3 has not yet been transmitted:
 - 3> if Random Access Preambles group B is configured:
 - 4> if the potential Msg3 size (UL data available for transmission plus MAC header and, where required, MAC CEs) is greater than *ra-Msg3SizeGroupA* and the pathloss is less than *PCMAX* (of the Serving Cell performing the Random Access Procedure) – *preambleReceivedTargetPower* – *msg3-DeltaPreamble* – *messagePowerOffsetGroupB*; or
 - 4> if the Random Access procedure was initiated for the CCCH logical channel and the CCCH SDU size plus MAC subheader is greater than *ra-Msg3SizeGroupA*:
 - 5> select the Random Access Preambles group B.
 - 4> else:
 - 5> select the Random Access Preambles group A.
 - 3> else:

- 4> select the Random Access Preambles group A.
- 2> else (i.e. Msg3 is being retransmitted):
 - 3> select the same group of Random Access Preambles as was used for the Random Access Preamble transmission attempt corresponding to the first transmission of Msg3.
 - > select a Random Access Preamble3 randomly with equal probability from the Random Access Preambles associated with the selected SSB and the selected Random Access Preambles group.
 - > else:
 - 2> set the *PREAMBLE_INDEX* to the selected Random Access Preamble.
- 11> if the Random Access procedure was initiated for SI request (as specified in TS 38.331 [5]); and
- 1> if *ra-AssociationPeriodIndex* and *si-RequestPeriod* are configured:
 - 2> determine the next available PRACH occasion from the PRACH occasions corresponding to the selected SSB in the association period given by *ra-AssociationPeriodIndex* in the *si-RequestPeriod* permitted by the restrictions given by the *ra-ssb-OccasionMaskIndex* if configured (the MAC entity shall select a PRACH occasion randomly with equal probability amongst the consecutive PRACH occasions according to subclause 8.1 of TS 38.213 [6] corresponding to the selected SSB).
 - > else if an SSB is selected above:
 - 2> determine the next available PRACH occasion from the PRACH occasions corresponding to the selected SSB permitted by the restrictions given by the *ra-ssb-OccasionMaskIndex* if configured or indicated by PDCCH (the MAC entity shall select a PRACH occasion randomly with equal probability amongst the consecutive PRACH occasions according to subclause 8.1 of TS 38.213 [6], corresponding to the selected SSB; the MAC entity may take into account the possible occurrence of measurement gaps when determining the next available PRACH occasion corresponding to the selected SSB).
 - 1> else if a CSI-RS is selected above:
 - 2> if there is no contention-free Random Access Resource associated with the selected CSI-RS:
 - 3> determine the next available PRACH occasion from the PRACH occasions, permitted by the restrictions given by the *ra-ssb-OccasionMaskIndex* if configured, corresponding to the SSB in *candidateBeamRSLList* which is quasi-colocated with the selected CSI-RS as specified in TS 38.214 [7] (the MAC entity shall select a PRACH occasion randomly with equal probability amongst the consecutive PRACH occasions according to subclause 8.1 of TS 38.213 [6], corresponding to the SSB which is quasi-colocated with the selected CSI-RS; the MAC entity may take into account the possible occurrence of measurement gaps when determining the next available PRACH occasion corresponding to the SSB which is quasi-colocated with the selected CSI-RS).
 - 2> else:
 - 3> determine the next available PRACH occasion from the PRACH occasions in *ra-OccasionList* corresponding to the selected CSI-RS (the MAC entity shall select a PRACH occasion randomly with equal probability amongst the PRACH occasions occurring simultaneously but on different subcarriers, corresponding to the selected CSI-RS; the MAC entity may take into account the possible occurrence of measurement gaps when determining the next available PRACH occasion corresponding to the selected CSI-RS).
 - 1> else if Random Access procedure was initiated for beam failure recovery; and
 - 1> if a CSI-RS is selected above and there is no contention-free Random Access Resource associated with the selected CSI-RS:
 - 2> determine the next available PRACH occasion from the PRACH occasions, permitted by the restrictions given by the *ra-ssb-OccasionMaskIndex* if configured, corresponding to the SSB in *candidateBeamRSLList* which is quasi-colocated with the selected CSI-RS as specified in TS 38.214 [7] (the MAC entity may take into account the possible occurrence of measurement gaps when determining the next available PRACH occasion corresponding to the SSB which is quasi-collected with the selected CSI-RS).

1> else:

- 2> determine the next available PRACH occasion (the MAC entity shall select a PRACH occasion randomly with equal probability amongst the PRACH occasions occurring simultaneously but on different subcarriers; the MAC entity may take into account the possible occurrence of measurement gaps when determining the next available PRACH occasion).

1> perform the Random Access Preamble transmission procedure (see subclause 5.1.3).

NOTE: When the UE determines if there is an SSB with SS-RSRP above $rsrp\text{-}ThresholdSSB$ or a CSI-RS with CSI-RSRP above $rsrp\text{-}ThresholdCSI\text{-}RS$, the UE uses the latest unfiltered L1-RSRP measurement.

[TS 38.321, clause 5.1.3]

The MAC entity shall, for each Random Access Preamble:

- 1> if $PREAMBLE_TRANSMISSION_COUNTER$ is greater than one; and
- 1> if the notification of suspending power ramping counter has not been received from lower layers; and
- 1> if SSB or CSI-RS selected is not changed from the selection in the last Random Access Preamble transmission:
- 2> increment $PREAMBLE_POWER_RAMPING_COUNTER$ by 1.
- 1> select the value of $DELTA_PREAMBLE$ according to subclause 7.3;
- 1> set $PREAMBLE_RECEIVED_TARGET_POWER$ to $preambleReceivedTargetPower + DELTA_PREAMBLE + (PREAMBLE_POWER_RAMPING_COUNTER - 1) \times PREAMBLE_POWER_RAMPING_STEP$;
- 1> except for contention-free Random Access Preamble for beam failure recovery request, compute the RA-RNTI associated with the PRACH occasion in which the Random Access Preamble is transmitted;
- 1> instruct the physical layer to transmit the Random Access Preamble using the selected PRACH occasion, corresponding RA-RNTI (if available), $PREAMBLE_INDEX$ and $PREAMBLE_RECEIVED_TARGET_POWER$.

The RA-RNTI associated with the PRACH occasion in which the Random Access Preamble is transmitted, is computed as:

$$RA\text{-}RNTI = 1 + s_id + 14 \times t_id + 14 \times 80 \times f_id + 14 \times 80 \times 8 \times ul_carrier_id$$

where s_id is the index of the first OFDM symbol of the PRACH occasion ($0 \leq s_id < 14$), t_id is the index of the first slot of the PRACH occasion in a system frame ($0 \leq t_id < 80$), f_id is the index of the PRACH occasion in the frequency domain ($0 \leq f_id < 8$), and $ul_carrier_id$ is the UL carrier used for Random Access Preamble transmission (0 for NUL carrier, and 1 for SUL carrier).

[TS 38.321, clause 5.1.4]

Once the Random Access Preamble is transmitted and regardless of the possible occurrence of a measurement gap, the MAC entity shall:

- 1> if the contention-free Random Access Preamble for beam failure recovery request was transmitted by the MAC entity:
- 2> start the *ra-ResponseWindow* configured in *BeamFailureRecoveryConfig* at the first PDCCH occasion as specified in TS 38.213 [6] from the end of the Random Access Preamble transmission;
- 2> monitor for a PDCCH transmission on the search space indicated by *recoverySearchSpaceId* of the SpCell identified by the C-RNTI while *ra-ResponseWindow* is running.
- 1> else:
- 2> start the *ra-ResponseWindow* configured in *RACH-ConfigCommon* at the first PDCCH occasion as specified in TS 38.213 [6] from the end of the Random Access Preamble transmission;
- 2> monitor the PDCCH of the SpCell for Random Access Response(s) identified by the RA-RNTI while the *ra-ResponseWindow* is running.

- 1> if notification of a reception of a PDCCH transmission on the search space indicated by *recoverySearchSpaceId* is received from lower layers on the Serving Cell where the preamble was transmitted; and
- 1> if PDCCH transmission is addressed to the C-RNTI; and
- 1> if the contention-free Random Access Preamble for beam failure recovery request was transmitted by the MAC entity:
 - 2> consider the Random Access procedure successfully completed.
- 1> else if a downlink assignment has been received on the PDCCH for the RA-RNTI and the received TB is successfully decoded:
 - 2> if the Random Access Response contains a MAC subPDU with Backoff Indicator:
 - 3> set the *PREAMBLE_BACKOFF* to value of the BI field of the MAC subPDU using Table 7.2-1, multiplied with *SCALING_FACTOR_BI*.
 - 2> else:
 - 3> set the *PREAMBLE_BACKOFF* to 0 ms.
 - 2> if the Random Access Response contains a MAC subPDU with Random Access Preamble identifier corresponding to the transmitted *PREAMBLE_INDEX* (see subclause 5.1.3):
 - 3> consider this Random Access Response reception successful.
 - 2> if the Random Access Response reception is considered successful:
 - 3> if the Random Access Response includes a MAC subPDU with RAPID only:
 - 4> consider this Random Access procedure successfully completed;
 - 4> indicate the reception of an acknowledgement for SI request to upper layers.
 - 3> else:
 - 4> apply the following actions for the Serving Cell where the Random Access Preamble was transmitted:
 - 5> process the received Timing Advance Command (see subclause 5.2);
 - 5> indicate the *preambleReceivedTargetPower* and the amount of power ramping applied to the latest Random Access Preamble transmission to lower layers (i.e. $(PREAMBLE_POWER_RAMPING_COUNTER - 1) \times PREAMBLE_POWER_RAMPING_STEP$);
 - 5> if the Serving Cell for the Random Access procedure is SRS-only SCell:
 - 6> ignore the received UL grant.
 - 5> else:
 - 6> process the received UL grant value and indicate it to the lower layers.
 - 4> if the Random Access Preamble was not selected by the MAC entity among the contention-based Random Access Preamble(s):
 - 5> consider the Random Access procedure successfully completed.
 - 4> else:
 - 5> set the *TEMPORARY_C-RNTI* to the value received in the Random Access Response;
 - 5> if this is the first successfully received Random Access Response within this Random Access procedure:
 - 6> if the transmission is not being made for the CCCH logical channel:

7> indicate to the Multiplexing and assembly entity to include a C-RNTI MAC CE in the subsequent uplink transmission.

6> obtain the MAC PDU to transmit from the Multiplexing and assembly entity and store it in the Msg3 buffer.

NOTE: If within a Random Access procedure, an uplink grant provided in the Random Access Response for the same group of contention-based Random Access Preambles has a different size than the first uplink grant allocated during that Random Access procedure, the UE behavior is not defined.

- 1> if *ra-ResponseWindow* configured in *BeamFailureRecoveryConfig* expires and if a PDCCH transmission on the search space indicated by *recoverySearchSpaceId* addressed to the C-RNTI has not been received on the Serving Cell where the preamble was transmitted; or
- > if *ra-ResponseWindow* configured in *RACH-ConfigCommon* expires, and if the Random Access Response containing Random Access Preamble identifiers that matches the transmitted *PREAMBLE_INDEX* has not been received:
 - 2> consider the Random Access Response reception not successful;
 - 2> increment *PREAMBLE_TRANSMISSION_COUNTER* by 1;
 - 2> if *PREAMBLE_TRANSMISSION_COUNTER* = *preambleTransMax* + 1:
 - 3> if the Random Access Preamble is transmitted on the SpCell:
 - 4> indicate a Random Access problem to upper layers;
 - 4> if this Random Access procedure was triggered for SI request:
 - 5> consider the Random Access procedure unsuccessfully completed.
 - 3> else if the Random Access Preamble is transmitted on a SCell:
 - 4> consider the Random Access procedure unsuccessfully completed.
 - 2> if the Random Access procedure is not completed:
 - 3> select a random backoff time according to a uniform distribution between 0 and the *PREAMBLE_BACKOFF*;
 - 3> if the criteria (as defined in subclause 5.1.2) to select contention-free Random Access Resources is met during the backoff time:
 - 4> perform the Random Access Resource selection procedure (see subclause 5.1.2);
 - 3> else:
 - 4> perform the Random Access Resource selection procedure (see subclause 5.1.2) after the backoff time.

The MAC entity may stop *ra-ResponseWindow* (and hence monitoring for Random Access Response(s)) after successful reception of a Random Access Response containing Random Access Preamble identifiers that matches the transmitted *PREAMBLE_INDEX*.

HARQ operation is not applicable to the Random Access Response reception.

[TS 38.321, clause 5.1.5]

Once Msg3 is transmitted, the MAC entity shall:

- 1> start the *ra-ContentionResolutionTimer* and restart the *ra-ContentionResolutionTimer* at each HARQ retransmission in the first symbol after the end of the Msg3 transmission;
- 1> monitor the PDCCH while the *ra-ContentionResolutionTimer* is running regardless of the possible occurrence of a measurement gap;

- 1> if notification of a reception of a PDCCH transmission of the SpCell is received from lower layers:
 - 2> if the C-RNTI MAC CE was included in Msg3:
 - 3> if the Random Access procedure was initiated for beam failure recovery (as specified in subclause 5.17) and the PDCCH transmission is addressed to the C-RNTI; or
 - 3> if the Random Access procedure was initiated by the MAC sublayer itself or by the RRC sublayer and the PDCCH transmission is addressed to the C-RNTI and contains a UL grant for a new transmission; or
 - 3> if the Random Access procedure was initiated by a PDCCH order and the PDCCH transmission is addressed to the C-RNTI;
 - > if the Random Access procedure was initiated for beam failure recovery (as specified in subclause 5.17) and the PDCCH transmission is addressed to the C-RNTI:
 - 4> consider this Contention Resolution successful;
 - 4> stop *ra-ContentionResolutionTimer*;
 - 4> discard the *TEMPORARY_C-RNTI*;
 - 4> consider this Random Access procedure successfully completed.
 - 2> else if the CCCH SDU was included in Msg3 and the PDCCH transmission is addressed to its *TEMPORARY_C-RNTI*:
 - 3> if the MAC PDU is successfully decoded:
 - 4> stop *ra-ContentionResolutionTimer*;
 - 4> if the MAC PDU contains a UE Contention Resolution Identity MAC CE; and
 - 4> if the UE Contention Resolution Identity in the MAC CE matches the CCCH SDU transmitted in Msg3:
 - 5> consider this Contention Resolution successful and finish the disassembly and demultiplexing of the MAC PDU;
 - 5> if this Random Access procedure was initiated for SI request:
 - 6> indicate the reception of an acknowledgement for SI request to upper layers.
 - 5> else:
 - 6> set the C-RNTI to the value of the *TEMPORARY_C-RNTI*;
 - 5> discard the *TEMPORARY_C-RNTI*;
 - 5> consider this Random Access procedure successfully completed.
 - 4> else:
 - 5> discard the *TEMPORARY_C-RNTI*;
 - 5> consider this Contention Resolution not successful and discard the successfully decoded MAC PDU.
 - 1> if *ra-ContentionResolutionTimer* expires:
 - 2> discard the *TEMPORARY_C-RNTI*;
 - 2> consider the Contention Resolution not successful.
 - 1> if the Contention Resolution is considered not successful:
 - 2> flush the HARQ buffer used for transmission of the MAC PDU in the Msg3 buffer;

- 2> increment *PREAMBLE_TRANSMISSION_COUNTER* by 1;
- 2> if *PREAMBLE_TRANSMISSION_COUNTER* = *preambleTransMax* + 1:
 - 3> indicate a Random Access problem to upper layers.
 - 3> if this Random Access procedure was triggered for SI request:
 - 4> consider the Random Access procedure unsuccessfully completed.
- 2> if the Random Access procedure is not completed:
 - 3> select a random backoff time according to a uniform distribution between 0 and the *PREAMBLE_BACKOFF*;
 - 3> if the criteria (as defined in subclause 5.1.2) to select contention-free Random Access Resources is met during the backoff time:
 - 3> perform the Random Access Resource selection procedure (see subclause 5.1.2).
 - 3> else:
 - 4> perform the Random Access Resource selection procedure (see subclause 5.1.2) after the backoff time.

[TS 38.321, clause 5.2]

RRC configures the following parameters for the maintenance of UL time alignment:

- *timeAlignmentTimer* (per TAG) which controls how long the MAC entity considers the Serving Cells belonging to the associated TAG to be uplink time aligned.

The MAC entity shall:

- 1> when a Timing Advance Command MAC CE is received, and if an N_{TA} (as defined in TS 38.211 [8]) has been maintained with the indicated TAG:
 - 2> apply the Timing Advance Command for the indicated TAG;
 - 2> start or restart the *timeAlignmentTimer* associated with the indicated TAG.
- 1> when a Timing Advance Command is received in a Random Access Response message for a Serving Cell belonging to a TAG:
 - 2> if the Random Access Preamble was not selected by the MAC entity among the contention-based Random Access Preamble:
 - 3> apply the Timing Advance Command for this TAG;
 - 3> start or restart the *timeAlignmentTimer* associated with this TAG.
 - 2> else if the *timeAlignmentTimer* associated with this TAG is not running:
 - 3> apply the Timing Advance Command for this TAG;
 - 3> start the *timeAlignmentTimer* associated with this TAG;
 - 3> when the Contention Resolution is considered not successful as described in subclause 5.1.5; or
 - 3> when the Contention Resolution is considered successful for SI request as described in subclause 5.1.5, after transmitting HARQ feedback for MAC PDU including UE Contention Resolution Identity MAC CE:
 - 4> stop *timeAlignmentTimer* associated with this TAG.
 - 2> else:
 - 3> ignore the received Timing Advance Command.

- 1> when a *timeAlignmentTimer* expires:
 - 2> if the *timeAlignmentTimer* is associated with the PTAG:
 - 3> flush all HARQ buffers for all Serving Cells;
 - 3> notify RRC to release PUCCH for all Serving Cells, if configured;
 - 3> notify RRC to release SRS for all Serving Cells, if configured;
 - 3> clear any configured downlink assignments and configured uplink grants;
 - 3> clear any PUSCH resource for semi-persistent CSI reporting;
 - 3> consider all running *timeAlignmentTimers* as expired;
 - 3> maintain N_{TA} (defined in TS 38.211 [8]) of all TAGs.
 - 2> else if the *timeAlignmentTimer* is associated with an STAG, then for all Serving Cells belonging to this TAG:
 - 3> flush all HARQ buffers;
 - 3> notify RRC to release PUCCH, if configured;
 - 3> notify RRC to release SRS, if configured;
 - 3> clear any configured downlink assignments and configured uplink grants;
 - 3> clear any PUSCH resource for semi-persistent CSI reporting;
 - 3> maintain N_{TA} (defined in TS 38.211 [8]) of this TAG.

When the MAC entity stops uplink transmissions for an SCell due to the fact that the maximum uplink transmission timing difference between TAGs of the MAC entity or the maximum uplink transmission timing difference between TAGs of any MAC entity of the UE is exceeded, the MAC entity considers the *timeAlignmentTimer* associated with the SCell as expired.

The MAC entity shall not perform any uplink transmission on a Serving Cell except the Random Access Preamble transmission when the *timeAlignmentTimer* associated with the TAG to which this Serving Cell belongs is not running. Furthermore, when the *timeAlignmentTimer* associated with the PTAG is not running, the MAC entity shall not perform any uplink transmission on any Serving Cell except the Random Access Preamble transmission on the SpCell.

[TS 38.321, clause 6.1.3.2]

The C-RNTI MAC CE is identified by MAC PDU subheader with LCID as specified in Table 6.2.1-2.

It has a fixed size and consists of a single field defined as follows (Figure 6.1.3.2-1):

- C-RNTI: This field contains the C-RNTI of the MAC entity. The length of the field is 16 bits.

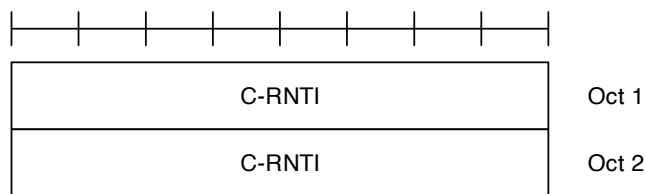

Figure 6.1.3.2-1: C-RNTI MAC CE

[TS 38.321, clause 6.1.5]

A MAC PDU consists of one or more MAC subPDUs and optionally padding. Each MAC subPDU consists one of the following:

- a MAC subheader with Backoff Indicator only;
- a MAC subheader with RAPID only (i.e. acknowledgment for SI request);
- a MAC subheader with RAPID and MAC RAR.

A MAC subheader with Backoff Indicator consists of five header fields E/T/R/R/BI as described in Figure 6.1.5-1. A MAC subPDU with Backoff Indicator only is placed at the beginning of the MAC PDU, if included. 'MAC subPDU(s) with RAPID only' and 'MAC subPDU(s) with RAPID and MAC RAR' can be placed anywhere between MAC subPDU with Backoff Indicator only (if any) and padding (if any).

A MAC subheader with RAPID consists of three header fields E/T/RAPID as described in Figure 6.1.5-2.

Padding is placed at the end of the MAC PDU if present. Presence and length of padding is implicit based on TB size, size of MAC subPDU(s).

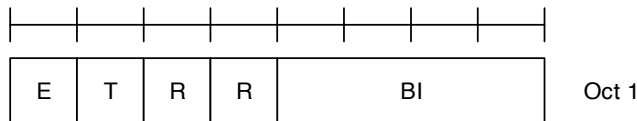

Figure 6.1.5-1: E/T/R/R/BI MAC subheader

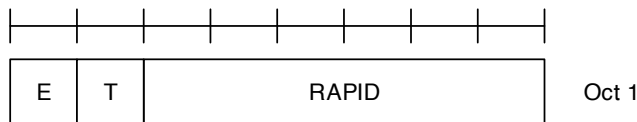

Figure 6.1.5-2: E/T/RAPID MAC subheader

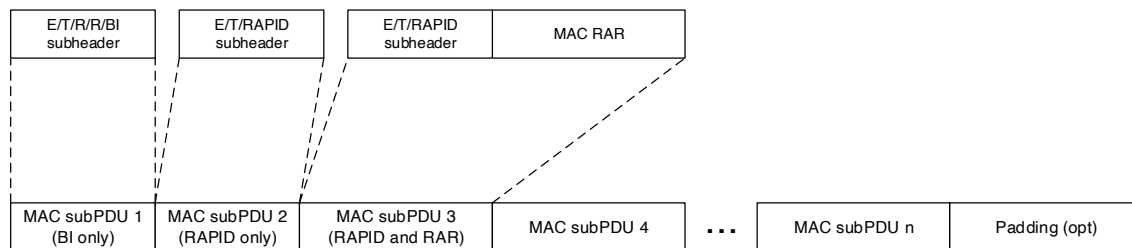

Figure 6.1.5-3: Example of MAC PDU consisting of MAC RARs

[TS 38.321, clause 6.2.3]

The MAC RAR is of fixed size as depicted in Figure 6.2.3-1, and consists of the following fields:

- R: Reserved bit, set to "0";
- Timing Advance Command: The Timing Advance Command field indicates the index value T_A used to control the amount of timing adjustment that the MAC entity has to apply in TS 38.213 [6]. The size of the Timing Advance Command field is 12 bits;
- UL Grant: The Uplink Grant field indicates the resources to be used on the uplink in TS 38.213 [6]. The size of the UL Grant field is 27 bits;
- Temporary C-RNTI: The Temporary C-RNTI field indicates the temporary identity that is used by the MAC entity during Random Access. The size of the Temporary C-RNTI field is 16 bits.

The MAC RAR is octet aligned.

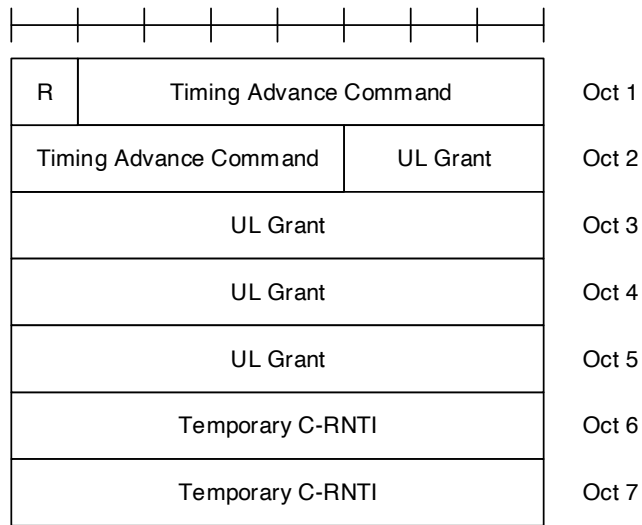

Figure 6.2.3-1: MAC RAR

7.1.1.1.6.3 Test description

7.1.1.1.6.3.1 Pre-test conditions

Same Pre-test conditions as in clause 7.1.1.0 except that Test loop function(Off).7.1.1.1.6.3.2 Test procedure sequence

Table 7.1.1.1.6.3.2-1: Main behaviour

St	Procedure	Message Sequence		TP	Verdict
		U - S	Message		
1	The SS transmits a Paging message including a matched UE identity.	<--	Paging	-	-
2	Check: Does the UE transmit preamble on PRACH using a preamble in group A defined in <i>-servingCellConfigCommon</i> in <i>SIB1</i> (totalNumberOfRA-Preambles, ssb-perRACH-OccasionAndCB-PreamblesPerSSB and numberOfRA-PreamblesGroupA)?	-->	PRACH Preamble	1	P
3	The SS transmits Random Access Response with RAPID corresponding to the transmitted Preamble in step 2, including TC-RNTI and not including Back off Indicator subheader.	<--	Random Access Response	-	-
4	The UE transmits a MAC PDU containing an <i>RRCSetupRequest</i> message. (Note 1)	-->	MAC PDU (<i>RRCSetupRequest</i>)	-	-
5	Before the contention resolution timer expires, the SS does not schedule any PDCCH.				
6	Check: Does the UE re-transmit a preamble on PRACH using a preamble in the same group A?	-->	PRACH Preamble	3	P
7	The SS transmits Random Access Response with RAPID corresponding to the transmitted Preamble in step 6, including TC-RNTI and not including Back off Indicator subheader.	<--	Random Access Response	-	-
8	The UE transmits a MAC PDU containing an <i>RRCSetupRequest</i> message. (Note 1)	-->	MAC PDU (<i>RRCSetupRequest</i>)	-	-
9	The SS schedules PDCCH transmission addressed to TC-RNTI to transmit a valid MAC PDU containing an <i>RRCSetup</i> message, but not including a matching 'UE Contention Resolution Identity' MAC control element.	<--	MAC PDU (<i>RRCSetup</i>)	-	-
-	EXCEPTION: In parallel with step 10, the parallel behaviour in table 7.1.1.1.6.3.2-2 is running.	-	-	-	-
10	Check: Does the UE re-transmit a preamble on PRACH using a preamble in the same group A?	-->	PRACH Preamble	2	P
11	The SS transmits Random Access Response with RAPID corresponding to the transmitted Preamble in step 10, including TC-RNTI and not including Back off Indicator subheader.	<--	Random Access Response	-	-
12	The UE transmits a MAC PDU containing an <i>RRCSetupRequest</i> message. (Note 1)	-->	MAC PDU (<i>RRCSetupRequest</i>)	-	-
13	The SS schedules PDCCH transmission addressed to TC-RNTI to transmit a valid MAC PDU containing an <i>RRCSetup</i> message and 'UE Contention Resolution Identity' MAC control element with matched 'Contention Resolution Identity'.	<--	MAC PDU (<i>RRCSetup</i> and UE Contention Resolution Identity MAC CE)	-	-
14	Check: Does UE transmit a MAC PDU containing an <i>RRCSetupComplete</i> message indicating acceptance of <i>RRCSetup</i> message?	-->	MAC PDU (<i>RRCSetupComplete</i>)	4	P
Note 1: Size of <i>RRCSetupRequest</i> message is 45 bits, octet aligned = 48 bits. With 16 bits of MAC Header the minimum size of MAC PDU carrying <i>RRCSetupRequest</i> is 64 bits.					

Table 7.1.1.1.6.3.2-2: Parallel behaviour

St	Procedure	Message Sequence		TP	Verdict
		U - S	Message		
1	Check: UE transmits a MAC PDU containing an <i>RRCSetupComplete</i> message indicating acceptance of <i>RRCSetup</i> message?	-->	MAC PDU (<i>RRCSetupComplete</i>)	2	F

7.1.1.1.6.3.3 Specific message contents

Table 7.1.1.1.6.3.3-1: *SIB1* (Preamble, Table 7.1.1.1.6.3.2-1)

Derivation Path: TS 38.508-1 [4], Table 4.6.1-28			
Information Element	Value/remark	Comment	Condition
<i>SIB1</i> ::= SEQUENCE {			
<i>servingCellConfigCommon</i> SEQUENCE {			
<i>uplinkConfigCommon</i> SEQUENCE {			
<i>initialUplinkBWP</i>	BWP-UplinkCommon		
}			
}			
}			

Table 7.1.1.1.6.3.3-2: *BWP-UplinkCommon* (Table 7.1.1.1.6.3.3-1)

Derivation Path: TS 38.508-1 [4], Table 4.6.3-10			
Information Element	Value/remark	Comment	Condition
<i>BWP-UplinkCommon</i> ::= SEQUENCE {			
<i>rach-ConfigCommon</i> CHOICE {			
<i>setup</i>	RACH-ConfigCommon		
}			
}			

Table 7.1.1.1.6.3.3-3: *RACH-ConfigCommon* (Table 7.1.1.1.6.3.3-2)

Derivation Path: TS 38.508-1 [4], Table 4.6.3-128			
Information Element	Value/remark	Comment	Condition
<i>RACH-ConfigCommon</i> ::= SEQUENCE {			
<i>rach-ConfigGeneric</i>	RACH-ConfigGeneric		
<i>totalNumberOfRA-Preambles</i>	42		
<i>ssb-perRACH-OccasionAndCB-PreamblesPerSSB</i>			
CHOICE {			
<i>One</i>	n32		
}			
<i>groupBconfigured</i> SEQUENCE {			
<i>ra-Msg3SizeGroupA</i>	b208		
<i>messagePowerOffsetGroupB</i>	minusinfinity		
<i>numberOfRA-PreamblesGroupA</i>	28		
}			
<i>ra-ContentionResolutionTimer</i>	sf48		
}			

7.1.1.2 Downlink Data Transfer

7.1.1.2.1 Correct Handling of DL MAC PDU / Assignment / HARQ process

7.1.1.2.1.1 Test Purpose (TP)

(1)

```
with { UE in RRC_CONNECTED state }
ensure that {
  when { UE receives downlink assignment on the PDCCH for the UE's C-RNTI and receives data in the
associated Slot and UE performs HARQ operation }
  then { UE sends a HARQ feedback on the HARQ process }
}
```

(2)

```
with { UE in RRC_CONNECTED state }
ensure that {
  when { SS transmits downlink assignment on the PDCCH with a C-RNTI unknown by the UE and data is
available in the associated Slot }
  then { UE does not send any HARQ feedback on the HARQ process }
}
```

(3)

```
with { UE in RRC_CONNECTED state }
ensure that {
  when { the UE receives a MAC PDU addressed to its C-RNTI and decode fails in the associated Slot }
  then { the UE transmits a NACK for the corresponding HARQ process }
}
```

(4)

```
with { UE in RRC_CONNECTED state }
ensure that {
  when { the UE receives a MAC PDU retransmission addressed to its C-RNTI, and results in successful
decode in the associated Slot }
  then { the UE transmits an ACK for the corresponding HARQ process and forward to higher layer }
}
```

(5)

```
with { UE in RRC_CONNECTED state }
ensure that {
  when { UE receives a MAC PDU containing multiple MAC sub PDUs each containing a MAC SDU that is
larger than 256 bytes (16 bits L field used) with padding MAC sub PDU at the end }
  then { UE successfully decodes the MAC PDU and forward to higher layer }
}
```

(6)

```
with { UE in RRC_CONNECTED state }
ensure that {
  when { UE receives a MAC PDU containing multiple MAC sub PDUs each containing a MAC SDU that is
smaller than 256 bytes (8 bits L field used) with padding MAC sub PDU at the end }
  then { UE successfully decodes the MAC PDU and forward to higher layer }
}
```

(7)

```
with { UE in RRC_CONNECTED state }
ensure that {
  when { UE receives a MAC PDU containing MAC sub PDU containing a MAC SDU and no padding MAC sub
PDU }
  then { UE successfully decodes the MAC PDU and forward to higher layer }
}
```

(8)

```

with { UE in RRC_CONNECTED state }
ensure that {
  when { UE receives a MAC PDU containing MAC sub PDU containing a MAC SDU that is smaller than 256
bytes (8 bits L field used) plus MAC sub PDU containing a MAC SDU that is greater than 256 bytes (16
bits L field used) and no padding }
  then { UE successfully decodes the MAC PDU and forwards the AMD PDUs to higher layer }
}

```

(9)

```

with { UE in RRC_CONNECTED state and configured with a specific TDD-UL-DL-ConfigCommon including
configuration of pattern2 }
ensure that {
  when { UE receives downlink assignment on the PDCCH associated with pattern2 for the UE's C-RNTI
and receives data in the associated Slot and UE performs HARQ operation }
  then { UE sends a HARQ feedback on the HARQ process }
}

```

7.1.1.2.1.2 Conformance requirements

References: The conformance requirements covered in the present TC are specified in: TS 38.321, clauses 5.3.1, 5.3.2.1, 5.3.2.2 and 6.1.2. Unless otherwise stated these are Rel-15 requirements.

[TS 38.321, clause 5.3.1]

Downlink assignments received on the PDCCH both indicate that there is a transmission on a DL-SCH for a particular MAC entity and provide the relevant HARQ information.

When the MAC entity has a C-RNTI, Temporary C-RNTI, or CS-RNTI, the MAC entity shall for each PDCCH occasion during which it monitors PDCCH and for each Serving Cell:

- 1> if a downlink assignment for this PDCCH occasion and this Serving Cell has been received on the PDCCH for the MAC entity's C-RNTI, or Temporary C-RNTI:
 - 2> if this is the first downlink assignment for this Temporary C-RNTI:
 - 3> consider the NDI to have been toggled.
 - 2> if the downlink assignment is for the MAC entity's C-RNTI, and if the previous downlink assignment indicated to the HARQ entity of the same HARQ process was either a downlink assignment received for the MAC entity's CS-RNTI or a configured downlink assignment:
 - 3> consider the NDI to have been toggled regardless of the value of the NDI.
 - 2> indicate the presence of a downlink assignment and deliver the associated HARQ information to the HARQ entity.
- 1> else if a downlink assignment for this PDCCH occasion has been received for this Serving Cell on the PDCCH for the MAC entity's CS-RNTI:
 - 2> if the NDI in the received HARQ information is 1:
 - 3> consider the NDI for the corresponding HARQ process not to have been toggled;
 - 3> indicate the presence of a downlink assignment for this Serving Cell and deliver the associated HARQ information to the HARQ entity.
 - 2> if the NDI in the received HARQ information is 0:
 - 3> if PDCCH contents indicate SPS deactivation:
 - 4> clear the configured downlink assignment for this Serving Cell (if any);
 - 4> if the timeAlignmentTimer associated with the PTAG is running:
 - 5> indicate a positive acknowledgement for the SPS deactivation to the physical layer.

- 3> else if PDCCH content indicates SPS activation:
 - 4> store the downlink assignment for this Serving Cell and the associated HARQ information as configured downlink assignment;
 - 4> initialise or re-initialise the configured downlink assignment for this Serving Cell to start in the associated PDSCH duration and to recur according to rules in subclause 5.8.1;
 - 4> set the HARQ Process ID to the HARQ Process ID associated with this PDSCH duration;
 - 4> consider the NDI bit for the corresponding HARQ process to have been toggled;
 - 4> indicate the presence of a configured downlink assignment for this Serving Cell and deliver the stored HARQ information to the HARQ entity.

For each Serving Cell and each configured downlink assignment, if configured and activated, the MAC entity shall:

- 1> if the PDSCH duration of the configured downlink assignment does not overlap with the PDSCH duration of a downlink assignment received on the PDCCH for this Serving Cell:
 - 2> instruct the physical layer to receive, in this PDSCH duration, transport block on the DL-SCH according to the configured downlink assignment and to deliver it to the HARQ entity;
 - 2> set the HARQ Process ID to the HARQ Process ID associated with this PDSCH duration;
 - 2> consider the NDI bit to have been toggled;
 - 2> indicate the presence of a configured downlink assignment and deliver the stored HARQ information to the HARQ entity.

For configured downlink assignments, the HARQ Process ID associated with the slot where the DL transmission starts is derived from the following equation:

$$\text{HARQ Process ID} = [\text{floor}(\text{CURRENT_slot} \times 10 / (\text{numberOfSlotsPerFrame} \times \text{semiPersistSchedIntervalDL})) \bmod \text{nrofHARQ-Processes}]$$

where $\text{CURRENT_slot} = [(\text{SFN} \times \text{numberOfSlotsPerFrame}) + \text{slot number in the frame}]$ and *numberOfSlotsPerFrame* refers to the number of consecutive slots per frame as specified in TS 38.211 [8].

When the MAC entity needs to read BCCH, the MAC entity may, based on the scheduling information from RRC:

- 1> if a downlink assignment for this PDCCH occasion has been received on the PDCCH for the SI-RNTI;
- 2> indicate a downlink assignment and redundancy version for the dedicated broadcast HARQ process to the HARQ entity.

[TS 38.321, clause 5.3.2.2]

When a transmission takes place for the HARQ process, one or more (in case of downlink spatial multiplexing) TBs and the associated HARQ information are received from the HARQ entity.

For each received TB and associated HARQ information, the HARQ process shall:

- 1> if the NDI, when provided, has been toggled compared to the value of the previous received transmission corresponding to this TB; or
- 1> if the HARQ process is equal to the broadcast process, and this is the first received transmission for the TB according to the system information schedule indicated by RRC; or
- 1> if this is the very first received transmission for this TB (i.e. there is no previous NDI for this TB):
 - 2> consider this transmission to be a new transmission.
- 1> else:
 - 2> consider this transmission to be a retransmission.

The MAC entity then shall:

- 1> if this is a new transmission:
 - 2> attempt to decode the received data.
- 1> else if this is a retransmission:
 - 2> if the data for this TB has not yet been successfully decoded:
 - 3> instruct the physical layer to combine the received data with the data currently in the soft buffer for this TB and attempt to decode the combined data.
 - 1> if the data which the MAC entity attempted to decode was successfully decoded for this TB; or
 - 1> if the data for this TB was successfully decoded before:
 - 2> if the HARQ process is equal to the broadcast process:
 - 3> deliver the decoded MAC PDU to upper layers.
 - 2> else if this is the first successful decoding of the data for this TB:
 - 3> deliver the decoded MAC PDU to the disassembly and demultiplexing entity.
 - 1> else:
 - 2> instruct the physical layer to replace the data in the soft buffer for this TB with the data which the MAC entity attempted to decode;
 - 1> if the HARQ process is associated with a transmission indicated with a Temporary C-RNTI and the Contention Resolution is not yet successful (see subclause 5.1.5); or
 - 1> if the HARQ process is equal to the broadcast process; or
 - 1> if the *timeAlignmentTimer*, associated with the TAG containing the Serving Cell on which the HARQ feedback is to be transmitted, is stopped or expired:
 - 2> not instruct the physical layer to generate acknowledgement(s) of the data in this TB.
 - 1> else:
 - 2> instruct the physical layer to generate acknowledgement(s) of the data in this TB.

The MAC entity shall ignore NDI received in all downlink assignments on PDCCH for its Temporary C-RNTI when determining if NDI on PDCCH for its C-RNTI has been toggled compared to the value in the previous transmission.

[TS 38.321, clause 6.1.2]

A MAC PDU consists of one or more MAC subPDUs. Each MAC subPDU consists of one of the following:

- A MAC subheader only (including padding);
- A MAC subheader and a MAC SDU;
- A MAC subheader and a MAC CE;
- A MAC subheader and padding.

The MAC SDUs are of variable sizes.

Each MAC subheader corresponds to either a MAC SDU, a MAC CE, or padding.

A MAC subheader except for fixed sized MAC CE and padding consists of the four header fields R/F/LCID/L. A MAC subheader for fixed sized MAC CE and padding consists of the two header fields R/LCID.

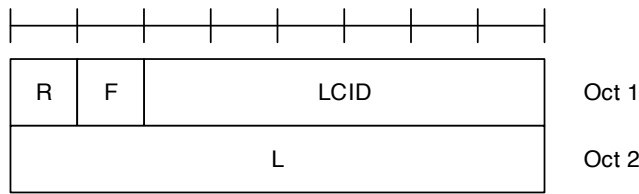

Figure 6.1.2-1: R/F/LCID/L MAC subheader with 8-bit L field

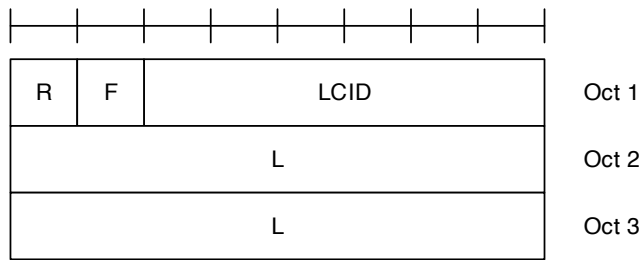

Figure 6.1.2-2: R/F/LCID/L MAC subheader with 16-bit L field

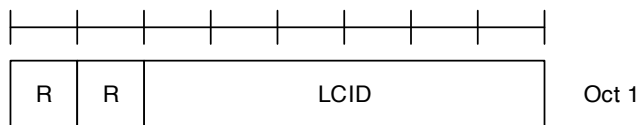

Figure 6.1.2-3: R/LCID MAC subheader

MAC CEs are placed together. DL MAC subPDU(s) with MAC CE(s) is placed before any MAC subPDU with MAC SDU and MAC subPDU with padding as depicted in Figure 6.1.2-4. UL MAC subPDU(s) with MAC CE(s) is placed after all the MAC subPDU(s) with MAC SDU and before the MAC subPDU with padding in the MAC PDU as depicted in Figure 6.1.2-5. The size of padding can be zero.

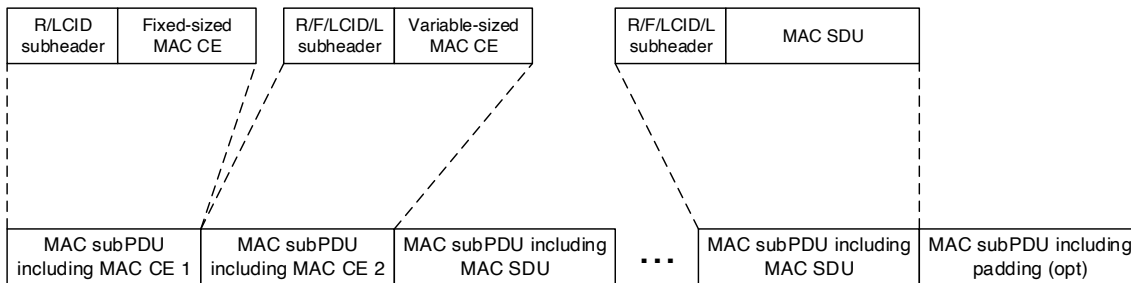

Figure 6.1.2-4: Example of a DL MAC PDU

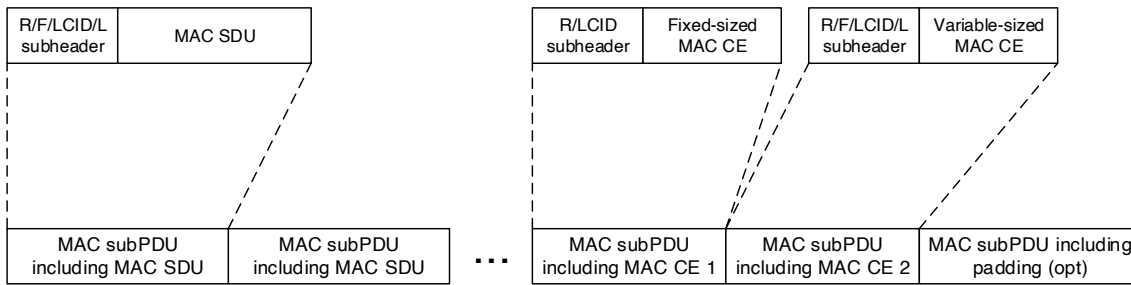

Figure 6.1.2-5: Example of a UL MAC PDU

A maximum of one MAC PDU can be transmitted per TB per MAC entity.

7.1.1.2.1.3 Test description

7.1.1.2.1.3.1 Pre-test conditions

Same Pre-test conditions as in clause 7.1.1.0 except that set to return no data in uplink and parameters as in Table 7.1.1.2.1.3.1-1.

Table 7.1.1.2.1.3.1-1: MAC Parameters

nrofHARQ-ProcessesForPDSCH	n16
----------------------------	-----

7.1.1.2.1.3.2 Test procedure sequence

Table 7.1.1.2.1.3.2-1: Main behaviour

St	Procedure	Message Sequence		TP	Verdict
		U - S	Message		
1	SS transmits a downlink assignment addressed to the C-RNTI assigned to the UE	<--	(PDCCH (C-RNTI))	-	-
2	SS transmits in the indicated downlink assignment a MAC PDU including a RLC PDU with poll bit not set.	<--	MAC PDU	-	-
3	Check: Does the UE transmit an HARQ ACK on PUCCH?	-->	HARQ ACK	1	P
4	SS transmits a downlink assignment to including a C-RNTI different from the assigned to the UE	<--	(PDCCH (unknown C-RNTI))	-	-
5	SS transmits in the indicated downlink assignment a RLC PDU in a MAC PDU including a RLC PDU with poll bit not set.	<--	MAC PDU	-	-
6	Check: Does the UE send any HARQ ACK/NACK on PUCCH?	-->	HARQ ACK/NACK	2	F
-	EXCEPTION: Steps 7 to 10 are run repeated using test parameter values as given for each iteration in table 7.1.1.2.1.3.2.-2.	-	-	-	-
7	The SS indicates a new transmission on PDCCH and transmits a MAC PDU including a RLC PDU with poll bit not set, with content set so that UE could not successfully decode the data from its soft buffer. (Note 1)	<--	MAC PDU	-	-
8	Check: Does the UE transmit a HARQ NACK?	-->	HARQ NACK	3	P
-	EXCEPTION: Step 9 shall be repeated till HARQ ACK is received at step 10 or until HARQ retransmission count = 4 is reached for MAC PDU at step 9 (Note 2).	-	-	-	-
9	The SS indicates a retransmission on PDCCH and transmits the same MAC PDU like step 7 (Note 1).	<--	MAC PDU	-	-
-	EXCEPTION: Up to [3] HARQ NACK from the UE should be allowed at step 10 (Note 2).	-	-	-	-
10	Check: Does the UE send a HARQ ACK?	-->	HARQ ACK	4	P
11	The SS transmits a MAC PDU containing three MAC sub PDUs each containing a MAC SDU(RLC PDU) that is of 260 bytes (16 bits L field used) and a padding MAC sub PDU at the end. The third RLC PDU contained will have poll bit set.	<--	MAC PDU	-	-
12	Check: Does the UE transmit a MAC PDU containing an RLC STATUS PDU acknowledging the reception of all the AMD PDUs in step 11?	-->	MAC PDU (RLC STATUS PDU)	5	P
13	The SS transmits a MAC PDU containing three MAC sub PDUs each containing a MAC SDU(RLC PDU) that is of 128 bytes (8 bits L field used) and a padding MAC sub PDU at the end. The third RLC PDU contained will have poll bit set.	<--	MAC PDU	-	-
14	Check: Does the UE transmit a MAC PDU containing an RLC STATUS PDU acknowledging the reception of all the AMD PDUs in step 13?	-->	MAC PDU (RLC STATUS PDU)	6	P
15	The SS transmits a MAC PDU containing one MAC sub PDU containing a MAC SDU(RLC PDU) that is of [128] bytes (8 bits L field used) and no padding MAC sub PDU at the end. The RLC PDU contained will have poll bit set.	<--	MAC PDU	-	-
16	Check: Does the UE transmit a MAC PDU containing an RLC STATUS PDU	-->	MAC PDU (RLC STATUS PDU)	7	P

	acknowledging the reception of the AMD PDU in step 15?				
17	The SS transmits a MAC PDU containing one MAC sub PDU containing a MAC SDU(RLC PDU) that is of [128] bytes (8 bits L field used), one MAC sub PDU containing a MAC SDU(RLC PDU) that is of [260] bytes (16 bits L field used) and no padding MAC sub PDU at the end. The second RLC PDU contained will have poll bit set.	<-	MAC PDU	-	-
18	Check: Does the UE transmit a MAC PDU containing an RLC STATUS PDU acknowledging the reception of all the AMD PDUs in step 17?	-->	MAC PDU (RLC STATUS PDU)	8	P
-	EXCEPTION : Steps 19a0 to 19a5 are executed for operation on NR TDD band only	-	-	-	-
19a0	The SS transmits an updated system information as specified in Table 7.1.1.3.1.3.3-14. (Note 5)	-	-	-	-
19a1	The SS transmits NR RRCReconfiguration message including <i>TDD-UL-DL-ConfigCommon</i> with <i>pattern1</i> and <i>pattern2</i> specified in Table 7.1.1.2.1.3.3-5 (Note 3)	<-	<i>RRCReconfiguration</i>	-	-
19a2	The UE transmits a NR <i>RRCReconfigurationComplete</i> message. (Note 4)	-->	<i>RRCReconfigurationComplete</i>	-	-
19a3	SS transmits a downlink assignment addressed to the C-RNTI assigned to the UE indicating downlink reception in a symbol in a slot part of <i>pattern2</i> .	<-	(PDCCH (C-RNTI))	-	-
19a4	SS transmits in the indicated downlink assignment a MAC PDU including a RLC PDU with poll bit not set.	<-	MAC PDU	-	-
19a5	Check: Does the UE transmit an HARQ ACK on PUCCH?	-->	HARQ ACK	9	P
Note 1:	SS should transmit this PDU so as to ensure at least one NACK.				
Note 2:	The value 4 for the maximum number of HARQ retransmissions has been chosen based on an assumption that, given the radio conditions used in this test case, a UE soft combiner implementation should have sufficient retransmissions to be able to successfully decode the data in its soft buffer.				
Note 3:	For EN-DC the NR RRCReconfiguration message is contained in RRCConnectionReconfiguration 36.508 [7], Table 4.6.1-8 using condition EN-DC_EmbedNR_RRCRecon.				
Note 4:	For EN-DC the NR RRCReconfigurationComplete message is contained in RRCConnectionReconfigurationComplete.				
Note 5:	if <i>pc_NG_RAN_NR</i> only				

Table 7.1.1.2.1.3.2-2: Test Parameters

Iteration	DL HARQ process (X)
K=1 to 16	X=K-1

7.1.1.2.1.3.3 Specific message contents

Table 7.1.1.2.1.3.3-1: Void**Table 7.1.1.2.1.3.3-2: RRCReconfiguration (step19a1, Table 7.1.1.2.1.3.2-1)**

Derivation Path: 38.508-1 [4], Table 4.6.1-131			
Information Element	Value/remark	Comment	Condition
RRCReconfiguration ::= SEQUENCE {			
criticalExtensions CHOICE {			
rrcReconfiguration ::= SEQUENCE {			
secondaryCellGroup	CellGroupConfig		EN-DC
}			
RRCReconfiguration-v1530-IEs ::= SEQUENCE {			NR
masterCellGroup	CellGroupConfig		
}			
}			
}			

Table 7.1.1.2.1.3.3-3: CellGroupConfig (Table 7.1.1.2.1.3.3-2)

Derivation Path: TS 38.508-1 [4], Table 4.6.3-19			
Information Element	Value/remark	Comment	Condition
CellGroupConfig ::= SEQUENCE {			
spCellConfig SEQUENCE {			
reconfigurationWithSync SEQUENCE {			
spCellConfigCommon	ServingCellConfigCommon		
}			
spCellConfigDedicated	ServingCellConfig		
}			
}			

Table 7.1.1.2.1.3.3-4, 7.1.1.2.1.3.3-13: ServingCellConfigCommon (Table 7.1.1.2.1.3.3-3)

Derivation Path: TS 38.508-1 [4], Table 4.6.3-168			
Information Element	Value/remark	Comment	Condition
ServingCellConfigCommon ::= SEQUENCE {			
uplinkConfigCommon SEQUENCE {			
initialUplinkBWP	BWP-UplinkCommon		
}			
tdd-UL-DL-ConfigurationCommon	TDD-UL-DL-ConfigCommon		
}			

Table 7.1.1.2.1.3.3-5: TDD-UL-DL-ConfigCommon (Table 7.1.1.2.1.3.3-4)

Derivation Path: TS 38.508-1 [4], Table 4.6.3-192			
Information Element	Value/remark	Comment	Condition
TDD-UL-DL-ConfigCommon ::= SEQUENCE {			
referenceSubcarrierSpacing	SubcarrierSpacing		
pattern1 SEQUENCE {			
dl-UL-TransmissionPeriodicity	ms5		FR1
	ms0p625		FR2
nrofDownlinkSlots	3		FR1
	2		FR2
nrofDownlinkSymbols	6		FR1
	6		FR2
nrofUplinkSlots	2		FR1
	2		FR2
nrofUplinkSymbols	4		FR1
	2		FR2
dl-UL-TransmissionPeriodicity-v1530	ms3		FR1
}			
pattern2 SEQUENCE {			
dl-UL-TransmissionPeriodicity	ms2		FR1
	ms0p625		FR2
nrofDownlinkSlots	4		FR1
	3		FR2
nrofDownlinkSymbols	0		FR1
	6		FR2
nrofUplinkSlots	0		FR1
	1		FR2
nrofUplinkSymbols	0		FR1
	2		FR2
}			
}			

Table 7.1.1.2.1.3.3-6: BWP-UplinkCommon (Table 7.1.1.2.1.3.3-4)

Derivation Path: TS 38.508-1 [4], Table 4.6.3-14			
Information Element	Value/remark	Comment	Condition
BWP-UplinkCommon ::= SEQUENCE {			
rach-ConfigCommon CHOICE {			
setup	RACH-ConfigCommon		
}			
}			

Table 7.1.1.2.1.3.3-7: RACH-ConfigCommon (Table 7.1.1.2.1.3.3-6)

Derivation Path: TS 38.508-1 [4], Table 4.6.3-128			
Information Element	Value/remark	Comment	Condition
RACH-ConfigCommon ::= SEQUENCE {			
rach-ConfigGeneric	RACH-ConfigGeneric		
}			

Table 7.1.1.2.1.3.3-8: RACH-ConfigGeneric (Table 7.1.1.2.1.3.3-7)

Derivation Path: TS 38.508-1 [4], Table 4.6.3-130			
Information Element	Value/remark	Comment	Condition
RACH-ConfigGeneric ::= SEQUENCE {			
prach-configurationIndex	156		
}			

Table 7.1.1.2.1.3.3-9: ServingCellConfig (Table 7.1.1.2.1.3.3-3)

Derivation Path: TS 38.508-1 [4], Table 4.6.3-167			
Information Element	Value/remark	Comment	Condition
ServingCellConfig ::= SEQUENCE {			
uplinkConfig SEQUENCE {			
initialUplinkBWP	BWP-UplinkDedicated		
}			
}			

Table 7.1.1.2.1.3.3-10: BWP-UplinkDedicated (Table 7.1.1.2.1.3.3-9)

Derivation Path: TS 38.508-1 [4], Table 4.6.3-15			
Information Element	Value/remark	Comment	Condition
BWP-UplinkDedicated ::= SEQUENCE {			
pucch-Config CHOICE {			
setup	PUCCH-Config		
}			
}			

Table 7.1.1.2.1.3.3-11: PUCCH-Config (Table 7.1.1.2.1.3.3-10)

Derivation Path: TS 38.508-1 [4], Table 4.6.3-112			
Information Element	Value/remark	Comment	Condition
PUCCH-Config ::= SEQUENCE {			
schedulingRequestResourceToAddModList	1 entry		
SEQUENCE (SIZE (1..maxNrofSR-Resources)) OF			
SchedulingRequestResourceConfig {			
SchedulingRequestResourceConfig[1]	SchedulingRequestResourceConfig	entry 1	
}			
}			

Table 7.1.1.2.1.3.3-12: SchedulingRequestResourceConfig (Table 7.1.1.2.1.3.3-11)

Derivation Path: TS 38.508-1 [4], Table 4.6.3-112			
Information Element	Value/remark	Comment	Condition
SchedulingRequestResourceConfig ::= SEQUENCE {			
periodicityAndOffset CHOICE {			
sl10	5	With SCS = kHz15 results in repetition every 10 ms	SCS_15kHz
sl20	5	With SCS = kHz30 results in repetition every 10 ms	SCS_30kHz
sl80	5	With SCS = kHz120 results in repetition every 10 ms	SCS_120kHz
}			
}			

Table 7.1.1.2.1.3.3-13: SystemInformationBlockType1 (step 19a0, Table 7.1.1.2.1.3.2-1)

Derivation path: 38.508-1 [4] table 4.6.1-28			
Information Element	Value/Remark	Comment	Condition
SIB1 ::= SEQUENCE {			
servingCellConfigCommon	ServingCellConfigCommon	Same contents as in Table 7.1.1.2.1.3.3-5	
}			

7.1.1.2.2 Correct Handling of DL HARQ process PDSCH Aggregation

7.1.1.2.2.1 Test Purpose (TP)

(1)

```
with { UE in RRC_CONNECTED state and pdsch-AggregationFactor > 1 }
ensure that {
  when { UE receives downlink assignment on the PDCCH for the UE's C-RNTI and receives data in the
associated slot and successive pdsch-AggregationFactor - 1 HARQ retransmissions within a bundle and
UE performs HARQ operation }
  then { UE sends a HARQ feedback on the HARQ process }
}
```

7.1.1.2.2.2 Conformance requirements

References: The conformance requirements covered in the current TC are specified in: TS 38.321, clauses 5.3.1, 5.3.2.1 and 5.3.2.2, TS 38.214, clause 5.1.2.1.

[TS 38.321, clause 5.3.1]

Downlink assignments received on the PDCCH both indicate that there is a transmission on a DL-SCH for a particular MAC entity and provide the relevant HARQ information.

When the MAC entity has a C-RNTI, Temporary C-RNTI, or CS-RNTI, the MAC entity shall for each PDCCH occasion during which it monitors PDCCH and for each Serving Cell:

- 1> if a downlink assignment for this PDCCH occasion and this Serving Cell has been received on the PDCCH for the MAC entity's C-RNTI, or Temporary C-RNTI:
 - 2> if this is the first downlink assignment for this Temporary C-RNTI:
 - 3> consider the NDI to have been toggled.
 - 2> if the downlink assignment is for the MAC entity's C-RNTI, and if the previous downlink assignment indicated to the HARQ entity of the same HARQ process was either a downlink assignment received for the MAC entity's CS-RNTI or a configured downlink assignment:
 - 3> consider the NDI to have been toggled regardless of the value of the NDI.
 - 2> indicate the presence of a downlink assignment and deliver the associated HARQ information to the HARQ entity.
- 1> else if a downlink assignment for this PDCCH occasion has been received for this Serving Cell on the PDCCH for the MAC entity's CS-RNTI:
 - 2> if the NDI in the received HARQ information is 1:
 - 3> consider the NDI for the corresponding HARQ process not to have been toggled;
 - 3> indicate the presence of a downlink assignment for this Serving Cell and deliver the associated HARQ information to the HARQ entity.
 - 2> if the NDI in the received HARQ information is 0:

- 3> if PDCCH contents indicate SPS deactivation:
 - 4> clear the configured downlink assignment for this Serving Cell (if any);
 - 4> if the timeAlignmentTimer associated with the PTAG is running:
 - 5> indicate a positive acknowledgement for the SPS deactivation to the physical layer.
- 3> else if PDCCH content indicates SPS activation:
 - 4> store the downlink assignment for this Serving Cell and the associated HARQ information as configured downlink assignment;
 - 4> initialise or re-initialise the configured downlink assignment for this Serving Cell to start in the associated PDSCH duration and to recur according to rules in subclause 5.8.1;
 - 4> set the HARQ Process ID to the HARQ Process ID associated with this PDSCH duration;
 - 4> consider the NDI bit for the corresponding HARQ process to have been toggled;
 - 4> indicate the presence of a configured downlink assignment for this Serving Cell and deliver the stored HARQ information to the HARQ entity.

For each Serving Cell and each configured downlink assignment, if configured and activated, the MAC entity shall:

- 1> if the PDSCH duration of the configured downlink assignment does not overlap with the PDSCH duration of a downlink assignment received on the PDCCH for this Serving Cell:
 - 2> instruct the physical layer to receive, in this PDSCH duration, transport block on the DL-SCH according to the configured downlink assignment and to deliver it to the HARQ entity;
 - 2> set the HARQ Process ID to the HARQ Process ID associated with this PDSCH duration;
 - 2> consider the NDI bit to have been toggled;
 - 2> indicate the presence of a configured downlink assignment and deliver the stored HARQ information to the HARQ entity.

For configured downlink assignments, the HARQ Process ID associated with the slot where the DL transmission starts is derived from the following equation:

$$\text{HARQ Process ID} = [\text{floor}(\text{CURRENT_slot} \times 10 / (\text{numberOfSlotsPerFrame} \times \text{periodicity}))] \text{ modulo } n_{\text{rofHARQ-Processes}}$$

where $\text{CURRENT_slot} = [(\text{SFN} \times \text{numberOfSlotsPerFrame}) + \text{slot number in the frame}]$ and $\text{numberOfSlotsPerFrame}$ refers to the number of consecutive slots per frame as specified in TS 38.211 [8].

When the MAC entity needs to read BCCH, the MAC entity may, based on the scheduling information from RRC:

- 1> if a downlink assignment for this PDCCH occasion has been received on the PDCCH for the SI-RNTI;
 - 2> indicate a downlink assignment and redundancy version for the dedicated broadcast HARQ process to the HARQ entity.

[TS 38.321, clause 5.3.2.1]

The MAC entity includes a HARQ entity for each Serving Cell, which maintains a number of parallel HARQ processes. Each HARQ process is associated with a HARQ process identifier. The HARQ entity directs HARQ information and associated TBs received on the DL-SCH to the corresponding HARQ processes (see subclause 5.3.2.2).

The number of parallel DL HARQ processes per HARQ entity is specified in TS 38.214 [7]. The dedicated broadcast HARQ process is used for BCCH.

The HARQ process supports one TB when the physical layer is not configured for downlink spatial multiplexing. The HARQ process supports one or two TBs when the physical layer is configured for downlink spatial multiplexing.

When the MAC entity is configured with *pdsch-AggregationFactor* > 1, the parameter *pdsch-AggregationFactor* provides the number of transmissions of a TB within a bundle of the dynamic downlink assignment. Bundling operation relies on the HARQ entity for invoking the same HARQ process for each transmission that is part of the same bundle. After the initial transmission, *pdsch-AggregationFactor* – 1 HARQ retransmissions follow within a bundle.

The MAC entity shall:

- 1> if a downlink assignment has been indicated:
 - 2> allocate the TB(s) received from the physical layer and the associated HARQ information to the HARQ process indicated by the associated HARQ information.
- 1> if a downlink assignment has been indicated for the broadcast HARQ process:
 - 2> allocate the received TB to the broadcast HARQ process.

[TS 38.321, clause 5.3.2.2]

When a transmission takes place for the HARQ process, one or two (in case of downlink spatial multiplexing) TBs and the associated HARQ information are received from the HARQ entity.

For each received TB and associated HARQ information, the HARQ process shall:

- 1> if the NDI, when provided, has been toggled compared to the value of the previous received transmission corresponding to this TB; or
- 1> if the HARQ process is equal to the broadcast process, and this is the first received transmission for the TB according to the system information schedule indicated by RRC; or
- 1> if this is the very first received transmission for this TB (i.e. there is no previous NDI for this TB):
 - 2> consider this transmission to be a new transmission.
- 1> else:
 - 2> consider this transmission to be a retransmission.

The MAC entity then shall:

- 1> if this is a new transmission:
 - 2> attempt to decode the received data.
- 1> else if this is a retransmission:
 - 2> if the data for this TB has not yet been successfully decoded:
 - 3> instruct the physical layer to combine the received data with the data currently in the soft buffer for this TB and attempt to decode the combined data.
- 1> if the data which the MAC entity attempted to decode was successfully decoded for this TB; or
- 1> if the data for this TB was successfully decoded before:
 - 2> if the HARQ process is equal to the broadcast process:
 - 3> deliver the decoded MAC PDU to upper layers.
 - 2> else if this is the first successful decoding of the data for this TB:
 - 3> deliver the decoded MAC PDU to the disassembly and demultiplexing entity.
- 1> else:
 - 2> instruct the physical layer to replace the data in the soft buffer for this TB with the data which the MAC entity attempted to decode.

- 1> if the HARQ process is associated with a transmission indicated with a Temporary C-RNTI and the Contention Resolution is not yet successful (see subclause 5.1.5); or
- 1> if the HARQ process is equal to the broadcast process; or
- 1> if the *timeAlignmentTimer*, associated with the TAG containing the Serving Cell on which the HARQ feedback is to be transmitted, is stopped or expired:
 - 2> not instruct the physical layer to generate acknowledgement(s) of the data in this TB.
- 1> else:
 - 2> instruct the physical layer to generate acknowledgement(s) of the data in this TB.

The MAC entity shall ignore NDI received in all downlink assignments on PDCCH for its Temporary C-RNTI when determining if NDI on PDCCH for its C-RNTI has been toggled compared to the value in the previous transmission.

[TS 38.214, clause 5.1.2.1]

When the UE is scheduled to receive PDSCH by a DCI, the *Time domain resource assignment* field value m of the DCI provides a row index $m + 1$ to an allocation table. The determination of the used resource allocation table is defined in sub-clause 5.1.2.1.1. The indexed row defines the slot offset K_0 , the start and length indicator *SLIV*, or directly the start symbol S and the allocation length L , and the PDSCH mapping type to be assumed in the PDSCH reception.

Given the parameter values of the indexed row:

- The slot allocated for the PDSCH is $\left\lfloor n \cdot \frac{2^{\mu_{\text{PDSCH}}}}{2^{\mu_{\text{PDCCH}}}} \right\rfloor + K_0$, where n is the slot with the scheduling DCI, and K_0 is

based on the numerology of PDSCH, and μ_{PDSCH} and μ_{PDCCH} are the subcarrier spacing configurations for PDSCH and PDCCH, respectively, and

- The starting symbol S relative to the start of the slot, and the number of consecutive symbols L counting from the symbol S allocated for the PDSCH are determined from the start and length indicator *SLIV*:

if $(L-1) \leq 7$ then

$$SLIV = 14 \cdot (L-1) + S$$

else

$$SLIV = 14 \cdot (14 - L + 1) + (14 - 1 - S)$$

where $0 < L \leq 14 - S$, and

- The PDSCH mapping type is set to Type A or Type B as defined in sub-clause 7.4.1.1.2 of [4, TS 38.211].

The UE shall consider the S and L combinations defined in table 5.1.2.1-1 as valid PDSCH allocations:

Table 5.1.2.1-1: Valid S and L combinations

PDSCH mapping type	Normal cyclic prefix			Extended cyclic prefix		
	S	L	$S+L$	S	L	$S+L$
Type A	{0,1,2,3} (Note 1)	{3,...,14}	{3,...,14}	{0,1,2,3} (Note 1)	{3,...,12}	{3,...,12}
Type B	{0,...,12}	{2,4,7}	{2,...,14}	{0,...,10}	{2,4,6}	{2,...,12}
Note 1: $S = 3$ is applicable only if <i>dmrs-TypeA-Position</i> = 3						

When the UE is configured with *aggregationFactorDL* > 1, the same symbol allocation is applied across the *aggregationFactorDL* consecutive slots. The UE may expect that the TB is repeated within each symbol allocation among each of the *aggregationFactorDL* consecutive slots and the PDSCH is limited to a single transmission layer. The redundancy version to be applied on the n^{th} transmission occasion of the TB is determined according to table 5.1.2.1-2.

Table 5.1.2.1-2: Applied redundancy version when *aggregationFactorDL* > 1

<i>rvid</i> indicated by the DCI scheduling the PDSCH	<i>rvid</i> to be applied to <i>n</i> th transmission occasion			
	<i>n mod 4 = 0</i>	<i>n mod 4 = 1</i>	<i>n mod 4 = 2</i>	<i>n mod 4 = 3</i>
0	0	2	3	1
2	2	3	1	0
3	3	1	0	2
1	1	0	2	3

If the UE procedure for determining slot configuration as defined in Subclause 11.1 of [6, TS 38.213] determines symbol of a slot allocated for PDSCH as uplink symbols, the transmission on that slot is omitted for multi-slot PDSCH transmission.

The UE is not expected to receive a PDSCH with mapping type A in a slot, if the PDCCH scheduling the PDSCH was received in the same slot and was not contained within the first three symbols of the slot.

The UE is not expected to receive a PDSCH with mapping type B in a slot, if the first symbol of the PDCCH scheduling the PDSCH was received in a later symbol than the first symbol indicated in the PDSCH time domain resource allocation.

7.1.1.2.2.3 Test description

7.1.1.2.2.3.1 Pre-test conditions

Same Pre-test conditions as in clause 7.1.1.0 except that set to return no data in uplink and parameters as in Table 7.1.1.2.2.3.1-1.

Table 7.1.1.2.2.3.1-1: MAC Parameters

nrofHARQ-ProcessesForPDSCH	n16
----------------------------	-----

7.1.1.2.2.3.2 Test procedure sequence

Table 7.1.1.2.2.3.2-1: Main behaviour

St	Procedure	Message Sequence		TP	Verdict
		U - S	Message		
1	SS transmits in the indicated downlink assignment an NR RRCReconfiguration. (Note 1)	<--	-	-	-
2	UE transmits NR RRCReconfigurationComplete message to the SS. (Note 2)	-->	-	-	-
3	The SS transmits a downlink assignment addressed to the C-RNTI assigned to the UE, the <i>rv_idx</i> is 0.	<--	-	-	-
4	The SS transmits in the indicated downlink assignment a MAC PDU including a RLC PDU, The CRC is calculated in such a way, it will result in CRC error on UE side.	<--	MAC PDU	-	-
5	In the following 3 consecutive slots, the SS transmits on the same downlink assignment a MAC PDU including a RLC PDU, The CRC is calculated in such a way, it will result in CRC error on UE side. (Note3)	<--	MAC PDU	-	-
5A	Check: Does the UE transmit a HARQ Feedback on any of slots n_0+k_1 , n_1+k_1 , n_2+k_1 ? (Note 4)	-->	HARQ ACK/NACK	1	F
6	Check: Does the UE transmit a HARQ NACK on slot n_3+k_1 ? (Note 4)	-->	HARQ NACK	1	P
7	The SS transmits a downlink assignment addressed to the C-RNTI assigned to the UE, the <i>rv_idx</i> is 0.	<--	-	-	-
8	The SS transmits in the indicated downlink assignment a MAC PDU including a RLC PDU, The CRC is calculated in such a way, it will result in CRC pass on UE side.	<--	MAC PDU	-	-
9	In the following 3 consecutive slots, the SS transmits on the same downlink assignment a MAC PDU including a RLC PDU, The CRC is calculated in such a way, it will result in CRC pass on UE side. (Note3)	<--	MAC PDU	-	-
10	Check: Does the UE transmit a HARQ ACK on slot n_3+k_1 ? (Note 4)	-->	HARQ ACK	1	P
<p>Note 1: For EN-DC the NR RRCReconfiguration message is contained in RRCConnectionReconfiguration 36.508 [7], Table 4.6.1-8 using condition EN-DC_EmbedNR_RRCRecon.</p> <p>Note 2: For EN-DC the NR RRCReconfigurationComplete message is contained in RRCConnectionReconfigurationComplete.</p> <p>Note 3: For <i>aggregationFactorDL</i>=4, the PDSCH will repeat in following 4-1=3 slots with same resource allocation but different redundancy version, if the slot can be used for downlink transmission.</p> <p>Note 4: n_0 is the index of slot when 1st transmission of MAC PDU in step 4/8 happens, n_1, n_2, n_3 are indices of slots when 2nd, 3rd, 4th transmission of MAC PDU in step 5/9 happens, k_1 is obtained from "PDSCH-to-HARQ_feedback timing indicator" of downlink assignment in step 3/7.</p>					

7.1.1.2.2.3.3 Specific message contents

Table 7.1.1.2.2.3.3-1: RRCReconfiguration (step 1, Table 7.1.1.2.2.3.2-1)

Derivation Path: 38.508-1 [4], Table [4.6.1-13]			
Information Element	Value/remark	Comment	Condition
RRCReconfiguration ::= SEQUENCE {			
criticalExtensions CHOICE {			
rrcReconfiguration SEQUENCE {			
secondaryCellGroup	CellGroupConfig	OCTET STRING (CONTAINING CellGroupConfig)	EN-DC
}			
RRCReconfiguration-v1530-IEs ::= SEQUENCE {			NR
masterCellGroup	CellGroupConfig		
}			
}			
}			

Table 7.1.1.2.2.3.3-2: cellGroupConfig (Table 7.1.1.2.2.3.3-1: RRCReconfiguration)

Derivation Path: 38.508-1 [4], Table [4.6.3-19]			
Information Element	Value/remark	Comment	Condition
cellGroupConfig ::= SEQUENCE {			
cellGroupId	0		
	1		EN-DC
spCellConfig SEQUENCE {			
spCellConfigDedicated SEQUENCE {			
servingCellConfig SEQUENCE {			
initialDownlinkBWP SEQUENCE {			
pdsch-Config SEQUENCE {			
pdsch-AggregationFactor	n4		
}			
}			
}			
}			
}			

7.1.1.2.3 Correct HARQ process handling / CCCH

7.1.1.2.3.1 Test Purpose (TP)

(1)

```
with { UE in RRC_IDLE state with RRC connection establishment procedure initiated }
ensure that {
  when { UE receives a MAC PDU addressed to RA-RNTI }
  then { UE does not transmit the HARQ feedback for the corresponding HARQ process }
}
```

(2)

```
with { UE in RRC_IDLE state with RRC connection establishment procedure initiated }
ensure that {
  when { UE receives a MAC PDU addressed to T-CRNTI without UE Contention Resolution Identity
corresponding the transmitted RRCSetupRequest message }
  then { UE does not transmit the HARQ feedback for the corresponding HARQ process }
}
```

(3)

```
with { UE in RRC_IDLE state with RRC connection establishment procedure initiated }
```

```

ensure that {
  when { UE receives a MAC PDU addressed to T-CRNTI and cannot decode properly }
  then { UE does not transmit the HARQ feedback for the corresponding HARQ process }
}

```

(4)

```

with { UE in RRC_IDLE state with RRC connection establishment procedure initiated }
ensure that {
  when { UE receives a MAC PDU addressed to T-CRNTI with UE Contention Resolution Identity
  corresponding the transmitted RRCSetupRequest message }
  then { UE transmits the HARQ ACK for the corresponding HARQ process }
}

```

7.1.1.2.3.2 Conformance requirements

References: The conformance requirements covered in the current TC are specified in: TS 38.321, clauses 5.3.2.1 and 5.3.2.2.

[TS 38.321, clause 5.3.2.1]

The MAC entity includes a HARQ entity for each Serving Cell, which maintains a number of parallel HARQ processes. Each HARQ process is associated with a HARQ process identifier. The HARQ entity directs HARQ information and associated TBs received on the DL-SCH to the corresponding HARQ processes (see subclause 5.3.2.2).

The number of parallel DL HARQ processes per HARQ entity is specified in TS 38.214 [7]. The dedicated broadcast HARQ process is used for BCCH.

The HARQ process supports one TB when the physical layer is not configured for downlink spatial multiplexing. The HARQ process supports one or two TBs when the physical layer is configured for downlink spatial multiplexing.

When the MAC entity is configured with *pdsch-AggregationFactor* > 1, the parameter *pdsch-AggregationFactor* provides the number of transmissions of a TB within a bundle of the dynamic downlink assignment. Bundling operation relies on the HARQ entity for invoking the same HARQ process for each transmission that is part of the same bundle. After the initial transmission, *pdsch-AggregationFactor* – 1 HARQ retransmissions follow within a bundle.

The MAC entity shall:

- 1> if a downlink assignment has been indicated:
 - 2> allocate the TB(s) received from the physical layer and the associated HARQ information to the HARQ process indicated by the associated HARQ information.
- 1> if a downlink assignment has been indicated for the broadcast HARQ process:
 - 2> allocate the received TB to the broadcast HARQ process.

[TS 38.321, clause 5.3.2.2]

When a transmission takes place for the HARQ process, one or two (in case of downlink spatial multiplexing) TBs and the associated HARQ information are received from the HARQ entity.

For each received TB and associated HARQ information, the HARQ process shall:

- 1> if the NDI, when provided, has been toggled compared to the value of the previous received transmission corresponding to this TB; or
- 1> if the HARQ process is equal to the broadcast process, and this is the first received transmission for the TB according to the system information schedule indicated by RRC; or
- 1> if this is the very first received transmission for this TB (i.e. there is no previous NDI for this TB):
 - 2> consider this transmission to be a new transmission.
- 1> else:
 - 2> consider this transmission to be a retransmission.

The MAC entity then shall:

- 1> if this is a new transmission:
 - 2> attempt to decode the received data.
- 1> else if this is a retransmission:
 - 2> if the data for this TB has not yet been successfully decoded:
 - 3> instruct the physical layer to combine the received data with the data currently in the soft buffer for this TB and attempt to decode the combined data.
 - 1> if the data which the MAC entity attempted to decode was successfully decoded for this TB; or
 - 1> if the data for this TB was successfully decoded before:
 - 2> if the HARQ process is equal to the broadcast process:
 - 3> deliver the decoded MAC PDU to upper layers.
 - 2> else if this is the first successful decoding of the data for this TB:
 - 3> deliver the decoded MAC PDU to the disassembly and demultiplexing entity.
 - 1> else:
 - 2> instruct the physical layer to replace the data in the soft buffer for this TB with the data which the MAC entity attempted to decode.
 - 1> if the HARQ process is associated with a transmission indicated with a Temporary C-RNTI and the Contention Resolution is not yet successful (see subclause 5.1.5); or
 - 1> if the HARQ process is equal to the broadcast process; or
 - 1> if the *timeAlignmentTimer*, associated with the TAG containing the Serving Cell on which the HARQ feedback is to be transmitted, is stopped or expired:
 - 2> not instruct the physical layer to generate acknowledgement(s) of the data in this TB.
 - 1> else:
 - 2> instruct the physical layer to generate acknowledgement(s) of the data in this TB.

The MAC entity shall ignore NDI received in all downlink assignments on PDCCH for its Temporary C-RNTI when determining if NDI on PDCCH for its C-RNTI has been toggled compared to the value in the previous transmission.

NOTE: If the MAC entity receives a retransmission with a TB size different from the last TB size signalled for this TB, the UE behavior is left up to UE implementation.

7.1.1.2.3.3 Test description

7.1.1.2.3.3.1 Pre-test conditions

System Simulator:

- NR Cell 1.

UE:

- None

Preamble:

- The UE is in 1N-A state on NR Cell 1 using generic procedure parameter Connectivity (*NR*) according to TS 38.508-1 [4].

7.1.1.2.3.3.2 Test procedure sequence

Table 7.1.1.2.3.3.2-1: Main behaviour

St	Procedure	Message Sequence		TP	Verdict
		U - S	Message		
1	The SS transmits a Paging message including a matched identity.	<--	-	-	-
2	The UE transmits Preamble on PRACH.	-->	PRACH Preamble	-	-
3	The SS transmits Random Access Response with matching RA-RNTI and including Temporary C-RNTI. The CRC is calculated in such a way, it will result in CRC error on UE side.	<--	Random Access Response	-	-
4	Check: does the UE transmit a HARQ ACK/NACK?	-->	HARQ ACK/NACK	1	F
5	The UE transmits Preamble on PRACH.	-->	PRACH Preamble	-	-
6	The SS transmits Random Access Response with matching RA-RNTI and including Temporary C-RNTI. The CRC is calculated in such a way, it will result in CRC pass on UE side.	<--	Random Access Response	-	-
7	Check: does the UE transmit a HARQ ACK/NACK?	-->	HARQ ACK/NACK	1	F
8	The UE transmits a MAC PDU containing an <i>RRCSetupRequest</i> message.	-->	MAC PDU	-	-
9	The SS transmits a valid MAC PDU containing <i>RRCSetup</i> , and including 'UE Contention Resolution Identity' MAC control element with not matching 'Contention Resolution Identity'.	<--	MAC PDU	-	-
10	Check: does the UE transmit a HARQ ACK/NACK?	-->	HARQ ACK/NACK	2	F
11	The UE transmits Preamble on PRACH.	-->	PRACH Preamble	-	-
12	The SS transmits Random Access Response with matching RA-RNTI and including Temporary C-RNTI.	<--	Random Access Response	-	-
13	The UE transmits a MAC PDU containing an <i>RRCSetupRequest</i> message.	-->	MAC PDU	-	-
14	The SS transmits a valid MAC PDU containing <i>RRCSetup</i> , and including 'UE Contention Resolution Identity' MAC control element with matching 'Contention Resolution Identity'. The CRC is calculated in such a way that it will result in CRC error on UE side.	<--	MAC PDU	-	-
15	Check: Does UE transmit a HARQ ACK/NACK?	-->	HARQ ACK/NACK	3	F
16	The UE transmits Preamble on PRACH.	-->	PRACH Preamble	-	-
17	The SS transmits Random Access Response with matching RA-RNTI and including Temporary C-RNTI.	<--	Random Access Response	-	-
18	The UE transmits a MAC PDU containing an <i>RRCSetupRequest</i> message.	-->	MAC PDU	-	-
19	The SS transmits a valid MAC PDU containing <i>RRCSetup</i> , and including 'UE Contention Resolution Identity' MAC control element with matching 'Contention Resolution Identity'. The CRC is calculated in such a way that it will result in CRC pass on UE side.	<--	MAC PDU	-	-
20	Check: does the UE transmit a HARQ ACK?	-->	HARQ ACK	4	P
21	The UE transmits a MAC PDU containing an <i>RRCSetupComplete</i> message including SERVICE REQUEST message indicating acceptance of <i>RRCSetup</i> message	-->	MAC PDU	-	-
22-25	Steps 5 to 8 of the generic radio bearer establishment procedure (TS 38.508 table 4.5.4.2-3) are executed to successfully complete the service request procedure.	-	-	-	-

7.1.1.2.3.3.3 Specific message contents

None.

7.1.1.2.4 Correct HARQ process handling / BCCH

7.1.1.2.4.1 Test Purpose (TP)

(1)

```
with { UE in RRC_CONNECTED state }
ensure that {
  when { UE receives a MAC PDU addressed to SI-RNTI on the broadcast HARQ process }
  then { UE does not transmit the HARQ feedback for the broadcast HARQ process }
}
```

7.1.1.2.4.2 Conformance requirements

References: The conformance requirements covered in the current TC are specified in: TS 38.321, clauses 5.3.2.1 and 5.3.2.2.

[TS 38.321, clause 5.3.2.1]

The MAC entity includes a HARQ entity for each Serving Cell, which maintains a number of parallel HARQ processes. Each HARQ process is associated with a HARQ process identifier. The HARQ entity directs HARQ information and associated TBs received on the DL-SCH to the corresponding HARQ processes (see subclause 5.3.2.2).

The number of parallel DL HARQ processes per HARQ entity is specified in TS 38.214 [7]. The dedicated broadcast HARQ process is used for BCCH.

The HARQ process supports one TB when the physical layer is not configured for downlink spatial multiplexing. The HARQ process supports one or two TBs when the physical layer is configured for downlink spatial multiplexing.

When the MAC entity is configured with *pdsch-AggregationFactor* > 1, the parameter *pdsch-AggregationFactor* provides the number of transmissions of a TB within a bundle of the dynamic downlink assignment. Bundling operation relies on the HARQ entity for invoking the same HARQ process for each transmission that is part of the same bundle. After the initial transmission, *pdsch-AggregationFactor* – 1 HARQ retransmissions follow within a bundle.

The MAC entity shall:

- 1> if a downlink assignment has been indicated:
 - 2> allocate the TB(s) received from the physical layer and the associated HARQ information to the HARQ process indicated by the associated HARQ information.
- 1> if a downlink assignment has been indicated for the broadcast HARQ process:
 - 2> allocate the received TB to the broadcast HARQ process.

[TS 38.321, clause 5.3.2.2]

When a transmission takes place for the HARQ process, one or two (in case of downlink spatial multiplexing) TBs and the associated HARQ information are received from the HARQ entity.

For each received TB and associated HARQ information, the HARQ process shall:

- 1> if the NDI, when provided, has been toggled compared to the value of the previous received transmission corresponding to this TB; or
- 1> if the HARQ process is equal to the broadcast process, and this is the first received transmission for the TB according to the system information schedule indicated by RRC; or
- 1> if this is the very first received transmission for this TB (i.e. there is no previous NDI for this TB):

2> consider this transmission to be a new transmission.

1> else:

2> consider this transmission to be a retransmission.

The MAC entity then shall:

1> if this is a new transmission:

2> attempt to decode the received data.

1> else if this is a retransmission:

2> if the data for this TB has not yet been successfully decoded:

3> instruct the physical layer to combine the received data with the data currently in the soft buffer for this TB and attempt to decode the combined data.

1> if the data which the MAC entity attempted to decode was successfully decoded for this TB; or

1> if the data for this TB was successfully decoded before:

2> if the HARQ process is equal to the broadcast process:

3> deliver the decoded MAC PDU to upper layers.

2> else if this is the first successful decoding of the data for this TB:

3> deliver the decoded MAC PDU to the disassembly and demultiplexing entity.

1> else:

2> instruct the physical layer to replace the data in the soft buffer for this TB with the data which the MAC entity attempted to decode.

1> if the HARQ process is associated with a transmission indicated with a Temporary C-RNTI and the Contention Resolution is not yet successful (see subclause 5.1.5); or

1> if the HARQ process is equal to the broadcast process; or

1> if the *timeAlignmentTimer*, associated with the TAG containing the Serving Cell on which the HARQ feedback is to be transmitted, is stopped or expired:

2> not instruct the physical layer to generate acknowledgement(s) of the data in this TB.

1> else:

2> instruct the physical layer to generate acknowledgement(s) of the data in this TB.

The MAC entity shall ignore NDI received in all downlink assignments on PDCCH for its Temporary C-RNTI when determining if NDI on PDCCH for its C-RNTI has been toggled compared to the value in the previous transmission.

NOTE: If the MAC entity receives a retransmission with a TB size different from the last TB size signalled for this TB, the UE behaviour is left up to UE implementation.

7.1.1.2.4.3 Test description

7.1.1.2.4.3.1 Pre-test conditions

System Simulator:

- NR Cell 1

UE:

- None.

Preamble:

- The UE is in state 3N-A with UE test loop mode A activated as defined in 38.508-1 [4].

7.1.1.2.4.3.2 Test procedure sequence

Table 7.1.1.2.4.3.2-1: Main behaviour

St	Procedure	Message Sequence		TP	Verdict
		U - S	Message		
1	The SS transmits a Short message on PDCCH using P-RNTI indicating a systemInfoModification. (Note 1)	<--	PDCCH (DCI 1_0): Short Message	-	-
2	At the start of the modification period, the SS transmits an updated system information with SI-RNTI addressed in L1/L2 header. CRC is calculated in such a way, it will result in CRC fail on UE side. Dedicated HARQ process for broadcast is used. (Note 5)	<--	-	-	-
3	Check: Does the UE transmit a HARQ ACK/NACK? (Note 2 and 3)	-->	HARQ ACK/NACK	1	F
4	After 400ms of step 2, the SS transmits an updated system information contents same as in step 2 with SI-RNTI addressed in L1/L2 header. CRC is calculated in such a way, it will result in CRC pass on UE side. Dedicated HARQ process for broadcast is used.	<--	-	-	-
5	Check: Does the UE transmit a HARQ ACK/NACK? (Note 2 and 4)	->	HARQ ACK/NACK	1	F
6	After 100 ms of Step 4, SS is configured to not allocate UL Grants on Scheduling Request.	-	-	-	-
7	The SS transmits MAC PDU containing an RLC PDU.	<--	MAC PDU	-	-
8	The UE transmits a HARQ ACK.	-->	HARQ ACK	-	-
9	Check: Does the UE transmit PRACH Preamble, using PRACH resources as in new SI?	-->	PRACH Preamble	1	P
10	The SS transmits Random Access Response	<--	Random Access Response	-	-
11	The UE transmits a MAC PDU with C-RNTI containing loop backed RLC PDU.	-->	MAC PDU	-	-
12	SS sends PDCCH transmission for UE C-RNTI to complete contention resolution.	<--	-	-	-
<p>Note 1: The Short Message was transmitted in controlResourceSetZero as Configured in SIB1, need to guarantee that the UE will receive at least one Paging in the Modification Period preceding the SysInfo change, SS should send the Paging message in every eligible PO in this Modification Period.</p> <p>Note 2: When requested to check HARQ feedback for the dedicated broadcast HARQ process, the SS shall assume the same PUCCH reception requirement as specified in TS 38.213 section 9 for a normal HARQ process.</p> <p>Note 3: For duration of 400ms, the SS shall check HARQ ACK/NACK for all broadcast SIBs. This duration is sufficient to ensure that SS transmits few times SIBs with CRC corruption.</p> <p>Note 4: For duration of 100 ms, The SS shall check for HARQ ACK/NACK for all broadcast SIBs. This duration is sufficient to ensure that SS transmits few times SIBs after CRC corruption is removed.</p> <p>Note 5: The modification period boundaries are defined by SFN values for which $SFN \bmod m = 0$, where m is the number of radio frames comprising the modification period. Value of m is calculated based on the parameters specified in TS 38.508-1 [4] i.e $m = (\text{modificationPeriodCoeff}=4) * (\text{defaultPagingCycle}=128)$</p>					

7.1.1.2.4.3.3 Specific message contents

Table 7.1.1.2.4.3.3-1: SystemInformationBlockType1 (steps 2 and 4 of table 7.1.1.2.4.3.2-1)

Derivation path: 38.508-1 [4] table 4.6.1-28			
Information Element	Value/Remark	Comment	Condition
SIB1 ::= SEQUENCE {			
servingCellConfigCommon SEQUENCE {			
uplinkConfigCommon SEQUENCE {			
initialUplinkBWP SEQUENCE {			
rach-ConfigCommon SEQUENCE {			
prach-RootSequenceIndex CHOICE {			
I139	20		FDD
I139	2		TDD
}			
}			
}			
}			
}			
}			

7.1.1.3 Uplink Data Transfer

7.1.1.3.1 Correct Handling of UL MAC PDU / Assignment / HARQ process

7.1.1.3.1.1 Test Purpose (TP)

(1)

```
with { UE in RRC_CONNECTED state }
ensure that {
  when { UE receives for a Slot an uplink grant with valid C-RNTI }
  then { UE transmits data and associated HARQ information to the HARQ entity for this Slot }
}
```

(2)

```
with { UE in RRC_CONNECTED state }
ensure that {
  when { SS transmits for a Slot an uplink grant with not allocated C-RNTI }
  then { UE does not transmits data and associated HARQ information to the HARQ entity for this Slot }
}
```

(3)

```
with { UE in RRC_CONNECTED state }
ensure that {
  when { UE receives an UL Grant with toggled NDI and has data available for transmission }
  then { UE transmits a new MAC PDU }
}
```

(4)

```
with { UE in RRC_CONNECTED state and having transmitted a MAC PDU on a HARQ process }
ensure that {
  when { UE receives an uplink grant on PDCCH for the next Slot corresponding to the HARQ process
with old NDI not toggled}
  then { UE performs an adaptive retransmission of the MAC PDU with redundancy version as received
on PDCCH }
}
```

(5)

```
with { UE in E-UTRA RRC_CONNECTED state }
```

```

ensure that {
  when { UE receives an uplink grant on PDCCH for the next Slot corresponding to the HARQ process
with toggled NDI, and data is not available for transmission }
  then { UE transmits any MAC Padding PDU }
}

```

(6)

```

with { UE in RRC_CONNECTED state }
ensure that {
  when { UE has a MAC SDU to be transmitted that is smaller or equal to 256 bytes }
  then { UE sets F field to 0 and includes 8 bit L field in the MAC sub PDU }
}

```

(7)

```

with { UE in RRC_CONNECTED state }
ensure that {
  when { UE has a MAC SDU to be transmitted that is larger than 256 bytes }
  then { UE sets F field to 1 and includes 16 bit L field in the MAC sub PDU }
}

```

(8)

```

with { UE in E-UTRA RRC_CONNECTED state }
ensure that {
  when { UE has to insert padding in a MAC PDU }
  then { UE inserts the last MAC sub PDU as a padding sub PDU }
}

```

(9)

```

with { UE in RRC_CONNECTED state and configured with a specific TDD-UL-DL-ConfigCommon including
configuration of pattern2 }
ensure that {
  when { UE receives for a Slot an uplink grant associated with pattern2 with valid C-RNTI }
  then { UE transmits data and associated HARQ information to the HARQ entity for this Slot }
}

```

7.1.1.3.1.2 Conformance requirements

References: The conformance requirements covered in the present TC are specified in: TS 38.321, clauses 5.4.1, 5.4.2.1, 5.4.2.2 and 6.1.2. Unless otherwise stated these are Rel-15 requirements.

[TS 38.321, clause 5.4.1]

Uplink grant is either received dynamically on the PDCCH, in a Random Access Response, or configured semi-persistently by RRC. The MAC entity shall have an uplink grant to transmit on the UL-SCH. To perform the requested transmissions, the MAC layer receives HARQ information from lower layers.

If the MAC entity has a C-RNTI, a Temporary C-RNTI or CS-RNTI, the MAC entity shall for each PDCCH occasion and for each Serving Cell belonging to a TAG that has a running *timeAlignmentTimer* and for each grant received for this PDCCH occasion:

- 1> if an uplink grant for this Serving Cell has been received on the PDCCH for the MAC entity's C-RNTI or Temporary C-RNTI; or
- 1> if an uplink grant has been received in a Random Access Response:
 - 2> if the uplink grant is for MAC entity's C-RNTI and if the previous uplink grant delivered to the HARQ entity for the same HARQ process was either an uplink grant received for the MAC entity's CS-RNTI or a configured uplink grant:
 - 3> consider the NDI to have been toggled for the corresponding HARQ process regardless of the value of the NDI.
 - 2> deliver the uplink grant and the associated HARQ information to the HARQ entity.

- 1> else if an uplink grant for this PDCCH occasion has been received for this serving cell on the PDCCH for the MAC entity's CS-RNTI:
 - 2> if the NDI in the received HARQ information is 1:
 - 3> consider the NDI for the corresponding HARQ process not to have been toggled;
 - 3> stop the *ConfiguredGrantTimer* for the corresponding HARQ process, if running;
 - 3> deliver the uplink grant and the associated HARQ information to the HARQ entity.
 - 2> else if the NDI in the received HARQ information is 0:
 - 3> if PDCCH contents indicate configured grant Type 2 deactivation:
 - 4> trigger configured grant confirmation.
 - 3> else if PDCCH contents indicate configured grant Type 2 activation:
 - 4> trigger configured grant confirmation;
 - 4> store the uplink grant for this serving cell and the associated HARQ information as configured uplink grant;
 - 4> initialise or re-initialise the configured uplink grant for this serving cell to start in the associated PUSCH duration and to recur according to rules in subclause 5.8.2;
 - 4> set the HARQ Process ID to the HARQ Process ID associated with this PUSCH duration;
 - 4> consider the NDI bit for the corresponding HARQ process to have been toggled;
 - 4> stop the *ConfiguredGrantTimer* for the corresponding HARQ process, if running;
 - 4> deliver the configured uplink grant and the associated HARQ information to the HARQ entity.

For each Serving Cell and each configured uplink grant, if configured and activated, the MAC entity shall:

- 1> set the HARQ Process ID to the HARQ Process ID associated with this PUSCH duration;
- 1> if the *ConfiguredGrantTimer* for the corresponding HARQ process is not running:
 - 2> consider the NDI bit for the corresponding HARQ process to have been toggled;
 - 2> deliver the configured uplink grant and the associated HARQ information to the HARQ entity.

NOTE 1: For the same serving cell, an uplink grant addressed to C-RNTI shall override a configured uplink grant in case of overlap in time domain.

For configured uplink grants, the HARQ Process ID associated with this symbol is derived from the following equation:

$$\text{HARQ Process ID} = [\text{floor}(\text{CURRENT_symbol}/\text{periodicity})] \text{ modulo } \textit{numberOfConfGrant-Processes}$$

where $\text{CURRENT_symbol} = (\text{SFN} * \textit{numberOfSlotsPerFrame} * \textit{numberOfSymbolsPerSlot} + \text{slot number in the frame} * \textit{numberOfSymbolsPerSlot} + \text{symbol number in the slot})$, and *numberOfSlotsPerFrame* and *numberOfSymbolsPerSlot* refer to the number of consecutive slots per frame and the number of consecutive symbols per slot, respectively as specified in TS 38.211 [8].

NOTE 2: *CURRENT_symbol* refers to the symbol index of the first transmission of a repetition bundle that takes place. [TS 36.322, clause 5.4.2.1]

The MAC entity includes a HARQ entity for each Serving Cell with configured uplink (including the case when it is configured with *supplementaryUplink*), which maintains a number of parallel HARQ processes.

The number of parallel UL HARQ processes per HARQ entity is specified in TS 38.214 [7].

Each HARQ process supports one TB.

Each HARQ process is associated with a HARQ process identifier. For UL transmission with UL grant in RA Response, HARQ process identifier 0 is used.

When repetition is configured with $repK > 1$, the parameter $repK$ provides the number of repetitions of a TB within a bundle. Repetition operation relies on the HARQ entity for invoking the same HARQ process for each transmission that is part of the same bundle. Within a bundle HARQ retransmissions are non-adaptive and triggered without waiting for feedback from previous transmissions according to $repK$.

For each uplink grant, the HARQ entity shall:

- 1> identify the HARQ process(es) associated with this grant, and for each identified HARQ process:
 - 2> if the received grant was not addressed to a Temporary C-RNTI on PDCCH, and the NDI provided in the associated HARQ information has been toggled compared to the value in the previous transmission of this TB of this HARQ process; or
 - 2> if the uplink grant was received on PDCCH for the C-RNTI and the HARQ buffer of the identified process is empty; or
 - 2> if the uplink grant was received in a Random Access Response:
 - 3> if there is a MAC PDU in the Msg3 buffer and the uplink grant was received in a Random Access Response:
 - 4> obtain the MAC PDU to transmit from the Msg3 buffer.
 - 3> else:
 - 4> obtain the MAC PDU to transmit from the "Multiplexing and assembly" entity, if any;
 - 3> if a MAC PDU to transmit has been obtained:
 - 4> deliver the MAC PDU and the uplink grant and the HARQ information of the TB to the identified HARQ process;
 - 4> instruct the identified HARQ process to trigger a new transmission.
 - 4> if the uplink grant is addressed to CS-RNTI or the uplink grant is a configured uplink grant:
 - 5> start or restart the *ConfiguredGrantTimer*, if configured, for the corresponding HARQ process when the transmission is performed.
 - 2> else:
 - 3> if the uplink grant received on PDCCH was addressed to CS-RNTI and if the HARQ buffer of the identified process is empty:
 - 4> ignore the uplink grant.
 - 3> else:
 - 4> deliver the uplink grant and the HARQ information (redundancy version) of the TB to the identified HARQ process;
 - 4> instruct the identified HARQ process to trigger a retransmission;
 - 4> if the uplink grant is addressed to CS-RNTI or the uplink grant is a configured uplink grant:
 - 5> start or restart the *ConfiguredGrantTimer*, if configured, for the corresponding HARQ process when the transmission is performed.

When determining if NDI has been toggled compared to the value in the previous transmission the MAC entity shall ignore NDI received in all uplink grants on PDCCH for its Temporary C-RNTI.

[TS 38.321, clause 5.4.2.2]

Each HARQ process is associated with a HARQ buffer.

New transmissions are performed on the resource and with the MCS indicated on either PDCCH, Random Access Response, or RRC. Retransmissions are performed on the resource and, if provided, with the MCS indicated on PDCCH.

If the HARQ entity requests a new transmission for a TB, the HARQ process shall:

- 1> store the MAC PDU in the associated HARQ buffer;
- 1> store the uplink grant received from the HARQ entity;
- 1> generate a transmission as described below.

If the HARQ entity requests a retransmission for a TB, the HARQ process shall:

- 1> store the uplink grant received from the HARQ entity;
- 1> generate a transmission as described below.

To generate a transmission for a TB, the HARQ process shall:

- 1> if the MAC PDU was obtained from the Msg3 buffer; or
- 1> if there is no measurement gap at the time of the transmission and, in case of retransmission, the retransmission does not collide with a transmission for a MAC PDU obtained from the Msg3 buffer:
 - 2> instruct the physical layer to generate a transmission according to the stored uplink grant.

[TS 38.321, clause 6.1.2]

A MAC PDU consists of one or more MAC subPDUs. Each MAC subPDU consists of one of the following:

- A MAC subheader only (including padding);
- A MAC subheader and a MAC SDU;
- A MAC subheader and a MAC CE;
- A MAC subheader and padding.

The MAC SDUs are of variable sizes.

Each MAC subheader corresponds to either a MAC SDU, a MAC CE, or padding.

A MAC subheader except for fixed sized MAC CE and padding consists of the four header fields R/F/LCID/L. A MAC subheader for fixed sized MAC CE and padding consists of the two header fields R/LCID.

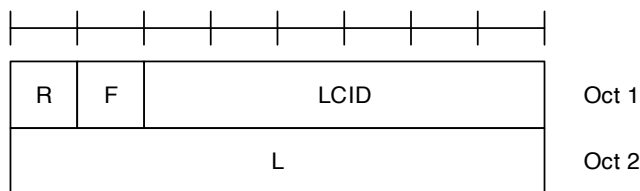

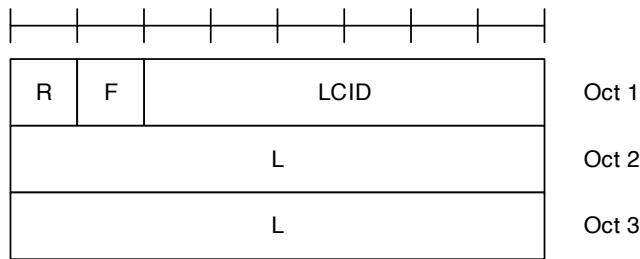

Figure 6.1.2-2: R/F/LCID/L MAC subheader with 16-bit L field

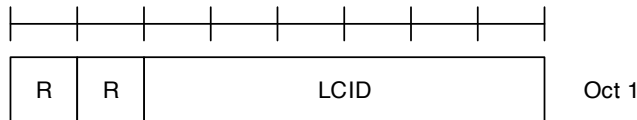

Figure 6.1.2-3: R/LCID MAC subheader

MAC CEs are placed together. DL MAC subPDU(s) with MAC CE(s) is placed before any MAC subPDU with MAC SDU and MAC subPDU with padding as depicted in Figure 6.1.2-4. UL MAC subPDU(s) with MAC CE(s) is placed after all the MAC subPDU(s) with MAC SDU and before the MAC subPDU with padding in the MAC PDU as depicted in Figure 6.1.2-5. The size of padding can be zero.

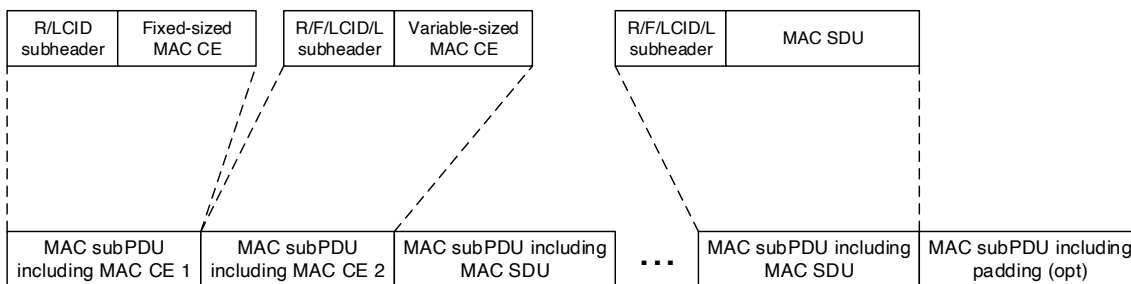

Figure 6.1.2-4: Example of a DL MAC PDU

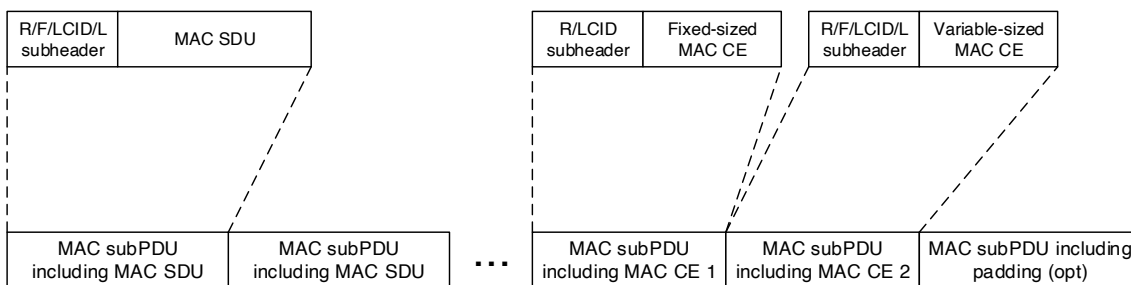

Figure 6.1.2-5: Example of a UL MAC PDU

A maximum of one MAC PDU can be transmitted per TB per MAC entity.

7.1.1.3.1.3 Test description

7.1.1.3.1.3.1 Pre-test conditions

Same Pre-test conditions as in clause 7.1.1.0.

7.1.1.3.1.3.2 Test procedure sequence

Table 7.1.1.3.1.3.2-1: Main behaviour

St	Procedure	Message Sequence		TP	Verdict
		U - S	Message		
1	The SS ignores scheduling requests and does not allocate any uplink grant.	-	-	-	-
2	SS transmits a MAC PDU including a RLC SDU	<--	MAC PDU	-	-
-	EXCEPTION: Step 3 runs in parallel with behaviour in table 7.1.1.3.1.3.2-2	-	-	-	-
3	For 100 ms SS transmits an UL Grant every 10 ms , allowing the UE to return the RLC SDU as received in step 2, on PDCCH, but with the C-RNTI different from the C-RNTI assigned to the UE.	<--	(UL Grant (unknown C-RNTI))	-	-
4	Check: Does the UE transmit a MAC PDU corresponding to grant in step 3?	-->	MAC PDU	2	F
5	SS transmits an UL Grant, allowing the UE to return the RLC SDU as received in step 2, on PDCCH with the C-RNTI assigned to the UE.	<--	(UL Grant (C-RNTI))	-	-
6	Check: Does the UE transmit a MAC PDU corresponding to grant in step 6?	-->	MAC PDU	1	P
6A	SS transmits a MAC PDU containing an RLC STATUS PDU acknowledging the reception of the AMD PDUs in step 6.	<--	MAC PDU (RLC STATUS PDU)	-	-
7	The SS Transmits a valid MAC PDU containing RLC PDU	<--	MAC PDU	-	-
8	The SS allocates an UL Grant for one HARQ process X, sufficient for one RLC SDU to be looped back in a Slot, and NDI indicates new transmission redundancy version to be used as 0	<--	Uplink Grant	-	-
9	Check: Does the UE transmit a MAC PDU including one RLC SDU, in HARQ process X?	-->	MAC PDU	3	P
10	The SS transmits an UL grant corresponding to slot for HARQ process X, with NDI not toggled and redundancy version to be used as 1	<--	Uplink Grant	-	-
11	Check: Does the UE retransmit the MAC PDU in for HARQ process X, using redundancy version1?	-->	MAC PDU	4	P
11A	SS transmits a MAC PDU containing an RLC STATUS PDU acknowledging the reception of the AMD PDUs in step 11.	<--	MAC PDU (RLC STATUS PDU)	-	-
12	The SS transmits an UL grant corresponding to SLOT for HARQ process X, with NDI toggled and redundancy version to be used as 0	<--	Uplink Grant	-	-
13	Check: Does the UE retransmit the MAC PDU containing padding for HARQ process X, using redundancy version 0?	-->	MAC PDU	5	P
14	SS transmits a MAC PDU including a RLC PDU of size 128 bytes	<--	MAC PDU	-	-
15	The SS transmits an UL Grant, allowing the UE to return the RLC SDU as received in step 14 and padding.	<--	(UL Grant (C-RNTI))	-	-
16	Check: Does the UE transmit a MAC PDU corresponding to grant in step 14 with F field set to 0 and includes 8 bit L field in the MAC sub PDU and includes a padding sub PDU at end?	-->	MAC PDU	6,8	P
16A	SS transmits a MAC PDU containing an RLC STATUS PDU acknowledging the reception of the AMD PDUs in step 16.	<--	MAC PDU (RLC STATUS PDU)	-	-
17	SS transmits a MAC PDU including a RLC	<--	MAC PDU	-	-

	PDU of size 512 bytes				
18	The SS transmits an UL Grant, allowing the UE to return the RLC SDU as received in step 17 and padding.	<--	(UL Grant (C-RNTI))	-	-
19	Check: Does the UE transmit a MAC PDU corresponding to grant in step 17 with F field set to 1 and includes 16 bit L field in the MAC sub PDU and includes a padding sub PDU at end?	-->	MAC PDU	7,8	P
19A	SS transmits a MAC PDU containing an RLC STATUS PDU acknowledging the reception of the AMD PDUs in step 19.	<--	MAC PDU (RLC STATUS PDU)	-	-
-	EXCEPTION : Steps 20a0 to 20a6 are executed for operation on NR TDD band only	-	-	-	-
20a0	The SS transmits an updated system information as specified in Table 7.1.1.3.1.3.3-14.				
20a1	The SS transmits a NR RRCReconfiguration message including <i>TDD-UL-DL-ConfigCommon</i> with <i>pattern1</i> and <i>pattern 2</i> specified in Table 7.1.1.3.1.3.3-5 (Note 1)	<--	<i>RRCReconfiguration</i>	-	-
20a2	The UE transmit a NR <i>RRCReconfigurationComplete</i> message. (Note 2)	-->	<i>RRCReconfigurationComplete</i>	-	-
20a3	SS transmits a MAC PDU including a RLC SDU	<--	MAC PDU	-	-
20a4	SS transmits an UL Grant, allowing the UE to return the RLC SDU as received in step 20a3, on PDCCH with the C-RNTI assigned to the UE.	<--	(UL Grant (C-RNTI))	-	-
20a5	Check: Does the UE transmit a MAC PDU corresponding to grant in step 20a4?	-->	MAC PDU	9	P
20a6	SS transmits a MAC PDU containing an RLC STATUS PDU acknowledging the reception of the AMD PDUs in step 20a5.	<--	MAC PDU (RLC STATUS PDU)	-	-
Note 1: For EN-DC the NR RRCReconfiguration message is contained in RRCConnectionReconfiguration 36.508 [7], Table 4.6.1-8 using condition EN-DC_EmbedNR_RRCRecon.					
Note 2: For EN-DC the NR RRCReconfigurationComplete message is contained in RRCConnectionReconfigurationComplete.					

Table 7.1.1.3.1.3.2-2: Parallel behaviour

St	Procedure	Message Sequence		TP	Verdict
		U - S	Message		
1	UE transmits a Scheduling Request.	-->	(SR)	-	-

7.1.1.3.1.3.3 Specific message contents

Table 7.1.1.3.1.3.3-1: Void**Table 7.1.1.3.1.3.3-2: Void****Table 7.1.1.3.1.3.3-3: RRCReconfiguration (step20a1, Table 7.1.1.3.1.3.2-1)**

Derivation Path: 38.508-1 [4], Table 4.6.1-13			
Information Element	Value/remark	Comment	Condition
RRCReconfiguration ::= SEQUENCE {			
criticalExtensions CHOICE {			
rrcReconfiguration ::= SEQUENCE {			
secondaryCellGroup	CellGroupConfig		EN-DC
}			
RRCReconfiguration-v1530-IEs ::= SEQUENCE {			NR
masterCellGroup	CellGroupConfig		
}			
}			
}			

Table 7.1.1.3.1.3.3-4: CellGroupConfig (Table 7.1.1.3.1.3.3-3)

Derivation Path: TS 38.508-1 [4], Table 4.6.3-19			
Information Element	Value/remark	Comment	Condition
CellGroupConfig ::= SEQUENCE {			
spCellConfig SEQUENCE {			
reconfigurationWithSync SEQUENCE {			
spCellConfigCommon	ServingCellConfigCommon		
}			
spCellConfigDedicated	ServingCellConfig		
}			
}			

Table 7.1.1.3.1.3.3-5: ServingCellConfigCommon (Table 7.1.1.3.1.3.3-4, Table 7.1.1.3.1.3.3-14)

Derivation Path: TS 38.508-1 [4], Table 4.6.3-168			
Information Element	Value/remark	Comment	Condition
ServingCellConfigCommon ::= SEQUENCE {			
uplinkConfigCommon SEQUENCE {			
initialUplinkBWP	BWP-UplinkCommon		
}			
tdd-UL-DL-ConfigurationCommon	TDD-UL-DL-ConfigCommon		
}			

Table 7.1.1.3.1.3.3-6: TDD-UL-DL-ConfigCommon (Table 7.1.1.3.1.3.3-5)

Derivation Path: TS 38.508-1 [4], Table 4.6.3-192			
Information Element	Value/remark	Comment	Condition
TDD-UL-DL-ConfigCommon ::= SEQUENCE {			
referenceSubcarrierSpacing	SubcarrierSpacing		
pattern1 SEQUENCE {			
dl-UL-TransmissionPeriodicity	ms5		FR1
	ms0p625		FR2
nrofDownlinkSlots	3		FR1
	2		FR2
nrofDownlinkSymbols	6		FR1
	6		FR2
nrofUplinkSlots	2		FR1
	2		FR2
nrofUplinkSymbols	4		FR1
	2		FR2
dl-UL-TransmissionPeriodicity-v1530	ms3		FR1
}			
pattern2 SEQUENCE {			
dl-UL-TransmissionPeriodicity	ms2		FR1
	ms0p625		FR2
nrofDownlinkSlots	4		FR1
	3		FR2
nrofDownlinkSymbols	0		FR1
	6		FR2
nrofUplinkSlots	0		FR1
	1		FR2
nrofUplinkSymbols	0		FR1
	2		FR2
}			
}			

Table 7.1.1.3.1.3.3-7: BWP-UplinkCommon (Table 7.1.1.3.1.3.3-5)

Derivation Path: TS 38.508-1 [4], Table 4.6.3-14			
Information Element	Value/remark	Comment	Condition
BWP-UplinkCommon ::= SEQUENCE {			
rach-ConfigCommon CHOICE {			
setup	RACH-ConfigCommon		
}			
}			

Table 7.1.1.3.1.3.3-8: RACH-ConfigCommon (Table 7.1.1.3.1.3.3-7)

Derivation Path: TS 38.508-1 [4], Table 4.6.3-128			
Information Element	Value/remark	Comment	Condition
RACH-ConfigCommon ::= SEQUENCE {			
rach-ConfigGeneric	RACH-ConfigGeneric		
}			

Table 7.1.1.3.1.3.3-9: RACH-ConfigGeneric (Table 7.1.1.3.1.3.3-8)

Derivation Path: TS 38.508-1 [4], Table 4.6.3-130			
Information Element	Value/remark	Comment	Condition
RACH-ConfigGeneric ::= SEQUENCE {			
prach-configurationIndex	156		
}			

Table 7.1.1.3.1.3.3-10: *ServingCellConfig* (Table 7.1.1.3.1.3.3-4)

Derivation Path: TS 38.508-1 [4], Table 4.6.3-167			
Information Element	Value/remark	Comment	Condition
ServingCellConfig ::= SEQUENCE {			
uplinkConfig SEQUENCE {			
initialUplinkBWP	BWP-UplinkDedicated		
}			
}			

Table 7.1.1.3.1.3.3-11: *BWP-UplinkDedicated* (Table 7.1.1.3.1.3.3-10)

Derivation Path: TS 38.508-1 [4], Table 4.6.3-15			
Information Element	Value/remark	Comment	Condition
BWP-UplinkDedicated ::= SEQUENCE {			
pucch-Config CHOICE {			
setup	PUCCH-Config		
}			
}			

Table 7.1.1.3.1.3.3-12: *PUCCH-Config* (Table 7.1.1.3.1.3.3-11)

Derivation Path: TS 38.508-1 [4], Table 4.6.3-112			
Information Element	Value/remark	Comment	Condition
PUCCH-Config ::= SEQUENCE {			
schedulingRequestResourceToAddModList	1 entry		
SEQUENCE (SIZE (1..maxNrofSR-Resources)) OF			
SchedulingRequestResourceConfig {			
SchedulingRequestResourceConfig[1]	SchedulingRequestResourceConfig	entry 1	
}			
}			

Table 7.1.1.3.1.3.3-13: *SchedulingRequestResourceConfig* (Table 7.1.1.3.1.3.3-12)

Derivation Path: TS 38.508-1 [4], Table 4.6.3-112			
Information Element	Value/remark	Comment	Condition
SchedulingRequestResourceConfig ::= SEQUENCE {			
periodicityAndOffset CHOICE {			
sl10	5	With SCS = kHz15 results in repetition every 10 ms	SCS_15kHz
sl20	5	With SCS = kHz30 results in repetition every 10 ms	SCS_30kHz
sl80	4	With SCS = kHz120 results in repetition every 10 ms	SCS_120kHz
}			
}			

Table 7.1.1.3.1.3.3-14: SystemInformationBlockType1 (step 20a0, Table 7.1.1.3.1.3.2-1)

Derivation path: 38.508-1 [4] table 4.6.1-28			
Information Element	Value/Remark	Comment	Condition
SIB1 ::= SEQUENCE {			
servingCellConfigCommon	ServingCellConfigCommon	Same contents as in Table 7.1.1.3.1.3.3-5	
}			

7.1.1.3.2 Logical channel prioritization handling

7.1.1.3.2.1 Test Purpose (TP)

(1)

```
with {UE in RRC_CONNECTED state}
ensure that {
  when { UE is sending data on the uplink }
  then { UE serves the logical channels according to their priority and configured PBR }
}
```

7.1.1.3.1.2 Conformance requirements

References: The conformance requirements covered in the present TC are specified in: TS 38.321, clause 5.4.3.1.1, 5.4.3.1.2, 5.4.3.1.3. Unless otherwise stated these are Rel-15 requirements.

[TS 38.321, clause 5.4.3.1.1]

The Logical Channel Prioritization procedure is applied whenever a new transmission is performed.

RRC controls the scheduling of uplink data by signalling for each logical channel per MAC entity:

- *priority* where an increasing priority value indicates a lower priority level;
- *prioritisedBitRate* which sets the Prioritized Bit Rate (PBR);
- *bucketSizeDuration* which sets the Bucket Size Duration (BSD).

RRC additionally controls the LCP procedure by configuring mapping restrictions for each logical channel:

- *allowedSCS-List* which sets the allowed Subcarrier Spacing(s) for transmission;
- *maxPUSCH-Duration* which sets the maximum PUSCH duration allowed for transmission;
- *configuredGrantType1Allowed* which sets whether a Configured Grant Type 1 can be used for transmission;
- *allowedServingCells* which sets the allowed cell(s) for transmission.

The following UE variable is used for the Logical channel prioritization procedure:

- B_j which is maintained for each logical channel j .

The MAC entity shall initialize B_j of the logical channel to zero when the logical channel is established.

For each logical channel j , the MAC entity shall:

- 1> increment B_j by the product $PBR \times T$ before every instance of the LCP procedure, where T is the time elapsed since B_j was last updated;
- 1> if the value of B_j is greater than the bucket size (i.e. $PBR \times BSD$):
 - 2> set B_j to the bucket size.

NOTE: The exact moment(s) when the UE updates B_j between LCP procedures is up to UE implementation, as long as B_j is up to date at the time when a grant is processed by LCP.

[TS 38.321, clause 5.4.3.1.2]

The MAC entity shall, when a new transmission is performed:

- 1> select the logical channels for each UL grant that satisfy all the following conditions:
 - 2> the set of allowed Subcarrier Spacing index values in *allowedSCS-List*, if configured, includes the Subcarrier Spacing index associated to the UL grant; and
 - 2> *maxPUSCH-Duration*, if configured, is larger than or equal to the PUSCH transmission duration associated to the UL grant; and
 - 2> *configuredGrantType1Allowed*, if configured, is set to TRUE in case the UL grant is a Configured Grant Type 1; and
 - 2> *allowedServingCells*, if configured, includes the Cell information associated to the UL grant.

NOTE: The Subcarrier Spacing index, PUSCH transmission duration and Cell information are included in Uplink transmission information received from lower layers for the corresponding scheduled uplink transmission.

[TS 38.321, clause 5.4.3.1.3]

The MAC entity shall, when a new transmission is performed:

- 1> allocate resources to the logical channels as follows:
 - 2> logical channels selected in subclause 5.4.3.1.2 for the UL grant with $B_j > 0$ are allocated resources in a decreasing priority order. If the PBR of a logical channel is set to "infinity", the MAC entity shall allocate resources for all the data that is available for transmission on the logical channel before meeting the PBR of the lower priority logical channel(s);
 - 2> decrement B_j by the total size of MAC SDUs served to logical channel j above;

NOTE: The value of B_j can be negative.

- 2> if any resources remain, all the logical channels selected in subclause 5.4.3.1.2 are served in a strict decreasing priority order (regardless of the value of B_j) until either the data for that logical channel or the UL grant is exhausted, whichever comes first. Logical channels configured with equal priority should be served equally.

The UE shall also follow the rules below during the scheduling procedures above:

- the UE should not segment an RLC SDU (or partially transmitted SDU or retransmitted RLC PDU) if the whole SDU (or partially transmitted SDU or retransmitted RLC PDU) fits into the remaining resources of the associated MAC entity;
- if the UE segments an RLC SDU from the logical channel, it shall maximize the size of the segment to fill the grant of the associated MAC entity as much as possible;
- the UE should maximise the transmission of data;
- if the MAC entity is given an UL grant size that is equal to or larger than 8 bytes while having data available for transmission, the MAC entity shall not transmit only padding BSR and/or padding.

The MAC entity shall not generate a MAC PDU for the HARQ entity if the following conditions are satisfied:

- the MAC entity is configured with *skipUplinkTxDynamic* and the grant indicated to the HARQ entity was addressed to a C-RNTI, or the grant indicated to the HARQ entity is a configured uplink grant; and
- the MAC PDU includes zero MAC SDUs; and
- the MAC PDU includes only the periodic BSR and there is no data available for any LCG, or the MAC PDU includes only the padding BSR.

Logical channels shall be prioritised in accordance with the following order (highest priority listed first):

- MAC CE for C-RNTI or data from UL-CCCH;

- MAC CE for SPS confirmation;
- MAC CE for BSR, with exception of BSR included for padding;
- MAC CE for single entry PHR or multiple entry PHR;
- data from any Logical Channel, except data from UL-CCCH;
- MAC CE for BSR included for padding.

7.1.1.3.2.3 Test description

7.1.1.3.2.3.1 Pre-test conditions

Same Pre-test conditions as in clause 7.1.1.0 with the exception of 3 UM SN terminated SCG bearers configured according to Table 7.1.1.3.2.3.1-1.

Table 7.1.1.3.2.3.1-1: Priority, PBR and Bucket Delay settings

DRB	priority	prioritizedBitRate (kbytes/s)	bucketSizeDuration (ms)
DRB1	6	8	100
DRB2	7	16	100
DRB3	8	32	100

Table 7.1.1.3.2.3.1-2: PDCP Settings

Parameter	Value
Discard_Timer	ms1500

7.1.1.3.2.3.2 Test procedure sequence

Table 7.1.1.3.2.3.2-1: Main behaviour

St	Procedure	Message Sequence		TP	Verdict
		U - S	Message		
-	EXCEPTION: Steps 1 to 3 are run 4 times using the parameters specified for each run in table 7.1.1.3.2.3.2-3.	-	-	-	-
1	The SS transmits N1 320-octet RLC SDUs on DRB1, N2 320-octet RLC SDUs on DRB2, and N3 320-octet RLC SDUs on DRB3.	<-	(RLC SDUs)	-	-
-	EXCEPTION: In parallel to the event described in step 2 the events specified in Table 7.1.1.3.2.3.2-2 shall take place.	-	-	-	-
2	The SS is configured for Uplink Grant Allocation Type 2 as defined in TS 38.523-3 [3]. 150 ms after Step 1 (Note1), for a duration of T2, the SS transmits an UL grant of D octets every T1.	<-	(UL grants)	-	-
3	Check: Are the total number of octets of the UL RLC SDUs received at the SS for each DRB as follows: - total number of octets received for DRB1 is D1 octets +/- 10% - total number of octets received for DRB2 is D2 octets +/- 10% - total number of octets received for DRB3 is D3 octets +/- 10% ?	-	-	1	P
Note 1: This wait time will ensure that a) all octets have been completely received by the UE on all 3 DRBs before the first UL grant is received and b) the Bj's for each logical channel have reached their maximum value i.e. the bucket size of the corresponding logical channel before the first UL grant is received.					

Table 7.1.1.3.2.3.2-2: Parallel behaviour

St	Procedure	Message Sequence		TP	Verdict
		U - S	Message		
1	Check: Does the UE transmit the RLC SDUs back to the SS?	-->	-	1	P

Table 7.1.1.3.2.3.2-3: Test parameter values

Parameter	First run	Second run	Third run	Fourth run
N1 (SDUs)	13	13	7	104
N2 (SDUs)	25	25	50	25
N3 (SDUs)	50	50	50	50
D (octets)	1153	576	1153	1153
T1 (ms)	20	20	20	10
T2 (ms)	500	700	500	500
D1 (octets)	4160	4160	2240	33350 (Note 1)
D2 (octets)	8000	8000	10435 (Note 1)	8000
D3 (octets)	16000	7790 (Note 1)	16000	16000
Note 1: Calculated using the following equation for the case of the least header size: (D1 + D2 + D3) = (D - 6) * T2 / T1				

NOTE: The Test parameter values above and the test procedure assume that the UE has a loopback buffer of at least 57280 octets.

7.1.1.3.2.3.3 Specific message contents

Table 7.1.1.3.2.3.3-1: SchedulingRequest-Config (Preamble)

Derivation Path: 38.508-1 [4], Table 4.6.3-155			
Information Element	Value/remark	Comment	Condition
sr-TransMax	n64		

7.1.1.3.2b Logical channel prioritization handling with Mapping restrictions

7.1.1.3.2b.1 Test Purpose (TP)

(1)

```
with {UE in RRC_CONNECTED state with allowedSCS-List configured }
ensure that {
  when { UE is sending data on the uplink }
  then { UE serves the logical channels according to their priority and configured PBR and
respecting allowedSCS-List }
}
```

(2)

```
with {UE in RRC_CONNECTED state with maxPUSCH-Duration configured }
ensure that {
  when { UE is sending data on the uplink }
  then { UE serves the logical channels according to their priority and configured PBR and
respecting maxPUSCH-Duration }
}
```

(3)

```
with { UE in RRC_CONNECTED state with configuredGrantType1Allowed configured }
ensure that {
  when { UE is sending data on the uplink }
  then { UE serves the logical channels according to their priority and configured PBR and
respecting configuredGrantType1Allowed }
}
```

7.1.1.3.2b.2 Conformance requirements

References: The conformance requirements covered in the present TC are specified in: TS 38.321, clause 5.4.3.1.1, 5.4.3.1.2, 5.4.3.1.3. Unless otherwise stated these are Rel-15 requirements.

[TS 38.321, clause 5.4.3.1.1]

The Logical Channel Prioritization (LCP) procedure is applied whenever a new transmission is performed.

RRC controls the scheduling of uplink data by signalling for each logical channel per MAC entity:

- *priority* where an increasing priority value indicates a lower priority level;
- *prioritisedBitRate* which sets the Prioritized Bit Rate (PBR);
- *bucketSizeDuration* which sets the Bucket Size Duration (BSD).

RRC additionally controls the LCP procedure by configuring mapping restrictions for each logical channel:

- *allowedSCS-List* which sets the allowed Subcarrier Spacing(s) for transmission;
- *maxPUSCH-Duration* which sets the maximum PUSCH duration allowed for transmission;
- *configuredGrantType1Allowed* which sets whether a configured grant Type 1 can be used for transmission;
- *allowedServingCells* which sets the allowed cell(s) for transmission.

The following UE variable is used for the Logical channel prioritization procedure:

- B_j which is maintained for each logical channel j .

The MAC entity shall initialize B_j of the logical channel to zero when the logical channel is established.

For each logical channel j , the MAC entity shall:

- 1> increment B_j by the product $PBR \times T$ before every instance of the LCP procedure, where T is the time elapsed since B_j was last incremented;
- 1> if the value of B_j is greater than the bucket size (i.e. $PBR \times BSD$):
 - 2> set B_j to the bucket size.

NOTE: The exact moment(s) when the UE updates B_j between LCP procedures is up to UE implementation, as long as B_j is up to date at the time when a grant is processed by LCP.

[TS 38.321, clause 5.4.3.1.2]

The MAC entity shall, when a new transmission is performed:

- 1> select the logical channels for each UL grant that satisfy all the following conditions:
 - 2> the set of allowed Subcarrier Spacing index values in *allowedSCS-List*, if configured, includes the Subcarrier Spacing index associated to the UL grant; and
 - 2> *maxPUSCH-Duration*, if configured, is larger than or equal to the PUSCH transmission duration associated to the UL grant; and
 - 2> *configuredGrantType1Allowed*, if configured, is set to *true* in case the UL grant is a Configured Grant Type 1; and
 - 2> *allowedServingCells*, if configured, includes the Cell information associated to the UL grant. Does not apply to logical channels associated with a DRB configured with PDCP duplication within the same MAC entity (i.e. CA duplication) for which PDCP duplication is deactivated.

NOTE: The Subcarrier Spacing index, PUSCH transmission duration and Cell information are included in Uplink transmission information received from lower layers for the corresponding scheduled uplink transmission.

[TS 38.321, clause 5.4.3.1.3]

The MAC entity shall, when a new transmission is performed:

- 1> allocate resources to the logical channels as follows:
 - 2> logical channels selected in subclause 5.4.3.1.2 for the UL grant with $B_j > 0$ are allocated resources in a decreasing priority order. If the PBR of a logical channel is set to *infinity*, the MAC entity shall allocate resources for all the data that is available for transmission on the logical channel before meeting the PBR of the lower priority logical channel(s);
 - 2> decrement B_j by the total size of MAC SDUs served to logical channel j above;
 - 2> if any resources remain, all the logical channels selected in subclause 5.4.3.1.2 are served in a strict decreasing priority order (regardless of the value of B_j) until either the data for that logical channel or the UL grant is exhausted, whichever comes first. Logical channels configured with equal priority should be served equally.

NOTE: The value of B_j can be negative.

If the MAC entity is requested to simultaneously transmit multiple MAC PDUs, or if the MAC entity receives the multiple UL grants within one or more coinciding PDCCH occasions (i.e. on different Serving Cells), it is up to UE implementation in which order the grants are processed.

The UE shall also follow the rules below during the scheduling procedures above:

- the UE should not segment an RLC SDU (or partially transmitted SDU or retransmitted RLC PDU) if the whole SDU (or partially transmitted SDU or retransmitted RLC PDU) fits into the remaining resources of the associated MAC entity;
- if the UE segments an RLC SDU from the logical channel, it shall maximize the size of the segment to fill the grant of the associated MAC entity as much as possible;
- the UE should maximise the transmission of data;
- if the MAC entity is given a UL grant size that is equal to or larger than 8 bytes while having data available and allowed (according to subclause 5.4.3.1) for transmission, the MAC entity shall not transmit only padding BSR and/or padding.

The MAC entity shall not generate a MAC PDU for the HARQ entity if the following conditions are satisfied:

- the MAC entity is configured with *skipUplinkTxDynamic* with value *true* and the grant indicated to the HARQ entity was addressed to a C-RNTI, or the grant indicated to the HARQ entity is a configured uplink grant; and
- there is no aperiodic CSI requested for this PUSCH transmission as specified in TS 38.212 [9]; and
- the MAC PDU includes zero MAC SDUs; and
- the MAC PDU includes only the periodic BSR and there is no data available for any LCG, or the MAC PDU includes only the padding BSR.

Logical channels shall be prioritised in accordance with the following order (highest priority listed first):

- C-RNTI MAC CE or data from UL-CCCH;
- Configured Grant Confirmation MAC CE;
- MAC CE for BSR, with exception of BSR included for padding;
- Single Entry PHR MAC CE or Multiple Entry PHR MAC CE;
- data from any Logical Channel, except data from UL-CCCH;
- MAC CE for Recommended bit rate query;
- MAC CE for BSR included for padding.

7.1.1.3.2b.3 Test description

7.1.1.3.2b.3.1 Pre-test conditions

Same Pre-test conditions as in clause 7.1.1.0 with the exception of 3 UM NR DRBs configured according to Table 7.1.1.3.2b.3.1-1.

Table 7.1.1.3.2b.3.1-1: Priority, PBR, Bucket Delay allowed-SCSList settings

DRB	priority	prioritizedBitRate (kbytes/s)	bucketSize Duration (ms)	allowed-SCSList	
				FR1	FR2
DRB1	6	8	100	{15KHz, 30KHz}	{60KHz, 120KHz}
DRB2	7	16	100	{60KHz}	{60KHz}
DRB3	8	32	100	{15KHz, 30KHz,60KH z}	{120KHz}

Table 7.1.1.3.2b.3.1-2: allowed-SCSList and maxPUSCH-Duration settings

DRB	allowed-SCSList	maxPUSCH- Duration
DRB1	Not Present	ms0p02
DRB2	Not Present	ms0p5
DRB3	Not Present	ms0p5

Table 7.1.1.3.2b.3.1-2a: PUSCH-TimeDomainResourceAllocationList

Derivation Path: TS 38.508-1 [4], table 4.6.3-122				
Information Element	Value/remark	Comment	Condition	
PUSCH-TimeDomainResourceAllocationList ::= SEQUENCE (SIZE(1..maxNrofUL-Allocations)) OF PUSCH-TimeDomainResourceAllocation {	2 entry			
PUSCH-TimeDomainResourceAllocation[1] SEQUENCE {		entry 1		
k2	2		FR1	
	4		FR2	
mappingType	typeA			
startSymbolAndLength	27	Start symbol(S)=0, Length(L)=14		
}				
PUSCH-TimeDomainResourceAllocation[2] SEQUENCE {		entry 2		
k2	2		FR1	
	4		FR2	
mappingType	typeA			
startSymbolAndLength	52	Start symbol(S)=10, Length(L)=4	FR1	
startSymbolAndLength	42	Start symbol(S)=0, Length(L)=4	FR2	
}				
}				

Table 7.1.1.3.2b.3.1-3: maxPUSCH-Duration and configuredGrantType1Allowed settings

DRB	maxPUSCH-Duration	configuredGrantType1Allowed
DRB1	Not Present	true
DRB2	Not Present	false
DRB3	Not Present	true

Table 7.1.1.3.2b.3.1-4: PDCP Settings

Parameter	Value
Discard_Timer	ms1500

7.1.1.3.2b.3.2 Test procedure sequence

Table 7.1.1.3.2b.3.2-1: Main behaviour

St	Procedure	Message Sequence		TP	Verdict
		U - S	Message		
-	EXCEPTION: Steps 1 to 3 are run using the parameters specified for first run in table 7.1.1.3.2b.3.2-3.	-	-	-	-
1	The SS transmits N1 320-octet RLC SDUs on DRB1, N2 320-octet RLC SDUs on DRB2, and N3 320-octet RLC SDUs on DRB3.	<--	(RLC SDUs)	-	-
-	EXCEPTION: In parallel to the event described in step 2 the events specified in Table 7.1.1.3.2b.3.2-2 shall take place.	-	-	-	-
2	The SS is configured for Uplink Grant Allocation Type 2 as defined in TS 38.523-3 [3]. 150 ms after Step 1 (Note1), for a duration of T2, the SS transmits an UL grant of D octets every T1.	<--	(UL grants)	-	-
3	Check: Are the total number of octets of the UL RLC SDUs received at the SS for each DRB as follows: - total number of octets received for DRB1 is D1 octets +/- 10% - total number of octets received for DRB2 is 0 - total number of octets received for DRB3 is D3 octets +/- 10% otherwise?	-	-	1	P
4	SS transmits NR <i>RRCReconfiguration</i> message to configure allowed-SCSList and maxPUSCH-Duration as per Table 7.1.1.3.2b.3.1-2. (Note 2)	<--	(NR RRC: <i>RRCReconfiguration</i>)	-	-
-	EXCEPTION: In parallel to the event described in step 5 the events specified in Table 7.1.1.3.2b.3.2-2a shall take place on DRB2	-	-	-	-
5	The UE transmits NR <i>RRCReconfigurationComplete</i> message. (Note 3)	-->	(NR RRC: <i>RRCReconfigurationComplete</i>)	-	-
-	EXCEPTION: Steps 6 to 8 are run using the parameters specified for second run in table 7.1.1.3.2b.3.1-2.	-	-	-	-
6	The SS transmits N1 160-octet RLC SDUs on DRB1, N2 160-octet RLC SDUs on DRB2, and N3 160-octet RLC SDUs on DRB3.	<--	(RLC SDUs)	-	-
-	EXCEPTION: In parallel to the event described in step 7 the events specified in Table 7.1.1.3.2b.3.2-2 shall take place.	-	-	-	-
7	The SS is configured for Uplink Grant Allocation Type 2 as defined in TS 38.523-3 [3]. 150 ms after Step 1 (Note1), for a duration of T2, the SS transmits an UL grant of D octets every T1.	<--	(UL grants)	-	-
8	Check: Are the total number of octets of the UL RLC SDUs received at the SS for each DRB as follows: - total number of octets received for DRB1 are 0 - total number of octets received for DRB2 are D2 octets +/- 10% - total number of octets received for DRB3 are D3 octets +/- 10%?	-	-	2	P
9	SS transmits NR <i>RRCReconfiguration</i> message to configure UL configured grant type 1 with UL grant configured 150 ms after Step 11 (Note1), for a duration of T2 and an UL grant of D octets every T1. It also configures maxPUSCH-Duration and	<--	(NR RRC: <i>RRCReconfiguration</i>)	-	-

	configuredGrantType1Allowed as per Table 7.1.1.3.2b.3.1-3 (Note 2)				
-	EXCEPTION: In parallel to the event described in step 10 the events specified in Table 7.1.1.3.2b.3.2-2a shall take place on DRB1	-	-	-	-
10	The UE transmits NR <i>RRCReconfigurationComplete</i> message. (Note 3)	-->	(NR RRC: <i>RRCReconfigurationComplete</i>)	-	-
-	EXCEPTION: Steps 11 to 13 are run using the parameters specified for third run in table 7.1.1.3.2b.3.1-1.	-	-	-	-
11	The SS transmits N1 320-octet RLC SDUs on DRB1, N2 320-octet RLC SDUs on DRB2, and N3 320-octet RLC SDUs on DRB3.	<--	(RLC SDUs)	-	-
-	EXCEPTION: In parallel to the event described in step 9 the events specified in Table 7.1.1.3.2b.3.2-2 shall take place.	-	-	-	-
12	Check: Are the total number of octets of the UL RLC SDUs received at the SS for each DRB as follows: - total number of octets received for DRB1 are D1 octets +/- 10% - total number of octets received for DRB2 are 0 - total number of octets received for DRB3 are D3 octets +/- 10%?	-	-	3	P
13	The SS sends one Uplink Grant to send loop back PDU on DRB 2.	<--	(UL grants)	-	-
14	The UE transmits the RLC SDU back to the SS.	-->	-	-	-
<p>Note 1: This wait time will ensure that a) all octets have been completely received by the UE on all 3 DRBs before the first UL grant is received and b) the Bj's for each logical channel have reached their maximum value i.e. the bucket size of the corresponding logical channel before the first UL grant is received.</p> <p>Note 2: For EN-DC the NR <i>RRCReconfiguration</i> message is contained in <i>RRCConnectionReconfiguration</i> 36.508 [7], Table 4.6.1-8 using condition EN-DC_EmbedNR_RRCRecon.</p> <p>Note 3: For EN-DC the NR <i>RRCReconfigurationComplete</i> message is contained in <i>RRCConnectionReconfigurationComplete</i></p>					

Table 7.1.1.3.2b.3.2-2: Parallel behaviour

St	Procedure	Message Sequence		TP	Verdict
		U – S	Message		
1	Check: Does the UE transmit the RLC SDUs back to the SS?	-->	-	1,2,3	P

Table 7.1.1.3.2b.3.2-2a: Parallel behaviour

St	Procedure	Message Sequence		TP	Verdict
		U – S	Message		
1	The UE may transmit the RLC SDU back to the SS within one second.	-->	-	-	-

Table 7.1.1.3.2b.3.2-3: Test parameter values

Parameter	First run	Second run	Third run
N1 (SDUs)	13	1	13
N2 (SDUs)	1	25	1
N3 (SDUs)	50	50	50
D (octets)	1153	576	1153
T1 (ms)	20	20	20
T2 (ms)	360	420	360
D1 (octets)	4160	0	4160
D2 (octets)	0	4000	0
D3 (octets)	16000	8000	16000
Note 1: Calculated using the following equation for the case of the least header size: $(D1 + D2 + D3) = (D - 6) * T2 / T1$.			

7.1.1.3.2b.3.3 Specific message contents

Table 7.1.1.3.2b.3.3-1: SchedulingRequest-Config (Preamble)

Derivation Path: 36.508 [7], Table 4.6.3-20			
Information Element	Value/remark	Comment	Condition
sr-TransMax	n64		

Table 7.1.1.3.2b.3.3-2: RRCReconfiguration (step 9, Table 7.1.1.3.2b.3.2-1)

Derivation path: 38.508-1 [4], Table 4.6.1-13			
Information Element	Value/remark	Comment	Condition
RRCReconfiguration ::= SEQUENCE {			
criticalExtensions CHOICE {			
rrcReconfiguration SEQUENCE {			
radioBearerConfig	Not present		
secondaryCellGroup	CellGroupConfig	OCTET STRING (CONTAINING CellGroupConfig)	EN-DC
nonCriticalExtension := SEQUENCE {}	Not present		EN-DC
nonCriticalExtension := SEQUENCE{			NR
masterCellGroup	CellGroupConfig	OCTET STRING (CONTAINING CellGroupConfig)	
dedicatedNAS-MessageList SEQUENCE (SIZE(1..maxDRB)) OF DedicatedNAS-Message {}	Not present		
}			
}			
}			
}			

Table 7.1.1.3.2b.3.3-3: *CellGroupConfig* (Table 7.1.1.3.2b.3.3-2: *RRCReconfiguration*)

Derivation path: 38.508-1 [4], Table 4.6.3-19			
Information Element	Value/remark	Comment	Condition
CellGroupConfig ::= SEQUENCE {			
rlc-BearerToAddModList	Not present		
mac-CellGroupConfig	Not present		
physicalCellGroupConfig SEQUENCE {			
cs-RNTI CHOICE {			
setup SEQUENCE{			
RNTI-Value	'FFE0'H		
}			
}			
}			
spCellConfig SEQUENCE{			
servCellIndex	Not present		NR
	1		EN-DC
reconfigurationWithSync	Not present		
spCellConfigDedicated SEQUENCE{			
uplinkConfig SEQUENCE {			
initialUplinkBWP SEQUENCE {			
pucch-Config CHOICE {			
setup SEQUENCE {			
schedulingRequestResourceToAddModList {			
schedulingRequestResourceId	1		
schedulingRequestID	0		
periodicityAndOffset CHOICE {			
sl20	10		
}			
}			
}			
configuredGrantConfig CHOICE {			
setup SEQUENCE {			
cg-DMRS-Configuration	DMRS-UplinkConfig	Reference TS 38.508-1[4], Table 4.6.3-51	
}			
uci-OnPUSCH CHOICE {			
setup SEQUENCE {			
semiStatic SEQUENCE {	BetaOffsets		
betaOffsetACK-Index1	9		
betaOffsetACK-Index2	9		
betaOffsetACK-Index3	9		
betaOffsetCSI-Part1-Index1	6		
betaOffsetCSI-Part1-Index2	6		
betaOffsetCSI-Part2-Index1	6		
betaOffsetCSI-Part2-Index2	6		
}			
}			
}			
resourceAllocation	ResourceAllocationType 1		
powerControlLoopToUse	n0		
p0-PUSCH-Alpha	1		
nrofHARQ-Processes	16		
repK	n1		
periodicity	Sym20x14		15kHz
periodicity	Sym40x14		30kHz
periodicity	Sym80x14		60kHz
periodicity	Sym160x14		120kHz
rrc-ConfiguredUplinkGrant SEQUENCE{			
timeDomainOffset	0		
timeDomainAllocation	0	Reference TS 38.508-1 [4], Table 4.6.3-122	
}			
}			
frequencyDomainAllocation	BIT STRING (SIZE(18))	BIT STRING	

		(SIZE(18), Equal to NBWPsize * (LRB-1) + RBstart), where LRB = 23 PRB, RBstart = 0, NBWPsize is the size [PRBs] of the active carrier bandwidth part and obtained in TS.38.508-1 [4] clause 4.3.1.1.	
antennaPort	0		
precodingAndNumberOfLayers	0		
srs-ResourceIndicator	Not present		
mcsAndTBS	16		
pathlossReferenceIndex	0		
}			
}			
}			

7.1.1.3.3 Correct handling of MAC control information / Scheduling requests

7.1.1.3.3.1 Test Purpose (TP)

(1)

```
with { UE in RRC_CONNECTED state with SR resource on PUCCH is configured }
ensure that {
  when { UE has UL data available for transmission and UE has no UL-SCH resources available and
SR_COUNTER is less than sr-TransMax }
  then { the UE transmits a SR on every available PUCCH until resources are granted }
}
```

(2)

```
with { UE in RRC_CONNECTED state with SR resource on PUCCH is configured }
ensure that {
  when { UE receives an UL grant for a new transmission }
  then { UE cancels all pending SR(s) }
}
```

(3)

```
with { UE in RRC_CONNECTED state with SR resource on PUCCH is configured }
ensure that {
  when { UE has UL data available for transmission and UE has no UL-SCH resources available and
SR_COUNTER becomes equal to sr-TransMax }
  then { the UE transmits a PRACH Preamble to initiate a Random Access procedure }
}
```

(4)

```
with { UE in RRC_CONNECTED state with SR resource on PUCCH is configured and logicalChannelSR-
DelayTimer is configured }
ensure that {
  when { UE has UL data available for transmission on LCH for which logicalChannelSR-DelayTimer is
configured and UE has no UL-SCH resources available and SR_COUNTER is less than sr-TransMax }
  then { the UE delays transmission of SR until logicalChannelSR-DelayTimer expires }
}
```

(5)

```
with { UE in RRC_CONNECTED state with SR resource on PUCCH is configured }
ensure that {
```

```

when { UE has UL data available for transmission on LCH for which logicalChannelSR-DelayTimer is
not configured and UE has no UL-SCH resources available and SR_COUNTER is less than sr-TransMax }
  then { the UE transmits a SR on every available PUCCH until resources are granted }
}

```

7.1.1.3.3.2 Conformance requirements

References: The conformance requirements covered in the present TC are specified in: TS 38.321, clauses 5.4.4 and 5.4.5. Unless otherwise stated these are Rel-15 requirements.

[TS 38.321, clause 5.4.4]

The Scheduling Request (SR) is used for requesting UL-SCH resources for new transmission.

The MAC entity may be configured with zero, one, or more SR configurations. An SR configuration consists of a set of PUCCH resources for SR across different BWPs and cells. For a logical channel, at most one PUCCH resource for SR is configured per BWP.

Each SR configuration corresponds to one or more logical channels. Each logical channel may be mapped to zero or one SR configuration, which is configured by RRC. The SR configuration of the LCH that triggered the BSR (subclause 5.4.5) (if such a configuration exists) is considered as corresponding SR configuration for the triggered SR. For BSR triggered by *retxBSR-Timer* expiry, the corresponding SR configuration for the triggered SR is that of the highest priority LCH (if such a configuration exists) that has data available for transmission at the time the BSR is triggered.

RRC configures the following parameters for the scheduling request procedure:

- *sr-ProhibitTimer* (per SR configuration);
- *sr-TransMax* (per SR configuration);
- *sr-ConfigIndex*.

The following UE variables are used for the scheduling request procedure:

- *SR_COUNTER* (per SR configuration).

If an SR is triggered and there are no other SRs pending corresponding to the same SR configuration, the MAC entity shall set the *SR_COUNTER* of the corresponding SR configuration to 0.

When an SR is triggered, it shall be considered as pending until it is cancelled. All pending SR(s) shall be cancelled and each respective *sr-ProhibitTimer* shall be stopped when a MAC PDU is assembled and this PDU includes a BSR which contains buffer status up to (and including) the last event that triggered a BSR (see subclause 5.4.5), or when the UL grant(s) can accommodate all pending data available for transmission.

Only PUCCH resources on a BWP which is active at the time of SR transmission occasion are considered valid.

As long as at least one SR is pending, the MAC entity shall for each pending SR:

- 1> if the MAC entity has no valid PUCCH resource configured for the pending SR:
 - 2> initiate a Random Access procedure (see subclause 5.1) on the SpCell and cancel the pending SR.
- 1> else, for the SR configuration corresponding to the pending SR:
 - 2> when the MAC entity has an SR transmission occasion on the valid PUCCH resource for SR configured; and
 - 2> if *sr-ProhibitTimer* is not running at the time of the SR transmission occasion; and
 - 2> if the PUCCH resource for the SR transmission occasion does not overlap with a measurement gap; and
 - 2> if the PUCCH resource for the SR transmission occasion does not overlap with a UL-SCH resource:
 - 3> if *SR_COUNTER* < *sr-TransMax*:
 - 4> increment *SR_COUNTER* by 1;
 - 4> instruct the physical layer to signal the SR on one valid PUCCH resource for SR;

4> start the *sr-ProhibitTimer*.

3> else:

4> notify RRC to release PUCCH for all serving cells;

4> notify RRC to release SRS for all serving cells;

4> clear any configured downlink assignments and uplink grants;

4> initiate a Random Access procedure (see subclause 5.1) on the SpCell and cancel all pending SRs.

NOTE: The selection of which valid PUCCH resource for SR to signal SR on when the MAC entity has more than one overlapping valid PUCCH resource for the SR transmission occasion is left to UE implementation.

[TS 38.321, clause 5.4.5]

For Regular BSR, the MAC entity shall:

1> if the BSR is triggered for a logical channel for which *logicalChannelSR-Delay* is configured by upper layers:

2> start or restart the *logicalChannelSR-DelayTimer*.

1> else:

2> if running, stop the *logicalChannelSR-DelayTimer*.

...

The MAC entity shall:

1> if the Buffer Status reporting procedure determines that at least one BSR has been triggered and not cancelled:

2> if UL-SCH resources are available for a new immediate transmission:

3> instruct the Multiplexing and Assembly procedure to generate the BSR MAC CE(s);

3> start or restart *periodicBSR-Timer* except when all the generated BSRs are long or short Truncated BSRs;

3> start or restart *retxBSR-Timer*.

2> else if a Regular BSR has been triggered and *logicalChannelSR-DelayTimer* is not running:

3> if an uplink grant is not a configured grant; or

3> if the Regular BSR was not triggered for a logical channel for which logical channel SR masking (*logicalChannelSR-Mask*) is setup by upper layers:

4> trigger a Scheduling Request.

7.1.1.3.3.3 Test description

7.1.1.3.3.3.1 Pre-test conditions

Same Pre-test conditions as in clause 7.1.1.0 with the exception of 2 AM DRBs configured according to Table 7.1.1.3.3.1-1 and Table 7.1.1.3.3.1-2.

Table 7.1.1.3.3.1-1: Logical Channel Configuration Settings

Parameter	DRB1	DRB2
LogicalChannelIdentity	LCH4(DRB-Identity +3)	LCH5(DRB-Identity +3)
Priority	7	6
prioritizedBitRate	0kbs	0kbs
logicalChannelGroup	2 (LCG ID#2)	1 (LCG ID#1)
logicalChannelSR-DelayTimerApplied	False	True
logicalChannelSR-DelayTimer	Not Present	sf512

Table 7.1.1.3.3.1-2: RLC parameters

<i>t-PollRetransmit</i>	ms80
-------------------------	------

7.1.1.3.3.3.2 Test procedure sequence

Table 7.1.1.3.3.3.2-1: Main behaviour

St	Procedure	Message Sequence		TP	Verdict
		U - S	Message		
1	The SS transmits a MAC PDU containing A MAC Sub PDU containing a RLC SDU on LCH 5	<--	MAC PDU (containing 1 MAC sub PDU)	-	-
2	Check: Does the UE transmit Scheduling Requests for logicalChannelSR-DelayTimer (sf512) from step 1?	-->	(SR)	4	F
3	Check: Does the UE transmit [x] Scheduling Requests separately on [x] consecutively available PUCCHs after logicalChannelSR-DelayTimer expiry? (Note 1)	-->	(SR)	1,4	P
4	The SS transmits an UL grant to allocate UL-SCH resources that are enough to transmit looped back PDU	<--	(UL Grant)	-	-
5	Check: Does the UE transmit a MAC PDU containing MAC Sub PDU containing a RLC SDU on LCH5?	-->	MAC PDU (containing 1 MAC sub PDU containing RLC SDU)	1	P
6	The SS transmits a MAC PDU containing A MAC Sub PDU containing a RLC SDU on LCH 4	<--	MAC PDU (containing 1 MAC sub PDU)	-	-
7	Check: Does the UE transmit Scheduling Requests separately on [x] consecutively available PUCCHs? (Note 1)	-->	(SR)	1,5	P
8	The SS transmits an UL grant to allocate UL-SCH resources that are enough to transmit looped back PDU	<--	(UL Grant)	-	-
9	Check: Does the UE transmit a MAC PDU containing MAC Sub PDU containing a RLC SDU on LCH4?	-->	MAC PDU (containing 1 MAC sub PDU containing RLC SDU)	1	P
10	Check: For 1 second, does the UE transmit a Scheduling Request?	-->	(SR)	1,2	F
11	The SS transmits a MAC PDU containing a Timing Advance Command MAC Control Element, but does not send any subsequent alignments.	<--	MAC PDU (Timing Advance Command)	-	-
12	The SS transmits a MAC PDU containing a MAC SDU on LCH 4	<--	MAC PDU (MAC SDU)	-	-
-	EXCEPTION: Step 13 is repeated less than sr-TransMax times	-	-	-	-
13	The UE may transmit Scheduling Requests before time alignment timer expires. The SS shall not respond to the Scheduling Requests in this step. (Note 2)	-->	(SR)	-	-
14	Check: does the UE transmit a preamble on PRACH?	-->	(PRACH Preamble)	3	P
15	The SS transmits a Random Access Response including an UL grant to enable UE to transmit C-RNTI MAC Control Element and the MAC SDU as received in step 14.	<--	Random Access Response	-	-
16	The UE transmit a MAC PDU including a C-RNTI MAC Control Element and a MAC SDU. (Note 3)	-->	MAC PDU (MAC Sub PDU containing C-RNTI control element, MAC sub PDU containing MAC SDU)	-	-
17	The SS sends PDCCH transmission for UE C-RNTI	<--	-	-	-
<p>Note 1: The UE repeats the scheduling requests on every available PUCCH as long as SR_COUNTER < dsr-TransMax and there is UL data available for transmission and there are no resources available to transmit it. At the reception of first Scheduling Request from the UE, SS will be scheduled to transmit a grant after 100ms. Hence SS will receive 10 Scheduling Requests.</p> <p>Note 2: In step 8, SR repetition of [63] times (sr-TransMax (64)) will take at least [63*10 = 630] ms which is smaller than TA timer [infinity].</p> <p>Note 3: The UE transmission of the MAC PDU ensures that the random access procedure was successful.</p>					

7.1.1.3.3.3 Specific message contents

Table 7.1.1.3.3.3-1: SchedulingRequestConfig (Preamble)

Derivation Path: TS 38.508-1 [4], Table 4.6.3-155			
Information Element	Value/remark	Comment	Condition
SchedulingRequestConfig ::= SEQUENCE { schedulingRequestToAddModList (SIZE(1..maxNrofSR-ConfigPerCellGroup)) OF SSchedulingRequestToAddMod {	1 entry		
SchedulingRequestToAddMod[1] SEQUENCE {		entry 1	
sr-TransMax	n64	MAX Value	
}			
}			

7.1.1.3.4 Correct handling of MAC control information / Buffer status / UL data arrive in the UE Tx buffer / Regular BSR

7.1.1.3.4.1 Test Purpose (TP)

(1)

```
with { UE in RRC_CONNECTED state }
ensure that {
  when { UL data arrives in the UE transmission buffer and the data belongs to a logical channel
with higher priority than those for which data is already available for transmission and the new
logical channel and the existing logical channels belongs to the different LCG }
  then { UE Reports a Long Buffer Status Reporting (BSR) }
}
```

(2)

```
with { UE in RRC_CONNECTED state }
ensure that {
  when { UL data arrives in the UE transmission buffer and there is no data available for
transmission for any of the logical channels which belong to a LCG }
  then { UE Reports a Short Buffer Status Reporting (BSR) }
}
```

(3)

```
with { UE in RRC_CONNECTED state }
ensure that {
  when { UL data arrives in the UE transmission buffer and the data belongs to a logical channel
with higher priority than those for which data is already available for transmission and the new
logical channel and existing logical channels belong to the same LCG }
  then { UE Reports a Short Buffer Status Reporting (BSR) }
}
```

(4)

```
with { UE in RRC_CONNECTED state }
ensure that {
  when { retxBSR-Timer expires and only one LCG has data available for transmission }
  then { UE triggers a regular BSR and Reports a Short Buffer Status Reporting (BSR) }
}
```

(5)

```
with { UE in RRC_CONNECTED state }
ensure that {
  when { a Regular BSR has been triggered and UE has pending data for transmission and UE has only
resources to send either BSR report or data }
  then { UE transmits the BSR report }
}
```

}

(6)

```

with { UE in E-UTRA RRC_CONNECTED state }
ensure that {
  when { UE determines that a BSR has been triggered since the last transmission of a BSR and UE has
no UL resources allocated for new transmission for this TTI }
  then { UE transmits a scheduling request }
}

```

(7)

Void.

(8)

```

with { UE in RRC_CONNECTED state }
ensure that {
  when { a Regular BSR has been triggered and UE has pending data on several logical channels for
transmission and UE has UL resources to send all pending data including BSR }
  then { UE transmits the UL data and reports buffer status reporting (BSR) that indicates there
is no more data in the buffer }
}

```

7.1.1.3.4.2 Conformance requirements

References: The conformance requirements covered in the present TC are specified in: TS 38.321, clauses 5.4.5, 6.1.3.1, 6.2.1 and TS 38.323 clause 5.6. Unless otherwise stated these are Rel-15 requirements.

[TS 38.321, clause 5.4.3.1.3]

Logical channels shall be prioritised in accordance with the following order (highest priority listed first):

- C-RNTI MAC CE or data from UL-CCCH;
- Configured Grant Confirmation MAC CE;
- MAC CE for BSR, with exception of BSR included for padding;
- Single Entry PHR MAC CE or Multiple Entry PHR MAC CE;
- data from any Logical Channel, except data from UL-CCCH;
- MAC CE for Recommended bit rate query;
- MAC CE for BSR included for padding.

[TS 38.321, clause 5.4.5]

The Buffer Status reporting (BSR) procedure is used to provide the serving gNB with information about UL data volume in the MAC entity.

RRC configures the following parameters to control the BSR:

- *periodicBSR-Timer*;
- *retxBSR-Timer*;
- *logicalChannelSR-Delay*;
- *logicalChannelSR-DelayTimer*;
- *logicalChannelGroup*.

Each logical channel may be allocated to an LCG using the *logicalChannelGroup*. The maximum number of LCGs is eight.

The MAC entity determines the amount of UL data available for a logical channel according to the data volume calculation procedure in TSs 38.322 and 38.323 [3] [4].

A BSR shall be triggered if any of the following events occur:

- the MAC entity has new UL data available for a logical channel which belongs to an LCG; and either
 - the new UL data belongs to a logical channel with higher priority than the priority of any logical channel containing available UL data which belong to any LCG; or
 - none of the logical channels which belong to an LCG contains any available UL data.

in which case the BSR is referred below to as 'Regular BSR';

- UL resources are allocated and number of padding bits is equal to or larger than the size of the Buffer Status Report MAC CE plus its subheader, in which case the BSR is referred below to as 'Padding BSR';
- *retxBSR-Timer* expires, and at least one of the logical channels which belong to an LCG contains UL data, in which case the BSR is referred below to as 'Regular BSR';
- *periodicBSR-Timer* expires, in which case the BSR is referred below to as 'Periodic BSR'.

For Regular BSR, the MAC entity shall:

- 1> if the BSR is triggered for a logical channel for which *logicalChannelSR-Delay* is configured by upper layers:
 - 2> start or restart the *logicalChannelSR-DelayTimer*.
- 1> else:
 - 2> if running, stop the *logicalChannelSR-DelayTimer*.

For Regular and Periodic BSR, the MAC entity shall:

- 1> if more than one LCG has data available for transmission when the BSR is to be transmitted:
 - 2> report Long BSR for all LCGs which have data available for transmission.
- 1> else:
 - 2> report Short BSR.

For Padding BSR:

- 1> if the number of padding bits is equal to or larger than the size of the Short BSR plus its subheader but smaller than the size of the Long BSR plus its subheader:
 - 2> if more than one LCG has data available for transmission when the BSR is to be transmitted:
 - 3> if the number of padding bits is equal to the size of the Short BSR plus its subheader:
 - 4> report Short Truncated BSR of the LCG with the highest priority logical channel with data available for transmission.
 - 3> else:
 - 4> report Long Truncated BSR of the LCG(s) with the logical channels having data available for transmission following a decreasing order of priority, and in case of equal priority, in increasing order of LCGID.
 - 2> else:
 - 3> report Short BSR;
- 1> else if the number of padding bits is equal to or larger than the size of the Long BSR plus its subheader:
 - 2> report Long BSR for all LCGs which have data available for transmission.

The MAC entity shall:

- 1> if the Buffer Status reporting procedure determines that at least one BSR has been triggered and not cancelled:
 - 2> if UL-SCH resources are available for a new immediate transmission:
 - 3> instruct the Multiplexing and Assembly procedure to generate the BSR MAC CE(s);
 - 3> start or restart *periodicBSR-Timer* except when all the generated BSRs are long or short Truncated BSRs;
 - 3> start or restart *retxBSR-Timer*.
 - 2> else if a Regular BSR has been triggered and *logicalChannelSR-DelayTimer* is not running:
 - 3> if an uplink grant is not a configured grant; or
 - 3> if the Regular BSR was not triggered for a logical channel for which logical channel SR masking (*logicalChannelSR-Mask*) is setup by upper layers:
 - 4> trigger a Scheduling Request.

A MAC PDU shall contain at most one BSR MAC CE, even when multiple events have triggered a BSR by the time. The Regular BSR and the Periodic BSR shall have precedence over the padding BSR.

The MAC entity shall restart *retxBSR-Timer* upon reception of a grant for transmission of new data on any UL-SCH.

All triggered BSRs may be cancelled when the UL grant(s) can accommodate all pending data available for transmission but is not sufficient to additionally accommodate the BSR MAC control element plus its subheader. All triggered BSRs shall be cancelled when a BSR is included in a MAC PDU for transmission.

The MAC entity shall transmit at most one BSR in one MAC PDU. Padding BSR shall not be included when the MAC PDU contains a Regular or Periodic BSR.

[TS 38.321, clause 6.1.3.1]

Buffer Status Report (BSR) MAC CEs consist of either:

- Short BSR format (fixed size); or
- Long BSR format (variable size); or
- Short Truncated BSR format (fixed size); or
- Long Truncated BSR format (variable size).

The BSR formats are identified by MAC PDU subheaders with LCIDs as specified in Table 6.2.1-2.

The fields in the BSR MAC CE are defined as follows:

- LCG ID: The Logical Channel Group ID field identifies the group of logical channel(s) whose buffer status is being reported. The length of the field is 3 bits;
- LCG_i: For the Long BSR format, this field indicates the presence of the Buffer Size field for the logical channel group *i*. The LCG_i field set to "1" indicates that the Buffer Size field for the logical channel group *i* is reported. The LCG_i field set to "0" indicates that the Buffer Size field for the logical channel group *i* is not reported. For the Long Truncated BSR format, this field indicates whether logical channel group *i* has data available. The LCG_i field set to "1" indicates that logical channel group *i* has data available. The LCG_i field set to "0" indicates that logical channel group *i* does not have data available;
- Buffer Size: The Buffer Size field identifies the total amount of data available according to the data volume calculation procedure in TSs 38.322 and 38.323 [3] [4] across all logical channels of a logical channel group after the MAC PDU has been built (i.e. after the logical channel prioritization procedure, which may result the value of the Buffer Size field to zero). The amount of data is indicated in number of bytes. The size of the RLC and MAC headers are not considered in the buffer size computation. The length of this field for the Short BSR format and the Short Truncated BSR format is 5 bits. The length of this field for the Long BSR format and the Long Truncated BSR format is 8 bits. The values for the 5-bit and 8-bit Buffer Size fields are shown in Tables 6.1.3.1-1 and 6.1.3.1-2, respectively. For the Long BSR format and the Long Truncated BSR format, the Buffer

Size fields are included in ascending order based on the LCG_i. For the Long Truncated BSR format the number of Buffer Size fields included is maximised, while not exceeding the number of padding bits.

NOTE: The number of the Buffer Size fields in the Long Truncated BSR format can be zero.

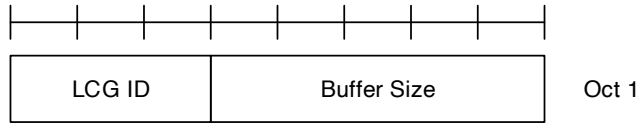

Figure 6.1.3.1-1: Short BSR and Short Truncated BSR MAC CE

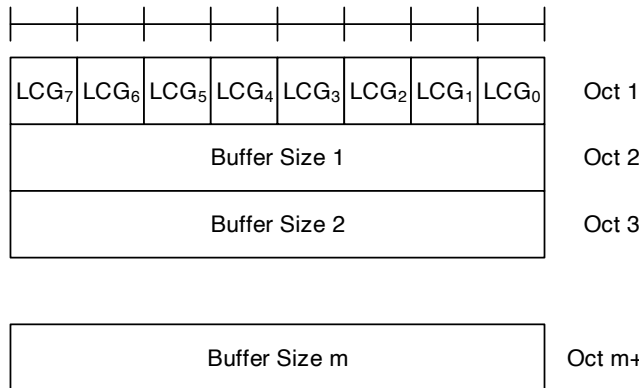

Figure 6.1.3.1-2: Long BSR and Long Truncated BSR MAC CE

Table 6.1.3.1-1: Buffer size levels (in bytes) for 5-bit Buffer Size field

Index	BS value	Index	BS value	Index	BS value	Index	BS value
0	0	8	≤ 102	16	≤ 1446	24	≤ 20516
1	≤ 10	9	≤ 142	17	≤ 2014	25	≤ 28581
2	≤ 14	10	≤ 198	18	≤ 2806	26	≤ 39818
3	≤ 20	11	≤ 276	19	≤ 3909	27	≤ 55474
4	≤ 28	12	≤ 384	20	≤ 5446	28	≤ 77284
5	≤ 38	13	≤ 535	21	≤ 7587	29	≤ 107669
6	≤ 53	14	≤ 745	22	≤ 10570	30	≤ 150000
7	≤ 74	15	≤ 1038	23	≤ 14726	31	> 150000

Table 6.1.3.1-2: Buffer size levels (in bytes) for 8-bit Buffer Size field

Index	BS value	Index	BS value	Index	BS value	Index	BS value
0	0	64	≤ 560	128	≤ 31342	192	≤ 1754595
1	≤ 10	65	≤ 597	129	≤ 33376	193	≤ 1868488
2	≤ 11	66	≤ 635	130	≤ 35543	194	≤ 1989774
3	≤ 12	67	≤ 677	131	≤ 37850	195	≤ 2118933
4	≤ 13	68	≤ 720	132	≤ 40307	196	≤ 2256475
5	≤ 14	69	≤ 767	133	≤ 42923	197	≤ 2402946
6	≤ 15	70	≤ 817	134	≤ 45709	198	≤ 2558924
7	≤ 16	71	≤ 870	135	≤ 48676	199	≤ 2725027
8	≤ 17	72	≤ 926	136	≤ 51836	200	≤ 2901912
9	≤ 18	73	≤ 987	137	≤ 55200	201	≤ 3090279
10	≤ 19	74	≤ 1051	138	≤ 58784	202	≤ 3290873
11	≤ 20	75	≤ 1119	139	≤ 62599	203	≤ 3504487
12	≤ 22	76	≤ 1191	140	≤ 66663	204	≤ 3731968
13	≤ 23	77	≤ 1269	141	≤ 70990	205	≤ 3974215
14	≤ 25	78	≤ 1351	142	≤ 75598	206	≤ 4232186
15	≤ 26	79	≤ 1439	143	≤ 80505	207	≤ 4506902
16	≤ 28	80	≤ 1532	144	≤ 85730	208	≤ 4799451
17	≤ 30	81	≤ 1631	145	≤ 91295	209	≤ 5110989
18	≤ 32	82	≤ 1737	146	≤ 97221	210	≤ 5442750
19	≤ 34	83	≤ 1850	147	≤ 103532	211	≤ 5796046
20	≤ 36	84	≤ 1970	148	≤ 110252	212	≤ 6172275
21	≤ 38	85	≤ 2098	149	≤ 117409	213	≤ 6572925
22	≤ 40	86	≤ 2234	150	≤ 125030	214	≤ 6999582
23	≤ 43	87	≤ 2379	151	≤ 133146	215	≤ 7453933
24	≤ 46	88	≤ 2533	152	≤ 141789	216	≤ 7937777
25	≤ 49	89	≤ 2698	153	≤ 150992	217	≤ 8453028
26	≤ 52	90	≤ 2873	154	≤ 160793	218	≤ 9001725
27	≤ 55	91	≤ 3059	155	≤ 171231	219	≤ 9586039
28	≤ 59	92	≤ 3258	156	≤ 182345	220	≤ 10208280
29	≤ 62	93	≤ 3469	157	≤ 194182	221	≤ 10870913
30	≤ 66	94	≤ 3694	158	≤ 206786	222	≤ 11576557
31	≤ 71	95	≤ 3934	159	≤ 220209	223	≤ 12328006
32	≤ 75	96	≤ 4189	160	≤ 234503	224	≤ 13128233
33	≤ 80	97	≤ 4461	161	≤ 249725	225	≤ 13980403
34	≤ 85	98	≤ 4751	162	≤ 265935	226	≤ 14887889
35	≤ 91	99	≤ 5059	163	≤ 283197	227	≤ 15854280
36	≤ 97	100	≤ 5387	164	≤ 301579	228	≤ 16883401
37	≤ 103	101	≤ 5737	165	≤ 321155	229	≤ 17979324
38	≤ 110	102	≤ 6109	166	≤ 342002	230	≤ 19146385
39	≤ 117	103	≤ 6506	167	≤ 364202	231	≤ 20389201
40	≤ 124	104	≤ 6928	168	≤ 387842	232	≤ 21712690
41	≤ 132	105	≤ 7378	169	≤ 413018	233	≤ 23122088
42	≤ 141	106	≤ 7857	170	≤ 439827	234	≤ 24622972
43	≤ 150	107	≤ 8367	171	≤ 468377	235	≤ 26221280
44	≤ 160	108	≤ 8910	172	≤ 498780	236	≤ 27923336
45	≤ 170	109	≤ 9488	173	≤ 531156	237	≤ 29735875
46	≤ 181	110	≤ 10104	174	≤ 565634	238	≤ 31666069
47	≤ 193	111	≤ 10760	175	≤ 602350	239	≤ 33721553
48	≤ 205	112	≤ 11458	176	≤ 641449	240	≤ 35910462
49	≤ 218	113	≤ 12202	177	≤ 683087	241	≤ 38241455
50	≤ 233	114	≤ 12994	178	≤ 727427	242	≤ 40723756
51	≤ 248	115	≤ 13838	179	≤ 774645	243	≤ 43367187
52	≤ 264	116	≤ 14736	180	≤ 824928	244	≤ 46182206
53	≤ 281	117	≤ 15692	181	≤ 878475	245	≤ 49179951
54	≤ 299	118	≤ 16711	182	≤ 935498	246	≤ 52372284
55	≤ 318	119	≤ 17795	183	≤ 996222	247	≤ 55771835
56	≤ 339	120	≤ 18951	184	≤ 1060888	248	≤ 59392055
57	≤ 361	121	≤ 20181	185	≤ 1129752	249	≤ 63247269
58	≤ 384	122	≤ 21491	186	≤ 1203085	250	≤ 67352729
59	≤ 409	123	≤ 22885	187	≤ 1281179	251	≤ 71724679
60	≤ 436	124	≤ 24371	188	≤ 1364342	252	≤ 76380419
61	≤ 464	125	≤ 25953	189	≤ 1452903	253	≤ 81338368

62	≤ 494	126	≤ 27638	190	≤ 1547213	254	> 81338368
63	≤ 526	127	≤ 29431	191	≤ 1647644	255	Reserved

[TS 38.321, clause 6.2.1]

Table 6.2.1-2 Values of LCID for UL-SCH

Index	LCID values
000000	CCCH
000001–100000	Identity of the logical channel
100001–110110	Reserved
110111	Configured Grant Confirmation
111000	Multiple Entry PHR
111001	Single Entry PHR
111010	C-RNTI
111011	Short Truncated BSR
111100	Long Truncated BSR
111101	Short BSR
111110	Long BSR
111111	Padding

[TS 38.323, clause 5.6]

For the purpose of MAC buffer status reporting, the transmitting PDCP entity shall consider the following as PDCP data volume:

- the PDCP SDUs for which no PDCP Data PDUs have been constructed;
- the PDCP Data PDUs that have not been submitted to lower layers;
- the PDCP Control PDUs;
- for AM DRBs, the PDCP SDUs to be retransmitted according to subclause 5.1.2;
- for AM DRBs, the PDCP Data PDUs to be retransmitted according to subclause 5.5.

[TS 38.322, clause 5.5] For the purpose of MAC buffer status reporting, the UE shall consider the following as RLC data volume:

- RLC SDUs and RLC SDU segments that have not yet been included in an RLC data PDU;
- RLC data PDUs that are pending for initial transmission;
- RLC data PDUs that are pending for retransmission (RLC AM).

In addition, if a STATUS PDU has been triggered and *t-StatusProhibit* is not running or has expired, the UE shall estimate the size of the STATUS PDU that will be transmitted in the next transmission opportunity, and consider this as part of RLC data volume.

7.1.1.3.4.3 Test description

7.1.1.3.4.3.1 Pre-test conditions

Same Pre-test conditions as in clause 7.1.1.0 with the exception of 3 AM DRBs on NR cell configured according to Table 7.1.1.3.4.3.1-1.

Table 7.1.1.3.4.3.1-1: Logical Channel Configuration Settings

Parameter	Value DRB1	Value DRB2	Value DRB3
LogicalChannelIdentity	LCH4((DRB-Identity +3)	LCH5(DRB-Identity +3)	LCH6(DRB-Identity +3)
Priority	8	7	6
prioritizedBitRate	0 kB/s	0 kB/s	0 kB/s
logicalChannelGroup	2 (LCG ID#2)	2 (LCG ID#2)	1 (LCG ID#1)

7.1.1.3.4.3.2 Test procedure sequence

Table 7.1.1.3.4.3.2-1: Main behaviour

St	Procedure	Message Sequence		TP	Verdict
		U - S	Message		
1	The SS ignores scheduling requests and does not allocate any uplink grant.	-	-	-	-
2	The SS transmits a MAC PDU containing two RLC SDUs of size 12 bytes on LCH4	<--	MAC PDU (2 RLC SDUs on LCH4)	-	-
3	SS allocates an UL Grant of 40 bits. (Note 1)	<--	(UL Grant, 40 bits)	-	-
4	Check: Does the UE transmit a Short BSR with 'LCG ID' field set to '2' and 'Buffer size' field set to value '4' or bigger? (Note 2)	-->	MAC PDU (MAC Short BSR (LCG ID='2', Buffer Size='4' or bigger))	2,5	P
5	Wait for retxBSR-Timer expiry on UE side.	-	-	-	-
6	Check: Does the UE transmit a scheduling request?	-->	(SR)	6	P
7	The SS responds to the scheduling request in step 6 by an UL Grant of 40 bits. (Note 1)	<--	(UL Grant, 40 bits)	-	-
8	Check: Does the UE transmit a Short BSR with 'LCG ID' field set to '2' and 'Buffer size' field set to value '4' or bigger? (Note 2)	-->	MAC PDU (MAC Short BSR (LCG ID='2', Buffer Size='4' or bigger))	4,5	P
9	The SS transmits a MAC PDU containing one RLC SDU of size 12 bytes on LCH5	<--	MAC PDU (1 RLC SDU on LCH5)	-	-
10	Check: Does the UE transmit a scheduling request?	-->	(SR)	6	P
11	The SS respond to the scheduling request in step 10 by an UL Grant of 40 bits. (Note 1)	<--	(UL Grant, 40 bits)	-	-
12	Check: Does the UE transmit a Short BSR with 'LCG ID' field set to '2' and 'Buffer size#1' field set to value '5' or bigger? (Note 2)	-->	MAC PDU (MAC Short BSR (LCG ID='2', Buffer Size='5' or bigger))	3,5	P
13	The SS transmits a MAC PDU containing two RLC SDUs of size 5 bytes on LCH6	<--	MAC PDU (2 RLC SDUs on LCH6)	-	-
14	Check: Does the UE transmit a scheduling request?	-->	(SR)	6	P
15	The SS responds to the scheduling request in step 14 by one UL Grant of 40 bits. (Note 1)	<--	(UL Grant, 40 bits)	-	-
16	Check: Does the UE transmit a Long BSR with 'Buffer size#1' field set to value '1', 'Buffer size#2' field set to value '20' or bigger? (Note 3)	-->	MAC PDU (MAC Long BSR (Buffer size#1='1' or bigger, Buffer size#2='20' or bigger))	1,5	P
17	Wait for retxBSR-Timer expiry on the UE side.	-	-	-	-
18	Check: Does the UE transmit a scheduling request?	-->	(SR)	6	P
19	SS allocates an UL Grant of 608 bits. (Note 4)	<--	(UL Grant, 608 bits)	-	-
20	Check: Does the UE transmit a MAC PDU including five RLC SDUs and BSR? (Note 5)	-->	MAC PDU (17-Byte 2 MAC sub PDUs from LCH4, 17-Byte 1 MAC sub PDU from LCH5 and 10-Byte 2 MAC Sub PDUs from LCH6)	-	-
21	SS transmits an RLC STATUS PDU to acknowledge correctly received data(LCID='000100')	<--	RLC STATUS PDU (ACK_SN=2)	-	-
22	SS transmits an RLC STATUS PDU to acknowledge correctly received data(LCID='000101')	<--	RLC STATUS PDU (ACK_SN=1)	-	-
23	SS transmits an RLC STATUS PDU to acknowledge correctly received data(LCID='000110')	<--	RLC STATUS PDU (ACK_SN=2)	-	-
24	The SS transmits a MAC PDU containing two MAC SDUs, the first containing a 8 byte RLC SDU with LCID set to LCH4 and the second containing a 7 byte RLC SDU with LCID set to LCH6.	<--	MAC PDU	-	-
25	The UE sends Scheduling Request	-->	(SR)	-	-
26	The SS transmits an uplink grant of size 256 bits. (Note 6)	<--	(UL grant, 256 bits)	-	-

27	Check: Does the UE return a MAC PDU of length 256 bits including RLC SDUs, Padding and Short BSR or LongBSR with Buffer size(s) set to '0'? (Note 5)	-->	MAC PDU (13-Byte MAC Sub PDU from LC 4 and 12-Byte MAC Sub PDU from LCH6 and 5-Byte MAC Sub PDU containing Long BSR and 2-Byte MAC Sub PDU containing Padding) Or MAC PDU (13-Byte MAC Sub PDU from LCH4 and 12-Byte MAC Sub PDU from LCH6 and 2-Byte MAC Sub PDU containing short BSR and 5-Byte MAC Sub PDU containing Padding)	8	P
28	SS transmits an RLC STATUS PDU to acknowledge correctly received data(LCID=LCH4)	<--	RLC STATUS PDU (ACK_SN=3)	-	-
29	SS transmits an RLC STATUS PDU to acknowledge correctly received data(LCID=LCH6)	<--	RLC STATUS PDU (ACK_SN=3)	-	-
<p>Note 1: 40 bits enables UE to transmit a MAC PDU with a 1 byte MAC BSR header and a Short BSR (1 byte) or a 2 bytes MAC BSR header and a Long BSR (3 bytes with 2 LCG configured).</p> <p>Note 2: UE triggers a Short BSR of type "Regular BSR" to report buffer status for one LCG for that TTI. The UE should not send any of the received RLC SDUs (segmented) due to Regular BSR has higher priority than U-plane logical channels.</p> <p>Note 3: UE triggers and transmit a Long BSR of type "Regular BSR". The UL grant would be enough for UE to transmit one RLC SDU as received in step 8, but Regular BSR has higher priority than U-plane logical channels.</p> <p>Note 4: The UE has 46 bytes of RLC SDU data (received in steps 2, 9 and 13) in the transmission buffer.608 bits enables UE to transmit user data in MAC PDU 2 RLC SDUs of 12 bytes on LCH4, each 3 Bytes RLC Header and 2 Bytes MAC Header resulting in 2 MAC Sub PDUs of 17 Bytes Each. Similarly one 17 Bytes MAC Sub PDU for 12 Bytes RLC SDU on LCH5. Two 5 Bytes RLC SDUs on LCH6 with 3 Bytes RLC header each and 2 Bytes MAC header each, will result in 2 MAC sub PDUs of 10 bytes each. Total comes to 17+17+17+10+10 +3 B LongBSR(2 Bytes LongBSR header + 1 Byte LongBSR) + 2 B padding =76 Bytes.</p> <p>Note 5: The MAC SDUs for the different logical channels may be in any order in the MAC PDU.</p> <p>Note 6: UL grant of 256 bits (L_{RBS} & I_{MCS} as per 38.523-3[3] annex B) is chosen to enable UE to transmit two MAC SDUs of size 11 and 10 bytes in a MAC PDU (8 bytes RLC SDU + 3 bytes AMD PDU header +2 Bytes MAC sub Header + 7 bytes RLC SDU+ 3 bytes AMD PDU header+2 Bytes MAC sub Header + 2 Bytes Long BSR MAC Sub Header + 3 Bytes Long BSR + 2 Bytes MAC Padding Sub PDU) or (8 bytes RLC SDU + 3 bytes AMD PDU header +2 Bytes MAC sub Header + 7 bytes RLC SDU+ 3 bytes AMD PDU header+2 Bytes MAC sub Header + 1 Byte Short BSR MAC Sub Header + 1 Byte Short BSR + 7 Bytes MAC Padding Sub PDU) = 32 Bytes</p>					

7.1.1.3.4.3.3

Specific message contents

Table 7.1.1.3.4.3.3: MAC-CellGroupConfig (preamble)

Derivation Path: TS 38.508-1 [4], clause Table 4.6.3-68			
Information Element	Value/remark	Comment	Condition
MAC-CellGroupConfig ::= SEQUENCE {			
bsr-Config SEQUENCE {			
periodicBSR-Timer	infinity		
retxBSR-Timer	sf320		
}			
phr-Config CHOICE {			
release	NULL		
}			
}			

7.1.1.3.5 Correct handling of MAC control information / Buffer Status / UL resources are allocated / Padding BSR

7.1.1.3.5.1 Test Purpose (TP)

(1)

```
with { UE in RRC_CONNECTED state }
ensure that {
  when { UE transmits a MAC PDU and the number of padding bits is equal to the size of a Short BSR
plus its subheader and the UE has available data for transmission from more than one LCG in the TTI
where the BSR is transmitted }
  then { UE reports a Truncated short BSR of the LCG with the highest priority logical channel
with data available for transmission }
}
```

(2)

```
with { UE in E-UTRA RRC_CONNECTED state }
ensure that {
  when { UE transmits a MAC PDU and the number of padding bits is larger than the size of a Short
BSR plus its subheader but smaller than the size of a Long BSR plus its subheader and the UE has
available data for transmission from more than one LCG in the TTI where the BSR is transmitted }
  then { UE reports a Truncated long BSR }
}
```

(3)

```
with { UE in RRC_CONNECTED state }
ensure that {
  when { UE transmits a MAC PDU and the number of padding bits is equal to or larger than the size
of a Short BSR plus its subheader but smaller than the size of a Long BSR plus its subheader and the
UE has available data for transmission from only one LCG in the TTI where the BSR is transmitted }
  then { UE reports a Short BSR }
}
```

(4)

```
with { UE in RRC_CONNECTED state }
ensure that {
  when { UE transmits a MAC PDU and the number of padding bits is equal to or larger than the size
of a Long BSR plus its subheader }
  then { UE reports a long BSR }
}
```

7.1.1.3.5.2 Conformance requirements

References: The conformance requirements covered in the present TC are specified in: TS 38.321, clauses 5.4.5, 6.1.3.1 and 6.2.1. Unless otherwise stated these are Rel-15 requirements.

[TS 38.321, clause 5.4.5]

The Buffer Status reporting (BSR) procedure is used to provide the serving gNB with information about UL data volume in the MAC entity.

RRC configures the following parameters to control the BSR:

- *periodicBSR-Timer*;
- *retxBSR-Timer*;
- *logicalChannelSR-Delay*;
- *logicalChannelSR-DelayTimer*;
- *logicalChannelGroup*.

Each logical channel may be allocated to an LCG using the *logicalChannelGroup*. The maximum number of LCGs is eight.

The MAC entity determines the amount of UL data available for a logical channel according to the data volume calculation procedure in TSs 38.322 and 38.323 [3] [4].

A BSR shall be triggered if any of the following events occur:

- the MAC entity has new UL data available for a logical channel which belongs to an LCG; and either
 - the new UL data belongs to a logical channel with higher priority than the priority of any logical channel containing available UL data which belong to any LCG; or
 - none of the logical channels which belong to an LCG contains any available UL data.

in which case the BSR is referred below to as 'Regular BSR';

- UL resources are allocated and number of padding bits is equal to or larger than the size of the Buffer Status Report MAC CE plus its subheader, in which case the BSR is referred below to as 'Padding BSR';
- *retxBSR-Timer* expires, and at least one of the logical channels which belong to an LCG contains UL data, in which case the BSR is referred below to as 'Regular BSR';
- *periodicBSR-Timer* expires, in which case the BSR is referred below to as 'Periodic BSR'.

For Regular BSR, the MAC entity shall:

- 1> if the BSR is triggered for a logical channel for which *logicalChannelSR-Delay* is configured by upper layers:
 - 2> start or restart the *logicalChannelSR-DelayTimer*.
- 1> else:
 - 2> if running, stop the *logicalChannelSR-DelayTimer*.

For Regular and Periodic BSR, the MAC entity shall:

- 1> if more than one LCG has data available for transmission when the BSR is to be transmitted:
 - 2> report Long BSR for all LCGs which have data available for transmission.
- 1> else:
 - 2> report Short BSR.

For Padding BSR:

- 1> if the number of padding bits is equal to or larger than the size of the Short BSR plus its subheader but smaller than the size of the Long BSR plus its subheader:
 - 2> if more than one LCG has data available for transmission when the BSR is to be transmitted:
 - 3> if the number of padding bits is equal to the size of the Short BSR plus its subheader:
 - 4> report Short Truncated BSR of the LCG with the highest priority logical channel with data available for transmission.
 - 3> else:
 - 4> report Long Truncated BSR of the LCG(s) with the logical channels having data available for transmission following a decreasing order of priority, and in case of equal priority, in increasing order of LCGID.
 - 2> else:
 - 3> report Short BSR;
- 1> else if the number of padding bits is equal to or larger than the size of the Long BSR plus its subheader:
 - 2> report Long BSR for all LCGs which have data available for transmission.

The MAC entity shall:

- 1> if the Buffer Status reporting procedure determines that at least one BSR has been triggered and not cancelled:
 - 2> if UL-SCH resources are available for a new immediate transmission:
 - 3> instruct the Multiplexing and Assembly procedure to generate the BSR MAC CE(s);
 - 3> start or restart *periodicBSR-Timer* except when all the generated BSRs are long or short Truncated BSRs;
 - 3> start or restart *retxBSR-Timer*.
 - 2> else if a Regular BSR has been triggered and *logicalChannelSR-DelayTimer* is not running:
 - 3> if an uplink grant is not a configured grant; or
 - 3> if the Regular BSR was not triggered for a logical channel for which logical channel SR masking (*logicalChannelSR-Mask*) is setup by upper layers:
 - 4> trigger a Scheduling Request.

A MAC PDU shall contain at most one BSR MAC CE, even when multiple events have triggered a BSR by the time. The Regular BSR and the Periodic BSR shall have precedence over the padding BSR.

The MAC entity shall restart *retxBSR-Timer* upon reception of a grant for transmission of new data on any UL-SCH.

All triggered BSRs may be cancelled when the UL grant(s) can accommodate all pending data available for transmission but is not sufficient to additionally accommodate the BSR MAC control element plus its subheader. All triggered BSRs shall be cancelled when a BSR is included in a MAC PDU for transmission.

The MAC entity shall transmit at most one BSR in one MAC PDU. Padding BSR shall not be included when the MAC PDU contains a Regular or Periodic BSR.

[TS 38.321, clause 6.1.3.1]

Buffer Status Report (BSR) MAC CEs consist of either:

- Short BSR format (fixed size); or
- Long BSR format (variable size); or
- Short Truncated BSR format (fixed size); or
- Long Truncated BSR format (variable size).

The BSR formats are identified by MAC PDU subheaders with LCIDs as specified in Table 6.2.1-2.

The fields in the BSR MAC CE are defined as follows:

- LCG ID: The Logical Channel Group ID field identifies the group of logical channel(s) whose buffer status is being reported. The length of the field is 3 bits;
- LCG_i: For the Long BSR format, this field indicates the presence of the Buffer Size field for the logical channel group *i*. The LCG_i field set to "1" indicates that the Buffer Size field for the logical channel group *i* is reported. The LCG_i field set to "0" indicates that the Buffer Size field for the logical channel group *i* is not reported. For the Long Truncated BSR format, this field indicates whether logical channel group *i* has data available. The LCG_i field set to "1" indicates that logical channel group *i* has data available. The LCG_i field set to "0" indicates that logical channel group *i* does not have data available;
- Buffer Size: The Buffer Size field identifies the total amount of data available according to the data volume calculation procedure in TSs 38.322 and 38.323 [3] [4] across all logical channels of a logical channel group after the MAC PDU has been built (i.e. after the logical channel prioritization procedure, which may result the value of the Buffer Size field to zero). The amount of data is indicated in number of bytes. The size of the RLC and MAC headers are not considered in the buffer size computation. The length of this field for the Short BSR format and the Short Truncated BSR format is 5 bits. The length of this field for the Long BSR format and the Long Truncated BSR format is 8 bits. The values for the 5-bit and 8-bit Buffer Size fields are shown in Tables 6.1.3.1-1 and 6.1.3.1-2, respectively. For the Long BSR format and the Long Truncated BSR format, the Buffer

Size fields are included in ascending order based on the LCG_i. For the Long Truncated BSR format the number of Buffer Size fields included is maximised, while not exceeding the number of padding bits.

NOTE: The number of the Buffer Size fields in the Long Truncated BSR format can be zero.

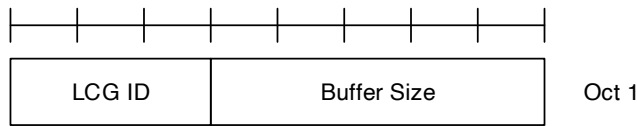

Figure 6.1.3.1-1: Short BSR and Short Truncated BSR MAC CE

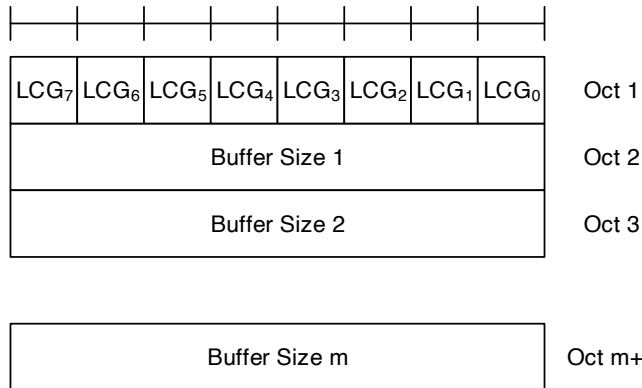

Figure 6.1.3.1-2: Long BSR and Long Truncated BSR MAC CE

Table 6.1.3.1-1: Buffer size levels (in bytes) for 5-bit Buffer Size field

Index	BS value	Index	BS value	Index	BS value	Index	BS value
0	0	8	≤ 102	16	≤ 1446	24	≤ 20516
1	≤ 10	9	≤ 142	17	≤ 2014	25	≤ 28581
2	≤ 14	10	≤ 198	18	≤ 2806	26	≤ 39818
3	≤ 20	11	≤ 276	19	≤ 3909	27	≤ 55474
4	≤ 28	12	≤ 384	20	≤ 5446	28	≤ 77284
5	≤ 38	13	≤ 535	21	≤ 7587	29	≤ 107669
6	≤ 53	14	≤ 745	22	≤ 10570	30	≤ 150000
7	≤ 74	15	≤ 1038	23	≤ 14726	31	> 150000

Table 6.1.3.1-2: Buffer size levels (in bytes) for 8-bit Buffer Size field

Index	BS value	Index	BS value	Index	BS value	Index	BS value
0	0	64	≤ 560	128	≤ 31342	192	≤ 1754595
1	≤ 10	65	≤ 597	129	≤ 33376	193	≤ 1868488
2	≤ 11	66	≤ 635	130	≤ 35543	194	≤ 1989774
3	≤ 12	67	≤ 677	131	≤ 37850	195	≤ 2118933
4	≤ 13	68	≤ 720	132	≤ 40307	196	≤ 2256475
5	≤ 14	69	≤ 767	133	≤ 42923	197	≤ 2402946
6	≤ 15	70	≤ 817	134	≤ 45709	198	≤ 2558924
7	≤ 16	71	≤ 870	135	≤ 48676	199	≤ 2725027
8	≤ 17	72	≤ 926	136	≤ 51836	200	≤ 2901912
9	≤ 18	73	≤ 987	137	≤ 55200	201	≤ 3090279
10	≤ 19	74	≤ 1051	138	≤ 58784	202	≤ 3290873
11	≤ 20	75	≤ 1119	139	≤ 62599	203	≤ 3504487
12	≤ 22	76	≤ 1191	140	≤ 66663	204	≤ 3731968
13	≤ 23	77	≤ 1269	141	≤ 70990	205	≤ 3974215
14	≤ 25	78	≤ 1351	142	≤ 75598	206	≤ 4232186
15	≤ 26	79	≤ 1439	143	≤ 80505	207	≤ 4506902
16	≤ 28	80	≤ 1532	144	≤ 85730	208	≤ 4799451
17	≤ 30	81	≤ 1631	145	≤ 91295	209	≤ 5110989
18	≤ 32	82	≤ 1737	146	≤ 97221	210	≤ 5442750
19	≤ 34	83	≤ 1850	147	≤ 103532	211	≤ 5796046
20	≤ 36	84	≤ 1970	148	≤ 110252	212	≤ 6172275
21	≤ 38	85	≤ 2098	149	≤ 117409	213	≤ 6572925
22	≤ 40	86	≤ 2234	150	≤ 125030	214	≤ 6999582
23	≤ 43	87	≤ 2379	151	≤ 133146	215	≤ 7453933
24	≤ 46	88	≤ 2533	152	≤ 141789	216	≤ 7937777
25	≤ 49	89	≤ 2698	153	≤ 150992	217	≤ 8453028
26	≤ 52	90	≤ 2873	154	≤ 160793	218	≤ 9001725
27	≤ 55	91	≤ 3059	155	≤ 171231	219	≤ 9586039
28	≤ 59	92	≤ 3258	156	≤ 182345	220	≤ 10208280
29	≤ 62	93	≤ 3469	157	≤ 194182	221	≤ 10870913
30	≤ 66	94	≤ 3694	158	≤ 206786	222	≤ 11576557
31	≤ 71	95	≤ 3934	159	≤ 220209	223	≤ 12328006
32	≤ 75	96	≤ 4189	160	≤ 234503	224	≤ 13128233
33	≤ 80	97	≤ 4461	161	≤ 249725	225	≤ 13980403
34	≤ 85	98	≤ 4751	162	≤ 265935	226	≤ 14887889
35	≤ 91	99	≤ 5059	163	≤ 283197	227	≤ 15854280
36	≤ 97	100	≤ 5387	164	≤ 301579	228	≤ 16883401
37	≤ 103	101	≤ 5737	165	≤ 321155	229	≤ 17979324
38	≤ 110	102	≤ 6109	166	≤ 342002	230	≤ 19146385
39	≤ 117	103	≤ 6506	167	≤ 364202	231	≤ 20389201
40	≤ 124	104	≤ 6928	168	≤ 387842	232	≤ 21712690
41	≤ 132	105	≤ 7378	169	≤ 413018	233	≤ 23122088
42	≤ 141	106	≤ 7857	170	≤ 439827	234	≤ 24622972
43	≤ 150	107	≤ 8367	171	≤ 468377	235	≤ 26221280
44	≤ 160	108	≤ 8910	172	≤ 498780	236	≤ 27923336
45	≤ 170	109	≤ 9488	173	≤ 531156	237	≤ 29735875
46	≤ 181	110	≤ 10104	174	≤ 565634	238	≤ 31666069
47	≤ 193	111	≤ 10760	175	≤ 602350	239	≤ 33721553
48	≤ 205	112	≤ 11458	176	≤ 641449	240	≤ 35910462
49	≤ 218	113	≤ 12202	177	≤ 683087	241	≤ 38241455
50	≤ 233	114	≤ 12994	178	≤ 727427	242	≤ 40723756
51	≤ 248	115	≤ 13838	179	≤ 774645	243	≤ 43367187
52	≤ 264	116	≤ 14736	180	≤ 824928	244	≤ 46182206
53	≤ 281	117	≤ 15692	181	≤ 878475	245	≤ 49179951
54	≤ 299	118	≤ 16711	182	≤ 935498	246	≤ 52372284
55	≤ 318	119	≤ 17795	183	≤ 996222	247	≤ 55771835
56	≤ 339	120	≤ 18951	184	≤ 1060888	248	≤ 59392055
57	≤ 361	121	≤ 20181	185	≤ 1129752	249	≤ 63247269
58	≤ 384	122	≤ 21491	186	≤ 1203085	250	≤ 67352729
59	≤ 409	123	≤ 22885	187	≤ 1281179	251	≤ 71724679
60	≤ 436	124	≤ 24371	188	≤ 1364342	252	≤ 76380419
61	≤ 464	125	≤ 25953	189	≤ 1452903	253	≤ 81338368

62	≤ 494	126	≤ 27638	190	≤ 1547213	254	> 81338368
63	≤ 526	127	≤ 29431	191	≤ 1647644	255	Reserved

[TS 38.321, clause 6.2.1]

Table 6.2.1-2: Values of LCID for UL-SCH

Index	LCID values
000000	CCCH
000001–100000	Identity of the logical channel
100001–110110	Reserved
110111	Configured Grant Confirmation
111000	Multiple Entry PHR
111001	Single Entry PHR
111010	C-RNTI
111011	Short Truncated BSR
111100	Long Truncated BSR
111101	Short BSR
111110	Long BSR
111111	Padding

7.1.1.3.5.3 Test description

7.1.1.3.5.3.1 Pre-test conditions

Same Pre-test conditions as in clause 7.1.1.0 with the exception of 2 AM DRBs on NR cell configured according to Table 7.1.1.3.5.3.1-1.

Table 7.1.1.3.5.3.1-1: Logical Channel Configuration Settings

Parameter	DRB1	DRB2
LogicalChannelIdentity	LCH4(DRB-Identity +3)	LCH5(DRB-Identity +3)
Priority	7	6
prioritizedBitRate	0kbs	0kbs
logicalChannelGroup	2 (LCG ID#2)	1 (LCG ID#1)

7.1.1.3.5.3.2 Test procedure sequence

Table 7.1.1.3.5.3.2-1: Main behaviour

St	Procedure	Message Sequence		TP	Verdict
		U - S	Message		
1	The SS ignores scheduling requests and does not allocate any uplink grant.	-	-	-	-
-	EXCEPTION: Step 2 shall be repeated for 3 times	-	-	-	-
2	The SS transmits a MAC PDU including an RLC PDU of size 13 bytes on LCH5.	<--	MAC PDU (RLC SDU on LCH5)	-	-
3	The SS transmits a MAC PDU including an RLC PDU of size 12 bytes on LCH4.	<--	MAC PDU (RLC SDU on LCH4)	-	-
4	UE transmits a Scheduling Request on PUCCH.	-->	(SR)	-	-
5	The SS sends an uplink grant of size 40 bits. (Note 1)	<--	(UL grant)	-	-
6	The UE transmit a Long BSR report.	-->	MAC PDU (Long BSR header (LCID='111110'), Long BSR)	-	-
7	The SS sends an uplink grant of size 136 bits. (Note 2)	<--	(UL grant)	-	-
8	Check: Does UE transmit a MAC PDU containing an RLC SDU and a short truncated BSR indicating pending data ('Buffer size' field > '0') for logicalChannelGroup 1 ('LCG ID' field set to '01')?	-->	MAC PDU (MAC sub PDU header for RLC PDU, RLC PDU, short truncated BSR header (LCID='111011'), short truncatedBSR(LCG ID='01', Buffer size>'0'))	1	P
9	The SS sends an uplink grant of size 152 bits. (Note 3)	<--	(UL grant)	-	-
10	Check: Does UE transmit a MAC PDU containing an RLC SDU and a long truncated BSR indicating pending data available for LCG ₁ and LCG ₂ and 'Buffer size' field > '0' for logicalChannelGroup 1?	-->	MAC PDU (MAC sub PDU header for RLC PDU, RLC PDU, long truncated BSR header (LCID='111100'), long truncatedBSR(LCG ₁ =1, LCG ₂ =1, Buffer size1>'0'))	2	P
11	The SS sends an uplink grant of size 136 bits. (Note 4)	<--	(UL grant)	-	-
12	Check: Does UE transmit a MAC PDU containing an RLC SDU and with a Short BSR indicating pending data ('Buffer size' field > '0') for logicalChannelGroup 2 ('LCG ID' field ='10')?	-->	MAC PDU (MAC sub PDU header for RLC PDU, RLC PDU, Short BSR header(LCID='11101'), Short BSR(LCG ID='10',Buffer size>'0'))	3	P
12 A	SS transmits an RLC STATUS PDU to acknowledge correctly received data (LCID=LCH5)	<--	RLC STATUS PDU (ACK_SN=3)	-	-
13	The SS sends an uplink grant of size 160 bits. (Note 5)	<--	(UL grant)	-	-
14	Check: Does UE transmit a MAC PDU containing a RLC SDU and a Long BSR?	-->	MAC PDU (MAC sub PDU header for RLC PDU, RLC PDU, Long BSR header (LCID='111110'), Long BSR)	4	P
15	SS transmits an RLC STATUS PDU to acknowledge correctly received data (LCID=LCH4)	<--	RLC STATUS PDU (ACK_SN=1)	-	-
<p>Note 1: 40 bits (L_{RBs} & I_{MCS} as per 38.523-3[3] annex B) enables UE to transmit a MAC PDU with a MAC BSR header (1 byte) and a Short BSR (1 byte) or a MAC BSR header (2 bytes) a Long BSR (3 bytes when 2 LCG configured).</p> <p>Note 2: UE triggers a truncated Short BSR of type "Padding BSR" to report buffer status for one LCG for that TTI. (2 Bytes MAC Data sub PDU header + 13 Bytes MAC SDU + 1 Byte Short truncated BSR sub header + 1 Byte Short truncated BSR = 17 bytes)</p> <p>Note 3: UE triggers a truncated Long BSR of type "Padding BSR" to report buffer status for one LCG for that TTI. (2 Bytes MAC Data sub PDU header + 13 Bytes MAC SDU + 2 Bytes Long truncated BSR sub header + 2 Bytes Long truncated BSR = 19 bytes)</p> <p>Note 4: UE triggers a Short BSR of type "Padding BSR" to report buffer status for one LCG for that TTI. (2 Bytes MAC Data sub PDU header + 13 Bytes MAC SDU + 1 Byte Short BSR sub header + 1 Byte short BSR = 17 bytes)</p>					

Note 5: UE triggers a long BSR of type "Padding BSR" to report buffer status for one LCG for that TTI. (2 Bytes MAC Data sub PDU header + 12 Bytes MAC SDU + 2 Bytes long BSR sub header + 1 Byte long BSR + 1 byte Padding sub header + 2 bytes Padding = 20 bytes)

7.1.1.3.5.3.3 Specific message contents

None

7.1.1.3.6 Correct handling of MAC control information / Buffer status / Periodic BSR timer expires

7.1.1.3.6.1 Test Purpose (TP)

(1)

```
with { UE in RRC_CONNECTED state }
ensure that {
  when { periodicBSR-Timer expires and more than one LCG has buffered data }
  then { UE triggers a Periodic BSR and reports Long BSR and restarts the periodicBSR-Timer }
}
```

(2)

```
with { UE in E-UTRA RRC_CONNECTED state }
ensure that {
  when { periodicBSR-Timer expires and one LCG has buffered data }
  then { UE triggers a Periodic BSR and reports Short BSR and restarts the periodicBSR-Timer }
}
```

7.1.1.3.6.2 Conformance requirements

References: The conformance requirements covered in the present TC are specified in: TS 38.321, clauses 5.4.5, 6.1.3.1 and 6.2.1. Unless otherwise stated these are Rel-15 requirements.

[TS 38.321, clause 5.4.5]

The Buffer Status reporting (BSR) procedure is used to provide the serving gNB with information about UL data volume in the MAC entity.

RRC configures the following parameters to control the BSR:

- *periodicBSR-Timer*;
- *retxBSR-Timer*;
- *logicalChannelSR-Delay*;
- *logicalChannelSR-DelayTimer*;
- *logicalChannelGroup*.

Each logical channel may be allocated to an LCG using the *logicalChannelGroup*. The maximum number of LCGs is eight.

The MAC entity determines the amount of UL data available for a logical channel according to the data volume calculation procedure in TSs 38.322 and 38.323 [3] [4].

A BSR shall be triggered if any of the following events occur:

- the MAC entity has new UL data available for a logical channel which belongs to an LCG; and either
 - the new UL data belongs to a logical channel with higher priority than the priority of any logical channel containing available UL data which belong to any LCG; or
 - none of the logical channels which belong to an LCG contains any available UL data.

in which case the BSR is referred below to as 'Regular BSR';

- UL resources are allocated and number of padding bits is equal to or larger than the size of the Buffer Status Report MAC CE plus its subheader, in which case the BSR is referred below to as 'Padding BSR';
- *retxBSR-Timer* expires, and at least one of the logical channels which belong to an LCG contains UL data, in which case the BSR is referred below to as 'Regular BSR';
- *periodicBSR-Timer* expires, in which case the BSR is referred below to as 'Periodic BSR'.

For Regular BSR, the MAC entity shall:

- 1> if the BSR is triggered for a logical channel for which *logicalChannelSR-Delay* is configured by upper layers:
 - 2> start or restart the *logicalChannelSR-DelayTimer*.
- 1> else:
 - 2> if running, stop the *logicalChannelSR-DelayTimer*.

For Regular and Periodic BSR, the MAC entity shall:

- 1> if more than one LCG has data available for transmission when the BSR is to be transmitted:
 - 2> report Long BSR for all LCGs which have data available for transmission.
- 1> else:
 - 2> report Short BSR.

For Padding BSR:

- 1> if the number of padding bits is equal to or larger than the size of the Short BSR plus its subheader but smaller than the size of the Long BSR plus its subheader:
 - 2> if more than one LCG has data available for transmission when the BSR is to be transmitted:
 - 3> if the number of padding bits is equal to the size of the Short BSR plus its subheader:
 - 4> report Short Truncated BSR of the LCG with the highest priority logical channel with data available for transmission.
 - 3> else:
 - 4> report Long Truncated BSR of the LCG(s) with the logical channels having data available for transmission following a decreasing order of priority, and in case of equal priority, in increasing order of LCGID.
 - 2> else:
 - 3> report Short BSR;
- 1> else if the number of padding bits is equal to or larger than the size of the Long BSR plus its subheader:
 - 2> report Long BSR for all LCGs which have data available for transmission.

The MAC entity shall:

- 1> if the Buffer Status reporting procedure determines that at least one BSR has been triggered and not cancelled:
 - 2> if UL-SCH resources are available for a new immediate transmission:
 - 3> instruct the Multiplexing and Assembly procedure to generate the BSR MAC CE(s);
 - 3> start or restart *periodicBSR-Timer* except when all the generated BSRs are long or short Truncated BSRs;
 - 3> start or restart *retxBSR-Timer*.

- 2> else if a Regular BSR has been triggered and *logicalChannelSR-DelayTimer* is not running:
- 3> if an uplink grant is not a configured grant; or
- 3> if the Regular BSR was not triggered for a logical channel for which logical channel SR masking (*logicalChannelSR-Mask*) is setup by upper layers:
- 4> trigger a Scheduling Request.

A MAC PDU shall contain at most one BSR MAC CE, even when multiple events have triggered a BSR by the time. The Regular BSR and the Periodic BSR shall have precedence over the padding BSR.

The MAC entity shall restart *retxBSR-Timer* upon reception of a grant for transmission of new data on any UL-SCH.

All triggered BSRs may be cancelled when the UL grant(s) can accommodate all pending data available for transmission but is not sufficient to additionally accommodate the BSR MAC control element plus its subheader. All triggered BSRs shall be cancelled when a BSR is included in a MAC PDU for transmission.

The MAC entity shall transmit at most one BSR in one MAC PDU. Padding BSR shall not be included when the MAC PDU contains a Regular or Periodic BSR.

[TS 38.321, clause 6.1.3.1]

Buffer Status Report (BSR) MAC CEs consist of either:

- Short BSR format (fixed size); or
- Long BSR format (variable size); or
- Short Truncated BSR format (fixed size); or
- Long Truncated BSR format (variable size).

The BSR formats are identified by MAC PDU subheaders with LCIDs as specified in Table 6.2.1-2.

The fields in the BSR MAC CE are defined as follows:

- LCG ID: The Logical Channel Group ID field identifies the group of logical channel(s) whose buffer status is being reported. The length of the field is 3 bits;
- LCG_i: For the Long BSR format, this field indicates the presence of the Buffer Size field for the logical channel group *i*. The LCG_i field set to "1" indicates that the Buffer Size field for the logical channel group *i* is reported. The LCG_i field set to "0" indicates that the Buffer Size field for the logical channel group *i* is not reported. For the Long Truncated BSR format, this field indicates whether logical channel group *i* has data available. The LCG_i field set to "1" indicates that logical channel group *i* has data available. The LCG_i field set to "0" indicates that logical channel group *i* does not have data available;
- Buffer Size: The Buffer Size field identifies the total amount of data available according to the data volume calculation procedure in TSs 38.322 and 38.323 [3] [4] across all logical channels of a logical channel group after the MAC PDU has been built (i.e. after the logical channel prioritization procedure, which may result the value of the Buffer Size field to zero). The amount of data is indicated in number of bytes. The size of the RLC and MAC headers are not considered in the buffer size computation. The length of this field for the Short BSR format and the Short Truncated BSR format is 5 bits. The length of this field for the Long BSR format and the Long Truncated BSR format is 8 bits. The values for the 5-bit and 8-bit Buffer Size fields are shown in Tables 6.1.3.1-1 and 6.1.3.1-2, respectively. For the Long BSR format and the Long Truncated BSR format, the Buffer Size fields are included in ascending order based on the LCG_i. For the Long Truncated BSR format the number of Buffer Size fields included is maximised, while not exceeding the number of padding bits.

NOTE: The number of the Buffer Size fields in the Long Truncated BSR format can be zero.

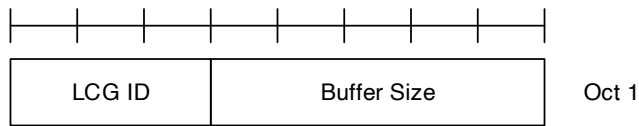

Figure 6.1.3.1-1: Short BSR and Short Truncated BSR MAC CE

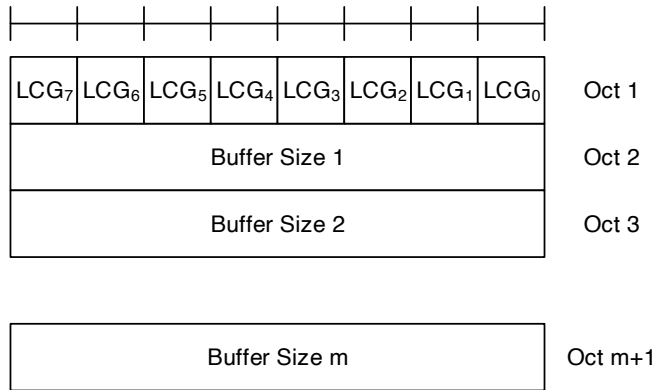

Figure 6.1.3.1-2: Long BSR and Long Truncated BSR MAC CE

Table 6.1.3.1-1: Buffer size levels (in bytes) for 5-bit Buffer Size field

Index	BS value	Index	BS value	Index	BS value	Index	BS value
0	0	8	≤ 102	16	≤ 1446	24	≤ 20516
1	≤ 10	9	≤ 142	17	≤ 2014	25	≤ 28581
2	≤ 14	10	≤ 198	18	≤ 2806	26	≤ 39818
3	≤ 20	11	≤ 276	19	≤ 3909	27	≤ 55474
4	≤ 28	12	≤ 384	20	≤ 5446	28	≤ 77284
5	≤ 38	13	≤ 535	21	≤ 7587	29	≤ 107669
6	≤ 53	14	≤ 745	22	≤ 10570	30	≤ 150000
7	≤ 74	15	≤ 1038	23	≤ 14726	31	> 150000

Table 6.1.3.1-2: Buffer size levels (in bytes) for 8-bit Buffer Size field

Index	BS value	Index	BS value	Index	BS value	Index	BS value
0	0	64	≤ 526	128	≤ 29431	192	≤ 1647644
1	≤ 10	65	≤ 560	129	≤ 31342	193	≤ 1754595
2	≤ 11	66	≤ 597	130	≤ 33376	194	≤ 1868488
3	≤ 12	67	≤ 635	131	≤ 35543	195	≤ 1989774
4	≤ 13	68	≤ 677	132	≤ 37850	196	≤ 2118933
5	≤ 13	69	≤ 720	133	≤ 40307	197	≤ 2256475
6	≤ 14	70	≤ 767	134	≤ 42923	198	≤ 2402946
7	≤ 15	71	≤ 817	135	≤ 45709	199	≤ 2558924
8	≤ 16	72	≤ 870	136	≤ 48676	200	≤ 2725027
9	≤ 17	73	≤ 926	137	≤ 51836	201	≤ 2901912
10	≤ 18	74	≤ 987	138	≤ 55200	202	≤ 3090279
11	≤ 19	75	≤ 1051	139	≤ 58784	203	≤ 3290873
12	≤ 20	76	≤ 1119	140	≤ 62599	204	≤ 3504487
13	≤ 22	77	≤ 1191	141	≤ 66663	205	≤ 3731968
14	≤ 23	78	≤ 1269	142	≤ 70990	206	≤ 3974215
15	≤ 25	79	≤ 1351	143	≤ 75598	207	≤ 4232186
16	≤ 26	80	≤ 1439	144	≤ 80505	208	≤ 4506902
17	≤ 28	81	≤ 1532	145	≤ 85730	209	≤ 4799451
18	≤ 30	82	≤ 1631	146	≤ 91295	210	≤ 5110989
19	≤ 32	83	≤ 1737	147	≤ 97221	211	≤ 5442750
20	≤ 34	84	≤ 1850	148	≤ 103532	212	≤ 5796046
21	≤ 36	85	≤ 1970	149	≤ 110252	213	≤ 6172275
22	≤ 38	86	≤ 2098	150	≤ 117409	214	≤ 6572925
23	≤ 40	87	≤ 2234	151	≤ 125030	215	≤ 6999582
24	≤ 43	88	≤ 2379	152	≤ 133146	216	≤ 7453933
25	≤ 46	89	≤ 2533	153	≤ 141789	217	≤ 7937777
26	≤ 49	90	≤ 2698	154	≤ 150992	218	≤ 8453028
27	≤ 52	91	≤ 2873	155	≤ 160793	219	≤ 9001725
28	≤ 55	92	≤ 3059	156	≤ 171231	220	≤ 9586039
29	≤ 59	93	≤ 3258	157	≤ 182345	221	≤ 10208280
30	≤ 62	94	≤ 3469	158	≤ 194182	222	≤ 10870913
31	≤ 66	95	≤ 3694	159	≤ 206786	223	≤ 11576557
32	≤ 71	96	≤ 3934	160	≤ 220209	224	≤ 12328006
33	≤ 75	97	≤ 4189	161	≤ 234503	225	≤ 13128233
34	≤ 80	98	≤ 4461	162	≤ 249725	226	≤ 13980403
35	≤ 85	99	≤ 4751	163	≤ 265935	227	≤ 14887889
36	≤ 91	100	≤ 5059	164	≤ 283197	228	≤ 15854280
37	≤ 97	101	≤ 5387	165	≤ 301579	229	≤ 16883401
38	≤ 103	102	≤ 5737	166	≤ 321155	230	≤ 17979324
39	≤ 110	103	≤ 6109	167	≤ 342002	231	≤ 19146385
40	≤ 117	104	≤ 6506	168	≤ 364202	232	≤ 20389201
41	≤ 124	105	≤ 6928	169	≤ 387842	233	≤ 21712690
42	≤ 132	106	≤ 7378	170	≤ 413018	234	≤ 23122088
43	≤ 141	107	≤ 7857	171	≤ 439827	235	≤ 24622972
44	≤ 150	108	≤ 8367	172	≤ 468377	236	≤ 26221280
45	≤ 160	109	≤ 8910	173	≤ 498780	237	≤ 27923336
46	≤ 170	110	≤ 9488	174	≤ 531156	238	≤ 29735875
47	≤ 181	111	≤ 10104	175	≤ 565634	239	≤ 31666069
48	≤ 193	112	≤ 10760	176	≤ 602350	240	≤ 33721553
49	≤ 205	113	≤ 11458	177	≤ 641449	241	≤ 35910462
50	≤ 218	114	≤ 12202	178	≤ 683087	242	≤ 38241455
51	≤ 233	115	≤ 12994	179	≤ 727427	243	≤ 40723756
52	≤ 248	116	≤ 13838	180	≤ 774645	244	≤ 43367187
53	≤ 264	117	≤ 14736	181	≤ 824928	245	≤ 46182206
54	≤ 281	118	≤ 15692	182	≤ 878475	246	≤ 49179951
55	≤ 299	119	≤ 16711	183	≤ 935498	247	≤ 52372284
56	≤ 318	120	≤ 17795	184	≤ 996222	248	≤ 55771835
57	≤ 339	121	≤ 18951	185	≤ 1060888	249	≤ 59392055
58	≤ 361	122	≤ 20181	186	≤ 1129752	250	≤ 63247269
59	≤ 384	123	≤ 21491	187	≤ 1203085	251	≤ 67352729
60	≤ 409	124	≤ 22885	188	≤ 1281179	252	≤ 71724679
61	≤ 436	125	≤ 24371	189	≤ 1364342	253	≤ 76380419

62	≤ 464	126	≤ 25953	190	≤ 1452903	254	≤ 81338368
63	≤ 494	127	≤ 27638	191	≤ 1547213	255	> 81338368

[TS 38.321, clause 6.2.1]

Table 6.2.1-2: Values of LCID for UL-SCH

Index	LCID values
000000	CCCH
000001–100000	Identity of the logical channel
100001–110110	Reserved
110111	Configured Grant Confirmation
111000	Multiple Entry PHR
111001	Single Entry PHR
111010	C-RNTI
111011	Short Truncated BSR
111100	Long Truncated BSR
111101	Short BSR
111110	Long BSR
111111	Padding

7.1.1.3.6.3 Test description

7.1.1.3.6.3.1 Pre-test conditions

Same Pre-test conditions as in clause 7.1.1.0 with the exception of 2 SN terminated SCG bearers configured according to Table 7.1.1.3.6.3.1-1.

Table 7.1.1.3.6.3.1-1: Logical Channel Configuration Settings

Parameter	DRB1	DRB2
LogicalChannelIdentity	LCH4(DRB-Identity +3)	LCH5(DRB-Identity +3)
Priority	7	6
prioritizedBitRate	0kbs	0kbs
logicalChannelGroup	2 (LCG ID#2)	1 (LCG ID#1)

7.1.1.3.6.3.2 Test procedure sequence

Table 7.1.1.3.6.3.2-1: Main behaviour

St	Procedure	Message Sequence		TP	Verdict
		U - S	Message		
1	The SS ignores scheduling requests and does not allocate any uplink grant.	-	-	-	-
2	The SS transmits a MAC PDU containing an RLC PDU on LCH4 (LCG ID 2), which contains 1 RLC SDU of size 14 bytes.	<--	MAC PDU (RLC PDU)		
3	The SS sends an uplink grant of size 32 bits. (Note 1)	<--	(UL grant)	-	-
4	The UE transmits a short BSR report and restarts <i>periodicBSR-Timer</i>	-->	MAC PDU ((LCID='111101', LCG ID='10', Buffer size index > 0)	-	-
-	EXCEPTION: Steps 5 to 7 shall be repeated two times (Note 2)	-	-	-	-
5	Wait for <i>periodicBSR-Timer</i> expiry.	-	-	-	-
6	The SS sends an uplink grant of size 32 bits	-	-	-	-
7	Check: Does UE transmit a MAC PDU containing a Short BSR with 'LCG ID' field set to '10' (logicalChannelGroup 2) and Buffer Size Index > 0?	-->	MAC PDU (LCID='111101', LCG ID='10', Buffer Size index > 0)	2	P
8	The SS transmits a MAC PDU containing an RLC PDU on LCH5 (LCG ID 1), which contains 1 RLC SDU of size 14 bytes.	<--	MAC PDU (RLC PDU)	-	-
9	The SS sends an uplink grant of size 40 bits (Note 3)	<--	(UL grant)	-	-
10	The UE transmits a long BSR report with 'Buffer size#1' (LCG ID=1) and 'Buffer size#2' (LCG ID=2) fields set to value > '0'	-->	MAC PDU (('Buffer size#1 index' > 0, 'Buffer size#2 index=' >0')	-	-
-	EXCEPTION: Step 11 to 13 shall be repeated twice. (Note 4)	-	-	-	-
11	Wait for <i>periodicBSR-Timer</i> expiry.	-	-	-	-
12	The SS sends an uplink grant of size 40 bits	-	-	-	-
13	Check: Does UE transmit a MAC PDU containing a Long BSR with 'Buffer size#1' (LCG ID=1) and 'Buffer size#2' (LCG ID=2) fields set to value > '0'?	-->	MAC PDU	1	P
14	The SS transmits 1 UL grant of size 320 bits to enable the UE to loopback RLC SDU on LCH4 and LCH5.			-	-
15	The UE transmits MAC PDU containing the remaining RLC SDUs as sent by the SS in steps 2 and 8.	-->	MAC PDU	-	-
Note 1:	SS transmits an UL grant of 32 bits(L_{RBs} & I_{MCS} as per 38.523-3[3] annex B) to allow UE to transmit a Regular BSR triggered by the new data received logicalChannelGroup 1 in step 2.				
Note 2:	One short BSR due to first expiry of <i>periodicBSR-Timer</i> and one short BSR due to second expiry of <i>periodicBSR-Timer</i> .				
Note 3:	SS transmits an UL grant of 40 bits(L_{RBs} & I_{MCS} as per 38.523-3[3] annex B) to allow UE to transmit a Regular BSR triggered by the new data received on higher priority logicalChannelGroup 1 in step 8.				
Note 4:	One long BSR due to expiry of <i>periodicBSR-Timer</i> and one long BSR due to second expiry of <i>periodicBSR-Timer</i> .				

7.1.1.3.6.3.3 Specific message contents

Table 7.1.1.3.6.3.3: MAC-CellGroupConfig (preamble)

Derivation Path: TS 38.308 [6], clause Table 4.6.3-49			
Information Element	Value/remark	Comment	Condition
MAC-CellGroupConfig ::= SEQUENCE {			
bsr-Config SEQUENCE {			
periodicBSR-Timer	sf160		
retxBSR-Timer	sf10240		
}			
phr-Config CHOICE {			
release	NULL		
}			
}			

7.1.1.3.7 UE power headroom reporting / Periodic reporting / DL pathloss change reporting

7.1.1.3.7.1 Test Purpose (TP)

(1)

```
with { UE in RRC_CONNECTED state }
ensure that {
  when { phr-PeriodicTimer is configured in UE }
  then { UE transmits a MAC PDU containing Power Headroom MAC Control Element }
}
```

(2)

```
with { UE in RRC_CONNECTED state with periodic power headroom reporting configured }
ensure that {
  when { phr-PeriodicTimer expires and UL resources allocated for new transmission }
  then { UE transmits a MAC PDU containing Power Headroom MAC Control Element }
}
```

(3)

```
with { UE in RRC_CONNECTED state with periodic power headroom reporting configured }
ensure that {
  when { power headroom reporting is disabled }
  then { UE stops transmitting Power Headroom MAC Control Element }
}
```

(4)

```
with { UE in RRC_Connected state with Power headroom reporting for phr-Tx-PowerFactorChange
configured }
ensure that {
  when { the DL Pathloss has changed more than phr-Tx-PowerFactorChange dB and phr-ProhibitTimer is
running }
  then { UE does not transmit a MAC PDU containing Power Headroom MAC Control Element }
}
```

(5)

```
with { UE in RRC_Connected state with Power headroom reporting for phr-Tx-PowerFactorChange
configured }
ensure that {
  when { phr-ProhibitTimer expires and power headroom report is triggered due to DL Pathloss change
}
  then { UE transmits a MAC PDU containing Power Headroom MAC Control Element }
}
```

7.1.1.3.7.2 Conformance requirements

References: The conformance requirements covered in the current TC are specified in: TS 38.321 clause 5.4.6 and 6.1.3.8. Unless otherwise stated these are Rel-15 requirements.

[TS 38.321, clause 5.4.6]

The Power Headroom reporting procedure is used to provide the serving gNB with the following information:

- Type 1 power headroom: the difference between the nominal UE maximum transmit power and the estimated power for UL-SCH transmission per activated Serving Cell;
- Type 2 power headroom: the difference between the nominal UE maximum transmit power and the estimated power for UL-SCH and PUCCH transmission on SpCell of the other MAC entity (i.e. E-UTRA MAC entity in EN-DC case only);
- Type 3 power headroom: the difference between the nominal UE maximum transmit power and the estimated power for SRS transmission per activated Serving Cell.

RRC controls Power Headroom reporting by configuring the following parameters:

- *phr-PeriodicTimer*;
- *phr-ProhibitTimer*;
- *phr-Tx-PowerFactorChange*;
- *phr-Type2PCell*;
- *phr-Type2OtherCell*;
- *phr-ModeOtherCG*;
- *multiplePHR*.

A Power Headroom Report (PHR) shall be triggered if any of the following events occur:

- *phr-ProhibitTimer* expires or has expired and the path loss has changed more than *phr-Tx-PowerFactorChange* dB for at least one activated Serving Cell of any MAC entity which is used as a pathloss reference since the last transmission of a PHR in this MAC entity when the MAC entity has UL resources for new transmission;

NOTE 1: The path loss variation for one cell assessed above is between the pathloss measured at present time on the current pathloss reference and the pathloss measured at the transmission time of the last transmission of PHR on the pathloss reference in use at that time, irrespective of whether the pathloss reference has changed in between.

- *phr-PeriodicTimer* expires;
- upon configuration or reconfiguration of the power headroom reporting functionality by upper layers, which is not used to disable the function;
- activation of an SCell of any MAC entity with configured uplink;
- addition of the PSCell (i.e. PSCell is newly added or changed);
- *phr-ProhibitTimer* expires or has expired, when the MAC entity has UL resources for new transmission, and the following is true for any of the activated Serving Cells of any MAC entity with configured uplink:
 - there are UL resources allocated for transmission or there is a PUCCH transmission on this cell, and the required power backoff due to power management (as allowed by $P\text{-MPR}_c$ as specified in TS 38.101-1 [14], TS 38.101-2 [15], and TS 38.101-3 [16]) for this cell has changed more than *phr-Tx-PowerFactorChange* dB since the last transmission of a PHR when the MAC entity had UL resources allocated for transmission or PUCCH transmission on this cell.

NOTE 2: The MAC entity should avoid triggering a PHR when the required power backoff due to power management decreases only temporarily (e.g. for up to a few tens of milliseconds) and it should avoid reflecting such temporary decrease in the values of $P_{CMAX,f,c}/PH$ when a PHR is triggered by other triggering conditions.

If the MAC entity has UL resources allocated for a new transmission the MAC entity shall:

- 1> if it is the first UL resource allocated for a new transmission since the last MAC reset:
 - 2> start *phr-PeriodicTimer*;
- 1> if the Power Headroom reporting procedure determines that at least one PHR has been triggered and not cancelled; and
- 1> if the allocated UL resources can accommodate the MAC CE for PHR which the MAC entity is configured to transmit, plus its subheader, as a result of LCP as defined in subclause 5.4.3.1:
 - 2> if *multiplePHR* is configured:
 - 3> for each activated Serving Cell with configured uplink associated with any MAC entity:
 - 4> obtain the value of the Type 1 or Type 3 power headroom for the corresponding uplink carrier as specified in subclause 7.7 of TS 38.213 [6];
 - 4> if this MAC entity has UL resources allocated for transmission on this Serving Cell; or
 - 4> if the other MAC entity, if configured, has UL resources allocated for transmission on this Serving Cell and *phr-ModeOtherCG* is set to real by upper layers:
 - 5> obtain the value for the corresponding $P_{CMAX,f,c}$ field from the physical layer.
 - 3> if *phr-Type2OtherCell* is configured:
 - 4> if the other MAC entity is E-UTRA MAC entity:
 - 5> obtain the value of the Type 2 power headroom for the SpCell of the other MAC entity (i.e. E-UTRA MAC entity);
 - 5> if *phr-ModeOtherCG* is set to real by upper layers:
 - 6> obtain the value for the corresponding $P_{CMAX,f,c}$ field for the SpCell of the other MAC entity (i.e. E-UTRA MAC entity) from the physical layer.
 - 3> instruct the Multiplexing and Assembly procedure to generate and transmit the Multiple Entry PHR MAC CE as defined in subclause 6.1.3.9 based on the values reported by the physical layer.
 - 2> else (i.e. Single Entry PHR format is used):
 - 3> obtain the value of the Type 1 power headroom from the physical layer for the corresponding uplink carrier of the PCell;
 - 3> obtain the value for the corresponding $P_{CMAX,f,c}$ field from the physical layer;
 - 3> instruct the Multiplexing and Assembly procedure to generate and transmit the Single Entry PHR MAC CE as defined in subclause 6.1.3.8 based on the values reported by the physical layer.
 - 2> start or restart *phr-PeriodicTimer*;
 - 2> start or restart *phr-ProhibitTimer*;
 - 2> cancel all triggered PHR(s).

[TS 38.321, clause 6.1.3.8]

The Single Entry PHR MAC CE is identified by a MAC PDU subheader with LCID as specified in Table 6.2.1-2.

It has a fixed size and consists of two octet defined as follows (figure 6.1.3.8-1):

- R: Reserved bit, set to "0";
- Power Headroom (PH): This field indicates the power headroom level. The length of the field is 6 bits. The reported PH and the corresponding power headroom levels are shown in Table 6.1.3.8-1 below (the corresponding measured values in dB are specified in TS 38.133 [11]);
- $P_{CMAX,f,c}$: This field indicates the $P_{CMAX,f,c}$ (as specified in TS 38.213 [6]) used for calculation of the preceding PH field. The reported $P_{CMAX,f,c}$ and the corresponding nominal UE transmit power levels are shown in Table 6.1.3.8-2 (the corresponding measured values in dBm are specified in TS 38.133 [11]).

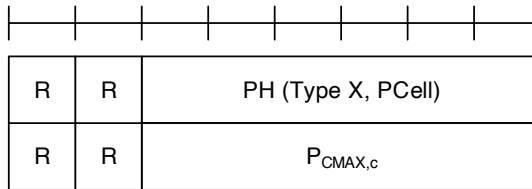

Figure 6.1.3.8-1: Single Entry PHR MAC CE

Table 6.1.3.8-1: Power Headroom levels for PHR

PH	Power Headroom Level
0	POWER_HEADROOM_0
1	POWER_HEADROOM_1
2	POWER_HEADROOM_2
3	POWER_HEADROOM_3
...	...
60	POWER_HEADROOM_60
61	POWER_HEADROOM_61
62	POWER_HEADROOM_62
63	POWER_HEADROOM_63

Table 6.1.3.8-2: Nominal UE transmit power level for PHR

$P_{CMAX,f,c}$	Nominal UE transmit power level
0	PCMAX_C_00
1	PCMAX_C_01
2	PCMAX_C_02
...	...
61	PCMAX_C_61
62	PCMAX_C_62
63	PCMAX_C_63

7.1.1.3.7.3 Test description

7.1.1.3.7.3.1 Pre-test conditions

Same Pre-test conditions as in clause 7.1.1.0 except that set to return no data in uplink.

7.1.1.3.7.3.2 Test procedure sequence

Table 7.1.1.3.7.3.2-1: Main behaviour

St	Procedure	Message Sequence		TP	Verdict
		U - S	Message		
1	The SS transmits UL grant to the UE at every 10ms in PDCCH occasion.	<--	-	-	-
2	SS transmits NR <i>RRCReconfiguration</i> message to configure specific Power Headroom parameters for NR Cell.(Note 1).	<--	(<i>RRCReconfiguration</i>)	-	-
3	Check: does the UE transmit a MAC PDU containing Power Headroom MAC Control Element? (Note 2, 5)	-->	MAC PDU	1	P
4	The UE transmits an NR <i>RRCReconfigurationComplete</i> message to confirm the setup of Power Headroom parameters. (Note 2,3)	-->	(<i>RRCReconfigurationComplete</i>)	-	-
5	Check: does the UE transmit a MAC PDU containing Power Headroom MAC Control Element 500ms after step 3? (Note 5)	-->	MAC PDU	2	P
6	The SS transmits an NR <i>RRCReconfiguration</i> message to disable Power Headroom reporting.(Note 1)	<--	(<i>RRCReconfiguration</i>)	-	-
7	The UE transmits an NR <i>RRCReconfigurationComplete</i> message to confirm the disabling of Power Headroom parameters.(Note 3)	-->	(<i>RRCReconfigurationComplete</i>)	-	-
8	Check: for 2 seconds, does the UE transmit a MAC PDU containing Power Headroom MAC Control Element? (Note 5)	-->	MAC PDU	3	F
9	SS transmits NR <i>RRCReconfiguration</i> message to configure specific Power Headroom parameters for NR Cell.(Note 1)	<--	(<i>RRCReconfiguration</i>)	-	-
10	Check: does the UE transmit a MAC PDU containing Power Headroom MAC Control Element? (Note 4, 5)	-->	MAC PDU	1	P
11	The UE transmits an NR <i>RRCReconfigurationComplete</i> message to confirm the setup of Power Headroom parameters. (Note 3,4)	-->	(<i>RRCReconfigurationComplete</i>)	-	-
12	Wait for T1= 20% of <i>prohibitPHR-Timer</i> .	-	-	-	-
13	Reduce SS power level for NR Cell so as to cause a DL_Pathloss change at UE by 5dB.	-	-	-	-
14	Check: for 80% of <i>prohibitPHR-Timer</i> since step 10, does the UE transmit a MAC PDU containing Power Headroom MAC Control Element? (Note 5)	-->	MAC PDU	4	F
15	Check: after <i>prohibitPHR-Timer</i> after step 10, does the UE transmit a MAC PDU containing Power Headroom MAC Control Element? (Note 5)	-->	MAC PDU	5	P
16	Increase SS power level for NR Cell so as to cause a DL_Pathloss change at UE by 5dB.	-	-	-	-
17	Check: for 80% of <i>prohibitPHR-Timer</i> since step 15, does the UE transmit a MAC PDU containing Power Headroom MAC Control Element? (Note 5)	-->	MAC PDU	4	F

18	Check: after <i>prohibitPHR-Timer</i> after step 15, does the UE transmit a MAC PDU containing Power Headroom MAC Control Element? (Note 5)	-->	MAC PDU	5	P
19	The SS transmits an NR <i>RRCReconfiguration</i> message to disable Power Headroom reporting.(Note 1)	<--	(<i>RRCReconfiguration</i>)	-	-
20	The UE transmits an NR <i>RRCReconfigurationComplete</i> message to confirm the disabling of Power Headroom parameters.(Note 3)	-->	(<i>RRCReconfigurationComplete</i>)	-	-
<p>Note 1: for EN-DC the NR <i>RRCReconfiguration</i> message is contained in <i>RRCConnectionReconfiguration</i> 36.508 [7], Table 4.6.1-8 using condition EN-DC_EmbedNR_RRCRecon.</p> <p>Note 2: Steps 3 and 4 can happen in any order.</p> <p>Note 3: for EN-DC the NR <i>RRCReconfigurationComplete</i> message is contained in <i>RRCConnectionReconfigurationComplete</i>.</p> <p>Note 4: Steps 10 and 11 can happen in any order.</p> <p>Note 5: For NR5GC the received MAC PDU will contain Single-entry PHR MAC CE. For MR-DC the received MAC PDU will contain Multiple-Entry PHR MAC CE.</p>					

7.1.1.3.7.3.3 Specific message contents

Table 7.1.1.3.7.3.3-1: RRCReconfiguration (step 2 Table 7.1.1.3.7.3.2-1)

Derivation Path: 38.508-1 [4], Table 4.6.1-13			
Information Element	Value/remark	Comment	Condition
RRCReconfiguration ::= SEQUENCE {			
criticalExtensions CHOICE {			
rrcReconfiguration SEQUENCE {			
secondaryCellGroup	CellGroupConfig	OCTET STRING (CONTAINING CellGroupConfig)	EN-DC
nonCriticalExtension SEQUENCE {			NR
masterCellGroup	CellGroupConfig	OCTET STRING (CONTAINING CellGroupConfig)	
}			
}			
}			
}			

Table 7.1.1.3.7.3.3-2: CellGroupConfig (Table 7.1.1.3.7.3.3-1)

Derivation Path: 38.508-1 [4], Table 4.6.3-19			
Information Element	Value/remark	Comment	Condition
cellGroupConfig ::= SEQUENCE {			
mac-CellGroupConfig SEQUENCE {			
phr-Config CHOICE {			
setup SEQUENCE {			
phr-PeriodicTimer	sf500		
phr-ProhibitTimer	sf1000		
phr-Tx-PowerFactorChange	infinity		
multiplePHR	false		
multiplePHR	true		MR-DC
phr-Type2PCell	false		
phr-Type2OtherCell	false		
phr-ModeOtherCG	real		
}			
}			
}			
}			

Table 7.1.1.3.7.3.3-3: RRCReconfiguration (step 6,19 Table 7.1.1.3.7.3.2-1)

Derivation Path: 38.508-1 [4], Table 4.6.1-13			
Information Element	Value/remark	Comment	Condition
RRCReconfiguration ::= SEQUENCE {			
criticalExtensions CHOICE {			
rrcReconfiguration SEQUENCE {			
secondaryCellGroup	CellGroupConfig	OCTET STRING (CONTAINING CellGroupConfig)	EN-DC
nonCriticalExtension SEQUENCE {			NR
masterCellGroup	CellGroupConfig	OCTET STRING (CONTAINING CellGroupConfig)	
}			
}			
}			
}			

Table 7.1.1.3.7.3.3-4: CellGroupConfig (Table 7.1.1.3.7.3.3-3)

Derivation Path: 38.508-1 [4], Table 4.6.3-19			
Information Element	Value/remark	Comment	Condition
cellGroupConfig ::= SEQUENCE {			
mac-CellGroupConfig SEQUENCE {			
phr-Config CHOICE {			
release	NULL		
}			
}			
}			

Table 7.1.1.3.7.3.3-5: RRCReconfiguration (step 9 Table 7.1.1.3.7.3.2-1)

Derivation Path: 38.508-1 [4], Table 4.6.1-13			
Information Element	Value/remark	Comment	Condition
RRCReconfiguration ::= SEQUENCE {			
criticalExtensions CHOICE {			
rrcReconfiguration SEQUENCE {			
secondaryCellGroup	CellGroupConfig	OCTET STRING (CONTAINING CellGroupConfig)	EN-DC
nonCriticalExtension SEQUENCE {			NR
masterCellGroup	CellGroupConfig	OCTET STRING (CONTAINING CellGroupConfig)	
}			
}			
}			
}			

Table 7.1.1.3.7.3.3-6: CellGroupConfig (Table 7.1.1.3.7.3.3-5)

Derivation Path: 38.508-1 [4], Table 4.6.3-19			
Information Element	Value/remark	Comment	Condition
cellGroupConfig ::= SEQUENCE {			
mac-CellGroupConfig SEQUENCE {			
phr-Config CHOICE {			
setup SEQUENCE {			
phr-PeriodicTimer	infinity		
phr-ProhibitTimer	sf1000		
phr-Tx-PowerFactorChange	3dB		
multiplePHR	false		
multiplePHR	true		MR-DC
phr-Type2PCell	false		
phr-Type2OtherCell	false		
phr-ModeOtherCG	real		
}			
}			
}			
}			

7.1.1.3.8 UE power headroom reporting / SCell activation / DL pathloss change reporting

7.1.1.3.8.1 UE power headroom reporting / SCell activation / DL pathloss change reporting/ Intra-band Contiguous CA

7.1.1.3.8.1.1 Test Purpose (TP)

(1)

```
with { UE in RRC_Connected state with multiple Power headroom reporting and an SCell with uplink is
configured }
ensure that {
  when { UE receives an Activation MAC Control Element activating the SCell }
  then { UE transmits a MAC PDU containing Power Headroom Report MAC Control Element including PH
type1 for SpCell and SCell }
}
```

(2)

```
with { UE in RRC_Connected state with multiple Power headroom reporting for phr-dl-PathlossChange
configured }
ensure that {
  when { the DL Pathloss changes and phr-ProhibitTimer is running }
  then { UE does not transmit a MAC PDU containing Power Headroom Report MAC Control Element
including PH type1 for SpCell and SCell }
}
```

(3)

```
with { UE in RRC_Connected state with Power headroom reporting for phr-dl-PathlossChange configured
}
ensure that {
  when { phr-ProhibitTimer expires and power headroom report is triggered due to DL Pathloss change
}
  then { UE transmits a MAC PDU containing Power Headroom Report MAC Control Element including PH
type1 for SpCell and SCell }
}
```

7.1.1.3.8.1.2 Conformance requirements

References: The conformance requirements covered in the current TC are specified in: TS 38.321 clause 5.4.6 and 6.1.3.8. Unless otherwise stated these are Rel-15 requirements.

[TS 38.321, clause 5.4.6]

The Power Headroom reporting procedure is used to provide the serving gNB with the following information:

- Type 1 power headroom: the difference between the nominal UE maximum transmit power and the estimated power for UL-SCH transmission per activated Serving Cell;
- Type 2 power headroom: the difference between the nominal UE maximum transmit power and the estimated power for UL-SCH and PUCCH transmission on SpCell of the other MAC entity (i.e. E-UTRA MAC entity in EN-DC, NE-DC, and NGEN-DC cases);
- Type 3 power headroom: the difference between the nominal UE maximum transmit power and the estimated power for SRS transmission per activated Serving Cell.

RRC controls Power Headroom reporting by configuring the following parameters:

- *phr-PeriodicTimer*;
- *phr-ProhibitTimer*;
- *phr-Tx-PowerFactorChange*;
- *phr-Type2OtherCell*;
- *phr-ModeOtherCG*;
- *multiplePHR*.

A Power Headroom Report (PHR) shall be triggered if any of the following events occur:

- *phr-ProhibitTimer* expires or has expired and the path loss has changed more than *phr-Tx-PowerFactorChange* dB for at least one activated Serving Cell of any MAC entity which is used as a pathloss reference since the last transmission of a PHR in this MAC entity when the MAC entity has UL resources for new transmission;

NOTE 1: The path loss variation for one cell assessed above is between the pathloss measured at present time on the current pathloss reference and the pathloss measured at the transmission time of the last transmission of PHR on the pathloss reference in use at that time, irrespective of whether the pathloss reference has changed in between.

- *phr-PeriodicTimer* expires;
- upon configuration or reconfiguration of the power headroom reporting functionality by upper layers, which is not used to disable the function;
- activation of an SCell of any MAC entity with configured uplink;
- addition of the PSCell (i.e. PSCell is newly added or changed);
- *phr-ProhibitTimer* expires or has expired, when the MAC entity has UL resources for new transmission, and the following is true for any of the activated Serving Cells of any MAC entity with configured uplink:
 - there are UL resources allocated for transmission or there is a PUCCH transmission on this cell, and the required power backoff due to power management (as allowed by $P\text{-MPR}_c$ as specified in TS 38.101-1 [14], TS 38.101-2 [15], and TS 38.101-3 [16]) for this cell has changed more than *phr-Tx-PowerFactorChange* dB since the last transmission of a PHR when the MAC entity had UL resources allocated for transmission or PUCCH transmission on this cell.

NOTE 2: The MAC entity should avoid triggering a PHR when the required power backoff due to power management decreases only temporarily (e.g. for up to a few tens of milliseconds) and it should avoid reflecting such temporary decrease in the values of $P_{\text{CMAX},f,c}/\text{PH}$ when a PHR is triggered by other triggering conditions.

If the MAC entity has UL resources allocated for a new transmission the MAC entity shall:

- 1> if it is the first UL resource allocated for a new transmission since the last MAC reset:
 - 2> start *phr-PeriodicTimer*;

- 1> if the Power Headroom reporting procedure determines that at least one PHR has been triggered and not cancelled; and
- 1> if the allocated UL resources can accommodate the MAC CE for PHR which the MAC entity is configured to transmit, plus its subheader, as a result of LCP as defined in clause 5.4.3.1:
 - 2> if *multiplePHR* with value *true* is configured:
 - 3> for each activated Serving Cell with configured uplink associated with any MAC entity:
 - 4> obtain the value of the Type 1 or Type 3 power headroom for the corresponding uplink carrier as specified in clause 7.7 of TS 38.213 [6] for NR Serving Cell and clause 5.1.1.2 of TS 36.213 [17] for E-UTRA Serving Cell;
 - 4> if this MAC entity has UL resources allocated for transmission on this Serving Cell; or
 - 4> if the other MAC entity, if configured, has UL resources allocated for transmission on this Serving Cell and *phr-ModeOtherCG* is set to *real* by upper layers:
 - 5> obtain the value for the corresponding $P_{\text{CMAX},f,c}$ field from the physical layer.
 - 3> if *phr-Type2OtherCell* with value *true* is configured:
 - 4> if the other MAC entity is E-UTRA MAC entity:
 - 5> obtain the value of the Type 2 power headroom for the SpCell of the other MAC entity (i.e. E-UTRA MAC entity);
 - 5> if *phr-ModeOtherCG* is set to *real* by upper layers:
 - 6> obtain the value for the corresponding $P_{\text{CMAX},f,c}$ field for the SpCell of the other MAC entity (i.e. E-UTRA MAC entity) from the physical layer.
 - 3> instruct the Multiplexing and Assembly procedure to generate and transmit the Multiple Entry PHR MAC CE as defined in clause 6.1.3.9 based on the values reported by the physical layer.
 - 2> else (i.e. Single Entry PHR format is used):
 - 3> obtain the value of the Type 1 power headroom from the physical layer for the corresponding uplink carrier of the PCell;
 - 3> obtain the value for the corresponding $P_{\text{CMAX},f,c}$ field from the physical layer;
 - 3> instruct the Multiplexing and Assembly procedure to generate and transmit the Single Entry PHR MAC CE as defined in clause 6.1.3.8 based on the values reported by the physical layer.
 - 2> start or restart *phr-PeriodicTimer*;
 - 2> start or restart *phr-ProhibitTimer*;
 - 2> cancel all triggered PHR(s).

[TS 38.321, clause 6.1.3.9]

The Multiple Entry PHR MAC CE is identified by a MAC subheader with LCID as specified in Table 6.2.1-2.

It has a variable size, and includes the bitmap, a Type 2 PH field and an octet containing the associated $P_{\text{CMAX},f,c}$ field (if reported) for SpCell of the other MAC entity, a Type 1 PH field and an octet containing the associated $P_{\text{CMAX},f,c}$ field (if reported) for the PCell. It further includes, in ascending order based on the *ServCellIndex*, one or multiple of Type X PH fields and octets containing the associated $P_{\text{CMAX},f,c}$ fields (if reported) for Serving Cells other than PCell indicated in the bitmap. X is either 1 or 3 according to TS 38.213 [6] and TS 36.213 [17].

The presence of Type 2 PH field for SpCell of the other MAC entity is configured by *phr-Type2OtherCell* with value *true*.

A single octet bitmap is used for indicating the presence of PH per Serving Cell when the highest *ServCellIndex* of Serving Cell with configured uplink is less than 8, otherwise four octets are used.

The MAC entity determines whether PH value for an activated Serving Cell is based on real transmission or a reference format by considering the configured grant(s) and downlink control information which has been received until and including the PDCCH occasion in which the first UL grant for a new transmission that can accommodate the MAC CE for PHR as a result of LCP as defined in clause 5.4.3.1 is received since a PHR has been triggered if the PHR MAC CE is reported on an uplink grant received on the PDCCH or until the first uplink symbol of PUSCH transmission minus PUSCH preparation time as defined in clause 7.7 of TS 38.213 [6] if the PHR MAC CE is reported on a configured grant.

For a band combination in which the UE does not support dynamic power sharing, the UE may omit the octets containing Power Headroom field and $P_{\text{CMAX},f,c}$ field for Serving Cells in the other MAC entity except for the PCell in the other MAC entity and the reported values of Power Headroom and $P_{\text{CMAX},f,c}$ for the PCell are up to UE implementation.

The PHR MAC CEs are defined as follows:

- C_i : This field indicates the presence of a PH field for the Serving Cell with *ServCellIndex* i as specified in TS 38.331 [5]. The C_i field set to 1 indicates that a PH field for the Serving Cell with *ServCellIndex* i is reported. The C_i field set to 0 indicates that a PH field for the Serving Cell with *ServCellIndex* i is not reported;
- R: Reserved bit, set to 0;
- V: This field indicates if the PH value is based on a real transmission or a reference format. For Type 1 PH, the V field set to 0 indicates real transmission on PUSCH and the V field set to 1 indicates that a PUSCH reference format is used. For Type 2 PH, the V field set to 0 indicates real transmission on PUCCH and the V field set to 1 indicates that a PUCCH reference format is used. For Type 3 PH, the V field set to 0 indicates real transmission on SRS and the V field set to 1 indicates that an SRS reference format is used. Furthermore, for Type 1, Type 2, and Type 3 PH, the V field set to 0 indicates the presence of the octet containing the associated $P_{\text{CMAX},f,c}$ field, and the V field set to 1 indicates that the octet containing the associated $P_{\text{CMAX},f,c}$ field is omitted;
- Power Headroom (PH): This field indicates the power headroom level. The length of the field is 6 bits. The reported PH and the corresponding power headroom levels are shown in Table 6.1.3.8-1 (the corresponding measured values in dB for the NR Serving Cell are specified in TS 38.133 [11] while the corresponding measured values in dB for the E-UTRA Serving Cell are specified in TS 36.133 [12]);
- P: This field indicates whether the MAC entity applies power backoff due to power management (as allowed by $P\text{-MPR}_c$ as specified in TS 38.101-1 [14], TS 38.101-2 [15], and TS 38.101-3 [16]). The MAC entity shall set the P field to 1 if the corresponding $P_{\text{CMAX},f,c}$ field would have had a different value if no power backoff due to power management had been applied;
- $P_{\text{CMAX},f,c}$: If present, this field indicates the $P_{\text{CMAX},f,c}$ (as specified in TS 38.213 [6]) for the NR Serving Cell and the $P_{\text{CMAX},c}$ or $\tilde{P}_{\text{CMAX},c}$ (as specified in TS 36.213 [17]) for the E-UTRA Serving Cell used for calculation of the preceding PH field. The reported $P_{\text{CMAX},f,c}$ and the corresponding nominal UE transmit power levels are shown in Table 6.1.3.8-2 (the corresponding measured values in dBm for the NR Serving Cell are specified in TS 38.133 [11] while the corresponding measured values in dBm for the E-UTRA Serving Cell are specified in TS 36.133 [12]).

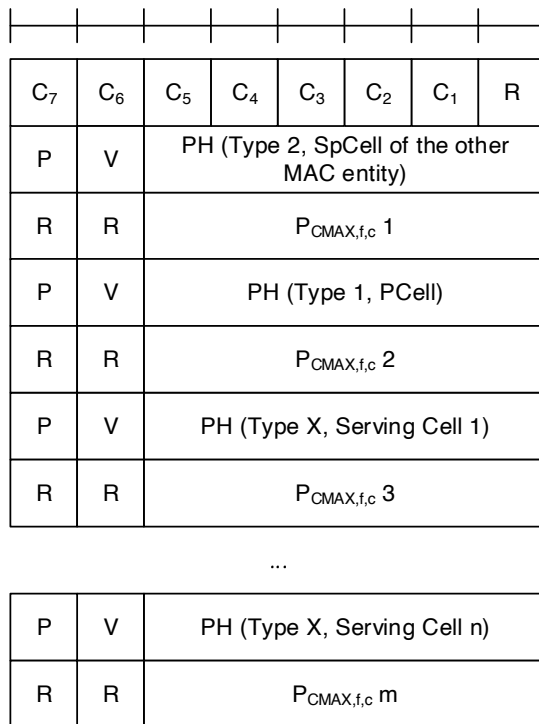

Figure 6.1.3.9-1: Multiple Entry PHR MAC CE with the highest *ServCellIndex* of Serving Cell with configured uplink is less than 8

7.1.1.3.8.1.3 Test description

7.1.1.3.8.1.3.1 Pre-test conditions

Same Pre-test conditions as in clause 7.1.1.0 except that Test loop function(*Off*) System information combination NR-4 and in addition NR Cell 3 is configured as NR Active Scell.

7.1.1.3.8.1.3.2 Test procedure sequence

Table 7.1.1.3.8.1.3.2-0: Cell configuration power level changes over time for FR1

	Parameter	Unit	NR Cell 1	NR Cell 3	Remarks
T0	Cell-specific RS EPRE	dBm/SC S	-88	-88	
T1	Cell-specific RS EPRE	dBm/SC S	-99	-88	
T2	Cell-specific RS EPRE	dBm/SC S	-88	-88	
T3	Cell-specific RS EPRE	dBm/SC S	-88	-99	
T4	Cell-specific RS EPRE	dBm/SC S	-88	-88	

Table 7.1.1.3.8.1.3.2-0A: Cell configuration power level changes over time for FR2

	Parameter	Unit	NR Cell 1	NR Cell 3	Remarks
T0	Cell-specific RS EPRE	dBm/SCS	-82	-82	
T1	Cell-specific RS EPRE	dBm/SCS	-91	-82	
T2	Cell-specific RS EPRE	dBm/SCS	-82	-82	
T3	Cell-specific RS EPRE	dBm/SCS	-82	-91	
T4	Cell-specific RS EPRE	dBm/SCS	-82	-82	

Table 7.1.1.3.8.1.3.2-1: Main behaviour

St	Procedure	Message Sequence		TP	Verdict
		U - S	Message		
1	SS transmits an RRCReconfiguration message to configure SCell (NR Cell 3). Note 1	<--	RRCReconfiguration	-	-
2	The UE transmits RRCReconfigurationComplete message. Note 2	-->	RRCReconfigurationComplete	-	-
3	The SS is configured for Uplink Grant Allocation Type 2. SS is configured to transmit UL grant for UE at every 10 ms.	-	-	-	-
4	SS transmits an RRCReconfiguration message to provide Power Headroom parameters. Note 1	<--	RRCReconfiguration	-	-
	EXCEPTION: In parallel with step 5, UE executes parallel behaviour defined in Table 7.1.1.3.8.1.3.2-2	-	-	-	-
5	The UE transmits RRCReconfigurationComplete message to confirm the setup of Power Headroom parameters. Note 2	-->	RRCReconfigurationComplete	-	-
6	The SS transmits an Activation MAC control element to activate SCell.	<--	MAC PDU (SCell Activation/Deactivation MAC CE of one octet (C ₁ =1))	-	-
7	Check: Does the UE transmit a MAC PDU containing Multiple Entry PHR MAC CE containing Type 2 PH of NR SpCell and Scell? Note 3	-->	MAC PDU	1	P
8	Void	-	-	-	-
9	SS adjusts cell levels according to row T1 of Table 7.1.1.3.8.3.1.2-0/0A.	-	-	-	-
10	Check: For 80% of <i>prohibitPHR-Timer</i> since step 7, does the UE transmit a MAC PDU containing Multiple Entry PHR MAC CE?	-->	MAC PDU	2	F
11	Check: After <i>prohibitPHR-Timer</i> after step 7, does the UE transmit a MAC PDU containing Multiple Entry PHR MAC CE containing Type 2 PH of NR SpCell and Scell? Note 3	-->	MAC PDU	3	P
12	SS adjusts cell levels according to row T2 of Table 7.1.1.3.8.1.3.2-0/0A.	-	-	-	-
13	Check: For 80% of <i>prohibitPHR-Timer</i> since step 11, does the UE transmit a MAC PDU containing Multiple Entry PHR MAC CE ?	-->	MAC PDU	2	F
14	Check: After <i>prohibitPHR-Timer</i> after step 11, does the UE transmit a MAC PDU containing Multiple Entry PHR MAC CE containing Type 2 PH of NR SpCell and Scell? Note 3	-->	MAC PDU	3	P
15	SS adjusts cell levels according to row T3 of Table 7.1.1.3.8.1.3.2-0/0A.	-	-	-	-
16	Check: For 80% of <i>prohibitPHR-Timer</i> since step 14, does the UE transmit a MAC PDU containing Multiple Entry PHR MAC CE containing?	-->	MAC PDU	2	F
17	Check: After <i>prohibitPHR-Timer</i> after step 14, does the UE transmit a MAC PDU containing Multiple Entry PHR MAC CE containing Type 2 PH of NR SpCell and Scell? Note 3	-->	MAC PDU	3	P
18	SS adjusts cell levels according to row T4 of Table 7.1.1.3.8.1.3.2-0/0A.	-	-	-	-
19	Check: For 80% of <i>prohibitPHR-Timer</i> since step 17, does the UE transmit a MAC PDU containing Multiple Entry PHR MAC CE?	-->	MAC PDU	2	F
20	Check: After <i>prohibitPHR-Timer</i> after step 17, does the UE transmit a MAC PDU containing Multiple Entry PHR MAC CE containing Type 2 PH of NR SpCell and Scell? Note 3	-->	MAC PDU	3	P

21	The SS transmits an NR <i>RRCReconfiguration</i> message to disable Power Headroom reporting. (Note 1)	<--	(<i>RRCReconfiguration</i>)	-	-
22	The UE transmits an NR <i>RRCReconfigurationComplete</i> message to confirm the disabling of Power Headroom parameters. (Note 3)	-->	(<i>RRCReconfigurationComplete</i>)	-	-
<p>Note 1: For EN-DC the NR <i>RRCReconfiguration</i> message is contained in <i>RRCConnectionReconfiguration</i>.</p> <p>Note 2: For EN-DC the NR <i>RRCReconfigurationComplete</i> message is contained in <i>RRCConnectionReconfigurationComplete</i>.</p> <p>Note 3: For EN-DC the Type 1 PHR report for EUTRA Pcell is also included.</p>					

Table 7.1.1.3.8.1.3.2-2: Parallel behaviour

St	Procedure	Message Sequence		TP	Verdict
		U - S	Message		
1	The UE transmits a MAC PDU containing Multiple Entry PHR MAC CE containing Type 2 PH of NR SpCell.	-->	MAC PDU	-	-

7.1.1.3.8.1.3.3 Specific message contents

Table 7.1.1.3.8.1.3.3-1: *RRCReconfiguration* (step 1, Table 7.1.1.3.8.1.3.2-1)

Derivation Path: TS 38.508-1 [4], Table 4.6.1-13.			
Information Element	Value/remark	Comment	Condition
<i>RRCReconfiguration</i> ::= SEQUENCE {			
criticalExtensions CHOICE {			
c1 CHOICE {			
<i>rrcReconfiguration</i> ::= SEQUENCE {			
secondaryCellGroup	CellGroupConfig	OCTET STRING (CONTAINING CellGroupConfig)	EN-DC
nonCriticalExtension SEQUENCE {			NR
masterCellGroup	CellGroupConfig	OCTET STRING (CONTAINING CellGroupConfig)	
}			
}			
}			
}			

Table 7.1.1.3.8.1.3.3-2: CellGroupConfig (Table 7.1.1.3.8.1.3.3-1)

Derivation Path: TS 38.508-1 [4], Table 4.6.3-19.			
Information Element	Value/remark	Comment	Condition
CellGroupConfig ::= SEQUENCE {			
sCellToAddModList SEQUENCE (SIZE (1..maxMeasId)) OF SCellConfig {	1 entry		
SCellConfig[1] SEQUENCE {		entry 1	
sCellIndex	SCellIndex as per TS 38.508-1 [4] table 4.6.3-154		
sCellConfigCommon	ServingCellConfigCommon		
sCellConfigDedicated	ServingCellConfig		
}			
}			

Table 7.1.1.3.8.1.3.3-3: ServingCellConfigCommon (Table 7.1.1.3.8.1.3.3-2)

Derivation Path: TS 38.508-1 [4], Table 4.6.3-168.			
Information Element	Value/remark	Comment	Condition
ServingCellConfigCommon ::= SEQUENCE {			
physCellId	Physical Cell Identity of NR Cell 3		
}			

Table 7.1.1.3.8.1.3.3-3A: Void**Table 7.1.1.3.8.1.3.3-4: RRCReconfiguration (Step 4, Table 7.1.1.3.8.1.3.2-1)**

Derivation Path: 38.508-1 [4], Table 4.6.1-13			
Information Element	Value/remark	Comment	Condition
RRCReconfiguration ::= SEQUENCE {			
criticalExtensions CHOICE {			
rrcReconfiguration SEQUENCE {			
secondaryCellGroup	CellGroupConfig	OCTET STRING (CONTAINING CellGroupConfig)	EN-DC
nonCriticalExtension SEQUENCE {			NR
masterCellGroup	CellGroupConfig	OCTET STRING (CONTAINING CellGroupConfig)	
}			
}			
}			

Table 7.1.1.3.8.1.3.3-5: CellGroupConfig (Table 7.1.1.3.8.1.3.3-4)

Derivation Path: 38.508-1 [4], Table 4.6.3-19			
Information Element	Value/remark	Comment	Condition
CellGroupConfig ::= SEQUENCE {			
cellGroupId	CellGroupId as per TS 38.508-1 [4] table 4.6.3-20		
mac-CellGroupConfig SEQUENCE {			
phr-Config CHOICE {			
setup SEQUENCE {			
phr-PeriodicTimer	infinity		
phr-ProhibitTimer	sf1000		
phr-Tx-PowerFactorChange	infinity		
multiplePHR	true		
dummy	true		
phr-Type2OtherCell	false		
phr-ModeOtherCG	real		
}			
}			
}			

7.1.1.3.8.2 UE power headroom reporting / SCell activation / DL pathloss change reporting / Inter-Band CA

The scope and description of the present TC is the same as test case 7.1.1.3.8.1 with the following differences:

- CA configuration: Inter-band CA replaces Intra-band Contiguous CA

- Cells configuration: NR Cell 10 replaces NR Cell 3

7.1.1.3.8.3 UE power headroom reporting / SCell activation / DL pathloss change reporting / Intra-band non-Contiguous CA

The scope and description of the present TC is the same as test case 7.1.1.3.8.1 with the following differences:

- CA configuration: Intra-band non-Contiguous CA replaces Intra-band Contiguous CA.

7.1.1.3.9 Correct Handling of UL HARQ process / PUSCH Aggregation

7.1.1.3.9.1 Test Purpose (TP)

(1)

```
with { UE in RRC_CONNECTED state and PUSCH Aggregation > 1 }
ensure that {
  when { UE receives an UL Grant with toggled NDI and has data available for transmission }
  then { UE transmits a new MAC PDU and repeats the MAC PDU in pusch-AggregationFactor-1 times
after first transmission and selects the redundancy version correctly }
}
```

7.1.1.3.9.2 Conformance requirements

References: The conformance requirements covered in the present TC are specified in: TS 38.214 clauses 6.1.2.1 and 6.1.4, TS 38.321 clauses 5.4.1, 5.4.2.1 and 5.4.2.2. Unless otherwise stated these are Rel-15 requirements.

[TS 38.214, clause 6.1.2.1]

When the UE is scheduled to transmit a transport block and no CSI report, or the UE is scheduled to transmit a transport block and a CSI report on PUSCH by a DCI, the *Time domain resource assignment* field value m of the DCI provides a row index $m + 1$ to an allocated table. The determination of the used resource allocation table is defined in sub-clause 6.1.2.1.1. The indexed row defines the slot offset K_2 , the start and length indicator *SLIV*, or directly the start symbol S and the allocation length L , and the PUSCH mapping type to be applied in the PUSCH transmission.

When the UE is scheduled to transmit a PUSCH with no transport block and with a CSI report by a *CSI request* field on a DCI, the *Time-domain resource assignment* field value m of the DCI provides a row index $m + 1$ to an allocated table. The determination of the applied resource allocation table is defined in sub-clause 6.1.2.1.1. The indexed row defines the start and length indicator *SLIV*, or directly the start symbol S and the allocation length L , and the PUSCH mapping type to be applied in the PUSCH transmission and K_2 is determined based on the corresponding list entries $Y_j, j = 0, \dots, N_{\text{Rep}} - 1$ of the higher layer parameter *reportSlotConfig* in *CSI-ReportConfig* for the N_{Rep} triggered CSI Reporting Settings. The i th codepoint of K_2 is determined as $K_2 = \max_j Y_j(i)$ where $Y_j(i)$ is the i th codepoint of Y_j .

- The slot where the UE shall transmit the PUSCH is determined by K_2 as $\left\lceil n \cdot \frac{2^{\mu_{\text{PUSCH}}}}{2^{\mu_{\text{PDCCH}}}} \right\rceil + K_2$ where n is the slot with the scheduling DCI, K_2 is based on the numerology of PUSCH, and μ_{PUSCH} and μ_{PDCCH} are the subcarrier spacing configurations for PUSCH and PDCCH, respectively, and
- The starting symbol S relative to the start of the slot, and the number of consecutive symbols L counting from the symbol S allocated for the PUSCH are determined from the start and length indicator *SLIV* of the indexed row:

if $(L-1) \leq 7$ then

$$SLIV = 14 \cdot (L-1) + S$$

else

$$SLIV = 14 \cdot (14-L+1) + (14-1-S)$$

where $0 < L \leq 14 - S$, and

- The PUSCH mapping type is set to Type A or Type B as defined in Subclause 6.4.1.1.3 of [4, TS 38.211] as given by the indexed row.

The UE shall consider the S and L combinations defined in table 6.1.2.1-1 as valid PUSCH allocations

Table 6.1.2.1-1: Valid S and L combinations

PUSCH mapping type	Normal cyclic prefix			Extended cyclic prefix		
	S	L	$S+L$	S	L	$S+L$
Type A	0	{4,...,14}	{4,...,14}	0	{4,...,12}	{4,...,12}
Type B	{0,...,13}	{1,...,14}	{1,...,14}	{0,...,12}	{1,...,12}	{1,...,12}

When the UE is configured with $aggregationFactorUL > 1$, the same symbol allocation is applied across the $aggregationFactorUL$ consecutive slots and the PUSCH is limited to a single transmission layer. The UE shall repeat the TB across the $aggregationFactorUL$ consecutive slots applying the same symbol allocation in each slot. The redundancy version to be applied on the n^{th} transmission occasion of the TB is determined according to table 6.1.2.1-2.

Table 6.1.2.1-2: Redundancy version when $aggregationFactorUL > 1$

rv_{id} indicated by the DCI scheduling the PUSCH	rv_{id} to be applied to n^{th} transmission occasion			
	$n \bmod 4 = 0$	$n \bmod 4 = 1$	$n \bmod 4 = 2$	$n \bmod 4 = 3$
0	0	2	3	1
2	2	3	1	0
3	3	1	0	2
1	1	0	2	3

If the UE procedure for determining slot configuration, as defined in subclause 11.1 of [6, TS 38.213], determines symbols of a slot allocated for PUSCH as downlink symbols, the transmission on that slot is omitted for multi-slot PUSCH transmission.

[TS 38.214, clause 6.1.4]

To determine the modulation order, target code rate, redundancy version and transport block size for the physical uplink shared channel, the UE shall first

- read the 5-bit modulation and coding scheme field (I_{MCS}) in the DCI to determine the modulation order (O_m) and target code rate (R) based on the procedure defined in Subclause 6.1.4.1
- read redundancy version field (rv) in the DCI to determine the redundancy version, and
- [check the "CSI request" bit field]

and second

- the UE shall use the number of layers (ν), the total number of allocated PRBs (n_{PRB}) to determine the transport block size based on the procedure defined in Subclause 6.1.4.2.

[TS 38.321, clause 5.4.1]

Uplink grant is either received dynamically on the PDCCH, in a Random Access Response, or configured semi-persistently by RRC. The MAC entity shall have an uplink grant to transmit on the UL-SCH. To perform the requested transmissions, the MAC layer receives HARQ information from lower layers.

If the MAC entity has a C-RNTI, a Temporary C-RNTI, or CS-RNTI, the MAC entity shall for each PDCCH occasion and for each Serving Cell belonging to a TAG that has a running *timeAlignmentTimer* and for each grant received for this PDCCH occasion:

- 1> if an uplink grant for this Serving Cell has been received on the PDCCH for the MAC entity's C-RNTI or Temporary C-RNTI; or
- 1> if an uplink grant has been received in a Random Access Response:

- 2> if the uplink grant is for MAC entity's C-RNTI and if the previous uplink grant delivered to the HARQ entity for the same HARQ process was either an uplink grant received for the MAC entity's CS-RNTI or a configured uplink grant:
 - 3> consider the NDI to have been toggled for the corresponding HARQ process regardless of the value of the NDI.
- 2> if the uplink grant is for MAC entity's C-RNTI, and the identified HARQ process is configured for a configured uplink grant:
 - 3> start or restart the *configuredGrantTimer* for the corresponding HARQ process, if configured.
- 2> deliver the uplink grant and the associated HARQ information to the HARQ entity.
- 1> else if an uplink grant for this PDCCH occasion has been received for this Serving Cell on the PDCCH for the MAC entity's CS-RNTI:
 - 2> if the NDI in the received HARQ information is 1:
 - 3> consider the NDI for the corresponding HARQ process not to have been toggled;
 - 3> start or restart the *configuredGrantTimer* for the corresponding HARQ process, if configured;
 - 3> deliver the uplink grant and the associated HARQ information to the HARQ entity.
 - 2> else if the NDI in the received HARQ information is 0:
 - 3> if PDCCH contents indicate configured grant Type 2 deactivation:
 - 4> trigger configured uplink grant confirmation.
 - 3> else if PDCCH contents indicate configured grant Type 2 activation:
 - 4> trigger configured uplink grant confirmation;
 - 4> store the uplink grant for this Serving Cell and the associated HARQ information as configured uplink grant;
 - 4> initialise or re-initialise the configured uplink grant for this Serving Cell to start in the associated PUSCH duration and to recur according to rules in subclause 5.8.2;
 - 4> set the HARQ Process ID to the HARQ Process ID associated with this PUSCH duration;
 - 4> consider the NDI bit for the corresponding HARQ process to have been toggled;
 - 4> stop the *configuredGrantTimer* for the corresponding HARQ process, if running;
 - 4> deliver the configured uplink grant and the associated HARQ information to the HARQ entity.

For each Serving Cell and each configured uplink grant, if configured and activated, the MAC entity shall:

- 1> if the PUSCH duration of the configured uplink grant does not overlap with the PUSCH duration of an uplink grant received on the PDCCH for this Serving Cell:
 - 2> set the HARQ Process ID to the HARQ Process ID associated with this PUSCH duration;
- 2> if the *configuredGrantTimer* for the corresponding HARQ process is not running:
 - 3> consider the NDI bit for the corresponding HARQ process to have been toggled;
 - 3> deliver the configured uplink grant and the associated HARQ information to the HARQ entity.

For configured uplink grants, the HARQ Process ID associated with the first symbol of a UL transmission is derived from the following equation:

$$\text{HARQ Process ID} = [\text{floor}(\text{CURRENT_symbol}/\text{periodicity})] \text{ modulo } n_{\text{rofHARQ-Processes}}$$

where $CURRENT_symbol = (SFN \times numberOfSlotsPerFrame \times numberOfSymbolsPerSlot + slot\ number\ in\ the\ frame \times numberOfSymbolsPerSlot + symbol\ number\ in\ the\ slot)$, and *numberOfSlotsPerFrame* and *numberOfSymbolsPerSlot* refer to the number of consecutive slots per frame and the number of consecutive symbols per slot, respectively as specified in TS 38.211 [8].

NOTE 1: *CURRENT_symbol* refers to the symbol index of the first transmission occasion of a repetition bundle that takes place.

NOTE 2: A HARQ process is configured for a configured uplink grant if the configured uplink grant is activated and the associated HARQ process ID is less than *nrofHARQ-Processes*.

[TS 38.321, clause 5.4.2.1]

The MAC entity includes a HARQ entity for each Serving Cell with configured uplink (including the case when it is configured with *supplementaryUplink*), which maintains a number of parallel HARQ processes.

The number of parallel UL HARQ processes per HARQ entity is specified in TS 38.214 [7].

Each HARQ process supports one TB.

Each HARQ process is associated with a HARQ process identifier. For UL transmission with UL grant in RA Response, HARQ process identifier 0 is used.

When the MAC entity is configured with *pusch-AggregationFactor* > 1, the parameter *pusch-AggregationFactor* provides the number of transmissions of a TB within a bundle of the dynamic grant. After the initial transmission, *pusch-AggregationFactor* – 1 HARQ retransmissions follow within a bundle. When the MAC entity is configured with *repK* > 1, the parameter *repK* provides the number of transmissions of a TB within a bundle of the configured uplink grant. After the initial transmission, HARQ retransmissions follow within a bundle. For both dynamic grant and configured uplink grant, bundling operation relies on the HARQ entity for invoking the same HARQ process for each transmission that is part of the same bundle. Within a bundle, HARQ retransmissions are triggered without waiting for feedback from previous transmission according to *pusch-AggregationFactor* for a dynamic grant and *repK* for a configured uplink grant, respectively. Each transmission within a bundle is a separate uplink grant after the initial uplink grant within a bundle is delivered to the HARQ entity.

For each transmission within a bundle of the dynamic grant, the sequence of redundancy versions is determined according to subclause 6.1.4 of TS 38.214 [7]. For each transmission within a bundle of the configured uplink grant, the sequence of redundancy versions is determined according to subclause 6.1.2.3 of TS 38.214 [7].

For each uplink grant, the HARQ entity shall:

- 1> identify the HARQ process associated with this grant, and for each identified HARQ process:
 - 2> if the received grant was not addressed to a Temporary C-RNTI on PDCCH, and the NDI provided in the associated HARQ information has been toggled compared to the value in the previous transmission of this TB of this HARQ process; or
 - 2> if the uplink grant was received on PDCCH for the C-RNTI and the HARQ buffer of the identified process is empty; or
 - 2> if the uplink grant was received in a Random Access Response; or
 - 2> if the uplink grant is part of a bundle of the configured uplink grant, and may be used for initial transmission according to subclause 6.1.2.3 of TS 38.214 [7], and if no MAC PDU has been obtained for this bundle:
 - 3> if there is a MAC PDU in the Msg3 buffer and the uplink grant was received in a Random Access Response:
 - 4> obtain the MAC PDU to transmit from the Msg3 buffer.
 - 3> else:
 - 4> obtain the MAC PDU to transmit from the Multiplexing and assembly entity, if any;
 - 3> if a MAC PDU to transmit has been obtained:

- 4> deliver the MAC PDU and the uplink grant and the HARQ information of the TB to the identified HARQ process;
- 4> instruct the identified HARQ process to trigger a new transmission;
- 4> if the uplink grant is addressed to CS-RNTI; or
- 4> if the uplink grant is a configured uplink grant; or
- 4> if the uplink grant is addressed to C-RNTI, and the identified HARQ process is configured for a configured uplink grant:
 - 5> start or restart the *configuredGrantTimer*, if configured, for the corresponding HARQ process when the transmission is performed.
- 3> else:
 - 4> flush the HARQ buffer of the identified HARQ process.
- 2> else (i.e. retransmission):
 - 3> if the uplink grant received on PDCCH was addressed to CS-RNTI and if the HARQ buffer of the identified process is empty; or
 - 3> if the uplink grant is part of a bundle and if no MAC PDU has been obtained for this bundle; or
 - 3> if the uplink grant is part of a bundle of the configured uplink grant, and the PUSCH of the uplink grant overlaps with a PUSCH of another uplink grant received on the PDCCH for this Serving Cell:
 - 4> ignore the uplink grant.
 - 3> else:
 - 4> deliver the uplink grant and the HARQ information (redundancy version) of the TB to the identified HARQ process;
 - 4> instruct the identified HARQ process to trigger a retransmission;
 - 4> if the uplink grant is addressed to CS-RNTI; or
 - 4> if the uplink grant is addressed to C-RNTI, and the identified HARQ process is configured for a configured uplink grant:
 - 5> start or restart the *configuredGrantTimer*, if configured, for the corresponding HARQ process when the transmission is performed.

When determining if NDI has been toggled compared to the value in the previous transmission the MAC entity shall ignore NDI received in all uplink grants on PDCCH for its Temporary C-RNTI.

[TS 38.321, clause 5.4.2.2]

Each HARQ process is associated with a HARQ buffer.

New transmissions are performed on the resource and with the MCS indicated on either PDCCH, Random Access Response, or RRC. Retransmissions are performed on the resource and, if provided, with the MCS indicated on PDCCH, or on the same resource and with the same MCS as was used for last made transmission attempt within a bundle.

If the HARQ entity requests a new transmission for a TB, the HARQ process shall:

- 1> store the MAC PDU in the associated HARQ buffer;
- 1> store the uplink grant received from the HARQ entity;
- 1> generate a transmission as described below.

If the HARQ entity requests a retransmission for a TB, the HARQ process shall:

1> store the uplink grant received from the HARQ entity;

1> generate a transmission as described below.

To generate a transmission for a TB, the HARQ process shall:

1> if the MAC PDU was obtained from the Msg3 buffer; or

1> if there is no measurement gap at the time of the transmission and, in case of retransmission, the retransmission does not collide with a transmission for a MAC PDU obtained from the Msg3 buffer:

2> instruct the physical layer to generate a transmission according to the stored uplink grant.

7.1.1.3.9.3 Test description

7.1.1.3.9.3.1 Pre-test conditions

Same Pre-test conditions as in clause 7.1.1.0.

7.1.1.3.9.3.2 Test procedure sequence

Table 7.1.1.3.9.3.2-1: Main behaviour

St	Procedure	Message Sequence		TP	Verdict
		U - S	Message		
1	The SS transmits a valid MAC PDU containing RLC PDU.	<---	MAC PDU	-	-
2	The UE transmits a Scheduling Request.	-->	(SR)	-	-
3	The SS allocates an UL Grant for one HARQ process X, sufficient for one RLC SDU to be looped back in a Slot, and NDI indicates new transmission and DCI scheduling the PUSCH indicates $rv^{ID} = 0$.	<--	UL Grant	-	-
4	Check: Does the UE transmit a MAC PDU including one RLC SDU, in HARQ process X and repeats the MAC PDU in consecutive slots $pusch\text{-}AggregationFactor-1$ times with $rv^{ID} = 2$ for the first retransmission, $rv^{ID} = 3$ for the second retransmission and $rv^{ID} = 1$ for the third retransmission.	-->	MAC PDU	1	P

7.1.1.3.9.3.3 Specific message contents

Table 7.1.1.3.9.3.3-1: *ServingCellConfig* (preamble)

Derivation Path: TS 38.508-1 [4], Table 4.6.3-167			
Information Element	Value/remark	Comment	Condition
<i>ServingCellConfig</i> ::= SEQUENCE {			
uplinkConfig SEQUENCE {			
initialUplinkBWP	BWP-UplinkDedicated		
}			
}			

Table 7.1.1.3.9.3.3-2: *BWP-UplinkDedicated* (Table 7.1.1.3.9.3.3-1)

Derivation Path: TS 38.508-1 [4], Table 4.6.3-11			
Information Element	Value/remark	Comment	Condition
BWP-UplinkDedicated ::= SEQUENCE {			
pusch-Config CHOICE {	Not present		
Setup	PUSCH-Config		
}			
}			

Table 7.1.1.3.9.3.3-3: *PUSCH-Config* (Table 7.1.1.3.9.3.3-2)

Derivation Path: TS 38.508-1 [4], Table 4.6.3-118			
Information Element	Value/remark	Comment	Condition
PUSCH-Config ::= SEQUENCE {			
pusch-AggregationFactor	n4		
}			

7.1.1.3.10 Correct Handling of HARQ process / Multiple CORESETPoolIndex

7.1.1.3.10.1 Test Purpose (TP)

(1)

```
with { UE in RRC_CONNECTED state and is configured with PDCCH-Config that contains two different
values of CORESETPoolIndex in ControlResourceSet }
ensure that {
  when { UE receives PDCCHs that schedule two non-overlapping in time domain PUSCHs are associated
to different ControlResourceSets having different values of CORESETPoolIndex }
  then { UE sends PUSCHs following the scheduling information of PDCCHs }
}
```

(2)

```
with(UE in RRC_CONNECTED state and is configured with PDCCH-Config that contains two different
values of CORESETPoolIndex in ControlResourceSet)
ensure that {
  when{ UE receives PDCCHs that schedule two overlapping in time domain PDSCHs are associated to
different ControlResourceSets having different values of CORESETPoolIndex }
  then { UE Receives PDSCHs following the scheduling information of PDCCHs }
}
```

7.1.1.3.10.2 Conformance requirements

References: The conformance requirements covered in the present TC are specified in: TS 38.214, clauses 5.18.10 and 6.1.20. Unless otherwise stated these are Rel-16 requirements.

[TS 38.214, clause 5.11]

If a UE is configured by higher layer parameter *PDCCH-Config* that contains two different values of *CORESETPoolIndex* in *ControlResourceSet*, the UE may expect to receive multiple PDCCHs scheduling fully/partially/non-overlapped PDSCHs in time and frequency domain. The UE may expect the reception of full/partially-overlapped PDSCHs in time only when PDCCHs that schedule two PDSCHs are associated to different *ControlResourceSets* having different values of *CORESETPoolIndex*. For a *ControlResourceSet* without *CORESETPoolIndex*, the UE may assume that the *ControlResourceSet* is assigned with *CORESETPoolIndex* as 0. When the UE is scheduled with full/partially/non-overlapped PDSCHs in time and frequency domain, the full scheduling information for receiving a PDSCH is indicated and carried only by the corresponding PDCCH, the UE is expected to be scheduled with the same active BWP and the same SCS. When the UE is scheduled with full/partially-overlapped PDSCHs in time and frequency domain, the UE can be scheduled with at most two codewords simultaneously. When PDCCHs that schedule two PDSCHs are associated to different *ControlResourceSets* having different values of *CORESETPoolIndex*, the following operations are allowed:

- For any two HARQ process IDs in a given scheduled cell, if the UE is scheduled to start receiving a first PDSCH starting in symbol j by a PDCCH associated with a value of $CORESETPoolIndex$ ending in symbol i , the UE can be scheduled to receive a PDSCH starting earlier than the end of the first PDSCH with a PDCCH associated with a different value of $CORESETPoolIndex$ that ends later than symbol i .
- In a given scheduled cell, the UE can receive a first PDSCH in slot i , with the corresponding HARQ-ACK assigned to be transmitted in slot j , and a second PDSCH associated with a value of $CORESETPoolIndex$ different from that of the first PDSCH starting later than the first PDSCH with its corresponding HARQ-ACK assigned to be transmitted in a slot before slot j .

If PDCCHs that schedule corresponding PDSCHs are associated to the same or different *ControlResourceSets* having the same value of $CORESETPoolIndex$, the UE procedure for receiving the PDSCH upon detection of a PDCCH follows Clause 5.1.

[TS 38.214, clause 6.1]

If a UE is configured by higher layer parameter *PDCCH-Config* that contains two different values of $CORESETPoolIndex$ in *ControlResourceSet* for the active BWP of a serving cell and PDCCHs that schedule two non-overlapping in time domain PUSCHs are associated to different *ControlResourceSets* having different values of $CORESETPoolIndex$, for any two HARQ process IDs in a given scheduled cell, if the UE is scheduled to start a first PUSCH transmission starting in symbol j by a PDCCH associated with a value of $CORESETPoolIndex$ ending in symbol i , the UE can be scheduled to transmit a PUSCH starting earlier than the end of the first PUSCH by a PDCCH associated with a different value of $CORESETPoolIndex$ that ends later than symbol i .

7.1.1.3.10.3 Test description

7.1.1.3.10.3.1 Pre-test conditions

Same Pre-test conditions as in clause 7.1.1.0.

7.1.1.3.10.3.2 Test procedure sequence

Table 7.1.1.3.10.3.2-2: Main behaviour

St	Procedure	Message Sequence		TP	Verdict
		U - S	Message		
1	SS transmits NR <i>RRCReconfiguration</i> message to configure two different values of $CORESETPoolIndex$ in <i>ControlResourceSet</i> , (Note 1)	<--	-	-	-
2	The UE transmit NR <i>RRCReconfigurationComplete</i> messages (Note 2)	-->	-	-	-
3	The SS transmits 2 MAC PDU's on overlapping PDSCH's scheduled by two different values of $CORESETPoolIndex$ in <i>ControlResourceSet</i>	<--	MAC PDU 1, MAC PDU 2	-	-
4	100 ms after step 4, the SS transmits a two UL grants scheduling two non-overlapping in time domain PUSCHs associated to different <i>ControlResourceSets</i> having different values of $CORESETPoolIndex$	<--	(UL Grant 1, UL Grant 2)	-	-
5	Check: The UE transmits 2 MAC PDU's loop backed PDU's from step 4	-->	MAC PDU 1, MAC PDU 2	1,2	P
Note 1: For EN-DC the NR <i>RRCReconfiguration</i> message is contained in <i>RRCConnectionReconfiguration</i> 36.508 [7], Table 4.6.1-8 using condition EN-DC_EmbedNR_RRCRecon.					
Note 2: For EN-DC the NR <i>RRCReconfigurationComplete</i> message is contained in <i>RRCConnectionReconfigurationComplete</i> .					

7.1.1.3.10.3.3 Specific message contents

FFS

7.1.1.4 Transport Size Selection

7.1.1.4.1 DL-SCH Transport Block Size Selection

7.1.1.4.1.0 Common parameters for DL-SCH Transport Block Size Selection

Table 7.1.1.4.1.0-1: PDSCH-TimeDomainResourceAllocationList

Derivation Path: TS 38.508-1 [4], Table 4.6.3-103			
Information Element	Value/remark	Comment	Condition
PDSCH-TimeDomainResourceAllocationList ::= SEQUENCE(SIZE(1..maxNrofDL-Allocations)) OF SEQUENCE(SIZE(1..maxNrofDL-Allocations)) OF PDSCH-TimeDomainResourceAllocation {	2 entries		
PDSCH-TimeDomainResourceAllocation[1] SEQUENCE {		entry 1	
k0	Not present		
mappingType	typeA		
startSymbolAndLength	86	S=2, L=7	
}			
PDSCH-TimeDomainResourceAllocation[2] SEQUENCE {		entry 2	
k0	Not present		
mappingType	typeA		
startSymbolAndLength	53	S=2, L=12	
}			
}			

7.1.1.4.1.1 DL-SCH Transport Block Size selection / DCI format 1_0

7.1.1.4.1.1.1 Test Purpose (TP)

(1)

```

with { UE in RRC_CONNECTED state }
ensure that {
  when { UE on PDCCH receives DCI format 1_0 indicating a resource block assignment correspondent to
physical resource blocks , Time domain resource assignment and a modulation and coding }
  then { UE decodes the received transport block of size correspondent as per Modulation Coding
scheme, time domain resource allocation and PRB's and forwards it to higher layers }
}

```

7.1.1.4.1.1.2 Conformance requirements

References: The conformance requirements covered in the present TC are specified in: TS 38.212 clause 7.3.1.2.1, TS 38.214 clause 5.1.2.1, 5.1.2.2, 5.1.2.2.2, 5.1.3, 5.1.3.1 and 5.1.3.2. Unless otherwise stated these are Rel-15 requirements.

[TS 38.212, clause 7.3.1.2.1]

DCI format 1_0 is used for the scheduling of PDSCH in one DL cell.

The following information is transmitted by means of the DCI format 1_0 with CRC scrambled by C-RNTI or CS-RNTI or new-RNTI:

- Identifier for DCI formats – 1 bits
- The value of this bit field is always set to 1, indicating a DL DCI format
- Frequency domain resource assignment – $\log_2(N_{RB}^{DL,BWP}(N_{RB}^{DL,BWP} + 1)/2)$ bits

- $N_{RB}^{DL,BWP}$ is the size of the active DL bandwidth part in case DCI format 1_0 is monitored in the UE specific search space and satisfying
 - the total number of different DCI sizes monitored per slot is no more than 4 for the cell, and
 - the total number of different DCI sizes with C-RNTI monitored per slot is no more than 3 for the cell
- otherwise, $N_{RB}^{DL,BWP}$ is the size of the initial DL bandwidth part.

If the CRC of the DCI format 1_0 is scrambled by C-RNTI and the "Frequency domain resource assignment" field are of all ones, the DCI format 1_0 is for random access procedure initiated by a PDCCH order, with all remaining fields set as follows:

- Random Access Preamble index – 6 bits according to *ra-PreambleIndex* in Subclause 5.1.2 of [8, TS38.321]
- UL/SUL indicator – 1 bit. If the value of the "Random Access Preamble index" is not all zeros and if the UE is configured with SUL in the cell, this field indicates which UL carrier in the cell to transmit the PRACH according to Table 7.3.1.1.1-1; otherwise, this field is reserved
- SS/PBCH index – 6 bits. If the value of the "Random Access Preamble index" is not all zeros, this field indicates the SS/PBCH that shall be used to determine the RACH occasion for the PRACH transmission; otherwise, this field is reserved.
- PRACH Mask index – 4 bits. If the value of the "Random Access Preamble index" is not all zeros, this field indicates the RACH occasion associated with the SS/PBCH indicated by "SS/PBCH index" for the PRACH transmission, according to Subclause 5.1.1 of [8, TS38.321]; otherwise, this field is reserved
- Reserved bits – 10 bits

Otherwise, all remaining fields are set as follows:

- Time domain resource assignment – 4 bits as defined in Subclause 5.1.2.1 of [6, TS38.214]
- VRB-to-PRB mapping – 1 bit according to Table 7.3.1.1.2-33
- Modulation and coding scheme – 5 bits as defined in Subclause 5.1.3 of [6, TS38.214]
- New data indicator – 1 bit
- Redundancy version – 2 bits as defined in Table 7.3.1.1.1-2
- HARQ process number – 4 bits
- Downlink assignment index – 2 bits as defined in Subclause 9.1.3 of [5, TS38.213], as counter DAI
- TPC command for scheduled PUCCH – 2 bits as defined in Subclause 7.2.1 of [5, TS38.213]
- PUCCH resource indicator – 3 bits as defined in Subclause 9.2.3 of [5, TS38.213]
- PDSCH-to-HARQ_feedback timing indicator – 3 bits as defined in Subclause 9.2.3 of [5, TS38.213]

[TS 38.214, clause 5.1.2.1]

When the UE is scheduled to receive PDSCH by a DCI, the *Time domain resource assignment* field value m of the DCI provides a row index $m + 1$ to an allocation table. The determination of the used resource allocation table is defined in sub-clause 5.1.2.1.1. The indexed row defines the slot offset K_0 , the start and length indicator *SLIV*, or directly the start symbol S and the allocation length L , and the PDSCH mapping type to be assumed in the PDSCH reception.

Given the parameter values of the indexed row:

- The slot allocated for the PDSCH is $\left\lfloor n \cdot \frac{2^{\mu_{PDSCH}}}{2^{\mu_{PDCCH}}} \right\rfloor + K_0$, where n is the slot with the scheduling DCI, and K_0 is based on the numerology of PDSCH, and μ_{PDSCH} and μ_{PDCCH} are the subcarrier spacing configurations for PDSCH and PDCCH, respectively, and

- The starting symbol S relative to the start of the slot, and the number of consecutive symbols L counting from the symbol S allocated for the PDSCH are determined from the start and length indicator $SLIV$:

if $(L-1) \leq 7$ then

$$SLIV = 14 \cdot (L-1) + S$$

else

$$SLIV = 14 \cdot (14 - L + 1) + (14 - 1 - S)$$

where $0 < L \leq 14 - S$, and

- The PDSCH mapping type is set to Type A or Type B as defined in sub-clause 7.4.1.1.2 of [4, TS 38.211].

The UE shall consider the S and L combinations defined in table 5.1.2.1-1 as valid PDSCH allocations:

Table 5.1.2.1-1: Valid S and L combinations

PDSCH mapping type	Normal cyclic prefix			Extended cyclic prefix		
	S	L	$S+L$	S	L	$S+L$
Type A	{0,1,2,3} (Note 1)	{3,...,14}	{3,...,14}	{0,1,2,3} (Note 1)	{3,...,12}	{3,...,12}
Type B	{0,...,12}	{2,4,7}	{2,...,14}	{0,...,10}	{2,4,6}	{2,...,12}

[38.214 clause 5.1.2.2]

Two downlink resource allocation schemes, type 0 and type 1, are supported. The UE shall assume that when the scheduling grant is received with DCI format 1_0, then downlink resource allocation type 1 is used.

[38.214 clause 5.1.2.2.2]

In downlink resource allocation of type 1, the resource block assignment information indicates to a scheduled UE a set of contiguously allocated non-interleaved or interleaved virtual resource blocks within the active bandwidth part of size N_{BWP}^{size} PRBs except for the case when DCI format 1_0 is decoded in any common search space in CORESET 0 in which case the initial bandwidth part of size $N_{BWP,0}^{size}$ shall be used.

A downlink type 1 resource allocation field consists of a resource indication value (RIV) corresponding to a starting virtual resource block (RB_{start}) and a length in terms of contiguously allocated resource blocks L_{RBs} . The resource indication value is defined by

if $(L_{RBs} - 1) \leq \lfloor N_{BWP}^{size} / 2 \rfloor$ then

$$RIV = N_{BWP}^{size} (L_{RBs} - 1) + RB_{start}$$

else

$$RIV = N_{BWP}^{size} (N_{BWP}^{size} - L_{RBs} + 1) + (N_{BWP}^{size} - 1 - RB_{start})$$

where $L_{RBs} \geq 1$ and shall not exceed $N_{BWP}^{size} - RB_{start}$.

[TS 38.214, clause 5.1.3]

To determine the modulation order, target code rate, and transport block size(s) in the physical downlink shared channel, the UE shall first

- read the 5-bit *modulation and coding scheme* field (I_{MCS}) in the DCI to determine the modulation order (Q_m) and target code rate (R) based on the procedure defined in Subclause 5.1.3.1, and
- read *redundancy version* field (rv) in the DCI to determine the redundancy version..

and second

- the UE shall use the number of layers (v), the total number of allocated PRBs before rate matching (n_{PRB}) to determine to the transport block size based on the procedure defined in Subclause 5.1.3.2.

The UE may skip decoding a transport block in an initial transmission if the effective channel code rate is higher than 0.95, where the effective channel code rate is defined as the number of downlink information bits (including CRC bits) divided by the number of physical channel bits on PDSCH. If the UE skips decoding, the physical layer indicates to higher layer that the transport block is not successfully decoded.

[TS 38.214, clause 5.1.3.1]

For the PDSCH scheduled by a PDCCH with DCI format 1_0 or format 1_1 with CRC scrambled by C-RNTI, new-RNTI, TC-RNTI, CS-RNTI, SI-RNTI, RA-RNTI, or P-RNTI,

if the higher layer parameter *mcs-Table* given by *PDSCH-Config* is set to 'qam256', and the PDSCH is scheduled by a PDCCH with a DCI format 1_1 and the CRC is scrambled by C-RNTI or CS-RNTI

- the UE shall use I_{MCS} and Table 5.1.3.1-2 to determine the modulation order (Q_m) and Target code rate (R) used in the physical downlink shared channel.

elseif the UE is not configured with new-RNTI, the higher layer parameter *mcs-Table* given by *PDSCH-Config* is set to 'qam64LowSE', and the PDSCH is scheduled with C-RNTI, and the PDSCH is assigned by a PDCCH in a UE-specific search space

- the UE shall use I_{MCS} and Table 5.1.3.1-3 to determine the modulation order (Q_m) and Target code rate (R) used in the physical downlink shared channel.

elseif the UE is configured with new-RNTI, and the PDSCH is scheduled with new-RNTI

- the UE shall use I_{MCS} and Table 5.1.3.1-3 to determine the modulation order (Q_m) and Target code rate (R) used in the physical downlink shared channel.

elseif the UE is not configured with the higher layer parameter *mcs-Table* given by *SPS-config*, the higher layer parameter *mcs-Table* given by *PDSCH-Config* is set to 'qam256', the PDSCH is scheduled with CS-RNTI, and the PDSCH is assigned by a PDCCH with DCI format 1_1

- the UE shall use I_{MCS} and Table 5.1.3.1-2 to determine the modulation order (Q_m) and Target code rate (R) used in the physical downlink shared channel.

elseif the UE is configured with the higher layer parameter *mcs-Table* given by *SPS-config* set to 'qam64LowSE', and the PDSCH is scheduled with CS-RNTI

- the UE shall use I_{MCS} and Table 5.1.3.1-3 to determine the modulation order (Q_m) and Target code rate (R) used in the physical downlink shared channel.

else

- the UE shall use I_{MCS} and Table 5.1.3.1-1 to determine the modulation order (Q_m) and Target code rate (R) used in the physical downlink shared channel.

End

The UE is not expected to decode a PDSCH scheduled with P-RNTI, RA-RNTI, SI-RNTI and $Q_m > 2$

Table 5.1.3.1-1: MCS index table 1 for PDSCH

MCS Index I_{MCS}	Modulation Order Q_m	Target code Rate $R \times [1024]$	Spectral efficiency
0	2	120	0.2344
1	2	157	0.3066
2	2	193	0.3770
3	2	251	0.4902
4	2	308	0.6016
5	2	379	0.7402
6	2	449	0.8770
7	2	526	1.0273
8	2	602	1.1758
9	2	679	1.3262
10	4	340	1.3281
11	4	378	1.4766
12	4	434	1.6953
13	4	490	1.9141
14	4	553	2.1602
15	4	616	2.4063
16	4	658	2.5703
17	6	438	2.5664
18	6	466	2.7305
19	6	517	3.0293
20	6	567	3.3223
21	6	616	3.6094
22	6	666	3.9023
23	6	719	4.2129
24	6	772	4.5234
25	6	822	4.8164
26	6	873	5.1152
27	6	910	5.3320
28	6	948	5.5547
29	2	reserved	
30	4	reserved	
31	6	reserved	

[TS 38.214, clause 5.1.3.2]

In case the higher layer parameter *maxNrofCodeWordsScheduledByDCI* indicates that two codeword transmission is enabled, then a transport block is disabled by DCI format 1_1 if $I_{MCS} = 26$ and if $r_{vid} = 1$ for the corresponding transport block, otherwise the transport block is enabled. If both transport blocks are enabled, transport block 1 and 2 are mapped to codeword 0 and 1 respectively. If only one transport block is enabled, then the enabled transport block is always mapped to the first codeword.

For the PDSCH assigned by a PDCCH with DCI format 1_0 or format 1_1 with CRC scrambled by C-RNTI, new-RNTI, TC-RNTI, CS-RNTI, or SI-RNTI, if Table 5.1.3.1-2 is used and $0 \leq I_{MCS} \leq 27$, or a table other than Table 5.1.3.1-2 is used and $0 \leq I_{MCS} \leq 28$, the UE shall, except if the transport block is disabled in DCI format 1_1, first determine the TBS as specified below:

1) The UE shall first determine the number of REs (N_{RE}) within the slot.

- A UE first determines the number of REs allocated for PDSCH within a PRB (N'_{RE}) by

$$N'_{RE} = N_{sc}^{RB} \cdot N_{ymb}^{sh} - N_{DMRS}^{PRB} - N_{oh}^{PRB}, \text{ where } N_{sc}^{RB} = 12 \text{ is the number of subcarriers in a physical resource}$$

block, N_{ymb}^{sh} is the number of symbols of the PDSCH allocation within the slot, N_{DMRS}^{PRB} is the number of REs for DM-RS per PRB in the scheduled duration including the overhead of the DM-RS CDM groups without data, as indicated by DCI format 1_1 or as described for format 1_0 in Subclause 5.1.6.2, and N_{oh}^{PRB} is the overhead configured by higher layer parameter *xOverhead* in *PDSCH-ServingCellConfig*. If the *xOverhead* in *PDSCH-ServingCellConfig* is not configured (a value from 0, 6, 12, or 18), the N_{oh}^{PRB} is set to

0. If the PDSCH is scheduled by PDCCH with a CRC scrambled by SI-RNTI, RA-RNTI or P-RNTI, N_{oh}^{PRB} is assumed to be 0.

- A UE determines the total number of REs allocated for PDSCH (N_{RE}) by $N_{RE} = \min(156, N_{RE}^{\prime}) \cdot n_{PRB}$, where n_{PRB} is the total number of allocated PRBs for the UE.

2) Intermediate number of information bits (N_{info}) is obtained by $N_{info} = N_{RE} \cdot R \cdot Q_m \cdot \nu$.

If $N_{info} \leq 3824$

Use step 3 as the next step of the TBS determination

else

Use step 4 as the next step of the TBS determination

end if

3) When $N_{info} \leq 3824$, TBS is determined as follows

- quantized intermediate number of information bits $N_{info}^{\prime} = \max\left(24, 2^n \cdot \left\lfloor \frac{N_{info}}{2^n} \right\rfloor\right)$, where $n = \max(3, \log_2(N_{info})) - 6$.
- use Table 5.1.3.2-2 find the closest TBS that is not less than N_{info}^{\prime} .

Table 5.1.3.2-2: TBS for $N_{info} \leq 3824$

Index	TBS	Index	TBS	Index	TBS	Index	TBS
1	24	31	336	61	1288	91	3624
2	32	32	352	62	1320	92	3752
3	40	33	368	63	1352	93	3824
4	48	34	384	64	1416		
5	56	35	408	65	1480		
6	64	36	432	66	1544		
7	72	37	456	67	1608		
8	80	38	480	68	1672		
9	88	39	504	69	1736		
10	96	40	528	70	1800		
11	104	41	552	71	1864		
12	112	42	576	72	1928		
13	120	43	608	73	2024		
14	128	44	640	74	2088		
15	136	45	672	75	2152		
16	144	46	704	76	2216		
17	152	47	736	77	2280		
18	160	48	768	78	2408		
19	168	49	808	79	2472		
20	176	50	848	80	2536		
21	184	51	888	81	2600		
22	192	52	928	82	2664		
23	208	53	984	83	2728		
24	224	54	1032	84	2792		
25	240	55	1064	85	2856		
26	256	56	1128	86	2976		
27	272	57	1160	87	3104		
28	288	58	1192	88	3240		
29	304	59	1224	89	3368		
30	320	60	1256	90	3496		

4) When $N'_{info} > 3824$, TBS is determined as follows.

- quantized intermediate number of information bits $N'_{info} = \max\left(3840, 2^n \times \text{round}\left(\frac{N'_{info} - 24}{2^n}\right)\right)$, where $n = \log_2(N'_{info} - 24) \lfloor -5$ and ties in the round function are broken towards the next largest integer.

- if $R \leq 1/4$

$$TBS = 8 \cdot C \cdot \left\lceil \frac{N'_{info} + 24}{8 \cdot C} \right\rceil - 24, \text{ where } C = \left\lceil \frac{N'_{info} + 24}{3816} \right\rceil$$

else

if $N'_{info} > 8424$

$$TBS = 8 \cdot C \cdot \left\lceil \frac{N'_{info} + 24}{8 \cdot C} \right\rceil - 24, \text{ where } C = \left\lceil \frac{N'_{info} + 24}{8424} \right\rceil$$

else

$$TBS = 8 \cdot \left\lceil \frac{N'_{info} + 24}{8} \right\rceil - 24$$

end if

end if

7.1.1.4.1.1.3 Test description

7.1.1.4.1.1.3.1 Pre-test conditions

Same Pre-test conditions as in clause 7.1.1.0 except set the NR Cell bandwidth and applicable BWP to maximum for the NR Band under test as specified in Table 5.3.5-1 in TS 38.101-1 [16] / TS 38.101-2 [17] (to enable testing of n_{PRB} up to maximum value) and Short_DCI condition is applied in NR Serving cell configuration.

Test frequency NRf1 is as specified in TS 38.508-1 [4] clause 4.3.1 using the common highest UL and DL channel bandwidth and using the default subcarrier spacing specified in TS 38.508-1 [4] clause 6.2.3.1.

7.1.1.4.1.1.3.2 Test procedure sequence

Table 7.1.1.4.1.1.3.2-1: Maximum TBS for different UE categories

UE Category	Maximum number of bits of a UL-SCH transport block received within a TTI
TS 38.306 [23] clause 4.1.2 require UE without ue-CategoryDL and ue-CategoryUL, to support Max TBS achievable based on max bandwidth of the Band under test.	

Table 7.1.1.4.1.1.3.2-2: Number of downlink PDCP SDUs and PDCP SDU size used as test data

TBS [bits]	Number of PDCP SDUs	PDCP SDU size [bits] (Note 1)
$136 \leq \text{TBS} \leq 12128$ note 2	1	$8 * \text{FLOOR}((\text{TBS} - 128)/8)$
$12129 \leq \text{TBS} \leq 24200$	2	$8 * \text{FLOOR}((\text{TBS} - 200)/16)$
$24201 \leq \text{TBS} \leq 36272$	3	$8 * \text{FLOOR}((\text{TBS} - 272)/24)$
$36273 \leq \text{TBS} \leq 48344$	4	$8 * \text{FLOOR}((\text{TBS} - 344)/32)$
$48345 \leq \text{TBS} \leq 60416$	5	$8 * \text{FLOOR}((\text{TBS} - 416)/40)$
$60417 \leq \text{TBS} \leq 72488$	6	$8 * \text{FLOOR}((\text{TBS} - 488)/48)$
$72489 \leq \text{TBS} \leq 84560$	7	$8 * \text{FLOOR}((\text{TBS} - 560)/56)$
$84561 \leq \text{TBS} \leq 96632$	8	$8 * \text{FLOOR}((\text{TBS} - 632)/64)$
$96633 < \text{TBS} \leq 108704$	9	$8 * \text{FLOOR}((\text{TBS} - 704)/72)$
$10705 \leq \text{TBS} \leq 120776$	10	$8 * \text{FLOOR}((\text{TBS} - 776)/80)$
$120777 \leq \text{TBS} \leq 132848$	11	$8 * \text{FLOOR}((\text{TBS} - 848)/88)$
$132849 \leq \text{TBS} \leq 144920$	12	$8 * \text{FLOOR}((\text{TBS} - 920)/96)$
$\text{TBS} > 144920$	13	$8 * \text{FLOOR}((\text{TBS} - 992)/104)$

Note 1: Each PDCP SDU is limited to 1500 octets (to keep below maximum SDU size of ESM as specified in TS 24.301 [21] clause 9.9.4.12).

The PDCP SDU size of each PDCP SDU is

$\text{PDCP SDU size} = (\text{TBS} - N * \text{PDCP header size} - N * \text{AMD PDU header size} - N * \text{MAC header size} - \text{Size of Timing Advance} - \text{RLC Status PDU size} - \text{MAC header for RLC Status PDU}) / N$, where

PDCP header size is 24 bits for the RLC AM and 18-bit SN case;
AMD PDU header size is 24 bits with 18 bit SN;

MAC header size for AMD PDU = 16 or 24 bits depending on L=8 or 16 bits. Worst case 24 is taken.

Size of Timing Advance MAC CE with header is 16 bits (if no Timing Advance and/or RLC status needs to be sent, padding will occur instead).

RLC Status PDU size = 24 bits with 1 ACK_SN, With a MAC header of 16 bits.

This gives:

$\text{PDCP SDU size} = 8 * \text{FLOOR}((\text{TBS} - N * 24 - N * 24 - N * 24 - 56) / (8 * N))$ bits.

Note 2: According to the final PDCP SDU size formula in Note 1, the smallest TBS that can be tested is 136 bits.

Table 7.1.1.4.1.1.3.2-3: Specific Parameters

Parameter	Value	Comment
number of layers (v)	1	
mcs-Table	qam64	
xoh-PDSCH	Not Present	Results in value 0(xoh0)

Table 7.1.1.4.1.1.3.2-4: Main behaviour

St	Procedure	Message Sequence		TP	Verdict
		U - S	Message		
-	EXCEPTION: Steps 1 to 5 are repeated for allowed values of N_{PRB} 1 to $N_{RB}^{DL,BWP}$ in BWP, time domain resource as per table 7.1.1.4.1.0-1 and I_{MCS} from 0 to 28. NOTE: Skip the execution of steps for which the TBS size results in coding rate exceeding 0.95.	-	-	-	-
1	The SS calculates or looks up TBS in TS 38.214 [15] based on the value of S, L, I_{MCS} and n_{PRB} .	-	-	-	-
-	EXCEPTION: Steps 2 to 5 are performed if TBS is less than or equal to UE capability "Maximum number of DL-SCH transport block bits received within a TTI" as specified in Table 7.1.1.4.1.1.3.2-1 and larger than or equal to 132 bits as specified in Table 7.1.1.4.1.1.3.2-2	-	-	-	-
2	The SS creates one or more PDCP SDUs, depending on TBS, in accordance with Table 7.1.1.4.1.1.3.2-2.	-	-	-	-
3	The SS transmits the PDCP SDUs concatenated into a MAC PDU and indicates on PDCCH DCI Format 1_0 and values of S, L, I_{MCS} and n_{PRB} .	<--	MAC PDU (NxPDCP SDUs) DCI: (DCI Format 1_0, S, L, I_{MCS} and n_{PRB} .)	-	-
4	At the reception of scheduling request the SS transmits UL Grant for transmitting loop back PDCP SDUs.	<--	(UL Grant)	-	-
5	CHECK: Does UE return the same number of PDCP SDUs with same content as transmitted by the SS in step 3?	-->	(NxPDCP SDUs)	1	P

7.1.1.4.1.1.3.3 Specific message contents

None.

7.1.1.4.1.2 Void

7.1.1.4.1.3 DL-SCH transport block size selection / DCI format 1_1 / RA type 0/RA Type 1 / 2
Codewords enabled

7.1.1.4.1.3.1 Test Purpose (TP)

(1)

```
with { UE in RRC_CONNECTED state and maxNrofCodeWordsScheduledByDCI set to 'n2' }
ensure that {
  when { UE on PDCCH receives DCI format 1_1 indicating resource allocation type 0 a resource block
assignment correspondent to physical resource blocks , Time domain resource assignment and a
modulation and coding }
```

```

    then { UE decodes the received transport block of size correspondent as per Modulation Coding
    scheme, time domain resource allocation and PRB's and forwards it to higher layers }
    }

```

(2)

```

with { UE in RRC_CONNECTED state and maxNrofCodeWordsScheduledByDCI set to 'n2' }
ensure that {
    when { UE on PDCCH receives DCI format 1_1 indicating resource allocation type 1 a resource block
    assignment correspondent to physical resource blocks , Time domain resource assignment and a
    modulation and coding }
    then { UE decodes the received transport block of size correspondent as per Modulation Coding
    scheme, time domain resource allocation and PRB's and forwards it to higher layers }
    }

```

7.1.1.4.1.3.2 Conformance requirements

References: The conformance requirements covered in the present TC are specified in: TS 38.212 clause 7.3.1.2.2, TS 38.214 clause 5.1.2.1, 5.1.2.2.1, 5.1.2.2.2, 5.1.3, 5.1.3.1 and 5.1.3.2. Unless otherwise stated these are Rel-15 requirements.

[TS 38.212, clause 7.3.1.2.2]

DCI format 1_1 is used for the scheduling of PDSCH in one cell.

The following information is transmitted by means of the DCI format 1_1 with CRC scrambled by C-RNTI or CS-RNTI or new-RNTI:

- Identifier for DCI formats – 1 bits
- The value of this bit field is always set to 1, indicating a DL DCI format
 - Carrier indicator – 0 or 3 bits as defined in Subclause 10.1 of [5, TS38.213].
 - Bandwidth part indicator – 0, 1 or 2 bits as determined by the number of DL BWPs $n_{\text{BWP,RRC}}$ configured by higher layers, excluding the initial DL bandwidth part. The bit width for this field is determined as $\lceil \log_2(n_{\text{BWP}}) \rceil$ bits, where
 - $n_{\text{BWP}} = n_{\text{BWP,RRC}} + 1$ if $n_{\text{BWP,RRC}} \leq 3$, in which case the bandwidth part indicator is equivalent to the higher layer parameter *BWP-Id*;
 - otherwise $n_{\text{BWP}} = n_{\text{BWP,RRC}}$, in which case the bandwidth part indicator is defined in Table 7.3.1.1.2-1;

If a UE does not support active BWP change via DCI, the UE ignores this bit field.

- Frequency domain resource assignment – number of bits determined by the following, where $N_{\text{RB}}^{\text{DL,BWP}}$ is the size of the active DL bandwidth part:
 - N_{RBG} bits if only resource allocation type 0 is configured, where N_{RBG} is defined in Subclause 5.1.2.2.1 of [6, TS38.214],
 - $\log_2(N_{\text{RB}}^{\text{DL,BWP}}(N_{\text{RB}}^{\text{DL,BWP}} + 1)/2)$ bits if only resource allocation type 1 is configured, or
 - $\max\left(\log_2(N_{\text{RB}}^{\text{DL,BWP}}(N_{\text{RB}}^{\text{DL,BWP}} + 1)/2), N_{\text{RBG}}\right) + 1$ bits if both resource allocation type 0 and 1 are configured.
 - If both resource allocation type 0 and 1 are configured, the MSB bit is used to indicate resource allocation type 0 or resource allocation type 1, where the bit value of 0 indicates resource allocation type 0 and the bit value of 1 indicates resource allocation type 1.
 - For resource allocation type 0, the N_{RBG} LSBs provide the resource allocation as defined in Subclause 5.1.2.2.1 of [6, TS38.214].

- For resource allocation type 1, the $\lceil \log_2(N_{RB}^{DL,BWP}(N_{RB}^{DL,BWP} + 1)/2) \rceil$ LSBs provide the resource allocation as defined in Subclause 5.1.2.2.2 of [6, TS38.214]

If “Bandwidth part indicator” field indicates a bandwidth part other than the active bandwidth part and if both resource allocation type 0 and 1 are configured for the indicated bandwidth part, the UE assumes resource allocation type 0 for the indicated bandwidth part if the bit width of the “Frequency domain resource assignment” field of the active bandwidth part is smaller than the bit width of the “Frequency domain resource assignment” field of the indicated bandwidth part.

- Time domain resource assignment – 0, 1, 2, 3, or 4 bits as defined in Subclause 5.1.2.1 of [6, TS38.214]. The bit width for this field is determined as $\lceil \log_2(I) \rceil$ bits, where I is the number of entries in the higher layer parameter *pusch-AllocationList*.
- VRB-to-PRB mapping – 0 or 1 bit
 - 0 bit if only resource allocation type 0 is configured;
 - 1 bit according to Table 7.3.1.1.2-33 otherwise, only applicable to resource allocation type 1, as defined in Subclause 7.3.1.6 of [4, TS38.211].
- PRB bundling size indicator – 0 bit if the higher layer parameter *prb-BundlingType* is not configured or is set to ‘static’, or 1 bit if the higher layer parameter *prb-BundlingType* is set to ‘dynamic’, according to Subclause 5.1.2.3 of [6, TS38.214].
- Rate matching indicator – 0, 1, or 2 bits according to higher layer parameter *rateMatchPattern*.
- ZP CSI-RS trigger – 0, 1, or 2 bits as defined in Subclause 5.1.4.2 of [6, TS38.214]. The bit width for this field is determined as $\lceil \log_2(n_{ZP} + 1) \rceil$ bits, where n_{ZP} is the number of ZP CSI-RS resource sets in the higher layer parameter *zP-CSI-RS-Resource*.

For transport block 1:

- Modulation and coding scheme – 5 bits as defined in Subclause 5.1.3.1 of [6, TS38.214]
- New data indicator – 1 bit
- Redundancy version – 2 bits as defined in Table 7.3.1.1.1-2

For transport block 2 (only present if *maxNrofCodeWordsScheduledByDCI* equals 2

- Modulation and coding scheme – 5 bits as defined in Subclause 5.1.3.1 of [6, TS38.214]
- New data indicator – 1 bit
- Redundancy version – 2 bits as defined in Table 7.3.1.1.1-2

If “Bandwidth part indicator” field indicates a bandwidth part other than the active bandwidth part and the value of *maxNrofCodeWordsScheduledByDCI* for the indicated bandwidth part equals 2 and the value of *maxNrofCodeWordsScheduledByDCI* for the active bandwidth part equals 1, the UE assumes zeros are padded when interpreting the “Modulation and coding scheme”, “New data indicator”, and “Redundancy version” fields of transport block 2 according to Subclause 12 of [5, TS38.213], and the UE ignores the “Modulation and coding scheme”, “New data indicator”, and “Redundancy version” fields of transport block 2 for the indicated bandwidth part.

- HARQ process number – 4 bits
- Downlink assignment index – number of bits as defined in the following
 - 4 bits if more than one serving cell are configured in the DL and the higher layer parameter *pdscHARQ-ACK-Codebook=dynamic*, where the 2 MSB bits are the counter DAI and the 2 LSB bits are the total DAI;
 - 2 bits if only one serving cell is configured in the DL and the higher layer parameter *pdscHARQ-ACK-Codebook=dynamic*, where the 2 bits are the counter DAI;
 - 0 bits otherwise.

- TPC command for scheduled PUCCH – 2 bits as defined in Subclause 7.2.1 of [5, TS38.213]
- PUCCH resource indicator – 3 bits as defined in Subclause 9.2.3 of [5, TS38.213]
- PDSCH-to-HARQ_feedback timing indicator – 3 0, 1, 2, or bits as defined in Subclause 9.2.3 of [5, TS38.213]. The bit width for this field is determined as $\lceil \log_2(I) \rceil$ bits, where I is the number of entries in the higher layer parameter *dl-DataToUL-ACK*.
- Antenna port(s) – 4, 5, or 6 bits as defined by Tables 7.3.1.2.2-1/2/3/4, where the number of CDM groups without data of values 1, 2, and 3 refers to CDM groups {0}, {0,1}, and {0, 1,2} respectively. The antenna ports $\{p_0, \dots, p_{v-1}\}$ shall be determined according to the ordering of DMRS port(s) given by Tables 7.3.1.2.2-1/2/3/4.

If a UE is configured with both *dmrs-DownlinkForPDSCH-MappingTypeA* and *dmrs-DownlinkForPDSCH-MappingTypeB*, the bit width of this field equals $\max\{x_A, x_B\}$, where x_A is the “Antenna ports” bit width derived according to *dmrs-DownlinkForPDSCH-MappingTypeA* and x_B is the “Antenna ports” bit width derived according to *dmrs-DownlinkForPDSCH-MappingTypeB*. A number of $|x_A - x_B|$ zeros are padded in the MSB of this field, if the mapping type of the PDSCH corresponds to the smaller value of x_A and x_B .

- Transmission configuration indication – 0 bit if higher layer parameter *tci-PresentInDCI* is not enabled; otherwise 3 bits as defined in Subclause 5.1.5 of [6, TS38.214].

If “Bandwidth part indicator” field indicates a bandwidth part other than the active bandwidth part and the “Transmission configuration indication” field is not present in the DCI format 1_1, the UE assumes *tci-PresentInDCI* is not enabled for the indicated bandwidth part.

- SRS request – 2 bits as defined by Table 7.3.1.1.2-24 for UEs not configured with SUL in the cell; 3 bits for UEs configured SUL in the cell where the first bit is the non-SUL/SUL indicator as defined in Table 7.3.1.1.1-1 and the second and third bits are defined by Table 7.3.1.1.2-24. This bit field may also indicate the associated CSI-RS according to Subclause 6.1.1.2 of [6, TS 38.214].
- CBG transmission information (CBGTI) – 0, 2, 4, 6, or 8 bits as defined in Subclause 5.1.7 of [6, TS38.214], determined by the higher layer parameters *maxCodeBlockGroupsPerTransportBlock* and *Number-MCS-HARQ-DL-DCI* for the PDSCH.
- CBG flushing out information (CBGFI) – 0 or 1 bit as defined in Subclause 5.1.7 of [6, TS38.214], determined by higher layer parameter *codeBlockGroupFlushIndicator*.
- DMRS sequence initialization – 1 bit if both *scramblingID0* and *scramblingID1* are configured in *DMRS-DownlinkConfig* for n_{SCID} selection defined in Subclause 7.4.1.1.1 of [4, TS38.211]; 0 bit otherwise.

[TS 38.214, clause 5.1.2.1]

When the UE is scheduled to receive PDSCH by a DCI, the *Time domain resource assignment* field value m of the DCI provides a row index $m + 1$ to an allocation table. The determination of the used resource allocation table is defined in sub-clause 5.1.2.1.1. The indexed row defines the slot offset K_0 , the start and length indicator *SLIV*, or directly the start symbol S and the allocation length L , and the PDSCH mapping type to be assumed in the PDSCH reception.

Given the parameter values of the indexed row:

- The slot allocated for the PDSCH is $\left\lfloor n \cdot \frac{2^{\mu_{\text{PDSCH}}}}{2^{\mu_{\text{PDCCH}}}} \right\rfloor + K_0$, where n is the slot with the scheduling DCI, and K_0 is

based on the numerology of PDSCH, and μ_{PDSCH} and μ_{PDCCH} are the subcarrier spacing configurations for PDSCH and PDCCH, respectively, and

- The starting symbol S relative to the start of the slot, and the number of consecutive symbols L counting from the symbol S allocated for the PDSCH are determined from the start and length indicator *SLIV*:

if $(L-1) \leq 7$ then

$$SLIV = 14 \cdot (L-1) + S$$

else

$$SLIV = 14 \cdot (14 - L + 1) + (14 - 1 - S)$$

where $0 < L \leq 14 - S$, and

- The PDSCH mapping type is set to Type A or Type B as defined in sub-clause 7.4.1.1.2 of [4, TS 38.211].

The UE shall consider the S and L combinations defined in table 5.1.2.1-1 as valid PDSCH allocations:

Table 5.1.2.1-1: Valid S and L combinations

PDSCH mapping type	Normal cyclic prefix			Extended cyclic prefix		
	S	L	$S+L$	S	L	$S+L$
Type A	{0,1,2,3} (Note 1)	{3,...,14}	{3,...,14}	{0,1,2,3} (Note 1)	{3,...,12}	{3,...,12}
Type B	{0,...,12}	{2,4,7}	{2,...,14}	{0,...,10}	{2,4,6}	{2,...,12}

Note 1: $S = 3$ is applicable only if $dmrs\text{-}TypeA\text{-}Position = 3$

[TS 38.214, clause 5.1.2.2.1]

In downlink resource allocation of type 0, the resource block assignment information includes a bitmap indicating the Resource Block Groups (RBGs) that are allocated to the scheduled UE where a RBG is a set of consecutive virtual resource blocks defined by higher layer parameter $rbg\text{-}Size$ configured for PDSCH and the size of the carrier bandwidth part as defined in Table 5.1.2.2.1-1.

Table 5.1.2.2.1-1: Nominal RBG size P

Bandwidth Part Size	Configuration 1	Configuration 2
1 – 36	2	4
37 – 72	4	8
73 – 144	8	16
145 – 275	16	16

The total number of RBGs (N_{RBG}) for a downlink carrier bandwidth part i of size $N_{BWP,i}^{size}$ PRBs is given by

$$N_{RBG} = \left(N_{BWP,i}^{size} + \left(N_{BWP,i}^{start} \bmod P \right) \right) / P \Big|, \text{ where}$$

- the size of the first RBG is $RBG_0^{size} = P - N_{BWP,i}^{start} \bmod P$,
- the size of last RBG is $RBG_{last}^{size} = \left(N_{BWP,i}^{start} + N_{BWP,i}^{size} \right) \bmod P$ if $\left(N_{BWP,i}^{start} + N_{BWP,i}^{size} \right) \bmod P > 0$ and P otherwise,
- the size of all other RBGs is P .

The bitmap is of size N_{RBG} bits with one bitmap bit per RBG such that each RBG is addressable. The RBGs shall be indexed in the order of increasing frequency and starting at the lowest frequency of the carrier bandwidth part. The order of RBG bitmap is such that RBG 0 to RBG $N_{RBG} - 1$ are mapped from MSB to LSB. The RBG is allocated to the UE if the corresponding bit value in the bitmap is 1, the RBG is not allocated to the UE otherwise.

[TS 38.214, clause 5.1.2.2.2]

In downlink resource allocation of type 1, the resource block assignment information indicates to a scheduled UE a set of contiguously allocated localized or distributed virtual resource blocks within the active carrier bandwidth part of size N_{BWP}^{size} PRBs except for the case when DCI format 1_0 is decoded in the common search space in CORESET 0 in which case the initial bandwidth part of size N_{BWP}^{size} shall be used.

A downlink type 1 resource allocation field consists of a resource indication value (RIV) corresponding to a starting virtual resource block (RB_{start}) and a length in terms of contiguously allocated resource blocks L_{RBs} . The resource indication value is defined by

if $(L_{RBs} - 1) \leq N_{BWP}^{size} / 2$ then

$$RIV = N_{BWP}^{size} (L_{RBs} - 1) + RB_{start}$$

else

$$RIV = N_{BWP}^{size} (N_{BWP}^{size} - L_{RBs} + 1) + (N_{BWP}^{size} - 1 - RB_{start})$$

where $L_{RBs} \geq 1$ and shall not exceed $N_{BWP}^{size} - RB_{start}$.

[TS 38.214, clause 5.1.3]

To determine the modulation order, target code rate, and transport block size(s) in the physical downlink shared channel, the UE shall first

- read the 5-bit *modulation and coding scheme* field (I_{MCS}) in the DCI to determine the modulation order (Q_m) and target code rate (R) based on the procedure defined in Subclause 5.1.3.1, and
- read *redundancy version* field (rv) in the DCI to determine the redundancy version.

and second

- the UE shall use the number of layers (v), the total number of allocated PRBs before rate matching (n_{PRB}) to determine to the transport block size based on the procedure defined in Subclause 5.1.3.2.

The UE may skip decoding a transport block in an initial transmission if the effective channel code rate is higher than 0.95, where the effective channel code rate is defined as the number of downlink information bits (including CRC bits) divided by the number of physical channel bits on PDSCH. If the UE skips decoding, the physical layer indicates to higher layer that the transport block is not successfully decoded.

[TS 38.214, clause 5.1.3.1]

For the PDSCH scheduled by a PDCCH with DCI format 1_0 or format 1_1 with CRC scrambled by C-RNTI, new-RNTI, TC-RNTI, CS-RNTI, SI-RNTI, RA-RNTI, or P-RNTI,

if the higher layer parameter *mcs-Table* given by *PDSCH-Config* is set to 'qam256', and the PDSCH is scheduled by a PDCCH with a DCI format 1_1 and the CRC is scrambled by C-RNTI or CS-RNTI

- the UE shall use I_{MCS} and Table 5.1.3.1-2 to determine the modulation order (Q_m) and Target code rate (R) used in the physical downlink shared channel.

elseif the UE is not configured with new-RNTI, the higher layer parameter *mcs-Table* given by *PDSCH-Config* is set to 'qam64LowSE', and the PDSCH is scheduled with C-RNTI, and the PDSCH is assigned by a PDCCH in a UE-specific search space

- the UE shall use I_{MCS} and Table 5.1.3.1-3 to determine the modulation order (Q_m) and Target code rate (R) used in the physical downlink shared channel.

elseif the UE is configured with new-RNTI, and the PDSCH is scheduled with new-RNTI

- the UE shall use I_{MCS} and Table 5.1.3.1-3 to determine the modulation order (Q_m) and Target code rate (R) used in the physical downlink shared channel.

elseif the UE is not configured with the higher layer parameter *mcs-Table* given by *SPS-config*, the higher layer parameter *mcs-Table* given by *PDSCH-Config* is set to 'qam256', the PDSCH is scheduled with CS-RNTI, and the PDSCH is assigned by a PDCCH with DCI format 1_1

- the UE shall use I_{MCS} and Table 5.1.3.1-2 to determine the modulation order (Q_m) and Target code rate (R) used in the physical downlink shared channel.

elseif the UE is configured with the higher layer parameter *mcs-Table* given by *SPS-config* set to 'qam64LowSE', and the PDSCH is scheduled with CS-RNTI

- the UE shall use I_{MCS} and Table 5.1.3.1-3 to determine the modulation order (Q_m) and Target code rate (R) used in the physical downlink shared channel.

else

- the UE shall use I_{MCS} and Table 5.1.3.1-1 to determine the modulation order (Q_m) and Target code rate (R) used in the physical downlink shared channel.

End

The UE is not expected to decode a PDSCH scheduled with P-RNTI, RA-RNTI, SI-RNTI and $Q_m > 2$

Table 5.1.3.1-1: MCS index table 1 for PDSCH

MCS Index I_{MCS}	Modulation Order Q_m	Target code Rate $R \times [1024]$	Spectral efficiency
0	2	120	0.2344
1	2	157	0.3066
2	2	193	0.3770
3	2	251	0.4902
4	2	308	0.6016
5	2	379	0.7402
6	2	449	0.8770
7	2	526	1.0273
8	2	602	1.1758
9	2	679	1.3262
10	4	340	1.3281
11	4	378	1.4766
12	4	434	1.6953
13	4	490	1.9141
14	4	553	2.1602
15	4	616	2.4063
16	4	658	2.5703
17	6	438	2.5664
18	6	466	2.7305
19	6	517	3.0293
20	6	567	3.3223
21	6	616	3.6094
22	6	666	3.9023
23	6	719	4.2129
24	6	772	4.5234
25	6	822	4.8164
26	6	873	5.1152
27	6	910	5.3320
28	6	948	5.5547
29	2	reserved	
30	4	reserved	
31	6	reserved	

[TS 38.214, clause 5.1.3.2]

In case the higher layer parameter *maxNrofCodeWordsScheduledByDCI* indicates that two codeword transmission is enabled, then a transport block is disabled by DCI format 1_1 if $I_{MCS} = 26$ and if $rv_{id} = 1$ for the corresponding transport block, otherwise the transport block is enabled. If both transport blocks are enabled, transport block 1 and 2 are mapped to codeword 0 and 1 respectively. If only one transport block is enabled, then the enabled transport block is always mapped to the first codeword.

For the PDSCH assigned by a PDCCH with DCI format 1_0 or format 1_1 with CRC scrambled by C-RNTI, new-RNTI, TC-RNTI, CS-RNTI, or SI-RNTI, if Table 5.1.3.1-2 is used and $0 \leq I_{MCS} \leq 27$, or a table other than Table 5.1.3.1-2 is used and $0 \leq I_{MCS} \leq 28$, the UE shall, except if the transport block is disabled in DCI format 1_1, first determine the TBS as specified below:

- 1) The UE shall first determine the number of REs (N_{RE}) within the slot.

- A UE first determines the number of REs allocated for PDSCH within a PRB (N'_{RE}) by

$$N'_{RE} = N_{sc}^{RB} \cdot N_{ymb}^{sh} - N_{DMRS}^{PRB} - N_{oh}^{PRB}$$
, where $N_{sc}^{RB} = 12$ is the number of subcarriers in a physical resource block, N_{ymb}^{sh} is the number of symbols of the PDSCH allocation within the slot, N_{DMRS}^{PRB} is the number of REs for DM-RS per PRB in the scheduled duration including the overhead of the DM-RS CDM groups without data, as indicated by DCI format 1_1 or as described for format 1_0 in Subclause 5.1.6.2, and N_{oh}^{PRB} is the overhead configured by higher layer parameter $xOverhead$ in *PDSCH-ServingCellConfig*. If the $xOverhead$ in *PDSCH-ServingCellconfig* is not configured (a value from 0, 6, 12, or 18), the N_{oh}^{PRB} is set to 0. If the PDSCH is scheduled by PDCCH with a CRC scrambled by SI-RNTI, RA-RNTI or P-RNTI, N_{oh}^{PRB} is assumed to be 0.
- A UE determines the total number of REs allocated for PDSCH (N_{RE}) by $N_{RE} = \min(156, N'_{RE}) \cdot n_{PRB}$, where n_{PRB} is the total number of allocated PRBs for the UE.

2) Intermediate number of information bits (N_{info}) is obtained by $N_{info} = N_{RE} \cdot R \cdot Q_m \cdot v$.

If $N_{info} \leq 3824$

Use step 3 as the next step of the TBS determination

else

Use step 4 as the next step of the TBS determination

end if

3) When $N_{info} \leq 3824$, TBS is determined as follows

- quantized intermediate number of information bits $N'_{info} = \max\left(24, 2^n \cdot \left\lfloor \frac{N_{info}}{2^n} \right\rfloor\right)$, where

$$n = \max(3, \log_2(N_{info})) - 6$$
.
- use Table 5.1.3.2-2 find the closest TBS that is not less than N'_{info} .

Table 5.1.3.2-2: TBS for $N_{info} \leq 3824$

Index	TBS	Index	TBS	Index	TBS	Index	TBS
1	24	31	336	61	1288	91	3624
2	32	32	352	62	1320	92	3752
3	40	33	368	63	1352	93	3824
4	48	34	384	64	1416		
5	56	35	408	65	1480		
6	64	36	432	66	1544		
7	72	37	456	67	1608		
8	80	38	480	68	1672		
9	88	39	504	69	1736		
10	96	40	528	70	1800		
11	104	41	552	71	1864		
12	112	42	576	72	1928		
13	120	43	608	73	2024		
14	128	44	640	74	2088		
15	136	45	672	75	2152		
16	144	46	704	76	2216		
17	152	47	736	77	2280		
18	160	48	768	78	2408		
19	168	49	808	79	2472		
20	176	50	848	80	2536		
21	184	51	888	81	2600		
22	192	52	928	82	2664		
23	208	53	984	83	2728		
24	224	54	1032	84	2792		
25	240	55	1064	85	2856		
26	256	56	1128	86	2976		
27	272	57	1160	87	3104		
28	288	58	1192	88	3240		
29	304	59	1224	89	3368		
30	320	60	1256	90	3496		

4) When $N_{info} > 3824$, TBS is determined as follows.

- quantized intermediate number of information bits $N'_{info} = \max\left(3840, 2^n \times \text{round}\left(\frac{N_{info} - 24}{2^n}\right)\right)$, where $n = \lfloor \log_2(N_{info} - 24) \rfloor - 5$ and ties in the round function are broken towards the next largest integer.
- if $R \leq 1/4$

$$TBS = 8 \cdot C \cdot \left\lceil \frac{N'_{info} + 24}{8 \cdot C} \right\rceil - 24, \text{ where } C = \left\lceil \frac{N'_{info} + 24}{3816} \right\rceil$$

else

if $N'_{info} > 8424$

$$TBS = 8 \cdot C \cdot \left\lceil \frac{N'_{info} + 24}{8 \cdot C} \right\rceil - 24, \text{ where } C = \left\lceil \frac{N'_{info} + 24}{8424} \right\rceil$$

else

$$TBS = 8 \cdot \left\lceil \frac{N'_{info} + 24}{8} \right\rceil - 24$$

end if

end if

7.1.1.4.1.3.3 Test description

7.1.1.4.1.3.3.1 Pre-test conditions

Same Pre-test conditions as in clause 7.1.1.0 except set the NR Cell bandwidth and applicable BWP to maximum for the NR Band under test as specified in Table 5.3.5-1 in TS 38.101-1 [16] / TS 38.101-2 [17] (to enable testing of n_{PRB} up to maximum value).

Test frequency NRf1 is as specified in TS 38.508-1 [4] clause 4.3.1 using the common highest UL and DL channel bandwidth and using the default subcarrier spacing specified in TS 38.508-1 [4] clause 6.2.3.1.

7.1.1.4.1.3.3.2 Test procedure sequence

Table 7.1.1.4.1.3.3.2-1: Maximum TBS for different UE categories

UE Category	Maximum number of bits of a UL-SCH transport block received within a TTI
TS 38.306 [23] clause 4.1.2 require UE without <i>ue-CategoryDL</i> and <i>ue-CategoryUL</i> , to support Max TBS achievable based on max bandwidth of the Band under test.	

Table 7.1.1.4.1.3.3.2-2: Number of downlink PDCP SDUs and PDCP SDU size used as test data

TBS [bits]	Number of PDCP SDUs	PDCP SDU size [bits] (Note 1)
$192 \leq \text{TBS} \leq 12184$ note 2	1	$8 * \text{FLOOR}((\text{TBS} - 184)/8)$
$12185 \leq \text{TBS} \leq 24256$	2	$8 * \text{FLOOR}((\text{TBS} - 256)/16)$
$24257 \leq \text{TBS} \leq 36328$	3	$8 * \text{FLOOR}((\text{TBS} - 328)/24)$
$36329 \leq \text{TBS} \leq 48400$	4	$8 * \text{FLOOR}((\text{TBS} - 400)/32)$
$48401 \leq \text{TBS} \leq 60472$	5	$8 * \text{FLOOR}((\text{TBS} - 472)/40)$
$60473 \leq \text{TBS} \leq 72544$	6	$8 * \text{FLOOR}((\text{TBS} - 544)/48)$
$72545 \leq \text{TBS} \leq 84616$	7	$8 * \text{FLOOR}((\text{TBS} - 616)/56)$
$84617 \leq \text{TBS} \leq 96688$	8	$8 * \text{FLOOR}((\text{TBS} - 688)/64)$
$96689 < \text{TBS} \leq 108760$	9	$8 * \text{FLOOR}((\text{TBS} - 760)/72)$
$108761 \leq \text{TBS} \leq 120832$	10	$8 * \text{FLOOR}((\text{TBS} - 832)/80)$
$120833 \leq \text{TBS} \leq 132904$	11	$8 * \text{FLOOR}((\text{TBS} - 904)/88)$
$132905 \leq \text{TBS} \leq 144976$	12	$8 * \text{FLOOR}((\text{TBS} - 976)/96)$
$\text{TBS} > 144976$	13	$8 * \text{FLOOR}((\text{TBS} - 1048)/104)$
<p>Note 1: Each PDCP SDU is limited to 1500 octets (to keep below maximum SDU size of ESM as specified in TS 24.301 [21] clause 9.9.4.12).</p> <p>The PDCP SDU size of each PDCP SDU is</p> <p>PDCP SDU size = (TBS – N*PDCP header size – N*AMD PDU header size – N*MAC header size – Size of Timing Advance – RLC Status PDU size- MAC header for RLC Status PDU – 32 bit Additional RLC header with SO if one RLC SDU gets split in 2 TBS and 24 bit MAC header for this additional PDU) / N, where</p> <p>PDCP header size is 24 bits for the RLC AM and 18-bit SN case; AMD PDU header size is 24 bits with 18 bit SN;</p> <p>MAC header size for AMD PDU = 16 or 24 bits depending on L=8 or 16 bits. Worst case 24 is taken.</p> <p>Size of Timing Advance MAC CE with header is 16 bits (if no Timing Advance and/or RLC status needs to be sent, padding will occur instead). IF RLC SDU does not get split the 32 bits additional padding gets added instead</p> <p>RLC Status PDU size = 24 bits with 1 ACK_SN, With a MAC header of 16 bits.</p> <p>This gives:</p> <p>PDCP SDU size = $8 * \text{FLOOR}((\text{TBS} - N * 24 - N * 24 - N * 24 - 112) / (8 * N))$ bits.</p> <p>Note 2: According to the final PDCP SDU size formula in Note 1, the smallest TBS that can be tested is 192 bits.</p>		

Table 7.1.1.4.1.3.3.2-2A: Bandwidth part Dependent Parameters for Resource allocation 0 with start of BWP assumed as 0

$N_{RB}^{DL,BWP} = N_{BWP,i}^{size}$	Nominal RBG size P (Configuration1)	Size of last RBG	Allowed N_{PRB} Values
11	2	1	All 1...11
18	2	2	2,4,6,8,10,12,16,18
24	2	2	2,4,6,8,10,12,16,18,20,22,24
25	2	1	All 1...25
31	2	1	All 1...31
32	2	2	2,4,6,8,10,12,16,18,20,22,24,26,28,30,32
38	4	2	2,4,6,8,10,12,16,18,20,22,24,26,28,30,32,34,36,38
51	4	3	3,4,7,8,11,12,15,16,19,20,23,24,27,28,31,32,35,36,39,40,43,44,47,48,51
52	4	4	4,8,12,16,20,24,28,32,36,40,44,48,52
65	4	1	1,4,5,8,9,12,13,16,17,20,21,24,25,28,29,32,33,36,37,40,41,44,45,48,49,52,53,56,57,60,61,64,65
66	4	2	2,4,6,8,10,12,16,18,20,22,24,26,28,30,32,34,36,38,40,42,44,46,48,50,52,54,56,58,60,62,64,66
79	8	7	7,8,15,16,23,24,31,32,39,40,47,48,55,56,63,64,71,72,79
106	8	2	2,8,10,16,18,24,26,32,34,40,42,48,50,56,58,64,66,72,74,80,82,88,90,96,92,104,106
107	8	3	3,8,11,16,19,24,27,32,35,40,43,48,51,56,59,64,67,72,75,80,83,88,91,96,99,104,107
132	8	4	4,8,12,16,20,24,28,32,36,40,44,48,52,56,60,64,68,72,76,80,84,88,92,96,100,104,108,112,116,120,124,128,132
133	8	5	5,8,13,16,21,24,29,32,37,40,45,48,53,56,61,64,69,72,77,80,85,88,93,96,101,104,109,112,117,120,125,128,133
135	8	7	7,8,15,16,23,24,31,32,39,40,47,48,55,56,63,64,71,72,79,80,87,88,95,96,103,104,111,112,119,120,127,128,135
160	16	16	16,32,48,64,80,96,112,128,144,160
216	16	8	8,16,24,32,40,48,56,64,72,80,88,96,104,112,120,128,136,144,152,160,168,176,184,192,200,208,216
217	16	9	9,16,25,32,41,48,57,64,73,80,89,96,105,112,121,128,137,144,153,160,169,176,185,192,201,208,217
264	16	8	8,16,24,32,40,48,56,64,72,80,88,96,104,112,120,128,136,144,160,168,176,184,192,200,208,216,224,232,240,248,256,264
270	16	14	14,16,30,32,46,44,62,64,78,80,94,96,110,112,126,128,142,144,158,160,174,176,190,192,206,208,222,224,238,240,254,256,270
273	16	1	1,16,17,32,33,48,49,64,65,80,81,96,97,112,113,128,129,144,145,160,161,176,171,192,193,208,209,224,225,240,241,256,257,272,273

Table 7.1.1.4.1.3.3.2-3: Specific Parameter

Parameter	Value	Comments	Condition
number of layers (v)	1		
mcs-Table	qam64		
resourceAllocation	dynamicSwitch		pc_dynamicSwitchRA_Type0_1_PDSCH
	resourceAllocationType0		NOT pc_dynamicSwitchRA_Type0_1_PDSCH AND Steps 1-5
	resourceAllocationType1		NOT pc_dynamicSwitchRA_Type0_1_PDSCH AND Steps 6-10
maxNrofCodeWordsScheduledByDCI	n2	both codewords enabled	
N_{BWP}^{start}	0		

Table 7.1.1.4.1.3.3.2-4: Main behaviour

St	Procedure	Message Sequence		TP	Verdict
		U - S	Message		
-	EXCEPTION: Steps 1 to 5 are repeated for allowed values of N_{PRB} as per table 7.1.1.4.1.3.3.2-2A in BWP, time domain resource as per table 7.1.1.4.1.0-1 and I_{MCS} from 0 to 28. NOTE: Skip the execution of steps for which the TBS size results in coding rate exceeding 0.95.	-	-	-	-
1	SS calculates or looks up TBS in TS 38.214 [15] based on the value of S, L, I_{MCS} and n_{PRB} . The SS uses the same I_{MCS} and TBS for both transport blocks: $I_{MCS\#1} = I_{MCS\#2} = I_{MCS}$ TBS 1= TBS 2= TBS	-	-	-	-
-	EXCEPTION: Steps 2 to 5 are performed if TBS1 + TBS2 is less than or equal to UE capability "Maximum number of DL-SCH transport block bits received within a TTI" as specified in Table 7.1.1.4.1.3.3.2-1 and larger than or equal to 192 bits as specified in Table 7.1.1.4.1.3.3.2-2.	-	-	-	-
2	SS creates one or more PDCP SDUs for transport block 1 and 2 depending on TBS1, and TBS2 in accordance with Table 7.1.1.4.1.3.3.2-2.	-	-	-	-
3	SS transmits the PDCP SDUs concatenated into a MAC PDU and indicates on PDCCH DCI Format 1_1 resource allocation 0 and values of S, L, $I_{MCS\#1}$, $I_{MCS\#2}$ and n_{PRB} .	<->	Transport block 1: MAC PDU Transport block 2: MAC PDU DCI: (DCI Format 1_1, S, L, $I_{MCS\#1}$, $I_{MCS\#2}$ and n_{PRB})	-	-
4	At the reception of scheduling request the SS transmits UL Grant for transmitting loop back PDCP SDUs.	<->	(UL Grant)	-	-
5	CHECK: Does UE return the same number of PDCP SDUs with same content as transmitted by the SS in step 3?	-->	(NxPDCP SDUs)	1	P
-	EXCEPTION : Steps 5Aa1 to 5Aa2 are executed if NOT <code>pc_dynamicSwitchRA_Type0_1_PDSCH</code>	-	-	-	-
5A a1	The SS transmits a NR RRCReconfiguration message including <i>PDSCH-Config</i> with IE <code>resourceAllocationType1</code> (Note 1)	<->	<i>RRCReconfiguration</i>	-	-
5A a2	The UE transmit a NR <i>RRCReconfigurationComplete</i> message. (Note 2)	-->	<i>RRCReconfigurationComplete</i>	-	-
-	EXCEPTION: Steps 6 to 10 are repeated for allowed values of N_{PRB} 1 to $N_{RB}^{DL,BWP}$ in BWP, time domain resource as per table 7.1.1.4.1.0-1 and I_{MCS} from 0 to 28.	-	-	-	-

6	SS calculates or looks up TBS in TS 38.214 [15] based on the value of S, L, I_{MCS} and n_{PRB} . The SS uses the same I_{MCS} and TBS for both transport blocks: $I_{MCS\#1} = I_{MCS\#2} = I_{MCS}$ TBS 1= TBS 2= TBS	-	-	-	-
-	EXCEPTION: Steps 7 to 10 are performed if TBS1 + TBS2 is less than or equal to UE capability "Maximum number of DL-SCH transport block bits received within a TTI" as specified in Table 7.1.1.4.1.3.3.2-1 and larger than or equal to 192 bits as specified in Table 7.1.1.4.1.3.3.2-2.	-	-	-	-
7	SS creates one or more PDCP SDUs for transport block 1 and 2 depending on TBS1, and TBS2 in accordance with Table 7.1.1.4.1.3.3.2-2.	-	-	-	-
8	SS transmits the PDCP SDUs concatenated into a MAC PDU and indicates on PDCCH DCI Format 1_1 resource allocation 1 and values of S, L, $I_{MCS\#1}$, $I_{MCS\#2}$ and n_{PRB} .	<-	Transport block 1: MAC PDU Transport block 2: MAC PDU DCI: (DCI Format 1_1, S, L, $I_{MCS\#1}$, $I_{MCS\#2}$ and n_{PRB})	-	-
9	At the reception of scheduling request the SS transmits UL Grant for transmitting loop back PDCP SDUs.	<-	(UL Grant)	-	-
10	CHECK: Does UE return the same number of PDCP SDUs with same content as transmitted by the SS in step 3?	->	(NxPDCP SDUs)	2	P
<p>Note 1: For EN-DC the NR RRCReconfiguration message is contained in RRCConnectionReconfiguration 36.508 [7], Table 4.6.1-8 using condition EN-DC_EmbedNR_RRCRecon.</p> <p>Note 2: For EN-DC the NR RRCReconfigurationComplete message is contained in RRCConnectionReconfigurationComplete.</p>					

7.1.1.4.1.3.3.3 Specific message contents

None.

7.1.1.4.1.4 DL-SCH transport block size selection / DCI format 1_1 / RA type 0/RA Type 1 / 2 Codewords enabled / 256QAM

7.1.1.4.1.4.1 Test Purpose (TP)

(1)

```
with { UE in RRC_CONNECTED state, maxNrofCodeWordsScheduledByDCI set to 'n2' and mcs-Table is set as 'qam256' }
ensure that {
  when { UE on PDCCH receives DCI format 1_1 indicating resource allocation type 0 a resource block assignment correspondent to physical resource blocks, Time domain resource assignment and a modulation and coding }
  then { UE decodes the received transport block of size correspondent as per Modulation Coding scheme, time domain resource allocation and PRB's and forwards it to higher layers }
}
```

(2)

```
with { UE in RRC_CONNECTED state, maxNrofCodeWordsScheduledByDCI set to 'n2' and mcs-Table is set as 'qam256' }
ensure that {
```

```

when { UE on PDCCH receives DCI format 1_1 indicating resource allocation type 1 a resource block
assignment correspondent to physical resource blocks , Time domain resource assignment and a
modulation and coding }
then { UE decodes the received transport block of size correspondent as per Modulation Coding
scheme, time domain resource allocation and PRB's and forwards it to higher layers }
}

```

7.1.1.4.1.4.2 Conformance requirements

References: The conformance requirements covered in the present TC are specified in: TS 38.212 clause 7.3.1.2.2, TS 38.214 clauses 5.1.2.1, 5.1.2.2.1, 5.1.2.2.2, 5.1.3, 5.1.3.1 and 5.1.3.2. Unless otherwise stated these are Rel-15 requirements.

[TS 38.212, clause 7.3.1.2.2]

DCI format 1_1 is used for the scheduling of PDSCH in one cell.

The following information is transmitted by means of the DCI format 1_1 with CRC scrambled by C-RNTI or CS-RNTI or new-RNTI:

- Identifier for DCI formats – 1 bits
- The value of this bit field is always set to 1, indicating a DL DCI format
- Carrier indicator – 0 or 3 bits as defined in Subclause 10.1 of [5, TS38.213].
- Bandwidth part indicator – 0, 1 or 2 bits as determined by the number of DL BWPs $n_{\text{BWP,RRC}}$ configured by higher layers, excluding the initial DL bandwidth part. The bit width for this field is determined as $\lceil \log_2(n_{\text{BWP}}) \rceil$ bits, where
 - $n_{\text{BWP}} = n_{\text{BWP,RRC}} + 1$ if $n_{\text{BWP,RRC}} \leq 3$, in which case the bandwidth part indicator is equivalent to the higher layer parameter *BWP-Id*;
 - otherwise $n_{\text{BWP}} = n_{\text{BWP,RRC}}$, in which case the bandwidth part indicator is defined in Table 7.3.1.1.2-1;

If a UE does not support active BWP change via DCI, the UE ignores this bit field.

- Frequency domain resource assignment – number of bits determined by the following, where $N_{\text{RB}}^{\text{DL,BWP}}$ is the size of the active DL bandwidth part:
 - N_{RBG} bits if only resource allocation type 0 is configured, where N_{RBG} is defined in Subclause 5.1.2.2.1 of [6, TS38.214],
 - $\lceil \log_2(N_{\text{RB}}^{\text{DL,BWP}}(N_{\text{RB}}^{\text{DL,BWP}} + 1)/2) \rceil$ bits if only resource allocation type 1 is configured, or
 - $\max\left(\lceil \log_2(N_{\text{RB}}^{\text{DL,BWP}}(N_{\text{RB}}^{\text{DL,BWP}} + 1)/2) \rceil, N_{\text{RBG}}\right) + 1$ bits if both resource allocation type 0 and 1 are configured.
 - If both resource allocation type 0 and 1 are configured, the MSB bit is used to indicate resource allocation type 0 or resource allocation type 1, where the bit value of 0 indicates resource allocation type 0 and the bit value of 1 indicates resource allocation type 1.
 - For resource allocation type 0, the N_{RBG} LSBs provide the resource allocation as defined in Subclause 5.1.2.2.1 of [6, TS38.214].
 - For resource allocation type 1, the $\lceil \log_2(N_{\text{RB}}^{\text{DL,BWP}}(N_{\text{RB}}^{\text{DL,BWP}} + 1)/2) \rceil$ LSBs provide the resource allocation as defined in Subclause 5.1.2.2.2 of [6, TS38.214]

If “Bandwidth part indicator” field indicates a bandwidth part other than the active bandwidth part and if both resource allocation type 0 and 1 are configured for the indicated bandwidth part, the UE assumes resource allocation type 0 for the indicated bandwidth part if the bit width of the “Frequency domain resource

assignment” field of the active bandwidth part is smaller than the bit width of the “Frequency domain resource assignment” field of the indicated bandwidth part.

- Time domain resource assignment – 0, 1, 2, 3, or 4 bits as defined in Subclause 5.1.2.1 of [6, TS38.214]. The bit width for this field is determined as $\lceil \log_2(I) \rceil$ bits, where I is the number of entries in the higher layer parameter *pusch-AllocationList*.
- VRB-to-PRB mapping – 0 or 1 bit
 - 0 bit if only resource allocation type 0 is configured;
 - 1 bit according to Table 7.3.1.1.2-33 otherwise, only applicable to resource allocation type 1, as defined in Subclause 7.3.1.6 of [4, TS38.211].
- PRB bundling size indicator – 0 bit if the higher layer parameter *prb-BundlingType* is not configured or is set to ‘static’, or 1 bit if the higher layer parameter *prb-BundlingType* is set to ‘dynamic’, according to Subclause 5.1.2.3 of [6, TS38.214].
- Rate matching indicator – 0, 1, or 2 bits according to higher layer parameter *rateMatchPattern*.
- ZP CSI-RS trigger – 0, 1, or 2 bits as defined in Subclause 5.1.4.2 of [6, TS38.214]. The bit width for this field is determined as $\lceil \log_2(n_{ZP} + 1) \rceil$ bits, where n_{ZP} is the number of ZP CSI-RS resource sets in the higher layer parameter *zP-CSI-RS-Resource*.

For transport block 1:

- Modulation and coding scheme – 5 bits as defined in Subclause 5.1.3.1 of [6, TS38.214]
- New data indicator – 1 bit
- Redundancy version – 2 bits as defined in Table 7.3.1.1.1-2

For transport block 2 (only present if *maxNrofCodeWordsScheduledByDCI* equals 2

- Modulation and coding scheme – 5 bits as defined in Subclause 5.1.3.1 of [6, TS38.214]
- New data indicator – 1 bit
- Redundancy version – 2 bits as defined in Table 7.3.1.1.1-2

If “Bandwidth part indicator” field indicates a bandwidth part other than the active bandwidth part and the value of *maxNrofCodeWordsScheduledByDCI* for the indicated bandwidth part equals 2 and the value of *maxNrofCodeWordsScheduledByDCI* for the active bandwidth part equals 1, the UE assumes zeros are padded when interpreting the “Modulation and coding scheme”, “New data indicator”, and “Redundancy version” fields of transport block 2 according to Subclause 12 of [5, TS38.213], and the UE ignores the “Modulation and coding scheme”, “New data indicator”, and “Redundancy version” fields of transport block 2 for the indicated bandwidth part.

- HARQ process number – 4 bits
- Downlink assignment index – number of bits as defined in the following
 - 4 bits if more than one serving cell are configured in the DL and the higher layer parameter *pdsch-HARQ-ACK-Codebook=dynamic*, where the 2 MSB bits are the counter DAI and the 2 LSB bits are the total DAI;
 - 2 bits if only one serving cell is configured in the DL and the higher layer parameter *pdsch-HARQ-ACK-Codebook=dynamic*, where the 2 bits are the counter DAI;
 - 0 bits otherwise.
- TPC command for scheduled PUCCH – 2 bits as defined in Subclause 7.2.1 of [5, TS38.213]
- PUCCH resource indicator – 3 bits as defined in Subclause 9.2.3 of [5, TS38.213]

- PDSCH-to-HARQ_feedback timing indicator – 0, 1, 2, or 3 bits as defined in Subclause 9.2.3 of [5, TS38.213]. The bit width for this field is determined as $\lceil \log_2(I) \rceil$ bits, where I is the number of entries in the higher layer parameter *dl-DataToUL-ACK*.
- Antenna port(s) – 4, 5, or 6 bits as defined by Tables 7.3.1.2.2-1/2/3/4, where the number of CDM groups without data of values 1, 2, and 3 refers to CDM groups {0}, {0,1}, and {0, 1,2} respectively. The antenna ports $\{p_0, \dots, p_{v-1}\}$ shall be determined according to the ordering of DMRS port(s) given by Tables 7.3.1.2.2-1/2/3/4.

If a UE is configured with both *dmrs-DownlinkForPDSCH-MappingTypeA* and *dmrs-DownlinkForPDSCH-MappingTypeB*, the bit width of this field equals $\max\{x_A, x_B\}$, where x_A is the “Antenna ports” bit width derived according to *dmrs-DownlinkForPDSCH-MappingTypeA* and x_B is the “Antenna ports” bit width derived according to *dmrs-DownlinkForPDSCH-MappingTypeB*. A number of $|x_A - x_B|$ zeros are padded in the MSB of this field, if the mapping type of the PDSCH corresponds to the smaller value of x_A and x_B .

- Transmission configuration indication – 0 bit if higher layer parameter *tci-PresentInDCI* is not enabled; otherwise 3 bits as defined in Subclause 5.1.5 of [6, TS38.214].

If “Bandwidth part indicator” field indicates a bandwidth part other than the active bandwidth part and the “Transmission configuration indication” field is not present in the DCI format 1_1, the UE assumes *tci-PresentInDCI* is not enabled for the indicated bandwidth part.

- SRS request – 2 bits as defined by Table 7.3.1.1.2-24 for UEs not configured with SUL in the cell; 3 bits for UEs configured SUL in the cell where the first bit is the non-SUL/SUL indicator as defined in Table 7.3.1.1.1-1 and the second and third bits are defined by Table 7.3.1.1.2-24. This bit field may also indicate the associated CSI-RS according to Subclause 6.1.1.2 of [6, TS 38.214].
- CBG transmission information (CBGTI) – 0, 2, 4, 6, or 8 bits as defined in Subclause 5.1.7 of [6, TS38.214], determined by the higher layer parameters *maxCodeBlockGroupsPerTransportBlock* and *Number-MCS-HARQ-DL-DCI* for the PDSCH.
- CBG flushing out information (CBGFI) – 0 or 1 bit as defined in Subclause 5.1.7 of [6, TS38.214], determined by higher layer parameter *codeBlockGroupFlushIndicator*.
- DMRS sequence initialization – 1 bit if both *scramblingID0* and *scramblingID1* are configured in *DMRS-DownlinkConfig* for n_{SCID} selection defined in Subclause 7.4.1.1.1 of [4, TS38.211]; 0 bit otherwise.

[TS 38.214, clause 5.1.2.1]

When the UE is scheduled to receive PDSCH by a DCI, the *Time domain resource assignment* field value m of the DCI provides a row index $m + 1$ to an allocation table. The determination of the used resource allocation table is defined in sub-clause 5.1.2.1.1. The indexed row defines the slot offset K_0 , the start and length indicator *SLIV*, or directly the start symbol S and the allocation length L , and the PDSCH mapping type to be assumed in the PDSCH reception.

Given the parameter values of the indexed row:

- The slot allocated for the PDSCH is $\left\lceil n \cdot \frac{2^{\mu_{\text{PDSCH}}}}{2^{\mu_{\text{PDCCH}}}} \right\rceil + K_0$, where n is the slot with the scheduling DCI, and K_0 is based on the numerology of PDSCH, and μ_{PDSCH} and μ_{PDCCH} are the subcarrier spacing configurations for PDSCH and PDCCH, respectively, and
- The starting symbol S relative to the start of the slot, and the number of consecutive symbols L counting from the symbol S allocated for the PDSCH are determined from the start and length indicator *SLIV*:

if $(L-1) \leq 7$ then

$$SLIV = 14 \cdot (L-1) + S$$

else

$$SLIV = 14 \cdot (14 - L + 1) + (14 - 1 - S)$$

where $0 < L \leq 14 - S$, and

- The PDSCH mapping type is set to Type A or Type B as defined in sub-clause 7.4.1.1.2 of [4, TS 38.211].

The UE shall consider the S and L combinations defined in table 5.1.2.1-1 as valid PDSCH allocations:

Table 5.1.2.1-1: Valid S and L combinations

PDSCH mapping type	Normal cyclic prefix			Extended cyclic prefix		
	S	L	$S+L$	S	L	$S+L$
Type A	{0,1,2,3 (Note 1)}	{3,...,14}	{3,...,14}	{0,1,2,3 (Note 1)}	{3,...,12}	{3,...,12}
Type B	{0,...,12}	{2,4,7}	{2,...,14}	{0,...,10}	{2,4,6}	{2,...,12}

Note 1: $S = 3$ is applicable only if $dmrs\text{-}TypeA\text{-}Position = 3$

[TS 38.214, clause 5.1.2.2.1]

In downlink resource allocation of type 0, the resource block assignment information includes a bitmap indicating the Resource Block Groups (RBGs) that are allocated to the scheduled UE where a RBG is a set of consecutive virtual resource blocks defined by higher layer parameter $rbg\text{-}Size$ configured for PDSCH and the size of the carrier bandwidth part as defined in Table 5.1.2.2.1-1.

Table 5.1.2.2.1-1: Nominal RBG size P

Bandwidth Part Size	Configuration 1	Configuration 2
1 – 36	2	4
37 – 72	4	8
73 – 144	8	16
145 – 275	16	16

The total number of RBGs (N_{RBG}) for a downlink carrier bandwidth part i of size $N_{BWP,i}^{size}$ PRBs is given by

$$N_{RBG} = \left(N_{BWP,i}^{size} + \left(N_{BWP,i}^{start} \bmod P \right) \right) / P \Big|, \text{ where}$$

- the size of the first RBG is $RBG_0^{size} = P - N_{BWP,i}^{start} \bmod P$,
- the size of last RBG is $RBG_{last}^{size} = \left(N_{BWP,i}^{start} + N_{BWP,i}^{size} \right) \bmod P$ if $\left(N_{BWP,i}^{start} + N_{BWP,i}^{size} \right) \bmod P > 0$ and P otherwise,
- the size of all other RBGs is P .

The bitmap is of size N_{RBG} bits with one bitmap bit per RBG such that each RBG is addressable. The RBGs shall be indexed in the order of increasing frequency and starting at the lowest frequency of the carrier bandwidth part. The order of RBG bitmap is such that RBG 0 to RBG $N_{RBG} - 1$ are mapped from MSB to LSB. The RBG is allocated to the UE if the corresponding bit value in the bitmap is 1, the RBG is not allocated to the UE otherwise.

[TS 38.214, clause 5.1.2.2.2]

In downlink resource allocation of type 1, the resource block assignment information indicates to a scheduled UE a set of contiguously allocated localized or distributed virtual resource blocks within the active carrier bandwidth part of size N_{BWP}^{size} PRBs except for the case when DCI format 1_0 is decoded in the common search space in CORESET 0 in which case the initial bandwidth part of size N_{BWP}^{size} shall be used.

A downlink type 1 resource allocation field consists of a resource indication value (RIV) corresponding to a starting virtual resource block (RB_{start}) and a length in terms of contiguously allocated resource blocks L_{RBs} . The resource indication value is defined by

$$\text{if } (L_{RBs} - 1) \leq \left\lfloor N_{BWP}^{size} / 2 \right\rfloor \text{ then}$$

$$RIV = N_{BWP}^{size} (L_{RBs} - 1) + RB_{start}$$

else

$$RIV = N_{BWP}^{size} (N_{BWP}^{size} - L_{RBs} + 1) + (N_{BWP}^{size} - 1 - RB_{start})$$

where $L_{RBs} \geq 1$ and shall not exceed $N_{BWP}^{size} - RB_{start}$.

[TS 38.214, clause 5.1.3]

To determine the modulation order, target code rate, and transport block size(s) in the physical downlink shared channel, the UE shall first

- read the 5-bit *modulation and coding scheme* field (I_{MCS}) in the DCI to determine the modulation order (Q_m) and target code rate (R) based on the procedure defined in Subclause 5.1.3.1, and
- read *redundancy version* field (rv) in the DCI to determine the redundancy version..

and second

- the UE shall use the number of layers (v), the total number of allocated PRBs before rate matching (n_{PRB}) to determine to the transport block size based on the procedure defined in Subclause 5.1.3.2.

The UE may skip decoding a transport block in an initial transmission if the effective channel code rate is higher than 0.95, where the effective channel code rate is defined as the number of downlink information bits (including CRC bits) divided by the number of physical channel bits on PDSCH. If the UE skips decoding, the physical layer indicates to higher layer that the transport block is not successfully decoded.

[TS 38.214, clause 5.1.3.1]

For the PDSCH scheduled by a PDCCH with DCI format 1_0 or format 1_1 with CRC scrambled by C-RNTI, new-RNTI, TC-RNTI, CS-RNTI, SI-RNTI, RA-RNTI, or P-RNTI,

if the higher layer parameter *mcs-Table* given by *PDSCH-Config* is set to 'qam256', and the PDSCH is scheduled by a PDCCH with a DCI format 1_1 and the CRC is scrambled by C-RNTI or CS-RNTI

- the UE shall use I_{MCS} and Table 5.1.3.1-2 to determine the modulation order (Q_m) and Target code rate (R) used in the physical downlink shared channel.

elseif the UE is not configured with new-RNTI, the higher layer parameter *mcs-Table* given by *PDSCH-Config* is set to 'qam64LowSE', and the PDSCH is scheduled with C-RNTI, and the PDSCH is assigned by a PDCCH in a UE-specific search space

- the UE shall use I_{MCS} and Table 5.1.3.1-3 to determine the modulation order (Q_m) and Target code rate (R) used in the physical downlink shared channel.

elseif the UE is configured with new-RNTI, and the PDSCH is scheduled with new-RNTI

- the UE shall use I_{MCS} and Table 5.1.3.1-3 to determine the modulation order (Q_m) and Target code rate (R) used in the physical downlink shared channel.

elseif the UE is not configured with the higher layer parameter *mcs-Table* given by *SPS-config*, the higher layer parameter *mcs-Table* given by *PDSCH-Config* is set to 'qam256', the PDSCH is scheduled with CS-RNTI, and the PDSCH is assigned by a PDCCH with DCI format 1_1

- the UE shall use I_{MCS} and Table 5.1.3.1-2 to determine the modulation order (Q_m) and Target code rate (R) used in the physical downlink shared channel.

elseif the UE is configured with the higher layer parameter *mcs-Table* given by *SPS-config* set to 'qam64LowSE', and the PDSCH is scheduled with CS-RNTI

- the UE shall use I_{MCS} and Table 5.1.3.1-3 to determine the modulation order (Q_m) and Target code rate (R) used in the physical downlink shared channel.

else

- the UE shall use I_{MCS} and Table 5.1.3.1-1 to determine the modulation order (Q_m) and Target code rate (R) used in the physical downlink shared channel.

End

The UE is not expected to decode a PDSCH scheduled with P-RNTI, RA-RNTI, SI-RNTI and $Q_m > 2$

...

Table 5.1.3.1-2: MCS index table 2 for PDSCH

MCS Index I_{MCS}	Modulation Order Q_m	Target code Rate R x [1024]	Spectral efficiency
0	2	120	0.2344
1	2	193	0.3770
2	2	308	0.6016
3	2	449	0.8770
4	2	602	1.1758
5	4	378	1.4766
6	4	434	1.6953
7	4	490	1.9141
8	4	553	2.1602
9	4	616	2.4063
10	4	658	2.5703
11	6	466	2.7305
12	6	517	3.0293
13	6	567	3.3223
14	6	616	3.6094
15	6	666	3.9023
16	6	719	4.2129
17	6	772	4.5234
18	6	822	4.8164
19	6	873	5.1152
20	8	682.5	5.3320
21	8	711	5.5547
22	8	754	5.8906
23	8	797	6.2266
24	8	841	6.5703
25	8	885	6.9141
26	8	916.5	7.1602
27	8	948	7.4063
28	2	reserved	
29	4	reserved	
30	6	reserved	
31	8	reserved	

[TS 38.214, clause 5.1.3.2]

In case the higher layer parameter *maxNrofCodeWordsScheduledByDCI* indicates that two codeword transmission is enabled, then a transport block is disabled by DCI format 1_1 if $I_{MCS} = 26$ and if $rv_{id} = 1$ for the corresponding transport block, otherwise the transport block is enabled. If both transport blocks are enabled, transport block 1 and 2 are mapped to codeword 0 and 1 respectively. If only one transport block is enabled, then the enabled transport block is always mapped to the first codeword.

For the PDSCH assigned by a PDCCH with DCI format 1_0 or format 1_1 with CRC scrambled by C-RNTI, new-RNTI, TC-RNTI, CS-RNTI, or SI-RNTI, if Table 5.1.3.1-2 is used and $0 \leq I_{MCS} \leq 27$, or a table other than Table 5.1.3.1-2 is used and $0 \leq I_{MCS} \leq 28$, the UE shall, except if the transport block is disabled in DCI format 1_1, first determine the TBS as specified below:

- 1) The UE shall first determine the number of REs (N_{RE}) within the slot.

- A UE first determines the number of REs allocated for PDSCH within a PRB (N'_{RE}) by

$$N'_{RE} = N_{sc}^{RB} \cdot N_{symb}^{sh} - N_{DMRS}^{PRB} - N_{oh}^{PRB}$$
, where $N_{sc}^{RB} = 12$ is the number of subcarriers in a physical resource block, N_{symb}^{sh} is the number of symbols of the PDSCH allocation within the slot, N_{DMRS}^{PRB} is the number of REs for DM-RS per PRB in the scheduled duration including the overhead of the DM-RS CDM groups without data, as indicated by DCI format 1_1 or as described for format 1_0 in Subclause 5.1.6.2, and N_{oh}^{PRB} is the overhead configured by higher layer parameter $xOverhead$ in *PDSCH-ServingCellConfig*. If the $xOverhead$ in *PDSCH-ServingCellconfig* is not configured (a value from 0, 6, 12, or 18), the N_{oh}^{PRB} is set to 0. If the PDSCH is scheduled by PDCCH with a CRC scrambled by SI-RNTI, RA-RNTI or P-RNTI, N_{oh}^{PRB} is assumed to be 0.
- A UE determines the total number of REs allocated for PDSCH (N_{RE}) by $N_{RE} = \min(156, N'_{RE}) \cdot n_{PRB}$, where n_{PRB} is the total number of allocated PRBs for the UE.

2) Intermediate number of information bits (N_{info}) is obtained by $N_{info} = N_{RE} \cdot R \cdot Q_m \cdot v$.

If $N_{info} \leq 3824$

Use step 3 as the next step of the TBS determination

else

Use step 4 as the next step of the TBS determination

end if

3) When $N_{info} \leq 3824$, TBS is determined as follows

- quantized intermediate number of information bits $N'_{info} = \max\left(24, 2^n \cdot \left\lfloor \frac{N_{info}}{2^n} \right\rfloor\right)$, where

$$n = \max(3, \log_2(N_{info})) - 6$$
.
- use Table 5.1.3.2-2 find the closest TBS that is not less than N'_{info} .

Table 5.1.3.2-2: TBS for $N_{info} \leq 3824$

Index	TBS	Index	TBS	Index	TBS	Index	TBS
1	24	31	336	61	1288	91	3624
2	32	32	352	62	1320	92	3752
3	40	33	368	63	1352	93	3824
4	48	34	384	64	1416		
5	56	35	408	65	1480		
6	64	36	432	66	1544		
7	72	37	456	67	1608		
8	80	38	480	68	1672		
9	88	39	504	69	1736		
10	96	40	528	70	1800		
11	104	41	552	71	1864		
12	112	42	576	72	1928		
13	120	43	608	73	2024		
14	128	44	640	74	2088		
15	136	45	672	75	2152		
16	144	46	704	76	2216		
17	152	47	736	77	2280		
18	160	48	768	78	2408		
19	168	49	808	79	2472		
20	176	50	848	80	2536		
21	184	51	888	81	2600		
22	192	52	928	82	2664		
23	208	53	984	83	2728		
24	224	54	1032	84	2792		
25	240	55	1064	85	2856		
26	256	56	1128	86	2976		
27	272	57	1160	87	3104		
28	288	58	1192	88	3240		
29	304	59	1224	89	3368		
30	320	60	1256	90	3496		

4) When $N_{info} > 3824$, TBS is determined as follows.

- quantized intermediate number of information bits $N'_{info} = \max\left(3840, 2^n \times \text{round}\left(\frac{N_{info} - 24}{2^n}\right)\right)$, where $n = \lfloor \log_2(N_{info} - 24) \rfloor - 5$ and ties in the round function are broken towards the next largest integer.
- if $R \leq 1/4$

$$TBS = 8 \cdot C \cdot \left\lceil \frac{N'_{info} + 24}{8 \cdot C} \right\rceil - 24, \text{ where } C = \left\lceil \frac{N'_{info} + 24}{3816} \right\rceil$$

else

if $N'_{info} > 8424$

$$TBS = 8 \cdot C \cdot \left\lceil \frac{N'_{info} + 24}{8 \cdot C} \right\rceil - 24, \text{ where } C = \left\lceil \frac{N'_{info} + 24}{8424} \right\rceil$$

else

$$TBS = 8 \cdot \left\lceil \frac{N'_{info} + 24}{8} \right\rceil - 24$$

end if

end if

7.1.1.4.1.4.3 Test description

7.1.1.4.1.4.3.1 Pre-test conditions

Same Pre-test conditions as in clause 7.1.1.0 except set the NR Cell bandwidth and applicable BWP to maximum for the NR Band under test as specified in Table 5.3.5-1 in TS 38.101-1 [16] / TS 38.101-2 [17] (to enable testing of n_{PRB} up to maximum value).

Test frequency NRf1 is as specified in TS 38.508-1[4] clause 4.3.1 using the common highest UL and DL channel bandwidth and using the default subcarrier spacing specified in TS 38.508-1[4] clause 6.2.3.1.

7.1.1.4.1.4.3.2 Test procedure sequence

Table 7.1.1.4.1.4.3.2-1: Maximum TBS for different UE categories

UE Category	Maximum number of bits of a UL-SCH transport block received within a TTI
TS 38.306 [23] clause 4.1.2 require UE without <i>ue-CategoryDL</i> and <i>ue-CategoryUL</i> , to support Max TBS achievable based on max bandwidth of the Band under test.	

Table 7.1.1.4.1.4.3.2-2: Number of downlink PDCP SDUs and PDCP SDU size used as test data

TBS [bits]	Number of PDCP SDUs	PDCP SDU size [bits] (Note 1)
$192 \leq \text{TBS} \leq 12184$ note 2	1	$8 * \text{FLOOR}((\text{TBS} - 184)/8)$
$12185 \leq \text{TBS} \leq 24256$	2	$8 * \text{FLOOR}((\text{TBS} - 256)/16)$
$24257 \leq \text{TBS} \leq 36328$	3	$8 * \text{FLOOR}((\text{TBS} - 328)/24)$
$36329 \leq \text{TBS} \leq 48400$	4	$8 * \text{FLOOR}((\text{TBS} - 400)/32)$
$48401 \leq \text{TBS} \leq 60472$	5	$8 * \text{FLOOR}((\text{TBS} - 472)/40)$
$60473 \leq \text{TBS} \leq 72544$	6	$8 * \text{FLOOR}((\text{TBS} - 544)/48)$
$72545 \leq \text{TBS} \leq 84616$	7	$8 * \text{FLOOR}((\text{TBS} - 616)/56)$
$84617 \leq \text{TBS} \leq 96688$	8	$8 * \text{FLOOR}((\text{TBS} - 688)/64)$
$96689 < \text{TBS} \leq 108760$	9	$8 * \text{FLOOR}((\text{TBS} - 760)/72)$
$108761 \leq \text{TBS} \leq 120832$	10	$8 * \text{FLOOR}((\text{TBS} - 832)/80)$
$120833 \leq \text{TBS} \leq 132904$	11	$8 * \text{FLOOR}((\text{TBS} - 904)/88)$
$132905 \leq \text{TBS} \leq 144976$	12	$8 * \text{FLOOR}((\text{TBS} - 976)/96)$
$144785 \leq \text{TBS} \leq 157048$	13	$8 * \text{FLOOR}((\text{TBS} - 1048)/104)$
$157049 \leq \text{TBS} \leq 169120$	14	$8 * \text{FLOOR}((\text{TBS} - 1120)/112)$
$169121 < \text{TBS} \leq 181192$	15	$8 * \text{FLOOR}((\text{TBS} - 1192)/120)$
$181193 \leq \text{TBS} \leq 193264$	16	$8 * \text{FLOOR}((\text{TBS} - 1264)/128)$
$193337 \leq \text{TBS} \leq 205336$	17	$8 * \text{FLOOR}((\text{TBS} - 1336)/136)$
$205409 \leq \text{TBS} \leq 217408$	18	$8 * \text{FLOOR}((\text{TBS} - 1408)/144)$
$\text{TBS} > 217408$	19	$8 * \text{FLOOR}((\text{TBS} - 1480)/152)$

Note 1: Each PDCP SDU is limited to 1500 octets (to keep below maximum SDU size of ESM as specified in TS 24.301 [21] clause 9.9.4.12).

The PDCP SDU size of each PDCP SDU is

$\text{PDCP SDU size} = (\text{TBS} - N * \text{PDCP header size} - N * \text{AMD PDU header size} - N * \text{MAC header size} - \text{Size of Timing Advance} - \text{RLC Status PDU size} - \text{MAC header for RLC Status PDU} - 32 \text{ bit Additional RLC header with SO if one RLC SDU gets split in 2 TBS and 24 bit MAC header for this additional PDU}) / N$, where

PDCP header size is 24 bits for the RLC AM and 18-bit SN case;
AMD PDU header size is 24 bits with 18 bit SN;

MAC header size for AMD PDU = 16 or 24 bits depending on L=8 or 16 bits. Worst case 24 is taken.

Size of Timing Advance MAC CE with header is 16 bits (if no Timing Advance and/or RLC status needs to be sent, padding will occur instead).
IF RLC SDU does not get split the 32 bits additional padding gets added instead

RLC Status PDU size = 24 bits with 1 ACK_SN, With a MAC header of 16 bits.

This gives:

$\text{PDCP SDU size} = 8 * \text{FLOOR}((\text{TBS} - N * 24 - N * 24 - N * 24 - 112) / (8 * N))$ bits.

Note 2: According to the final PDCP SDU size formula in Note 1, the smallest TBS that can be tested is 192 bits.

Table 7.1.1.4.1.4.3.2-2A: Bandwidth part Dependent Parameters for Resource allocation 0 with start of BWP assumed as 0

$N_{RB}^{DL,BWP} = N_{BWP,i}^{size}$	Nominal RBG size P (Configuration1)	Size of last RBG	Allowed N_{PRB} Values
11	2	1	All 1...11
18	2	2	2,4,6,8,10,12,16,18
24	2	2	2,4,6,8,10,12,16,18,20,22,24
25	2	1	All 1...25
31	2	1	All 1...31
32	2	2	2,4,6,8,10,12,16,18,20,22,24,26,28,30,32
38	4	2	2,4,6,8,10,12,16,18,20,22,24,26,28,30,32,34,36,38
51	4	3	3,4,7,8,11,12,15,16,19,20,23,24,27,28,31,32,35,36,39,40,43,44,47,48,51
52	4	4	4,8,12,16,20,24,28,32,36,40,44,48,52
65	4	1	1,4,5,8,9,12,13,16,17,20,21,24,25,28,29,32,33,36,37,40,41,44,45,48,49,52,53,56,57,60,61,64,65
66	4	2	2,4,6,8,10,12,16,18,20,22,24,26,28,30,32,34,36,38,40,42,44,46,48,50,52,54,56,58,60,62,64,66
79	8	7	7,8,15,16,23,24,31,32,39,40,47,48,55,56,63,64,71,72,79
106	8	2	2,8,10,16,18,24,26,32,34,40,42,48,50,56,58,64,66,72,74,80,82,88,90,96,92,104,106
107	8	3	3,8,11,16,19,24,27,32,35,40,43,48,51,56,59,64,67,72,75,80,83,88,91,96,99,104,107
132	8	4	4,8,12,16,20,24,28,32,36,40,44,48,52,56,60,64,68,72,76,80,84,88,92,96,100,104,108,112,116,120,124,128,132
133	8	5	5,8,13,16,21,24,29,32,37,40,45,48,53,56,61,64,69,72,77,80,85,88,93,96,101,104,109,112,117,120,125,128,133
135	8	7	7,8,15,16,23,24,31,32,39,40,47,48,55,56,63,64,71,72,79,80,87,88,95,96,103,104,111,112,119,120,127,128,135
160	16	16	16,32,48,64,80,96,112,128,144,160
216	16	8	8,16,24,32,40,48,56,64,72,80,88,96,104,112,120,128,136,144,152,160,168,176,184,192,200,208,216
217	16	9	9,16,25,32,41,48,57,64,73,80,89,96,105,112,121,128,137,144,153,160,169,176,185,192,201,208,217
264	16	8	8,16,24,32,40,48,56,64,72,80,88,96,104,112,120,128,136,144,160,168,176,184,192,200,208,216,224,232,240,248,256,264
270	16	14	14,16,30,32,46,44,62,64,78,80,94,96,110,112,126,128,142,144,158,160,174,176,190,192,206,208,222,224,238,240,254,256,270
273	16	1	1,16,17,32,33,48,49,64,65,80,81,96,97,112,113,128,129,144,145,160,161,176,171,192,193,208,209,224,225,240,241,256,257,272,273

Table 7.1.1.4.1.4.3.2-3: Specific Parameter

Parameter	Value	Comments	Condition
PD-SCH mappingType	typeA		
starting symbol S	0 Or 3 to avoid clash with PDCCH symbols		
number of consecutive symbols L	3..14-S		
α_0	0 or 1 (if S=0)		
number of layers (v)	1		
qcs-Table	qam256		
α_0 -PD-SCH	Not present	Results in value 0(α_0)	
dmrs-AdditionalPosition	pos0	Results in 1 DMRS symbol per two carrier (N_{DMRS}) for Duration in symbols ≥ 3 (TS 38.211 [24], table 7.4.1.1.2-3)	
resourceAllocation	dynamicSwitch		pc_dynamicSwitchRA_Type0_1_PD-SCH
	resourceAllocationType0		NOT pc_dynamicSwitchRA_Type0_1_PD-SCH AND Steps 1-5
	resourceAllocationType1		NOT pc_dynamicSwitchRA_Type0_1_PD-SCH AND Steps 6-10
maxNrofCodeWordsScheduledByDCI	n2	both codewords enabled	
rbg-Size	Not present	configuration 1 applicable	
ν_{start}^{BWP}	0		

Table 7.1.1.4.1.4.3.2-4: Main behaviour

St	Procedure	Message Sequence		TP	Verdict
		U - S	Message		
-	EXCEPTION: Steps 1 to 5 are repeated for allowed values of N_{PRB} as per Table 7.1.1.4.1.4.3.2-2A in BWP, time domain resource as per table 7.1.1.4.1.0-1 and I_{MCS} from 0 to 27. NOTE: Skip the execution of steps for which the TBS size results in coding rate exceeding 0.95.	-	-	-	-
1	SS calculates or looks up TBS in TS 38.214 [15] based on the value of S, L, I_{MCS} and n_{PRB} . The SS uses the same I_{MCS} and TBS for both transport blocks: $I_{MCS\#1} = I_{MCS\#2} = I_{MCS}$ TBS 1= TBS 2= TBS	-	-	-	-
-	EXCEPTION: Steps 2 to 5 are performed if TBS1 + TBS2 is less than or equal to UE capability "Maximum number of DL-SCH transport block bits received within a TTI" as specified in Table 7.1.1.4.1.4.3.2-1 and larger than or equal to 192 bits as specified in Table 7.1.1.4.1.4.3.2-2.	-	-	-	-
2	SS creates one or more PDCP SDUs for transport block 1 and 2 depending on TBS1, and TBS2 in accordance with Table 7.1.1.4.1.4.3.2-2.	-	-	-	-
3	SS transmits the PDCP SDUs concatenated into a MAC PDU and indicates on PDCCH DCI Format 1_1 resource allocation 0 and values of S, L, $I_{MCS\#1}$, $I_{MCS\#2}$ and n_{PRB} .	<-	Transport block 1: MAC PDU Transport block 2: MAC PDU DCI: (DCI Format 1_1, S, L , $I_{MCS\#1}$, $I_{MCS\#2}$ and n_{PRB} .)	-	-
4	At the reception of scheduling request the SS transmits UL Grant for transmitting loop back PDCP SDUs.	<-	(UL Grant)	-	-
5	CHECK: Does UE return the same number of PDCP SDUs with same content as transmitted by the SS in step 3?	-->	(NxPDCP SDUs)	1	P
-	EXCEPTION : Steps 5Aa1 to 5Aa2 are executed if NOT <code>pc_dynamicSwitchRA_Type0_1_PDSCH</code>	-	-	-	-
5A a1	The SS transmits a NR RRCReconfiguration message including <i>PDSCH-Config</i> with IE <code>resourceAllocation</code> set to <code>resourceAllocationType1</code> (Note 1)	<-	<i>RRCReconfiguration</i>	-	-
5A a2	The UE transmit a NR <i>RRCReconfigurationComplete</i> message. (Note 2)	-->	<i>RRCReconfigurationComplete</i>	-	-
-	EXCEPTION: Steps 6 to 10 are repeated for allowed values of N_{PRB} 1 to $N_{RB}^{DL,BWP}$ in BWP, time domain resource length L 3 to 14- S and I_{MCS} from 0 to 27.	-	-	-	-

6	SS calculates or looks up TBS in TS 38.214 [15] based on the value of S, L, I_{MCS} and n_{PRB} . The SS uses the same I_{MCS} and TBS for both transport blocks: $I_{MCS\#1} = I_{MCS\#2} = I_{MCS}$ TBS 1= TBS 2= TBS	-	-	-	-
-	EXCEPTION: Steps 7 to 10 are performed if TBS1 + TBS2 is less than or equal to UE capability "Maximum number of DL-SCH transport block bits received within a TTI" as specified in Table 7.1.1.4.1.4.3.2-1 and larger than or equal to 192 bits as specified in Table 7.1.1.4.1.4.3.2-2	-	-	-	-
7	SS creates one or more PDCP SDUs for transport block 1 and 2 depending on TBS1, and TBS2 in accordance with Table 7.1.1.4.1.4.3.2-2.	-	-	-	-
8	SS transmits the PDCP SDUs concatenated into a MAC PDU and indicates on PDCCH DCI Format 1_1 resource allocation 1 and values of S, L, $I_{MCS\#1}$, $I_{MCS\#2}$ and n_{PRB} .	<--	Transport block 1: MAC PDU Transport block 2: MAC PDU DCI: (DCI Format 1_1, S, L, $I_{MCS\#1}$, $I_{MCS\#2}$ and n_{PRB} .)	-	-
9	At the reception of scheduling request the SS transmits UL Grant for transmitting loop back PDCP SDUs.	<--	(UL Grant)	-	-
10	CHECK: Does UE return the same number of PDCP SDUs with same content as transmitted by the SS in step 3?	-->	(NxPDCP SDUs)	2	P
<p>Note 1: For EN-DC the NR RRCReconfiguration message is contained in RRCConnectionReconfiguration 36.508 [7], Table 4.6.1-8 using condition EN-DC_EmbedNR_RRCRecon.</p> <p>Note 2: For EN-DC the NR RRCReconfigurationComplete message is contained in RRCConnectionReconfigurationComplete.</p>					

7.1.1.4.1.4.3.3 Specific message contents

None.

7.1.1.4.2 UL-SCH Transport Block Size Selection

7.1.1.4.2.0 Common parameters for UL-SCH Transport Block Size Selection

Table 7.1.1.4.2.0-1: PUSCH-TimeDomainResourceAllocationList

Derivation Path: TS 38.508-1 [4], table 4.6.3-122			
Information Element	Value/remark	Comment	Condition
PUSCH-TimeDomainResourceAllocationList ::= SEQUENCE (SIZE(1..maxNrofUL-Allocations)) OF PUSCH-TimeDomainResourceAllocation {	2 entry		
PUSCH-TimeDomainResourceAllocation[1] SEQUENCE {		entry 1	FR1
k2	2		FR1
	4		FR2
mappingType	typeB		
startSymbolAndLength	52	Start symbol(S)=10, Length(L)=4	FR1
startSymbolAndLength	42	Start symbol(S)=0, Length(L)=4	FR2
}			
PUSCH-TimeDomainResourceAllocation[2] SEQUENCE {		entry 2	FR1
k2	2		FR1
	4		FR2
mappingType	typeB		
startSymbolAndLength	27	Start symbol(S)=0, Length(L)=14	
}			
}			

7.1.1.4.2.1 UL-SCH Transport Block Size selection / DCI format 0_0 / Transform precoding disabled

7.1.1.4.2.1.1 Test Purpose (TP)

(1)

```

with { UE in RRC_CONNECTED state }
ensure that {
  when { UE has pending data for transmission and receives on PDCCH DCI format 0_0 indicating a
resource block assignment correspondent to physical resource blocks , Time domain resource
assignment and modulation and coding }
  then { UE transmits MAC PDU on PUSCH as per Modulation Coding scheme, time domain resource
allocation and PRB's }
}

```

7.1.1.4.2.1.2 Conformance requirements

References: The conformance requirements covered in the present TC are specified in: TS 38.212 clause 7.3.1.1.1, TS 38.214 clause 6.1.2.1, 6.1.2.2, 6.1.2.2.2, 6.1.4.1, 5.1.3.1, 6.1.4.2 and 5.1.3.2. Unless otherwise stated these are Rel-15 requirements.

[TS 38.212, clause 7.3.1.1.1]

DCI format 0_0 is used for the scheduling of PUSCH in one cell.

The following information is transmitted by means of the DCI format 0_0 with CRC scrambled by C-RNTI or CS-RNTI or new-RNTI:

- Identifier for DCI formats – 1 bit

- The value of this bit field is always set to 0, indicating an UL DCI format
- Frequency domain resource assignment – $\lceil \log_2(N_{RB}^{UL,BWP}(N_{RB}^{UL,BWP} + 1)/2) \rceil$ bits where
 - $N_{RB}^{UL,BWP}$ is the size of the active UL bandwidth part in case DCI format 0_0 is monitored in the UE specific search space and satisfying
 - the total number of different DCI sizes monitored per slot is no more than 4 for the cell, and
 - the total number of different DCI sizes with C-RNTI monitored per slot is no more than 3 for the cell
 - otherwise, $N_{RB}^{UL,BWP}$ is the size of the initial UL bandwidth part.
 - For PUSCH hopping with resource allocation type 1:
 - N_{UL_hop} MSB bits are used to indicate the frequency offset according to Subclause 6.3 of [6, TS 38.214], where $N_{UL_hop} = 1$ if the higher layer parameter *frequencyHoppingOffsetLists* contains two offset values and $N_{UL_hop} = 2$ if the higher layer parameter *frequencyHoppingOffsetLists* contains four offset values
 - $\lceil \log_2(N_{RB}^{UL,BWP}(N_{RB}^{UL,BWP} + 1)/2) \rceil - N_{UL_hop}$ bits provides the frequency domain resource allocation according to Subclause 6.1.2.2.2 of [6, TS 38.214]
 - For non-PUSCH hopping with resource allocation type 1:
 - $\lceil \log_2(N_{RB}^{UL,BWP}(N_{RB}^{UL,BWP} + 1)/2) \rceil$ bits provides the frequency domain resource allocation according to Subclause 6.1.2.2.2 of [6, TS 38.214]
- Time domain resource assignment – 4 bits as defined in Subclause 6.1.2.1 of [6, TS 38.214]
- Frequency hopping flag – 1 bit.
- Modulation and coding scheme – 5 bits as defined in Subclause 6.1.3 of [6, TS 38.214]
- New data indicator – 1 bit
- Redundancy version – 2 bits as defined in Table 7.3.1.1.1-2
- HARQ process number – 4 bits
- TPC command for scheduled PUSCH – 2 bits as defined in Subclause 7.1.1 of [5, TS 38.213]
- Padding bits, if required.
- UL/SUL indicator – 1 bit for UEs configured with SUL in the cell as defined in Table 7.3.1.1.1-1 and the number of bits for DCI format 1_0 before padding is larger than the number of bits for DCI format 0_0 before padding; 0 bit otherwise. The UL/SUL indicator, if present, locates in the last bit position of DCI format 0_0, after the padding bit(s).
 - If the UL/SUL indicator is present in DCI format 0_0 and the higher layer parameter *pusch-Config* is not configured on both UL and SUL the UE ignores the UL/SUL indicator field in DCI format 0_0, and the corresponding PUSCH scheduled by the DCI format 0_0 is for the UL or SUL for which high layer parameter *pusch-Config* is configured;
 - If the UL/SUL indicator is not present in DCI format 0_0, the corresponding PUSCH scheduled by the DCI format 0_0 is for the UL or SUL for which high layer parameter *pusch-Config* is configured.

The following information is transmitted by means of the DCI format 0_0 with CRC scrambled by TC-RNTI:

- Identifier for DCI formats – 1 bit
 - The value of this bit field is always set to 0, indicating an UL DCI format
- Frequency domain resource assignment – $\lceil \log_2(N_{RB}^{UL,BWP}(N_{RB}^{UL,BWP} + 1)/2) \rceil$ bits where

- $N_{RB}^{UL,BWP}$ is the size of the initial UL bandwidth part.
- For PUSCH hopping with resource allocation type 1:
 - N_{UL_hop} MSB bits are used to indicate the frequency offset according to Subclause 6.3 of [6, TS 38.214], where $N_{UL_hop} = 1$ if $N_{RB}^{UL,BWP} < 50$ and $N_{UL_hop} = 2$ otherwise
 - $\lceil \log_2(N_{RB}^{UL,BWP}(N_{RB}^{UL,BWP} + 1)/2) \rceil - N_{UL_hop}$ bits provides the frequency domain resource allocation according to Subclause 6.1.2.2.2 of [6, TS 38.214]
- For non-PUSCH hopping with resource allocation type 1:
 - $\lceil \log_2(N_{RB}^{UL,BWP}(N_{RB}^{UL,BWP} + 1)/2) \rceil$ bits provides the frequency domain resource allocation according to Subclause 6.1.2.2.2 of [6, TS 38.214]
- Time domain resource assignment – 4 bits as defined in Subclause 6.1.2.1 of [6, TS 38.214]
- Frequency hopping flag – 1 bit.
- Modulation and coding scheme – 5 bits as defined in Subclause 6.1.3 of [6, TS 38.214], using Table 5.1.3.1-1
- New data indicator – 1 bit, reserved
- Redundancy version – 2 bits as defined in Table 7.3.1.1.1-2
- HARQ process number – 4 bits, reserved
- TPC command for scheduled PUSCH – 2 bits as defined in Subclause 7.1.1 of [5, TS 38.213]
- Padding bits, if required.
- UL/SUL indicator – 1 bit if the cell has two ULs and the number of bits for DCI format 1_0 before padding is larger than the number of bits for DCI format 0_0 before padding; 0 bit otherwise. The UL/SUL indicator, if present, locates in the last bit position of DCI format 0_0, after the padding bit(s).
 - If 1 bit, reserved, and the corresponding PUSCH is always on the same UL carrier as the previous transmission of the same TB

If DCI format 0_0 is monitored in common search space and if the number of information bits in the DCI format 0_0 prior to padding is less than the payload size of the DCI format 1_0 monitored in common search space for scheduling the same serving cell, zeros shall be appended to the DCI format 0_0 until the payload size equals that of the DCI format 1_0.

If DCI format 0_0 is monitored in common search space and if the number of information bits in the DCI format 0_0 prior to padding is larger than the payload size of the DCI format 1_0 monitored in common search space for scheduling the same serving cell, the bit width of the frequency domain resource allocation field in the DCI format 0_0 is reduced by truncating the first few most significant bits such that the size of DCI format 0_0 equals to the size of the DCI format 1_0.

If DCI format 0_0 is monitored in UE specific search space but does not satisfy at least one of the following

- the total number of different DCI sizes monitored per slot is no more than 4 for the cell, and
- the total number of different DCI sizes with C-RNTI monitored per slot is no more than 3 for the cell

and if the number of information bits in the DCI format 0_0 prior to padding is less than the payload size of the DCI format 1_0 monitored in common search space for scheduling the same serving cell, zeros shall be appended to the DCI format 0_0 until the payload size equals that of the DCI format 1_0.

If DCI format 0_0 is monitored in UE specific search space but does not satisfy at least one of the following

- the total number of different DCI sizes monitored per slot is no more than 4 for the cell, and
- the total number of different DCI sizes with C-RNTI monitored per slot is no more than 3 for the cell

and if the number of information bits in the DCI format 0_0 prior to padding is larger than the payload size of the DCI format 1_0 monitored in common search space for scheduling the same serving cell, the bit width of the frequency domain resource allocation field in the DCI format 0_0 is reduced by truncating the first few most significant bits such that the size of DCI format 0_0 equals to the size of the DCI format 1_0.

If DCI format 0_0 is monitored in UE specific search space and satisfies both of the following

- the total number of different DCI sizes monitored per slot is no more than 4 for the cell, and
- the total number of different DCI sizes with C-RNTI monitored per slot is no more than 3 for the cell

and if the number of information bits in the DCI format 0_0 prior to padding is less than the payload size of the DCI format 1_0 monitored in UE specific search space for scheduling the same serving cell, zeros shall be appended to the DCI format 0_0 until the payload size equals that of the DCI format 1_0.

[TS 38.214, clause 6.1.2.1]

When the UE is scheduled to transmit a transport block and no CSI report, or the UE is scheduled to transmit a transport block and a CSI report on PUSCH by a DCI, the *Time domain resource assignment* field value m of the DCI provides a row index $m + 1$ to an allocated table. The determination of the used resource allocation table is defined in sub-clause 6.1.2.1.1. The indexed row defines the slot offset K_2 , the start and length indicator $SLIV$, or directly the start symbol S and the allocation length L , and the PUSCH mapping type to be applied in the PUSCH transmission.

When the UE is scheduled to transmit a PUSCH with no transport block and with a CSI report by a *CSI request* field on a DCI, the *Time-domain resource assignment* field value m of the DCI provides a row index $m + 1$ to an allocated table. The determination of the applied resource allocation table is defined in sub-clause 6.1.2.1.1. The indexed row defines the start and length indicator $SLIV$, or directly the start symbol S and the allocation length L , and the PUSCH mapping type to be applied in the PUSCH transmission and K_2 is determined based on the corresponding list entries $Y_j, j = 0, \dots, N_{Rep} - 1$ of the higher layer parameter *reportSlotConfig* in *CSI-ReportConfig* for the N_{Rep} triggered CSI Reporting Settings. The i th codepoint of K_2 s determined as $K_2 = \max_j Y_j$ where $Y_j(i)$ is the i th codepoint of Y_j .

- The slot where the UE shall transmit the PUSCH is determined by K_2 as $\left\lceil n \cdot \frac{2^{\mu_{PUSCH}}}{2^{\mu_{PDCCH}}} \right\rceil + K_2$ where n is the slot with the scheduling DCI, K_2 is based on the numerology of PUSCH, and μ_{PUSCH} and μ_{PDCCH} are the subcarrier spacing configurations for PUSCH and PDCCH, respectively, and
- The starting symbol S relative to the start of the slot, and the number of consecutive symbols L counting from the symbol S allocated for the PUSCH are determined from the start and length indicator $SLIV$ of the indexed row:

if $(L-1) \leq 7$ then

$$SLIV = 14 \cdot (L-1) + S$$

else

$$SLIV = 14 \cdot (14 - L + 1) + (14 - 1 - S)$$

where $0 < L \leq 14 - S$, and

- The PUSCH mapping type is set to Type A or Type B as defined in Subclause 6.4.1.1.3 of [4, TS 38.211] as given by the indexed row.

The UE shall consider the S and L combinations defined in table 6.1.2.1-1 as valid PUSCH allocations

Table 6.1.2.1-1: Valid S and L combinations

PUSCH mapping type	Normal cyclic prefix			Extended cyclic prefix		
	S	L	$S+L$	S	L	$S+L$
Type A	0	{4, ..., 14}	{4, ..., 14}	0	{4, ..., 12}	{4, ..., 12}
Type B	{0, ..., 13}	{1, ..., 14}	{1, ..., 14}	{0, ..., 12}	{1, ..., 12}	{1, ..., 12}

When the UE is configured with $aggregationFactorUL > 1$, the same symbol allocation is applied across the $aggregationFactorUL$ consecutive slots and the PUSCH is limited to a single transmission layer. The UE shall repeat the TB across the $aggregationFactorUL$ consecutive slots applying the same symbol allocation in each slot. The redundancy version to be applied on the n^{th} transmission occasion of the TB is determined according to table 6.1.2.1-2.

Table 6.1.2.1-2: Redundancy version when $aggregationFactorUL > 1$

rv_{id} indicated by the DCI scheduling the PUSCH	rv_{id} to be applied to n^{th} transmission occasion			
	$n \bmod 4 = 0$	$n \bmod 4 = 1$	$n \bmod 4 = 2$	$n \bmod 4 = 3$
0	0	2	3	1
2	2	3	1	0
3	3	1	0	2
1	1	0	2	3

If the UE procedure for determining slot configuration, as defined in subclause 11.1 of [6, TS 38.213], determines symbols of a slot allocated for PUSCH as downlink symbols, the transmission on that slot is omitted for multi-slot PUSCH transmission.

[38.214 clause 6.1.2.2]

The UE shall determine the resource block assignment in frequency domain using the resource allocation field in the detected PDCCH DCI. Two uplink resource allocation schemes type 0 and type 1 are supported. Uplink resource allocation scheme type 0 is supported for PUSCH only when transform precoding is disabled. Uplink resource allocation scheme type 1 is supported for PUSCH for both cases when transform precoding is enabled or disabled.

If the scheduling DCI is configured to indicate the uplink resource allocation type as part of the *Frequency domain resource* assignment field by setting a higher layer parameter *resourceAllocation in pusch-Config* to 'dynamicswitch', the UE shall use uplink resource allocation type 0 or type 1 as defined by this DCI field. Otherwise the UE shall use the uplink frequency resource allocation type as defined by the higher layer parameter *resourceAllocation*.

The UE shall assume that when the scheduling PDCCH is received with DCI format 0_0, then uplink resource allocation type 1 is used.

If a bandwidth part indicator field is not configured in the scheduling DCI, the RB indexing for uplink type 0 and type 1 resource allocation is determined within the UE's active bandwidth part. If a bandwidth part indicator field is configured in the scheduling DCI, the RB indexing for uplink type 0 and type 1 resource allocation is determined within the UE's bandwidth part indicated by bandwidth part indicator field value in the DCI, except for the case when DCI format 0_0 is decoded in any PDCCH common search space in CORESET 0 in which case the initial bandwidth part shall be used. The UE shall upon detection of PDCCH intended for the UE determine first the uplink bandwidth part and then the resource allocation within the bandwidth part.

[38.214 clause 6.1.2.2.2]

In uplink resource allocation of type 1, the resource block assignment information indicates to a scheduled UE a set of contiguously allocated non-interleaved virtual resource blocks within the active carrier bandwidth part of size N_{BWP}^{size} PRBs except for the case when DCI format 0_0 is decoded in the Type0-PDCCH common search space in CORESET 0 in which case the initial bandwidth part of size N_{BWP}^{size} shall be used.

An uplink type 1 resource allocation field consists of a resource indication value (RIV) corresponding to a starting virtual resource block (RB_{start}) and a length in terms of contiguously allocated resource blocks L_{RBs} . The resource indication value is defined by

if $(L_{RBs} - 1) \leq \lfloor N_{BWP}^{size} / 2 \rfloor$ then

$$RIV = N_{BWP}^{size}(L_{RBs} - 1) + RB_{start}$$

else

$$RIV = N_{BWP}^{size}(N_{BWP}^{size} - L_{RBs} + 1) + (N_{BWP}^{size} - 1 - RB_{start})$$

where $L_{RBs} \geq 1$ and shall not exceed $N_{BWP}^{size} - RB_{start}$.

[TS 38.214, clause 6.1.4.1]

For the PUSCH assigned by a DCI format 0_0/0_1 with CRC scrambled by C-RNTI, new-RNTI, TC-RNTI, or SP-CSI-RNTI, the transform precoding is enabled if *transformPrecoder* in *PUSCH-Config* is set to 'enabled', or if *transformPrecoder* in *PUSCH-Config* is not configured and *msg3-transformPrecoding* in *rach-ConfigCommon* is set to 'enabled'; otherwise the transform precoding is disabled.

For the PUSCH assigned by a DCI format 0_0/0_1 with CRC scrambled by CS-RNTI, or the PUSCH with configured grant using CS-RNTI, the transform precoding is enabled if *transformPrecoder* in *ConfiguredGrantConfig* is set to 'enabled'; otherwise the transform precoding is disabled.

For a PUSCH scheduled by RAR UL grant or for a PUSCH scheduled by a DCI format 0_0/0_1 with CRC scrambled by C-RNTI, TC-RNTI, or CS-RNTI, or SP-CSI-RNTI, or for a PUSCH with configured grant using CS-RNTI,

if *transformPrecoder* is disabled for this PUSCH transmission

- if *mcs-Table* in *PUSCH-Config* is set to 'qam256', and PUSCH is scheduled with C-RNTI or SP-CSI-RNTI, and PUSCH is assigned by DCI format 0_1,
 - the UE shall use I_{MCS} and Table 5.1.3.1-2 to determine the modulation order (Q_m) and Target code rate (R) used in the physical uplink shared channel.
- elseif the UE is not configured with new-RNTI, *mcs-Table* in *PUSCH-Config* is set to 'qam64LowSE', the PUSCH is scheduled with C-RNTI, or SP-CSI-RNTI, and the PUSCH is assigned by a PDCCH in a UE-specific search space,
 - the UE shall use I_{MCS} and Table 5.1.3.1-3 to determine the modulation order (Q_m) and Target code rate (R) used in the physical uplink shared channel.
- elseif the UE is configured with new-RNTI, and the PUSCH is scheduled with new-RNTI,
 - the UE shall use I_{MCS} and Table 5.1.3.1-3 to determine the modulation order (Q_m) and Target code rate (R) used in the physical uplink shared channel.
- elseif *mcs-Table* in *ConfiguredGrantConfig* is set to 'qam256', and PUSCH is scheduled with CS-RNTI,
 - the UE shall use I_{MCS} and Table 5.1.3.1-2 to determine the modulation order (Q_m) and Target code rate (R) used in the physical uplink shared channel.
- elseif *mcs-Table* in *ConfiguredGrantConfig* is set to 'qam64LowSE', and PUSCH is scheduled with CS-RNTI,
 - the UE shall use I_{MCS} and Table 5.1.3.1-3 to determine the modulation order (Q_m) and Target code rate (R) used in the physical uplink shared channel.
- else
 - the UE shall use I_{MCS} and Table 5.1.3.1-1 to determine the modulation order (Q_m) and Target code rate (R) used in the physical uplink shared channel.

[TS 38.214, clause 5.1.3.1]

Table 5.1.3.1-1: MCS index table 1 for PDSCH

MCS Index I_{MCS}	Modulation Order Q_m	Target code Rate $R \times [1024]$	Spectral efficiency
0	2	120	0.2344
1	2	157	0.3066
2	2	193	0.3770
3	2	251	0.4902
4	2	308	0.6016
5	2	379	0.7402
6	2	449	0.8770
7	2	526	1.0273
8	2	602	1.1758
9	2	679	1.3262
10	4	340	1.3281
11	4	378	1.4766
12	4	434	1.6953
13	4	490	1.9141
14	4	553	2.1602
15	4	616	2.4063
16	4	658	2.5703
17	6	438	2.5664
18	6	466	2.7305
19	6	517	3.0293
20	6	567	3.3223
21	6	616	3.6094
22	6	666	3.9023
23	6	719	4.2129
24	6	772	4.5234
25	6	822	4.8164
26	6	873	5.1152
27	6	910	5.3320
28	6	948	5.5547
29	2	reserved	
30	4	reserved	
31	6	reserved	

[TS 38.214, clause 6.1.4.2]

For a PUSCH scheduled by RAR UL grant or for a PUSCH scheduled by a DCI format 0_0/0_1 with CRC scrambled by C-RNTI, new-RNTI, TC-RNTI, CS-RNTI, or SP-CSI-RNTI.

if

- $0 \leq I_{MCS} \leq 27$ and transform precoding is disabled and Table 5.1.3.1-2 is used, or
- $0 \leq I_{MCS} \leq 28$ and transform precoding is disabled and a table other than Table 5.1.3.1-2 is used, or
- $0 \leq I_{MCS} \leq 27$ and transform precoding is enabled and , the UE shall first determine the TBS as specified below:

The UE shall first determine the number of REs (N_{RE}) within the slot:

- A UE first determines the number of REs allocated for PUSCH within a PRB (N'_{RE}) by
- $N'_{RE} = N_{sc}^{RB} * N_{symp}^{sh} - N_{DMRS}^{PRB} - N_{oh}^{PRB}$, where $N_{sc}^{RB} = 12$ is the number of subcarriers in the frequency domain in a physical resource block, N_{symp}^{sh} is the number of symbols of the PUSCH allocation within the slot, N_{DMRS}^{PRB} is the number of REs for DM-RS per PRB in the scheduled duration including the overhead of the DM-RS CDM groups without data, as indicated by DCI format 0_1 or as described for DCI format 0_0 in Subclause 6.2.2, and N_{oh}^{PRB} is the overhead configured by higher layer parameter $xOverhead$ in PUSCH-

ServingCellConfig. If the N_{oh}^{PRB} is not configured (a value from 0, 6, 12, or 18), the N_{oh}^{PRB} is assumed to be 0. For MSG3 transmission the N_{oh}^{PRB} is always set to 0..

- A UE determines the total number of REs allocated for PUSCH (N_{RE}) by

$$N_{RE} = \min(156, N_{RE}') \cdot n_{PRB}$$
 where n_{PRB} is the total number of allocated PRBs for the UE.
- Next, proceed with steps 2-5 as defined in Subclause 5.1.3.2

else if

- $28 \leq I_{MCS} \leq 31$ and transform precoding is disabled and Table 5.1.3.1-2 is used, or
- $28 \leq I_{MCS} \leq 31$ and transform precoding is enabled,
- the TBS is assumed to be as determined from the DCI transported in the latest PDCCH for the same transport block using $0 \leq I_{MCS} \leq 27$. If there is no PDCCH for the same transport block using $0 \leq I_{MCS} \leq 27$, and if the initial PUSCH for the same transport block is transmitted with configured grant, the TBS shall be determined from the most recent configured scheduling PDCCH.

else

- the TBS is assumed to be as determined from the DCI transported in the latest PDCCH for the same transport block using $0 \leq I_{MCS} \leq 28$. If there is no PDCCH for the same transport block using $0 \leq I_{MCS} \leq 28$, and if the initial PUSCH for the same transport block is transmitted with configured grant, the TBS shall be determined from the most recent configured scheduling PDCCH.

[TS 38.214, clause 5.1.3.2]

- 2 Intermediate number of information bits (N_{info}) is obtained by $N_{info} = N_{RE} \cdot R \cdot Q_m \cdot \nu$.

If $N_{info} \leq 3824$

Use step 3 as the next step of the TBS determination

else

Use step 4 as the next step of the TBS determination

end if

- 3) When $N_{info} \leq 3824$, TBS is determined as follows

- quantized intermediate number of information bits $N_{info}' = \max\left(24, 2^n \left\lfloor \frac{N_{info}}{2^n} \right\rfloor\right)$, where

$$n = \max(3, \log_2(N_{info})) - 6$$
- use Table 5.1.3.2-2 find the closest TBS that is not less than N_{info}' .

Table 5.1.3.2-2: TBS for $N_{info} \leq 3824$

Index	TBS	Index	TBS	Index	TBS	Index	TBS
1	24	31	336	61	1288	91	3624
2	32	32	352	62	1320	92	3752
3	40	33	368	63	1352	93	3824
4	48	34	384	64	1416		
5	56	35	408	65	1480		
6	64	36	432	66	1544		
7	72	37	456	67	1608		
8	80	38	480	68	1672		
9	88	39	504	69	1736		
10	96	40	528	70	1800		
11	104	41	552	71	1864		
12	112	42	576	72	1928		
13	120	43	608	73	2024		
14	128	44	640	74	2088		
15	136	45	672	75	2152		
16	144	46	704	76	2216		
17	152	47	736	77	2280		
18	160	48	768	78	2408		
19	168	49	808	79	2472		
20	176	50	848	80	2536		
21	184	51	888	81	2600		
22	192	52	928	82	2664		
23	208	53	984	83	2728		
24	224	54	1032	84	2792		
25	240	55	1064	85	2856		
26	256	56	1128	86	2976		
27	272	57	1160	87	3104		
28	288	58	1192	88	3240		
29	304	59	1224	89	3368		
30	320	60	1256	90	3496		

4) When $N_{info} > 3824$, TBS is determined as follows.

- quantized intermediate number of information bits $N'_{info} = \max\left(3840, 2^n \times \text{round}\left(\frac{N_{info} - 24}{2^n}\right)\right)$, where $n = \lfloor \log_2(N_{info} - 24) \rfloor - 5$ and ties in the round function are broken towards the next largest integer.
- if $R \leq 1/4$

$$TBS = 8 \cdot C \cdot \left\lceil \frac{N'_{info} + 24}{8 \cdot C} \right\rceil - 24, \text{ where } C = \left\lceil \frac{N'_{info} + 24}{3816} \right\rceil$$

else

if $N'_{info} > 8424$

$$TBS = 8 \cdot C \cdot \left\lceil \frac{N'_{info} + 24}{8 \cdot C} \right\rceil - 24, \text{ where } C = \left\lceil \frac{N'_{info} + 24}{8424} \right\rceil$$

else

$$TBS = 8 \cdot \left\lceil \frac{N'_{info} + 24}{8} \right\rceil - 24$$

end if

end if

7.1.1.4.2.1.3 Test description

7.1.1.4.2.1.3.1 Pre-test conditions

Same Pre-test conditions as in clause 7.1.1.0 except set the NR Cell bandwidth and applicable BWP to maximum for the NR Band under test as specified in Table 5.3.5-1 in TS 38.101-1 [16] / TS 38.101-2 [17] (to enable testing of n_{PRB} up to maximum value) and Short_DCI condition is applied in NR Serving cell configuration.

Test frequency NRf1 is as specified in TS 38.508-1 [4] clause 4.3.1 using the common highest UL and DL channel bandwidth and using the default subcarrier spacing specified in TS 38.508-1 [4] clause 6.2.3.1.

7.1.1.4.2.1.3.2 Test procedure sequence

Table 7.1.1.4.2.1.3.2-1: Maximum TBS for different UE categories

UE Category	Maximum number of bits of a UL-SCH transport block received within a TTI
TS 38.306 [23] clause 4.1.2 require UE without <i>ue-CategoryDL</i> and <i>ue-CategoryUL</i> , to support Max TBS achievable based on max bandwidth of the Band under test.	

Table 7.1.1.4.2.1.3.2-2: Number of uplink PDCP SDUs and PDCP SDU size used as test data

TBS [bits]	Number of PDCP SDUs	PDCP SDU size [bits] (Note 1)
$136 \leq TBS \leq 12128$ note 2	1	$8 * \text{FLOOR}((TBS - 128)/8)$
$12129 \leq TBS \leq 24200$	2	$8 * \text{FLOOR}((TBS - 200)/16)$
$24201 \leq TBS \leq 36272$	3	$8 * \text{FLOOR}((TBS - 272)/24)$
$36273 \leq TBS \leq 48344$	4	$8 * \text{FLOOR}((TBS - 344)/32)$
$48345 \leq TBS \leq 60416$	5	$8 * \text{FLOOR}((TBS - 416)/40)$
$60417 \leq TBS \leq 72488$	6	$8 * \text{FLOOR}((TBS - 488)/48)$
$72489 \leq TBS \leq 84560$	7	$8 * \text{FLOOR}((TBS - 560)/56)$
$84561 \leq TBS \leq 96632$	8	$8 * \text{FLOOR}((TBS - 632)/64)$
$96633 \leq TBS \leq 108704$	9	$8 * \text{FLOOR}((TBS - 704)/72)$
$108705 \leq TBS \leq 120776$	10	$8 * \text{FLOOR}((TBS - 776)/80)$
$120777 \leq TBS \leq 132848$	11	$8 * \text{FLOOR}((TBS - 848)/88)$
$132849 \leq TBS \leq 144920$	12	$8 * \text{FLOOR}((TBS - 920)/96)$
$TBS > 144920$	13	$8 * \text{FLOOR}((TBS - 992)/104)$

Note 1: Each PDCP SDU is limited to 1500 octets (to keep below maximum SDU size of ESM as specified in TS 24.301 [21] clause 9.9.4.12).

The PDCP SDU size of each PDCP SDU is

$$\text{PDCP SDU size} = (TBS - N * \text{PDCP header size} - N * \text{AMD PDU header size} - N * \text{MAC header size} - \text{Size of Timing Advance} - \text{RLC Status PDU size} - \text{MAC header for RLC Status PDU}) / N, \text{ where}$$

PDCP header size is 24 bits for the RLC AM and 18-bit SN case;
AMD PDU header size is 24 bits with 18 bit SN;

MAC header size for AMD PDU = 16 or 24 bits depending on L=8 or 16 bits. Worst case 24 is taken.

Size of Timing Advance MAC CE with header is 16 bits (if no Timing Advance and/or RLC status needs to be sent, padding will occur instead).

RLC Status PDU size = 24 bits with 1 ACK_SN, With a MAC header of 16 bits.

This gives:

$$\text{PDCP SDU size} = 8 * \text{FLOOR}((TBS - N * 24 - N * 24 - N * 24 - 56) / (8 * N)) \text{ bits.}$$

Note 2: According to the final PDCP SDU size formula in Note 1, the smallest TBS that can be tested is 136 bits.

Table 7.1.1.4.2.1.3.2-3: Specific Parameters

Parameter	Value	Comment
number of layers (v)	1	
mcs-Table	qam64	

Table 7.1.1.4.2.1.3.2-4: Main behaviour

St	Procedure	Message Sequence		TP	Verdict
		U - S	Message		
-	EXCEPTION: Steps 1 to 5 are repeated for allowed values of N_{PRB} 1 to $N_{RB}^{UL,BWP}$ in BWP, time domain resource as per Table 7.1.1.4.2.0-1 and I_{MCS} from 0 to 28. Skip the execution of steps for $I_{MCS} = 28$ and $N_{PRB} < 4$. (Note 1)	-	-	-	-
1	The SS calculates or looks up TBS in TS 38.214 [15] based on the value of S, L, I_{MCS} and n_{PRB} .	-	-	-	-
-	EXCEPTION: Steps 2 to 5 are performed if TBS is less than or equal to UE capability "Maximum number of UL-SCH transport block bits received within a TTI" as specified in Table 7.1.1.4.2.1.3.2-1 and larger than or equal to 136 bits as specified in Table 7.1.1.4.2.1.3.2-2. Skip the execution of steps 2 to 5 for which the TBS size equal to 3824 or 3840. (Note 2)	-	-	-	-
2	The SS creates one or more PDCP SDUs, depending on TBS, in accordance with Table 7.1.1.4.2.1.3.2-2.	-	-	-	-
3	After 300ms, the SS transmits all PDCP SDUs (N_{SDUs}) as created in step 2 in a MAC PDU.	<--	MAC PDU ($N \times$ PDCP SDUs)	-	-
4	After 60ms of step 3, SS transmits UL Grant DCI 0_0, and values of S, L, I_{MCS} and n_{PRB} .	<--	(UL Grant) (DCI Format 0_0, S, L, I_{MCS} and n_{PRB})	-	-
5	CHECK: Does UE return the same number of PDCP SDUs with same content as transmitted by the SS in step 3 using Time, frequency Resources and modulation and coding scheme as configured by the SS in step 4?	-->	MAC PDU ($N \times$ PDCP SDU)	1	P
<p>Note 1: For $I_{MCS} = 28$ and $N_{PRB} < 4$, the resulting TBS is very small leading to CRC errors in decoding UL data.</p> <p>Note 2: There is ambiguity of TBS calculation when $3824.0 < N_{info} < 3825.0$ in clause 5.1.3.2 of TS 38.214 [15].</p>					

7.1.1.4.2.1.3.3 Specific message contents

None.

7.1.1.4.2.2 Void

7.1.1.4.2.3 UL-SCH transport block size selection / DCI format 0_1 / RA type 0/RA Type 1 / Transform precoding disabled

7.1.1.4.2.3.1 Test Purpose (TP)

(1)

```
with { UE in RRC_CONNECTED state }
ensure that {
  when { UE has pending data for transmission and receives DCI format 0_1 indicating resource
allocation type 0 a resource block assignment correspondent to physical resource blocks , Time
domain resource assignment and a modulation and coding }
  then { UE transmits MAC PDU's on PUSCH as per Modulation Coding scheme, time domain resource
allocation and PRB's }
}
```

(2)

```
with { UE in RRC_CONNECTED state }
ensure that {
  when { UE has pending data for transmission and receives DCI format 0_1 indicating resource
allocation type 1 a resource block assignment correspondent to physical resource blocks , Time
domain resource assignment and a modulation and coding }
  then { UE transmits MAC PDU's on PUSCH as per Modulation Coding scheme, time domain resource
allocation and PRB's }
}
```

7.1.1.4.2.3.2 Conformance requirements

References: The conformance requirements covered in the present TC are specified in: TS 38.212 clause 7.3.1.1.1, TS 38.214 clause 6.1.2.1, 6.1.2.2, 6.1.2.2.1, 6.1.2.2.2, 6.1.4.1, 5.1.3.1, 6.1.4.2 and 5.1.3.2. Unless otherwise stated these are Rel-15 requirements.

[TS 38.212, clause 7.3.1.1.2]

DCI format 0_1 is used for the scheduling of PUSCH in one cell.

The following information is transmitted by means of the DCI format 0_1 with CRC scrambled by C-RNTI or CS-RNTI or SP-CSI-RNTI or new-RNTI:

- Identifier for DCI formats – 1 bit
- The value of this bit field is always set to 0, indicating an UL DCI format
- Carrier indicator – 0 or 3 bits, as defined in Subclause 10.1 of [5, TS38.213].
- UL/SUL indicator – 0 bit for UEs not configured with SUL in the cell or UEs configured with SUL in the cell but only PUCCH carrier in the cell is configured for PUSCH transmission; 1 bit for UEs configured with SUL in the cell as defined in Table 7.3.1.1.1-1.
- Bandwidth part indicator – 0, 1 or 2 bits as determined by the number of UL BWPs $n_{\text{BWP,RRC}}$ configured by higher layers, excluding the initial UL bandwidth part. The bit width for this field is determined as $\lceil \log_2(n_{\text{BWP}}) \rceil$ bits, where
 - $n_{\text{BWP}} = n_{\text{BWP,RRC}} + 1$ if , in which case the bandwidth part indicator is equivalent to the higher layer parameter *BWP-Id*;
 - otherwise $n_{\text{BWP}} = n_{\text{BWP,RRC}}$, in which case the bandwidth part indicator is defined in Table 7.3.1.1.2-1;

If a UE does not support active BWP change via DCI, the UE ignores this bit field.

- Frequency domain resource assignment – number of bits determined by the following, where $N_{\text{RB}}^{\text{UL,BWP}}$ is the size of the active UL bandwidth part:

- N_{RBG} bits if only resource allocation type 0 is configured, where N_{RBG} is defined in Subclause 6.1.2.2.1 of [6, TS 38.214],
- $\lceil \log_2(N_{\text{RB}}^{\text{UL,BWP}}(N_{\text{RB}}^{\text{UL,BWP}} + 1)/2) \rceil$ bits if only resource allocation type 1 is configured, or $\max\left(\lceil \log_2(N_{\text{RB}}^{\text{UL,BWP}}(N_{\text{RB}}^{\text{UL,BWP}} + 1)/2) \rceil, N_{\text{RBG}}\right) + 1$ bits if both resource allocation type 0 and 1 are configured.
- If both resource allocation type 0 and 1 are configured, the MSB bit is used to indicate resource allocation type 0 or resource allocation type 1, where the bit value of 0 indicates resource allocation type 0 and the bit value of 1 indicates resource allocation type 1.
- For resource allocation type 0, the N_{RBG} LSBs provide the resource allocation as defined in Subclause 6.1.2.2.1 of [6, TS 38.214].
- For resource allocation type 1, the $\lceil \log_2(N_{\text{RB}}^{\text{UL,BWP}}(N_{\text{RB}}^{\text{UL,BWP}} + 1)/2) \rceil$ LSBs provide the resource allocation as follows:
 - For PUSCH hopping with resource allocation type 1:
 - $N_{\text{UL,hop}}$ MSB bits are used to indicate the frequency offset according to Subclause 6.3 of [6, TS 38.214], where $N_{\text{UL,hop}} = 1$ if the higher layer parameter *frequencyHoppingOffsetLists* contains two offset values and $N_{\text{UL,hop}} = 2$ if the higher layer parameter *frequencyHoppingOffsetLists* contains four offset values
 - $\lceil \log_2(N_{\text{RB}}^{\text{UL,BWP}}(N_{\text{RB}}^{\text{UL,BWP}} + 1)/2) \rceil - N_{\text{UL,hop}}$ bits provides the frequency domain resource allocation according to Subclause 6.1.2.2.2 of [6, TS 38.214]

If "Bandwidth part indicator" field indicates a bandwidth part other than the active bandwidth part and if both resource allocation type 0 and 1 are configured for the indicated bandwidth part, the UE assumes resource allocation type 0 for the indicated bandwidth part if the bit width of the "Frequency domain resource assignment" field of the active bandwidth part is smaller than the bit width of the "Frequency domain resource assignment" field of the indicated bandwidth part.

- For non-PUSCH hopping with resource allocation type 1:
 - $\lceil \log_2(N_{\text{RB}}^{\text{UL,BWP}}(N_{\text{RB}}^{\text{UL,BWP}} + 1)/2) \rceil$ bits provides the frequency domain resource allocation according to Subclause 6.1.2.2.2 of [6, TS 38.214]
- Time domain resource assignment – 0, 1, 2, 3, or 4 bits as defined in Subclause 6.1.2.1 of [6, TS38.214]. The bit width for this field is determined as $\lceil \log_2(I) \rceil$ bits, where I the number of entries in the higher layer parameter *pusch-AllocationList*.
- Frequency hopping flag – 0 or 1 bit:
 - 0 bit if only resource allocation type 0 is configured or if the higher layer parameter *frequencyHopping* is not configured;
 - 1 bit according to Table 7.3.1.1.2-34 otherwise, only applicable to resource allocation type 1, as defined in Subclause 6.3 of [6, TS 38.214].
- Modulation and coding scheme – 5 bits as defined in Subclause 6.1.4.1 of [6, TS 38.214]
- New data indicator – 1 bit
- Redundancy version – 2 bits as defined in Table 7.3.1.1.1-2
- HARQ process number – 4 bits
- 1st downlink assignment index – 1 or 2 bits:

- 1 bit for semi-static HARQ-ACK codebook;
- 2 bits for dynamic HARQ-ACK codebook.
- 2nd downlink assignment index – 0 or 2 bits:
 - 2 bits for dynamic HARQ-ACK codebook with two HARQ-ACK sub-codebooks;
 - 0 bit otherwise.
- TPC command for scheduled PUSCH – 2 bits as defined in Subclause 7.1.1 of [5, TS38.213]
- SRS resource indicator – $\left\lceil \log_2 \left(\prod_{k=1}^{\min\{L_{\max}^{\text{PUSCH}}, N_{\text{SRS}}\}} \binom{N_{\text{SRS}}}{k} \right) \right\rceil$ or $\lceil \log_2(N_{\text{SRS}}) \rceil$ bits, where N_{SRS} is the number of configured SRS resources in the SRS resource set associated with the higher layer parameter *usage* of value 'codeBook' or 'nonCodeBook', and L_{\max}^{PUSCH} is the maximum number of supported layers for the PUSCH.
 - $\left\lceil \log_2 \left(\prod_{k=1}^{\min\{L_{\max}^{\text{PUSCH}}, N_{\text{SRS}}\}} \binom{N_{\text{SRS}}}{k} \right) \right\rceil$ bits according to Tables 7.3.1.1.2-28/29/30/31 if the higher layer parameter *txConfig* = *nonCodebook*, where N_{SRS} is the number of configured SRS resources in the SRS resource set associated with the higher layer parameter *usage* of value 'nonCodeBook';
 - $\lceil \log_2(N_{\text{SRS}}) \rceil$ bits according to Tables 7.3.1.1.2-32 if the higher layer parameter *txConfig* = *codebook*, where N_{SRS} is the number of configured SRS resources in the SRS resource set associated with the higher layer parameter *usage* of value 'codeBook'.
- Precoding information and number of layers – number of bits determined by the following:
 - 0 bits if the higher layer parameter *txConfig* = *nonCodeBook*;
 - 0 bits for 1 antenna port and if the higher layer parameter *txConfig* = *codebook*;
 - 4, 5, or 6 bits according to Table 7.3.1.1.2-2 for 4 antenna ports, if *txConfig* = *codebook*, and according to the values of higher layer parameters *transformPrecoder*, *maxRank*, and *codebookSubset*;
 - 2, 4, or 5 bits according to Table 7.3.1.1.2-3 for 4 antenna ports, if *txConfig* = *codebook*, and according to the values of higher layer parameters *transformPrecoder*, *maxRank*, and *codebookSubset*;
 - 2 or 4 bits according to Table 7.3.1.1.2-4 for 2 antenna ports, if *txConfig* = *codebook*, and according to the values of higher layer parameters *maxRank* and *codebookSubset*;
 - 1 or 3 bits according to Table 7.3.1.1.2-5 for 2 antenna ports, if *txConfig* = *codebook* *maxRank* and *codebookSubset*, and according to the values of higher layer parameters .
- Antenna ports – number of bits determined by the following
 - 2 bits as defined by Tables 7.3.1.1.2-6, if *transformPrecoder*=*enabled*, *dmrs-Type*=1, and *maxLength*=1;
 - 4 bits as defined by Tables 7.3.1.1.2-7, if *transformPrecoder*=*enabled*, *dmrs-Type*=1, and *maxLength*=2;
 - 3 bits as defined by Tables 7.3.1.1.2-8/9/10/11, if *transformPrecoder*=*disabled*, *dmrs-Type*=1, and *maxLength*=1, and the value of rank is determined according to the SRS resource indicator field if the higher layer parameter *txConfig* = *nonCodebook* and according to the Precoding information and number of layers field if the higher layer parameter *txConfig* = *codebook*;
 - 4 bits as defined by Tables 7.3.1.1.2-12/13/14/15, if *transformPrecoder*=*disabled*, *dmrs-Type*=1, and *maxLength*=2, and the value of rank is determined according to the SRS resource indicator field if the higher layer parameter *txConfig* = *nonCodebook* and according to the Precoding information and number of layers field if the higher layer parameter *txConfig* = *codebook*;

- 4 bits as defined by Tables 7.3.1.1.2-16/17/18/19, if *transformPrecoder=disabled*, *dmrs-Type=2*, and *maxLength=1*, and the value of rank is determined according to the SRS resource indicator field if the higher layer parameter *txConfig = nonCodebook* and according to the Precoding information and number of layers field if the higher layer parameter *txConfig = codebook*;
- 5 bits as defined by Tables 7.3.1.1.2-20/21/22/23, if *transformPrecoder=disabled*, *dmrs-Type=2*, and *maxLength=2*, and the value of rank is determined according to the SRS resource indicator field if the higher layer parameter *txConfig = nonCodebook* and according to the Precoding information and number of layers field if the higher layer parameter *txConfig = codebook*.

where the number of CDM groups without data of values 1, 2, and 3 in Tables 7.3.1.1.2-6 to 7.3.1.1.2-23 refers to CDM groups {0}, {0,1}, and {0, 1,2} respectively.

If a UE is configured with both *dmrs-UplinkForPUSCH-MappingTypeA* and *dmrs-UplinkForPUSCH-MappingTypeB*, the bit width of this field equals $\max\{x_A, x_B\}$, where x_A is the “Antenna ports” bit width derived according to *dmrs-UplinkForPUSCH-MappingTypeA* and x_B is the “Antenna ports” bit width derived according to *dmrs-UplinkForPUSCH-MappingTypeB*. A number of $|x_A - x_B|$ zeros are padded in the MSB of this field, if the mapping type of the PUSCH corresponds to the smaller value of x_A and x_B .

- SRS request – 2 bits as defined by Table 7.3.1.1.2-24 for UEs not configured with SUL in the cell; 3 bits for UEs configured SUL in the cell where the first bit is the non-SUL/SUL indicator as defined in Table 7.3.1.1.1-1 and the second and third bits are defined by Table 7.3.1.1.2-24. This bit field may also indicate the associated CSI-RS according to Subclause 6.1.1.2 of [6, TS 38.214].
 - CSI request – 0, 1, 2, 3, 4, 5, or 6 bits determined by higher layer parameter *reportTriggerSize*.
 - CBG transmission information (CBGTI) – 0, 2, 4, 6, or 8 bits determined by higher layer parameter *maxCodeBlockGroupsPerTransportBlock* for PUSCH.
 - PTRS-DMRS association – number of bits determined as follows
 - 0 bit if *PTRS-UplinkConfig* is not configured and *transformPrecoder=disabled*, or if *transformPrecoder=enabled*, or if *maxRank=1*;
 - 2 bits otherwise, where Table 7.3.1.1.2-25 and 7.3.1.1.2-26 are used to indicate the association between PTRS port(s) and DMRS port(s) for transmission of one PT-RS port and two PT-RS ports respectively, and the DMRS ports are indicated by the Antenna ports field.
- If “Bandwidth part indicator” field indicates a bandwidth part other than the active bandwidth part and the “PTRS-DMRS association” field is present for the indicated bandwidth part but not present for the active bandwidth part, the UE assumes the “PTRS-DMRS association” field is not present for the indicated bandwidth part. *betaOffsets = semiStatic*
- *beta_offset* indicator – 0 if the higher layer parameter ; otherwise 2 bits as defined by Table 9.3-3 in [5, TS 38.213].
 - DMRS sequence initialization – 0 if the higher layer parameter *transformPrecoder=enabled*; 1 bit if the higher layer parameter *transformPrecoder=disabled* and both *scramblingID0* and *scramblingID1* are configured in *DMRS-UplinkConfig*, for n_{SCID} selection defined in Subclause 6.4.1.1.1.1 of [4, TS 38.211].
 - UL-SCH indicator – 1 bit. A value of “1” indicates UL-SCH shall be transmitted on the PUSCH and a value of “0” indicates UL-SCH shall not be transmitted on the PUSCH.

For a UE configured with SUL in a cell, if PUSCH is configured to be transmitted on both the SUL and the non-SUL of the cell and if the number of information bits in format 0_1 for the SUL is not equal to the number of information bits in format 0_1 for the non-SUL, zeros shall be appended to smaller format 0_1 until the payload size equals that of the larger format 0_1.

Table 7.3.1.1.2-1: Bandwidth part indicator

Value of BWP indicator field 2 bits	Bandwidth part
00	First bandwidth part configured by higher layers
01	Second bandwidth part configured by higher layers
10	Third bandwidth part configured by higher layers
11	Fourth bandwidth part configured by higher layers

Table 7.3.1.1.2-2: Precoding information and number of layers, for 4 antenna ports, if *transformPrecoder=disabled* and *maxRank = 2 or 3 or 4*

Bit field mapped to index	<i>codebookSubset = fullyAndPartialAndNonCoherent</i>	Bit field mapped to index	<i>codebookSubset = partialAndNonCoherent</i>	Bit field mapped to index	<i>codebookSubset=nonCoherent</i>
0	1 layer: TPMI=0	0	1 layer: TPMI=0	0	1 layer: TPMI=0
1	1 layer: TPMI=1	1	1 layer: TPMI=1	1	1 layer: TPMI=1
...
3	1 layer: TPMI=3	3	1 layer: TPMI=3	3	1 layer: TPMI=3
4	2 layers: TPMI=0	4	2 layers: TPMI=0	4	2 layers: TPMI=0
...
9	2 layers: TPMI=5	9	2 layers: TPMI=5	9	2 layers: TPMI=5
10	3 layers: TPMI=0	10	3 layers: TPMI=0	10	3 layers: TPMI=0
11	4 layers: TPMI=0	11	4 layers: TPMI=0	11	4 layers: TPMI=0
12	1 layer: TPMI=4	12	1 layer: TPMI=4	12-15	reserved
...		
19	1 layer: TPMI=11	19	1 layer: TPMI=11		
20	2 layers: TPMI=6	20	2 layers: TPMI=6		
...		
27	2 layers: TPMI=13	27	2 layers: TPMI=13		
28	3 layers: TPMI=1	28	3 layers: TPMI=1		
29	3 layers: TPMI=2	29	3 layers: TPMI=2		
30	4 layers: TPMI=1	30	4 layers: TPMI=1		
31	4 layers: TPMI=2	31	4 layers: TPMI=2		
32	1 layers: TPMI=12				
...	...				
47	1 layers: TPMI=27				
48	2 layers: TPMI=14				
...	...				
55	2 layers: TPMI=21				
56	3 layers: TPMI=3				
...	...				
59	3 layers: TPMI=6				
60	4 layers: TPMI=3				
61	4 layers: TPMI=4				
62-63	reserved				

Table 7.3.1.1.2-3: Precoding information and number of layers for 4 antenna ports, if *transformPrecoder= enabled*, or if *transformPrecoder=disabled* and *maxRank = 1*

Bit field mapped to index	<i>codebookSubset = fullyAndPartialAndNonCoherent</i>	Bit field mapped to index	<i>codebookSubset= partialAndNonCoherent</i>	Bit field mapped to index	<i>codebookSubset = nonCoherent</i>
0	1 layer: TPMI=0	0	1 layer: TPMI=0	0	1 layer: TPMI=0
1	1 layer: TPMI=1	1	1 layer: TPMI=1	1	1 layer: TPMI=1
...
3	1 layer: TPMI=3	3	1 layer: TPMI=3	3	1 layer: TPMI=3
4	1 layer: TPMI=4	4	1 layer: TPMI=4		
...		
11	1 layer: TPMI=11	11	1 layer: TPMI=11		
12	1 layers: TPMI=12	12-15	reserved		
...	...				
27	1 layers: TPMI=27				
28-31	reserved				

Table 7.3.1.1.2-4: Precoding information and number of layers, for 2 antenna ports, if *transformPrecoder=disabled* and *maxRank = 2*

Bit field mapped to index	<i>codebookSubset = fullyAndPartialAndNonCoherent</i>	Bit field mapped to index	<i>codebookSubset = nonCoherent</i>
0	1 layer: TPMI=0	0	1 layer: TPMI=0
1	1 layer: TPMI=1	1	1 layer: TPMI=1
2	2 layers: TPMI=0	2	2 layers: TPMI=0
3	1 layer: TPMI=2	3	reserved
4	1 layer: TPMI=3		
5	1 layer: TPMI=4		
6	1 layer: TPMI=5		
7	2 layers: TPMI=1		
8	2 layers: TPMI=2		
9-15	reserved		

Table 7.3.1.1.2-5: Precoding information and number of layers, for 2 antenna ports, if *transformPrecoder= enabled*, or if *transformPrecoder= disabled* and *maxRank = 1*

Bit field mapped to index	<i>codebookSubset = fullyAndPartialAndNonCoherent</i>	Bit field mapped to index	<i>codebookSubset = nonCoherent</i>
0	1 layer: TPMI=0	0	1 layer: TPMI=0
1	1 layer: TPMI=1	1	1 layer: TPMI=1
2	1 layer: TPMI=2		
3	1 layer: TPMI=3		
4	1 layer: TPMI=4		
5	1 layer: TPMI=5		
6-7	reserved		

...

Table 7.3.1.1.2-33: VRB-to-PRB mapping

Bit field mapped to index	VRB-to-PRB mapping
0	Non-interleaved
1	Interleaved

[TS 38.214, clause 6.1.2.1]

When the UE is scheduled to transmit a transport block and no CSI report, or the UE is scheduled to transmit a transport block and a CSI report on PUSCH by a DCI, the *Time domain resource assignment* field value m of the DCI provides a row index $m + 1$ to an allocated table. The determination of the used resource allocation table is defined in sub-clause 6.1.2.1.1. The indexed row defines the slot offset K_2 , the start and length indicator $SLIV$, or directly the start symbol S and the allocation length L , and the PUSCH mapping type to be applied in the PUSCH transmission.

When the UE is scheduled to transmit a PUSCH with no transport block and with a CSI report by a *CSI request* field on a DCI, the *Time-domain resource assignment* field value m of the DCI provides a row index $m + 1$ to an allocated table. The determination of the applied resource allocation table is defined in sub-clause 6.1.2.1.1. The indexed row defines the start and length indicator $SLIV$, or directly the start symbol S and the allocation length L , and the PUSCH mapping type to be applied in the PUSCH transmission and K_2 is determined based on the corresponding list entries $Y_j, j = 0, \dots, N_{\text{Rep}} - 1$ of the higher layer parameter *reportSlotConfig* in *CSI-ReportConfig* for the N_{Rep} triggered CSI Reporting Settings. The i th codepoint of K_2 is determined as $K_2 = \max_j Y_j(i)$ where $Y_j(i)$ is the i th codepoint of Y_j .

- The slot where the UE shall transmit the PUSCH is determined by K_2 as $\left\lceil n \cdot \frac{2^{\mu_{\text{PUSCH}}}}{2^{\mu_{\text{PDCCH}}}} \right\rceil + K_2$ where n is the slot with the scheduling DCI, K_2 is based on the numerology of PUSCH, and μ_{PUSCH} and μ_{PDCCH} are the subcarrier spacing configurations for PUSCH and PDCCH, respectively, and

- The starting symbol S relative to the start of the slot, and the number of consecutive symbols L counting from the symbol S allocated for the PUSCH are determined from the start and length indicator $SLIV$ of the indexed row:

if $(L-1) \leq 7$ then

$$SLIV = 14 \cdot (L-1) + S$$

else

$$SLIV = 14 \cdot (14 - L + 1) + (14 - 1 - S)$$

where $0 < L \leq 14 - S$, and

- The PUSCH mapping type is set to Type A or Type B as defined in Subclause 6.4.1.1.3 of [4, TS 38.211] as given by the indexed row.

The UE shall consider the S and L combinations defined in table 6.1.2.1-1 as valid PUSCH allocations

Table 6.1.2.1-1: Valid S and L combinations

PUSCH mapping type	Normal cyclic prefix			Extended cyclic prefix		
	S	L	$S+L$	S	L	$S+L$
Type A	0	{4,...,14}	{4,...,14}	0	{4,...,12}	{4,...,12}
Type B	{0,...,13}	{1,...,14}	{1,...,14}	{0,...,12}	{1,...,12}	{1,...,12}

When the UE is configured with $aggregationFactorUL > 1$, the same symbol allocation is applied across the $aggregationFactorUL$ consecutive slots and the PUSCH is limited to a single transmission layer. The UE shall repeat the TB across the $aggregationFactorUL$ consecutive slots applying the same symbol allocation in each slot. The redundancy version to be applied on the n^{th} transmission occasion of the TB is determined according to table 6.1.2.1-2.

Table 6.1.2.1-2: Redundancy version when $aggregationFactorUL > 1$

rv_{id} indicated by the DCI scheduling the PUSCH	rv_{id} to be applied to n^{th} transmission occasion			
	$n \bmod 4 = 0$	$n \bmod 4 = 1$	$n \bmod 4 = 2$	$n \bmod 4 = 3$
0	0	2	3	1
2	2	3	1	0
3	3	1	0	2
1	1	0	2	3

If the UE procedure for determining slot configuration, as defined in subclause 11.1 of [6, TS 38.213], determines symbols of a slot allocated for PUSCH as downlink symbols, the transmission on that slot is omitted for multi-slot PUSCH transmission.

[38.214 clause 6.1.2.2]

The UE shall determine the resource block assignment in frequency domain using the resource allocation field in the detected PDCCH DCI. Two uplink resource allocation schemes type 0 and type 1 are supported. Uplink resource allocation scheme type 0 is supported for PUSCH only when transform precoding is disabled. Uplink resource allocation scheme type 1 is supported for PUSCH for both cases when transform precoding is enabled or disabled.

If the scheduling DCI is configured to indicate the uplink resource allocation type as part of the *Frequency domain resource* assignment field by setting a higher layer parameter *resourceAllocation* in *pusch-Config* to 'dynamicswitch', the UE shall use uplink resource allocation type 0 or type 1 as defined by this DCI field. Otherwise the UE shall use the uplink frequency resource allocation type as defined by the higher layer parameter *resourceAllocation*.

The UE shall assume that when the scheduling PDCCH is received with DCI format 0_0, then uplink resource allocation type 1 is used.

If a bandwidth part indicator field is not configured in the scheduling DCI, the RB indexing for uplink type 0 and type 1 resource allocation is determined within the UE's active bandwidth part. If a bandwidth part indicator field is configured in the scheduling DCI, the RB indexing for uplink type 0 and type 1 resource allocation is determined within the UE's bandwidth part indicated by bandwidth part indicator field value in the DCI, except for the case when DCI format 0_0 is decoded in any PDCCH common search space in CORESET 0 in which case the initial bandwidth part shall be used. The UE shall upon detection of PDCCH intended for the UE determine first the uplink bandwidth part and then the resource allocation within the bandwidth part.

[38.214 clause 6.1.2.2.1]

In uplink resource allocation of type 0, the resource block assignment information includes a bitmap indicating the Resource Block Groups (RBGs) that are allocated to the scheduled UE where a RBG is a set of consecutive virtual resource blocks defined by higher layer parameter *rbg-Size* configured for PUSCH and the size of the carrier bandwidth part as defined in Table 6.1.2.2.1-1.

Table 6.1.2.2.1-1: Nominal RBG size P

Carrier Bandwidth Part Size	Configuration 1	Configuration 2
1 – 36	2	4
37 – 72	4	8
73 – 144	8	16
145 – 275	16	16

The total number of RBGs (N_{RBG}) for a uplink carrier bandwidth part i of size $N_{\text{BWP},i}^{\text{size}}$ PRBs is given by

$$N_{\text{RBG}} = \left(N_{\text{BWP},i}^{\text{size}} + \left(N_{\text{BWP},i}^{\text{start}} \bmod P \right) \right) / P \quad \text{where}$$

- the size of the first RBG is $\text{RBG}_0^{\text{size}} = P - N_{\text{BWP},i}^{\text{start}} \bmod P$,
- the size of the last RBG is $\text{RBG}_{\text{last}}^{\text{size}} = \left(N_{\text{BWP},i}^{\text{start}} + N_{\text{BWP},i}^{\text{size}} \right) \bmod P$ if $\left(N_{\text{BWP},i}^{\text{start}} + N_{\text{BWP},i}^{\text{size}} \right) \bmod P > 0$ and P otherwise.
- the size of all other RBG is P .

The bitmap is of size N_{RBG} bits with one bitmap bit per RBG such that each RBG is addressable. The RBGs shall be indexed in the order of increasing frequency of the carrier bandwidth part and starting at the lowest frequency. The order of RBG bitmap is such that RBG 0 to RBG $N_{\text{RBG}} - 1$ are mapped from MSB to LSB of the bitmap. The RBG is allocated to the UE if the corresponding bit value in the bitmap is 1, the RBG is not allocated to the UE otherwise.

[38.214 clause 6.1.2.2.2]

In uplink resource allocation of type 1, the resource block assignment information indicates to a scheduled UE a set of contiguously allocated non-interleaved virtual resource blocks within the active carrier bandwidth part of size $N_{\text{BWP}}^{\text{size}}$

PRBs except for the case when DCI format 0_0 is decoded in the Type0-PDCCH common search space in CORESET 0 in which case the initial bandwidth part of size N_{BWP}^{size} shall be used.

An uplink type 1 resource allocation field consists of a resource indication value (RIV) corresponding to a starting virtual resource block (RB_{start}) and a length in terms of contiguously allocated resource blocks L_{RBs} . The resource indication value is defined by

if $(L_{RBs} - 1) \leq \lfloor N_{BWP}^{size} / 2 \rfloor$ then

$$RIV = N_{BWP}^{size} (L_{RBs} - 1) + RB_{start}$$

else

$$RIV = N_{BWP}^{size} (N_{BWP}^{size} - L_{RBs} + 1) + (N_{BWP}^{size} - 1 - RB_{start})$$

where $L_{RBs} \geq 1$ and shall not exceed $N_{BWP}^{size} - RB_{start}$.

[TS 38.214, clause 6.1.4.1]

For the PUSCH assigned by a DCI format 0_0/0_1 with CRC scrambled by C-RNTI, new-RNTI, TC-RNTI, or SP-CSI-RNTI, the transform precoding is enabled if *transformPrecoder* in *PUSCH-Config* is set to 'enabled', or if *transformPrecoder* in *PUSCH-Config* is not configured and *msg3-transformPrecoding* in *rach-ConfigCommon* is set to 'enabled'; otherwise the transform precoding is disabled.

For the PUSCH assigned by a DCI format 0_0/0_1 with CRC scrambled by CS-RNTI, or the PUSCH with configured grant using CS-RNTI, the transform precoding is enabled if *transformPrecoder* in *ConfiguredGrantConfig* is set to 'enabled'; otherwise the transform precoding is disabled.

For a PUSCH scheduled by RAR UL grant or for a PUSCH scheduled by a DCI format 0_0/0_1 with CRC scrambled by C-RNTI, TC-RNTI, or CS-RNTI, or SP-CSI-RNTI, or for a PUSCH with configured grant using CS-RNTI,

if *transformPrecoder* is disabled for this PUSCH transmission

- if *mcs-Table* in *PUSCH-Config* is set to 'qam256', and PUSCH is scheduled with C-RNTI or SP-CSI-RNTI, and PUSCH is assigned by DCI format 0_1,
 - the UE shall use I_{MCS} and Table 5.1.3.1-2 to determine the modulation order (Q_m) and Target code rate (R) used in the physical uplink shared channel.
- elseif the UE is not configured with new-RNTI, *mcs-Table* in *PUSCH-Config* is set to 'qam64LowSE', the PUSCH is scheduled with C-RNTI, or SP-CSI-RNTI, and the PUSCH is assigned by a PDCCH in a UE-specific search space,
 - the UE shall use I_{MCS} and Table 5.1.3.1-3 to determine the modulation order (Q_m) and Target code rate (R) used in the physical uplink shared channel.
- elseif the UE is configured with new-RNTI, and the PUSCH is scheduled with new-RNTI,
 - the UE shall use I_{MCS} and Table 5.1.3.1-3 to determine the modulation order (Q_m) and Target code rate (R) used in the physical uplink shared channel.
- elseif *mcs-Table* in *ConfiguredGrantConfig* is set to 'qam256', and PUSCH is scheduled with CS-RNTI,
 - the UE shall use I_{MCS} and Table 5.1.3.1-2 to determine the modulation order (Q_m) and Target code rate (R) used in the physical uplink shared channel.
- elseif *mcs-Table* in *ConfiguredGrantConfig* is set to 'qam64LowSE', and PUSCH is scheduled with CS-RNTI,
 - the UE shall use I_{MCS} and Table 5.1.3.1-3 to determine the modulation order (Q_m) and Target code rate (R) used in the physical uplink shared channel.
- else

- the UE shall use I_{MCS} and Table 5.1.3.1-1 to determine the modulation order (Q_m) and Target code rate (R) used in the physical uplink shared channel.

[TS 38.214, clause 5.1.3.1]

Table 5.1.3.1-1: MCS index table 1 for PDSCH

MCS Index I_{MCS}	Modulation Order Q_m	Target code Rate $R \times [1024]$	Spectral efficiency
0	2	120	0.2344
1	2	157	0.3066
2	2	193	0.3770
3	2	251	0.4902
4	2	308	0.6016
5	2	379	0.7402
6	2	449	0.8770
7	2	526	1.0273
8	2	602	1.1758
9	2	679	1.3262
10	4	340	1.3281
11	4	378	1.4766
12	4	434	1.6953
13	4	490	1.9141
14	4	553	2.1602
15	4	616	2.4063
16	4	658	2.5703
17	6	438	2.5664
18	6	466	2.7305
19	6	517	3.0293
20	6	567	3.3223
21	6	616	3.6094
22	6	666	3.9023
23	6	719	4.2129
24	6	772	4.5234
25	6	822	4.8164
26	6	873	5.1152
27	6	910	5.3320
28	6	948	5.5547
29	2	reserved	
30	4	reserved	
31	6	reserved	

[TS 38.214, clause 6.1.4.2]

For a PUSCH scheduled by RAR UL grant or for a PUSCH scheduled by a DCI format 0_0/0_1 with CRC scrambled by C-RNTI, new-RNTI, TC-RNTI, CS-RNTI, or SP-CSI-RNTI.

if

- $0 \leq I_{MCS} \leq 27$ and transform precoding is disabled and Table 5.1.3.1-2 is used, or
- $0 \leq I_{MCS} \leq 28$ and transform precoding is disabled and a table other than Table 5.1.3.1-2 is used, or
- $0 \leq I_{MCS} \leq 27$ and transform precoding is enabled, the UE shall first determine the TBS as specified below:

The UE shall first determine the number of REs (N_{RE}) within the slot:

- A UE first determines the number of REs allocated for PUSCH within a PRB (N'_{RE}) by
- $N'_{RE} = N_{sc}^{RB} * N_{ymb}^{sh} - N_{DMRS}^{PRB} - N_{oh}^{PRB}$, where $N_{sc}^{RB} = 12$ is the number of subcarriers in the frequency domain in a physical resource block, N_{ymb}^{sh} is the number of symbols of the PUSCH allocation within the

slot, N_{DMRS}^{PRB} is the number of REs for DM-RS per PRB in the scheduled duration including the overhead of the DM-RS CDM groups without data, as indicated by DCI format 0_1 or as described for DCI format 0_0 in Subclause 6.2.2, and N_{oh}^{PRB} is the overhead configured by higher layer parameter $xOverhead$ in *PUSCH-ServingCellConfig*. If the N_{oh}^{PRB} is not configured (a value from 0, 6, 12, or 18), the N_{oh}^{PRB} is assumed to be 0. For MSG3 transmission the N_{oh}^{PRB} is always set to 0..

- A UE determines the total number of REs allocated for PUSCH (N_{RE}) by

$$N_{RE} = \min(156, N_{RE}') \cdot n_{PRB}$$
 where n_{PRB} is the total number of allocated PRBs for the UE.
- Next, proceed with steps 2-4 as defined in Subclause 5.1.3.2

else if

- $28 \leq I_{MCS} \leq 31$ and transform precoding is disabled and Table 5.1.3.1-2 is used, or
- $28 \leq I_{MCS} \leq 31$ and transform precoding is enabled,
- the TBS is assumed to be as determined from the DCI transported in the latest PDCCH for the same transport block using $0 \leq I_{MCS} \leq 27$. If there is no PDCCH for the same transport block using $0 \leq I_{MCS} \leq 27$, and if the initial PUSCH for the same transport block is transmitted with configured grant, the TBS shall be determined from the most recent configured scheduling PDCCH.

else

- the TBS is assumed to be as determined from the DCI transported in the latest PDCCH for the same transport block using $0 \leq I_{MCS} \leq 28$. If there is no PDCCH for the same transport block using $0 \leq I_{MCS} \leq 28$, and if the initial PUSCH for the same transport block is transmitted with configured grant, the TBS shall be determined from the most recent configured scheduling PDCCH.

[TS 38.214, clause 5.1.3.2]

- 2) Intermediate number of information bits (N_{info}) is obtained by $N_{info} = N_{RE} \cdot R \cdot Q_m \cdot \nu$.

If $N_{info} \leq 3824$

Use step 3 as the next step of the TBS determination

else

Use step 4 as the next step of the TBS determination

end if

- 3) When $N_{info} \leq 3824$, TBS is determined as follows

- quantized intermediate number of information bits $N_{info}' = \max\left(24, 2^n \cdot \left\lfloor \frac{N_{info}}{2^n} \right\rfloor\right)$, where

$$n = \max(3, \log_2(N_{info})) - 6$$
- use Table 5.1.3.2-2 find the closest TBS that is not less than N_{info}' .

Table 5.1.3.2-2: TBS for $N_{info} \leq 3824$

Index	TBS	Index	TBS	Index	TBS	Index	TBS
1	24	31	336	61	1288	91	3624
2	32	32	352	62	1320	92	3752
3	40	33	368	63	1352	93	3824
4	48	34	384	64	1416		
5	56	35	408	65	1480		
6	64	36	432	66	1544		
7	72	37	456	67	1608		
8	80	38	480	68	1672		
9	88	39	504	69	1736		
10	96	40	528	70	1800		
11	104	41	552	71	1864		
12	112	42	576	72	1928		
13	120	43	608	73	2024		
14	128	44	640	74	2088		
15	136	45	672	75	2152		
16	144	46	704	76	2216		
17	152	47	736	77	2280		
18	160	48	768	78	2408		
19	168	49	808	79	2472		
20	176	50	848	80	2536		
21	184	51	888	81	2600		
22	192	52	928	82	2664		
23	208	53	984	83	2728		
24	224	54	1032	84	2792		
25	240	55	1064	85	2856		
26	256	56	1128	86	2976		
27	272	57	1160	87	3104		
28	288	58	1192	88	3240		
29	304	59	1224	89	3368		
30	320	60	1256	90	3496		

4) When $N_{info} > 3824$, TBS is determined as follows.

- quantized intermediate number of information bits $N'_{info} = \max\left(3840, 2^n \times \text{round}\left(\frac{N_{info} - 24}{2^n}\right)\right)$, where $n = \lfloor \log_2(N_{info} - 24) \rfloor - 5$ and ties in the round function are broken towards the next largest integer.
- if $R \leq 1/4$

$$TBS = 8 \cdot C \cdot \left\lceil \frac{N'_{info} + 24}{8 \cdot C} \right\rceil - 24, \text{ where } C = \left\lceil \frac{N'_{info} + 24}{3816} \right\rceil$$

else

if $N'_{info} > 8424$

$$TBS = 8 \cdot C \cdot \left\lceil \frac{N'_{info} + 24}{8 \cdot C} \right\rceil - 24, \text{ where } C = \left\lceil \frac{N'_{info} + 24}{8424} \right\rceil$$

else

$$TBS = 8 \cdot \left\lceil \frac{N'_{info} + 24}{8} \right\rceil - 24$$

end if

end if

7.1.1.4.2.3.3 Test description

7.1.1.4.2.3.3.1 Pre-test conditions

Same Pre-test conditions as in clause 7.1.1.0 except set the NR Cell bandwidth and applicable BWP to maximum for the NR Band under test as specified in Table 5.3.5-1 in TS 38.101-1 [16] / TS 38.101-2 [17] (to enable testing of n_{PRB} up to maximum value).

Test frequency NRf1 is as specified in TS 38.508-1 [4] clause 4.3.1 using the common highest UL and DL channel bandwidth and using the default subcarrier spacing specified in TS 38.508-1 [4] clause 6.2.3.1.

7.1.1.4.2.3.3.2 Test procedure sequence

Table 7.1.1.4.2.3.3.2-1: Maximum TBS for different UE categories

UE Category	Maximum number of bits of a UL-SCH transport block received within a TTI
TS 38.306 [23] clause 4.1.2 require UE without <i>ue-CategoryDL</i> and <i>ue-CategoryUL</i> , to support Max TBS achievable based on max bandwidth of the Band under test.	

Table 7.1.1.4.2.3.3.2-2: Number of downlink PDCP SDUs and PDCP SDU size used as test data

TBS [bits]	Number of PDCP SDUs	PDCP SDU size [bits] (Note 1)
$136 \leq TBS \leq 12128$ note 2	1	$8 * \text{FLOOR}((TBS - 128)/8)$
$12129 \leq TBS \leq 24200$	2	$8 * \text{FLOOR}((TBS - 200)/16)$
$24201 \leq TBS \leq 36272$	3	$8 * \text{FLOOR}((TBS - 272)/24)$
$36273 \leq TBS \leq 48344$	4	$8 * \text{FLOOR}((TBS - 344)/32)$
$48345 \leq TBS \leq 60416$	5	$8 * \text{FLOOR}((TBS - 416)/40)$
$60417 \leq TBS \leq 72488$	6	$8 * \text{FLOOR}((TBS - 488)/48)$
$72489 \leq TBS \leq 84560$	7	$8 * \text{FLOOR}((TBS - 560)/56)$
$84561 \leq TBS \leq 96632$	8	$8 * \text{FLOOR}((TBS - 632)/64)$
$96633 \leq TBS \leq 108704$	9	$8 * \text{FLOOR}((TBS - 704)/72)$
$10705 \leq TBS \leq 120776$	10	$8 * \text{FLOOR}((TBS - 776)/80)$
$120777 \leq TBS \leq 132848$	11	$8 * \text{FLOOR}((TBS - 848)/88)$
$132849 \leq TBS \leq 144920$	12	$8 * \text{FLOOR}((TBS - 920)/96)$
$TBS > 144920$	13	$8 * \text{FLOOR}((TBS - 992)/104)$

Note 1: Each PDCP SDU is limited to 1500 octets (to keep below maximum SDU size of ESM as specified in TS 24.301 [21] clause 9.9.4.12).

The PDCP SDU size of each PDCP SDU is

$$\text{PDCP SDU size} = (TBS - N * \text{PDCP header size} - N * \text{AMD PDU header size} - N * \text{MAC header size} - \text{Size of Timing Advance} - \text{RLC Status PDU size} - \text{MAC header for RLC Status PDU}) / N, \text{ where}$$

PDCP header size is 24 bits for the RLC AM and 18-bit SN case;
AMD PDU header size is 24 bits with 18 bit SN;

MAC header size for AMD PDU = 16 or 24 bits depending on L=8 or 16 bits. Worst case 24 is taken.

Size of Timing Advance MAC CE with header is 16 bits (if no Timing Advance and/or RLC status needs to be sent, padding will occur instead).

RLC Status PDU size = 24 bits with 1 ACK_SN, With a MAC header of 16 bits.

This gives:

$$\text{PDCP SDU size} = 8 * \text{FLOOR}((TBS - N * 24 - N * 24 - N * 24 - 56) / (8 * N)) \text{ bits.}$$

Note 2: According to the final PDCP SDU size formula in Note 1, the smallest TBS that can be tested is 136 bits.

Table 7.1.1.4.2.3.3.2-2A: Bandwidth part Dependent Parameters for Resource allocation 0 with start of BWP assumed as 0

$N_{RB}^{DL,BWP} = N_{BWP,i}^{size}$	Nominal RBG size P (Configuration1)	Size of last RBG	Allowed N_{PRB} Values
11	2	1	All 1...11
18	2	2	2,4,6,8,10,12,16,18
24	2	2	2,4,6,8,10,12,16,18,20,22,24
25	2	1	All 1...25
31	2	1	All 1...31
32	2	2	2,4,6,8,10,12,16,18,20,22,24,26,28,30,32
38	4	2	2,4,6,8,10,12,16,18,20,22,24,26,28,30,32,34,36,38
51	4	3	3,4,7,8,11,12,15,16,19,20,23,24,27,28,31,32,35,36,39,40,43,44,47,48,51
52	4	4	4,8,12,16,20,24,28,32,36,40,44,48,52
65	4	1	1,4,5,8,9,12,13,16,17,20,21,24,25,28,29,32,33,36,37,40,41,44,45,48,49,52,53,56,57,60,61,64,65
66	4	2	2,4,6,8,10,12,16,18,20,22,24,26,28,30,32,34,36,38,40,42,44,46,48,50,52,54,56,58,60,62,64,66
79	8	7	7,8,15,16,23,24,31,32,39,40,47,48,55,56,63,64,71,72,79
106	8	2	2,8,10,16,18,24,26,32,34,40,42,48,50,56,58,64,66,72,74,80,82,88,90,96,92,104,106
107	8	3	3,8,11,16,19,24,27,32,35,40,43,48,51,56,59,64,67,72,75,80,83,88,91,96,99,104,107
132	8	4	4,8,12,16,20,24,28,32,36,40,44,48,52,56,60,64,68,72,76,80,84,88,92,96,100,104,108,112,116,120,124,128,132
133	8	5	5,8,13,16,21,24,29,32,37,40,45,48,53,56,61,64,69,72,77,80,85,88,93,96,101,104,109,112,117,120,125,128,133
135	8	7	7,8,15,16,23,24,31,32,39,40,47,48,55,56,63,64,71,72,79,80,87,88,95,96,103,104,111,112,119,120,127,128,135
160	16	16	16,32,48,64,80,96,112,128,144,160
216	16	8	8,16,24,32,40,48,56,64,72,80,88,96,104,112,120,128,136,144,152,160,168,176,184,192,200,208,216
217	16	9	9,16,25,32,41,48,57,64,73,80,89,96,105,112,121,128,137,144,153,160,169,176,185,192,201,208,217
264	16	8	8,16,24,32,40,48,56,64,72,80,88,96,104,112,120,128,136,144,160,168,176,184,192,200,208,216,224,232,240,248,256,264
270	16	14	14,16,30,32,46,44,62,64,78,80,94,96,110,112,126,128,142,144,158,160,174,176,190,192,206,208,222,224,238,240,254,256,270
273	16	1	1,16,17,32,33,48,49,64,65,80,81,96,97,112,113,128,129,144,145,160,161,176,171,192,193,208,209,224,225,240,241,256,257,272,273

Table 7.1.1.4.2.3.3.2-3: Specific Parameter

Parameter	Value	Comment	Condition
mcs-Table	qam64		
resourceAllocation	dynamicSwitch		pc_dynamicSwitchRA_Type0_1_PUSCH
	resourceAllocationType1		NOT pc_dynamicSwitchRA_Type0_1_PUSCH AND Steps 1-5
	resourceAllocationType0		NOT pc_dynamicSwitchRA_Type0_1_PUSCH AND pc_ra_Type0_PUSCH AND Steps 6-10
rbg-Size	Not present	configuration 1 applicable	
N_{BWP}^{start}	0		

Table 7.1.1.4.2.3.3.2-4: Main behaviour

		U - S	Message		
-	EXCEPTION: Steps 1 to 5 are repeated for allowed values of N_{PRB} 1 to $N_{PRB}^{UL,BWP}$ in BWP, time domain resource as per Table 7.1.1.4.2.0-1 and I_{MCS} from 0 to 28. Skip the execution of steps 1 to 5 for $I_{MCS} = 28$ and $N_{PRB} < 4$. (Note3)	-	-	-	-
3GPP TS 38.523-1 version 16.6.0 Release 16		619	ETSI TS 138 523-1 V16.6.0 (2021-02)		
1	SS calculates or looks up TBS in TS 38.214 [15] based on the value of S, L, I_{MCS} and n_{PRB} .	-	-	-	-
-	EXCEPTION: Steps 2 to 5 are performed if TBS is less than or equal to UE capability "Maximum number of UL-SCH transport block bits received within a TTI" as specified in Table 7.1.1.4.2.3.3.2-1 and larger than or equal to 136 bits as specified in Table 7.1.1.4.2.3.3.2-2 Skip the execution of steps 2 to 5 for which the value of N'_{info} satisfies the condition $3824 < N'_{info} < 3825$.(Note 4)	-	-	-	-
2	SS creates one or more PDCP SDUs depending on TBS in accordance with Table 7.1.1.4.2.3.3.2-2.	-	-	-	-
3	After 300ms, the SS transmits all PDCP SDUs (N_{SDUs}) as created in step 2 in a MAC PDU.	<--	MAC PDU (NxPDCP SDUs)	-	-
4	After 60ms of step 3 SS transmits UL Grant DCI 0_1, and values of S, L, I_{MCS} and n_{PRB} .	<--	(UL Grant) (DCI: (DCI Format 0_1, S, L, I_{MCS} and n_{PRB}))	-	-
5	CHECK: Does UE return the same number of PDCP SDUs with same content as transmitted by the SS in step 3 using Time, frequency Resources and modulation and coding scheme as configured by the SS in step 4?	-->	(NxPDCP SDUs)	2	P
-	EXCEPTION : Steps 5Aa1 to 10 are executed if $pc_ra_Type0_PUSCH$	-	-	-	-
-	EXCEPTION : Steps 5Aa1 to 5Aa2 are executed if NOT $pc_dynamicSwitchRA_Type0_1_PUSCH$	-	-	-	-
5A a1	The SS transmits a NR RRCReconfiguration message including <i>PUSCH-Config</i> with IE resourceAllocation set to resourceAllocationType1 (Note 1)	<--	<i>RRCReconfiguration</i>	-	-
5A a2	The UE transmit a NR <i>RRCReconfigurationComplete</i> message. (Note 2)	-->	<i>RRCReconfigurationComplete</i>	-	-
-	EXCEPTION: Steps 6 to 10 are repeated for allowed values of N_{PRB} as per table 7.1.1.4.2.3.3.2-2A in BWP, time domain resource length L 3 to 14-S and I_{MCS} from 0 to 28. Skip the execution of steps 6 to 10 for $I_{MCS} = 28$ and $N_{PRB} < 4$. (Note 3)	-	-	-	-
6	SS calculates or looks up TBS in TS 38.214 [15] based on the value of S, L, I_{MCS} and n_{PRB} .	-	-	-	-
-	EXCEPTION: Steps 7 to 10 are performed if TBS1 + TBS2 is less than or equal to UE capability "Maximum number of UL-SCH transport block bits received within a TTI" as specified in Table 7.1.1.4.2.3.3.2-1 and larger than or equal to 136 bits as specified in Table 7.1.1.4.2.3.3.2-2. Skip the execution of steps 7 to 10 for which	-	-	-	-
		ETSI			

7.1.1.4.2.3.3.3 Specific message contents

None.

7.1.1.4.2.4 UL-SCH transport block size selection / DCI format 0_1 / RA type 0/RA Type 1 / 256QAM / Transform precoding disabled

7.1.1.4.2.4.1 Test Purpose (TP)

(1)

```
with { UE in RRC_CONNECTED state and mcs-Table is set as 'qam256' }
ensure that {
  when { UE has pending data for transmission and receives DCI format 1_1 indicating resource
allocation type 0 a resource block assignment correspondent to physical resource blocks , Time
domain resource assignment and a modulation and coding }
  then { UE transmits MAC PDU's on PUSCH as per Modulation Coding scheme, time domain resource
allocation and PRB's }
}
```

(2)

```
with { UE in RRC_CONNECTED state and mcs-Table is set as 'qam256' }
ensure that {
  when { UE has pending data for transmission and receives DCI format 1_1 indicating resource
allocation type 1 a resource block assignment correspondent to physical resource blocks , Time
domain resource assignment and a modulation and coding }
  then { UE transmits MAC PDU's on PUSCH as per Modulation Coding scheme, time domain resource
allocation and PRB's }
}
```

7.1.1.4.2.4.2 Conformance requirements

References: The conformance requirements covered in the present TC are specified in: TS 38.212 clause 7.3.1.1.1, TS 38.214 clause 6.1.2.1, 6.1.2.2, 6.1.2.2.1, 6.1.2.2.2, 6.1.4.1, 5.1.3.1, 6.1.4.2 and 5.1.3.2. Unless otherwise stated these are Rel-15 requirements.

[TS 38.212, clause 7.3.1.1.2]

DCI format 0_1 is used for the scheduling of PUSCH in one cell.

The following information is transmitted by means of the DCI format 0_1 with CRC scrambled by C-RNTI or CS-RNTI or SP-CSI-RNTI or new-RNTI:

- Identifier for DCI formats – 1 bit
- The value of this bit field is always set to 0, indicating an UL DCI format
 - Carrier indicator – 0 or 3 bits, as defined in Subclause 10.1 of [5, TS38.213].
 - UL/SUL indicator – 0 bit for UEs not configured with SUL in the cell or UEs configured with SUL in the cell but only PUCCH carrier in the cell is configured for PUSCH transmission; 1 bit for UEs configured with SUL in the cell as defined in Table 7.3.1.1.1-1.
 - Bandwidth part indicator – 0, 1 or 2 bits as determined by the number of UL BWPs $n_{\text{BWP,RRC}}$ configured by higher layers, excluding the initial UL bandwidth part. The bit width for this field is determined as $\lceil \log_2(n_{\text{BWP}}) \rceil$ bits, where
 - $n_{\text{BWP}} = n_{\text{BWP,RRC}} + 1$ if $n_{\text{BWP,RRC}} \leq 3$, in which case the bandwidth part indicator is equivalent to the higher layer parameter *BWP-Id*;
 - otherwise $n_{\text{BWP}} = n_{\text{BWP,RRC}}$, in which case the bandwidth part indicator is defined in Table 7.3.1.1.2-1;

If a UE does not support active BWP change via DCI, the UE ignores this bit field.

- Frequency domain resource assignment – number of bits determined by the following, where $N_{RB}^{UL,BWP}$ is the size of the active UL bandwidth part:
 - N_{RBG} bits if only resource allocation type 0 is configured, where N_{RBG} is defined in Subclause 6.1.2.2.1 of [6, TS 38.214],
 - $\log_2(N_{RB}^{UL,BWP}(N_{RB}^{UL,BWP} + 1)/2)$ bits if only resource allocation type 1 is configured, or $\max(\log_2(N_{RB}^{UL,BWP}(N_{RB}^{UL,BWP} + 1)/2), N_{RBG}) + 1$ bits if both resource allocation type 0 and 1 are configured.
- If both resource allocation type 0 and 1 are configured, the MSB bit is used to indicate resource allocation type 0 or resource allocation type 1, where the bit value of 0 indicates resource allocation type 0 and the bit value of 1 indicates resource allocation type 1.
- For resource allocation type 0, the N_{RBG} LSBs provide the resource allocation as defined in Subclause 6.1.2.2.1 of [6, TS 38.214].
- For resource allocation type 1, the $\log_2(N_{RB}^{UL,BWP}(N_{RB}^{UL,BWP} + 1)/2)$ LSBs provide the resource allocation as follows:
 - For PUSCH hopping with resource allocation type 1:
 - N_{UL_hop} MSB bits are used to indicate the frequency offset according to Subclause 6.3 of [6, TS 38.214], where $N_{UL_hop} = 1$ if the higher layer parameter *frequencyHoppingOffsetLists* contains two offset values and $N_{UL_hop} = 2$ if the higher layer parameter *frequencyHoppingOffsetLists* contains four offset values
 - $\log_2(N_{RB}^{UL,BWP}(N_{RB}^{UL,BWP} + 1)/2) - N_{UL_hop}$ bits provides the frequency domain resource allocation according to Subclause 6.1.2.2.2 of [6, TS 38.214]
 - For non-PUSCH hopping with resource allocation type 1:
 - $\log_2(N_{RB}^{UL,BWP}(N_{RB}^{UL,BWP} + 1)/2)$ bits provides the frequency domain resource allocation according to Subclause 6.1.2.2.2 of [6, TS 38.214]

If "Bandwidth part indicator" field indicates a bandwidth part other than the active bandwidth part and if both resource allocation type 0 and 1 are configured for the indicated bandwidth part, the UE assumes resource allocation type 0 for the indicated bandwidth part if the bit width of the "Frequency domain resource assignment" field of the active bandwidth part is smaller than the bit width of the "Frequency domain resource assignment" field of the indicated bandwidth part.

- Time domain resource assignment – 0, 1, 2, 3, or 4 bits as defined in Subclause 6.1.2.1 of [6, TS38.214]. The bit width for this field is determined as $\log_2(I)$ bits, where I the number of entries in the higher layer parameter *pusch-AllocationList*.
- Frequency hopping flag – 0 or 1 bit:
 - 0 bit if only resource allocation type 0 is configured or if the higher layer parameter *frequencyHopping* is not configured;
 - 1 bit according to Table 7.3.1.1.2-34 otherwise, only applicable to resource allocation type 1, as defined in Subclause 6.3 of [6, TS 38.214].
- Modulation and coding scheme – 5 bits as defined in Subclause 6.1.4.1 of [6, TS 38.214]
- New data indicator – 1 bit
- Redundancy version – 2 bits as defined in Table 7.3.1.1.1-2

- HARQ process number – 4 bits
- 1st downlink assignment index – 1 or 2 bits:
 - 1 bit for semi-static HARQ-ACK codebook;
 - 2 bits for dynamic HARQ-ACK codebook.
- 2nd downlink assignment index – 0 or 2 bits:
 - 2 bits for dynamic HARQ-ACK codebook with two HARQ-ACK sub-codebooks;
 - 0 bit otherwise.
- TPC command for scheduled PUSCH – 2 bits as defined in Subclause 7.1.1 of [5, TS38.213]
- SRS resource indicator – $\left\lceil \log_2 \left(\sum_{k=1}^{\min\{L_{\max}^{\text{PUSCH}}, N_{\text{SRS}}\}} \binom{N_{\text{SRS}}}{k} \right) \right\rceil$ or $\lceil \log_2(N_{\text{SRS}}) \rceil$ bits, where N_{SRS} is the number of configured SRS resources in the SRS resource set associated with the higher layer parameter *usage* of value '*codeBook*' or '*nonCodeBook*', and L_{\max}^{PUSCH} is the maximum number of supported layers for the PUSCH.
 - $\left\lceil \log_2 \left(\sum_{k=1}^{\min\{L_{\max}^{\text{PUSCH}}, N_{\text{SRS}}\}} \binom{N_{\text{SRS}}}{k} \right) \right\rceil$ bits according to Tables 7.3.1.1.2-28/29/30/31 if the higher layer parameter *txConfig* = *nonCodebook*, where N_{SRS} is the number of configured SRS resources in the SRS resource set associated with the higher layer parameter *usage* of value '*nonCodeBook*';
 - $\lceil \log_2(N_{\text{SRS}}) \rceil$ bits according to Tables 7.3.1.1.2-32 if the higher layer parameter *txConfig* = *codebook*, where N_{SRS} is the number of configured SRS resources in the SRS resource set associated with the higher layer parameter *usage* of value '*codeBook*'.
- Precoding information and number of layers – number of bits determined by the following:
 - 0 bits if the higher layer parameter *txConfig* = *nonCodeBook*;
 - 0 bits for 1 antenna port and if the higher layer parameter *txConfig* = *codebook*;
 - 4, 5, or 6 bits according to Table 7.3.1.1.2-2 for 4 antenna ports, if *txConfig* = *codebook*, and according to the values of higher layer parameters *transformPrecoder*, *maxRank*, and *codebookSubset*;
 - 2, 4, or 5 bits according to Table 7.3.1.1.2-3 for 4 antenna ports, if *txConfig* = *codebook*, and according to the values of higher layer parameters *transformPrecoder*, *maxRank*, and *codebookSubset*;
 - 2 or 4 bits according to Table 7.3.1.1.2-4 for 2 antenna ports, if *txConfig* = *codebook*, and according to the values of higher layer parameters *maxRank* and *codebookSubset*;
 - 1 or 3 bits according to Table 7.3.1.1.2-5 for 2 antenna ports, if *txConfig* = *codebook*, and according to the values of higher layer parameters *maxRank* and *codebookSubset*.
- Antenna ports – number of bits determined by the following
 - 2 bits as defined by Tables 7.3.1.1.2-6, if *transformPrecoder*=*enabled*, *dmrs-Type*=1, and *maxLength*=1;
 - 4 bits as defined by Tables 7.3.1.1.2-7, if *transformPrecoder*=*enabled*, *dmrs-Type*=1, and *maxLength*=2;
 - 3 bits as defined by Tables 7.3.1.1.2-8/9/10/11, if *transformPrecoder*=*disabled*, *dmrs-Type*=1, and *maxLength*=1, and the value of rank is determined according to the SRS resource indicator field if the higher layer parameter *txConfig* = *nonCodebook* and according to the Precoding information and number of layers field if the higher layer parameter *txConfig* = *codebook*;
 - 4 bits as defined by Tables 7.3.1.1.2-12/13/14/15, if *transformPrecoder*=*disabled*, *dmrs-Type*=1, and *maxLength*=2, and the value of rank is determined according to the SRS resource indicator field if the higher

layer parameter $txConfig = nonCodebook$ and according to the Precoding information and number of layers field if the higher layer parameter $txConfig = codebook$;

- 4 bits as defined by Tables 7.3.1.1.2-16/17/18/19, if $transformPrecoder=disabled$, $dmrs-Type=2$, and $maxLength=1$, and the value of rank is determined according to the SRS resource indicator field if the higher layer parameter $txConfig = nonCodebook$ and according to the Precoding information and number of layers field if the higher layer parameter $txConfig = codebook$;
- 5 bits as defined by Tables 7.3.1.1.2-20/21/22/23, if $transformPrecoder=disabled$, $dmrs-Type=2$, and $maxLength=2$, and the value of rank is determined according to the SRS resource indicator field if the higher layer parameter $txConfig = nonCodebook$ and according to the Precoding information and number of layers field if the higher layer parameter $txConfig = codebook$.

where the number of CDM groups without data of values 1, 2, and 3 in Tables 7.3.1.1.2-6 to 7.3.1.1.2-23 refers to CDM groups $\{0\}$, $\{0,1\}$, and $\{0,1,2\}$ respectively.

If a UE is configured with both $dmrs-UplinkForPUSCH-MappingTypeA$ and $dmrs-UplinkForPUSCH-MappingTypeB$, the bit width of this field equals $\max\{x_A, x_B\}$, where x_A is the “Antenna ports” bit width derived according to $dmrs-UplinkForPUSCH-MappingTypeA$ and x_B is the “Antenna ports” bit width derived according to $dmrs-UplinkForPUSCH-MappingTypeB$. A number of $|x_A - x_B|$ zeros are padded in the MSB of this field, if the mapping type of the PUSCH corresponds to the smaller value of x_A and x_B .

- SRS request – 2 bits as defined by Table 7.3.1.1.2-24 for UEs not configured with SUL in the cell; 3 bits for UEs configured SUL in the cell where the first bit is the non-SUL/SUL indicator as defined in Table 7.3.1.1.1-1 and the second and third bits are defined by Table 7.3.1.1.2-24. This bit field may also indicate the associated CSI-RS according to Subclause 6.1.1.2 of [6, TS 38.214].
- CSI request – 0, 1, 2, 3, 4, 5, or 6 bits determined by higher layer parameter $reportTriggerSize$.
- CBG transmission information (CBGTI) – 0, 2, 4, 6, or 8 bits determined by higher layer parameter $maxCodeBlockGroupsPerTransportBlock$ for PUSCH.
- PTRS-DMRS association – number of bits determined as follows
 - 0 bit if $PTRS-UplinkConfig$ is not configured and $transformPrecoder=disabled$, or if $transformPrecoder=enabled$, or if $maxRank=1$;
 - 2 bits otherwise, where Table 7.3.1.1.2-25 and 7.3.1.1.2-26 are used to indicate the association between PTRS port(s) and DMRS port(s) for transmission of one PT-RS port and two PT-RS ports respectively, and the DMRS ports are indicated by the Antenna ports field.

If “Bandwidth part indicator” field indicates a bandwidth part other than the active bandwidth part and the “PTRS-DMRS association” field is present for the indicated bandwidth part but not present for the active bandwidth part, the UE assumes the “PTRS-DMRS association” field is not present for the indicated bandwidth part.

- β_{offset} indicator – 0 if the higher layer parameter $\beta_{offsets} = semiStatic$; otherwise 2 bits as defined by Table 9.3-3 in [5, TS 38.213].
- DMRS sequence initialization – 0 if the higher layer parameter $transformPrecoder=enabled$; 1 bit if the higher layer parameter $transformPrecoder=disabled$ and both $scramblingID0$ and $scramblingID1$ are configured in $DMRS-UplinkConfig$, for n_{SCID} selection defined in Subclause 6.4.1.1.1.1 of [4, TS 38.211].
- UL-SCH indicator – 1 bit. A value of “1” indicates UL-SCH shall be transmitted on the PUSCH and a value of “0” indicates UL-SCH shall not be transmitted on the PUSCH.

For a UE configured with SUL in a cell, if PUSCH is configured to be transmitted on both the SUL and the non-SUL of the cell and if the number of information bits in format 0_1 for the SUL is not equal to the number of information bits in format 0_1 for the non-SUL, zeros shall be appended to smaller format 0_1 until the payload size equals that of the larger format 0_1.

Table 7.3.1.1.2-1: Bandwidth part indicator

Value of BWP indicator field 2 bits	Bandwidth part
00	First bandwidth part configured by higher layers
01	Second bandwidth part configured by higher layers
10	Third bandwidth part configured by higher layers
11	Fourth bandwidth part configured by higher layers

Table 7.3.1.1.2-2: Precoding information and number of layers, for 4 antenna ports, if *transformPrecoder=disabled* and *maxRank = 2 or 3 or 4*

Bit field mapped to index	<i>codebookSubset = fullyAndPartialAndNonCoherent</i>	Bit field mapped to index	<i>codebookSubset = partialAndNonCoherent</i>	Bit field mapped to index	<i>codebookSubset= nonCoherent</i>
0	1 layer: TPMI=0	0	1 layer: TPMI=0	0	1 layer: TPMI=0
1	1 layer: TPMI=1	1	1 layer: TPMI=1	1	1 layer: TPMI=1
...
3	1 layer: TPMI=3	3	1 layer: TPMI=3	3	1 layer: TPMI=3
4	2 layers: TPMI=0	4	2 layers: TPMI=0	4	2 layers: TPMI=0
...
9	2 layers: TPMI=5	9	2 layers: TPMI=5	9	2 layers: TPMI=5
10	3 layers: TPMI=0	10	3 layers: TPMI=0	10	3 layers: TPMI=0
11	4 layers: TPMI=0	11	4 layers: TPMI=0	11	4 layers: TPMI=0
12	1 layer: TPMI=4	12	1 layer: TPMI=4	12-15	reserved
...		
19	1 layer: TPMI=11	19	1 layer: TPMI=11		
20	2 layers: TPMI=6	20	2 layers: TPMI=6		
...		
27	2 layers: TPMI=13	27	2 layers: TPMI=13		
28	3 layers: TPMI=1	28	3 layers: TPMI=1		
29	3 layers: TPMI=2	29	3 layers: TPMI=2		
30	4 layers: TPMI=1	30	4 layers: TPMI=1		
31	4 layers: TPMI=2	31	4 layers: TPMI=2		
32	1 layers: TPMI=12				
...	...				
47	1 layers: TPMI=27				
48	2 layers: TPMI=14				
...	...				
55	2 layers: TPMI=21				
56	3 layers: TPMI=3				
...	...				
59	3 layers: TPMI=6				
60	4 layers: TPMI=3				
61	4 layers: TPMI=4				
62-63	reserved				

Table 7.3.1.1.2-3: Precoding information and number of layers for 4 antenna ports, if *transformPrecoder= enabled*, or if *transformPrecoder=disabled* and *maxRank = 1*

Bit field mapped to index	<i>codebookSubset = fullyAndPartialAndNonCoherent</i>	Bit field mapped to index	<i>codebookSubset= partialAndNonCoherent</i>	Bit field mapped to index	<i>codebookSubset= nonCoherent</i>
0	1 layer: TPMI=0	0	1 layer: TPMI=0	0	1 layer: TPMI=0
1	1 layer: TPMI=1	1	1 layer: TPMI=1	1	1 layer: TPMI=1
...
3	1 layer: TPMI=3	3	1 layer: TPMI=3	3	1 layer: TPMI=3
4	1 layer: TPMI=4	4	1 layer: TPMI=4		
...		
11	1 layer: TPMI=11	11	1 layer: TPMI=11		
12	1 layers: TPMI=12	12-15	reserved		
...	...				
27	1 layers: TPMI=27				
28-31	reserved				

Table 7.3.1.1.2-4: Precoding information and number of layers, for 2 antenna ports, if *transformPrecoder=disabled* and *maxRank = 2*

Bit field mapped to index	<i>codebookSubset = fullyAndPartialAndNonCoherent</i>	Bit field mapped to index	<i>codebookSubset = nonCoherent</i>
0	1 layer: TPMI=0	0	1 layer: TPMI=0
1	1 layer: TPMI=1	1	1 layer: TPMI=1
2	2 layers: TPMI=0	2	2 layers: TPMI=0
3	1 layer: TPMI=2	3	reserved
4	1 layer: TPMI=3		
5	1 layer: TPMI=4		
6	1 layer: TPMI=5		
7	2 layers: TPMI=1		
8	2 layers: TPMI=2		
9-15	reserved		

Table 7.3.1.1.2-5: Precoding information and number of layers, for 2 antenna ports, if *transformPrecoder= enabled*, or if *transformPrecoder= disabled* and *maxRank = 1*

Bit field mapped to index	<i>codebookSubset = fullyAndPartialAndNonCoherent</i>	Bit field mapped to index	<i>codebookSubset = nonCoherent</i>
0	1 layer: TPMI=0	0	1 layer: TPMI=0
1	1 layer: TPMI=1	1	1 layer: TPMI=1
2	1 layer: TPMI=2		
3	1 layer: TPMI=3		
4	1 layer: TPMI=4		
5	1 layer: TPMI=5		
6-7	reserved		

...

Table 7.3.1.1.2-33: VRB-to-PRB mapping

Bit field mapped to index	VRB-to-PRB mapping
0	Non-interleaved
1	Interleaved

[TS 38.214, clause 6.1.2.1]

When the UE is scheduled to transmit a transport block and no CSI report, or the UE is scheduled to transmit a transport block and a CSI report on PUSCH by a DCI, the *Time domain resource assignment* field value m_d of the DCI provides a row index $m + 1$ to an allocated table. The determination of the used resource allocation table is defined in sub-clause 6.1.2.1.1. The indexed row defines the slot offset K_2 , the start and length indicator $SLIV$, or directly the start symbol S and the allocation length L , and the PUSCH mapping type to be applied in the PUSCH transmission.

When the UE is scheduled to transmit a PUSCH with no transport block and with a CSI report by a *CSI request* field on a DCI, the *Time-domain resource assignment* field value m of the DCI provides a row index $m + 1$ to an allocated table. The determination of the applied resource allocation table is defined in sub-clause 6.1.2.1.1. The indexed row defines the start and length indicator $SLIV$, or directly the start symbol S and the allocation length L , and the PUSCH mapping type to be applied in the PUSCH transmission and K_2 is determined based on the corresponding list entries $Y_j, j = 0, \dots, N_{Rep} - 1$ of the higher layer parameter *reportSlotConfig* in *CSI-ReportConfig* for the N_{Rep} triggered CSI Reporting Settings. The i th codepoint of K_2 is determined as $K_2 = \max_j Y_j(i)$ where $Y_j(i)$ is the i th codepoint of Y_j .

- The slot where the UE shall transmit the PUSCH is determined by K_2 as $\left\lceil n \cdot \frac{2^{\mu_{PUSCH}}}{2^{\mu_{PDCCH}}} \right\rceil + K_2$ where n is the slot with the scheduling DCI, K_2 is based on the numerology of PUSCH, and μ_{PUSCH} and μ_{PDCCH} are the subcarrier spacing configurations for PUSCH and PDCCH, respectively, and

- The starting symbol S relative to the start of the slot, and the number of consecutive symbols L counting from the symbol S allocated for the PUSCH are determined from the start and length indicator $SLIV$ of the indexed row:

if $(L-1) \leq 7$ then

$$SLIV = 14 \cdot (L-1) + S$$

else

$$SLIV = 14 \cdot (14 - L + 1) + (14 - 1 - S)$$

where $0 < L \leq 14 - S$, and

- The PUSCH mapping type is set to Type A or Type B as defined in Subclause 6.4.1.1.3 of [4, TS 38.211] as given by the indexed row.

The UE shall consider the S and L combinations defined in table 6.1.2.1-1 as valid PUSCH allocations

Table 6.1.2.1-1: Valid S and L combinations

PUSCH mapping type	Normal cyclic prefix			Extended cyclic prefix		
	S	L	$S+L$	S	L	$S+L$
Type A	0	{4,...,14}	{4,...,14}	0	{4,...,12}	{4,...,12}
Type B	{0,...,13}	{1,...,14}	{1,...,14}	{0,...,12}	{1,...,12}	{1,...,12}

When the UE is configured with $aggregationFactorUL > 1$, the same symbol allocation is applied across the $aggregationFactorUL$ consecutive slots and the PUSCH is limited to a single transmission layer. The UE shall repeat the TB across the $aggregationFactorUL$ consecutive slots applying the same symbol allocation in each slot. The redundancy version to be applied on the n^{th} transmission occasion of the TB is determined according to table 6.1.2.1-2.

Table 6.1.2.1-2: Redundancy version when $aggregationFactorUL > 1$

rv_{id} indicated by the DCI scheduling the PUSCH	rv_{id} to be applied to n^{th} transmission occasion			
	$n \bmod 4 = 0$	$n \bmod 4 = 1$	$n \bmod 4 = 2$	$n \bmod 4 = 3$
0	0	2	3	1
2	2	3	1	0
3	3	1	0	2
1	1	0	2	3

If the UE procedure for determining slot configuration, as defined in subclause 11.1 of [6, TS 38.213], determines symbols of a slot allocated for PUSCH as downlink symbols, the transmission on that slot is omitted for multi-slot PUSCH transmission.

[38.214 clause 6.1.2.2]

The UE shall determine the resource block assignment in frequency domain using the resource allocation field in the detected PDCCH DCI. Two uplink resource allocation schemes type 0 and type 1 are supported. Uplink resource allocation scheme type 0 is supported for PUSCH only when transform precoding is disabled. Uplink resource allocation scheme type 1 is supported for PUSCH for both cases when transform precoding is enabled or disabled.

If the scheduling DCI is configured to indicate the uplink resource allocation type as part of the *Frequency domain resource* assignment field by setting a higher layer parameter *resourceAllocation* in *pusch-Config* to 'dynamicswitch', the UE shall use uplink resource allocation type 0 or type 1 as defined by this DCI field. Otherwise the UE shall use the uplink frequency resource allocation type as defined by the higher layer parameter *resourceAllocation*.

The UE shall assume that when the scheduling PDCCH is received with DCI format 0_0, then uplink resource allocation type 1 is used.

If a bandwidth part indicator field is not configured in the scheduling DCI, the RB indexing for uplink type 0 and type 1 resource allocation is determined within the UE's active bandwidth part. If a bandwidth part indicator field is configured in the scheduling DCI, the RB indexing for uplink type 0 and type 1 resource allocation is determined within the UE's bandwidth part indicated by bandwidth part indicator field value in the DCI, except for the case when DCI format 0_0 is decoded in any PDCCH common search space in CORESET 0 in which case the initial bandwidth part shall be used. The UE shall upon detection of PDCCH intended for the UE determine first the uplink bandwidth part and then the resource allocation within the bandwidth part.

[38.214 clause 6.1.2.2.1]

In uplink resource allocation of type 0, the resource block assignment information includes a bitmap indicating the Resource Block Groups (RBGs) that are allocated to the scheduled UE where a RBG is a set of consecutive virtual resource blocks defined by higher layer parameter *rbg-Size* configured for PUSCH and the size of the carrier bandwidth part as defined in Table 6.1.2.2.1-1.

Table 6.1.2.2.1-1: Nominal RBG size P

Carrier Bandwidth Part Size	Configuration 1	Configuration 2
1 – 36	2	4
37 – 72	4	8
73 – 144	8	16
145 – 275	16	16

The total number of RBGs (N_{RBG}) for a uplink carrier bandwidth part i of size $N_{\text{BWP},i}^{\text{size}}$ PRBs is given by

$$N_{\text{RBG}} = \left(N_{\text{BWP},i}^{\text{size}} + \left(N_{\text{BWP},i}^{\text{start}} \bmod P \right) \right) / P \quad \text{where}$$

- the size of the first RBG is $\text{RBG}_0^{\text{size}} = P - N_{\text{BWP},i}^{\text{start}} \bmod P$,
- the size of the last RBG is $\text{RBG}_{\text{last}}^{\text{size}} = \left(N_{\text{BWP},i}^{\text{start}} + N_{\text{BWP},i}^{\text{size}} \right) \bmod P$ if $\left(N_{\text{BWP},i}^{\text{start}} + N_{\text{BWP},i}^{\text{size}} \right) \bmod P > 0$ and P otherwise.
- the size of all other RBG is P .

The bitmap is of size N_{RBG} bits with one bitmap bit per RBG such that each RBG is addressable. The RBGs shall be indexed in the order of increasing frequency of the carrier bandwidth part and starting at the lowest frequency. The order of RBG bitmap is such that RBG 0 to RBG $N_{\text{RBG}} - 1$ are mapped from MSB to LSB of the bitmap. The RBG is allocated to the UE if the corresponding bit value in the bitmap is 1, the RBG is not allocated to the UE otherwise.

[38.214 clause 6.1.2.2.2]

In uplink resource allocation of type 1, the resource block assignment information indicates to a scheduled UE a set of contiguously allocated non-interleaved virtual resource blocks within the active carrier bandwidth part of size $N_{\text{BWP}}^{\text{size}}$

PRBs except for the case when DCI format 0_0 is decoded in the Type0-PDCCH common search space in CORESET 0 in which case the initial bandwidth part of size N_{BWP}^{size} shall be used.

An uplink type 1 resource allocation field consists of a resource indication value (RIV) corresponding to a starting virtual resource block (RB_{start}) and a length in terms of contiguously allocated resource blocks L_{RBs} . The resource indication value is defined by

if $(L_{RBs} - 1) \leq \lfloor N_{BWP}^{size} / 2 \rfloor$ then

$$RIV = N_{BWP}^{size} (L_{RBs} - 1) + RB_{start}$$

else

$$RIV = N_{BWP}^{size} (N_{BWP}^{size} - L_{RBs} + 1) + (N_{BWP}^{size} - 1 - RB_{start})$$

where $L_{RBs} \geq 1$ and shall not exceed $N_{BWP}^{size} - RB_{start}$.

[TS 38.214, clause 6.1.4.1]

For the PUSCH assigned by a DCI format 0_0/0_1 with CRC scrambled by C-RNTI, new-RNTI, TC-RNTI, or SP-CSI-RNTI, the transform precoding is enabled if *transformPrecoder* in *PUSCH-Config* is set to 'enabled', or if *transformPrecoder* in *PUSCH-Config* is not configured and *msg3-transformPrecoding* in *rach-ConfigCommon* is set to 'enabled'; otherwise the transform precoding is disabled.

For the PUSCH assigned by a DCI format 0_0/0_1 with CRC scrambled by CS-RNTI, or the PUSCH with configured grant using CS-RNTI, the transform precoding is enabled if *transformPrecoder* in *ConfiguredGrantConfig* is set to 'enabled'; otherwise the transform precoding is disabled.

For a PUSCH scheduled by RAR UL grant or for a PUSCH scheduled by a DCI format 0_0/0_1 with CRC scrambled by C-RNTI, TC-RNTI, or CS-RNTI, or SP-CSI-RNTI, or for a PUSCH with configured grant using CS-RNTI,

if *transformPrecoder* is disabled for this PUSCH transmission

- if *mcs-Table* in *PUSCH-Config* is set to 'qam256', and PUSCH is scheduled with C-RNTI or SP-CSI-RNTI, and PUSCH is assigned by DCI format 0_1,
 - the UE shall use I_{MCS} and Table 5.1.3.1-2 to determine the modulation order (Q_m) and Target code rate (R) used in the physical uplink shared channel.
- elseif the UE is not configured with new-RNTI, *mcs-Table* in *PUSCH-Config* is set to 'qam64LowSE', the PUSCH is scheduled with C-RNTI, or SP-CSI-RNTI, and the PUSCH is assigned by a PDCCH in a UE-specific search space,
 - the UE shall use I_{MCS} and Table 5.1.3.1-3 to determine the modulation order (Q_m) and Target code rate (R) used in the physical uplink shared channel.
- elseif the UE is configured with new-RNTI, and the PUSCH is scheduled with new-RNTI,
 - the UE shall use I_{MCS} and Table 5.1.3.1-3 to determine the modulation order (Q_m) and Target code rate (R) used in the physical uplink shared channel.
- elseif *mcs-Table* in *ConfiguredGrantConfig* is set to 'qam256', and PUSCH is scheduled with CS-RNTI,
 - the UE shall use I_{MCS} and Table 5.1.3.1-2 to determine the modulation order (Q_m) and Target code rate (R) used in the physical uplink shared channel.
- elseif *mcs-Table* in *ConfiguredGrantConfig* is set to 'qam64LowSE', and PUSCH is scheduled with CS-RNTI,
 - the UE shall use I_{MCS} and Table 5.1.3.1-3 to determine the modulation order (Q_m) and Target code rate (R) used in the physical uplink shared channel.
- else

- the UE shall use I_{MCS} and Table 5.1.3.1-1 to determine the modulation order (Q_m) and Target code rate (R) used in the physical uplink shared channel.

[TS 38.214, clause 5.1.3.1]

Table 5.1.3.1-2: MCS index table 2 for PDSCH

MCS Index I_{MCS}	Modulation Order Q_m	Target code Rate $R \times [1024]$	Spectral efficiency
0	2	120	0.2344
1	2	193	0.3770
2	2	308	0.6016
3	2	449	0.8770
4	2	602	1.1758
5	4	378	1.4766
6	4	434	1.6953
7	4	490	1.9141
8	4	553	2.1602
9	4	616	2.4063
10	4	658	2.5703
11	6	466	2.7305
12	6	517	3.0293
13	6	567	3.3223
14	6	616	3.6094
15	6	666	3.9023
16	6	719	4.2129
17	6	772	4.5234
18	6	822	4.8164
19	6	873	5.1152
20	8	682.5	5.3320
21	8	711	5.5547
22	8	754	5.8906
23	8	797	6.2266
24	8	841	6.5703
25	8	885	6.9141
26	8	916.5	7.1602
27	8	948	7.4063
28	2	reserved	
29	4	reserved	
30	6	reserved	
31	8	reserved	

[TS 38.214, clause 6.1.4.2]

For a PUSCH scheduled by RAR UL grant or for a PUSCH scheduled by a DCI format 0_0/0_1 with CRC scrambled by C-RNTI, new-RNTI, TC-RNTI, CS-RNTI, or SP-CSI-RNTI.

if

- $0 \leq I_{MCS} \leq 27$ and transform precoding is disabled and Table 5.1.3.1-2 is used, or
- $0 \leq I_{MCS} \leq 28$ and transform precoding is disabled and a table other than Table 5.1.3.1-2 is used, or
- $0 \leq I_{MCS} \leq 27$ and transform precoding is enabled, the UE shall first determine the TBS as specified below:

The UE shall first determine the number of REs (N_{RE}) within the slot:

- A UE first determines the number of REs allocated for PUSCH within a PRB (N'_{RE}) by
- $N'_{RE} = N_{sc}^{RB} * N_{ymb}^{sh} - N_{DMRS}^{PRB} - N_{oh}^{PRB}$, where $N_{sc}^{RB} = 12$ is the number of subcarriers in the frequency domain in a physical resource block, N_{ymb}^{sh} is the number of symbols of the PUSCH allocation within the

slot, N_{DMRS}^{PRB} is the number of REs for DM-RS per PRB in the scheduled duration including the overhead of the DM-RS CDM groups without data, as indicated by DCI format 0_1 or as described for DCI format 0_0 in Subclause 6.2.2, and N_{oh}^{PRB} is the overhead configured by higher layer parameter $xOverhead$ in *PUSCH-ServingCellConfig*. If the N_{oh}^{PRB} is not configured (a value from 0, 6, 12, or 18), the N_{oh}^{PRB} is assumed to be 0. For MSG3 transmission the N_{oh}^{PRB} is always set to 0..

- A UE determines the total number of REs allocated for PUSCH (N_{RE}) by

$$N_{RE} = \min(156, N_{RE}') \cdot n_{PRB}$$
 where n_{PRB} is the total number of allocated PRBs for the UE.
- Next, proceed with steps 2-4 as defined in Subclause 5.1.3.2

else if

- $28 \leq I_{MCS} \leq 31$ and transform precoding is disabled and Table 5.1.3.1-2 is used, or
- $28 \leq I_{MCS} \leq 31$ and transform precoding is enabled,
- the TBS is assumed to be as determined from the DCI transported in the latest PDCCH for the same transport block using $0 \leq I_{MCS} \leq 27$. If there is no PDCCH for the same transport block using $0 \leq I_{MCS} \leq 27$, and if the initial PUSCH for the same transport block is transmitted with configured grant, the TBS shall be determined from the most recent configured scheduling PDCCH.

else

- the TBS is assumed to be as determined from the DCI transported in the latest PDCCH for the same transport block using $0 \leq I_{MCS} \leq 28$. If there is no PDCCH for the same transport block using $0 \leq I_{MCS} \leq 28$, and if the initial PUSCH for the same transport block is transmitted with configured grant, the TBS shall be determined from the most recent configured scheduling PDCCH.

[TS 38.214, clause 5.1.3.2]

- 2) Intermediate number of information bits (N_{info}) is obtained by $N_{info} = N_{RE} \cdot R \cdot Q_m \cdot \nu$.

If $N_{info} \leq 3824$

Use step 3 as the next step of the TBS determination

else

Use step 4 as the next step of the TBS determination

end if

- 3) When $N_{info} \leq 3824$, TBS is determined as follows

- quantized intermediate number of information bits $N_{info}' = \max\left(24, 2^n \cdot \left\lfloor \frac{N_{info}}{2^n} \right\rfloor\right)$, where

$$n = \max(3, \log_2(N_{info})) - 6$$
- use Table 5.1.3.2-2 find the closest TBS that is not less than N_{info}' .

Table 5.1.3.2-2: TBS for $N_{info} \leq 3824$

Index	TBS	Index	TBS	Index	TBS	Index	TBS
1	24	31	336	61	1288	91	3624
2	32	32	352	62	1320	92	3752
3	40	33	368	63	1352	93	3824
4	48	34	384	64	1416		
5	56	35	408	65	1480		
6	64	36	432	66	1544		
7	72	37	456	67	1608		
8	80	38	480	68	1672		
9	88	39	504	69	1736		
10	96	40	528	70	1800		
11	104	41	552	71	1864		
12	112	42	576	72	1928		
13	120	43	608	73	2024		
14	128	44	640	74	2088		
15	136	45	672	75	2152		
16	144	46	704	76	2216		
17	152	47	736	77	2280		
18	160	48	768	78	2408		
19	168	49	808	79	2472		
20	176	50	848	80	2536		
21	184	51	888	81	2600		
22	192	52	928	82	2664		
23	208	53	984	83	2728		
24	224	54	1032	84	2792		
25	240	55	1064	85	2856		
26	256	56	1128	86	2976		
27	272	57	1160	87	3104		
28	288	58	1192	88	3240		
29	304	59	1224	89	3368		
30	320	60	1256	90	3496		

4) When $N_{info} > 3824$, TBS is determined as follows.

- quantized intermediate number of information bits $N'_{info} = \max\left(3840, 2^n \times \text{round}\left(\frac{N_{info} - 24}{2^n}\right)\right)$, where $n = \lfloor \log_2(N_{info} - 24) \rfloor - 5$ and ties in the round function are broken towards the next largest integer.
- if $R \leq 1/4$

$$TBS = 8 \cdot C \cdot \left\lceil \frac{N'_{info} + 24}{8 \cdot C} \right\rceil - 24, \text{ where } C = \left\lceil \frac{N'_{info} + 24}{3816} \right\rceil$$

else

if $N'_{info} > 8424$

$$TBS = 8 \cdot C \cdot \left\lceil \frac{N'_{info} + 24}{8 \cdot C} \right\rceil - 24, \text{ where } C = \left\lceil \frac{N'_{info} + 24}{8424} \right\rceil$$

else

$$TBS = 8 \cdot \left\lceil \frac{N'_{info} + 24}{8} \right\rceil - 24$$

end if

end if

7.1.1.4.2.4.3 Test description

7.1.1.4.2.4.3.1 Pre-test conditions

Same Pre-test conditions as in clause 7.1.1.0 except set the NR Cell bandwidth and applicable BWP to maximum for the NR Band under test as specified in Table 5.3.5-1 in TS 38.101-1 [16] / TS 38.101-2 [17] (to enable testing of n_{PRB} up to maximum value).

Test frequency NRf1 is as specified in TS 38.508-1 [4] clause 4.3.1 using the common highest UL and DL channel bandwidth and using the default subcarrier spacing specified in TS 38.508-1 [4] clause 6.2.3.1.

7.1.1.4.2.4.3.2 Test procedure sequence

Table 7.1.1.4.2.4.3.2-1: Maximum TBS for different UE categories

UE Category	Maximum number of bits of a UL-SCH transport block received within a TTI
TS 38.306 [23] clause 4.1.2 require UE without <i>ue-CategoryDL</i> and <i>ue-CategoryUL</i> , to support Max TBS achievable based on max bandwidth of the Band under test.	

Table 7.1.1.4.2.4.3.2-2: Number of downlink PDCP SDUs and PDCP SDU size used as test data

TBS [bits]	Number of PDCP SDUs	PDCP SDU size [bits] (Note 1)
$136 \leq TBS \leq 12128$ note 2	1	$8 * \text{FLOOR}((TBS - 128)/8)$
$12129 \leq TBS \leq 24200$	2	$8 * \text{FLOOR}((TBS - 200)/16)$
$24201 \leq TBS \leq 36272$	3	$8 * \text{FLOOR}((TBS - 272)/24)$
$36273 \leq TBS \leq 48344$	4	$8 * \text{FLOOR}((TBS - 344)/32)$
$48345 \leq TBS \leq 60416$	5	$8 * \text{FLOOR}((TBS - 416)/40)$
$60417 \leq TBS \leq 72488$	6	$8 * \text{FLOOR}((TBS - 488)/48)$
$72489 \leq TBS \leq 84560$	7	$8 * \text{FLOOR}((TBS - 560)/56)$
$84561 \leq TBS \leq 96632$	8	$8 * \text{FLOOR}((TBS - 632)/64)$
$96633 < TBS \leq 108704$	9	$8 * \text{FLOOR}((TBS - 704)/72)$
$10705 \leq TBS \leq 120776$	10	$8 * \text{FLOOR}((TBS - 776)/80)$
$120777 \leq TBS \leq 132848$	11	$8 * \text{FLOOR}((TBS - 848)/88)$
$132849 \leq TBS \leq 144920$	12	$8 * \text{FLOOR}((TBS - 920)/96)$
$TBS > 144920$	13	$8 * \text{FLOOR}((TBS - 992)/104)$

Note 1: Each PDCP SDU is limited to 1500 octets (to keep below maximum SDU size of ESM as specified in TS 24.301 [21] clause 9.9.4.12).

The PDCP SDU size of each PDCP SDU is

$$\text{PDCP SDU size} = (TBS - N * \text{PDCP header size} - N * \text{AMD PDU header size} - N * \text{MAC header size} - \text{Size of Timing Advance} - \text{RLC Status PDU size} - \text{MAC header for RLC Status PDU}) / N, \text{ where}$$

PDCP header size is 24 bits for the RLC AM and 18-bit SN case;
AMD PDU header size is 24 bits with 18 bit SN;

MAC header size for AMD PDU = 16 or 24 bits depending on L=8 or 16 bits. Worst case 24 is taken.

Size of Timing Advance MAC CE with header is 16 bits (if no Timing Advance and/or RLC status needs to be sent, padding will occur instead).

RLC Status PDU size = 24 bits with 1 ACK_SN, With a MAC header of 16 bits.

This gives:

$$\text{PDCP SDU size} = 8 * \text{FLOOR}((TBS - N * 24 - N * 24 - N * 24 - 56) / (8 * N)) \text{ bits.}$$

Note 2: According to the final PDCP SDU size formula in Note 1, the smallest TBS that can be tested is 136 bits.

Table 7.1.1.4.2.4.3.2-2A: Bandwidth part Dependent Parameters for Resource allocation 0 with start of BWP assumed as 0

$N_{RB}^{DL,BWP} = N_{BWP,i}^{size}$	Nominal RBG size P (Configuration1)	Size of last RBG	Allowed N_{PRB} Values
11	2	1	All 1...11
18	2	2	2,4,6,8,10,12,16,18
24	2	2	2,4,6,8,10,12,16,18,20,22,24
25	2	1	All 1...25
31	2	1	All 1...31
32	2	2	2,4,6,8,10,12,16,18,20,22,24,26,28,30,32
38	4	2	2,4,6,8,10,12,16,18,20,22,24,26,28,30,32,34,36,38
51	4	3	3,4,7,8,11,12,15,16,19,20,23,24,27,28,31,32,35,36,39,40,43,44,47,48,51
52	4	4	4,8,12,16,20,24,28,32,36,40,44,48,52
65	4	1	1,4,5,8,9,12,13,16,17,20,21,24,25,28,29,32,33,36,37,40,41,44,45,48,49,52,53,56,57,60,61,64,65
66	4	2	2,4,6,8,10,12,16,18,20,22,24,26,28,30,32,34,36,38,40,42,44,46,48,50,52,54,56,58,60,62,64,66
79	8	7	7,8,15,16,23,24,31,32,39,40,47,48,55,56,63,64,71,72,79
106	8	2	2,8,10,16,18,24,26,32,34,40,42,48,50,56,58,64,66,72,74,80,82,88,90,96,92,104,106
107	8	3	3,8,11,16,19,24,27,32,35,40,43,48,51,56,59,64,67,72,75,80,83,88,91,96,99,104,107
132	8	4	4,8,12,16,20,24,28,32,36,40,44,48,52,56,60,64,68,72,76,80,84,88,92,96,100,104,108,112,116,120,124,128,132
133	8	5	5,8,13,16,21,24,29,32,37,40,45,48,53,56,61,64,69,72,77,80,85,88,93,96,101,104,109,112,117,120,125,128,133
135	8	7	7,8,15,16,23,24,31,32,39,40,47,48,55,56,63,64,71,72,79,80,87,88,95,96,103,104,111,112,119,120,127,128,135
160	16	16	16,32,48,64,80,96,112,128,144,160
216	16	8	8,16,24,32,40,48,56,64,72,80,88,96,104,112,120,128,136,144,152,160,168,176,184,192,200,208,216
217	16	9	9,16,25,32,41,48,57,64,73,80,89,96,105,112,121,128,137,144,153,160,169,176,185,192,201,208,217
264	16	8	8,16,24,32,40,48,56,64,72,80,88,96,104,112,120,128,136,144,160,168,176,184,192,200,208,216,224,232,240,248,256,264
270	16	14	14,16,30,32,46,44,62,64,78,80,94,96,110,112,126,128,142,144,158,160,174,176,190,192,206,208,222,224,238,240,254,256,270
273	16	1	1,16,17,32,33,48,49,64,65,80,81,96,97,112,113,128,129,144,145,160,161,176,171,192,193,208,209,224,225,240,241,256,257,272,273

Table 7.1.1.4.2.4.3.2-3: Specific Parameter

Parameter	Value	Comment	Condition
number of layers (v)	1		
mcs-Table	qam256		
resourceAllocation	dynamicSwitch		pc_dynamicSwitchRA_Type0_1_PUSCH
	resourceAllocationType1		NOT pc_dynamicSwitchRA_Type0_1_PUSCH AND Steps 1-5
	resourceAllocationType0		NOT pc_dynamicSwitchRA_Type0_1_PUSCH AND pc_ra_Type0_PUSCH AND Steps 6-10
rbg-Size	Not present	configuration 1 applicable	
N_{BWP}^{start}	0		

Table 7.1.1.4.2.4.3.2-4: Main behaviour

St	Procedure	Message Sequence		TP	Verdict
		U - S	Message		
-	EXCEPTION: Steps 1 to 5 are repeated for allowed values of N_{PRB} 1 to $N_{RB}^{DL,BWP}$ in BWP, time domain resource as per Table 7.1.1.4.2.0-1 and I_{MCS} from 0 to 27.	-	-	-	-
1	SS calculates or looks up TBS in TS 38.214 [15] based on the value of S, L, I_{MCS} and n_{PRB} .	-	-	-	-
-	EXCEPTION: Steps 2 to 5 are performed if TBS is less than or equal to UE capability "Maximum number of UL-SCH transport block bits received within a TTI" as specified in Table 7.1.1.4.2.4.3.2-1 and larger than or equal to 136 bits as specified in Table 7.1.1.4.2.4.3.2-2. Skip the execution of steps 2 to 5 for which the TBS size equal to 3824 or 3840. (Note 3)	-	-	-	-
2	SS creates one or more PDCP SDUs depending on TBS in accordance with Table 7.1.1.4.2.4.3.2-2.	-	-	-	-
3	After 300ms, the SS transmits all PDCP SDUs (N_{SDUs}) as created in step 2 in a MAC PDU.	<-	MAC PDU ($N \times$ PDCP SDUs)	-	-
4	After 60ms of step 3 SS transmits UL Grant DCI 0_1, and values of S, L, I_{MCS} and n_{PRB} .	<-	(UL Grant) (DCI: (DCI Format 0_1, S, L, I_{MCS} and n_{PRB}))	-	-
5	CHECK: Does UE return the same number of PDCP SDUs with same content as transmitted by the SS in step 3 using Time, frequency Resources and modulation and coding scheme as configured by the SS in step 4?	-->	($N \times$ PDCP SDUs)	2	P
-	EXCEPTION : Steps 5Aa1 to 10 are executed if $pc_ra_Type0_PUSCH$	-	-	-	-
-	EXCEPTION : Steps 5Aa1 to 5Aa2 are executed if NOT $pc_dynamicSwitchRA_Type0_1_PUSCH$	-	-	-	-
5A a1	The SS transmits a NR RRCReconfiguration message including <i>PUSCH-Config</i> with IE <i>resourceAllocation</i> set to <i>resourceAllocationType1</i> (Note 1)	<-	<i>RRCReconfiguration</i>	-	-
5A a2	The UE transmit a NR <i>RRCReconfigurationComplete</i> message. (Note 2)	-->	<i>RRCReconfigurationComplete</i>	-	-
-	EXCEPTION: Steps 6 to 10 are repeated for allowed values of N_{PRB} as per Table 7.1.1.4.2.4.3.2-2A in BWP, time domain resource length L 3 to 14-S and I_{MCS} from 0 to 27.	-	-	-	-
6	SS calculates or looks up TBS in TS 38.214 [15] based on the value of S, L, I_{MCS} and n_{PRB} .	-	-	-	-

-	EXCEPTION: Steps 7 to 10 are performed if TBS is less than or equal to UE capability "Maximum number of UL-SCH transport block bits received within a TTI" as specified in Table 7.1.1.4.2.4.3.2-1 and larger than or equal to 136 bits as specified in Table 7.1.1.4.2.4.3.2-2. Skip the execution of steps 7 to 10 for which the TBS size equal to 3824 or 3840. (Note 3)	-	-	-	-
7	SS creates one or more PDCP SDUs depending on TBS in accordance with Table 7.1.1.4.2.4.3.2-2.	-	-	-	-
8	After 300ms, the SS transmits all PDCP SDUs (N_{SDUs}) as created in step 7 in a MAC PDU.	<--	MAC PDU (N_{xPDCP} SDUs)	-	-
9	After 60ms of step 8 SS transmits UL Grant DCI 0_1, and values of S, L, I_{MCS} and n_{PRB} .	<--	(UL Grant) (DCI: (DCI Format 0_1, S, L, I_{MCS} and n_{PRB}))	-	-
10	CHECK: Does UE return the same number of PDCP SDUs with same content as transmitted by the SS in step 8 using Time, frequency Resources and modulation and coding scheme as configured by the SS in step 4?	-->	(N_{xPDCP} SDUs)	1	P
<p>Note 1: For EN-DC the NR RRCReconfiguration message is contained in RRCConnectionReconfiguration 36.508 [7], Table 4.6.1-8 using condition EN-DC_EmbedNR_RRCRecon.</p> <p>Note 2: For EN-DC the NR RRCReconfigurationComplete message is contained in RRCConnectionReconfigurationComplete.</p> <p>Note 3: There is ambiguity of TBS calculation when $3824.0 < N_{info} < 3825.0$ in clause 5.1.3.2 of TS 38.214 [15].</p>					

7.1.1.4.2.4.3.3 Specific message contents

[None].

7.1.1.4.2.5 UL-SCH Transport Block Size selection / DCI format 0_0 / Transform precoding and 64QAM

7.1.1.4.2.5.1 Test Purpose (TP)

(1)

```
with { UE in RRC_CONNECTED state and transform precoding enabled}
ensure that {
  when { UE has pending data for transmission and receives on PDCCH DCI format 0_0 indicating a
resource block assignment correspondent to physical resource blocks , Time domain resource
assignment and modulation and coding }
  then { UE transmits MAC PDU on PUSCH as per Modulation Coding scheme, time domain resource
allocation and PRB's }
}
```

7.1.1.4.2.5.2 Conformance requirements

References: The conformance requirements covered in the present TC are specified in: TS 38.212 clause 7.3.1.1.1, TS 38.214 clause 6.1.2.1, 6.1.2.2, 6.1.2.2.2, 6.1.4.1, 5.1.3.1, 6.1.4.2 and 5.1.3.2. Unless otherwise stated these are Rel-15 requirements.

[TS 38.212, clause 7.3.1.1.1]

DCI format 0_0 is used for the scheduling of PUSCH in one cell.

The following information is transmitted by means of the DCI format 0_0 with CRC scrambled by C-RNTI or CS-RNTI or new-RNTI:

- Identifier for DCI formats – 1 bit
 - The value of this bit field is always set to 0, indicating an UL DCI format
- Frequency domain resource assignment – $\lceil \log_2(N_{RB}^{UL,BWP}(N_{RB}^{UL,BWP} + 1)/2) \rceil$ bits where
 - $N_{RB}^{UL,BWP}$ is the size of the active UL bandwidth part in case DCI format 0_0 is monitored in the UE specific search space and satisfying
 - the total number of different DCI sizes monitored per slot is no more than 4 for the cell, and
 - the total number of different DCI sizes with C-RNTI monitored per slot is no more than 3 for the cell
 - otherwise, $N_{RB}^{UL,BWP}$ is the size of the initial UL bandwidth part.
- For PUSCH hopping with resource allocation type 1:
 - N_{UL_hop} MSB bits are used to indicate the frequency offset according to Subclause 6.3 of [6, TS 38.214], where $N_{UL_hop} = 1$ if the higher layer parameter *frequencyHoppingOffsetLists* contains two offset values and $N_{UL_hop} = 2$ if the higher layer parameter *frequencyHoppingOffsetLists* contains four offset values
 - $\lceil \log_2(N_{RB}^{UL,BWP}(N_{RB}^{UL,BWP} + 1)/2) \rceil - N_{UL_hop}$ bits provides the frequency domain resource allocation according to Subclause 6.1.2.2.2 of [6, TS 38.214]
- For non-PUSCH hopping with resource allocation type 1:
 - $\lceil \log_2(N_{RB}^{UL,BWP}(N_{RB}^{UL,BWP} + 1)/2) \rceil$ bits provides the frequency domain resource allocation according to Subclause 6.1.2.2.2 of [6, TS 38.214]
- Time domain resource assignment – 4 bits as defined in Subclause 6.1.2.1 of [6, TS 38.214]
- Frequency hopping flag – 1 bit.
- Modulation and coding scheme – 5 bits as defined in Subclause 6.1.3 of [6, TS 38.214]
- New data indicator – 1 bit
- Redundancy version – 2 bits as defined in Table 7.3.1.1.1-2
- HARQ process number – 4 bits
- TPC command for scheduled PUSCH – 2 bits as defined in Subclause 7.1.1 of [5, TS 38.213]
- Padding bits, if required.
- UL/SUL indicator – 1 bit for UEs configured with SUL in the cell as defined in Table 7.3.1.1.1-1 and the number of bits for DCI format 1_0 before padding is larger than the number of bits for DCI format 0_0 before padding; 0 bit otherwise. The UL/SUL indicator, if present, locates in the last bit position of DCI format 0_0, after the padding bit(s).
 - If the UL/SUL indicator is present in DCI format 0_0 and the higher layer parameter *pusch-Config* is not configured on both UL and SUL the UE ignores the UL/SUL indicator field in DCI format 0_0, and the corresponding PUSCH scheduled by the DCI format 0_0 is for the UL or SUL for which high layer parameter *pucch-Config* is configured;
 - If the UL/SUL indicator is not present in DCI format 0_0, the corresponding PUSCH scheduled by the DCI format 0_0 is for the UL or SUL for which high layer parameter *pucch-Config* is configured.

The following information is transmitted by means of the DCI format 0_0 with CRC scrambled by TC-RNTI:

- Identifier for DCI formats – 1 bit
 - The value of this bit field is always set to 0, indicating an UL DCI format

- Frequency domain resource assignment – $\lceil \log_2(N_{RB}^{UL,BWP}(N_{RB}^{UL,BWP} + 1)/2) \rceil$ bits where
 - $N_{RB}^{UL,BWP}$ is the size of the initial UL bandwidth part.
 - For PUSCH hopping with resource allocation type 1:
 - N_{UL_hop} MSB bits are used to indicate the frequency offset according to Subclause 6.3 of [6, TS 38.214], where $N_{UL_hop} = 1$ if $N_{RB}^{UL,BWP} < 50$ and $N_{UL_hop} = 2$ otherwise
 - $\lceil \log_2(N_{RB}^{UL,BWP}(N_{RB}^{UL,BWP} + 1)/2) \rceil - N_{UL_hop}$ bits provides the frequency domain resource allocation according to Subclause 6.1.2.2.2 of [6, TS 38.214]
 - For non-PUSCH hopping with resource allocation type 1:
 - $\lceil \log_2(N_{RB}^{UL,BWP}(N_{RB}^{UL,BWP} + 1)/2) \rceil$ bits provides the frequency domain resource allocation according to Subclause 6.1.2.2.2 of [6, TS 38.214]
- Time domain resource assignment – 4 bits as defined in Subclause 6.1.2.1 of [6, TS 38.214]
- Frequency hopping flag – 1 bit.
- Modulation and coding scheme – 5 bits as defined in Subclause 6.1.3 of [6, TS 38.214], using Table 5.1.3.1-1
- New data indicator – 1 bit, reserved
- Redundancy version – 2 bits as defined in Table 7.3.1.1.1-2
- HARQ process number – 4 bits, reserved
- TPC command for scheduled PUSCH – 2 bits as defined in Subclause 7.1.1 of [5, TS 38.213]
- Padding bits, if required.
- UL/SUL indicator – 1 bit if the cell has two ULs and the number of bits for DCI format 1_0 before padding is larger than the number of bits for DCI format 0_0 before padding; 0 bit otherwise. The UL/SUL indicator, if present, locates in the last bit position of DCI format 0_0, after the padding bit(s).
 - If 1 bit, reserved, and the corresponding PUSCH is always on the same UL carrier as the previous transmission of the same TB

If DCI format 0_0 is monitored in common search space and if the number of information bits in the DCI format 0_0 prior to padding is less than the payload size of the DCI format 1_0 monitored in common search space for scheduling the same serving cell, zeros shall be appended to the DCI format 0_0 until the payload size equals that of the DCI format 1_0.

If DCI format 0_0 is monitored in common search space and if the number of information bits in the DCI format 0_0 prior to padding is larger than the payload size of the DCI format 1_0 monitored in common search space for scheduling the same serving cell, the bit width of the frequency domain resource allocation field in the DCI format 0_0 is reduced by truncating the first few most significant bits such that the size of DCI format 0_0 equals to the size of the DCI format 1_0.

If DCI format 0_0 is monitored in UE specific search space but does not satisfy at least one of the following

- the total number of different DCI sizes monitored per slot is no more than 4 for the cell, and
- the total number of different DCI sizes with C-RNTI monitored per slot is no more than 3 for the cell

and if the number of information bits in the DCI format 0_0 prior to padding is less than the payload size of the DCI format 1_0 monitored in common search space for scheduling the same serving cell, zeros shall be appended to the DCI format 0_0 until the payload size equals that of the DCI format 1_0.

If DCI format 0_0 is monitored in UE specific search space but does not satisfy at least one of the following

- the total number of different DCI sizes monitored per slot is no more than 4 for the cell, and

- the total number of different DCI sizes with C-RNTI monitored per slot is no more than 3 for the cell

and if the number of information bits in the DCI format 0_0 prior to padding is larger than the payload size of the DCI format 1_0 monitored in common search space for scheduling the same serving cell, the bit width of the frequency domain resource allocation field in the DCI format 0_0 is reduced by truncating the first few most significant bits such that the size of DCI format 0_0 equals to the size of the DCI format 1_0.

If DCI format 0_0 is monitored in UE specific search space and satisfies both of the following

- the total number of different DCI sizes monitored per slot is no more than 4 for the cell, and
- the total number of different DCI sizes with C-RNTI monitored per slot is no more than 3 for the cell

and if the number of information bits in the DCI format 0_0 prior to padding is less than the payload size of the DCI format 1_0 monitored in UE specific search space for scheduling the same serving cell, zeros shall be appended to the DCI format 0_0 until the payload size equals that of the DCI format 1_0.

[TS 38.214, clause 6.1.2.1]

When the UE is scheduled to transmit a transport block and no CSI report, or the UE is scheduled to transmit a transport block and a CSI report on PUSCH by a DCI, the *Time domain resource assignment* field value m of the DCI provides a row index $m + 1$ to an allocated table. The determination of the used resource allocation table is defined in sub-clause 6.1.2.1.1. The indexed row defines the slot offset K_2 , the start and length indicator *SLIV*, or directly the start symbol S and the allocation length L , and the PUSCH mapping type to be applied in the PUSCH transmission.

When the UE is scheduled to transmit a PUSCH with no transport block and with a CSI report by a *CSI request* field on a DCI, the *Time-domain resource assignment* field value m of the DCI provides a row index $m + 1$ to an allocated table. The determination of the applied resource allocation table is defined in sub-clause 6.1.2.1.1. The indexed row defines the start and length indicator *SLIV*, or directly the start symbol S and the allocation length L , and the PUSCH mapping type to be applied in the PUSCH transmission and K_2 is determined based on the corresponding list entries $Y_j, j = 0, \dots, N_{\text{Rep}} - 1$ of the higher layer parameter *reportSlotConfig* in *CSI-ReportConfig* for the N_{Rep} triggered CSI Reporting Settings. The i th codepoint of K_2 is determined as $K_2 = \max_j Y_j(i)$ where $Y_j(i)$ is the i th codepoint of Y_j .

- The slot where the UE shall transmit the PUSCH is determined by K_2 as $\left\lfloor n \cdot \frac{2^{\mu_{\text{PUSCH}}}}{2^{\mu_{\text{PDCCH}}}} \right\rfloor + K_2$ where n is the slot with the scheduling DCI, K_2 is based on the numerology of PUSCH, and μ_{PUSCH} and μ_{PDCCH} are the subcarrier spacing configurations for PUSCH and PDCCH, respectively, and

- The starting symbol S relative to the start of the slot, and the number of consecutive symbols L counting from the symbol S allocated for the PUSCH are determined from the start and length indicator *SLIV* of the indexed row:

if $(L-1) \leq 7$ then

$$SLIV = 14 \cdot (L-1) + S$$

else

$$SLIV = 14 \cdot (14 - L + 1) + (14 - 1 - S)$$

where $0 < L \leq 14 - S$, and

- The PUSCH mapping type is set to Type A or Type B as defined in Subclause 6.4.1.1.3 of [4, TS 38.211] as given by the indexed row.

The UE shall consider the S and L combinations defined in table 6.1.2.1-1 as valid PUSCH allocations

Table 6.1.2.1-1: Valid S and L combinations

PUSCH mapping type	Normal cyclic prefix			Extended cyclic prefix		
	S	L	S+L	S	L	S+L
Type A	0	{4,...,14}	{4,...,14}	0	{4,...,12}	{4,...,12}
Type B	{0,...,13}	{1,...,14}	{1,...,14}	{0,...,12}	{1,...,12}	{1,...,12}

When the UE is configured with $aggregationFactorUL > 1$, the same symbol allocation is applied across the $aggregationFactorUL$ consecutive slots and the PUSCH is limited to a single transmission layer. The UE shall repeat the TB across the $aggregationFactorUL$ consecutive slots applying the same symbol allocation in each slot. The redundancy version to be applied on the n^{th} transmission occasion of the TB is determined according to table 6.1.2.1-2.

Table 6.1.2.1-2: Redundancy version when $aggregationFactorUL > 1$

rv_{id} indicated by the DCI scheduling the PUSCH	rv_{id} to be applied to n^{th} transmission occasion			
	$n \bmod 4 = 0$	$n \bmod 4 = 1$	$n \bmod 4 = 2$	$n \bmod 4 = 3$
0	0	2	3	1
2	2	3	1	0
3	3	1	0	2
1	1	0	2	3

If the UE procedure for determining slot configuration, as defined in subclause 11.1 of [6, TS 38.213], determines symbols of a slot allocated for PUSCH as downlink symbols, the transmission on that slot is omitted for multi-slot PUSCH transmission.

[38.214 clause 6.1.2.2]

The UE shall determine the resource block assignment in frequency domain using the resource allocation field in the detected PDCCH DCI. Two uplink resource allocation schemes type 0 and type 1 are supported. Uplink resource allocation scheme type 0 is supported for PUSCH only when transform precoding is disabled. Uplink resource allocation scheme type 1 is supported for PUSCH for both cases when transform precoding is enabled or disabled.

If the scheduling DCI is configured to indicate the uplink resource allocation type as part of the *Frequency domain resource* assignment field by setting a higher layer parameter *resourceAllocation* in *pusch-Config* to 'dynamicswitch', the UE shall use uplink resource allocation type 0 or type 1 as defined by this DCI field. Otherwise the UE shall use the uplink frequency resource allocation type as defined by the higher layer parameter *resourceAllocation*.

The UE shall assume that when the scheduling PDCCH is received with DCI format 0_0, then uplink resource allocation type 1 is used.

If a bandwidth part indicator field is not configured in the scheduling DCI, the RB indexing for uplink type 0 and type 1 resource allocation is determined within the UE's active bandwidth part. If a bandwidth part indicator field is configured in the scheduling DCI, the RB indexing for uplink type 0 and type 1 resource allocation is determined within the UE's bandwidth part indicated by bandwidth part indicator field value in the DCI, except for the case when DCI format 0_0 is decoded in any PDCCH common search space in CORESET 0 in which case the initial bandwidth part shall be used. The UE shall upon detection of PDCCH intended for the UE determine first the uplink bandwidth part and then the resource allocation within the bandwidth part.

[38.214 clause 6.1.2.2.2]

n uplink resource allocation of type 1, the resource block assignment information indicates to a scheduled UE a set of contiguously allocated non-interleaved virtual resource blocks within the active carrier bandwidth part of size N_{BWP}^{size} PRBs except for the case when DCI format 0_0 is decoded in the Type0-PDCCH common search space in CORESET 0 in which case the initial bandwidth part of size N_{BWP}^{size} shall be used.

An uplink type 1 resource allocation field consists of a resource indication value (*RIV*) corresponding to a starting virtual resource block (RB_{start}) and a length in terms of contiguously allocated resource blocks L_{RBs} . The resource indication value is defined by

if $(L_{RBs} - 1) \leq N_{BWP}^{size} / 2$ then

$$RIV = N_{BWP}^{size} (L_{RBs} - 1) + RB_{start}$$

else

$$RIV = N_{BWP}^{size} (N_{BWP}^{size} - L_{RBs} + 1) + (N_{BWP}^{size} - 1 - RB_{start})$$

where $L_{RBs} \geq 1$ and shall not exceed $N_{BWP}^{size} - RB_{start}$.

[TS 38.214, clause 6.1.4.1]

For the PUSCH assigned by a DCI format 0_0/0_1 with CRC scrambled by C-RNTI, new-RNTI, TC-RNTI, or SP-CSI-RNTI, the transform precoding is enabled if *transformPrecoder* in *PUSCH-Config* is set to 'enabled', or if *transformPrecoder* in *PUSCH-Config* is not configured and *msg3-transformPrecoding* in *rach-ConfigCommon* is set to 'enabled'; otherwise the transform precoding is disabled.

For the PUSCH assigned by a DCI format 0_0/0_1 with CRC scrambled by CS-RNTI, or the PUSCH with configured grant using CS-RNTI, the transform precoding is enabled if *transformPrecoder* in *ConfiguredGrantConfig* is set to 'enabled'; otherwise the transform precoding is disabled.

For a PUSCH scheduled by RAR UL grant or for a PUSCH scheduled by a DCI format 0_0/0_1 with CRC scrambled by C-RNTI, TC-RNTI, or CS-RNTI, or SP-CSI-RNTI, or for a PUSCH with configured grant using CS-RNTI,

if *transformPrecoder* is disabled for this PUSCH transmission

...

else

- if *mcs-TableTransformPrecoder* in *PUSCH-Config* is set to 'qam256', and the PUSCH is scheduled with C-RNTI or SP-CSI-RNTI, and PUSCH is assigned by DCI format 0_1,
 - the UE shall use I_{MCS} and Table 5.1.3.1-2 to determine the modulation order (Q_m) and Target code rate (R) used in the physical uplink shared channel.
- elseif the UE is not configured with new-RNTI, *mcs-TableTransformPrecoder* in *PUSCH-Config* is set to 'qam64LowSE', and the PUSCH is scheduled with C-RNTI, or SP-CSI-RNTI, and the PUSCH is assigned by a PDCCH in a UE-specific search space,
 - the UE shall use I_{MCS} and Table 6.1.4.1-2 to determine the modulation order (Q_m) and Target code rate (R) used in the physical uplink shared channel.
- elseif the UE is configured with new-RNTI, and the PUSCH is scheduled with new-RNTI,
 - the UE shall use I_{MCS} and Table 6.1.4.1-2 to determine the modulation order (Q_m) and Target code rate (R) used in the physical uplink shared channel.
- elseif *mcs-TableTransformPrecoder* in *ConfiguredGrantConfig* is set to 'qam256', and PUSCH is scheduled with CS-RNTI,
 - the UE shall use I_{MCS} and Table 5.1.3.1-2 to determine the modulation order (Q_m) and Target code rate (R) used in the physical uplink shared channel.
- elseif *mcs-TableTransformPrecoder* in *ConfiguredGrantConfig* is set to 'qam64LowSE', and PUSCH is scheduled with CS-RNTI,
 - the UE shall use I_{MCS} and Table 6.1.4.1-2 to determine the modulation order (Q_m) and Target code rate (R) used in the physical uplink shared channel.
- else
 - the UE shall use I_{MCS} and Table 6.1.4.1-1 to determine the modulation order (Q_m) and Target code rate (R) used in the physical uplink shared channel.

end

For Table 6.1.4.1-1 and Table 6.1.4.1-2, if higher layer parameter *PUSCH-tp-pi2BPSK* is configured, $q = 1$ otherwise $q=2$.

Table 6.1.4.1-1: MCS index table for PUSCH with transform precoding and 64QAM

MCS Index I_{MCS}	Modulation Order Q_m	Target code Rate R x 1024	Spectral efficiency
0	q	240/ q	0.2344
1	q	314/ q	0.3066
2	2	193	0.3770
3	2	251	0.4902
4	2	308	0.6016
5	2	379	0.7402
6	2	449	0.8770
7	2	526	1.0273
8	2	602	1.1758
9	2	679	1.3262
10	4	340	1.3281
11	4	378	1.4766
12	4	434	1.6953
13	4	490	1.9141
14	4	553	2.1602
15	4	616	2.4063
16	4	658	2.5703
17	6	466	2.7305
18	6	517	3.0293
19	6	567	3.3223
20	6	616	3.6094
21	6	666	3.9023
22	6	719	4.2129
23	6	772	4.5234
24	6	822	4.8164
25	6	873	5.1152
26	6	910	5.3320
27	6	948	5.5547
28	q	reserved	
29	2	reserved	
30	4	reserved	
31	6	reserved	

[TS 38.214, clause 6.1.4.2]

For a PUSCH scheduled by RAR UL grant or for a PUSCH scheduled by a DCI format 0_0/0_1 with CRC scrambled by C-RNTI, new-RNTI, TC-RNTI, CS-RNTI, or SP-CSI-RNTI.

if

- $0 \leq I_{MCS} \leq 27$ and transform precoding is disabled and Table 5.1.3.1-2 is used, or
- $0 \leq I_{MCS} \leq 28$ and transform precoding is disabled and a table other than Table 5.1.3.1-2 is used, or
- $0 \leq I_{MCS} \leq 27$ and transform precoding is enabled, the UE shall first determine the TBS as specified below:

The UE shall first determine the number of REs (N_{RE}) within the slot:

- A UE first determines the number of REs allocated for PUSCH within a PRB (N'_{RE}) by

- $N'_{RE} = N_{sc}^{RB} * N_{symp}^{sh} - N_{DMRS}^{PRB} - N_{oh}^{PRB}$, where $N_{sc}^{RB} = 12$ is the number of subcarriers in the frequency domain in a physical resource block, N_{symp}^{sh} is the number of symbols of the PUSCH allocation within the slot, N_{DMRS}^{PRB} is the number of REs for DM-RS per PRB in the scheduled duration including the overhead of the DM-RS CDM groups without data, as indicated by DCI format 0_1 or as described for DCI format 0_0 in Subclause 6.2.2, and N_{oh}^{PRB} is the overhead configured by higher layer parameter $xOverhead$ in *PUSCH-ServingCellConfig*. If the N_{oh}^{PRB} is not configured (a value from 0, 6, 12, or 18), the N_{oh}^{PRB} is assumed to be 0. For MSG3 transmission the N_{oh}^{PRB} is always set to 0..
- A UE determines the total number of REs allocated for PUSCH (N_{RE}) by $N_{RE} = \min(156, N'_{RE}) \cdot n_{PRB}$ where n_{PRB} is the total number of allocated PRBs for the UE.
- Next, proceed with steps 2-4 as defined in Subclause 5.1.3.2

else if

- $28 \leq I_{MCS} \leq 31$ and transform precoding is disabled and Table 5.1.3.1-2 is used, or
- $28 \leq I_{MCS} \leq 31$ and transform precoding is enabled,
- the TBS is assumed to be as determined from the DCI transported in the latest PDCCH for the same transport block using $0 \leq I_{MCS} \leq 27$. If there is no PDCCH for the same transport block using $0 \leq I_{MCS} \leq 27$, and if the initial PUSCH for the same transport block is transmitted with configured grant, the TBS shall be determined from the most recent configured scheduling PDCCH.

else

- the TBS is assumed to be as determined from the DCI transported in the latest PDCCH for the same transport block using $0 \leq I_{MCS} \leq 28$. If there is no PDCCH for the same transport block using $0 \leq I_{MCS} \leq 28$, and if the initial PUSCH for the same transport block is transmitted with configured grant, the TBS shall be determined from the most recent configured scheduling PDCCH.

[TS 38.214, clause 5.1.3.2]

- 2) Intermediate number of information bits (N_{info}) is obtained by $N_{info} = N_{RE} \cdot R \cdot Q_m \cdot v$.

If $N_{info} \leq 3824$

Use step 3 as the next step of the TBS determination

else

Use step 4 as the next step of the TBS determination

end if

- 3) When $N_{info} \leq 3824$, TBS is determined as follows

- quantized intermediate number of information bits $N'_{info} = \max\left(24, 2^n \cdot \left\lfloor \frac{N_{info}}{2^n} \right\rfloor\right)$, where $n = \max(3, \log_2(N_{info})) - 6$.
- use Table 5.1.3.2-2 find the closest TBS that is not less than N'_{info} .

Table 5.1.3.2-2: TBS for $N_{info} \leq 3824$

Index	TBS	Index	TBS	Index	TBS	Index	TBS
1	24	31	336	61	1288	91	3624
2	32	32	352	62	1320	92	3752
3	40	33	368	63	1352	93	3824
4	48	34	384	64	1416		
5	56	35	408	65	1480		
6	64	36	432	66	1544		
7	72	37	456	67	1608		
8	80	38	480	68	1672		
9	88	39	504	69	1736		
10	96	40	528	70	1800		
11	104	41	552	71	1864		
12	112	42	576	72	1928		
13	120	43	608	73	2024		
14	128	44	640	74	2088		
15	136	45	672	75	2152		
16	144	46	704	76	2216		
17	152	47	736	77	2280		
18	160	48	768	78	2408		
19	168	49	808	79	2472		
20	176	50	848	80	2536		
21	184	51	888	81	2600		
22	192	52	928	82	2664		
23	208	53	984	83	2728		
24	224	54	1032	84	2792		
25	240	55	1064	85	2856		
26	256	56	1128	86	2976		
27	272	57	1160	87	3104		
28	288	58	1192	88	3240		
29	304	59	1224	89	3368		
30	320	60	1256	90	3496		

4) When $N_{info} > 3824$, TBS is determined as follows.

- quantized intermediate number of information bits $N'_{info} = \max\left(3840, 2^n \times \text{round}\left(\frac{N_{info} - 24}{2^n}\right)\right)$, where $n = \lfloor \log_2(N_{info} - 24) \rfloor - 5$ and ties in the round function are broken towards the next largest integer.
- if $R \leq 1/4$

$$TBS = 8 \cdot C \cdot \left\lceil \frac{N'_{info} + 24}{8 \cdot C} \right\rceil - 24, \text{ where } C = \left\lceil \frac{N'_{info} + 24}{3816} \right\rceil$$

else

if $N'_{info} > 8424$

$$TBS = 8 \cdot C \cdot \left\lceil \frac{N'_{info} + 24}{8 \cdot C} \right\rceil - 24, \text{ where } C = \left\lceil \frac{N'_{info} + 24}{8424} \right\rceil$$

else

$$TBS = 8 \cdot \left\lceil \frac{N'_{info} + 24}{8} \right\rceil - 24$$

end if

end if

7.1.1.4.2.5.3 Test description

7.1.1.4.2.5.3.1 Pre-test conditions

Same Pre-test conditions as in clause 7.1.1.0 except set the NR Cell bandwidth and applicable BWP to maximum for the NR Band under test as specified in Table 5.3.5-1 in TS 38.101-1 [16] / TS 38.101-2 [17] (to enable testing of n_{PRB} up to maximum value) and Short_DCI condition is applicable in NR Serving cell configuration.

Test frequency NRf1 is as specified in TS 38.508-1 [4] clause 4.3.1 using the common highest UL and DL channel bandwidth and using the default subcarrier spacing specified in TS 38.508-1 [4] clause 6.2.3.1.

7.1.1.4.2.5.3.2 Test procedure sequence

Table 7.1.1.4.2.5.3.2-1: Maximum TBS for different UE categories

UE Category	Maximum number of bits of a UL-SCH transport block received within a TTI
TS 38.306 [23] clause 4.1.2 require UE without <i>ue-CategoryDL</i> and <i>ue-CategoryUL</i> , to support Max TBS achievable based on max bandwidth of the Band under test.	

Table 7.1.1.4.2.5.3.2-2: Number of uplink PDCP SDUs and PDCP SDU size used as test data

TBS [bits]	Number of PDCP SDUs	PDCP SDU size [bits] (Note 1)
$136 \leq TBS \leq 12128$ note 2	1	$8 * \text{FLOOR}((TBS - 128)/8)$
$12129 \leq TBS \leq 24200$	2	$8 * \text{FLOOR}((TBS - 200)/16)$
$24201 \leq TBS \leq 36272$	3	$8 * \text{FLOOR}((TBS - 272)/24)$
$36273 \leq TBS \leq 48344$	4	$8 * \text{FLOOR}((TBS - 344)/32)$
$48345 \leq TBS \leq 60416$	5	$8 * \text{FLOOR}((TBS - 416)/40)$
$60417 \leq TBS \leq 72488$	6	$8 * \text{FLOOR}((TBS - 488)/48)$
$72489 \leq TBS \leq 84560$	7	$8 * \text{FLOOR}((TBS - 560)/56)$
$84561 \leq TBS \leq 96632$	8	$8 * \text{FLOOR}((TBS - 632)/64)$
$96633 \leq TBS \leq 108704$	9	$8 * \text{FLOOR}((TBS - 704)/72)$
$108705 \leq TBS \leq 120776$	10	$8 * \text{FLOOR}((TBS - 776)/80)$
$120777 \leq TBS \leq 132848$	11	$8 * \text{FLOOR}((TBS - 848)/88)$
$132849 \leq TBS \leq 144920$	12	$8 * \text{FLOOR}((TBS - 920)/96)$
$TBS > 144920$	13	$8 * \text{FLOOR}((TBS - 992)/104)$

Note 1: Each PDCP SDU is limited to 1500 octets (to keep below maximum SDU size of ESM as specified in TS 24.301 [21] clause 9.9.4.12).

The PDCP SDU size of each PDCP SDU is

$$\text{PDCP SDU size} = (TBS - N * \text{PDCP header size} - N * \text{AMD PDU header size} - N * \text{MAC header size} - \text{Size of Timing Advance} - \text{RLC Status PDU size} - \text{MAC header for RLC Status PDU}) / N, \text{ where}$$

PDCP header size is 24 bits for the RLC AM and 18-bit SN case;
AMD PDU header size is 24 bits with 18 bit SN;

MAC header size for AMD PDU = 16 or 24 bits depending on L=8 or 16 bits. Worst case 24 is taken.

Size of Timing Advance MAC CE with header is 16 bits (if no Timing Advance and/or RLC status needs to be sent, padding will occur instead).

RLC Status PDU size = 24 bits with 1 ACK_SN, With a MAC header of 16 bits.

This gives:

$$\text{PDCP SDU size} = 8 * \text{FLOOR}((TBS - N * 24 - N * 24 - N * 24 - 56) / (8 * N)) \text{ bits.}$$

Note 2: According to the final PDCP SDU size formula in Note 1, the smallest TBS that can be tested is 136 bits.

Table 7.1.1.4.2.5.3.2-3: Specific Parameters

Parameter	Value	Comment
number of layers (v)	1	
<i>transformPrecoder</i>	enabled	

Table 7.1.1.4.2.5.3.2-4: Main behaviour

St	Procedure	Message Sequence		TP	Verdict
		U - S	Message		
-	EXCEPTION: Steps 1 to 5 are repeated for allowed values of N_{PRB} 1 to $N_{RB}^{UL,BWP}$ in BWP, time domain resource as per Table 7.1.1.4.2.0-1 and I_{MCS} from 0 to 28.	-	-	-	-
1	The SS calculates or looks up TBS in TS 38.214 [15] based on the value of S , L , I_{MCS} and n_{PRB} .	-	-	-	-
-	EXCEPTION: Steps 2 to 5 are performed if TBS is less than or equal to UE capability "Maximum number of UL-SCH transport block bits received within a TTI" as specified in Table 7.1.1.4.2.5.3.2-1 and larger than or equal to 136 bits as specified in Table 7.1.1.4.2.5.3.2-2 Skip the execution of steps 2 to 5 for which the TBS size equal to 3824 or 3840. (Note 1)	-	-	-	-
2	The SS creates one or more PDCP SDUs, depending on TBS, in accordance with Table 7.1.1.4.2.5.3.2-2.	-	-	-	-
3	After 300ms, the SS transmits all PDCP SDUs (N_{SDUs}) as created in step 2 in a MAC PDU.	<--	MAC PDU ($N \times$ PDCP SDUs)	-	-
4	After 60ms of step 3, SS transmits UL Grant DCI 0_0, and values of S , L , I_{MCS} and n_{PRB} .	<--	(UL Grant) (DCI Format 0_0, S , L , I_{MCS} and n_{PRB})	-	-
5	CHECK: Does UE return the same number of PDCP SDUs with same content as transmitted by the SS in step 3 using Time, frequency Resources and modulation and coding scheme as configured by the SS in step 4?	-->	MAC PDU ($N \times$ PDCP SDU)	1	P
Note 1: There is ambiguity of TBS calculation when $3824.0 < N_{info} < 3825.0$ in clause 5.1.3.2 of TS 38.214 [15].					

7.1.1.4.2.5.3.3 Specific message contents

None.

7.1.1.5 Discontinuous reception

7.1.1.5.0 DRX Common Definitions

FirstSlot is the First DL Slot in the subframe, which is 0 for both FDD and TDD as per default configuration in 38.5081-1[4] TDD-UL-DL-Config Table 4.6.3-192

LastDLSlot is the Last DL Slot in a frame; for FDD numerology =0 it is slot 9, numerology=1 it is slot 19, numerology=2 it is slot 39. For TDD as per default configuration in 38.5081-1[4] TDD-UL-DL-Config Table 4.6.3-192, for numerology =0, it is slot 7, numerology=1 it is slot 16, numerology=3 it is slot 77

LastULSlot is the Last UL Slot in a frame; for FDD/TDD numerology =0 it is slot 9, numerology=1 it is slot 18(Second Last as 2 Consecutive UL Slots), numerology=3 it is slot 79; the PDCCH for UL grant is sent K2= 4 Slot earlier.

7.1.1.5.1 DRX operation / Short cycle not configured / Parameters configured by RRC

(1)

```
with { UE in RRC_CONNECTED state }
ensure that {
  when { Long DRX cycle is configured and [(SFN * 10) + subframe number] modulo (drx-LongCycle) =
drx-StartOffset }
  then { UE starts the OnDurationTimer and monitors the PDCCH for OnDurationTimer PDCCH-Occasions }
}
```

(2)

```
with { UE in RRC_CONNECTED state }
ensure that {
  when { Long DRX cycle is configured and a new DL transmission is indicated on the PDCCH during
Active Time }
  then { UE starts or restarts the Drx-InactivityTimer and monitors the PDCCH for Drx-
InactivityTimer PDCCH occasions starting from the next PDCCH occasion of the PDCCH occasion where
the DL new transmission was indicated }
}
```

(3)

```
with { UE in RRC_CONNECTED state }
ensure that {
  when { Long DRX cycle is configured and if a HARQ RTT Timer expires in this PDCCH Occasion and the
data in the soft buffer of the corresponding HARQ process was not successfully decoded }
  then { UE starts the drx-RetransmissionTimer-DL for the corresponding HARQ process and monitors
the PDCCH for drx-RetransmissionTimer consecutive PDCCH Occasion }
}
```

(4)

```
with { UE in RRC_CONNECTED state }
ensure that {
  when { Long DRX cycle is configured and an uplink grant for a pending HARQ retransmission can
occur in this PDCCH occasion }
  then { UE monitors the PDCCH in this PDCCH occasion }
}
```

7.1.1.5.1.2 Conformance requirements

References: The conformance requirements covered in the present TC are specified in: TS 38.321, clause 5.7. Unless otherwise stated these are Rel-15 requirements.

[TS 38.321, clause 5.7]

The MAC entity may be configured by RRC with a DRX functionality that controls the UE's PDCCH monitoring. . Activity for the MAC entity's C-RNTI, CS-RNTI, INT-RNTI, SFI-RNTI, SP-CSI-RNTI, TPC-PUCCH-RNTI, TPC-PUSCH-RNTI, and TPC-SRS-RNTI. When using DRX operation, the MAC entity shall also monitor PDCCH according to requirements found in other subclauses of this specification. When in RRC_CONNECTED, if DRX is configured, the MAC entity may monitor the PDCCH discontinuously using the DRX operation specified in this subclause; otherwise the MAC entity shall monitor the PDCCH continuously.

RRC controls DRX operation by configuring the following timers:

- *drx-onDurationTimer*: the duration at the beginning of a DRX Cycle;

- *drx-SlotOffset*: the delay before starting the *drx-onDurationTimer*;
- *drx-InactivityTimer*: the duration after the PDCCH occasion in which a PDCCH indicates an new UL or DL transmission for the MAC entity;
- *drx-RetransmissionTimerDL* (per DL HARQ process): the maximum duration until a DL retransmission is received;
- *drx-RetransmissionTimerUL* (per UL HARQ process): the maximum duration until a grant for UL retransmission is received;
- *drx-LongCycle StartOffset*: the Long DRX cycle and *drx-StartOffset* which defines the subframe where the Long and Short DRX Cycle starts;
- *drx-ShortCycle* (optional): the Short DRX cycle;
- *drx-ShortCycleTimer* (optional): the duration the UE shall follow the Short DRX cycle;
- *drx-HARQ-RTT-TimerDL* (per DL HARQ process): the minimum duration before a DL assignment for HARQ retransmission is expected by the MAC entity;
- *drx-HARQ-RTT-TimerUL* (per UL HARQ process): the minimum duration before a UL HARQ retransmission grant is expected by the MAC entity.

When a DRX cycle is configured, the Active Time includes the time while:

- *drx-onDurationTimer* or *drx-InactivityTimer* or *drx-RetransmissionTimerDL* or *drx-RetransmissionTimerUL* or *ra-ContentionResolutionTimer* (as described in subclause 5.1.5) is running; or
- a Scheduling Request is sent on PUCCH and is pending (as described in subclause 5.4.4); or
- a PDCCH indicating a new transmission addressed to the C-RNTI of the MAC entity has not been received after successful reception of a Random Access Response for the random access preamble not selected by the MAC entity among the contention-based Random Access Preamble (as described in subclause 5.1.4).

When DRX is configured, the MAC entity shall:

- 1> if a MAC PDU is received in a configured downlink assignment:
 - 2> start the *drx-HARQ-RTT-TimerDL* for the corresponding HARQ process in the first symbol after the end of the corresponding transmission carrying the DL HARQ feedback;
 - 2> stop the *drx-RetransmissionTimerDL* for the corresponding HARQ process.
- 1> if a MAC PDU is transmitted in a configured uplink grant:
 - 2> start the *drx-HARQ-RTT-TimerUL* for the corresponding HARQ process in the first symbol after the end of the first repetition of the corresponding PUSCH transmission;
 - 2> stop the *drx-RetransmissionTimerUL* for the corresponding HARQ process.
- 1> if a *drx-HARQ-RTT-TimerDL* expires:
 - 2> if the data of the corresponding HARQ process was not successfully decoded:
 - 3> start the *drx-RetransmissionTimerDL* for the corresponding HARQ process.
- 1> if an *drx-HARQ-RTT-TimerUL* expires:
 - 2> start the *drx-RetransmissionTimerUL* for the corresponding HARQ process.
- 1> if a DRX Command MAC CE or a Long DRX Command MAC CE is received:
 - 2> stop *drx-onDurationTimer*;
 - 2> stop *drx-InactivityTimer*.
- 1> if *drx-InactivityTimer* expires or a DRX Command MAC CE is received:

- 2> if the Short DRX cycle is configured:
 - 3> start or restart *drx-ShortCycleTimer* in the first symbol after the expiry of *drx-HARQ-RTT-TimerDL*;
 - 3> use the Short DRX Cycle.
- 2> else:
 - 3> use the Long DRX cycle.
- 1> if *drx-ShortCycleTimer* expires:
 - 2> use the Long DRX cycle.
- 1> if a Long DRX Command MAC CE is received:
 - 2> stop *drx-ShortCycleTimer*;
 - 2> use the Long DRX cycle.
- 1> if the Short DRX Cycle is used, and $[(\text{SFN} \times 10) + \text{subframe number}] \bmod (\text{drx-ShortCycle}) = (\text{drx-StartOffset}) \bmod (\text{drx-ShortCycle})$; or
- 1> if the Long DRX Cycle is used, and $[(\text{SFN} \times 10) + \text{subframe number}] \bmod (\text{drx-LongCycle}) = \text{drx-StartOffset}$:
 - 2> if *drx-SlotOffset* is configured:
 - 3> start *drx-onDurationTimer* after *drx-SlotOffset* from the beginning of the subframe.
 - 2> else:
 - 3> start *drx-onDurationTimer*.
- 1> if the MAC entity is in Active Time:
 - 2> monitor the PDCCH;
 - 2> if the PDCCH indicates a DL transmission or if a DL assignment has been configured:
 - 3> start the *drx-HARQ-RTT-TimerDL* for the corresponding HARQ process immediately after the corresponding PUCCH transmission;
 - 3> stop the *drx-RetransmissionTimerDL* for the corresponding HARQ process.
 - 2> if the PDCCH indicates a UL transmission or if a UL grant has been configured:
 - 3> start the *drx-HARQ-RTT-TimerUL* for the corresponding HARQ process immediately after the first repetition of the corresponding PUSCH transmission;
 - 3> stop the *drx-RetransmissionTimerUL* for the corresponding HARQ process.
 - 2> if the PDCCH indicates a new transmission (DL or UL):
 - 3> start or restart *drx-InactivityTimer*.
- 1> else (i.e. not part of the Active Time):
 - 2> not report CQI/PMI/RI on PUCCH.

7.1.1.5.1.3 Test description

7.1.1.5.1.3.1 Pre-test conditions

Same Pre-test conditions as in clause 7.1.1.0 except that set to return no data in uplink.

7.1.1.5.1.3.2 Test procedure sequence

Table 7.1.1.5.1.3.2-1: Main behaviour

St	Procedure	Message Sequence		TP	Verdict
		U - S	Message		
1	SS transmits RRCConnectionReconfiguration to configure specific DRX parameters.	<--	-	-	-
2	The UE transmits RRCConnectionReconfigurationComplete	-->	-	-	-
3	In the first PDCCH occasion when the <i>Drx-onDurationTimer</i> is running, the SS indicates the transmission of a DL MAC PDU on the PDCCH.	<--	MAC PDU	-	-
4	Check: Does the UE transmit a HARQ ACK for the DL MAC PDU in Step 3?	-->	HARQ ACK	1	P
5	At least <i>drx-InactivityTimer</i> PDCCH occasions after the transmission of the MAC PDU in Step 3 has been indicated (This means the next DRX cycle or later after Step 2) in the last PDCCH occasion while the <i>drx-onDurationTimer</i> is still running, the SS indicates the transmission a DL MAC PDU on the PDDCH. (Note 4).	<--	MAC PDU	-	-
6	Check: Does the UE transmit a HARQ ACK for the DL MAC PDU in Step 5?	-->	HARQ ACK	1	P
7	<i>drx-InactivityTimer</i> PDCCH-occasions after the transmission of the MAC PDU transmitted in step 5 was indicated on the PDCCH, the SS indicates the transmission of a DL MAC PDU on the PDCCH. (Note 4)	<--	MAC PDU	-	-
8	Check: Does the UE transmit a HARQ ACK for the DL MAC PDU in Step 7?	-->	HARQ ACK	2	P
9	At least <i>drx-InactivityTimer</i> PDCCH occasions after the transmission of the MAC PDU in Step 7 has been indicated (This means the next DRX cycle or later after Step 5) and in the last PDCCH occasion before the <i>Drx-onDurationTimer</i> expires, the SS indicates the transmission of a DL MAC PDU on the PDDCH. The DL MAC PDU transmitted is invalid. (Note 1, Note 4)	<--	Invalid MAC PDU	-	-
10	Check: Does the UE transmit a HARQ NACK for the DL MAC PDU in Step 9?	-->	HARQ NACK	1	P
11	In the first PDCCH occasion when the <i>Drx-RetransmissionTimerDL</i> for the MAC PDU in Step 9 is started (i.e. after expiry of <i>drx-HARQ-RTT-TimerDL</i> after step 9), the SS indicates the transmission of a DL MAC PDU on the PDCCH.	<--	MAC PDU	-	-
12	Check: Does the UE transmit a HARQ ACK for the DL MAC PDU in Step 11?	-->	HARQ ACK	3	P
13	At least <i>drx-InactivityTimer</i> PDCCH occasions after the transmission of the DL MAC PDU in Step 11 has been indicated (This means the next DRX cycle or later after Step 11) and last PDCCH occasion before the <i>Drx-onDurationTimer</i> expires, the SS indicates the transmission of DL MAC PDU on the PDCCH. The DL MAC PDU transmitted is invalid. (Note 1, Note 4)	<--	Invalid MAC PDU	-	-
14	Check: Does the UE transmit a HARQ NACK for the DL MAC PDU in Step 13?	-->	HARQ NACK	1	P

15	In the last PDCCH occasion when the drx-RetransmissionTimerDL for MAC PDU in Step 13 is still running, the SS indicates the transmission of a DL MAC PDU on the PDCCH.	<--	MAC PDU	-	-
16	Check: Does the UE transmit a HARQ ACK for the DL MAC PDU in Step 15?	-->	HARQ ACK	3	P
17	The SS is configured for Uplink Grant Allocation Type [0]. At least drx-InactivityTimer PDCCH subframes after the transmission of the DL MAC PDU in Step 15 has been indicated in the last PDCCH occasion when the onDurationTimer is still running (This means the next DRX cycle or later after Step 9), the SS indicates an UL grant to the UE on the PDCCH. (Note 4)	<--	UL grant on PDCCH	-	-
18	Check: Does the UE transmit a Buffer Status Report on the UL indicating an empty buffer?	-->	Buffer Status Report MAC control element	1	P
19	In the last PDCCH occasion when the drx-RetransmissionTimer-UL for MAC PDU from Step 17 is still running, the SS indicates the transmission of a DL MAC PDU on the PDCCH.	<--	MAC PDU	-	-
20	Check: Does the UE transmit a HARQ ACK for the DL MAC PDU in Step 19?	-->	HARQ ACK	4	P
<p>Note 1: Invalid MAC PDU is a MAC PDU that fails the CRC check.</p> <p>Note 2: All the DL MAC PDU are transmitted with the NDI set on the PDCCH.</p> <p>Note 3: Timer tolerances for the MAC DRX related timers measured in PDCCH occasions is 0. These timers are: drx-InactivityTimer, drx-RetransmissionTimerDL, drx-RetransmissionTimerUL, drx-HARQ-RTT-TimerDL and drx-HARQ-RTT-TimerUL.</p> <p>Note 4: The drx-InactivityTimer is started in the next PDCCH occasion of the PDCCH occasion where DL new transmission is indicated.</p> <p>Note 5: The timer values expressed in number of slots.</p>					

7.1.1.5.1.3.3 Specific message contents

Table 7.1.1.5.1.3.3-1: RRCConnectionReconfiguration (step 1, Table 7.1.1.5.1.3.2-1)

Derivation Path: 38.508-1 [4], Table [value]			
Information Element	Value/remark	Comment	Condition
RRCReconfiguration-IEs ::= SEQUENCE {			
secondaryCellGroupToAddModList SEQUENCE (SIZE (1..maxSCellGroups)) OF cellGroupConfig {	[1 entry]		
cellGroupConfig [value] SEQUENCE {			
mac-CellGroupConfig SEQUENCE {			
drx-Config CHOICE {			
setup SEQUENCE {			
drx-onDurationTimer	ms20		
drx-InactivityTimer	Ms10		
drx-HARQ-RTT-TimerDL	56	Number of slots=4 due to number of symbol per slot=14	$\mu = 0,1,2,3$, 4 (2 with normal CP)
drx-HARQ-RTT-TimerDL	48	Number of slots=4 due to number of symbol per slot=12	$\mu = 2$ with external CP
drx-HARQ-RTT-TimerUL	56	Number of slots=4 due to number of symbol per slot=14	$\mu = 0,1,2,3$, 4 (2 with normal CP)
drx-HARQ-RTT-TimerUL	48	Number of slots=4 due to number of symbol per slot=12	$\mu = 2$ with external CP
drx-RetransmissionTimerDL	sl8		
drx-RetransmissionTimerUL	sl8		
drx-LongCycleStartOffset CHOICE {			
ms640	7		
}			
shortDRX	Not present		
drx-SlotOffset	ms0		
}			
}			
}			
}			
}			
}			

7.1.1.5.2 DRX operation / Short cycle not configured / Long DRX command MAC control element reception

7.1.1.5.2.1 Test Purpose (TP)

(1)

```

with { UE in CONNECTED mode }
ensure that {
  when { long DRX cycle is configured and a DRX Command MAC control element is received }
    then { UE successfully decodes the MAC control PDU }
}

```

(2)

```

with { UE in CONNECTED mode }
ensure that {
  when { long DRX cycle is configured and the HARQ RTT Timer is running and a DRX Command MAC control element is received }
    then { UE continues running the HARQ RTT timer }
}

```

}

(3)

```

with { UE in CONNECTED mode }
ensure that {
  when { long DRX cycle is configured and the drx-RetransmissionTimer is running and a DRX Command
MAC control element is received }
  then { UE continues running the drx-RetransmissionTimer and monitors the PDCCH }
}

```

7.1.1.5.2.2 Conformance requirements

References: The conformance requirements covered in the present TC are specified in: TS 38.321, clause 5.7. Unless otherwise stated these are Rel-15 requirements.

[TS 38.321, clause 5.7]

The MAC entity may be configured by RRC with a DRX functionality that controls the UE's PDCCH monitoring. Activity for the MAC entity's C-RNTI, CS-RNTI, INT-RNTI, SFI-RNTI, SP-CSI-RNTI, TPC-PUCCH-RNTI, TPC-PUSCH-RNTI, and TPC-SRS-RNTI. When using DRX operation, the MAC entity shall also monitor PDCCH according to requirements found in other subclasses of this specification. When in RRC_CONNECTED, if DRX is configured, the MAC entity may monitor the PDCCH discontinuously using the DRX operation specified in this subclass; otherwise the MAC entity shall monitor the PDCCH continuously.

RRC controls DRX operation by configuring the following timers:

- *drx-onDurationTimer*: the duration at the beginning of a DRX Cycle;
- *drx-SlotOffset*: the delay before starting the *drx-onDurationTimer*;
- *drx-InactivityTimer*: the duration after the PDCCH occasion in which a PDCCH indicates a new UL or DL transmission for the MAC entity;
- *drx-RetransmissionTimerDL* (per DL HARQ process): the maximum duration until a DL retransmission is received;
- *drx-RetransmissionTimerUL* (per UL HARQ process): the maximum duration until a grant for UL retransmission is received;
- *drx-LongCycle StartOffset*: the Long DRX cycle and *drx-StartOffset* which defines the subframe where the Long and Short DRX Cycle starts;
- *drx-ShortCycle* (optional): the Short DRX cycle;
- *drx-ShortCycleTimer* (optional): the duration the UE shall follow the Short DRX cycle;
- *drx-HARQ-RTT-TimerDL* (per DL HARQ process): the minimum duration before a DL assignment for HARQ retransmission is expected by the MAC entity;
- *drx-HARQ-RTT-TimerUL* (per UL HARQ process): the minimum duration before a UL HARQ retransmission grant is expected by the MAC entity.

When a DRX cycle is configured, the Active Time includes the time while:

- *drx-onDurationTimer* or *drx-InactivityTimer* or *drx-RetransmissionTimerDL* or *drx-RetransmissionTimerUL* or *ra-ContentionResolutionTimer* (as described in subclass 5.1.5) is running; or
- a Scheduling Request is sent on PUCCH and is pending (as described in subclass 5.4.4); or
- a PDCCH indicating a new transmission addressed to the C-RNTI of the MAC entity has not been received after successful reception of a Random Access Response for the random access preamble not selected by the MAC entity among the contention-based Random Access Preamble (as described in subclass 5.1.4).

When DRX is configured, the MAC entity shall:

- 1> if a MAC PDU is received in a configured downlink assignment:

- 2> start the *drx-HARQ-RTT-TimerDL* for the corresponding HARQ process in the first symbol after the end of the corresponding transmission carrying the DL HARQ feedback;
 - 2> stop the *drx-RetransmissionTimerDL* for the corresponding HARQ process.
- 1> if a MAC PDU is transmitted in a configured uplink grant:
- 2> start the *drx-HARQ-RTT-TimerUL* for the corresponding HARQ process in the first symbol after the end of the first repetition of the corresponding PUSCH transmission;
 - 2> stop the *drx-RetransmissionTimerUL* for the corresponding HARQ process.
- 1> if a *drx-HARQ-RTT-TimerDL* expires:
- 2> if the data of the corresponding HARQ process was not successfully decoded:
 - 3> start the *drx-RetransmissionTimerDL* for the corresponding HARQ process.
- 1> if an *drx-HARQ-RTT-TimerUL* expires:
- 2> start the *drx-RetransmissionTimerUL* for the corresponding HARQ process.
- 1> if a DRX Command MAC CE or a Long DRX Command MAC CE is received:
- 2> stop *drx-onDurationTimer*;
 - 2> stop *drx-InactivityTimer*.
- 1> if *drx-InactivityTimer* expires or a DRX Command MAC CE is received:
- 2> if the Short DRX cycle is configured:
 - 3> start or restart *drx-ShortCycleTimer* in the first symbol after the expiry of *drx-HARQ-RTT-TimerDL*;
 - 3> use the Short DRX Cycle.
 - 2> else:
 - 3> use the Long DRX cycle.
- 1> if *drx-ShortCycleTimer* expires:
- 2> use the Long DRX cycle.
- 1> if a Long DRX Command MAC CE is received:
- 2> stop *drx-ShortCycleTimer*;
 - 2> use the Long DRX cycle.
- 1> if the Short DRX Cycle is used, and $[(\text{SFN} \times 10) + \text{subframe number}] \bmod (\text{drx-ShortCycle}) = (\text{drx-StartOffset}) \bmod (\text{drx-ShortCycle})$; or
- 1> if the Long DRX Cycle is used, and $[(\text{SFN} \times 10) + \text{subframe number}] \bmod (\text{drx-LongCycle}) = \text{drx-StartOffset}$:
- 2> if *drx-SlotOffset* is configured:
 - 3> start *drx-onDurationTimer* after *drx-SlotOffset* from the beginning of the subframe..
 - 2> else:
 - 3> start *drx-onDurationTimer*.
- 1> if the MAC entity is in Active Time:
- 2> monitor the PDCCH;
 - 2> if the PDCCH indicates a DL transmission or if a DL assignment has been configured:

3> start the *drx-HARQ-RTT-TimerDL* for the corresponding HARQ process immediately after the corresponding PUCCH transmission;

3> stop the *drx-RetransmissionTimerDL* for the corresponding HARQ process.

2> if the PDCCH indicates a UL transmission or if a UL grant has been configured:

3> start the *drx-HARQ-RTT-TimerUL* for the corresponding HARQ process immediately after the first repetition of the corresponding PUSCH transmission;

3> stop the *drx-RetransmissionTimerUL* for the corresponding HARQ process.

2> if the PDCCH indicates a new transmission (DL or UL):

3> start or restart *drx-InactivityTimer*.

1> else (i.e. not part of the Active Time):

2> not report CQI/PMI/RI on PUCCH.

7.1.1.5.2.3 Test description

7.1.1.5.2.3.1 Pre-test conditions

Same Pre-test conditions as in clause 7.1.1.0 except that set to return no data in uplink.

7.1.1.5.2.3.2 Test procedure sequence

For FDD, *NormalSLT*(current SFN,current sub-frame, current slot,y)=y; For TDD, *NormalSLT*(current SFN, current slot,y) counts the minimum number of normal slots needed to cover y number of PDCCH-occasions(slots) until next PDCCH-occasion(slot) available, starting from current slot on current SFN.

Table 7.1.1.5.2.3.2-1: Main behaviour

St	Procedure	Message Sequence		TP	Verdict
		U - S	Message		
1	SS transmits RRCReconfiguration to configure specific DRX parameters. (Note 5)	<--	-	-	-
2	The UE transmits RRCReconfigurationComplete. (Note 6)	-->	-	-	-
3	In a PDCCH occasion which is X PDCCH sub frames before the PDCCH occasion in which the onDurationTimer expires, with $X < drx-onDurationTimer$, the SS indicates the transmission of a DL MAC PDU on the PDCCH. The SS transmits an MAC PDU.	<--	MAC PDU	-	-
4	Check: Does the UE transmit a HARQ NACK for the DL MAC PDU in Step 1?	-->	HARQ ACK	1	P
5	In a PDCCH occasion before the <i>drx-onDurationTimer</i> expires, the SS indicates the transmission of a DL MAC PDU on the PDCCH. The SS transmits a DL MAC PDU with DRX MAC Control element. UE successfully decodes the MAC PDU and starts the long DRX cycle.	<--	MAC PDU(DRX MAC Control element)	-	-
6	Check: Does the UE transmit a HARQ ACK?	-->	HARQ ACK	1	P
6A	In a PDCCH occasion before the Long DRX cycle ends, the SS indicates the transmission of a DL MAC PDU on the PDCCH. The SS transmits a DL MAC PDU	<--	MAC PDU		
6B	Check: Does the UE transmit a HARQ ACK?	-->	HARQ ACK	1	F
7	On the next or later DRX cycle than the one used for Step 3 and on a PDCCH occasion which is X PDCCH sub frames before the PDCCH occasion in which the <i>onDurationTimer</i> expires, with $X < drx-onDurationTimer$, the SS indicates the transmission of a DL MAC PDU. The SS transmits an invalid MAC PDU. (Note 1)	<--	MAC PDU	-	-
8	Check: Does the UE transmit a HARQ NACK?	-->	HARQ NACK	-	P
8A	In a PDCCH occasion before the <i>Drx-HARQ-RTT-TimerDL</i> for the MAC PDU indicated in Step 7 expires, the SS indicates the transmission of a DL MAC PDU on the PDCCH. The SS transmits a DL MAC PDU with DRX MAC Control element.	<--	MAC PDU(DRX MAC Control element)	-	-
8B	Check: Does the UE transmit a HARQ ACK?	-->	HARQ ACK	2,3	P
9	In a PDCCH occasion when the <i>drx-RetransmissionTimer</i> for the MAC PDU indicated in Step 7 is still running,, the SS indicates the transmission of a DL MAC PDU. The SS transmits a DL MAC PDU with DRX MAC Control element.	<--	MAC PDU(DRX MAC Control element)	-	-
10	Check: Does the UE transmit a HARQ ACK?	-->	HARQ ACK	2,3	P
11	In the last sub frame when the <i>Drx-RetransmissionTimer</i> for the DL MAC PDU indicated on the PDCCH in Step 7 is still running, the SS indicates the transmission of a DL MAC PDU.	<--	MAC PDU	-	-
12	Check: Does the UE transmit a HARQ ACK?	-->	HARQ ACK	2,3	P
<p>Note 1: Invalid MAC PDU is a MAC PDU that fails the CRC check.</p> <p>Note 2: All DL MAC PDUs are transmitted with the NDI set on the PDCCH.</p> <p>Note 3: Timer tolerances for the MAC DRX related timers measured in PDCCH occasions(slots). These timers are: <i>drx-InactivityTimer</i>, <i>drx-RetransmissionTimer</i>, <i>Drx-HARQ-RTT-TimerDL</i>.</p> <p>Note 5: For EN-DC the NR RRCReconfiguration message is contained in RRCConnectionReconfiguration 36.508 [7], Table 4.6.1-8 using condition EN-DC_EmbedNR_RRCRecon.</p> <p>Note 6: For EN-DC the NR RRCReconfigurationComplete message is contained in RRCConnectionReconfigurationComplete</p>					

7.1.1.5.2.3.3 Specific message contents

Table 7.1.1.5.2.3.3-1: *RRCReconfiguration* (step 1, Table 7.1.1.5.2.3.2-1)

Derivation Path: 38.508-1 [4], Table [4.6.1-13]			
Information Element	Value/remark	Comment	Condition
RRCReconfiguration-IEs ::= SEQUENCE {			
secondaryCellGroupToAddModList SEQUENCE	[1 entry]		
(SIZE (1..maxSCellGroups)) OF cellGroupConfig {			
cellGroupConfig[value] SEQUENCE {			
mac-CellGroupConfig SEQUENCE {			
drx-Config CHOICE {			
setup SEQUENCE {			
drx-onDurationTimer	ms40		
drx-InactivityTimer	Ms10		
drx-HARQ-RTT-TimerDL	56	Number of slots=4 due to number of symbol per slot=14	$\mu = 0,1,2,3,$ 4 (2 with normal CP)
drx-HARQ-RTT-TimerUL	56	Number of slots=4 due to number of symbol per slot=14	$\mu = 0,1,2,3,$ 4 (2 with normal CP)
drx-RetransmissionTimerDL	sl80		
drx-RetransmissionTimerUL	sl80		
drx-LongCycleStartOffset CHOICE {			
ms640	7		
}			
shortDRX	Not present		
drx-SlotOffset	ms0		
}			
}			
}			
}			
}			

7.1.1.5.3 DRX operation / Short cycle configured / Parameters configured by RRC

7.1.1.5.3.1 Test Purpose (TP)

(1)

```

with { UE in RRC_CONNECTED state }
ensure that {
  when { Short DRX cycle and drx-SlotOffset is configured and [(SFN * 10) + subframe number] modulo
drx-ShortCycle) = (drx-StartOffset) modulo (drx-ShortCycle) }
  then { UE starts the OnDurationTimer after drx-SlotOffset and monitors the PDCCH for
OnDurationTimer PDCCH-subframes }
}

```

(2)

```

with { UE in RRC_CONNECTED state }
ensure that {
  when { drxShortCycleTimer is expired and [(SFN * 10) + subframe number] modulo (drx-LongCycle) =
drx-StartOffset: }
  then { UE starts the OnDurationTimer after drx-SlotOffset and monitors the PDCCH for
OnDurationTimer PDCCH-subframes }
}

```

7.1.1.5.3.2 Conformance requirements

Editor's Note: The conformance requirements are based on running RAN2 CR

References: The conformance requirements covered in the present test case are specified in: TS 38.321, clause 5.7. Unless otherwise stated these are Rel-15 requirements.

[TS 38.321, clause 5.7]

The MAC entity may be configured by RRC with a DRX functionality that controls the UE's PDCCH monitoring activity for the MAC entity's C-RNTI, CS-RNTI, INT-RNTI, SFI-RNTI, SP-CSI-RNTI, TPC-PUCCH-RNTI, TPC-PUSCH-RNTI, and TPC-SRS-RNTI. When using DRX operation, the MAC entity shall also monitor PDCCH according to requirements found in other subclauses of this specification. When in RRC_CONNECTED, if DRX is configured, the MAC entity may monitor the PDCCH discontinuously using the DRX operation specified in this subclause; otherwise the MAC entity shall monitor the PDCCH continuously.

RRC controls DRX operation by configuring the following parameters:

- *drx-onDurationTimer*: the duration at the beginning of a DRX Cycle;
- *drx-SlotOffset*: the delay before starting the *drx-onDurationTimer*;
- *drx-InactivityTimer*: the duration after the PDCCH occasion in which a PDCCH indicates a new UL or DL transmission for the MAC entity;
- *drx-RetransmissionTimerDL* (per DL HARQ process): the maximum duration until a DL retransmission is received;
- *drx-RetransmissionTimerUL* (per UL HARQ process): the maximum duration until a grant for UL retransmission is received;
- *drx-LongCycleStartOffset*: the Long DRX cycle and *drx-StartOffset* which defines the subframe where the Long and Short DRX Cycle starts;
- *drx-ShortCycle* (optional): the Short DRX cycle;
- *drx-ShortCycleTimer* (optional): the duration the UE shall follow the Short DRX cycle;
- *drx-HARQ-RTT-TimerDL* (per DL HARQ process): the minimum duration before a DL assignment for HARQ retransmission is expected by the MAC entity;
- *drx-HARQ-RTT-TimerUL* (per UL HARQ process): the minimum duration before a UL HARQ retransmission grant is expected by the MAC entity.

When a DRX cycle is configured, the Active Time includes the time while:

- *drx-onDurationTimer* or *drx-InactivityTimer* or *drx-RetransmissionTimerDL* or *drx-RetransmissionTimerUL* or *ra-ContentionResolutionTimer* (as described in subclause 5.1.5) is running; or
- a Scheduling Request is sent on PUCCH and is pending (as described in subclause 5.4.4); or
- a PDCCH indicating a new transmission addressed to the C-RNTI of the MAC entity has not been received after successful reception of a Random Access Response for the Random Access Preamble not selected by the MAC entity among the contention-based Random Access Preamble (as described in subclause 5.1.4).

...

- 1> if *drx-InactivityTimer* expires or a DRX Command MAC CE is received:
 - 2> if the Short DRX cycle is configured:
 - 3> start or restart *drx-ShortCycleTimer* in the first symbol after the expiry of *drx-InactivityTimer* or in the first symbol after the end of DRX Command MAC CE reception;
 - 3> use the Short DRX Cycle.
 - 2> else:
 - 3> use the Long DRX cycle.
- 1> if *drx-ShortCycleTimer* expires:

2> use the Long DRX cycle.

1> if a Long DRX Command MAC CE is received:

2> stop *drx-ShortCycleTimer*;

2> use the Long DRX cycle.

1> if the Short DRX Cycle is used, and $[(SFN \times 10) + \text{subframe number}] \bmod (drx-ShortCycle) = (drx-StartOffset) \bmod (drx-ShortCycle)$; or

1> if the Long DRX Cycle is used, and $[(SFN \times 10) + \text{subframe number}] \bmod (drx-LongCycle) = drx-StartOffset$:

2> start *drx-onDurationTimer* after *drx-SlotOffset* from the beginning of the subframe.

7.1.1.5.3.3 Test description

7.1.1.5.3.3.1 Pre-test conditions

Same Pre-test conditions as in clause 7.1.1.0 except that set to return no data in uplink.

7.1.1.5.3.3.2 Test procedure sequence

For FDD, *NormalSLT* (current SFN, current sub-frame, current slot, y) = y ; For TDD, *NormalSLT* (current SFN, current slot, y) counts the minimum number of normal slots needed to cover y number of PDCCH-occasions(slots) until next PDCCH-occasion(slot) available, starting from current slot on current Subframe.

Table 7.1.1.5.3.3.2-1: Main behaviour

St	Procedure	Message Sequence		TP	Verdict
		U – S	Message		
1	SS transmits NR <i>RRCReconfiguration</i> message to configure specific DRX parameters for SpCell (Note1)	<--	-	-	-
2	The UE transmit NR <i>RRCReconfigurationComplete</i> messages (Note 2)	-->	-	-	-
3	In the first PDCCH occasion, after the <i>drx-SlotOffset</i> when the <i>drx-onDurationTimer</i> is running, the SS indicates the transmission of a DL MAC PDU on the PDCCH. (Note 3)(Note 4)	<--	MAC PDU	-	-
4	Check: Does the UE transmit a HARQ ACK for the DL MAC PDU in Step 3?	-->	HARQ ACK	-	-
5	At least <i>drx-InactivityTimer</i> after the transmission of the MAC PDU in Step 3 has been indicated (This means the next DRX cycle or later after Step 1) in the last PDCCH occasion while the <i>drx-onDurationTimer</i> is still running according to $[(SFN * 10) + \text{subframe number}] \bmod \text{drx-ShortCycle} = (\text{drx-StartOffset}) \bmod (\text{drx-ShortCycle})$, the SS indicates the transmission a DL MAC PDU on the PDCCH.	<--	MAC PDU	-	-
6	Check: Does the UE transmit a HARQ ACK for the DL MAC PDU in Step 5?	-->	HARQ ACK	1	P
7	SS waits for <i>drx-ShortCycleTimer</i> to expire.	-	-	-	-
8	In the first PDCCH occasion after the <i>drx-SlotOffset</i> when the <i>drx-onDurationTimer</i> of <i>drx-LongCycle</i> is running, the SS indicates the transmission of a DL MAC PDU on the PDCCH.	<--	MAC PDU	-	-
9	Check: Does the UE transmit a HARQ ACK for the DL MAC PDU in Step 8?	-->	HARQ ACK	2	P
Note 1: For EN-DC the NR <i>RRCReconfiguration</i> message is contained in <i>RRCConnectionReconfiguration</i> 36.508 [7], Table 4.6.1-8 using condition EN-DC_EmbedNR_RRCRecon.					
Note 2: For EN-DC the NR <i>RRCReconfigurationComplete</i> message is contained in <i>RRCConnectionReconfigurationComplete</i> .					
Note 3: The <i>drx-InactivityTimer</i> is started in the first symbol after the end of the PDCCH reception where DL new transmission is indicated.					
Note 4: When the <i>drx-InactivityTimer</i> expires, UE starts <i>drx-ShortCycleTimer</i> in the first symbol after the expiry of <i>drx-InactivityTimer</i> .					

7.1.1.5.3.3.3 Specific message contents

Table 7.1.1.5.3.3.3-1: *RRCReconfiguration* (step 1, Table 7.1.1.5.3.3.2-1)

Derivation Path: 38.508-1 [4], Table 4.6.1-13			
Information Element	Value/remark	Comment	Condition
<i>RRCReconfiguration</i> ::= SEQUENCE {			
<i>criticalExtensions</i> CHOICE {			
<i>rrcReconfiguration</i> ::= SEQUENCE {			
<i>radioBearerConfig</i>	RadioBearerConfig		NR
<i>secondaryCellGroup</i>	CellGroupConfig		EN-DC
}			
<i>nonCriticalExtension</i> ::= SEQUENCE {			NR
<i>masterCellGroup</i>	CellGroupConfig		
}			
}			
}			

Table 7.1.1.5.3.3.3-2: *CellGroupConfig* (Table 7.1.1.5.3.3.3-1)

Derivation Path: 38.508-1 [4], Table 4.6.3-19			
Information Element	Value/remark	Comment	Condition
cellGroupConfig ::= SEQUENCE {			
mac-CellGroupConfig SEQUENCE {			
drx-Config CHOICE {			
setup SEQUENCE {			
drx-onDurationTimer	ms20		
drx-InactivityTimer	Ms10		
drx-HARQ-RTT-TimerDL	56		
drx-HARQ-RTT-TimerUL	56		
drx-RetransmissionTimerDL	sI80		
drx-RetransmissionTimerUL	sI80		
drx-LongCycleStartOffset CHOICE {			
ms640	7		
}			
shortDRX SEQUENCE {			
drx-ShortCycle	Ms80		
drx-ShortCycleTimer	7		
}			
drx-SlotOffset	ms0		
}			
}			

7.1.1.5.4 DRX Operation / Short cycle configured / DRX command MAC control element reception

7.1.1.5.4.1 Test Purpose (TP)

(1)

```
with { UE in RRC_CONNECTED state }
ensure that {
  when { Short DRX cycle is configured and a DRX Command MAC control element is received }
  then { UE successfully decodes the MAC control PDU }
}
```

(2)

```
with { UE in RRC_CONNECTED state }
ensure that {
  when { Short DRX cycle is configured and the HARQ RTT Timer is running and a DRX Command MAC
control element is received }
  then { UE continues running the HARQ RTT timer }
}
```

(3)

```
with { UE in RRC_CONNECTED state }
ensure that {
  when { Short DRX cycle is configured and the drx-RetransmissionTimer-DL is running and a DRX
Command MAC control element is received }
  then { UE continues running the drx-RetransmissionTimer-DL and monitors the PDCCH }
}
```

7.1.1.5.4.2 Conformance requirements

References: The conformance requirements covered in the present TC are specified in: TS 38.321, clause 5.7. Unless otherwise stated these are Rel-15 requirements.

[TS 38.321, clause 5.7]

The MAC entity may be configured by RRC with a DRX functionality that controls the UE's PDCCH monitoring activity for the MAC entity's C-RNTI, CS-RNTI, INT-RNTI, SFI-RNTI, SP-CSI-RNTI, TPC-PUCCH-RNTI, TPC-PUSCH-RNTI, and TPC-SRS-RNTI. When using DRX operation, the MAC entity shall also monitor PDCCH according to requirements found in other subclauses of this specification. When in RRC_CONNECTED, if DRX is configured, for all the activated Serving Cells, the MAC entity may monitor the PDCCH discontinuously using the DRX operation specified in this subclause; otherwise the MAC entity shall monitor the PDCCH continuously.

RRC controls DRX operation by configuring the following parameters:

- *drx-onDurationTimer*: the duration at the beginning of a DRX Cycle;
- *drx-SlotOffset*: the delay before starting the *drx-onDurationTimer*;
- *drx-InactivityTimer*: the duration after the PDCCH occasion in which a PDCCH indicates a new UL or DL transmission for the MAC entity;
- *drx-RetransmissionTimerDL* (per DL HARQ process except for the broadcast process): the maximum duration until a DL retransmission is received;
- *drx-RetransmissionTimerUL* (per UL HARQ process): the maximum duration until a grant for UL retransmission is received;
- *drx-LongCycleStartOffset*: the Long DRX cycle and *drx-StartOffset* which defines the subframe where the Long and Short DRX Cycle starts;
- *drx-ShortCycle* (optional): the Short DRX cycle;
- *drx-ShortCycleTimer* (optional): the duration the UE shall follow the Short DRX cycle;
- *drx-HARQ-RTT-TimerDL* (per DL HARQ process except for the broadcast process): the minimum duration before a DL assignment for HARQ retransmission is expected by the MAC entity;
- *drx-HARQ-RTT-TimerUL* (per UL HARQ process): the minimum duration before a UL HARQ retransmission grant is expected by the MAC entity.

When a DRX cycle is configured, the Active Time includes the time while:

- *drx-onDurationTimer* or *drx-InactivityTimer* or *drx-RetransmissionTimerDL* or *drx-RetransmissionTimerUL* or *ra-ContentionResolutionTimer* (as described in subclause 5.1.5) is running; or
- a Scheduling Request is sent on PUCCH and is pending (as described in subclause 5.4.4); or
- a PDCCH indicating a new transmission addressed to the C-RNTI of the MAC entity has not been received after successful reception of a Random Access Response for the Random Access Preamble not selected by the MAC entity among the contention-based Random Access Preamble (as described in subclause 5.1.4).

When DRX is configured, the MAC entity shall:

- 1> if a MAC PDU is received in a configured downlink assignment:
 - 2> start the *drx-HARQ-RTT-TimerDL* for the corresponding HARQ process in the first symbol after the end of the corresponding transmission carrying the DL HARQ feedback;
 - 2> stop the *drx-RetransmissionTimerDL* for the corresponding HARQ process.
- 1> if a MAC PDU is transmitted in a configured uplink grant:
 - 2> start the *drx-HARQ-RTT-TimerUL* for the corresponding HARQ process in the first symbol after the end of the first repetition of the corresponding PUSCH transmission;
 - 2> stop the *drx-RetransmissionTimerUL* for the corresponding HARQ process.
- 1> if a *drx-HARQ-RTT-TimerDL* expires:
 - 2> if the data of the corresponding HARQ process was not successfully decoded:

- 3> start the *drx-RetransmissionTimerDL* for the corresponding HARQ process in the first symbol after the expiry of *drx-HARQ-RTT-TimerDL*.
- 1> if a *drx-HARQ-RTT-TimerUL* expires:
 - 2> start the *drx-RetransmissionTimerUL* for the corresponding HARQ process in the first symbol after the expiry of *drx-HARQ-RTT-TimerUL*.
- 1> if a DRX Command MAC CE or a Long DRX Command MAC CE is received:
 - 2> stop *drx-onDurationTimer*;
 - 2> stop *drx-InactivityTimer*.
- 1> if *drx-InactivityTimer* expires or a DRX Command MAC CE is received:
 - 2> if the Short DRX cycle is configured:
 - 3> start or restart *drx-ShortCycleTimer* in the first symbol after the expiry of *drx-InactivityTimer* or in the first symbol after the end of DRX Command MAC CE reception;
 - 3> use the Short DRX Cycle.
 - 2> else:
 - 3> use the Long DRX cycle.
- 1> if *drx-ShortCycleTimer* expires:
 - 2> use the Long DRX cycle.
- 1> if a Long DRX Command MAC CE is received:
 - 2> stop *drx-ShortCycleTimer*;
 - 2> use the Long DRX cycle.
- 1> if the Short DRX Cycle is used, and $[(\text{SFN} \times 10) + \text{subframe number}] \bmod (\text{drx-ShortCycle}) = (\text{drx-StartOffset}) \bmod (\text{drx-ShortCycle})$; or
- 1> if the Long DRX Cycle is used, and $[(\text{SFN} \times 10) + \text{subframe number}] \bmod (\text{drx-LongCycle}) = \text{drx-StartOffset}$:
 - 2> start *drx-onDurationTimer* after *drx-SlotOffset* from the beginning of the subframe.
- 1> if the MAC entity is in Active Time:
 - 2> monitor the PDCCH;
 - 2> if the PDCCH indicates a DL transmission:
 - 3> start the *drx-HARQ-RTT-TimerDL* for the corresponding HARQ process in the first symbol after the end of the corresponding transmission carrying the DL HARQ feedback;
 - 3> stop the *drx-RetransmissionTimerDL* for the corresponding HARQ process.
 - 2> if the PDCCH indicates a UL transmission:
 - 3> start the *drx-HARQ-RTT-TimerUL* for the corresponding HARQ process in the first symbol after the end of the first repetition of the corresponding PUSCH transmission;
 - 3> stop the *drx-RetransmissionTimerUL* for the corresponding HARQ process.
 - 2> if the PDCCH indicates a new transmission (DL or UL):
 - 3> start or restart *drx-InactivityTimer* in the first symbol after the end of the PDCCH reception.

- 1> in current symbol n , if the MAC entity would not be in Active Time considering grants/assignments/DRX Command MAC CE/Long DRX Command MAC CE received and Scheduling Request sent 4 ms prior to symbol n when evaluating all DRX Active Time conditions as specified in this subclause:
 - 2> not transmit periodic SRS and semi-persistent SRS defined in TS 38.214 [7].
- 1> if CSI masking (*csi-Mask*) is setup by upper layers:
 - 2> in current symbol n , if *onDurationTimer* would not be running considering grants/assignments/DRX Command MAC CE/Long DRX Command MAC CE received 4 ms prior to symbol n when evaluating all DRX Active Time conditions as specified in this subclause:
 - 3> not report CSI on PUCCH.
- 1> else:
 - 2> in current symbol n , if the MAC entity would not be in Active Time considering grants/assignments/DRX Command MAC CE/Long DRX Command MAC CE received and Scheduling Request sent 4 ms prior to symbol n when evaluating all DRX Active Time conditions as specified in this subclause:
 - 3> not report CSI on PUCCH and semi-persistent CSI on PUSCH.

Regardless of whether the MAC entity is monitoring PDCCH or not, the MAC entity transmits HARQ feedback, aperiodic CSI on PUSCH, and aperiodic SRS defined in TS 38.214 [7] when such is expected.

The MAC entity needs not to monitor the PDCCH if it is not a complete PDCCH occasion (e.g. the Active Time starts or ends in the middle of a PDCCH occasion).

7.1.1.5.4.3 Test description

7.1.1.5.4.3.1 Pre-test conditions

Same Pre-test conditions as in clause 7.1.1.0 except that set to return no data in uplink.

7.1.1.5.4.3.2 Test procedure sequence

For FDD, *NormalSLT*(current SFN, current subframe, current slot, y)= y ; For TDD, *NormalSLT*(current SFN, current subframe, current slot, y) counts the minimum number of normal slots needed to cover y number of PDCCH-occasions (slots) until next PDCCH-occasion (slot) available, starting from current slot on current SFN.

Table 7.1.1.5.4.3.2-1: Main behaviour

St	Procedure	Message Sequence		TP	Verdict
		U - S	Message		
1	SS transmits NR RRCReconfigurationmessage to configure specific DRX parameters for NR Cell. (Note 1)	<--	NR RRC: <i>RRCReconfiguration</i>	-	-
2	The UE transmits NR RRCReconfigurationComplete message. (Note 2)	-->	NR RRC: <i>RRCReconfigurationComplete</i>	-	-
3	In a PDCCH occasion which is X subframes before the PDCCH occasion in which the <i>drx-onDurationTimer</i> expires, with $X < drx-onDurationTimer-1$, the SS indicates the transmission of a DL MAC PDU on the PDCCH.	<--	MAC PDU	-	-
4	Check: Does the UE transmit a HARQ ACK for the DL MAC PDU in Step 3?	-->	HARQ ACK	1	P
5	In a PDCCH occasion before the <i>drx-onDurationTimer</i> expires, the SS indicates the transmission of a DL MAC PDU on the PDCCH. The SS transmits a DL MAC PDU with DRX MAC Control element. UE successfully decodes the MAC PDU.	<--	MAC PDU (DRX MAC Control element)	-	-
6	Check: Does the UE transmit a HARQ ACK for the DL MAC PDU in Step 5?	-->	HARQ ACK	1	P
6 A	In a PDCCH occasion before the short DRX cycle ends, the SS indicates the transmission of a DL MAC PDU on the PDCCH. The SS transmits a DL MAC PDU	<--	MAC PDU		
6 B	Check: Does the UE transmit a HARQ ACK in step 6B?	-->	HARQ ACK	1	F
7	On the next or later DRX cycle than the one used for Step 3 and on a PDCCH occasion which is X PDCCH sub frames before the PDCCH occasion in which the <i>onDurationTimer</i> expires, with $X < drx-onDurationTimer$, the SS indicates the transmission of a DL MAC PDU. The SS transmits an invalid MAC PDU. (Note 3)	<--	MAC PDU	-	-
8	Check: Does the UE transmit a HARQ NACK for the DL MAC PDU in Step 7?	-->	HARQ NACK	2,3	P
8 A	In a PDCCH occasion before the <i>Drx-HARQ-RTT-TimerDL</i> for the MAC PDU indicated in Step 7 expires, the SS indicates the transmission of a DL MAC PDU on the PDCCH. The SS transmits a DL MAC PDU with DRX MAC Control element.	<--	MAC PDU(DRX MAC Control element)		
8 B	Check: Does the UE transmit a HARQ ACK?	-->	HARQ ACK	2,3	P
9	In a PDCCH occasion which is Z slots before the slot in which the <i>drx-RetransmissionTimerDL</i> for the DL MAC PDU in Step 7 expires, with $1 < Z < drx-RetransmissionTimerDL$, the SS indicates the transmission of a DL MAC PDU. The SS transmits a DL MAC PDU with DRX MAC Control element.	<--	MAC PDU(DRX MAC Control element)	-	-
10	Check: Does the UE transmit a HARQ ACK for the DL MAC PDU in Step 9?	-->	HARQ ACK	2,3,1	P
11	In the last PDCCH occasion when the <i>drx-RetransmissionTimerDL</i> for the DL MAC PDU indicated on the PDCCH in Step 7 is still running, the SS indicates the transmission of a DL MAC PDU.	<--	MAC PDU	-	-
12	Check: Does the UE transmit a HARQ ACK for the DL MAC PDU in Step 11?	-->	HARQ ACK	2,3	P

Note 1:	For EN-DC the NR <i>RRCReconfiguration</i> message is contained in <i>RRCConnectionReconfiguration</i> .
Note 2:	For EN-DC the NR <i>RRCReconfigurationComplete</i> message is contained in <i>RRCConnectionReconfigurationComplete</i> .
Note 3:	Invalid MAC PDU is a MAC PDU that fails the CRC check.
Note 4:	All DL MAC PDUs are transmitted with the NDI set on the PDCCH.
Note 5:	Timer tolerances for the MAC DRX related timers measured in PDCCH occasions (slots). These timers are: <i>drx-InactivityTimer</i> , <i>drx-RetransmissionTimer</i> , <i>Drx-HARQ-RTT-TimerDL</i> .
Note 6:	K is the time for given PDSCH to HARQ feedback of PUCCH and shall be shorter than <i>drx-InactivityTimer</i> . In this TC, the DCI format should be configured to not include the PDSCH-to-HARQ-timing-indicator field. When the UE schedules a PDSCH reception over a number of symbols where the last symbol is within slot n-k, the UE shall provide corresponding HARQ-ACK information in a PUCCH transmission within slot n-k+4 according to TS 38.321 clause 9.2.3. Thus, the maximum value of K is 4 slots in this test case.

7.1.1.5.4.3.3 Specific message contents

Table 7.1.1.5.4.3.3-1: *RRCReconfiguration* (Step 1, Table 7.1.1.5.4.3.2-1)

Derivation Path: 38.508-1 [4], Table 4.6.1-13			
Information Element	Value/remark	Comment	Condition
RRCReconfiguration ::= SEQUENCE {			
criticalExtensions CHOICE {			
rrcReconfiguration SEQUENCE {			
radioBearerConfig	Not present		
secondaryCellGroup	CellGroupConfig	OCTET STRING (CONTAINING CellGroupConfig)	EN-DC
nonCriticalExtension ::= SEQUENCE {}	Not present		EN-DC
nonCriticalExtension ::= SEQUENCE{			NR
masterCellGroup	CellGroupConfig	OCTET STRING (CONTAINING CellGroupConfig)	
dedicatedNAS-MessageList SEQUENCE (SIZE(1..maxDRB)) OF DedicatedNAS-Message {}	Not present		
}			
}			
}			
}			

Table 7.1.1.5.4.3.3-2: *CellGroupConfig* (Table 7.1.1.5.4.3.3-1)

Derivation Path: 38.508-1 [4], Table 4.6.3-n			
Information Element	Value/remark	Comment	Condition
cellGroupConfig ::= SEQUENCE {			
mac-CellGroupConfig SEQUENCE {			
drx-Config CHOICE {			
setup SEQUENCE {			
drx-onDurationTimer	ms40		
drx-InactivityTimer	Ms10		
drx-HARQ-RTT-TimerDL	56		
drx-HARQ-RTT-TimerUL	56		
drx-RetransmissionTimerDL	SI80		
drx-RetransmissionTimerUL	SI80		
drx-LongCycleStartOffset CHOICE {			
ms640	7		
}			
shortDRX SEQUENCE {			
drx-ShortCycle	ms80		
drx-ShortCycleTimer	7		
}			
drx-SlotOffset	ms0		
}			
}			

7.1.1.5.5 DRX operation / Short cycle configured / Long DRX command MAC control element reception

7.1.1.5.5.1 Test Purpose (TP)

(1)

```
with { UE in RRC_CONNECTED state }
ensure that {
  when { short DRX cycle is configured and a long DRX Command MAC control element is received }
    then { UE successfully decodes the MAC control PDU }
}
```

(2)

```
with { UE in RRC_CONNECTED state }
ensure that {
  when { Long DRX cycle and drx-SlotOffset is configured and [(SFN * 10) + subframe number] modulo
drx-LongCycle) = drxStartOffset }
    then { UE starts the OnDurationTimer after drx-SlotOffset and monitors PDCCH for OnDurationTimer
PDCCH-subframes }
}
```

7.1.1.5.5.2 Conformance requirements

References: The conformance requirements covered in the present TC are specified in: TS 38.321, clause 5.7. Unless otherwise stated these are Rel-15 requirements.

[TS 38.321, clause 5.7]

The MAC entity may be configured by RRC with a DRX functionality that controls the UE's PDCCH monitoring activity for the MAC entity's C-RNTI, CS-RNTI, INT-RNTI, SFI-RNTI, SP-CSI-RNTI, TPC-PUCCH-RNTI, TPC-PUSCH-RNTI, and TPC-SRS-RNTI. When using DRX operation, the MAC entity shall also monitor PDCCH according to requirements found in other clauses of this specification. When in RRC_CONNECTED, if DRX is configured, for all the activated Serving Cells, the MAC entity may monitor the PDCCH discontinuously using the DRX operation specified in this clause; otherwise the MAC entity shall monitor the PDCCH as specified in TS 38.213 [6].

RRC controls DRX operation by configuring the following parameters:

- *drx-onDurationTimer*: the duration at the beginning of a DRX Cycle;
- *drx-SlotOffset*: the delay before starting the *drx-onDurationTimer*;
- *drx-InactivityTimer*: the duration after the PDCCH occasion in which a PDCCH indicates a new UL or DL transmission for the MAC entity;
- *drx-RetransmissionTimerDL* (per DL HARQ process except for the broadcast process): the maximum duration until a DL retransmission is received;
- *drx-RetransmissionTimerUL* (per UL HARQ process): the maximum duration until a grant for UL retransmission is received;
- *drx-LongCycleStartOffset*: the Long DRX cycle and *drx-StartOffset* which defines the subframe where the Long and Short DRX Cycle starts;
- *drx-ShortCycle* (optional): the Short DRX cycle;
- *drx-ShortCycleTimer* (optional): the duration the UE shall follow the Short DRX cycle;
- *drx-HARQ-RTT-TimerDL* (per DL HARQ process except for the broadcast process): the minimum duration before a DL assignment for HARQ retransmission is expected by the MAC entity;
- *drx-HARQ-RTT-TimerUL* (per UL HARQ process): the minimum duration before a UL HARQ retransmission grant is expected by the MAC entity.

When a DRX cycle is configured, the Active Time includes the time while:

- *drx-onDurationTimer* or *drx-InactivityTimer* or *drx-RetransmissionTimerDL* or *drx-RetransmissionTimerUL* or *ra-ContentionResolutionTimer* (as described in clause 5.1.5) is running; or
- a Scheduling Request is sent on PUCCH and is pending (as described in clause 5.4.4); or
- a PDCCH indicating a new transmission addressed to the C-RNTI of the MAC entity has not been received after successful reception of a Random Access Response for the Random Access Preamble not selected by the MAC entity among the contention-based Random Access Preamble (as described in clause 5.1.4).

When DRX is configured, the MAC entity shall:

- 1> if a MAC PDU is received in a configured downlink assignment:
 - 2> start the *drx-HARQ-RTT-TimerDL* for the corresponding HARQ process in the first symbol after the end of the corresponding transmission carrying the DL HARQ feedback;
 - 2> stop the *drx-RetransmissionTimerDL* for the corresponding HARQ process.
- 1> if a MAC PDU is transmitted in a configured uplink grant:
 - 2> start the *drx-HARQ-RTT-TimerUL* for the corresponding HARQ process in the first symbol after the end of the first repetition of the corresponding PUSCH transmission;
 - 2> stop the *drx-RetransmissionTimerUL* for the corresponding HARQ process.
- 1> if a *drx-HARQ-RTT-TimerDL* expires:
 - 2> if the data of the corresponding HARQ process was not successfully decoded:
 - 3> start the *drx-RetransmissionTimerDL* for the corresponding HARQ process in the first symbol after the expiry of *drx-HARQ-RTT-TimerDL*.
- 1> if a *drx-HARQ-RTT-TimerUL* expires:
 - 2> start the *drx-RetransmissionTimerUL* for the corresponding HARQ process in the first symbol after the expiry of *drx-HARQ-RTT-TimerUL*.

- 1> if a DRX Command MAC CE or a Long DRX Command MAC CE is received:
 - 2> stop *drx-onDurationTimer*;
 - 2> stop *drx-InactivityTimer*.
- 1> if *drx-InactivityTimer* expires or a DRX Command MAC CE is received:
 - 2> if the Short DRX cycle is configured:
 - 3> start or restart *drx-ShortCycleTimer* in the first symbol after the expiry of *drx-InactivityTimer* or in the first symbol after the end of DRX Command MAC CE reception;
 - 3> use the Short DRX Cycle.
 - 2> else:
 - 3> use the Long DRX cycle.
- 1> if *drx-ShortCycleTimer* expires:
 - 2> use the Long DRX cycle.
- 1> if a Long DRX Command MAC CE is received:
 - 2> stop *drx-ShortCycleTimer*;
 - 2> use the Long DRX cycle.
- 1> if the Short DRX Cycle is used, and $[(SFN \times 10) + \text{subframe number}] \bmod (drx-ShortCycle) = (drx-StartOffset) \bmod (drx-ShortCycle)$; or
- 1> if the Long DRX Cycle is used, and $[(SFN \times 10) + \text{subframe number}] \bmod (drx-LongCycle) = drx-StartOffset$:
 - 2> start *drx-onDurationTimer* after *drx-SlotOffset* from the beginning of the subframe.
- 1> if the MAC entity is in Active Time:
 - 2> monitor the PDCCH as specified in TS 38.213 [6];
 - 2> if the PDCCH indicates a DL transmission:
 - 3> start the *drx-HARQ-RTT-TimerDL* for the corresponding HARQ process in the first symbol after the end of the corresponding transmission carrying the DL HARQ feedback;
 - 3> stop the *drx-RetransmissionTimerDL* for the corresponding HARQ process.
 - 2> if the PDCCH indicates a UL transmission:
 - 3> start the *drx-HARQ-RTT-TimerUL* for the corresponding HARQ process in the first symbol after the end of the first repetition of the corresponding PUSCH transmission;
 - 3> stop the *drx-RetransmissionTimerUL* for the corresponding HARQ process.
 - 2> if the PDCCH indicates a new transmission (DL or UL):
 - 3> start or restart *drx-InactivityTimer* in the first symbol after the end of the PDCCH reception.
- 1> in current symbol *n*, if the MAC entity would not be in Active Time considering grants/assignments/DRX Command MAC CE/Long DRX Command MAC CE received and Scheduling Request sent until 4 ms prior to symbol *n* when evaluating all DRX Active Time conditions as specified in this clause:
 - 2> not transmit periodic SRS and semi-persistent SRS defined in TS 38.214 [7];
 - 2> not report CSI on PUCCH and semi-persistent CSI configured on PUSCH.
- 1> if CSI masking (*csi-Mask*) is setup by upper layers:

2> in current symbol n , if *drx-onDurationTimer* would not be running considering grants/assignments/DRX Command MAC CE/Long DRX Command MAC CE received until 4 ms prior to symbol n when evaluating all DRX Active Time conditions as specified in this clause:

3> not report CSI on PUCCH.

NOTE: If a UE multiplexes a CSI configured on PUCCH with other overlapping UCI(s) according to the procedure specified in TS 38.213 [6] subclause 9.2.5 and this CSI multiplexed with other UCI(s) would be reported on a PUCCH resource outside DRX Active Time, it is up to UE implementation whether to report this CSI multiplexed with other UCI(s).

Regardless of whether the MAC entity is monitoring PDCCH or not, the MAC entity transmits HARQ feedback, aperiodic CSI on PUSCH, and aperiodic SRS defined in TS 38.214 [7] when such is expected.

The MAC entity needs not to monitor the PDCCH if it is not a complete PDCCH occasion (e.g. the Active Time starts or ends in the middle of a PDCCH occasion).

7.1.1.5.5.3 Test Description

7.1.1.5.5.3.1 Pre-test conditions

Same Pre-test conditions as in clause 7.1.1.0 except that set to return no data in uplink.

7.1.1.5.5.3.2 Test procedure sequence

For FDD, $NormalSLT=(current\ SFN, current\ sub-frame, current\ slot, y)=y$; For TDD, $NormalSLT(current\ SFN, current\ slot, y)$ counts the minimum number of normal slots needed to cover y number of PDCCH-occasions (slots) until next PDCCH-occasion(slot) available, starting from current slot on current SFN.

Table 7.1.1.5.5.3.2-1: Main behaviour

St	Procedure	Message Sequence		TP	Verdict
		U - S	Message		
1	SS transmits NR RRCReconfiguration message to configure specific DRX parameters for NR Cell. (Note 1)	<--	NR RRC: <i>RRCReconfiguration</i>	-	-
2	The UE transmits NR RRCReconfigurationComplete message. (Note 2)	-->	NR RRC: <i>RRCReconfigurationComplete</i>	-	-
3	In a PDCCH occasion when the <i>drx-onDurationTimer</i> is running, the SS indicates the transmission of a DL MAC PDU on the PDCCH. The SS transmits a valid MAC PDU. (Note 3)	<--	MAC PDU	-	-
4	Check: Does the UE transmit a HARQ ACK for the DL MAC PDU in Step 3?	-->	HARQ ACK	1	P
4 A	Wait for the expiry of <i>drx-InactivityTimer</i> to ensure that UE starts the Short DRX Cycle.	-	-	-	-
5	In a PDCCH occasion before the <i>drx-onDurationTimer</i> expires, the SS indicates the transmission of a DL MAC PDU on the PDCCH. The SS transmits a DL MAC PDU with Long DRX MAC Control element. UE successfully decodes the MAC PDU.	<--	MAC PDU (Long DRX MAC Control element)	-	-
6	Check: Does the UE transmit a HARQ ACK for the DL MAC PDU in Step 5?	-->	HARQ ACK	1	P
7	In the first PDCCH occasion, after the <i>drx-SlotOffset</i> when the <i>drx-onDurationTimer</i> is running according to $[(SFN * 10) + \text{subframe number}] \bmod \text{drx-LongCycle} = (\text{drx-StartOffset}) \bmod (\text{drx-LongCycle})$, the SS indicates the transmission of a DL MAC PDU on the PDCCH.	<--	MAC PDU	-	-
8	Check: Does the UE transmit a HARQ ACK for the DL MAC PDU in Step 7?	-->	HARQ ACK	2	P
9	At least <i>drx-InactivityTimer</i> PDCCH occasions after the transmission of the MAC PDU in Step 7 has been indicated (This means the next DRX cycle or later after Step 7) in the last PDCCH occasion while the <i>drx-onDurationTimer</i> is still running, the SS indicates the transmission a DL MAC PDU on the PDDCH. (Note 7)	<--	MAC PDU	-	-
10	Check: Does the UE transmit a HARQ ACK for the DL MAC PDU in Step 9?	-->	HARQ ACK	2	P
<p>Note 1: For EN-DC the NR RRCReconfiguration message is contained in RRCConnectionReconfiguration 36.508 [7], Table 4.6.1-8 using condition EN-DC_EmbedNR_RRCRecon.</p> <p>Note 2: For EN-DC the NR RRCReconfigurationComplete message is contained in RRCConnectionReconfigurationComplete.</p> <p>Note 3: The SS assumes that the UE starts in long DRX after configuration.</p> <p>Note 4: All DL MAC PDUs are transmitted with the NDI set on the PDCCH.</p> <p>Note 5: Timer tolerances for the MAC DRX related timers measured in PDCCH occasions (slots). These timers are: <i>drx-InactivityTimer</i>, <i>drx-RetransmissionTimer</i>, <i>Drx-HARQ-RTT-TimerDL</i>.</p> <p>Note 6: Void</p> <p>Note 7: The <i>drx-InactivityTimer</i> is started in the next PDCCH occasion of the PDCCH occasion where DL new transmission is indicated.</p>					

7.1.1.5.5.3.3 Specific message contents

Table 7.1.1.5.5.3.3-1: RRCReconfiguration (Step 1, Table 7.1.1.5.5.3.2-1)

Derivation Path: 38.508-1 [4], Table 4.6.1-13			
Information Element	Value/remark	Comment	Condition
RRCReconfiguration ::= SEQUENCE {			
criticalExtensions CHOICE {			
rrcReconfiguration ::= SEQUENCE {			
radioBearerConfig	RadioBearerConfig with conditions SRB2 and DRB1		NR
secondaryCellGroup	CellGroupConfig		EN-DC
}			
nonCriticalExtension ::= SEQUENCE {			NR
masterCellGroup	CellGroupConfig with condition SRB2_DRB1		NR
}			
}			
}			

Table 7.1.1.5.5.3.3-2: CellGroupConfig (Table 7.1.1.5.5.3.3-1)

Derivation Path: 38.508-1 [4], Table 4.6.3-19			
Information Element	Value/remark	Comment	Condition
cellGroupConfig ::= SEQUENCE {			
mac-CellGroupConfig SEQUENCE {			
drx-Config CHOICE {			
setup SEQUENCE {			
drx-onDurationTimer	ms40		
drx-InactivityTimer	ms10		
drx-HARQ-RTT-TimerDL	56		
drx-HARQ-RTT-TimerUL	56		
drx-RetransmissionTimerDL	sl80		
drx-RetransmissionTimerUL	sl80		
drx-LongCycleStartOffset CHOICE {			
ms640	7		
}			
shortDRX SEQUENCE {			
drx-ShortCycle	ms80		
drx-ShortCycleTimer	7		
}			
drx-SlotOffset	ms0		
}			
}			
}			
}			

7.1.1.6 Semi-Persistent Scheduling

7.1.1.6.1 Correct handling of DL assignment / Semi-persistent case

7.1.1.6.1.1 Test Purpose (TP)

(1)

```

with { UE in RRC_Connected state with DRB established and sps-Configuration in DL is enabled }
ensure that {
  when { UE receives a DL assignment addressed to its stored CS-RNTI in slot y and with NDI set as 0 }
  then {UE starts receiving DL MAC PDU in slots y+n*[semiPersistSchedIntervalDL] where 'n' is
positive integer starting at zero }

```



```

    }

```

(2)

```

with { UE in RRC_Connected state with DRB established and stored DL SPS assignment to receive MAC
PDU in slot  $y+n \cdot [\text{semiPersistSchedIntervalDL}]$  }
ensure that {
  when { UE receives a DL assignment addressed to its CS-RNTI in slot  $p$  and with NDI set as 0, where
 $p \neq y+n \cdot [\text{semiPersistSchedIntervalDL}]$  }
  then { UE starts receiving DL MAC PDU in slots  $p+n \cdot [\text{semiPersistSchedIntervalDL}]$  and stops
receiving DL MAC PDU at slots  $y+n \cdot [\text{semiPersistSchedIntervalDL}]$  where 'n' is positive integer starting
at zero }
}

```

(3)

```

with { UE in RRC_Connected state with DRB established and stored DL SPS assignment to receive MAC
PDU at slot  $p+n \cdot [\text{semiPersistSchedIntervalDL}]$  }
ensure that {
  when { UE receives a DL assignment [for retransmission] addressed to its CS-RNTI in Slot  $z$  and
with NDI set as 1, where  $z \neq p+n \cdot [\text{semiPersistSchedIntervalDL}]$  }
  then { UE receives MAC PDU as per the retransmission grant for CS-RNTI }
}

```

(4)

```

with { UE in RRC_Connected state with DRB established and stored DL SPS assignment to receive MAC
PDU at slot  $y+n \cdot [\text{semiPersistSchedIntervalDL}]$  }
ensure that {
  when { UE receives a DL assignment addressed to its C-RNTI in Slot  $p$ , such that  $p =
y+n \cdot [\text{semiPersistSchedIntervalDL}]$  }
  then { UE receives MAC PDU as per assignment addressed to its C-RNTI }
}

```

(5)

```

with { UE in RRC_Connected state with DRB established and stored DL SPS grant to receive MAC PDU at
slot  $z+n \cdot [\text{semiPersistSchedIntervalDL}]$  }
ensure that {
  when { UE receives a RRC Message including sps-Configuration with sps-ConfigurationDL set as
'disable' and hence resulting in DL SPS grant deactivation }
  then { UE deletes the stored sps-Configuration DL parameters and stops receiving DL MAC PDU's as
per stored SPS assignment in slot  $z+n \cdot [\text{semiPersistSchedIntervalDL}]$  }
}

```

7.1.1.6.1.2 Conformance requirements

References: The conformance requirements covered in the present TC are specified in TS 38.321, clause 5.3.1, 5.8.1 and TS 38.300, clause 10.2. Unless otherwise stated these are Rel-15 requirements.

[TS 38.321, clause 5.3.1]

Downlink assignments received on the PDCCH both indicate that there is a transmission on a DL-SCH for a particular MAC entity and provide the relevant HARQ information.

When the MAC entity has a C-RNTI, Temporary C-RNTI, or CS-RNTI, the MAC entity shall for each PDCCH occasion during which it monitors PDCCH and for each Serving Cell:

- 1> if a downlink assignment for this PDCCH occasion and this Serving Cell has been received on the PDCCH for the MAC entity's C-RNTI, or Temporary C-RNTI:
 - 2> if this is the first downlink assignment for this Temporary C-RNTI:
 - 3> consider the NDI to have been toggled.
 - 2> if the downlink assignment is for the MAC entity's C-RNTI, and if the previous downlink assignment indicated to the HARQ entity of the same HARQ process was either a downlink assignment received for the MAC entity's CS-RNTI or a configured downlink assignment:
 - 3> consider the NDI to have been toggled regardless of the value of the NDI.

- 2> indicate the presence of a downlink assignment and deliver the associated HARQ information to the HARQ entity.
- 1> else if a downlink assignment for this PDCCH occasion has been received for this Serving Cell on the PDCCH for the MAC entity's CS-RNTI:
 - 2> if the NDI in the received HARQ information is 1:
 - 3> consider the NDI for the corresponding HARQ process not to have been toggled;
 - 3> indicate the presence of a downlink assignment for this Serving Cell and deliver the associated HARQ information to the HARQ entity.
 - 2> if the NDI in the received HARQ information is 0:
 - 3> if PDCCH contents indicate SPS deactivation:
 - 4> clear the configured downlink assignment for this Serving Cell (if any);
 - 4> if the timeAlignmentTimer, associated with the TAG containing the Serving Cell on which the HARQ feedback is to be transmitted, is running:
 - 5> indicate a positive acknowledgement for the SPS deactivation to the physical layer.
 - 3> else if PDCCH content indicates SPS activation:
 - 4> store the downlink assignment for this Serving Cell and the associated HARQ information as configured downlink assignment;
 - 4> initialise or re-initialise the configured downlink assignment for this Serving Cell to start in the associated PDSCH duration and to recur according to rules in subclause 5.8.1;

For each Serving Cell and each configured downlink assignment, if configured and activated, the MAC entity shall:

- 1> if the PDSCH duration of the configured downlink assignment does not overlap with the PDSCH duration of a downlink assignment received on the PDCCH for this Serving Cell:
 - 2> instruct the physical layer to receive, in this PDSCH duration, transport block on the DL-SCH according to the configured downlink assignment and to deliver it to the HARQ entity;
 - 2> set the HARQ Process ID to the HARQ Process ID associated with this PDSCH duration;
 - 2> consider the NDI bit for the corresponding HARQ process to have been toggled;
 - 2> indicate the presence of a configured downlink assignment and deliver the stored HARQ information to the HARQ entity.

For configured downlink assignments, the HARQ Process ID associated with the slot where the DL transmission starts is derived from the following equation:

$$\text{HARQ Process ID} = [\text{floor}(\text{CURRENT_slot} \times 10 / (\text{numberOfSlotsPerFrame} \times \text{periodicity}))] \text{ modulo } \text{nrofHARQ-Processes}$$

where $\text{CURRENT_slot} = [(\text{SFN} \times \text{numberOfSlotsPerFrame}) + \text{slot number in the frame}]$ and $\text{numberOfSlotsPerFrame}$ refers to the number of consecutive slots per frame as specified in TS 38.211 [8].

When the MAC entity needs to read BCCH, the MAC entity may, based on the scheduling information from RRC:

- 1> if a downlink assignment for this PDCCH occasion has been received on the PDCCH for the SI-RNTI;
- 2> indicate a downlink assignment and redundancy version for the dedicated broadcast HARQ process to the HARQ entity.

[TS 38.321, clause 5.8.1]

Semi-Persistent Scheduling (SPS) is configured by RRC per Serving Cell and per BWP. Activation and deactivation of the DL SPS are independent among the Serving Cells.

For the DL SPS, a DL assignment is provided by PDCCH, and stored or cleared based on L1 signalling indicating SPS activation or deactivation.

RRC configures the following parameters when SPS is configured:

- *cs-RNTI*: CS-RNTI for activation, deactivation, and retransmission;
- *nrofHARQ-Processes*: the number of configured HARQ processes for SPS;
- *periodicity*: periodicity of configured downlink assignment for SPS.

When SPS is released by upper layers, all the corresponding configurations shall be released.

After a downlink assignment is configured for SPS, the MAC entity shall consider sequentially that the N^{th} downlink assignment occurs in the slot for which:

$$[(\text{numberOfSlotsPerFrame} \times \text{SFN}_{\text{start time}} + \text{slot}_{\text{start time}}) + N \times \text{periodicity} \times \text{numberOfSlotsPerFrame} / 10] \text{ modulo } (1024 \times \text{numberOfSlotsPerFrame})$$

where $\text{SFN}_{\text{start time}}$ and $\text{slot}_{\text{start time}}$ are the SFN and slot, respectively, of the first transmission of PDSCH where the configured downlink assignment was (re-)initialised.

[TS 38.300, clause 10.2]

In the downlink, the gNB can dynamically allocate resources to UEs via the C-RNTI on PDCCH(s). A UE always monitors the PDCCH(s) in order to find possible assignments when its downlink reception is enabled (activity governed by DRX when configured). When CA is configured, the same C-RNTI applies to all serving cells.

The gNB may pre-empt an ongoing PDSCH transmission to one UE with a latency-critical transmission to another UE. The gNB can configure UEs to monitor interrupted transmission indications using INT-RNTI on a PDCCH. If a UE receives the interrupted transmission indication, the UE may assume that no useful information to that UE was carried by the resource elements included in the indication, even if some of those resource elements were already scheduled to this UE.

In addition, with Semi-Persistent Scheduling (SPS), the gNB can allocate downlink resources for the initial HARQ transmissions to UEs: RRC defines the periodicity of the configured downlink assignments while PDCCH addressed to CS-RNTI can either signal and activate the configured downlink assignment, or deactivate it; i.e. a PDCCH addressed to CS-RNTI indicates that the downlink assignment can be implicitly reused according to the periodicity defined by RRC, until deactivated.

NOTE: when required, retransmissions are explicitly scheduled on PDCCH(s).

The dynamically allocated downlink reception overrides the configured downlink assignment in the same serving cell, if they overlap in time. Otherwise a downlink reception according to the configured downlink assignment is assumed, if activated.

When CA is configured, at most one configured downlink assignment can be signalled per serving cell. When BA is configured, at most one configured downlink assignment can be signalled per BWP. On each serving cell, there can be only one configured downlink assignment active at a time, and multiple configured downlink assignment can be simultaneously active on different serving cells only. Activation and deactivation of configured downlink assignments are independent among the serving cells.

7.1.1.6.1.3 Test description

7.1.1.6.1.3.1 Pre-test conditions

Same Pre-test conditions as in clause 7.1.1.0 except that set to return no data in uplink.

7.1.1.6.1.3.2 Test procedure sequence

Table 7.1.1.6.1.3.2-1: Main behaviour

St	Procedure	Message Sequence		TP	Verdict
		U - S	Message		
1	The SS transmits a DL assignment using UE's CS-RNTI in Slot 'Y', NDI=0.	<--	(DL SPS Grant)	-	-
2	The SS transmits in Slot 'Y', a DL MAC PDU containing a RLC PDU (DL-SQN=0) on UM DRB.	<--	MAC PDU	-	-
3	Check: Does the UE transmit a HARQ ACK?	-->	HARQ ACK	1	P
4	The SS transmits in Slot 'Y+X', a DL MAC PDU containing a RLC PDU (DL-SQN=1) on DRB. (Note 1)	<--	MAC PDU	-	-
5	Check: Does the UE transmit a HARQ ACK?	-->	HARQ ACK	1	P
6	The SS transmits a DL assignment using UE's CS-RNTI in Slot 'P', NDI=0; (Where $Y+X < P < Y+2X$)	<--	(DL SPS Grant)	-	-
7	The SS transmits in Slot 'P', a DL MAC PDU containing a RLC PDU (DL-SQN=2) on UM DRB.	<--	MAC PDU	-	-
8	Check: Does the UE transmit a HARQ ACK?	-->	HARQ ACK	2	P
9	The SS transmits in Slot 'Y+2X', a DL MAC PDU containing a RLC PDU (DL-SQN=3) on UM DRB.	<--	MAC PDU	-	-
10	Check: Does the UE transmit a HARQ Feedback?	-->	HARQ ACK/NACK	2	F
11	The SS transmits a DL assignment using UE's C-RNTI in Slot 'P+X', NDI=0.	<--	(DL Grant)	-	-
12	The SS transmits in Slot 'P+X', a DL MAC PDU containing a RLC PDU (DL-SQN=3) on UM DRB. (Note 2)	<--	MAC PDU	-	-
13	Check: Does the UE transmit a HARQ ACK?	-->	HARQ ACK	4	P
14	The SS transmits in Slot 'P+2X', a DL MAC PDU containing a RLC PDU (DL-SQN=4) on UM DRB.	<--	MAC PDU	-	-
15	Check: Does the UE transmit a HARQ ACK?	-->	HARQ ACK	1	P
16	The SS transmits a DL assignment using UE's CS-RNTI in Slot 'P+3X', NDI=0.	<--	(DL SPS Grant)	-	-
17	The SS transmits in Slot 'P+3X', a DL MAC PDU containing 1 RLC PDU's (DL-SQN=5) on UM DRB; CRC is calculated in such a way will result in CRC error in UE.	<--	MAC PDU	-	-
18	Check: Does the UE transmit a HARQ NACK?	-->	HARQ NACK	-	-
-	EXCEPTION: Step 19 and 20 shall be repeated until HARQ retransmission count = 3 is reached for MAC PDU at step 17. (Note 3)	-	-	-	-
19	The SS transmits a DL assignment using UE's CS-RNTI in Slot 'Z', NDI=1; Where $(P+3X < Z < P+4X)$; The DL HARQ process is same as in step 18.	<--	(DL SPS Grant)	-	-
20	The SS re-transmits in Slot 'Z', a DL MAC PDU containing a RLC PDU (DL-SQN=5) on UM DRB.	<--	MAC PDU	-	-
-	EXCEPTION: Up to 3 HARQ NACK from the UE should be allowed at step 21 (Note 3).	-	-	-	-
21	Check: Does the UE transmit a HARQ ACK?	-->	HARQ ACK	3	P
22	SS transmits NR RRCReconfiguration to disable SPS-ConfigurationDL. (Note 4)	<--	RRCConnectionReconfiguration	-	-
23	The UE transmits NR RRCReconfigurationComplete. (Note 5)	-->	RRCConnectionReconfigurationComplete	-	-
24	The SS transmits in Slot 'P+5X', a DL MAC PDU containing 1 RLC PDU's (DL-SQN=7) on UM DRB;	<--	MAC PDU	-	-
25	Check: Does the UE transmit a HARQ Feedback?	-->	HARQ ACK/NACK	5	F

Note 1:	X is equal to semiPersistSchedIntervalDL in this document.
Note 2:	The DL assignment for C-RNTI and hence the size of MAC PDU is different in size than stored CS-RNTI DL assignment in step 6. This assures UE is receiving DSCH data as per DL assignment for C-RNTI and not as per stored grant for CS-RNTI.
Note 3:	The value 4 for the maximum number of HARQ retransmissions has been chosen based on an assumption that, given the radio conditions used in this test case, a UE soft combiner implementation should have sufficient retransmissions to be able to successfully decode the data in its soft buffer.
Note 4:	For EN-DC the NR RRCReconfiguration message is contained in RRCConnectionReconfiguration 36.508 [7], Table 4.6.1-8 using condition EN-DC_EmbedNR_RRCRecon.
Note 5:	For EN-DC the NR RRCReconfigurationComplete message is contained in RRCConnectionReconfigurationComplete.

7.1.1.6.1.3.3 Specific message contents

Table 7.1.1.6.1.3.3-1: RRCReconfiguration (Preamble)

Derivation path: 38.508-1 [4], Table 4.6.1-13			
Information Element	Value/remark	Comment	Condition
RRCReconfiguration ::= SEQUENCE {			
criticalExtensions CHOICE {			
rrcReconfiguration SEQUENCE {			
secondaryCellGroup	CellGroupConfig	OCTET STRING (CONTAINING CellGroupConfig)	EN-DC
nonCriticalExtension ::= SEQUENCE{			NR
masterCellGroup	CellGroupConfig	OCTET STRING (CONTAINING CellGroupConfig)	
}			
}			
}			
}			

Table 7.1.1.6.1.3.3-2: CellGroupConfig (Table 7.1.1.6.1.3.3-2)

Derivation path: 38.508-1 [4], Table 4.6.3-19			
Information Element	Value/remark	Comment	Condition
CellGroupConfig ::= SEQUENCE {			
spCellConfig SEQUENCE {			
servCellIndex	1		
spCellConfigDedicated SEQUENCE {			
initialDownlinkBWP SEQUENCE {			
sps-Config CHOICE {			
setup SEQUENCE {			
periodicity	ms40		
nrofHARQ-Processes	8		
n1PUCCH-AN SEQUENCE{			
pucch-ResourceId	0		
}			
}			
}			
}			
mac-CellGroupConfig SEQUENCE {			
cs-RNTI CHOICE {			
setup SEQUENCE{			
RNTI-Value	'FFE0'H		
}			
}			
}			
}			

Table 7.1.1.6.1.3.3-3: *RRCReconfiguration* (step 22 of Table 7.1.1.6.1.3.2-1)

Derivation path: 38.508-1 [4], Table 4.6.1-13			
Information Element	Value/remark	Comment	Condition
RRCReconfiguration ::= SEQUENCE {			
criticalExtensions CHOICE {			
rrcReconfiguration SEQUENCE {			
secondaryCellGroup	CellGroupConfig	OCTET STRING (CONTAINING CellGroupConfig)	EN-DC
nonCriticalExtension ::= SEQUENCE{			NR
masterCellGroup	CellGroupConfig	OCTET STRING (CONTAINING CellGroupConfig)	
}			
}			
}			
}			

Table 7.1.1.6.1.3.3-4: *CellGroupConfig* (Table 7.1.1.6.1.3.3-3)

Derivation path: 38.508-1 [4], Table 4.6.3-19			
Information Element	Value/remark	Comment	Condition
CellGroupConfig ::= SEQUENCE {			
spCellConfig SEQUENCE {			
servCellIndex	1		
spCellConfigDedicated SEQUENCE {			
initialDownlinkBWP SEQUENCE {			
sps-Config CHOICE {			
release	Null		
}			
}			
}			
}			

7.1.1.6.2 Correct handling of UL grant / configured grant Type 1

7.1.1.6.2.1 Test Purpose (TP)

(1)

```
with { UE in RRC_Connected state with DRB established and sps-Configuration in UL is enabled with
Configured grant type 1 }
ensure that {
  when { The symbol in which equation  $[(SFN \times \text{numberOfSlotsPerFrame} \times \text{numberOfSymbolsPerSlot}) +
(\text{slot number in the frame} \times \text{numberOfSymbolsPerSlot}) + \text{symbol number in the slot}] =
(\text{timeDomainOffset} \times \text{numberOfSymbolsPerSlot} + S + N \times \text{periodicity}) \text{ modulo } (1024 \times
\text{numberOfSlotsPerFrame} \times \text{numberOfSymbolsPerSlot})$  is satisfied }
  then { UE starts transmitting UL MAC PDU periodically in the symbol associated with the new re-
configured grant }
}
```

(2)

```
with { UE in RRC_Connected state with DRB established and configured UL grant type 1 }
ensure that {
  when { UE receives a new UL grant type 1 in an RRC message }
  then { UE starts transmitting UL MAC PDU periodically in the symbol associated with the new re-
configured grant }
}
```

(3)

```

with { UE in RRC_Connected state with DRB established and configured UL grant type 1 }
ensure that {
  when { UE receives a RRC message including sps-Configuration with rrcConfiguredUplinkGrant set as
'release' }
    then { UE deletes the stored configured UL Grant type 1 parameters and stops transmitting UL MAC
PDU's as per configured UL grant type 1 }
}

```

(4)

```

with { UE in RRC_Connected state with DRB established and configured UL grant type 1 }
ensure that {
  when { UE receives a UL grant addressed to its CS-RNTI with NDI set as 1 for retransmission }
    then { UE re-transmits MAC PDU as per the new grant }
}

```

(5)

```

with { UE in RRC_Connected state with DRB established and configured UL grant type 1 }
ensure that {
  when { UE receives a UL grant addressed to its C-RNTI resulting in UL transmission overlap in time
domain as configured grant type 1 }
    then { UE transmits MAC PDU as per grant addressed to its C-RNTI }
}

```

7.1.1.6.2.2 Conformance requirements

References: The conformance requirements covered in the present TC are specified in: 3GPP TS 38.321 clauses 5.4.1 and 5.8.2, 3GPP TS 38.300 clause 10.3. Unless otherwise stated these are Rel-15 requirements.

[TS 38.321, clause 5.4.1]

Uplink grant is either received dynamically on the PDCCH, in a Random Access Response, or configured semi-persistently by RRC. The MAC entity shall have an uplink grant to transmit on the UL-SCH. To perform the requested transmissions, the MAC layer receives HARQ information from lower layers.

If the MAC entity has a C-RNTI, a Temporary C-RNTI, or CS-RNTI, the MAC entity shall for each PDCCH occasion and for each Serving Cell belonging to a TAG that has a running *timeAlignmentTimer* and for each grant received for this PDCCH occasion:

- 1> if an uplink grant for this Serving Cell has been received on the PDCCH for the MAC entity's C-RNTI or Temporary C-RNTI; or
- 1> if an uplink grant has been received in a Random Access Response:
 - 2> if the uplink grant is for MAC entity's C-RNTI and if the previous uplink grant delivered to the HARQ entity for the same HARQ process was either an uplink grant received for the MAC entity's CS-RNTI or a configured uplink grant:
 - 3> consider the NDI to have been toggled for the corresponding HARQ process regardless of the value of the NDI.
 - 2> if the uplink grant is for MAC entity's C-RNTI, and the identified HARQ process is configured for a configured uplink grant:
 - 3> start or restart the *configuredGrantTimer* for the corresponding HARQ process, if configured.
 - 2> deliver the uplink grant and the associated HARQ information to the HARQ entity.
- 1> else if an uplink grant for this PDCCH occasion has been received for this Serving Cell on the PDCCH for the MAC entity's CS-RNTI:
 - 2> if the NDI in the received HARQ information is 1:
 - 3> consider the NDI for the corresponding HARQ process not to have been toggled;
 - 3> start or restart the *configuredGrantTimer* for the corresponding HARQ process, if configured;

- 3> deliver the uplink grant and the associated HARQ information to the HARQ entity.
- 2> else if the NDI in the received HARQ information is 0:
 - 3> if PDCCH contents indicate configured grant Type 2 deactivation:
 - 4> trigger configured uplink grant confirmation.
 - 3> else if PDCCH contents indicate configured grant Type 2 activation:
 - 4> trigger configured uplink grant confirmation;
 - 4> store the uplink grant for this Serving Cell and the associated HARQ information as configured uplink grant;
 - 4> initialise or re-initialise the configured uplink grant for this Serving Cell to start in the associated PUSCH duration and to recur according to rules in subclause 5.8.2;
 - 4> stop the *configuredGrantTimer* for the corresponding HARQ process, if running;

For each Serving Cell and each configured uplink grant, if configured and activated, the MAC entity shall:

- 1> if the PUSCH duration of the configured uplink grant does not overlap with the PUSCH duration of an uplink grant received on the PDCCH or in a Random Access Response for this Serving Cell:
 - 2> set the HARQ Process ID to the HARQ Process ID associated with this PUSCH duration;
- 2> if the *configuredGrantTimer* for the corresponding HARQ process is not running:
 - 3> consider the NDI bit for the corresponding HARQ process to have been toggled;
 - 3> deliver the configured uplink grant and the associated HARQ information to the HARQ entity.

For configured uplink grants, the HARQ Process ID associated with the first symbol of a UL transmission is derived from the following equation:

$$\text{HARQ Process ID} = [\text{floor}(\text{CURRENT_symbol}/\text{periodicity})] \text{ modulo } nrof\text{HARQ-Processes}$$

where $\text{CURRENT_symbol} = (\text{SFN} \times \text{numberOfSlotsPerFrame} \times \text{numberOfSymbolsPerSlot} + \text{slot number in the frame} \times \text{numberOfSymbolsPerSlot} + \text{symbol number in the slot})$, and *numberOfSlotsPerFrame* and *numberOfSymbolsPerSlot* refer to the number of consecutive slots per frame and the number of consecutive symbols per slot, respectively as specified in TS 38.211 [8].

- NOTE 1: *CURRENT_symbol* refers to the symbol index of the first transmission occasion of a repetition bundle that takes place.
- NOTE 2: A HARQ process is configured for a configured uplink grant if the configured uplink grant is activated and the associated HARQ process ID is less than *nrofHARQ-Processes*.
- NOTE 3: If the MAC entity receives both a grant in a Random Access Response and an overlapping grant for its C-RNTI or CS-RNTI, requiring concurrent transmissions on the SpCell, the MAC entity may choose to continue with either the grant for its RA-RNTI or the grant for its C-RNTI or CS-RNTI.

[TS 38.321, clause 5.8.2]

There are two types of transmission without dynamic grant:

- configured grant Type 1 where an uplink grant is provided by RRC, and stored as configured uplink grant;
- configured grant Type 2 where an uplink grant is provided by PDCCH, and stored or cleared as configured uplink grant based on L1 signalling indicating configured uplink grant activation or deactivation.

Type 1 and Type 2 are configured by RRC per Serving Cell and per BWP. Multiple configurations can be active simultaneously only on different Serving Cells. For Type 2, activation and deactivation are independent among the Serving Cells. For the same Serving Cell, the MAC entity is configured with either Type 1 or Type 2.

RRC configures the following parameters when the configured grant Type 1 is configured:

- *cs-RNTI*: CS-RNTI for retransmission;
- *periodicity*: periodicity of the configured grant Type 1;
- *timeDomainOffset*: Offset of a resource with respect to SFN=0 in time domain;
- *timeDomainAllocation*: Allocation of configured uplink grant in time domain which contains *startSymbolAndLength* (i.e. *SLIV* in TS 38.214 [7]);
- *nrofHARQ-Processes*: the number of HARQ processes for configured grant.

RRC configures the following parameters when the configured grant Type 2 is configured:

- *cs-RNTI*: CS-RNTI for activation, deactivation, and retransmission;
- *periodicity*: periodicity of the configured grant Type 2;
- *nrofHARQ-Processes*: the number of HARQ processes for configured grant.

Upon configuration of a configured grant Type 1 for a Serving Cell by upper layers, the MAC entity shall:

- 1> store the uplink grant provided by upper layers as a configured uplink grant for the indicated Serving Cell;
- 1> initialise or re-initialise the configured uplink grant to start in the symbol according to *timeDomainOffset* and *S* (derived from *SLIV* as specified in TS 38.214 [7]), and to reoccur with *periodicity*.

After an uplink grant is configured for a configured grant Type 1, the MAC entity shall consider that the uplink grant recurs associated with each symbol for which:

$$[(SFN \times \text{numberOfSlotsPerFrame} \times \text{numberOfSymbolsPerSlot}) + (\text{slot number in the frame} \times \text{numberOfSymbolsPerSlot}) + \text{symbol number in the slot}] = (\text{timeDomainOffset} \times \text{numberOfSymbolsPerSlot} + S + N \times \text{periodicity}) \text{ modulo } (1024 \times \text{numberOfSlotsPerFrame} \times \text{numberOfSymbolsPerSlot}), \text{ for all } N \geq 0.$$

After an uplink grant is configured for a configured grant Type 2, the MAC entity shall consider that the uplink grant recurs associated with each symbol for which:

$$[(SFN \times \text{numberOfSlotsPerFrame} \times \text{numberOfSymbolsPerSlot}) + (\text{slot number in the frame} \times \text{numberOfSymbolsPerSlot}) + \text{symbol number in the slot}] = [(SFN_{\text{start time}} \times \text{numberOfSlotsPerFrame} \times \text{numberOfSymbolsPerSlot} + \text{slot}_{\text{start time}} \times \text{numberOfSymbolsPerSlot} + \text{symbol}_{\text{start time}}) + N \times \text{periodicity}] \text{ modulo } (1024 \times \text{numberOfSlotsPerFrame} \times \text{numberOfSymbolsPerSlot}), \text{ for all } N \geq 0.$$

where $SFN_{\text{start time}}$, $\text{slot}_{\text{start time}}$, and $\text{symbol}_{\text{start time}}$ are the SFN, slot, and symbol, respectively, of the first transmission opportunity of PUSCH where the configured uplink grant was (re-)initialised.

When a configured uplink grant is released by upper layers, all the corresponding configurations shall be released and all corresponding uplink grants shall be cleared.

The MAC entity shall:

- 1> if the configured uplink grant confirmation has been triggered and not cancelled; and
- 1> if the MAC entity has UL resources allocated for new transmission:
 - 2> instruct the Multiplexing and Assembly procedure to generate an Configured Grant Confirmation MAC CE as defined in subclause 6.1.3.7;
 - 2> cancel the triggered configured uplink grant confirmation.

For a configured grant Type 2, the MAC entity shall clear the configured uplink grant immediately after first transmission of Configured Grant Confirmation MAC CE triggered by the configured uplink grant deactivation.

Retransmissions except for repetition of configured uplink grants use uplink grants addressed to CS-RNTI.

[TS 38.300, clause 10.3]

In the uplink, the gNB can dynamically allocate resources to UEs via the C-RNTI on PDCCH(s). A UE always monitors the PDCCH(s) in order to find possible grants for uplink transmission when its downlink reception is enabled (activity governed by DRX when configured). When CA is configured, the same C-RNTI applies to all serving cells.

In addition, with Configured Grants, the gNB can allocate uplink resources for the initial HARQ transmissions to UEs. Two types of configured uplink grants are defined:

- With Type 1, RRC directly provides the configured uplink grant (including the periodicity).
- With Type 2, RRC defines the periodicity of the configured uplink grant while PDCCH addressed to CS-RNTI can either signal and activate the configured uplink grant, or deactivate it; i.e. a PDCCH addressed to CS-RNTI indicates that the uplink grant can be implicitly reused according to the periodicity defined by RRC, until deactivated.

The dynamically allocated uplink transmission overrides the configured uplink grant in the same serving cell, if they overlap in time. Otherwise an uplink transmission according to the configured uplink grant is assumed, if activated.

Retransmissions other than repetitions are explicitly allocated via PDCCH(s).

When CA is configured, at most one configured uplink grant can be signalled per serving cell. When BA is configured, at most one configured uplink grant can be signalled per BWP. On each serving cell, there can be only one configured uplink grant active at a time. A configured uplink grant for one serving cell can either be of Type 1 or Type 2. For Type 2, activation and deactivation of configured uplink grants are independent among the serving cells. When SUL is configured, a configured uplink grant can only be signalled for one of the 2 ULs of the cell.

7.1.1.6.2.3 Test description

7.1.1.6.2.3.1 Pre-test conditions

Same Pre-test conditions as in clause 7.1.1.0 and UM DRB should be established on NR Cell 1.

7.1.1.6.2.3.2 Test procedure sequence

Table 7.1.1.6.2.3.2-1: Main behaviour

St	Procedure	Message Sequence		TP	Verdict
		U - S	Message		
1	SS transmits NR <i>RRCReconfiguration</i> message to configure UL configured grant type 1 in SFN 900, <i>timeDomainOffset</i> is set to 5. (Note 1)	<--	(NR RRC: <i>RRCReconfiguration</i>)	-	-
2	The UE transmits NR <i>RRCReconfigurationComplete</i> message. (Note 2)	-->	(NR RRC: <i>RRCReconfigurationComplete</i>)	-	-
3	SS transmits a DL MAC PDU containing 4 RLC SDUs of size 96 bytes in SFN 1022 on UM DRB. (Note 3)	<--	MAC PDU (eight RLC SDUs)	-	-
4	Check: Does the UE transmit a MAC PDU containing one RLC SDU in Symbol 'x0', Slot y0', SFN 'z0' after the SFN in step 3 wraps around? Where $[(z0 \times \text{numberOfSlotsPerFrame} \times \text{numberOfSymbolsPerSlot}) + (y0 \times \text{numberOfSymbolsPerSlot}) + x0] = (5 \times \text{numberOfSymbolsPerSlot} + S + 0 \times \text{periodicity}) \text{ modulo } (1024 \times \text{numberOfSlotsPerFrame} \times \text{numberOfSymbolsPerSlot})$. (Note 4)	-->	MAC PDU (one RLC SDU)	1	P
5	Check: Does the UE transmit a MAC PDU containing one RLC SDU in Symbol 'x1', Slot y1', SFN 'z1'?' Where $[(z1 \times \text{numberOfSlotsPerFrame} \times \text{numberOfSymbolsPerSlot}) + (y1 \times \text{numberOfSymbolsPerSlot}) + x1] = (5 \times \text{numberOfSymbolsPerSlot} + S + 1 \times \text{periodicity}) \text{ modulo } (1024 \times \text{numberOfSlotsPerFrame} \times \text{numberOfSymbolsPerSlot})$.	-->	MAC PDU (one RLC SDU)	1	P
6	SS transmits NR <i>RRCReconfiguration</i> message to configure UL configured grant type 1 in SFN 'z1 + 1', <i>timeDomainOffset</i> is set to 35.	<--	(NR RRC: <i>RRCReconfiguration</i>)	-	-
7	The UE transmits NR <i>RRCReconfigurationComplete</i> message.	-->	(NR RRC: <i>RRCReconfigurationComplete</i>)	-	-
8	Check: Does the UE transmit a MAC PDU containing one RLC SDU received in step 4 in Symbol 'x2', Slot y2', SFN 'z2'?' Where $[(z2 \times \text{numberOfSlotsPerFrame} \times \text{numberOfSymbolsPerSlot}) + (y2 \times \text{numberOfSymbolsPerSlot}) + x2] = (5 \times \text{numberOfSymbolsPerSlot} + S + N \times \text{periodicity}) \text{ modulo } (1024 \times \text{numberOfSlotsPerFrame} \times \text{numberOfSymbolsPerSlot})$, $N \geq 2$.	-->	MAC PDU (one RLC SDU)	2	F
9	Check: Does the UE transmit a MAC PDU containing one RLC SDU in Symbol 'x3', Slot y3', SFN 'z3' after the SFN in step 8 wraps around? Where $[(z3 \times \text{numberOfSlotsPerFrame} \times \text{numberOfSymbolsPerSlot}) + (y3 \times \text{numberOfSymbolsPerSlot}) + x3] = (35 \times \text{numberOfSymbolsPerSlot} + S + 0 \times \text{periodicity}) \text{ modulo } (1024 \times \text{numberOfSlotsPerFrame} \times \text{numberOfSymbolsPerSlot})$.	-->	MAC PDU (one RLC SDU)	2	P

10	Check: Does the UE transmit a MAC PDU containing one RLC SDU in Symbol 'x4', Slot y4', SFN 'z4'? Where $[(z4 \times \text{numberOfSlotsPerFrame} \times \text{numberOfSymbolsPerSlot}) + (y4 \times \text{numberOfSymbolsPerSlot}) + x4] = (35 \times \text{numberOfSymbolsPerSlot} + S + 1 \times \text{periodicity}) \text{ modulo } (1024 \times \text{numberOfSlotsPerFrame} \times \text{numberOfSymbolsPerSlot})$.	-->	MAC PDU (one RLC SDU)	2	P
11	SS transmits a UL grant addressed to UE's stored CS-RNTI with NDI set as 1 in Slot 'p0' of PDCCH ($p0 = \text{floor}((y4 + 2) * (\text{PDCCH}_{\text{scs}} / \text{PUSCH}_{\text{scs}}))$), allowing the UE to transmit one loop back SDU.	<--	(UL Grant)	-	-
12	Check: Does the UE transmit a MAC PDU containing the same RLC SDU as in step 10 in Symbol 'S' of Slot 'q' of PUSCH? i.e., in the PUSCH slot $q = \text{floor}(p0 * (\text{PUSCH}_{\text{scs}} / \text{PDCCH}_{\text{scs}})) + K_2$ (Note 5)	-->	MAC PDU (one RLC SDU)	4	P
13	Check: Does the UE transmit a MAC PDU containing one RLC SDU in Symbol 'x5', Slot y5', SFN 'z5'? Where $[(z5 \times \text{numberOfSlotsPerFrame} \times \text{numberOfSymbolsPerSlot}) + (y5 \times \text{numberOfSymbolsPerSlot}) + x5] = (35 \times \text{numberOfSymbolsPerSlot} + S + 2 \times \text{periodicity}) \text{ modulo } (1024 \times \text{numberOfSlotsPerFrame} \times \text{numberOfSymbolsPerSlot})$.	-->	MAC PDU (one RLC SDU)	1	P
14	SS transmits a UL Grant using UE's C-RNTI in in Slot 'p1' of PDCCH allowing UE to transmit a MAC PDU containing one RLC SDU, where $p1 = \text{floor}((z6 \times \text{numberOfSlotsPerFrame} - K_2) * (\text{PDCCH}_{\text{scs}} / \text{PUSCH}_{\text{scs}}))$. (Note 6) Where $[(z6 \times \text{numberOfSlotsPerFrame} \times \text{numberOfSymbolsPerSlot}) + (y6 \times \text{numberOfSymbolsPerSlot}) + x6] = (35 \times \text{numberOfSymbolsPerSlot} + S + 3 \times \text{periodicity}) \text{ modulo } (1024 \times \text{numberOfSlotsPerFrame} \times \text{numberOfSymbolsPerSlot})$.	<--	(UL Grant)	-	-
15	Check: Does the UE transmit a MAC PDU containing one RLC SDU in Symbol 'x6', Slot y6', SFN 'z6'?	-->	MAC PDU (one RLC SDU)	5	P
16	Check: Does the UE transmit a MAC PDU containing one RLC SDU in Symbol 'x7', Slot y7', SFN 'z7'?' Where $[(z7 \times \text{numberOfSlotsPerFrame} \times \text{numberOfSymbolsPerSlot}) + (y7 \times \text{numberOfSymbolsPerSlot}) + x7] = (35 \times \text{numberOfSymbolsPerSlot} + S + 4 \times \text{periodicity}) \text{ modulo } (1024 \times \text{numberOfSlotsPerFrame} \times \text{numberOfSymbolsPerSlot})$.	-->	MAC PDU (one RLC SDU)	1	P
17	After step 16, SS transmits NR <i>RRCReconfiguration</i> message to release UL configured grant type 1 in SFN 'z4 + 1'.	<--	(NR RRC: <i>RRCReconfiguration</i>)	-	-
18	The UE transmits NR <i>RRCReconfigurationComplete</i> message.	-->	(NR RRC: <i>RRCReconfigurationComplete</i>)	-	-
19	SS transmits a DL MAC PDU containing one RLC SDU of size 96 bytes in SFN 'z7 + 10'.	<--	MAC PDU (one RLC SDU)		
20	Check: Does the UE transmit a MAC PDU	-->	MAC PDU (one RLC SDU)	3	F

	containing one RLC SDU in Symbol 'x8', Slot y8', SFN 'z8'? Where $[(z8 \times numberOfSlotsPerFrame \times numberOfSymbolsPerSlot) + (y8 \times numberOfSymbolsPerSlot) + x8] = (35 \times numberOfSymbolsPerSlot + S + 8 \times periodicity) \text{ modulo } (1024 \times numberOfSlotsPerFrame \times numberOfSymbolsPerSlot).$			
Note 1: For EN-DC the NR <i>RRConfigReconfiguration</i> message is contained in <i>RRConfigReconfiguration</i> . Note 2: For EN-DC the NR <i>RRConfigReconfigurationComplete</i> message is contained in <i>RRConfigReconfigurationComplete</i> . Note 3: According to the setting parameters in Table 7.1.1.6.2.3.3-2, TB size for configured grant type 1 is 808 bits, which is enough to allow the UE to transmit one PDU at a time (96 bytes RLC SDU + 1 byte UM RLC Header + 2 bytes MAC Sub PDU header + 2 bytes for short BSR or padding). Note 4: S is the starting symbol relative to the slot of the first PUSCH transmission for new configured grant type 1. The value of S can be obtained from TS 38.508-1 [4], Table 4.6.3-122. Note 5: q is the slot where the UE shall transmit the PUSCH and is determined by q_2 as $q_2 = \left\lfloor \frac{\Omega \cdot \frac{\mu_{PUSCH}}{\mu_{PDCCH}}}{2} \right\rfloor + 2$ where Ω is the slot with the scheduling DCI, q_2 is based on the numerology of PUSCH. S is the starting symbol relative to the start of the slot q according to TS 38.214 clause 6.1.2.1. Note 6: The UL grant addressed to C-RNTI should result in UL transmission overlap in time domain as configured grant type 1.				

7.1.1.6.2.3.3 Specific message contents

Table 7.1.1.6.2.3.3-1: *RRConfigReconfiguration* (step 1 and step 6, Table 7.1.1.6.2.3.2-1)

Derivation path: 38.508-1 [4], Table 4.6.1-13			
Information Element	Value/remark	Comment	Condition
<i>RRConfigReconfiguration</i> ::= SEQUENCE {			
criticalExtensions CHOICE {			
rrcReconfiguration SEQUENCE {			
radioBearerConfig	Not present		
secondaryCellGroup	CellGroupConfig	OCTET STRING (CONTAINING CellGroupConfig)	EN-DC
nonCriticalExtension ::= SEQUENCE {}	Not present		EN-DC
nonCriticalExtension ::= SEQUENCE {}			NR
masterCellGroup	CellGroupConfig	OCTET STRING (CONTAINING CellGroupConfig)	
dedicatedNAS-MessageList SEQUENCE (SIZE(1..maxDRB)) OF DedicatedNAS-Message {}	Not present		
}			
}			
}			
}			

Table 7.1.1.6.2.3.3-2: CellGroupConfig (Table 7.1.1.6.2.3.3-2: RRCReconfiguration)

Derivation path: 38.508-1 [4], Table 4.6.3-19			
Information Element	Value/remark	Comment	Condition
CellGroupConfig ::= SEQUENCE {			
rlc-BearerToAddModList	Not present		
mac-CellGroupConfig	Not present		
physicalCellGroupConfig SEQUENCE {			
cs-RNTI CHOICE {			
setup SEQUENCE{			
RNTI-Value	'FFE0'H		
}			
}			
}			
spCellConfig SEQUENCE{			
servCellIndex	Not present		NR
	1		EN-DC
reconfigurationWithSync	Not present		
spCellConfigDedicated SEQUENCE{			
uplinkConfig SEQUENCE {			
initialUplink SEQUENCE {			
pucch-Config CHOICE {			
setup SEQUENCE {			
schedulingRequestResourceToAddModList {			
schedulingRequestResourceId	1		
schedulingRequestID	0		
periodicityAndOffset CHOICE {			
sl20	10		
}			
}			
}			
}			
configuredGrantConfig CHOICE {			
setup SEQUENCE {			
cg-DMRS-Configuration	DMRS-UplinkConfig	Reference TS 38.508-1[4], Table 4.6.3-51	
}			
uci-OnPUSCH CHOICE {			
setup SEQUENCE {			
semiStatic SEQUENCE {	BetaOffsets		
betaOffsetACK-Index1	9		
betaOffsetACK-Index2	9		
betaOffsetACK-Index3	9		
betaOffsetCSI-Part1-Index1	6		
betaOffsetCSI-Part1-Index2	6		
betaOffsetCSI-Part2-Index1	6		
betaOffsetCSI-Part2-Index2	6		
}			
}			
}			
resourceAllocation	ResourceAllocationType 1		
powerControlLoopToUse	n0		
p0-PUSCH-Alpha	1		
nrofHARQ-Processes	16		
repK	n1		
periodicity	Sym40x14		15kHz
periodicity	Sym80x14		30kHz
periodicity	Sym160x14		60kHz
periodicity	Sym320x14		120kHz
rrc-ConfiguredUplinkGrant SEQUENCE{			

timeDomainOffset	5		For Step 1
	35		For Step 6
timeDomainAllocation	0	Reference TS 38.508-1 [4], Table 4.6.3-122	
frequencyDomainAllocation	BIT STRING (SIZE(18))	BIT STRING (SIZE(18), Equal to NBWPsize * (LRB-1) + RBstart), where LRB = 2 PRB, RBstart = 0, NBWPsize is the size [PRBs] of the active carrier bandwidth part and obtained in TS.38.508-1 [4] clause 4.3.1.1.	FR1_FDD, FR1_TDD
frequencyDomainAllocation	BIT STRING (SIZE(18))	BIT STRING (SIZE(18), Equal to NBWPsize * (LRB-1) + RBstart), where LRB=9 PRB, RBstart = 0 and NBWPsize is the size [PRBs] of the active carrier bandwidth part and obtained in TS.38.508-1 [4] clause 4.3.1.2.	FR2_TDD
antennaPort	0		
precodingAndNumberOfLayers	0		
srs-ResourceIndicator	Not present		
mcsAndTBS	18		FR1_FDD, FR1_TDD
	25		FR2_TDD
pathlossReferenceIndex	0		
}			
}			
}			
pusch-Config CHOICE {			
setup SEQUENCE {			
PUSCH-TimeDomainResourceAllocationList SEQUENCE {			
k2	n8		FR1 and FR2
mappingType	typeB		
startSymbolAndLength	0011011	Start symbol(S)=0, Length(L)=14	FR1
startSymbolAndLength	0001110	S=0, L=2	FR2
}			
}			
}			
}			
}			
}			
}			
}			
}			

Table 7.1.1.6.2.3.3-3: RRCReconfiguration (step 11, Table 7.1.1.6.2.3.2-1)

Derivation path: 38.508-1 [4], Table 4.6.1-13			
Information Element	Value/remark	Comment	Condition
RRCReconfiguration ::= SEQUENCE {			
criticalExtensions CHOICE {			
rrcReconfiguration SEQUENCE {			
radioBearerConfig	Not present		
secondaryCellGroup	CellGroupConfig	OCTET STRING (CONTAINING CellGroupConfig)	EN-DC
nonCriticalExtension ::= SEQUENCE { }	Not present		EN-DC
nonCriticalExtension ::= SEQUENCE { }			NR
masterCellGroup	CellGroupConfig	OCTET STRING (CONTAINING CellGroupConfig)	
dedicatedNAS-MessageList SEQUENCE (SIZE(1..maxDRB)) OF DedicatedNAS-Message { }	Not present		
}			
}			
}			
}			

Table 7.1.1.6.2.3.3-4: CellGroupConfig (Table 7.1.1.6.2.3.3-3: RRCReconfiguration)

Derivation path: 38.508-1 [4], Table 4.6.3-19			
Information Element	Value/remark	Comment	Condition
CellGroupConfig ::= SEQUENCE {			
spCellConfig SEQUENCE {			
spCellConfigDedicated SEQUENCE {			
uplinkConfig SEQUENCE {			
initialUplink SEQUENCE {			
configuredGrantConfig CHOICE {			
release	Null		
}			
}			
}			
}			
}			
}			

7.1.1.6.3 Correct handling of UL grant / configured grant Type 2

7.1.1.6.3.1 Test Purpose (TP)

(1)

```
with { UE in RRC_Connected state with DRB established and sps-Configuration in UL is enabled }
ensure that {
  when { UE receives a UL configured grant type 2 addressed to its stored CS-CRNTI with NDI set as 0 }
  then { UE starts transmitting UL MAC PDU periodically in the symbol associated with the
         configured grant }
}
```

(2)

```
with { UE in RRC_Connected state with DRB established and configured UL grant type 2 }
ensure that {
  when { UE receives a UL grant addressed to its CS-CRNTI with NDI set as 0 }
  then { UE starts transmitting UL MAC PDU periodically in the symbol associated with the new re-
         configured grant }
}
```

(3)

```

with { UE in RRC_Connected state with DRB established and configured UL grant type 2 }
ensure that {
  when { UE receives a UL grant addressed to its CS-CRNTI with NDI set as 1 for retransmission }
  then { UE re-transmits MAC PDU as per the new grant }
}

```

(4)

```

with{ UE in RRC_Connected state with DRB established and configured UL grant type 2 }
ensure that {
  when { UE receives a UL grant addressed to its C-RNTI resulting in UL transmission overlap in time
domain as configured grant type 2 }
  then { UE transmits MAC PDU as per grant addressed to its C-RNTI }
}

```

(5)

```

with { UE in RRC_Connected state with DRB established and configured UL grant type 2 }
ensure that {
  when {UE receives a RRC message including sps-Configuration with sps-ConfigurationUL set as
'disable' and hence resulting in UL SPS grant deactivation }
  then { UE deletes the stored sps-Configuration UL parameters and stops transmitting UL MAC PDU's
as per configured UL grant type 2 }
}

```

(6)

```

with{ UE in RRC_Connected state with DRB established and configured UL grant type 2 }
ensure that {
  when{ If in the symbol in which UL Configured Grant type 2 is available but the HARQ buffer is
empty (no data for transmission) }
  then{ UE ignores the UL configured grant type 2 and does not send any MAC PDU }
}

```

7.1.1.6.3.2 Conformance requirements

References: The conformance requirements covered in the present TC are specified in: 3GPP TS 38.321 clauses 5.4.1 and 5.8.2, 3GPP TS 38.300 clauses 10.3. Unless otherwise stated these are Rel-15 requirements.

[TS 38.321, clause 5.4.1]

Uplink grant is either received dynamically on the PDCCH, in a Random Access Response, or configured semi-persistently by RRC. The MAC entity shall have an uplink grant to transmit on the UL-SCH. To perform the requested transmissions, the MAC layer receives HARQ information from lower layers.

If the MAC entity has a C-RNTI, a Temporary C-RNTI, or CS-RNTI, the MAC entity shall for each PDCCH occasion and for each Serving Cell belonging to a TAG that has a running *timeAlignmentTimer* and for each grant received for this PDCCH occasion:

- 1> if an uplink grant for this Serving Cell has been received on the PDCCH for the MAC entity's C-RNTI or Temporary C-RNTI; or
- 1> if an uplink grant has been received in a Random Access Response:
 - 2> if the uplink grant is for MAC entity's C-RNTI and if the previous uplink grant delivered to the HARQ entity for the same HARQ process was either an uplink grant received for the MAC entity's CS-RNTI or a configured uplink grant:
 - 3> consider the NDI to have been toggled for the corresponding HARQ process regardless of the value of the NDI.
 - 2> if the uplink grant is for MAC entity's C-RNTI, and the identified HARQ process is configured for a configured uplink grant:
 - 3> start or restart the *configuredGrantTimer* for the corresponding HARQ process, if configured.
- 2> deliver the uplink grant and the associated HARQ information to the HARQ entity.

- 1> else if an uplink grant for this PDCCH occasion has been received for this Serving Cell on the PDCCH for the MAC entity's CS-RNTI:
 - 2> if the NDI in the received HARQ information is 1:
 - 3> consider the NDI for the corresponding HARQ process not to have been toggled;
 - 3> start or restart the *configuredGrantTimer* for the corresponding HARQ process, if configured;
 - 3> deliver the uplink grant and the associated HARQ information to the HARQ entity.
 - 2> else if the NDI in the received HARQ information is 0:
 - 3> if PDCCH contents indicate configured grant Type 2 deactivation:
 - 4> trigger configured uplink grant confirmation.
 - 3> else if PDCCH contents indicate configured grant Type 2 activation:
 - 4> trigger configured uplink grant confirmation;
 - 4> store the uplink grant for this Serving Cell and the associated HARQ information as configured uplink grant;
 - 4> initialise or re-initialise the configured uplink grant for this Serving Cell to start in the associated PUSCH duration and to recur according to rules in subclause 5.8.2;
 - 4> stop the *configuredGrantTimer* for the corresponding HARQ process, if running;

For each Serving Cell and each configured uplink grant, if configured and activated, the MAC entity shall:

- 1> if the PUSCH duration of the configured uplink grant does not overlap with the PUSCH duration of an uplink grant received on the PDCCH or in a Random Access Response for this Serving Cell:
 - 2> set the HARQ Process ID to the HARQ Process ID associated with this PUSCH duration;
- 2> if the *configuredGrantTimer* for the corresponding HARQ process is not running:
 - 3> consider the NDI bit for the corresponding HARQ process to have been toggled;
 - 3> deliver the configured uplink grant and the associated HARQ information to the HARQ entity.

For configured uplink grants, the HARQ Process ID associated with the first symbol of a UL transmission is derived from the following equation:

$$\text{HARQ Process ID} = [\text{floor}(\text{CURRENT_symbol}/\text{periodicity})] \text{ modulo } n_{\text{rofHARQ-Processes}}$$

where $\text{CURRENT_symbol} = (\text{SFN} \times \text{numberOfSlotsPerFrame} \times \text{numberOfSymbolsPerSlot} + \text{slot number in the frame} \times \text{numberOfSymbolsPerSlot} + \text{symbol number in the slot})$, and *numberOfSlotsPerFrame* and *numberOfSymbolsPerSlot* refer to the number of consecutive slots per frame and the number of consecutive symbols per slot, respectively as specified in TS 38.211 [8].

- NOTE 1: *CURRENT_symbol* refers to the symbol index of the first transmission occasion of a repetition bundle that takes place.
- NOTE 2: A HARQ process is configured for a configured uplink grant if the configured uplink grant is activated and the associated HARQ process ID is less than *nrofHARQ-Processes*.
- NOTE 3: If the MAC entity receives both a grant in a Random Access Response and an overlapping grant for its C-RNTI or CS-RNTI, requiring concurrent transmissions on the SpCell, the MAC entity may choose to continue with either the grant for its RA-RNTI or the grant for its C-RNTI or CS-RNTI.

[TS 38.321, clause 5.8.2]

There are two types of transmission without dynamic grant:

- configured grant Type 1 where an uplink grant is provided by RRC, and stored as configured uplink grant;

- configured grant Type 2 where an uplink grant is provided by PDCCH, and stored or cleared as configured uplink grant based on L1 signalling indicating configured uplink grant activation or deactivation.

Type 1 and Type 2 are configured by RRC per Serving Cell and per BWP. Multiple configurations can be active simultaneously only on different Serving Cells. For Type 2, activation and deactivation are independent among the Serving Cells. For the same Serving Cell, the MAC entity is configured with either Type 1 or Type 2.

RRC configures the following parameters when the configured grant Type 1 is configured:

- *cs-RNTI*: CS-RNTI for retransmission;
- *periodicity*: periodicity of the configured grant Type 1;
- *timeDomainOffset*: Offset of a resource with respect to SFN=0 in time domain;
- *timeDomainAllocation*: Allocation of configured uplink grant in time domain which contains *startSymbolAndLength* (i.e. *SLIV* in TS 38.214 [7]);
- *nrofHARQ-Processes*: the number of HARQ processes for configured grant.

RRC configures the following parameters when the configured grant Type 2 is configured:

- *cs-RNTI*: CS-RNTI for activation, deactivation, and retransmission;
- *periodicity*: periodicity of the configured grant Type 2;
- *nrofHARQ-Processes*: the number of HARQ processes for configured grant.

Upon configuration of a configured grant Type 1 for a Serving Cell by upper layers, the MAC entity shall:

- 1> store the uplink grant provided by upper layers as a configured uplink grant for the indicated Serving Cell;
- 1> initialise or re-initialise the configured uplink grant to start in the symbol according to *timeDomainOffset* and *S* (derived from *SLIV* as specified in TS 38.214 [7]), and to reoccur with *periodicity*.

After an uplink grant is configured for a configured grant Type 1, the MAC entity shall consider that the uplink grant recurs associated with each symbol for which:

$$[(\text{SFN} \times \text{numberOfSlotsPerFrame} \times \text{numberOfSymbolsPerSlot}) + (\text{slot number in the frame} \times \text{numberOfSymbolsPerSlot}) + \text{symbol number in the slot}] = (\text{timeDomainOffset} \times \text{numberOfSymbolsPerSlot} + S + N \times \text{periodicity}) \text{ modulo } (1024 \times \text{numberOfSlotsPerFrame} \times \text{numberOfSymbolsPerSlot}), \text{ for all } N \geq 0.$$

After an uplink grant is configured for a configured grant Type 2, the MAC entity shall consider that the uplink grant recurs associated with each symbol for which:

$$[(\text{SFN} \times \text{numberOfSlotsPerFrame} \times \text{numberOfSymbolsPerSlot}) + (\text{slot number in the frame} \times \text{numberOfSymbolsPerSlot}) + \text{symbol number in the slot}] = [(\text{SFN}_{\text{start time}} \times \text{numberOfSlotsPerFrame} \times \text{numberOfSymbolsPerSlot} + \text{slot}_{\text{start time}} \times \text{numberOfSymbolsPerSlot} + \text{symbol}_{\text{start time}}) + N \times \text{periodicity}] \text{ modulo } (1024 \times \text{numberOfSlotsPerFrame} \times \text{numberOfSymbolsPerSlot}), \text{ for all } N \geq 0.$$

where $\text{SFN}_{\text{start time}}$, $\text{slot}_{\text{start time}}$, and $\text{symbol}_{\text{start time}}$ are the SFN, slot, and symbol, respectively, of the first transmission opportunity of PUSCH where the configured uplink grant was (re-)initialised.

When a configured uplink grant is released by upper layers, all the corresponding configurations shall be released and all corresponding uplink grants shall be cleared.

The MAC entity shall:

- 1> if the configured uplink grant confirmation has been triggered and not cancelled; and
- 1> if the MAC entity has UL resources allocated for new transmission:
 - 2> instruct the Multiplexing and Assembly procedure to generate a Configured Grant Confirmation MAC CE as defined in subclause 6.1.3.7;

2> cancel the triggered configured uplink grant confirmation.

For a configured grant Type 2, the MAC entity shall clear the configured uplink grant immediately after first transmission of Configured Grant Confirmation MAC CE triggered by the configured uplink grant deactivation.

Retransmissions except for repetition of configured uplink grants use uplink grants addressed to CS-RNTI.

[TS 38.300, clause 10.3]

In the uplink, the gNB can dynamically allocate resources to UEs via the C-RNTI on PDCCH(s). A UE always monitors the PDCCH(s) in order to find possible grants for uplink transmission when its downlink reception is enabled (activity governed by DRX when configured). When CA is configured, the same C-RNTI applies to all serving cells.

In addition, with Configured Grants, the gNB can allocate uplink resources for the initial HARQ transmissions to UEs. Two types of configured uplink grants are defined:

- With Type 1, RRC directly provides the configured uplink grant (including the periodicity).
- With Type 2, RRC defines the periodicity of the configured uplink grant while PDCCH addressed to CS-RNTI can either signal and activate the configured uplink grant, or deactivate it; i.e. a PDCCH addressed to CS-RNTI indicates that the uplink grant can be implicitly reused according to the periodicity defined by RRC, until deactivated.

The dynamically allocated uplink transmission overrides the configured uplink grant in the same serving cell, if they overlap in time. Otherwise an uplink transmission according to the configured uplink grant is assumed, if activated.

Retransmissions other than repetitions are explicitly allocated via PDCCH(s).

When CA is configured, at most one configured uplink grant can be signalled per serving cell. When BA is configured, at most one configured uplink grant can be signalled per BWP. On each serving cell, there can be only one configured uplink grant active at a time. A configured uplink grant for one serving cell can either be of Type 1 or Type 2. For Type 2, activation and deactivation of configured uplink grants are independent among the serving cells. When SUL is configured, a configured uplink grant can only be signalled for one of the 2 ULs of the cell.

7.1.1.6.3.3 Test description

7.1.1.6.3.3.1 Pre-test conditions

Same Pre-test conditions as in clause 7.1.1.0 and UM DRB should be established on NR Cell 1. The loop back size is set to accommodate one RLC SDU in UL of same size as one RLC SDU in DL and 1 byte MAC subheader for Configured Grant Confirmation MAC CE.

7.1.1.6.3.3.2 Test procedure sequence

Table 7.1.1.6.3.3.2-1: Main behaviour

St	Procedure	Message Sequence		TP	Verdict
		U - S	Message		
1	SS transmits NR <i>RRCReconfiguration</i> message to configure UL configured grant type 2. (Note 1)	<--	(NR RRC: <i>RRCReconfiguration</i>)	-	-
2	The UE transmits NR <i>RRCReconfigurationComplete</i> message. (Note 2)	-->	(NR RRC: <i>RRCReconfigurationComplete</i>)	-	-
3	SS transmits a DL MAC PDU containing 6 RLC SDUs on UM DRB.	<--	MAC PDU	-	-
4	The UE transmits a Scheduling Request, indicating that loop back SDUs are ready for transmission in UL RLC.	-->	(SR)	-	-
5	SS transmits a UL configured grant type 2 addressed to UE's stored CS-RNTI in Slot 'n' of PDCCH, NDI=0, allowing the UE to transmit one loop back SDU and 1 byte MAC subheader for Configured Grant Confirmation MAC CE.	<--	(UL SPS Grant)	-	-
6	Check: Does the UE transmit a MAC PDU containing one RLC SDU and a Configured Grant Confirmation MAC CE in Symbol 'S' of Slot 'y' of PUSCH as per grant in step 5? i.e., in the PUSCH slot $y = \text{floor} (n * (\text{PUSCH}_{\text{scs}} / \text{PDCCH}_{\text{scs}})) + K_2$. (Note 3)	-->	MAC PDU	1	P
7	Check: Does the UE transmit a MAC PDU containing one RLC SDU in Symbol 'S' of Slot 'y + x' of PUSCH as per grant in step 5? (Note 4)	-->	MAC PDU	1	P
8	SS transmits a UL configured grant type 2 addressed to UE's stored CS-RNTI in Slot 'p' of PDCCH ($p = \text{floor} (p_0 * (\text{PDCCH}_{\text{scs}} / \text{PUSCH}_{\text{scs}}))$), NDI = 0, allowing the UE to transmit one loop back SDU and 1 byte MAC subheader for Configured Grant Confirmation MAC CE, Where p_0 is the slot of PUSCH with $y + x < p_0 < y + 2x - K_2$.	<--	(UL SPS Grant)	-	-
9	Check: Does the UE transmit a MAC PDU containing one RLC SDU and 1 byte MAC subheader for Configured Grant Confirmation MAC CE in Symbol 'S' of Slot 'z' of PUSCH as per grant in step 8? i.e., in the PUSCH slot $z = \text{floor} (p * (\text{PUSCH}_{\text{scs}} / \text{PDCCH}_{\text{scs}})) + K_2$. (Note 3)	-->	MAC PDU	2	P
10	Check: Does the UE transmit a MAC PDU containing one RLC SDU in Symbol 'S' of Slot 'y + 2x' as per grant in step 5?	-->	MAC PDU	2	F
11	Check: Does the UE transmit a MAC PDU containing one RLC SDU in Symbol 'S' of Slot 'z + x' of PUSCH as per grant in step 8?	-->	MAC PDU	2	P
12	SS transmits a UL configured grant type 2 addressed to UE's stored CS-RNTI in Slot 'q' of PDCCH ($q = \text{floor} (q_0 * (\text{PDCCH}_{\text{scs}} / \text{PUSCH}_{\text{scs}}))$), NDI = 1; allowing the UE to transmit one loop back SDU. The UL HARQ process is the same as in step 11, Where q_0 is the slot of PUSCH with $z + x < q_0 < z + 2x - K_2$.	<--	(UL SPS Grant)	-	-
13	Check: Does the UE transmit a MAC PDU containing the same RLC SDU as in step 11 in Symbol 'S' of Slot 'w' of PUSCH?	-->	MAC PDU	3	P

	i.e., in the PUSCH slot $w = \text{floor} (q * (\text{PUSCH}_{\text{scs}} / \text{PDCCH}_{\text{scs}})) + K_2$. (Note 3)				
14	Check: Does the UE transmit a MAC PDU containing one RLC SDU in Symbol 'S' of Slot 'z + 2x' of PUSCH as per grant in step 8?	-->	MAC PDU	1	P
15	SS transmits a UL Grant using UE's C-RNTI in in Slot 'r' of PDCCH allowing UE to transmit a MAC PDU containing one RLC SDU, where $r = \text{floor} ((z + 3x - K_2) * (\text{PDCCH}_{\text{scs}} / \text{PUSCH}_{\text{scs}}))$.	<--	(UL Grant)	-	-
16	Check: Does the UE transmit a MAC PDU containing one RLC SDU in Symbol 'S' of Slot 'z + 3x' of PUSCH as per grant in step 8?	-->	MAC PDU	4	P
17	Check: Does the UE transmit a MAC PDU in Slot 'z + 4x' as per grant in containing zero MAC SDU? (Note 5)	-->	MAC PDU	6	F
18	SS transmits a DL MAC PDU containing 1 RLC SDU on UM DRB after step 17.	<--	MAC PDU		
19	Check: Does the UE transmit a MAC PDU containing one RLC SDU in Symbol 'S' of Slot 'z + 5x' of PUSCH as per grant in step 8?	-->	MAC PDU	1	P
20	SS transmits <i>RRCReconfiguration</i> to disable UL configured grant type 2.	<--	NR RRC: <i>RRCReconfiguration</i>	-	-
21	The UE transmits <i>RRCReconfigurationComplete</i> .	-->	NR RRC: <i>RRCReconfigurationComplete</i>	-	-
22	SS transmits a DL MAC PDU containing 1 RLC SDU.	<--	MAC PDU	-	-
23	Check: Does the UE transmit a MAC PDU in Symbol 'S' of Slot 'z + 6x' of PUSCH as per grant in step 8.	-->	MAC PDU	5	F
<p>Note 1: For EN-DC the NR <i>RRCReconfiguration</i> message is contained in <i>RRCConnectionReconfiguration</i>.</p> <p>Note 2: For EN-DC the NR <i>RRCReconfigurationComplete</i> message is contained in <i>RRCConnectionReconfigurationComplete</i>.</p> <p>Note 3: y is the slot where the UE shall transmit the PUSCH and is determined by y_2 as $y_2 = \left\lfloor n \cdot \frac{\mu_{\text{PUSCH}}}{\mu_{\text{PDCCH}}} + 2 \right\rfloor$</p> <p>where n is the slot with the scheduling DCI, y_2 is based on the numerology of PUSCH. S is the starting symbol relative to the start of the slot y according to TS 38.214 clause 6.1.2.1.</p> <p>Note 4: x is equal to <i>periodicity</i> / 14 in this test case.</p> <p>Note 5: If the MAC entity does not generate a MAC PDU, one of the conditions which shall be satisfied is that there is no aperiodic CSI requested for this PUSCH transmission as specified in TS 38.321 clause 5.4.3.1.3.</p>					

7.1.1.6.3.3.3 Specific message contents

Table 7.1.1.6.3.3.3-1: RRCReconfiguration (step 1, Table 7.1.1.6.3.3.2-1)

Derivation path: 38.508-1 [4], Table 4.6.1-13			
Information Element	Value/remark	Comment	Condition
RRCReconfiguration ::= SEQUENCE {			
criticalExtensions CHOICE {			
rrcReconfiguration SEQUENCE {			
radioBearerConfig	Not present		
secondaryCellGroup	CellGroupConfig	OCTET STRING (CONTAINING CellGroupConfig)	EN-DC
nonCriticalExtension ::= SEQUENCE {}	Not present		EN-DC
nonCriticalExtension ::= SEQUENCE{			NR
masterCellGroup	CellGroupConfig	OCTET STRING (CONTAINING CellGroupConfig)	
dedicatedNAS-MessageList SEQUENCE (SIZE(1..maxDRB)) OF DedicatedNAS-Message {}	Not present		
}			
}			
}			
}			

Table 7.1.1.6.3.3.3-2: *CellGroupConfig* (Table 7.1.1.6.3.3.3-1: *RRCReconfiguration*)

Derivation path: 38.508-1 [4], Table 4.6.3-19			
Information Element	Value/remark	Comment	Condition
CellGroupConfig ::= SEQUENCE {			
rlc-BearerToAddModList	Not present		
mac-CellGroupConfig	Not present		
physicalCellGroupConfig SEQUENCE {			
cs-RNTI CHOICE {			
setup SEQUENCE{			
RNTI-Value	'FFE0'H		
}			
}			
}			
spCellConfig SEQUENCE{			
spCellConfigDedicated SEQUENCE{			
uplinkConfig SEQUENCE {			
initialUplinkBWP SEQUENCE {			
pucch-Config CHOICE {			
setup SEQUENCE {			
schedulingRequestResourceToAddModList {			
schedulingRequestResourceId	1		
schedulingRequestID	0		
periodicityAndOffset CHOICE {			
sl20	10		
}			
}			
}			
}			
}			
configuredGrantConfig CHOICE {			
setup SEQUENCE {			
cg-DMRS-Configuration	DMRS-UplinkConfig	Reference TS 38.508-1 [4], Table 4.6.3-51	
uci-OnPUSCH CHOICE {			
setup SEQUENCE {			
semiStatic SEQUENCE {	BetaOffsets		
betaOffsetACK-Index1	9		
betaOffsetACK-Index2	9		
betaOffsetACK-Index3	9		
betaOffsetCSI-Part1-Index1	6		
betaOffsetCSI-Part1-Index2	6		
betaOffsetCSI-Part2-Index1	6		
betaOffsetCSI-Part2-Index2	6		
}			
}			
}			
}			
resourceAllocation	ResourceAllocationType1		
powerControlLoopToUse	n0		
p0-PUSCH-Alpha	1		
nrofHARQ-Processes	16		
repK	n1		
periodicity	Sym40x14		15kHz
periodicity	Sym80x14		30kHz
periodicity	Sym160x14		60kHz
periodicity	Sym320x14		120kHz
}			
}			
pusch-Config CHOICE {			
setup SEQUENCE {			
PUSCH-TimeDomainResourceAllocationList			

7.1.1.6.4 Correct handling of DL assignment / Multi Semi-persistent configuration

7.1.1.6.4.1 Test Purpose (TP)

(1)

```
with { UE in RRC_Connected state with DRB established and sps-Configuration in DL is enabled }
ensure that {
  when { UE receives a DL assignment addressed to its stored CS-RNTI in slot y and with NDI set as 0
}
  then {UE starts receiving DL MAC PDU in slots y+n*[semiPersistSchedIntervalDL] where 'n' is
positive integer starting at zero }
}
```

(2)

```
with { UE in RRC_Connected state with DRB established and stored DL SPS assignment to receive MAC
PDU in slot y+n*[semiPersistSchedIntervalDL] }
ensure that {
  when { UE receives another DL assignment addressed to its CS-RNTI in slot p and with NDI set as 0,
where p!= y+n*[semiPersistSchedIntervalDL] }
  then { UE starts receiving DL MAC PDU in slots p+n*[semiPersistSchedIntervalDL] and continue
receiving DL MAC PDU at slots y+n*[semiPersistSchedIntervalDL] where 'n' is positive integer starting
at zero }
}
```

7.1.1.6.4.2 Conformance requirements

References: The conformance requirements covered in the present TC are specified in TS 38.321, clause 5.3.1, 5.8.1 and TS 38.300, clause 10.2. Unless otherwise stated these are Rel-16 requirements.

[TS 38.321, clause 5.3.1]

Downlink assignments received on the PDCCH both indicate that there is a transmission on a DL-SCH for a particular MAC entity and provide the relevant HARQ information.

When the MAC entity has a C-RNTI, Temporary C-RNTI, or CS-RNTI, the MAC entity shall for each PDCCH occasion during which it monitors PDCCH and for each Serving Cell:

- 1> if a downlink assignment for this PDCCH occasion and this Serving Cell has been received on the PDCCH for the MAC entity's C-RNTI, or Temporary C-RNTI:
 - 2> if this is the first downlink assignment for this Temporary C-RNTI:
 - 3> consider the NDI to have been toggled.
 - 2> if the downlink assignment is for the MAC entity's C-RNTI, and if the previous downlink assignment indicated to the HARQ entity of the same HARQ process was either a downlink assignment received for the MAC entity's CS-RNTI or a configured downlink assignment:
 - 3> consider the NDI to have been toggled regardless of the value of the NDI.
 - 2> indicate the presence of a downlink assignment and deliver the associated HARQ information to the HARQ entity.
- 1> else if a downlink assignment for this PDCCH occasion has been received for this Serving Cell on the PDCCH for the MAC entity's CS-RNTI:
 - 2> if the NDI in the received HARQ information is 1:
 - 3> consider the NDI for the corresponding HARQ process not to have been toggled;
 - 3> indicate the presence of a downlink assignment for this Serving Cell and deliver the associated HARQ information to the HARQ entity.
 - 2> if the NDI in the received HARQ information is 0:

- 3> if PDCCH contents indicate SPS deactivation:
 - 4> clear the configured downlink assignment for this Serving Cell (if any);
 - 4> if the *timeAlignmentTimer*, associated with the TAG containing the Serving Cell on which the HARQ feedback is to be transmitted, is running:
 - 5> indicate a positive acknowledgement for the SPS deactivation to the physical layer.
- 3> else if PDCCH content indicates SPS activation:
 - 4> store the downlink assignment for this Serving Cell and the associated HARQ information as configured downlink assignment;
 - 4> initialise or re-initialise the configured downlink assignment for this Serving Cell to start in the associated PDSCH duration and to recur according to rules in clause 5.8.1;

For each Serving Cell and each configured downlink assignment, if configured and activated, the MAC entity shall:

- 1> if the PDSCH duration of the configured downlink assignment does not overlap with the PDSCH duration of a downlink assignment received on the PDCCH for this Serving Cell:
 - 2> instruct the physical layer to receive, in this PDSCH duration, transport block on the DL-SCH according to the configured downlink assignment and to deliver it to the HARQ entity;
 - 2> set the HARQ Process ID to the HARQ Process ID associated with this PDSCH duration;
 - 2> consider the NDI bit for the corresponding HARQ process to have been toggled;
 - 2> indicate the presence of a configured downlink assignment and deliver the stored HARQ information to the HARQ entity.

For configured downlink assignments without *harq-ProcID-Offset*, the HARQ Process ID associated with the slot where the DL transmission starts is derived from the following equation:

$$\text{HARQ Process ID} = [\text{floor}(\text{CURRENT_slot} \times 10 / (\text{numberOfSlotsPerFrame} \times \text{periodicity}))] \text{ modulo } n_{\text{rofHARQ-Processes}}$$

where $\text{CURRENT_slot} = [(\text{SFN} \times \text{numberOfSlotsPerFrame}) + \text{slot number in the frame}]$ and *numberOfSlotsPerFrame* refers to the number of consecutive slots per frame as specified in TS 38.211 [8].

NOTE 1: In case of unaligned SFN across carriers in a cell group, the SFN of the concerned Serving Cell is used to calculate the HARQ Process ID used for configured downlink assignments.

For configured downlink assignments with *harq-ProcID-Offset*, the HARQ Process ID associated with the slot where the DL transmission starts is derived from the following equation:

$$\text{HARQ Process ID} = [\text{floor}(\text{CURRENT_slot} \times 10 / (\text{numberOfSlotsPerFrame} \times \text{periodicity}))] \text{ modulo } n_{\text{rofHARQ-Processes}} + \text{harq-ProcID-Offset}$$

where $\text{CURRENT_slot} = [(\text{SFN} \times \text{numberOfSlotsPerFrame}) + \text{slot number in the frame}]$ and *numberOfSlotsPerFrame* refers to the number of consecutive slots per frame as specified in TS 38.211 [8].

NOTE 2: *CURRENT_slot* refers to the slot index of the first transmission occasion of a bundle of configured downlink assignment.

When the MAC entity needs to read BCCH, the MAC entity may, based on the scheduling information from RRC:

- 1> if a downlink assignment for this PDCCH occasion has been received on the PDCCH for the SI-RNTI;
- 2> indicate a downlink assignment and redundancy version for the dedicated broadcast HARQ process to the HARQ entity.

[TS 38.321, clause 5.8.1]

Semi-Persistent Scheduling (SPS) is configured by RRC per Serving Cell and per BWP. Multiple assignments can be active simultaneously in the same BWP. Activation and deactivation of the DL SPS are independent among the Serving Cells.

For the DL SPS, a DL assignment is provided by PDCCH, and stored or cleared based on L1 signalling indicating SPS activation or deactivation.

RRC configures the following parameters when the SPS is configured:

- *cs-RNTI*: CS-RNTI for activation, deactivation, and retransmission;
- *nrofHARQ-Processes*: the number of configured HARQ processes for SPS;
- *harq-ProcID-Offset*: Offset of HARQ process for SPS;
- *periodicity*: periodicity of configured downlink assignment for SPS.

When the SPS is released by upper layers, all the corresponding configurations shall be released.

After a downlink assignment is configured for SPS, the MAC entity shall consider sequentially that the Nth downlink assignment occurs in the slot for which:

$$\frac{(numberOfSlotsPerFrame \times SFN + \text{slot number in the frame})}{[(numberOfSlotsPerFrame \times SFN_{\text{start time}} + \text{slot}_{\text{start time}}) + N \times \text{periodicity} \times numberOfSlotsPerFrame / 10] \text{ modulo } (1024 \times numberOfSlotsPerFrame)}$$

where $SFN_{\text{start time}}$ and $\text{slot}_{\text{start time}}$ are the SFN and slot, respectively, of the first transmission of PDSCH where the configured downlink assignment was (re-)initialised.

NOTE: In case of unaligned SFN across carriers in a cell group, the SFN of the concerned Serving Cell is used to calculate the occurrences of configured downlink assignments.

[TS 38.300, clause 10.2]

In the downlink, the gNB can dynamically allocate resources to UEs via the C-RNTI on PDCCH(s). A UE always monitors the PDCCH(s) in order to find possible assignments when its downlink reception is enabled (activity governed by DRX when configured). When CA is configured, the same C-RNTI applies to all serving cells.

The gNB may pre-empt an ongoing PDSCH transmission to one UE with a latency-critical transmission to another UE. The gNB can configure UEs to monitor interrupted transmission indications using INT-RNTI on a PDCCH. If a UE receives the interrupted transmission indication, the UE may assume that no useful information to that UE was carried by the resource elements included in the indication, even if some of those resource elements were already scheduled to this UE.

In addition, with Semi-Persistent Scheduling (SPS), the gNB can allocate downlink resources for the initial HARQ transmissions to UEs: RRC defines the periodicity of the configured downlink assignments while PDCCH addressed to CS-RNTI can either signal and activate the configured downlink assignment, or deactivate it; i.e. a PDCCH addressed to CS-RNTI indicates that the downlink assignment can be implicitly reused according to the periodicity defined by RRC, until deactivated.

NOTE: When required, retransmissions are explicitly scheduled on PDCCH(s).

The dynamically allocated downlink reception overrides the configured downlink assignment in the same serving cell, if they overlap in time. Otherwise a downlink reception according to the configured downlink assignment is assumed, if activated.

The UE may be configured with up to 8 active configured downlink assignments for a given BWP of a serving cell. When more than one is configured:

- The network decides which of these configured downlink assignments are active at a time (including all of them); and
- Each configured downlink assignment is activated separately using a DCI command and deactivation of configured downlink assignments is done using a DCI command, which can either deactivate a single configured downlink assignment or multiple configured downlink assignments jointly.

7.1.1.6.4.3 Test description

7.1.1.6.4.3.1 Pre-test conditions

Same Pre-test conditions as in clause 7.1.1.0 except that set to return no data in uplink and that the UM DRB is configured according to Table 7.1.1.6.4.3.1-1.

Table 7.1.1.6.4.3.1-1: RLC parameters

Uplink UM RLC sn-FieldLength	IF (pc_um_WithShortSN) size6 ELSE size12
Downlink UM RLC sn-FieldLength	F (pc_um_WithShortSN) size6 ELSE size12

7.1.1.6.4.3.2 Test procedure sequence

Table 7.1.1.6.4.3.2-1: Main behaviour

St	Procedure	Message Sequence		TP	Verdict
		U - S	Message		
1	SS transmits <i>NR</i> RRCReconfiguration to config SPS-ConfigurationDL.(Note 2)	<-	RRCConnectionReconfiguration	-	-
2	The UE transmits NR RRCReconfigurationComplete.(Note 3)	-->	RRCConnectionReconfigurationComplete	-	-
3	The SS transmits a DL assignment using UE's CS-RNTI in Slot 'Y', NDI=0	<-	(DL SPS Grant)	-	-
4	The SS transmits in Slot 'Y', a DL MAC PDU containing a RLC PDU on UM DRB.	<-	MAC PDU	-	-
5	Check: does the UE transmit a HARQ ACK?	-->	HARQ ACK	1	P
6	The SS transmits in Slot 'Y+X', a DL MAC PDU containing a RLC PDU on DRB. (Note 1)	<-	MAC PDU	-	-
7	Check: Does the UE transmit a HARQ ACK?	-->	HARQ ACK	1	P
8	SS transmits <i>NR</i> RRCReconfiguration to add another SPS-ConfigurationDL.(Note 2)	<-	RRCConnectionReconfiguration	-	-
9	The UE transmits NR RRCReconfigurationComplete.(Note 3)	-->	RRCConnectionReconfigurationComplete	-	-
10	The SS transmits a DL assignment using UE's CS-RNTI in Slot 'P', NDI=0; (Where Y+X<P<Y+2X)	<-	(DL SPS Grant)	-	-
11	The SS transmits in Slot 'P', a DL MAC PDU containing a RLC PDU on UM DRB.	<-	MAC PDU	-	-
12	Check: Does the UE transmit a HARQ ACK?	-->	HARQ ACK	2	P
13	The SS transmits in Slot 'Y+2X', a DL MAC PDU containing a RLC PDU on UM DRB.	<-	MAC PDU	-	-
14	Check: Does the UE transmit a HARQ Feedback?	-->	HARQ ACK	2	P
15	The SS transmits in Slot 'P+X', a DL MAC PDU containing a RLC PDU (DL-SQN=1) on UM DRB.	<-	MAC PDU	-	-
16	Check: Does the UE transmit a HARQ Feedback?	-->	HARQ ACK	2	P
17	SS transmits <i>NR</i> RRCReconfiguration to disable SPS-ConfigurationDL.(Note 2)	<-	RRCConnectionReconfiguration	-	-
18	The UE transmits NR RRCReconfigurationComplete.(Note 3)	-->	RRCConnectionReconfigurationComplete	-	-
Note 1: X is equal to semiPersistSchedIntervalDL in this document. Note 2: For EN-DC the NR RRCReconfiguration message is contained in RRCConnectionReconfiguration 36.508 [7], Table 4.6.1-8 using condition EN-DC_EmbedNR_RRCRecon. Note 3: For EN-DC the NR <i>RRCReconfigurationComplete</i> message is contained in <i>RRCConnectionReconfigurationComplete</i> .					

7.1.1.6.4.3.3 Specific message contents

Table 7.1.1.6.4.3.3-1: RRCReconfiguration (step 1/8, Table 7.1.1.6.4.3.2-1)

Derivation path: 38.508-1 [4], Table 4.6.1-13			
Information Element	Value/remark	Comment	Condition
RRCReconfiguration ::= SEQUENCE {			
criticalExtensions CHOICE {			
rrcReconfiguration SEQUENCE {			
secondaryCellGroup	CellGroupConfig	OCTET STRING (CONTAINING CellGroupConfig)	EN-DC
nonCriticalExtension ::= SEQUENCE{			NR
masterCellGroup	CellGroupConfig	OCTET STRING (CONTAINING CellGroupConfig)	
}			
}			
}			
}			

Table 7.1.1.6.4.3.3-2: CellGroupConfig (in Table 7.1.1.6.4.3.3-1)

Derivation path: 38.508-1 [4], Table 4.6.3-19			
Information Element	Value/remark	Comment	Condition
CellGroupConfig ::= SEQUENCE {			
physicalCellGroupConfig	PhysicalCellGroupConfig	Table 7.1.1.6.4.3.3-3	
spCellConfig SEQUENCE {			
servCellIndex	1		
spCellConfigDedicated SEQUENCE {			
initialDownlinkBWP SEQUENCE {			
sps-ConfigToAddModList-r16 ::= SEQUENCE (SIZE (1..maxNrofSPS-Config-r16)) OF SPS-Config {			
SPS-Config ::= SEQUENCE [1] {		The first SPS configuration entry	STEP 1
setup SEQUENCE {			
periodicity	ms160		
nrofHARQ-Processes	8		
sps-ConfigIndex-r16	0		
harq-ProclD-Offset-r16	0		
sps-ConfigIndex-r16	0		
}			
SPS-Config ::= SEQUENCE [2] {		The second SPS configuration entry	STEP 8
setup SEQUENCE {			
periodicity	ms160		
nrofHARQ-Processes	8		
sps-ConfigIndex-r16	1		
harq-ProclD-Offset-r16	8		
sps-ConfigIndex-r16	1		
}			
}			
}			
}			
}			
}			
}			

Table 7.1.1.6.4.3.3-3: PhysicalCellGroupConfig (Table 7.1.1.6.4.3.3-2)

Derivation Path: TS 38.508-1 [4], Table 4.6.3-106			
Information Element	Value/remark	Comment	Condition
PhysicalCellGroupConfig ::= SEQUENCE {			
cs-RNTI	'FFE0'H		
}			

Table 7.1.1.6.4.3.3-4: RRCReconfiguration (step 17 of Table 7.1.1.6.4.3.2-1)

Derivation path: 38.508-1 [4], Table 4.6.1-13			
Information Element	Value/remark	Comment	Condition
RRCReconfiguration ::= SEQUENCE {			
criticalExtensions CHOICE {			
rrcReconfiguration SEQUENCE {			
secondaryCellGroup	CellGroupConfig	OCTET STRING (CONTAINING CellGroupConfig)	EN-DC
nonCriticalExtension ::= SEQUENCE{			NR
masterCellGroup	CellGroupConfig	OCTET STRING (CONTAINING CellGroupConfig)	
}			
}			
}			

Table 7.1.1.6.4.3.3-5: CellGroupConfig (Table 7.1.1.6.4.3.3-4)

Derivation path: 38.508-1 [4], Table 4.6.3-19			
Information Element	Value/remark	Comment	Condition
CellGroupConfig ::= SEQUENCE {			
spCellConfig SEQUENCE {			
servCellIndex	1		
spCellConfigDedicated SEQUENCE {			
initialDownlinkBWP SEQUENCE {			
sps-ConfigToReleaseList-r16 SEQUENCE (SIZE (1..maxNrofSPS-Config-r16)) OF SPS- ConfigIndex-r16 {	2 entries	Release all the SPS entries configured previously	
SPS-ConfigIndex-r16[1]	0		
SPS-ConfigIndex-r16[2]	1		
}			
}			
}			
}			
}			

7.1.1.7 Activation/Deactivation of SCells

7.1.1.7.1 Activation/Deactivation of SCells / Activation/Deactivation MAC control element reception / sCellDeactivationTimer

7.1.1.7.1.1 Activation/Deactivation of SCells / Activation/Deactivation MAC control element reception / sCellDeactivationTimer / Intra-band Contiguous CA

7.1.1.7.1.1.1 Test Purpose (TP)

(1)

```
with { UE in RRC_CONNECTED state with SCell configured }
ensure that {
  when { the UE receives an SCell Activation/Deactivation MAC CE activating the SCell }
  then { the UE starts monitoring PDCCH on activated SCell }
}
```

(2)

```
with(UE in RRC_CONNECTED state with SCell activated)
ensure that {
  when{ the UE receives a DL assignment on SCell PDCCH }
  then { the UE restarts the sCellDeactivationTimer }
}
```

(3)

```
with ( UE in RRC_CONNECTED state with SCell activated)
ensure that {
  when{ the UE sCellDeactivationTimer expires }
  then { the UE deactivates the SCell and stops monitoring PDCCH on SCell }
}
```

(4)

```
with (UE in RRC_CONNECTED state with SCell activated )
ensure that {
  when{ the UE receives a SCell Activation/Deactivation MAC CE deactivating the SCell }
  then { the UE deactivates the SCell and stops monitoring PDCCH on SCell }
}
```

(5)

```
with(UE in RRC_CONNECTED state with SCell activated and UL CA is supported)
ensure that {
  when{ the UE receives a UL assignment on SCell and has data available for transmission }
  then { the UE transmits the UL MAC PDU }
}
```

7.1.1.7.1.1.2 Conformance requirements

References: The conformance requirements covered in the present TC are specified in: TS 38.321, clauses 5.9 and TS 38.331 clause 5.3.5.5.2. Unless otherwise stated these are Rel-15 requirements.

[TS 38.321, clause 5.9]

If the MAC entity is configured with one or more SCells, the network may activate and deactivate the configured SCells. Upon configuration of an SCell, the SCell is deactivated.

The configured SCell(s) is activated and deactivated by:

- receiving the SCell Activation/Deactivation MAC CE described in subclause 6.1.3.10;
- configuring *sCellDeactivationTimer* timer per configured SCell (except the SCell configured with PUCCH, if any): the associated SCell is deactivated upon its expiry.

The MAC entity shall for each configured SCell:

- 1> if an SCell Activation/Deactivation MAC CE is received activating the SCell:
 - 2> activate the SCell according to the timing defined in TS 38.213 [6]; i.e. apply normal SCell operation including:
 - 3> SRS transmissions on the SCell;
 - 3> CSI reporting for the SCell;
 - 3> PDCCH monitoring on the SCell;
 - 3> PDCCH monitoring for the SCell;
 - 3> PUCCH transmissions on the SCell, if configured.
 - 2> start or restart the *sCellDeactivationTimer* associated with the SCell in the slot when the SCell Activation/Deactivation MAC CE was received;
 - 2> (re-)initialize any suspended configured uplink grants of configured grant Type 1 associated with this SCell according to the stored configuration, if any, and to start in the symbol according to rules in subclause 5.8.2;
 - 2> trigger PHR according to subclause 5.4.6.
- 1> else if an SCell Activation/Deactivation MAC CE is received deactivating the SCell; or
- 1> if the *sCellDeactivationTimer* associated with the activated SCell expires:
 - 2> deactivate the SCell according to the timing defined in TS 38.213 [6];
 - 2> stop the *sCellDeactivationTimer* associated with the SCell;
 - 2> stop the *bwp-InactivityTimer* associated with the SCell;
 - 2> clear any configured downlink assignment and any configured uplink grant Type 2 associated with the SCell respectively;
 - 2> suspend any configured uplink grant Type 1 associated with the SCell;
 - 2> flush all HARQ buffers associated with the SCell.
- 1> if PDCCH on the activated SCell indicates an uplink grant or downlink assignment; or
- 1> if PDCCH on the Serving Cell scheduling the activated SCell indicates an uplink grant or a downlink assignment for the activated SCell; or
- 1> if a MAC PDU is transmitted in a configured uplink grant or received in a configured downlink assignment:
 - 2> restart the *sCellDeactivationTimer* associated with the SCell.
- 1> if the SCell is deactivated:
 - 2> not transmit SRS on the SCell;
 - 2> not report CSI for the SCell;
 - 2> not transmit on UL-SCH on the SCell;
 - 2> not transmit on RACH on the SCell;
 - 2> not monitor the PDCCH on the SCell;
 - 2> not monitor the PDCCH for the SCell;
 - 2> not transmit PUCCH on the SCell.

HARQ feedback for the MAC PDU containing SCell Activation/Deactivation MAC CE shall not be impacted by PCell, PSCell and PUCCH SCell interruptions due to SCell activation/deactivation in TS 38.133 [11].

When SCell is deactivated, the ongoing Random Access procedure on the SCell, if any, is aborted.

[TS 38.321, clause 6.1.3.10]

The SCell Activation/Deactivation MAC CE of one octet is identified by a MAC PDU subheader with LCID as specified in Table 6.2.1-1. It has a fixed size and consists of a single octet containing seven C-fields and one R-field. The SCell Activation/Deactivation MAC CE with one octet is defined as follows (Figure 6.1.3.10-1).

The SCell Activation/Deactivation MAC CE of four octets is identified by a MAC PDU subheader with LCID as specified in Table 6.2.1-1. It has a fixed size and consists of four octets containing 31 C-fields and one R-field. The SCell Activation/Deactivation MAC CE of four octets is defined as follows (Figure 6.1.3.10-2).

For the case with no Serving Cell with a *ServCellIndex* as specified in TS 38.331 [8] larger than 7, SCell Activation/Deactivation MAC CE of one octet is applied, otherwise SCell Activation/Deactivation MAC CE of four octets is applied.

- C_i : If there is an SCell configured for the MAC entity with *SCellIndex* i as specified in TS 38.331 [8], this field indicates the activation/deactivation status of the SCell with *SCellIndex* i , else the MAC entity shall ignore the C_i field. The C_i field is set to "1" to indicate that the SCell with *SCellIndex* i shall be activated. The C_i field is set to "0" to indicate that the SCell with *SCellIndex* i shall be deactivated;
- R: Reserved bit, set to "0".

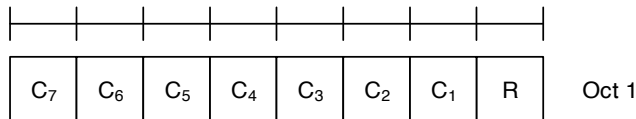

Figure 6.1.3.10-1: SCell Activation/Deactivation MAC CE of one octet

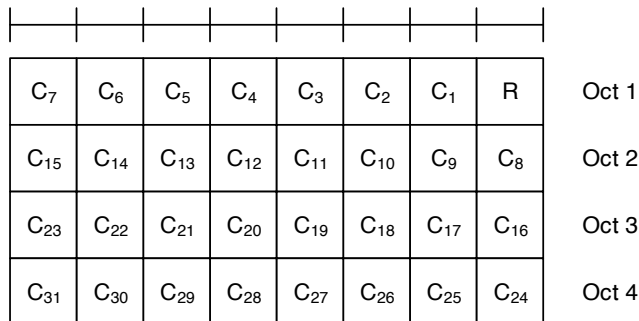

Figure 6.1.3.10-2: SCell Activation/Deactivation MAC CE of four octets

7.1.1.7.1.1.3 Test description

7.1.1.7.1.1.3.1 Pre-test conditions

Same Pre-test conditions as in clause 7.1.1.0 with the additional NR Cell 3 is configured as NR Active SCell.

7.1.1.7.1.1.3.2 Test procedure sequence

Table 7.1.1.7.1.1.3.2-1: Time instances of cell power level and parameter changes

	Parameter	Unit	NR Cell 1	NR Cell 3
T0	SS/PBCH SSS EPRE	dBm/SC S	-85	-85

Table 7.1.1.7.1.1.3.2-2: Main behaviour

St	Procedure	Message Sequence		TP	Verdict
		U - S	Message		
1	SS transmits an RRCReconfiguration message to configure NR SCell(NR Cell 3). Note 1	<--	(RRCReconfiguration)	-	-
2	The UE transmits RRCReconfigurationComplete message. Note 2	-->	(RRCReconfigurationComplete)	-	-
3	The SS transmits Activation MAC control element to activate NR SCell on NR SpCell.	<--	MAC PDU (SCell Activation/Deactivation MAC CE of one octet (C ₁ =1))	-	-
4	200 ms after step 3, the SS indicates a new transmission on PDCCH of SCell and transmits a MAC PDU (containing an RLC PDU)	<--	MAC PDU	-	-
5	Check: Does the UE transmit a Scheduling Request on PUCCH?	-->	(SR)	1	P
6	The SS sends an UL grant suitable for transmitting loop back PDU on NR SpCell.	<--	(UL Grant)	-	-
7	The UE transmits a MAC PDU containing the loop back PDU corresponding to step 4.	-->	MAC PDU	-	-
8	The SS transmits a MAC PDU containing RLC status PDU acknowledging reception of RLC PDU in step 7 on NR SpCell	<--	MAC PDU	-	-
9	400 ms(sCellDeactivationTimer = 320 ms) after step 4, the SS indicates a new transmission on PDCCH of NR SCell and transmits a MAC PDU (containing an RLC PDU)	<--	MAC PDU	-	-
10	Check: Does the UE transmit a Scheduling Request on PUCCH in next 1 second?	-->	(SR)	2	F
11	The SS transmits Activation MAC control element to activate SCell on NR SpCell.	<--	MAC PDU ((SCell Activation/Deactivation MAC CE of one octet (C ₁ =1))	-	-
12	200 ms after step 11 The SS indicates a new transmission on PDCCH of NR SCell and transmits a MAC PDU (containing just padding or RLC status PDU, but no RLC data PDU)	<--	MAC PDU	-	-
13	400 ms after step 11 the SS indicates a new transmission on PDCCH of NR SCell and transmits a MAC PDU (containing an RLC PDU)	<--	MAC PDU	-	-
14	Check: Does the UE transmit a Scheduling Request on PUCCH?	-->	(SR)	1,3	P
15	The SS sends an UL grant suitable for transmitting loop back PDU IF pc_UL_NR_CA_2CC on NR SCell ELSE on NR SpCell.	<--	(UL Grant)	-	-
16	The UE transmits a MAC PDU containing the loop back PDU corresponding to step 14	-->	MAC PDU	5	P
17	The SS transmits a MAC PDU containing RLC status PDU acknowledging reception of RLC PDU in step 16	<--	MAC PDU	-	-
18	The SS transmits Deactivation MAC control element to de-activate SCell on NR SpCell.	<--	MAC PDU (SCell Activation/Deactivation MAC CE of one octet (C ₁ =0))	-	-
19	The SS indicates a new transmission on PDCCH of NR SCell and transmits a MAC PDU (containing an RLC PDU)	<--	MAC PDU	-	-
20	Check: Does the UE transmit a Scheduling Request on PUCCH in next 1 second?	-->	(SR)	4	F
Note 1: for EN-DC the NR <i>RRCReconfiguration</i> message is contained in <i>RRCConnectionReconfiguration</i> . Note 2: for EN-DC the NR <i>RRCReconfigurationComplete</i> message is contained in <i>RRCConnectionReconfigurationComplete</i> .					

7.1.1.7.1.1.3.3 Specific message contents

Table 7.1.1.7.1.1.3.3-1: RRCReconfiguration (step 1, Table 7.1.1.7.1.1.3.2-2)

Derivation Path: TS 38.508-1 [4], Table 4.6.1-13.			
Information Element	Value/remark	Comment	Condition
RRCReconfiguration ::= SEQUENCE {			
criticalExtensions CHOICE {			
c1 CHOICE {			
rrcReconfiguration ::= SEQUENCE {			
secondaryCellGroup	CellGroupConfig		EN-DC
nonCriticalExtension SEQUENCE {			NR
masterCellGroup	CellGroupConfig	OCTET STRING (CONTAINING CellGroupConfig)	
}			
}			
}			
}			
}			

Table 7.1.1.7.1.1.3.3-2: CellGroupConfig (Table 7.1.1.7.1.1.3.3-1)

Derivation Path: TS 38.508-1 [4], Table 4.6.3-19.			
Information Element	Value/remark	Comment	Condition
CellGroupConfig ::= SEQUENCE {			
sCellToAddModList SEQUENCE (SIZE (1..maxMeasId)) OF SCellConfig {	1 entry		
SCellConfig[1] SEQUENCE {		entry 1	
sCellIndex	SCellIndex as per TS 38.508-1 [4] table 4.6.3- 154		
sCellConfigCommon	ServingCellConfigComm on		
sCellConfigDedicated	ServingCellConfig		
}			
}			
}			

Table 7.1.1.7.1.1.3.3-3: ServingCellConfigCommon (Table 7.1.1.7.1.1.3.3-2)

Derivation Path: TS 38.508-1 [4], Table 4.6.3-168.			
Information Element	Value/remark	Comment	Condition
ServingCellConfigCommon ::= SEQUENCE {			
physCellId	Physical Cell Identity of NR Cell 3		
uplinkConfigCommon	Not present		Not pc_UL_NR_ CA_2CC
}			

Table 7.1.1.7.1.1.3.3-4: ServingCellConfig (Table 7.1.1.7.1.1.3.3-2)

Derivation Path: TS 38.508-1 [4], Table 4.6.3-167.			
Information Element	Value/remark	Comment	Condition
ServingCellConfig ::= SEQUENCE {			
uplinkConfig	Not present		Not pc_UL_NR_ CA_2CC
sCellDeactivationTimer	ms320		
}			

7.1.1.7.1.2 Activation/Deactivation of SCells / Activation/Deactivation MAC control element reception / sCellDeactivationTimer / Inter-Band CA

The scope and description of the present TC is the same as test case 7.1.1.7.1.1 with the following differences:

- CA configuration: Inter-band CA replaces Intra-band Contiguous CA
- Cells configuration: NR Cell 10 replaces NR Cell 3

7.1.1.7.1.3 Activation/Deactivation of SCells / Activation/Deactivation MAC control element reception / sCellDeactivationTimer / Intra-band non-Contiguous CA

The scope and description of the present TC is the same as test case 7.1.1.7.1.1 with the following differences:

- CA configuration: Intra-band non-Contiguous CA replaces Intra-band Contiguous CA

7.1.1.8 Bandwidth Part (BWP) operation

7.1.1.8.1 Bandwidth Part (BWP) operation UL/DL

7.1.1.8.1.1 Test Purpose (TP)

(1)

```
with { UE in RRC_CONNECTED state }
ensure that {
  when { BandwidthPart-Config IE is included in RRC Message received on SpCell (i.e. PSCell in case
of EN-DC or PCell in case of SA) }
  then { UE starts normal MAC operation in the FirstActive UL and DL Bandwidth part }
}
```

(2)

```
with { UE in RRC_CONNECTED state }
ensure that {
  when { UE receives a DL DCI format 1_1 assigning a BWP different than the previously configured
BWP }
  then { UE starts normal MAC operation in the received new BWP }
}
```

(3)

```
with { UE in RRC_CONNECTED }
ensure that {
  when { UE receives a UL DCI format 0_1 assigning a BWP different than the previously configured
BWP }
  then { UE starts normal MAC operation in the received new BWP }
}
```

(4)

```
with { UE in RRC_CONNECTED state }
ensure that {
  when { RACH Procedure is triggered in SpCell (i.e. PSCell in case of EN-DC or PCell in case of SA)
and PRACH occasions are not configured }
  then { UE initiates the PRACH procedure in the initial BWP }
}
```

(5)

```
with { UE in RRC_Connected State with defaultDownlinkBWP configured }
ensure that {
  when { bwp-InactivityTimer expires }
  then { UE performs BWP switching to a BWP indicated by the defaultDownlinkBWP }
}
```

(6)

```

with { UE in RRC_Connected State with defaultDownlinkBWP configured and Active BWP is different than
defaultDownlinkBWP and bwp-InactivityTimer is running }
ensure that {
  when { UE receives UL assignment or DL grant addressed to its C-RNTI }
  then { UE restarts the bwp-InactivityTimer }
}

```

7.1.1.8.1.2 Conformance requirements

References: The conformance requirements covered in the present TC are specified in: TS 38.211 clause 4.4.5, TS 38.212 clause 7.3.1.1.2 and 7.3.1.2.2, TS 38.321 clause 5.15 and TS 38.331 clause 5.3.5.3 and 6.3.2. Unless otherwise stated these are Rel-15 requirements.

[TS 38.211, clause 4.4.5]

A bandwidth part is a subset of contiguous common resource blocks defined in subclause 4.4.4.3 for a given numerology μ_i in bandwidth part i on a given carrier. The starting position $N_{\text{BWP},i}^{\text{start},\mu}$ and the number of resource blocks $N_{\text{BWP},i}^{\text{size},\mu}$ in a bandwidth part shall fulfil $N_{\text{grid},x}^{\text{start},\mu} \leq N_{\text{BWP},i}^{\text{start},\mu} < N_{\text{grid},x}^{\text{start},\mu} + N_{\text{grid},x}^{\text{size},\mu}$ and $N_{\text{grid},x}^{\text{start},\mu} < N_{\text{BWP},i}^{\text{size},\mu} + N_{\text{BWP},i}^{\text{start},\mu} \leq N_{\text{grid},x}^{\text{start},\mu} + N_{\text{grid},x}^{\text{size},\mu}$, respectively. Configuration of a bandwidth part is described in clause 12 of [5, TS 38.213].

A UE can be configured with up to four bandwidth parts in the downlink with a single downlink bandwidth part being active at a given time. The UE is not expected to receive PDSCH, PDCCH, or CSI-RS (except for RRM) outside an active bandwidth part.

A UE can be configured with up to four bandwidth parts in the uplink with a single uplink bandwidth part being active at a given time. If a UE is configured with a supplementary uplink, the UE can in addition be configured with up to four bandwidth parts in the supplementary uplink with a single supplementary uplink bandwidth part being active at a given time. The UE shall not transmit PUSCH or PUCCH outside an active bandwidth part. For an active cell, the UE shall not transmit SRS outside an active bandwidth part.

Unless otherwise noted, the description in this specification applies to each of the bandwidth parts. When there is no risk of confusion, the index μ may be dropped from $N_{\text{BWP},i}^{\text{start},\mu}$, $N_{\text{BWP},i}^{\text{size},\mu}$, $N_{\text{grid},x}^{\text{start},\mu}$, and $N_{\text{grid},x}^{\text{size},\mu}$.

[TS 38.212, clause 7.3.1.1.2]

DCI format 0_1 is used for the scheduling of PUSCH in one cell.

The following information is transmitted by means of the DCI format 0_1 with CRC scrambled by C-RNTI or CS-RNTI or SP-CSI-RNTI or MCS-C-RNTI:

- Identifier for DCI formats – 1 bit
 - The value of this bit field is always set to 0, indicating an UL DCI format
- Carrier indicator – 0 or 3 bits, as defined in Subclause 10.1 of [5, TS 38.213].
- UL/SUL indicator – 0 bit for UEs not configured with SUL in the cell or UEs configured with SUL in the cell but only PUCCH carrier in the cell is configured for PUSCH transmission; 1 bit for UEs configured with SUL in the cell as defined in Table 7.3.1.1.1-1.
- Bandwidth part indicator – 0, 1 or 2 bits as determined by the number of UL BWPs $n_{\text{BWP,RRC}}$ configured by higher layers, excluding the initial UL bandwidth part. The bitwidth for this field is determined as $\lceil \log_2(n_{\text{BWP}}) \rceil$ bits, where
 - $n_{\text{BWP}} = n_{\text{BWP,RRC}} + 1$ if $n_{\text{BWP,RRC}} \leq 3$, in which case the bandwidth part indicator is equivalent to the ascending order of the higher layer parameter *BWP-Id*;
 - otherwise $n_{\text{BWP}} = n_{\text{BWP,RRC}}$, in which case the bandwidth part indicator is defined in Table 7.3.1.1.2-1;

If a UE does not support active BWP change via DCI, the UE ignores this bit field.

[TS 38.212, clause 7.3.1.2.2]

DCI format 1_1 is used for the scheduling of PDSCH in one cell.

The following information is transmitted by means of the DCI format 1_1 with CRC scrambled by C-RNTI or CS-RNTI or MCS-C-RNTI:

- Identifier for DCI formats – 1 bits
 - The value of this bit field is always set to 1, indicating a DL DCI format
- Carrier indicator – 0 or 3 bits as defined in Subclause 10.1 of [5, TS 38.213].
- Bandwidth part indicator – 0, 1 or 2 bits as determined by the number of DL BWPs $n_{\text{BWP,RRC}}$ configured by higher layers, excluding the initial DL bandwidth part. The bitwidth for this field is determined as $\lceil \log_2(n_{\text{BWP}}) \rceil$ bits, where
 - $n_{\text{BWP}} = n_{\text{BWP,RRC}} + 1$ if $n_{\text{BWP,RRC}} \leq 3$, in which case the bandwidth part indicator is equivalent to the higher layer parameter *BWP-Id*;
 - otherwise $n_{\text{BWP}} = n_{\text{BWP,RRC}}$, in which case the bandwidth part indicator is defined in Table 7.3.1.1.2-1;

If a UE does not support active BWP change via DCI, the UE ignores this bit field.

[TS 38.321, clause 5.15]

In addition to clause 12 of TS 38.213 [6], this subclause specifies requirements on BWP operation.

A Serving Cell may be configured with one or multiple BWPs, and the maximum number of BWP per Serving Cell is specified in TS 38.213 [6].

The BWP switching for a Serving Cell is used to activate an inactive BWP and deactivate an active BWP at a time. The BWP switching is controlled by the PDCCH indicating a downlink assignment or an uplink grant, by the *bwpl-InactivityTimer*, by RRC signalling, or by the MAC entity itself upon initiation of Random Access procedure. Upon RRC (re-)configuration of *firstActiveDownlinkBWP-Id* and/or *firstActiveUplinkBWP-Id* for SpCell or activation of an SCell, the DL BWP and/or UL BWP indicated by *firstActiveDownlinkBWP-Id* and/or *firstActiveUplinkBWP-Id* respectively (as specified in TS 38.331 [5]) is active without receiving PDCCH indicating a downlink assignment or an uplink grant. The active BWP for a Serving Cell is indicated by either RRC or PDCCH (as specified in TS 38.213 [6]). For unpaired spectrum, a DL BWP is paired with a UL BWP, and BWP switching is common for both UL and DL.

For each activated Serving Cell configured with a BWP, the MAC entity shall:

- 1> if a BWP is activated:
 - 2> transmit on UL-SCH on the BWP;
 - 2> transmit on RACH on the BWP, if PRACH occasions are configured;
 - 2> monitor the PDCCH on the BWP;
 - 2> transmit PUCCH on the BWP, if configured;
 - 2> report CSI for the BWP;
 - 2> transmit SRS on the BWP, if configured;
 - 2> receive DL-SCH on the BWP;
 - 2> (re-)initialize any suspended configured uplink grants of configured grant Type 1 on the active BWP according to the stored configuration, if any, and to start in the symbol according to rules in subclause 5.8.2.
- 1> if a BWP is deactivated:
 - 2> not transmit on UL-SCH on the BWP;

- 2> not transmit on RACH on the BWP;
- 2> not monitor the PDCCH on the BWP;
- 2> not transmit PUCCH on the BWP;
- 2> not report CSI for the BWP;
- 2> not transmit SRS on the BWP;
- 2> not receive DL-SCH on the BWP;
- 2> clear any configured downlink assignment and configured uplink grant of configured grant Type 2 on the BWP;
- 2> suspend any configured uplink grant of configured grant Type 1 on the inactive BWP.

Upon initiation of the Random Access procedure on a Serving Cell, after the selection of carrier for performing Random Access procedure as specified in subclause 5.1.1, the MAC entity shall for the selected carrier of this Serving Cell:

- 1> if PRACH occasions are not configured for the active UL BWP:
 - 2> switch the active UL BWP to BWP indicated by *initialUplinkBWP*;
 - 2> if the Serving Cell is a SpCell:
 - 3> switch the active DL BWP to BWP indicated by *initialDownlinkBWP*.
- 1> else:
 - 2> if the Serving Cell is a SpCell:
 - 3> if the active DL BWP does not have the same *bwp-Id* as the active UL BWP:
 - 4> switch the active DL BWP to the DL BWP with the same *bwp-Id* as the active UL BWP.
- 1> stop the *bwp-InactivityTimer* associated with the active DL BWP of this Serving Cell, if running.
- 1> if the Serving Cell is SCell:
 - 2> stop the *bwp-InactivityTimer* associated with the active DL BWP of SpCell, if running.
- 1> perform the Random Access procedure on the active DL BWP of SpCell and active UL BWP of this Serving Cell.

If the MAC entity receives a PDCCH for BWP switching of a Serving Cell, the MAC entity shall:

- 1> if there is no ongoing Random Access procedure associated with this Serving Cell; or
- 1> if the ongoing Random Access procedure associated with this Serving Cell is successfully completed upon reception of this PDCCH addressed to C-RNTI (as specified in subclauses 5.1.4 and 5.1.5):
 - 2> perform BWP switching to a BWP indicated by the PDCCH.

If the MAC entity receives a PDCCH for BWP switching for a Serving Cell while a Random Access procedure associated with that Serving Cell is ongoing in the MAC entity, it is up to UE implementation whether to switch BWP or ignore the PDCCH for BWP switching, except for the PDCCH reception for BWP switching addressed to the C-RNTI for successful Random Access procedure completion (as specified in subclauses 5.1.4 and 5.1.5) in which case the UE shall perform BWP switching to a BWP indicated by the PDCCH. Upon reception of the PDCCH for BWP switching other than successful contention resolution, if the MAC entity decides to perform BWP switching, the MAC entity shall stop the ongoing Random Access procedure and initiate a Random Access procedure after performing the BWP switching; if the MAC decides to ignore the PDCCH for BWP switching, the MAC entity shall continue with the ongoing Random Access procedure on the Serving Cell.

Upon reception of RRC (re-)configuration for BWP switching for a Serving Cell while a Random Access procedure associated with that Serving Cell is ongoing in the MAC entity, the MAC entity shall stop the ongoing Random Access procedure and initiate a Random Access procedure after performing the BWP switching.

The MAC entity shall for each activated Serving Cell configured with *bwp-InactivityTimer*:

- 1> if the *defaultDownlinkBWP-Id* is configured, and the active DL BWP is not the BWP indicated by the *defaultDownlinkBWP-Id*; or
- 1> if the *defaultDownlinkBWP-Id* is not configured, and the active DL BWP is not the *initialDownlinkBWP*:
 - 2> if a PDCCH addressed to C-RNTI or CS-RNTI indicating downlink assignment or uplink grant is received on the active BWP; or
 - 2> if a PDCCH addressed to C-RNTI or CS-RNTI indicating downlink assignment or uplink grant is received for the active BWP; or
 - 2> if a MAC PDU is transmitted in a configured uplink grant or received in a configured downlink assignment:
 - 3> if there is no ongoing random access procedure associated with this Serving Cell; or
 - 3> if the ongoing Random Access procedure associated with this Serving Cell is successfully completed upon reception of this PDCCH addressed to C-RNTI (as specified in subclauses 5.1.4 and 5.1.5):
 - 4> start or restart the *bwp-InactivityTimer* associated with the active DL BWP.
 - 2> if the *bwp-InactivityTimer* associated with the active DL BWP expires:
 - 3> if the *defaultDownlinkBWP-Id* is configured:
 - 4> perform BWP switching to a BWP indicated by the *defaultDownlinkBWP-Id*.
 - 3> else:
 - 4> perform BWP switching to the *initialDownlinkBWP*.

NOTE: If a Random Access procedure is initiated on an SCell, both this SCell and the SpCell are associated with this Random Access procedure.

- 1> if a PDCCH for BWP switching is received, and the MAC entity switches the active DL BWP:
 - 2> if the *defaultDownlinkBWP-Id* is configured, and the MAC entity switches to the DL BWP which is not indicated by the *defaultDownlinkBWP-Id*; or
 - 2> if the *defaultDownlinkBWP-Id* is not configured, and the MAC entity switches to the DL BWP which is not the *initialDownlinkBWP*:
 - 3> start or restart the *bwp-InactivityTimer* associated with the active DL BWP.

[TS 38.331, clause 5.2.1]

System Information (SI) is divided into the *MIB* and a number of SIBs where:

- ...
- For a UE in RRC_CONNECTED, the network can provide system information through dedicated signalling using the *RRCReconfiguration* message, e.g. if the UE has an active BWP with no common search space configured to monitor system information or paging.
- For PSCell and SCells, the network provides the required SI by dedicated signalling, i.e. within an *RRCReconfiguration* message. Nevertheless, the UE shall acquire MIB of the PSCell to get SFN timing of the SCG (which may be different from MCG). Upon change of relevant SI for SCell, RAN releases and adds the concerned SCell. For PSCell, SI can only be changed with Reconfiguration with Sync.

NOTE: The physical layer imposes a limit to the maximum size a SIB can take. The maximum *SIB1* or *SI* message size is 2976 bits.

[TS 38.331, clause 5.3.5.3]

The UE shall perform the following actions upon reception of the *RRCReconfiguration*:

...

- 1> if the UE is configured with E-UTRA *nr-SecondaryCellGroupConfig* (MCG is E-UTRA):
 - 2> if *RRCReconfiguration* was received via SRB1:
 - 3> submit the *RRCReconfigurationComplete* via the EUTRA MCG embedded in E-UTRA RRC message *RRCConnectionReconfigurationComplete* as specified in TS 36.331 [10];
 - 3> if *reconfigurationWithSync* was included in *spCellConfig* of an SCG:
 - 4> initiate the random access procedure on the SpCell, as specified in TS 38.321 [3];

...

NOTE: For EN-DC, in the case *RRCReconfiguration* is received via SRB1, the random access is triggered by RRC layer itself as there is not necessarily other UL transmission. In the case *RRCReconfiguration* is received via SRB3, the random access is triggered by the MAC layer due to arrival of *RRCReconfigurationComplete*.

[TS 38.331, clause 6.3.2]

7.1.1.8.1.3 Test description

7.1.1.8.1.3.1 Pre-test conditions

Same Pre-test conditions as in clause 7.1.1.0.

7.1.1.8.1.3.2 Test procedure sequence

Table 7.1.1.8.1.3.2-1: Main behaviour

St	Procedure	Message Sequence		TP	Verdict
		U - S	Message		
0	The SS transmits RRCReconfiguration to configure the dedicated BWPs incl. the FirstActive BWP. (Note 1) (Note 4).	<--	(RRCReconfiguration)	-	-
-	EXCEPTION: Steps 0Aa1 to 0Ab2 describe behaviour which depends on procedure parameters; the "lower case letter" identifies a step sequence that take place if a procedure parameter has a particular value.	-	-	-	-
0A a1	IF pc_EN_DC = TRUE OR pc_NGEN_DC = TRUE, the UE sends RRCReconfigurationComplete (Note 2).	-->	(RRCReconfigurationComplete)	-	-
0A b1	IF pc_NG_RAN_NR = TRUE, the SS allocates (transmitted in FirstActiveDownlinkBWP) an UL Grant with DCI format 0_1 indicating FirstActiveUplinkBWP (BWP#1).	<--	UL Grant	-	-
0A b2	Check: Does the UE send RRCReconfigurationComplete in the FirstActive BWP configured. (Note 2) (Note 3) (Note 5)	-->	(RRCReconfigurationComplete)	1	P
1	The SS transmits a valid MAC PDU containing RLC PDU in the configured FirstActive Downlink BWP configured.	<--	MAC PDU	-	-
2	After 100ms from step 1, the SS allocates (transmitted in FirstActiveDownlinkBWP) an UL Grant.	<--	UL Grant	-	-
3	Check: Does the UE transmit a MAC PDU including one RLC SDU in the FirstActive BWP configured. (Note 5)	-->	MAC PDU	1	P
4	VOID			-	-
5	The SS indicates on PDCCH (transmitted in Downlink BWP#1) DL DCI format 1_1 with new BWP Id (= BWP #2) and transmits a MAC PDU containing RLC PDU on the newly configured BWP (i.e. Downlink BWP#2).	<--	MAC PDU	-	-
6	After 100ms from step5, the SS allocates (transmitted in Downlink BWP#2) an UL Grant (with DCI indicating BWP#2), sufficient for loopback of the RLC SDU from step 5 in a Slot. (Note 3)	<--	UL Grant	-	-
7	Check: Does the UE transmit a MAC PDU including one RLC SDU in the configured BWP (i.e. Uplink BWP#2)? (Note 5)	-->	MAC PDU	2	P
8	VOID	-	-	-	-

9	The SS transmits a valid MAC PDU containing RLC PDU in the configured BWP (i.e. Downlink BWP#2).	<--	MAC PDU	-	-
10	After 100ms from step 9 the SS indicates on PDCCH (transmitted in Downlink BWP#2) UL DCI format 0_1 with new BWP Id (= BWP #3) and allocates an UL Grant, sufficient for loopback of the RLC SDU from step 9 in a Slot.	<--	UL Grant	-	-
11	Check: Does the UE transmit a MAC PDU including one RLC SDU in the configured BWP (i.e. Uplink BWP#3 for FDD and for TDD)? (Note 5)	-->	MAC PDU	3	P
11 A	The SS transmits a valid MAC PDU containing RLC PDU in the configured BWP (i.e. Downlink BWP#2 for FDD or Downlink BWP#3 for TDD).	<--	MAC PDU	-	-
12	After 100ms from step 11A the SS indicates PDCCH order for contention-based random access (transmitted in Downlink BWP#2 for FDD resp. Downlink BWP#3 for TDD).	<--	PDCCH Order (ra-PreambleIndex = '000000'B)	-	-
13	Check: Does the UE send PRACH Preamble in the initial BWP (UL BWP#0)?	-->	PRACH Preamble	4	P
13 A	The SS transmits (in Downlink BWP #0) a MAC PDU addressed to UE RA-RNTI, containing RAR with matching RAPID in MAC sub header.	<--	Random Access Response	-	-
13 B	The UE sends (in UL BWP#0) a msg3 in the grant associated to the received Random Access Response.	-->	msg3 (C-RNTI MAC CONTROL ELEMENT)	-	-
13 C	SS schedules (in Downlink BWP#0) PDCCH transmission for UE C-RNTI and allocates UL grant sufficient for the UE to loop back the data received at step 11a.	<--	Contention Resolution	-	-
13 D	Check: Does the UE transmit a MAC PDU including one RLC SDU in the initial BWP (i.e. Uplink BWP#0)? (Note 5)	-->	MAC PDU	4	P
14- 15	Void	-	-	-	-
16	The SS indicates on PDCCH (transmitted in Downlink BWP#0) DL DCI format 1_1 with BWP Id (= BWP #1) and transmits a MAC PDU containing RLC PDU on the configured BWP (i.e. Downlink BWP#1).	<--	MAC PDU	-	-
17	After 400 ms from step 16, the SS transmits another valid MAC PDU containing RLC PDU in the active BWP (i.e. Downlink BWP#1).	<--	MAC PDU	-	-

18	After 400 ms from step 17, the SS allocates (transmitted in Downlink BWP#1) an UL Grant, sufficient for loopback of a MAC PDU containing both RLC SDUs from steps 16 and 17 in a Slot.	<--	UL Grant	-	-
19	Check: Does the UE transmit a MAC PDU containing both RLC SDUs in the active BWP (i.e. Uplink BWP#1)? (Note 5)	-->	MAC PDU	-	-
20	The SS waits 1000 ms from step 18 to ensure that the bwp-InactivityTimer expired and then transmits a valid MAC PDU containing RLC PDU in the BWP with defaultDownlinkBWP-Id (= Downlink BWP#2).	<--	MAC PDU	-	-
21	The SS allocates (transmitted in the defaultDownlinkBWP, i.e. Downlink BWP#2) an UL Grant, sufficient for loopback of the RLC SDU from step 20 in a Slot.	<--	UL Grant	-	-
22	Check: Does the UE transmit a MAC PDU in Uplink BWP#2 (= BWP Id of the defaultDownlinkBWP). (Note 5)	-->	MAC PDU	5	P
<p>Note 1: for EN-DC the NR <i>RRCReconfiguration</i> message is contained in <i>RRCConnectionReconfiguration</i>.</p> <p>Note 2: for EN-DC the NR <i>RRCReconfigurationComplete</i> message is contained in <i>RRCConnectionReconfigurationComplete</i>.</p> <p>Note 3: In paired spectrum (= FDD), the switching of Downlink BWP and Uplink BWP can happen independently. Whereas in TDD, the switching of BWP for Downlink and Uplink is always at the same time instance. Currently, the scope of the Test Purposes (TP) is considered to <u>not</u> cover checking of a BWP deviation which results from non-synchronized Downlink and Uplink BWP switching in FDD.</p> <p>Note 4: After the preamble the UE is in RRC_CONNECTED, therefore SRBs and DRBs are already established. The RRCReconfiguration message in step 1 and step 14 shall not contain any elements like e.g. "rlc-BearerToAddModList" whose value(s) remain unchanged since the preamble. The sole purpose of the RRCReconfiguration message in step 1 and 14 is to configure BWPs and related fields for switching of BWPs.</p> <p>Note 5: When the UE does not use the expected BWP for the UL transmission the SS shall not receive the data what implicitly fails the test case.</p>					

7.1.1.8.1.3.3 Specific message contents

Table 7.1.1.8.1.3.3-1: RRCReconfiguration (step 0)

Derivation Path: TS 38.508-1 [6], Table 4.6.1-13 (see also Note 4 in Table 7.1.1.8.1.3.2-1)			
Information Element	Value/remark	Comment	Condition
RRCReconfiguration ::= SEQUENCE {			
criticalExtensions CHOICE {			
rrcReconfiguration ::= SEQUENCE {			
secondaryCellGroup	CellGroupConfig		EN-DC
nonCriticalExtension SEQUENCE {			NR
masterCellGroup	CellGroupConfig		
}			
}			
}			

Table 7.1.1.8.1.3.3-1A: CellGroupConfig (Table 7.1.1.8.1.3.3-1)

Derivation Path: TS 38.508-1 [4], Table 4.6.3-19			
Information Element	Value/remark	Comment	Condition
CellGroupConfig ::= SEQUENCE {			
mac-CellGroupConfig	Not present		
physicalCellGroupConfig	Not present		
spCellConfig SEQUENCE {			
servCellIndex	Not present		
	ServCellIndex		EN-DC
spCellConfigCommon	Not present		
rlf-TimersAndConstants	Not present		
spCellConfigDedicated	ServingCellConfig-Dedicated	Table 7.1.1.8.1.3.3-2	
}			
reportUplinkTxDirectCurrent-v1530	true		
}			

Table 7.1.1.8.1.3.3-2: ServingCellConfig-Dedicated (Table 7.1.1.8.1.3.3-1A)

Derivation Path: TS 38.508-1 [4] Table 4.6.3-167			
Information Element	Value/remark	Comment	Condition
ServingCellConfig ::= SEQUENCE {			
tdd-UL-DL-ConfigurationDedicated	Not present		
	TDD-UL-DL-ConfigDedicated		TDD
.. initialDownlinkBWP	Not present		
downlinkBWP-ToAddModList SEQUENCE (SIZE (1..maxNrofBWPs)) BWP-Downlink {	3 entries		
BWP-Downlink[1]	BWP-Downlink-BWP-N with condition BWP#1	entry 1	
BWP-Downlink[2]	BWP-Downlink-BWP-N with condition BWP#2	entry 2	
BWP-Downlink[3]	BWP-Downlink-BWP-N with condition BWP#3	entry 3	
}			
firstActiveDownlinkBWP-Id	1		
bwp-InactivityTimer	ms500		
defaultDownlinkBWP-Id	2		
uplinkConfig SEQUENCE {			
initialUplinkBWP	Not present		
uplinkBWP-ToReleaseList	Not present		
uplinkBWP-ToAddModList SEQUENCE (SIZE (1..maxNrofBWPs)) OF BWP-Uplink {	3 entries		
BWP-Uplink[1]	BWP-Uplink-BWP-N with condition BWP#1	entry 1	
BWP-Uplink[2]	BWP-Uplink-BWP-N with condition BWP#2	entry 2	
BWP-Uplink[3]	BWP-Uplink-BWP-N with condition BWP#3	entry 3	
}			
firstActiveUplinkBWP-Id	1		
pusch-ServingCellConfig	Not present		
}			
pdcch-ServingCellConfig	Not present		
pdsch-ServingCellConfig	Not present		
}			

Condition	Explanation
BWP#1	Bandwidth part 1
BWP#2	Bandwidth part 2
BWP#3	Bandwidth part 3

Table 7.1.1.8.1.3.3-2D: ControlResourceSet-BWP-N (Table 7.1.1.8.1.3.3-2B)

Derivation Path: TS 38.508-1 [4], Table 4.6.3-28			
Information Element	Value/remark	Comment	Condition
ControlResourceSet ::= SEQUENCE {			
controlResourceSetId	9		BWP#1
	10		BWP#2
	11		BWP#3
frequencyDomainResources	10000000 00000000 00000000 00000000 00000000 000000	CORESET to use the least significant 6 RBs of each BWP	
duration	2	SearchSpace duration of 2 symbols	
}			

Table 7.1.1.8.1.3.3-2E: SearchSpace-BWP-N (Table 7.1.1.8.1.3.3-2B)

Derivation Path: TS 38.508-1 [4], Table 4.6.3-162 with condition USS			
Information Element	Value/remark	Comment	Condition
SearchSpace ::= SEQUENCE {			
searchSpaceId	37		BWP#1
	38		BWP#2
	39		BWP#3
controlResourceSetId	9		BWP#1
	10		BWP#2
	11		BWP#3
nrofCandidates SEQUENCE {			
aggregationLevel1	n0		
aggregationLevel2	n1		
aggregationLevel4	n0		
aggregationLevel8	n0		
aggregationLevel16	n0		
}			
}			

```

when { UE MAC is reset, due to reconfiguration with sync on same cell }
  then { UE flushes DL HARQ buffer }
  }

```

(2)

```

with { UE in RRC_CONNECTED state }
ensure that {
  when{ UE MAC is reset, due to reconfiguration with sync on same cell }
    then { UE considers the next transmission for each DL HARQ process as very first }
  }

```

(3)

```

with(UE in RRC_CONNECTED state, with Scheduling Request procedure triggered)
ensure that {
  when{ UE MAC is reset, due to reconfiguration with sync on same cell }
    then { UE cancels Scheduling Request procedure }
  }

```

(4)

```

with ( UE in RRC_CONNECTED state )
ensure that {
  when{ UE MAC is reset, due to reconfiguration with sync on same cell }
    then { UE flushes UL HARQ buffer }
  }

```

(5)

```

with (UE in RRC_CONNECTED state )
ensure that {
  when{ UE MAC is reset, due to reconfiguration with sync on same cell }
    then { UE Considers the next transmission for each UL HARQ process as very first }
  }

```

7.1.1.9.1.2 Conformance requirements

References: The conformance requirements covered in the present TC are specified in: TS 38.321, clauses 5.12 and TS 38.331 clause 5.3.5.5.2. Unless otherwise stated these are Rel-15 requirements.

[TS 38.321, clause 5.12]

If a reset of the MAC entity is requested by upper layers, the MAC entity shall:

- 1> initialize B_j for each logical channel to zero;
- 1> stop (if running) all timers;
- 1> consider all *timeAlignmentTimers* as expired and perform the corresponding actions in subclause 5.2;
- 1> set the NDIs for all uplink HARQ processes to the value 0;
- 1> stop, if any, ongoing RACH procedure;
- 1> discard explicitly signalled contention-free Random Access Resources, if any;
- 1> flush Msg3 buffer;
- 1> cancel, if any, triggered Scheduling Request procedure;
- 1> cancel, if any, triggered Buffer Status Reporting procedure;
- 1> cancel, if any, triggered Power Headroom Reporting procedure;
- 1> flush the soft buffers for all DL HARQ processes;
- 1> for each DL HARQ process, consider the next received transmission for a TB as the very first transmission;

1> release, if any, Temporary C-RNTI;

1> reset *BFI_COUNTER*.

[TS 38.331, clause 5.3.5.5.2]

The UE shall perform the following actions to execute a reconfiguration with sync.

1> stop timer T310 for the corresponding SpCell, if running;

1> start timer T304 for the corresponding SpCell with the timer value set to *t304*, as included in the *reconfigurationWithSync*;

1> if the *frequencyInfoDL* is included:

2> consider the target SpCell to be one on the frequency indicated by the *frequencyInfoDL* with a physical cell identity indicated by the *physCellId*;

1> else:

2> consider the target SpCell to be one on the frequency of the source SpCell with a physical cell identity indicated by the *physCellId*;

1> start synchronising to the DL of the target SpCell;

1> apply the specified BCCH configuration defined in 9.1.1.1;

1> acquire the *MIB*, which is scheduled as specified in TS 38.213 [13];

1> perform the actions specified in clause 5.2.2.4.1

NOTE 1: The UE should perform the reconfiguration with sync as soon as possible following the reception of the RRC message triggering the reconfiguration with sync, which could be before confirming successful reception (HARQ and ARQ) of this message.

NOTE 2: The UE may omit reading the MIB if the UE already has the required timing information, or the timing information is not needed for random access.

1> reset the MAC entity of this cell group;

1> consider the SCell(s) of this cell group, if configured, to be in deactivated state;

1> apply the value of the *newUE-Identity* as the C-RNTI for this cell group;

Editor's Note: Verify that this does not configure some common parameters which are later discarded due to e.g. SCell release or due to LCH release.

1> configure lower layers in accordance with the received *spCellConfigCommon*;

1> configure lower layers in accordance with any additional fields, not covered in the previous, if included in the received *reconfigurationWithSync*.

7.1.1.9.1.3 Test description

7.1.1.9.1.3.1 Pre-test conditions

Same Pre-test conditions as in clause 7.1.1.0.

Table 7.1.1.9.1.3.1-1: Void

7.1.1.9.1.3.2 Test procedure sequence

Table 7.1.1.9.1.3.2-1: Main behaviour

St	Procedure	Message Sequence		TP	Verdict
		U - S	Message		
0	The SS stops the default downlink retransmission. (Note 4)	-	-	-	-
1	The SS transmits a MAC PDU containing one RLC SDU with P field set 0 on DRB, but the CRC is calculated in such a way that it will result in CRC error on UE side.	<--	MAC PDU (1 RLC SDU of 40 bytes on DRB)	-	-
2	The UE transmits a HARQ NACK	-->	HARQ NACK	-	-
3	The SS transmits NR <i>RRCReconfiguration</i> message with <i>reconfigurationWithSync</i> with the same SpCell. (Note 1)	<--	RRCReconfiguration	-	-
4	The UE transmits an NR <i>RRCReconfigurationComplete</i> message. (Note 2)	-->	RRCReconfigurationComplete	-	-
5	Check: For 100 ms, does the UE transmit any HARQ NACK?	-->	HARQ NACK	1	F
5A	The SS ignores scheduling requests and does not allocate any uplink grant.				
6	The SS transmits a MAC PDU containing RLC SDU with P field set 0 on DRB. The HARQ Process and NDI on PDCCH is same as in step 1. The SS shall ensure that the HARQ process used at step 1 will not be used in between steps 3 and 5.	<--	MAC PDU (1 RLC SDU of 40 bytes on DRB)	-	-
7	Check: Does the UE transmit a scheduling request?	-->	(SR)	2	P
-	Exception: The SS ignores following scheduling requests before step 9.	-	-	-	-
8	The SS allocates 1 UL Grant with size 384 bits and NDI indicates new transmission. (Note 5)	<--	Uplink Grant	-	-
9	The UE transmits a MAC PDU including one RLC SDU with P field set 1.	-->	MAC PDU	-	-
9A	The SS transmits a STATUS PDU.	<--	STATUS PDU	-	-
10	Void	-	-	-	-
11	The SS transmits a MAC PDU containing one RLC SDU with P field set 0 on DRB.	<--	MAC PDU (1 RLC SDU of 40 bytes on DRB)	-	-
12	The UE transmit a scheduling request	-->	(SR)	-	-
-	Exception: The SS ignores following scheduling requests before step 14.	-	-	-	-
13	Void	-	-	-	-
14	The SS transmits NR <i>RRCReconfiguration</i> message with <i>reconfigurationWithSync</i> and RLC re-establishment on DRB with the same SpCell. (Note 1)(Note 3)	<--	RRCReconfiguration	-	-
15	The UE transmits an NR <i>RRCReconfigurationComplete</i> message. Note 2	-->	RRCReconfigurationComplete	-	-
16	Check: For 100 ms seconds, if UE transmits a scheduling request?	-->	(SR)	3	F
16 A	The SS ignores scheduling requests and does not allocate any uplink grant.	-	-	-	-
17	The SS transmits a MAC PDU containing RLC SDU with P field set 0 on DRB.	<--	MAC PDU (1 RLC SDU of 40 bytes on DRB)	-	-
18	The UE transmits a scheduling request	-->	(SR)	-	-
	Exception: The SS ignores following scheduling requests before step 20.	-	-	-	-
19	The SS allocates an UL Grant with size 384 bits for one HARQ process X, and NDI indicates new transmission. (Note 5)	<--	Uplink Grant	-	-
20	The UE transmit a MAC PDU including one RLC SDU with P field set 1.	-->	MAC PDU	-	-

20 A	The SS transmits a STATUS PDU.	<--	STATUS PDU	-	-
21	Void				
22	The SS transmits NR <i>RRCReconfiguration</i> message with <i>reconfigurationWithSync</i> with the same SpCell. Note 1	<--	RRCReconfiguration	-	-
23	The UE transmits an NR <i>RRCReconfigurationComplete</i> message. Note 2		RRCReconfigurationComplete	-	-
24	Void				
24 A	The SS ignores scheduling requests and does not allocate any uplink grant.	-	-	-	-
25	The SS transmits a MAC PDU containing RLC SDU with P field set 0 on DRB. The HARQ Process and NDI on PDCCH is same as in step 17. The SS shall ensure that the HARQ process used at step 17 will not be used in between steps 22 and 23.	<--	MAC PDU (1 RLC SDU of 40 bytes on DRB)	-	-
26	The UE transmits a scheduling request	-->	(SR)	-	-
	Exception: The SS ignores following scheduling requests before step 28.	-	-	-	-
27	The SS allocates an UL Grant with with size 384 bits corresponding to HARQ process X, with NDI not toggled compared to step 19, and NDI indicates new transmission. (Note 5)	<--	Uplink Grant	-	-
28	Check: Does UE transmit a MAC PDU including one RLC SDU of 40 bytes on DRB and P field is set 1?	-->	MAC PDU	4,5	P
29	The SS transmits a STATUS PDU.	<--	STATUS PDU	-	-
<p>Note 1: for EN-DC the NR <i>RRCReconfiguration</i> message is contained in <i>RRCConnectionReconfiguration</i>.</p> <p>Note 2: for EN-DC the NR <i>RRCReconfigurationComplete</i> message is contained in <i>RRCConnectionReconfigurationComplete</i>.</p> <p>Note 3: RLC re-establishment on DRB is used to make sure UE discard RLC PDU.</p> <p>Note 4: The SS stops the default downlink retransmission to avoid HARQ ACK for the retransmission of DRB data at step 1.</p> <p>Note 5: The UL grant of 384 bits (L_{RBs} & I_{MCS} as per 38.523-3[3] annex B) is chosen to allow the UE to transmit one PDU at a time (40 bytes RLC SDU + 3 bytes RLC Header + 2 bytes MAC Sub PDU header + 2 bytes for short BSR or padding).</p>					

7.1.1.9.1.3.3 Specific message contents

Table 7.1.1.9.1.3.3-0: SchedulingRequest-Config (Preamble)

Derivation Path: 38.508-1 [4], Table 4.6.3-155			
Information Element	Value/remark	Comment	Condition
sr-TransMax	n64		

Table 7.1.1.9.1.3.3-1: RRCReconfiguration for NR (steps 3,14 and 22 of Table 7.1.1.9.1.3.2-1)

Derivation Path: 38.508-1 [4], Table 4.6.1-13			
Information Element	Value/remark	Comment	Condition
RRCReconfiguration ::= SEQUENCE {			
criticalExtensions CHOICE {			
rrcReconfiguration ::= SEQUENCE {			
radioBearerConfig	RadioBearerConfig according to TS 38.508-1 [4], table 4.6.3-132 with condition DRBn	n set to the default DRB of the first PDU session	NR
nonCriticalExtension SEQUENCE {			
masterCellGroup	CellGroupConfig according to TS 38.508-1 [4], table 4.6.3-19 with condition PCell_change		
}			
}			
}			
}			

Table 7.1.1.9.1.3.3-2: RRCConnectionReconfiguration for EN-DC (step 3, 14 and 22 of Table 7.1.1.9.1.3.2-1)

Derivation Path: 36.508 Table 4.6.1-8			
Information Element	Value/remark	Comment	Condition
RRCConnectionReconfiguration ::= SEQUENCE {			
criticalExtensions CHOICE {			
c1 CHOICE{			
rrcConnectionReconfiguration-r8 ::= SEQUENCE {			
nonCriticalExtension ::= SEQUENCE {			
nonCriticalExtension ::= SEQUENCE {			
nonCriticalExtension ::= SEQUENCE {			
nr-Config-r15 CHOICE {			
nr-SecondaryCellGroupConfig-r15	OCTET STRING including the RRCReconfiguration message and the IE secondaryCellGroup according TS 38.508-1 [67], table 4.6.1-13 with condition EN-DC_HO		
}			
}			
nr-RadioBearerConfig1-r15	OCTET STRING including RadioBearerConfig according TS 38.508-1 [67], table 4.6.3-132 with conditions EN-DC_DRB		
}			
}			
}			
}			
}			

7.1.1.10 Other Procedures

7.1.1.10.1 DataInactivityTimer expiry

7.1.1.10.1.1 Test Purpose (TP)

(1)

```
with { UE in NR RRC_CONNECTED state and dataInactivityTimer configured and running }
ensure that {
  when { UE receives or transmits MAC SDU from DRB }
  then { UE restarts the dataInactivityTimer }
}
```

(2)

```
with { UE in NR RRC_CONNECTED state and dataInactivityTimer configured and running }
ensure that {
  when { UE detecting data inactivity on expiry of DataInactivityTimer }
  then { UE enters RRC_IDLE state }
}
```

7.1.1.10.1.2 Conformance requirements

References: The conformance requirements covered in the present TC are specified in: 3GPP TS 38.321 clause 5.19 and TS 38.331 clause 5.3.8.5.

[TS 38.321, clause 5.19]

The UE may be configured by RRC with a Data inactivity monitoring functionality, when in RRC_CONNECTED. RRC controls Data inactivity operation by configuring the timer *dataInactivityTimer*.

When *dataInactivityTimer* is configured, the UE shall:

- 1> if any MAC entity receives a MAC SDU for DTCH logical channel, DCCH logical channel, or CCCH logical channel; or
- 1> if any MAC entity transmits a MAC SDU for DTCH logical channel, or DCCH logical channel:
 - 2> start or restart *dataInactivityTimer*.
- 1> if the *dataInactivityTimer* expires:
 - 2> indicate the expiry of the *dataInactivityTimer* to upper layers.

[TS 38.331 clause 5.3.8.5]

Upon receiving the expiry of *DataInactivityTimer* from lower layers while in RRC_CONNECTED, the UE shall:

- 1> perform the actions upon going to RRC_IDLE as specified in 5.3.11, with release cause 'RRC connection failure'.

7.1.1.10.1.3 Test description

7.1.1.10.1.3.1 Pre-test conditions

System Simulator:

- NR Cell 1.

UE:

- None.

Preamble:

- The UE is in state 3N-A and Test Mode Activated according to 38.508-1 [4] Table 4.4A.2-1 with UE test loop mode B is established IP PDU delay set to 6 seconds.

7.1.1.10.1.3.2 Test procedure sequence

Table 7.1.1.10.1.3.2-1: Main behaviour

St	Procedure	Message Sequence		TP	Verdict
		U - S	Message		
1	The SS waits (dataInactivityTimer/2 + 1) seconds	-	-	-	-
2	SS transmits a downlink assignment including the C-RNTI assigned to the UE	<--	(PDCCH (C-RNTI))	-	-
3	SS transmits in the indicated downlink assignment a RLC PDU in a MAC PDU.	<--	MAC PDU	-	-
4	Void	-	-	-	-
5	Void	-	-	-	-
6	Check: Does the UE transmits a MAC PDU containing Loop backed PDU on expiry of IP PDU delay?	-->	MAC PDU (containing 1 MAC sub PDU containing RLC SDU)	1	P
7-12	Repeat steps 1-6	-	-	-	-
13	SS waits dataInactivityTimer seconds for the UE to enter RRC_IDLE.	-	-	-	-
14	Check: Does the test result of generic test procedure in TS 38.508-1 [4] Table 4.9.5.2.2-1 indicate that the UE is in RRC_IDLE?	-	-	2	-

7.1.1.10.1.3.3 Specific Message Contents

Table 7.1.1.10.1.3.3-1: MAC-CellGroupConfig (preamble)

Derivation path: 38.508-1[4], table 4.6.3-68			
Information Element	Value/Remark	Comment	Condition
MAC-CellGroupConfig ::= SEQUENCE {			
dataInactivityTimer	s10		
}			

Table 7.1.1.10.1.3.3-2: CLOSE UE TEST LOOP (Preamble)

Derivation path: 36.508-1 [7] table 4.7A-3 condition UE test loop mode B			
Information Element	Value/Remark	Comment	Condition
UE test loop mode B LB setup			
IP PDU delay	'0000 0110'B	6 seconds	

7.1.1.10.2 Recommended Bit Rate

7.1.1.10.2.1 Test Purpose (TP)

(1)

```

with { UE in RRC Connected state and MMTEL call established}
ensure that {
  when { IF upper Layers requested to query the gNB for the recommended bit rate for a logical
channel and for a direction and bitRateQueryProhibitTimer is not running }
  then { UE transmits a Recommended Bit Rate Query MAC Control Element }
}

```

(2)

```

with(UE in RRC Connected state and MMTEL call established)
ensure that {
  when{ IF upper Layers requested to query the gNB for the recommended bit rate for a logical
channel and for a direction and bitRateQueryProhibitTimer is running}
    then { UE does not transmits a Recommended Bit Rate Query MAC Control Element}
}

```

(3)

```

with ( UE in RRC Connected state and MMTEL call established)
ensure that {
  when{ UE receives from the gNB for the recommended bit rate for a logical channel and for a
direction }
    then { UE starts applying the recommended bit Rate }
}

```

7.1.1.10.2.2 Conformance requirements

References: The conformance requirements covered in the present TC are specified in: TS 38.321, clauses 5.18.10 and 6.1.20. Unless otherwise stated these are Rel-15 requirements.

[TS 38.321, clause 5.18.10]

The recommended bit rate procedure is used to provide the MAC entity with information about the bit rate which the gNB recommends. The bit rate is the recommended bit rate of the physical layer. Averaging window of default value 2000 ms will apply as specified in TS 26.114 [13].

The gNB may transmit the Recommended bit rate MAC CE to the MAC entity to indicate the recommended bit rate for the UE for a specific logical channel and a specific direction (either uplink or downlink). Upon reception of a Recommended bit rate MAC CE the MAC entity shall:

- indicate to upper layers the recommended bit rate for the indicated logical channel and direction.

The MAC entity may request the gNB to indicate the recommended bit rate for a specific logical channel and a specific direction. If the MAC entity is requested by upper layers to query the gNB for the recommended bit rate for a logical channel and for a direction (i.e. for uplink or downlink), the MAC entity shall:

- 1> if a Recommended bit rate query for this logical channel and this direction has not been triggered:
- 2> trigger a Recommended bit rate query for this logical channel, direction, and desired bit rate.

If the MAC entity has UL resources allocated for new transmission the MAC entity shall:

- 1> for each Recommended bit rate query that the Recommended Bit Rate procedure determines has been triggered and not cancelled:
 - 2> if *bitRateQueryProhibitTimer* for the logical channel and the direction of this Recommended bit rate query is configured, and it is not running; and
 - 2> if the MAC entity has UL resources allocated for new transmission and the allocated UL resources can accommodate a Recommended bit rate MAC CE plus its subheader as a result of LCP as defined in clause 5.4.3.1:
 - 3> instruct the Multiplexing and Assembly procedure to generate the Recommended bit rate MAC CE for the logical channel and the direction of this Recommended bit rate query;
 - 3> start the *bitRateQueryProhibitTimer* for the logical channel and the direction of this Recommended bit rate query;
 - 3> cancel this Recommended bit rate query.

[TS 38.321, clause 6.1.20]

The Recommended bit rate MAC CE is identified by a MAC subheader with LCID as specified in Tables 6.2.1-1 and 6.2.1-2 for bit rate recommendation message from the gNB to the UE and bit rate recommendation query message from the UE to the gNB, respectively. It has a fixed size and consists of two octets defined as follows (Figure 6.1.3.20-1):

Table 6.1.3.20-1: Values (kbit/s) for Bit Rate field

Index	NR Recommended Bit Rate value [kbit/s]	Index	NR Recommended Bit Rate value [kbit/s]
0	Note 1	32	700
1	0	33	800
2	9	34	900
3	11	35	1000
4	13	36	1100
5	17	37	1200
6	21	38	1300
7	25	39	1400
8	29	40	1500
9	32	41	1750
10	36	42	2000
11	40	43	2250
12	48	44	2500
13	56	45	2750
14	72	46	3000
15	88	47	3500
16	104	48	4000
17	120	49	4500
18	140	50	5000
19	160	51	5500
20	180	52	6000
21	200	53	6500
22	220	54	7000
23	240	55	7500
24	260	56	8000
25	280	57	Reserved
26	300	58	Reserved
27	350	59	Reserved
28	400	60	Reserved
29	450	61	Reserved
30	500	62	Reserved
31	600	63	Reserved
Note 1: For bit rate recommendation message this index is used for indicating that no new recommendation on bit rate is given.			

7.1.1.10.2.3 Test description

7.1.1.10.2.3.1 Pre-test conditions

System Simulator:

- NR Cell 1
- System information combination NR-1 as defined in TS 38.508-1 [4] clause 4.4.3.1.3 is used in NR cell.

UE:

- None.

Preamble:

- The UE is in 5GS state 1N-A according to TS 38.508-1 [4], clause 4.4A.2 Table 4.4A.2-1.

7.1.1.10.2.3.2 Test procedure sequence

Table 7.1.1.10.2.3.2-2: Main behaviour

St	Procedure	Message Sequence		TP	Verdict
		U - S	Message		
1	The procedure in table 4.9.15.2.2-1 in TS 38.508-1 [4] is performed. The bitRateQueryProhibitTimer for the Logical channel of MMTEL QoS Flow is configured as s3 (3 seconds).	-	-	-	-
2	Trigger the UE to perform Recommended Bit Rate query for direction Downlink via AT (+CGBRRREQ) or MMI command.	-	-	-	-
3	Check: UE Transmits a MAC PDU containing Recommended bit rate MAC CE with Uplink/Downlink (UL/DL) set as 0?	->	MAC PDU	1	P
4	Trigger the UE to perform Recommended Bit Rate query for direction Uplink via AT (+CGBRRREQ) or MMI command.	-	-	-	-
5	Check: UE Transmits a MAC PDU containing Recommended bit rate MAC CE with Uplink/Downlink (UL/DL) set as 1?	->	MAC PDU	1	P
6	SS transmits a MAC PDU containing Recommended bit rate MAC CE with Uplink/Downlink (UL/DL) set as 0 and Bit Rate Same as value received in step 5.	<-	MAC PDU	-	-
7	Trigger the UE to perform Recommended Bit Rate query for direction Up Link via AT (+CGBRRREQ) or MMI command.	-	-	-	-
8	Check: UE Transmits a MAC PDU containing Recommended bit rate MAC CE ?	->	MAC PDU	2	P
9	While bitRateQueryProhibitTimer is running (3 seconds) in UE, Trigger the UE to perform Recommended Bit Rate query for direction Up Link via AT (+CGBRRREQ) or MMI command.	-	-	-	-
10	Check: While bitRateQueryProhibitTimer is running UE Transmits a MAC PDU containing Recommended bit rate MAC CE ?	->	MAC PDU	2	F
11	Check: After bitRateQueryProhibitTimer expires UE Transmits a MAC PDU containing Recommended bit rate MAC CE with Uplink/Downlink (UL/DL) set as 1?	->	MAC PDU	2	P
12	SS transmits a MAC PDU containing Recommended bit rate MAC CE with Uplink/Downlink (UL/DL) set as 1 and Bit Rate Same as value received in step1c1.	<-	MAC PDU	-	-
13	Exception: step 14 is repeated 10 times	-	-	-	-
14	SS transmits a MAC PDU including a RLC SDU of 1000 bytes.	<-	MAC PDU	-	-
15	Exception: step 16 is repeated 10 times	-	-	-	-
16	Check: Does the UE transmit a MAC PDU corresponding to step 10?	-->	MAC PDU	3	P

Note: The bitRateQueryProhibitTimer is configured only for UL direction as per asn.1 definition.

7.1.1.10.2.3.3 Specific message contents

None

7.1.1.11 NR Dual Connectivity

7.1.1.11.1 DC power headroom reporting / PSCell activation and DL pathloss change reporting

7.1.1.11.1.1 Test Purpose (TP)

(1)

```
with { UE in RRC_CONNECTED state on Pcell }
ensure that {
  when { PSCell is added }
  then { UE transmits a Power Headroom Report for the PCell and PSCell }
}
```

(2)

```
with { UE in RRC_CONNECTED state with PSCell and with Power headroom reporting for phr-Tx-
PowerFactorChange }
ensure that {
  when { the DL Pathloss has changed more than phr-Tx-PowerFactorChange dB and phr-ProhibitTimer is
running }
  then { UE does not transmit a MAC PDU containing Power Headroom MAC Control Element }
}
```

(3)

```
with { UE in RRC_CONNECTED state with PSCell and with Power headroom reporting for phr-Tx-
PowerFactorChange }
ensure that {
  when { the phr-ProhibitTimer expires and power headroom report is triggered due to DL Pathloss
change }
  then { UE transmits a MAC PDU containing Power Headroom MAC Control Element for the Pcell and
PSCell }
}
```

7.1.1.11.1.2 Conformance requirements

References: The conformance requirements covered in the present TC are specified in: 3GPP TS 38.321 clause 5.4.6

[TS 38.321, clause 5.4.6]

A Power Headroom Report (PHR) shall be triggered if any of the following events occur:

- *phr-ProhibitTimer* expires or has expired and the path loss has changed more than *phr-Tx-PowerFactorChange* dB for at least one activated Serving Cell of any MAC entity which is used as a pathloss reference since the last transmission of a PHR in this MAC entity when the MAC entity has UL resources for new transmission;

NOTE 1: The path loss variation for one cell assessed above is between the pathloss measured at present time on the current pathloss reference and the pathloss measured at the transmission time of the last transmission of PHR on the pathloss reference in use at that time, irrespective of whether the pathloss reference has changed in between.

- *phr-PeriodicTimer* expires;
- upon configuration or reconfiguration of the power headroom reporting functionality by upper layers, which is not used to disable the function;
- activation of an SCell of any MAC entity with configured uplink;
- addition of the PSCell (i.e. PSCell is newly added or changed);
- *phr-ProhibitTimer* expires or has expired, when the MAC entity has UL resources for new transmission, and the following is true for any of the activated Serving Cells of any MAC entity with configured uplink:
 - there are UL resources allocated for transmission or there is a PUCCH transmission on this cell, and the required power backoff due to power management (as allowed by P-MPR_c as specified in TS 38.101-1 [14],

TS 38.101-2 [15], and TS 38.101-3 [16]) for this cell has changed more than *phr-Tx-PowerFactorChange* dB since the last transmission of a PHR when the MAC entity had UL resources allocated for transmission or PUCCH transmission on this cell.

NOTE 2: The MAC entity should avoid triggering a PHR when the required power backoff due to power management decreases only temporarily (e.g. for up to a few tens of milliseconds) and it should avoid reflecting such temporary decrease in the values of $P_{\text{CMAX},f,c}/\text{PH}$ when a PHR is triggered by other triggering conditions.

If the MAC entity has UL resources allocated for a new transmission the MAC entity shall:

- 1> if it is the first UL resource allocated for a new transmission since the last MAC reset:
 - 2> start *phr-PeriodicTimer*;
- 1> if the Power Headroom reporting procedure determines that at least one PHR has been triggered and not cancelled; and
- 1> if the allocated UL resources can accommodate the MAC CE for PHR which the MAC entity is configured to transmit, plus its subheader, as a result of LCP as defined in clause 5.4.3.1:
 - 2> if *multiplePHR* with value *true* is configured:
 - 3> for each activated Serving Cell with configured uplink associated with any MAC entity:
 - 4> obtain the value of the Type 1 or Type 3 power headroom for the corresponding uplink carrier as specified in clause 7.7 of TS 38.213 [6] for NR Serving Cell and clause 5.1.1.2 of TS 36.213 [17] for E-UTRA Serving Cell;
 - 4> if this MAC entity has UL resources allocated for transmission on this Serving Cell; or
 - 4> if the other MAC entity, if configured, has UL resources allocated for transmission on this Serving Cell and *phr-ModeOtherCG* is set to *real* by upper layers:
 - 5> obtain the value for the corresponding $P_{\text{CMAX},f,c}$ field from the physical layer.
 - 3> if *phr-Type2OtherCell* with value *true* is configured:
 - 4> if the other MAC entity is E-UTRA MAC entity:
 - 5> obtain the value of the Type 2 power headroom for the SpCell of the other MAC entity (i.e. E-UTRA MAC entity);
 - 5> if *phr-ModeOtherCG* is set to *real* by upper layers:
 - 6> obtain the value for the corresponding $P_{\text{CMAX},f,c}$ field for the SpCell of the other MAC entity (i.e. E-UTRA MAC entity) from the physical layer.
 - 3> instruct the Multiplexing and Assembly procedure to generate and transmit the Multiple Entry PHR MAC CE as defined in clause 6.1.3.9 based on the values reported by the physical layer.
 - 2> else (i.e. Single Entry PHR format is used):
 - 3> obtain the value of the Type 1 power headroom from the physical layer for the corresponding uplink carrier of the PCell;
 - 3> obtain the value for the corresponding $P_{\text{CMAX},f,c}$ field from the physical layer;
 - 3> instruct the Multiplexing and Assembly procedure to generate and transmit the Single Entry PHR MAC CE as defined in clause 6.1.3.8 based on the values reported by the physical layer.
 - 2> start or restart *phr-PeriodicTimer*;
 - 2> start or restart *phr-ProhibitTimer*;
 - 2> cancel all triggered PHR(s).

7.1.1.11.1.3 Test description

7.1.1.11.1.3.1 Pre-test conditions

System Simulator:

- NR Cell 1 is the PCell and NR Cell 10 is the PSCell.

UE:

- None.

Preamble:

- The UE is in state NR RRC_CONNECTED using generic procedure parameter Connectivity (*NR-DC*), Test Mode (*On*) associated with UE test loop mode A configured on NR Cell 1 according to TS 38.508-1 [4], clause 4.5.4.

7.1.1.11.1.3.2 Test procedure sequence

Table 7.1.1.11.1.3.2-0: Cell configuration power level changes over time for FR1

	Parameter	Unit	NR Cell 1	NR Cell 10	Remarks
T0	Cell-specific RS EPRE	dBm/SC S	-82	off	
T1	Cell-specific RS EPRE	dBm/SC S	-89	-82	
T2	Cell-specific RS EPRE	dBm/SC S	-82	-82	
T3	Cell-specific RS EPRE	dBm/SC S	-82	-89	
T4	Cell-specific RS EPRE	dBm/SC S	-82	-82	

Table 7.1.1.11.1.3.2-0A: Cell configuration power level changes over time for FR2

	Parameter	Unit	NR Cell 1	NR Cell 10	Remarks
T0	Cell-specific RS EPRE	dBm/SC S	-82	off	
T1	Cell-specific RS EPRE	dBm/SC S	-91	-82	
T2	Cell-specific RS EPRE	dBm/SC S	-82	-82	
T3	Cell-specific RS EPRE	dBm/SC S	-82	-91	
T4	Cell-specific RS EPRE	dBm/SC S	-82	-82	

Table 7.1.1.11.1.3.2-1: Main behaviour

St	Procedure	Message Sequence		TP	Verdict
		U - S	Message		
1	The SS transmits UL grant to the UE at every 10ms in PDCCH occasion.	<--	-	-	-
2	SS transmits NR <i>RRCReconfiguration</i> message to configure to specific Power Headroom parameters for NR Cell	<--	<i>RRCReconfiguration</i>	-	-
3	Check: does the UE transmit a MAC PDU containing Multiple-Entry PHR MAC CE? (Note 1)	-->	MAC PDU	1	P
4	The UE transmits an NR <i>RRCReconfigurationComplete</i> message including nr-SCG-Response (Note 2,3)	-->	<i>(RRCReconfigurationComplete)</i>	-	-
5	Wait for T= 10% of <i>prohibitPHR-Timer</i> .from step 3	-	-	-	-
6	Reduce SS power level for NR PCell so as to cause a DL_Pathloss change at UE by 5dB, row T1 of Table 7.1.1.11.1.3.2-0/OA.	-	-	-	-
7	Check: for 80% of <i>prohibitPHR-Timer</i> since step 3, does the UE transmit a MAC PDU containing Multiple-Entry PHR MAC CE?	-->	MAC PDU	2	F
8	Check: after <i>prohibitPHR-Timer</i> after step 3, does the UE transmit a MAC PDU containing Multiple-Entry PHR MAC CE?	-->	MAC PDU	3	P
9	Increase SS power level for NR PCell so as to cause a DL_Pathloss change at UE by 5dB, row T2 of Table 7.1.1.11.1.3.2-0/OA.	-	-	-	-
10	Check: for 80% of <i>prohibitPHR-Timer</i> since step 8, does the UE transmit a MAC PDU containing Power Headroom MAC Control Element?	-->	MAC PDU	2	F
11	Check: after <i>prohibitPHR-Timer</i> after step 8, does the UE transmit a MAC PDU containing Power Headroom MAC Control Element?	-->	MAC PDU	3	P
12	Wait for T= 10% of <i>prohibitPHR-Timer</i> .from step 11	-	-	-	-
13	Reduce SS power level for NR PSCell so as to cause a DL_Pathloss change at UE by 5dB, row T3 of Table 7.1.1.11.1.3.2-0/OA.	-	-	-	-
14	Check: for 80% of <i>prohibitPHR-Timer</i> since step 11, does the UE transmit a MAC PDU containing Multiple-Entry PHR MAC CE?	-->	MAC PDU	2	F
15	Check: after <i>prohibitPHR-Timer</i> after step 11, does the UE transmit a MAC PDU containing Multiple-Entry PHR MAC CE?	-->	MAC PDU	3	P
16	Increase SS power level for NR PSCell so as to cause a DL_Pathloss change at UE by 5dB, row T4 of Table 7.1.1.11.1.3.2-0/OA.	-	-	-	-
17	Check: for 80% of <i>prohibitPHR-Timer</i> since step 15, does the UE transmit a MAC PDU containing Power Headroom MAC Control Element?	-->	MAC PDU	2	F
18	Check: after <i>prohibitPHR-Timer</i> after step 15, does the UE transmit a MAC PDU containing Power Headroom MAC Control Element?	-->	MAC PDU	3	P
19	The SS transmits an NR <i>RRCReconfiguration</i> message to disable Power Headroom reporting	<--	<i>RRCReconfiguration</i>	-	-
20	The UE transmits an NR <i>RRCReconfigurationComplete</i> message to confirm the disabling of Power Headroom parameters	-->	<i>RRCReconfigurationComplete</i>	-	-
Note 1: Steps 3 and 4 can happen in any order.					
Note 2: Steps 10 and 11 can happen in any order.					

7.1.1.11.1.3.3 Specific Message Contents

Table 7.1.1.11.1.3.3-2: CellGroupConfig (step 2, Table 7.1.1.11.1.3.2-1)

Derivation Path: 38.508-1 [4], Table 4.6.3-19			
Information Element	Value/remark	Comment	Condition
cellGroupConfig ::= SEQUENCE {			
mac-CellGroupConfig SEQUENCE {			
phr-Config CHOICE {			
setup SEQUENCE {			
phr-PeriodicTimer	infinity		
phr-ProhibitTimer	sf500		
phr-Tx-PowerFactorChange	dB3		
multiplePHR	true		
dummy	false		
phr-Type2OtherCell	false		
phr-ModeOtherCG	real		
}			
}			
}			
}			

7.1.1.12 UE power saving

7.1.1.12.1 Cross-slot scheduling / DCI 1_1

7.1.1.12.1.1 Test Purpose (TP)

(1)

```
with { UE in RRC_CONNECTED state with minimumSchedulingOffsetK0 is configured in the active DL BWP }
ensure that {
  when { UE receives DCI format 1_1 without the field of minimum applicable scheduling offset indicator }
  then { UE applies the default value configured by minimumSchedulingOffsetK0 and decodes the corresponding PDSCH in the correct slot }
```

(2)

```
with { UE in RRC_CONNECTED state with minimumSchedulingOffsetK0 is configured in the active DL BWP }
ensure that {
  when { UE receives DCI format 1_1 with the value of minimum applicable scheduling offset indicator is 1 }
  then { UE applies the second value configured by minimumSchedulingOffsetK0 and decodes the corresponding PDSCH in the correct slot }
```

7.1.1.12.1.2 Conformance requirements

References: The conformance requirements covered in the present TC are specified in: TS 38.212, clause 7.3.1.2.2, TS 38.214, clause 5.1.2.1 and 5.3.1. Unless otherwise stated these are Rel-15 requirements.

[TS 38.212, clause 7.3.1.2.2]

DCI format 1_1 is used for the scheduling of PDSCH in one cell.

The following information is transmitted by means of the DCI format 1_1 with CRC scrambled by C-RNTI or CS-RNTI or MCS-C-RNTI:

...

- Minimum applicable scheduling offset indicator – 0 or 1 bit

- 0 bit if higher layer parameter *minimumSchedulingOffsetK0* is not configured;
- 1 bit if higher layer parameter *minimumSchedulingOffsetK0* is configured. The 1 bit indication is used to determine the minimum applicable K0 for the active DL BWP and the minimum applicable K2 value for the active UL BWP, if configured respectively, according to Table 7.3.1.1.2-33. If the minimum applicable K0 is indicated, the minimum applicable value of the aperiodic CSI-RS triggering offset for an active DL BWP shall be the same as the minimum applicable K0 value.

...

Table 7.3.1.1.2-33: Joint indication of minimum applicable scheduling offset K0/K2

Bit field mapped to index	Minimum applicable K0 for the active DL BWP, if <i>minimumSchedulingOffsetK0</i> is configured for the DL BWP	Minimum applicable K2 for the active UL BWP, if <i>minimumSchedulingOffsetK2</i> is configured for the UL BWP
0	The first value configured by <i>minimumSchedulingOffsetK0</i> for the active DL BWP	The first value configured by <i>minimumSchedulingOffsetK2</i> for the active UL BWP
1	The second value configured by <i>minimumSchedulingOffsetK0</i> for the active DL BWP if the second value is configured; 0 otherwise	The second value configured by <i>minimumSchedulingOffsetK2</i> for the active UL BWP if the second value is configured; 0 otherwise

[TS 38.214, clause 5.1.2.1]

When the UE configured with [*minimumSchedulingOffset*] in an active DL BWP it applies a minimum scheduling offset restriction indicated by the ['Minimum applicable scheduling offset indicator'] field in DCI format 0_1 or 1_1. When the UE configured with [*minimumSchedulingOffset*] in active DL BWP and it has not received ['Minimum applicable scheduling offset indicator'] field in DCI format 0_1 or 1_1, UE shall apply a minimum scheduling offset restriction indicated based on ['Minimum applicable scheduling offset indicator'] value '0'. When the *minimum scheduling offset restriction* is applied the UE is not expected to be scheduled with a DCI in slot *n* to receive a PDSCH scheduled with C-RNTI, CS-RNTI or MCS-C-RNTI with *K0* smaller than the applicable minimum scheduling offset restriction *K0min*. The minimum scheduling offset restriction is not applied when PDSCH transmission is scheduled with C-RNTI, CS-RNTI or MCS-C-RNTI in common search space associated with CORESET0 and default PDSCH time domain resource allocation is used or when PDSCH transmission is scheduled with SI-RNTI or RA-RNTI. The application delay of the change of the minimum scheduling offset restriction is determined in Clause 5.3.1.

[TS 38.214, clause 5.3.1]

When the UE is scheduled with DCI format 0_1 or 1_1 with a ['Minimum applicable scheduling offset indicator'] field, it shall determine the *K0min* and *K2min* values to be applied, while the previously applied *K0min* and *K2min* values are applied until the new values take effect after application delay. Change of applied minimum scheduling offset restriction indication carried by DCI in slot *n*, shall be applied in slot *n+X* of the scheduling cell. The UE does not expect to be scheduled with DCI format 0_1 or 1_1 with ['Minimum applicable scheduling offset indicator'] field indicating another change to the applied *K0min* or *K2min* for the same active BWP before slot *n+X* of the scheduling cell.

When the DCI format 0_1 or 1_1 with ['Minimum applicable scheduling offset indicator'] field indicating a change to the applied *K0min* or *K2min* is contained within the first three symbols of the slot, the value of application delay *X* is determined by, $X = \max \left(\left\lceil K_{0minOld} \cdot \frac{\mu_{PDSCH}}{\mu_{PDCCCH}} \right\rceil, Z_{\mu} \right)$ where *K0minOld* is the currently applied *K0min* value of the active DL BWP in the scheduled cell, and *Z_μ* is determined by the subcarrier spacing of the active DL BWP in the scheduling cell, and given in Table 5.3.1-1 and μ_{PDCCCH} and μ_{PDSCH} are the sub-carrier spacing configurations for PDCCCH and PDSCH, respectively

When the DCI format 0_1 or 1_1 with ['Minimum applicable scheduling offset indicator'] field is received outside the first [three] symbols of the slot, value of *Z_μ* from Table 5.3.1-1 is incremented by one before determining the application delay *X*.

Table 5.3.1-1: Definition of Z_{μ}

μ	Z_{μ}
0	1
1	1
2	2
3	2

7.1.1.12.1.3 Test description

7.1.1.12.1.3.1 Pre-test conditions

Same Pre-test conditions as in clause 7.1.1.0 except that set to return no data in uplink.

7.1.1.12.1.3.2 Test procedure sequence

Table 7.1.1.12.1.3.2-1: Main behaviour

St	Procedure	Message Sequence		TP	Verdict
		U - S	Message		
1	SS transmits an RRCReconfiguration message to configure specific scheduling offset parameters. (Note 3)	<--			
2	The UE transmits an RRCReconfigurationComplete. (Note 4)	-->			
3	The SS transmits the DCI 1-1 at the first symbol of slot n1 on the PDCCH without the field of minimum applicable scheduling offset indicator.	<--	(PDCCH (DCI 1-1))		
4	The SS indicates the transmission of a DL MAC PDU in the slot which is X1 slots after n1 slot on the PDSCH. (Note 1)	<--	MAC PDU		
5	Check: Does the UE transmit a HARQ ACK for the DL MAC PDU in Step 4?	-->	HARQ ACK	1	P
6	The SS transmits a DCI 1-1 at the first symbol of slot n2 on the PDCCH with the value of minimum applicable scheduling offset indicator is 1.	<--	(PDCCH (DCI 1-1))		
7	The SS indicates the transmission a DL MAC PDU in the slot which is X2 slots after n2 slot on the PDSCH. (Note 2)	<--	MAC PDU		
8	Check: Does the UE transmit a HARQ ACK for the DL MAC PDU in Step 7?	-->	HARQ ACK	2	P
Note 1: X1 is the first value configured by minimumSchedulingOffsetK0-r16. Note 2: X2 is the second value configured by minimumSchedulingOffsetK0-r16. Note 3: For EN-DC the NR RRCReconfiguration message is contained in RRCConnectionReconfiguration 36.508 [7], Table 4.6.1-8 using condition EN-DC_EmbedNR_RRCRecon. Note 4: For EN-DC the NR RRCReconfigurationComplete message is contained in RRCConnectionReconfigurationComplete.					

7.1.1.12.1.3.3 Specific message contents

Table 7.1.1.12.1.3.3-1: RRCReconfiguration (step 1)

Derivation Path: TS 38.508-1 [6], Table 4.6.1-13			
Information Element	Value/remark	Comment	Condition
RRCReconfiguration ::= SEQUENCE {			
criticalExtensions CHOICE {			
rrcReconfiguration ::= SEQUENCE {			
secondaryCellGroup	CellGroupConfig		EN-DC
nonCriticalExtension ::= SEQUENCE {}	Not present		EN-DC
nonCriticalExtension SEQUENCE {			NR
masterCellGroup	CellGroupConfig		
}			
}			
}			
}			

Table 7.1.1.12.1.3.3-2: CellGroupConfig (Table 7.1.1.12.1.3.3-1: RRCReconfiguration)

Derivation Path: TS 38.508-1 [4], Table 4.6.3-19			
Information Element	Value/remark	Comment	Condition
CellGroupConfig ::= SEQUENCE {			
spCellConfig SEQUENCE {			
spCellConfigDedicated	ServingCellConfig		
}			
}			

Table 7.1.1.12.1.3.3-3: ServingCellConfig (Table 7.1.1.12.1.3.3-2: CellGroupConfig)

Derivation Path: TS 38.508-1 [4], Table 4.6.3-167			
Information Element	Value/remark	Comment	Condition
ServingCellConfig ::= SEQUENCE {			
uplinkConfig SEQUENCE {			
initialDownlinkBWP	BWP-DownlinkDedicated		
}			
}			

Table 7.1.1.12.1.3.3-4: BWP-DownlinkDedicated (Table 7.1.1.12.1.3.3-3: ServingCellConfig)

Derivation Path: TS 38.508-1 [4], Table 4.6.3-11			
Information Element	Value/remark	Comment	Condition
BWP-DownlinkDedicated ::= SEQUENCE {			
pdsch-Config CHOICE {			
setup	PDSCH-Config		
}			
}			

Table 7.1.1.12.1.3.3-5: PDSCH-Config (Table 7.1.1.12.1.3.3-4: BWP-DownlinkDedicated)

Derivation Path: TS 38.331 [6], clause 6.3.2			
Information Element	Value/remark	Comment	Condition
PDSCH-Config ::= SEQUENCE {			
minimumSchedulingOffsetK0-r16 ::= CHOICE {			
setup SEQUENCE {			
maxK0-SchedulingOffset-r16 [1]	5		
maxK0-SchedulingOffset-r16 [2]	15		
}			
}			
}			

7.1.1.12.2

7.1.1.12.3 DRX adaptation / UE wakeup indication

7.1.1.12.3.1 Test Purpose (TP)

(1)

```

with { UE in RRC_CONNECTED state and long DRX is configured and [(SFN * 10) + subframe number]
modulo (drx-LongCycle) = drx-StartOffset and DCP is configured }
ensure that {
  when { UE receives a DCP indication with the value of wake-up indication is 1 }
  then { UE starts the drx-onDurationTimer after drx-SlotOffset from the beginning of the subframe
and monitors the PDCCH }
}

```

(2)

```

with { UE in RRC_CONNECTED state and long DRX is configured and [(SFN * 10) + subframe number]
modulo (drx-LongCycle) = drx-StartOffset and DCP is configured }
ensure that {
  when { UE receives ps-wakeup with the value configured true }
  then { UE starts the drx-onDurationTimer after drx-SlotOffset from the beginning of the subframe
and monitors the PDCCH for OnDurationTimer PDCCH-Occasions }
}

```

(3)

```

with { UE in RRC_CONNECTED state long DRX is configured and [(SFN * 10) + subframe number] modulo
(drx-LongCycle) = drx-StartOffset and DCP is configured }
ensure that {
  when { all DCP occasions in time domain occurred in DRX active time }
  then { UE starts the drx-onDurationTimer after drx-SlotOffset from the beginning of the subframe
and monitors the PDCCH }
}

```

(4)

```

with { UE in RRC_CONNECTED state long DRX is configured and DCP is configured}
ensure that {
  when { all DCP occasions in time domain occurred during measurement gap }
  then { UE starts the drx-onDurationTimer after drx-SlotOffset from the beginning of the subframe
and monitors the PDCCH }
}

```

7.1.1.12.3.2 Conformance requirements

References: The conformance requirements covered in the present TC are specified in: TS 38.321, clause 5.7, TS 38.213, clause 10.3 and 7.3.1.3.7. Unless otherwise stated these are Rel-15 requirements.

[TS 38.321, clause 5.7]

The MAC entity may be configured by RRC with a DRX functionality that controls the UE's PDCCH monitoring activity for the MAC entity's C-RNTI, CI-RNTI, CS-RNTI, INT-RNTI, SFI-RNTI, SP-CSI-RNTI, TPC-PUCCH-RNTI, TPC-PUSCH-RNTI, TPC-SRS-RNTI, and AI-RNTI. When using DRX operation, the MAC entity shall also monitor PDCCH according to requirements found in other clauses of this specification. When in RRC_CONNECTED, if DRX is configured, for all the activated Serving Cells, the MAC entity may monitor the PDCCH discontinuously using the DRX operation specified in this clause; otherwise the MAC entity shall monitor the PDCCH as specified in TS 38.213 [6].

NOTE 1: If Sidelink resource allocation mode 1 is configured by RRC, a DRX functionality is not configured.

RRC controls DRX operation by configuring the following parameters:

- *drx-onDurationTimer*: the duration at the beginning of a DRX Cycle;
- *drx-SlotOffset*: the delay before starting the *drx-onDurationTimer*;

- *drx-InactivityTimer*: the duration after the PDCCH occasion in which a PDCCH indicates a new UL or DL transmission for the MAC entity;
- *drx-RetransmissionTimerDL* (per DL HARQ process except for the broadcast process): the maximum duration until a DL retransmission is received;
- *drx-RetransmissionTimerUL* (per UL HARQ process): the maximum duration until a grant for UL retransmission is received;
- *drx-LongCycleStartOffset*: the Long DRX cycle and *drx-StartOffset* which defines the subframe where the Long and Short DRX Cycle starts;
- *drx-ShortCycle* (optional): the Short DRX cycle;
- *drx-ShortCycleTimer* (optional): the duration the UE shall follow the Short DRX cycle;
- *drx-HARQ-RTT-TimerDL* (per DL HARQ process except for the broadcast process): the minimum duration before a DL assignment for HARQ retransmission is expected by the MAC entity;
- *drx-HARQ-RTT-TimerUL* (per UL HARQ process): the minimum duration before a UL HARQ retransmission grant is expected by the MAC entity;
- *ps-Wakeup* (optional): the configuration to start associated *drx-onDurationTimer* in case DCP is monitored but not detected;
- *ps-TransmitOtherPeriodicCSI* (optional): the configuration to report periodic CSI that is not L1-RSRP on PUCCH during the time duration indicated by *drx-onDurationTimer* in case DCP is configured but associated *drx-onDurationTimer* is not started;
- *ps-TransmitPeriodicL1-RSRP* (optional): the configuration to transmit periodic CSI that is L1-RSRP on PUCCH during the time duration indicated by *drx-onDurationTimer* in case DCP is configured but associated *drx-onDurationTimer* is not started.

Serving Cells may be configured by RRC in two groups. When RRC does not configure a secondary DRX group, there is only one DRX group. When two DRX groups are configured each group of Serving Cells, which is called a DRX group, is configured by RRC with its own set of parameters: *drx-onDurationTimer*, *drx-InactivityTimer*. When two DRX groups are configured, the two groups share the following parameter values: *drx-SlotOffset*, *drx-RetransmissionTimerDL*, *drx-RetransmissionTimerUL*, *drx-LongCycleStartOffset*, *drx-ShortCycle* (optional), *drx-ShortCycleTimer* (optional), *drx-HARQ-RTT-TimerDL*, and *drx-HARQ-RTT-TimerUL*.

When a DRX cycle is configured, the Active Time for Serving Cells in a DRX group includes the time while:

- *drx-onDurationTimer* or *drx-InactivityTimer* configured for the DRX group is running; or
- *drx-RetransmissionTimerDL* or *drx-RetransmissionTimerUL* is running on any Serving Cell in the DRX group; or
- *ra-ContentionResolutionTimer* (as described in clause 5.1.5) or *msgB-ResponseWindow* (as described in clause 5.1.4a) is running; or
- a Scheduling Request is sent on PUCCH and is pending (as described in clause 5.4.4); or
- a PDCCH indicating a new transmission addressed to the C-RNTI of the MAC entity has not been received after successful reception of a Random Access Response for the Random Access Preamble not selected by the MAC entity among the contention-based Random Access Preamble (as described in clauses 5.1.4 and 5.1.4a).

When DRX is configured, the MAC entity shall:

- 1> if a MAC PDU is received in a configured downlink assignment:
 - 2> start the *drx-HARQ-RTT-TimerDL* for the corresponding HARQ process in the first symbol after the end of the corresponding transmission carrying the DL HARQ feedback;
 - 2> stop the *drx-RetransmissionTimerDL* for the corresponding HARQ process.

- 1> if a MAC PDU is transmitted in a configured uplink grant and LBT failure indication is not received from lower layers:
 - 2> start the *drx-HARQ-RTT-TimerUL* for the corresponding HARQ process in the first symbol after the end of the first repetition of the corresponding PUSCH transmission;
 - 2> stop the *drx-RetransmissionTimerUL* for the corresponding HARQ process.
- 1> if a *drx-HARQ-RTT-TimerDL* expires:
 - 2> if the data of the corresponding HARQ process was not successfully decoded:
 - 3> start the *drx-RetransmissionTimerDL* for the corresponding HARQ process in the first symbol after the expiry of *drx-HARQ-RTT-TimerDL*.
- 1> if a *drx-HARQ-RTT-TimerUL* expires:
 - 2> start the *drx-RetransmissionTimerUL* for the corresponding HARQ process in the first symbol after the expiry of *drx-HARQ-RTT-TimerUL*.

For each DRX group, the MAC entity shall:

- 1> if a DRX Command MAC CE or a Long DRX Command MAC CE is received:
 - 2> stop *drx-onDurationTimer*;
 - 2> stop *drx-InactivityTimer*.
- 1> if *drx-InactivityTimer* for this DRX Group expires:
 - 2> if the Short DRX cycle is configured:
 - 3> start or restart *drx-ShortCycleTimer* for this DRX Group in the first symbol after the expiry of *drx-InactivityTimer*;
 - 3> use the Short DRX Cycle for this DRX group.
 - 2> else:
 - 3> use the Long DRX cycle for this DRX group.
- 1> if a DRX Command MAC CE is received:
 - 2> if the Short DRX cycle is configured:
 - 3> start or restart *drx-ShortCycleTimer* for this DRX Group in the first symbol after the end of DRX Command MAC CE reception;
 - 3> use the Short DRX Cycle for both DRX groups.
 - 2> else:
 - 3> use the Long DRX cycle for both DRX groups.
- 1> if *drx-ShortCycleTimer* for this DRX Group expires:
 - 2> use the Long DRX for this DRX Group cycle.
- 1> if a Long DRX Command MAC CE is received:
 - 2> stop *drx-ShortCycleTimer* for both DRX groups;
 - 2> use the Long DRX cycle for both DRX groups.
- 1> if the Short DRX Cycle is used, and $[(\text{SFN} \times 10) + \text{subframe number}] \bmod (\text{drx-ShortCycle}) = (\text{drx-StartOffset}) \bmod (\text{drx-ShortCycle})$:
 - 2> start *drx-onDurationTimer* after *drx-SlotOffset* from the beginning of the subframe.

- 1> if the Long DRX Cycle is used, and $[(SFN \times 10) + \text{subframe number}] \bmod (drx\text{-}LongCycle) = drx\text{-}StartOffset$:
- 2> if DCP monitoring is configured for the active DL BWP as specified in TS 38.213 [6], clause 10.3:
 - 3> if DCP indication associated with the current DRX Cycle received from lower layer indicated to start *drx-onDurationTimer*, as specified in TS 38.213 [6]; or
 - 3> if all DCP occasion(s) in time domain, as specified in TS 38.213 [6], associated with the current DRX Cycle occurred in Active Time considering grants/assignments/DRX Command MAC CE/Long DRX Command MAC CE received and Scheduling Request sent until 4 ms prior to start of the last DCP occasion, or within BWP switching interruption length, or during a measurement gap; or
 - 3> if *ps-Wakeup* is configured with value *true* and DCP indication associated with the current DRX Cycle has not been received from lower layers:
 - 4> start *drx-onDurationTimer* after *drx-SlotOffset* from the beginning of the subframe.
- 2> else:
 - 3> start *drx-onDurationTimer* after *drx-SlotOffset* from the beginning of the subframe.

NOTE 2: In case of unaligned SFN across carriers in a cell group, the SFN of the SpCell is used to calculate the DRX duration.

- 1> if the DRX group is in Active Time:
 - 2> monitor the PDCCH on the Serving Cells in this DRX group as specified in TS 38.213 [6];
 - 2> if the PDCCH indicates a DL transmission:
 - 3> start the *drx-HARQ-RTT-TimerDL* for the corresponding HARQ process in the first symbol after the end of the corresponding transmission carrying the DL HARQ feedback;
- NOTE 3: When HARQ feedback is postponed by PDSCH-to-HARQ_feedback timing indicating a non-numerical k1 value, as specified in TS 38.213 [6], the corresponding transmission opportunity to send the DL HARQ feedback is indicated in a later PDCCH requesting the HARQ-ACK feedback.
- 3> stop the *drx-RetransmissionTimerDL* for the corresponding HARQ process.
 - 3> if the PDSCH-to-HARQ_feedback timing indicate a non-numerical k1 value as specified in TS 38.213 [6]:
 - 4> start the *drx-RetransmissionTimerDL* in the first symbol after the PDSCH transmission for the corresponding HARQ process.
 - 2> if the PDCCH indicates a UL transmission:
 - 3> start the *drx-HARQ-RTT-TimerUL* for the corresponding HARQ process in the first symbol after the end of the first repetition of the corresponding PUSCH transmission;
 - 3> stop the *drx-RetransmissionTimerUL* for the corresponding HARQ process.
 - 2> if the PDCCH indicates a new transmission (DL or UL) on a Serving Cell in this DRX group:
 - 3> start or restart *drx-InactivityTimer* for this DRX group in the first symbol after the end of the PDCCH reception.
 - 1> if DCP monitoring is configured for the active DL BWP as specified in TS 38.213 [6], clause 10.3; and
 - 1> if the current symbol n occurs within *drx-onDurationTimer* duration; and
 - 1> if *drx-onDurationTimer* associated with the current DRX cycle is not started as specified in this clause:
 - 2> if the MAC entity would not be in Active Time considering grants/assignments/DRX Command MAC CE/Long DRX Command MAC CE received and Scheduling Request sent until 4 ms prior to symbol n when evaluating all DRX Active Time conditions as specified in this clause:

- 3> not transmit periodic SRS and semi-persistent SRS defined in TS 38.214 [7];
- 3> not report semi-persistent CSI configured on PUSCH;
- 3> if *ps-TransmitPeriodicL1-RSRP* is not configured with value *true*:
 - 4> not report periodic CSI that is L1-RSRP on PUCCH.
- 3> if *ps-TransmitOtherPeriodicCSI* is not configured with value *true*:
 - 4> not report periodic CSI that is not L1-RSRP on PUCCH.

1> else:

- 2> in current symbol *n*, if the DRX group would not be in Active Time considering grants/assignments scheduled on Serving Cell(s) in this DRX Group and DRX Command MAC CE/Long DRX Command MAC CE received and Scheduling Request sent until 4 ms prior to symbol *n* when evaluating all DRX Active Time conditions as specified in this clause:
 - 3> not transmit periodic SRS and semi-persistent SRS defined in TS 38.214 [7] in this DRX group;
 - 3> not report CSI on PUCCH and semi-persistent CSI configured on PUSCH in this DRX group.

...

Regardless of whether the MAC entity is monitoring PDCCH or not on the Serving Cells in this DRX group, the MAC entity transmits HARQ feedback, aperiodic CSI on PUSCH, and aperiodic SRS defined in TS 38.214 [7] on the Serving Cells in this DRX group when such is expected.

The MAC entity needs not to monitor the PDCCH if it is not a complete PDCCH occasion (e.g. the Active Time starts or ends in the middle of a PDCCH occasion).

[TS 38.213, clause 10.3]

A UE configured with DRX mode operation [11, TS 38.321] on the PCell or on the SpCell [12, TS 38.331]

- a PS-RNTI for DCI format 2_6 by *ps-RNTI*
- a number of search space sets, by *dci-Format2-6*, to monitor PDCCH for detection of DCI format 2_6 on the active DL BWP of the PCell or of the SpCell according to a common search space as described in Clause 10.1
- a payload size for DCI format 2_6 by *SizeDCI_2-6*
- a location in DCI format 2_6 of a Wake-up indication bit by *PSPositionDCI2-6*, where
 - the UE may not start the *drx-onDurationTimer* for the next long DRX cycle when a value of the Wake-up indication bit is '0', and
 - the UE starts the *drx-onDurationTimer* for the next long DRX cycle when a value of the Wake-up indication bit is '1'
- a bitmap, when the UE is provided a number of groups of configured SCells by *Scell-groups-for-dormancy-outside-active-time*, where
 - the bitmap location is immediately after the Wake-up indication bit location
 - the bitmap size is equal to the number of groups of configured SCells where each bit of the bitmap corresponds to a group of configured SCells from the number of groups of configured SCells
 - a '0' value for a bit of the bitmap indicates an active DL BWP, provided by *dormant-BWP*, for the UE [11, TS38.321] for each activated SCell in the corresponding group of configured SCells
 - a '1' value for a bit of the bitmap indicates
 - an active DL BWP, provided by *first-non-dormant-BWP-ID-for-DCI-outside-active-time*, for the UE for each activated SCell in the corresponding group of configured SCells, if a current active DL BWP is the dormant DL BWP

- a current active DL BWP, for the UE for each activated SCell in the corresponding group of configured SCells, if the current active DL BWP is not the dormant DL BWP
- an offset by *ps-Offset* indicating a time, where the UE starts monitoring PDCCH for detection of DCI format 2_6 according to the number of search space sets, prior to a slot where the *drx-onDurationTimer* would start on the PCell or on the SpCell [11, TS 38.321]
- for each search space set, the PDCCH monitoring occasions are the ones in the first T_s slots indicated by *duration*, or $T_s = 1$ slot if *duration* is not provided, starting from the first slot of the first T_s slots and ending prior to the start of *drx-onDurationTimer*.

The UE does not monitor PDCCH for detecting DCI format 2_6 during Active Time [11, TS 38.321].

If a UE reports for an active DL BWP a requirement of X slots prior to the beginning of a slot where the UE would start the *drx-onDurationTimer*, the UE is not required to monitor PDCCH for detection of DCI format 2_6 during the X slots, where X corresponds to the requirement of the SCS of the active DL BWP.

If a UE is provided search space sets to monitor PDCCH for detection of DCI format 2_6 in the active DL BWP of the PCell or of the SpCell and the UE does not detect DCI format 2_6

- if the UE is provided *ps-WakeupOrNot*, the UE is indicated by *ps-WakeupOrNot* whether the UE may not start or whether the UE shall start the *drx-onDurationTimer* for the next DRX cycle
- if the UE is not provided *ps-WakeupOrNot*, the UE may not start Active Time indicated by *drx-onDurationTimer* for the next DRX cycle

If a UE is provided search space sets to monitor PDCCH for detection of DCI format 2_6 in the active DL BWP of the PCell or of the SpCell and the UE

- is not required to monitor PDCCH for detection of DCI format 2_6, as described in Clauses 10, 11.1, 12, and in Clause 5.7 of [14, TS 38.321] for all corresponding PDCCH monitoring occasions outside Active Time prior to a next DRX cycle, or
- does not have any PDCCH monitoring occasions for detection of DCI format 2_6 outside Active Time of a next DRX cycle

the UE shall start the *drx-onDurationTimer* for the next DRX cycle.

If a UE is provided search space sets to monitor PDCCH for detection of DCI format 0_1 and DCI format 1_1 and if one or both of DCI format 0_1 and DCI format 1_1 include a SCell dormancy indication field,

- the SCell dormancy indication field is a bitmap with size equal to a number of groups of configured SCells, provided by *Scell-groups-for-dormancy-within-active-time*,
- each bit of the bitmap corresponds to a group of configured SCells from the number of groups of configured SCells
- if the UE detects a DCI format 0_1 or a DCI format 1_1 that does not include a carrier indicator field, or detects a DCI format 0_1 or DCI format 1_1 that includes a carrier indicator field with value equal to 0
- a '0' value for a bit of the bitmap indicates an active DL BWP, provided by *dormant-BWP*, for the UE for each activated SCell in the corresponding group of configured SCells
- a '1' value for a bit of the bitmap indicates
 - an active DL BWP, provided by *first-non-dormant-BWP-ID-for-DCI-inside-active-time*, for the UE for each activated SCell in the corresponding group of configured SCells, if a current active DL BWP is the dormant DL BWP
 - a current active DL BWP, for the UE for each activated SCell in the corresponding group of configured SCells, if the current active DL BWP is not the dormant DL BWP
- the UE sets the active DL BWP to the indicated active DL BWP

If a UE is provided search space sets to monitor PDCCH for detection of DCI format 1_1, and if

- the CRC of DCI format 1_1 is scrambled by a C-RNTI or a MCS-C-RNTI, and if
- $resourceAllocation = resourceAllocationType0$ and all bits of the frequency domain resource assignment field in DCI format 1_1 are equal to 0, or
- $resourceAllocation = resourceAllocationType1$ and all bits of the frequency domain resource assignment field in DCI format 1_1 are equal to 1
- $resourceAllocation = dynamicSwitch$ and all bits of the frequency domain resource assignment field in DCI format 1_1 are equal to 0 or 1

the UE considers the DCI format 1_1 as indicating SCell dormancy, not scheduling a PDSCH reception or indicating a SPS PDSCH release, and for transport block 1 interprets the sequence of fields of

- modulation and coding scheme
- new data indicator
- redundancy version

and of

- HARQ process number
- antenna port(s)
- DMRS sequence initialization

as providing a bitmap to each configured SCell, in an ascending order of the SCell index, where

- a '0' value for a bit of the bitmap indicates an active DL BWP, provided by *dormant-BWP*, for the UE for a corresponding activated SCell
- a '1' value for a bit of the bitmap indicates
 - an active DL BWP, provided by *first-non-dormant-BWP-ID-for-DCI-inside-active-time*, for the UE for a corresponding activated SCell, if a current active DL BWP is the dormant DL BWP
 - a current active DL BWP, for the UE for a corresponding activated SCell, if the current active DL BWP is not the dormant DL BWP
- the UE sets the active DL BWP to the indicated active DL BWP

If an active DL BWP provided by *dormant-BWP* for a UE on an activated SCell is not a default DL BWP for the UE on the activated SCell, as described in Clause 12, the BWP inactivity timer is not used for transitioning from the active DL BWP provided by *dormant-BWP* to the default DL BWP on the activated SCell.

A UE is expected to provide HARQ-ACK information in response to a detection of a DCI format 1_1 indicating SCell dormancy after N symbols from the last symbol of a PDCCH providing the DCI format 1_1. If *processingType2Enabled* of *PDSCH-ServingCellConfig* is set to *enable* for the serving cell with the PDCCH providing the DCI format 1_1, $N = 5$ for $\mu = 0$, $N = 5.5$ for $\mu = 1$, and $N = 11$ for $\mu = 2$; otherwise, $N = 10$ for $\mu = 0$, $N = 12$ for $\mu = 1$, $N = 22$ for $\mu = 2$, and $N = 25$ for $\mu = 3$, where μ is the smallest SCS configuration between the SCS configuration of the PDCCH providing the DCI format 1_1 and the SCS configuration of a PUCCH with the HARQ-ACK information in response to the detection of the DCI format 1_1.

[TS 38.213, clause 7.3.1.3.7]

DCI format 2_6 is used for notifying the power saving information outside DRX Active Time for one or more UEs.

The following information is transmitted by means of the DCI format 2_6 with CRC scrambled by PS-RNTI:

- block number 1, block number 2, ..., block number N

where the starting position of a block is determined by the parameter *PSPositionDCI2-6* provided by higher layers for the UE configured with the block.

If the UE is configured with higher layer parameter *PS-RNTI* and *dci-Format2-6*, one block is configured for the UE by higher layers, with the following fields defined for the block:

- Wake-up indication - 1 bit
- SCell dormancy indication – 0 bit if higher layer parameter *Scell-groups-for-dormancy-outside-active-time* is not configured; otherwise 1, 2, 3, 4 or 5 bits bitmap determined according to higher layer parameter *Scell-groups-for-dormancy-outside-active-time*, where each bit corresponds to one of the SCell group(s) configured by higher layers parameter *Scell-groups-for-dormancy-outside-active-time*, with MSB to LSB of the bitmap corresponding to the first to last configured SCell group.

The size of DCI format 2_6 is indicated by the higher layer parameter *SizeDCI_2-6*, according to Clause 10.3 of [5, TS 38.213].

7.1.1.12.3.3 Test description

7.1.1.12.3.3.1 Pre-test conditions

Same Pre-test conditions as in clause 7.1.1.0 except that set to return no data in uplink.

7.1.1.12.3.3.2 Test procedure sequence

Table 7.1.1.12.3.3.2-1: Main behaviour

St	Procedure	Message Sequence		TP	Verdict
		U - S	Message		
1	SS transmits RRCReconfiguration to configure specific DCP parameters. (Note 1)	<--			
2	The UE transmits RRCReconfigurationComplete. (Note 2)	-->			
3	Wait 1280ms to ensure UE is out DRX active time.				
4	The SS transmits DCI 2-6 on the PDCCH within the PS-offset time before the start of next long DRX drx-onDurationTimer and the DCI 2-6 indicates to start the next Drx-onDurationTimer.	<--	(PDCCH (DCI 2-6))		
5	In the first PDCCH occasion when the Drx-onDurationTimer is running, the SS indicates the transmission of a DL MAC PDU on the PDCCH.	<--	MAC PDU		
6	Check: Does the UE transmit a HARQ ACK for the DL MAC PDU in Step 5?	-->	HARQ ACK	1	P
7	SS transmits RRCReconfiguration to configure ps-wakeup with value true. (Note 1)	<--			
8	The UE transmits RRCReconfigurationComplete. (Note 2)	-->			
9	Wait 1280ms to ensure UE is out DRX active time.				
10	In the first PDCCH occasion when the <i>Drx-onDurationTimer</i> is running, the SS indicates the transmission of a DL MAC PDU on the PDCCH.	<--	MAC PDU		
11	Check: Does the UE transmit a HARQ ACK for the DL MAC PDU in Step 10?	-->	HARQ ACK	2	P
12	SS transmits RRCReconfiguration to configure specific DCP parameters. (Note 1)	<--			
13	The UE transmits RRCReconfigurationComplete. (Note 2)	-->			
14	Wait 1280ms to ensure UE is out DRX active time.				
15	The SS transmits DCI 2-6 on the PDCCH within the PS-offset time before the start of next long DRX drx-onDurationTimer and the DCI 2-6 indicates to start the next Drx-onDurationTimer.	<--	(PDCCH (DCI 2-6))		
16	In the last PDCCH occasion when the <i>Drx-onDurationTimer</i> is running, the SS indicates the transmission of an invalid DL MAC PDU on the PDCCH.	<--	Invalid MAC PDU		
17	The UE transmit a HARQ NACK for the DL MAC PDU in Step 16.	-->	HARQ NACK		
18	In the PDCCH occasion when the next <i>Drx-onDurationTimer</i> is running, the SS indicates the transmission of a DL MAC PDU on the PDCCH.	<--	MAC PDU		
19	Check: Does the UE transmit a HARQ ACK for the DL MAC PDU in Step 18?	-->	HARQ ACK	3	P
20	SS transmits RRCReconfiguration to configure specific measonfig parameters. (Note 1)	<--			
21	The UE transmits RRCReconfigurationComplete. (Note 2)	-->			
22	Wait 10ms to ensure UE is out DRX active time.				
23	In the first PDCCH occasion when the <i>Drx-onDurationTimer</i> is running, the SS indicates the transmission of a DL MAC PDU on the	<--	MAC PDU		

	PDCCH.				
24	Check: Does the UE transmit a HARQ ACK for the DL MAC PDU in Step 23?	-->	HARQ ACK	4	P
Note 1: For EN-DC the NR RRCReconfiguration message is contained in RRCConnectionReconfiguration 36.508 [7], Table 4.6.1-8 using condition EN-DC_EmbedNR_RRCRecon.					
Note 2: For EN-DC the NR RRCReconfigurationComplete message is contained in RRCConnectionReconfigurationComplete.					

7.1.1.12.3.3.3 Specific message contents

Table 7.1.1.12.3.3.3-1: RRCReconfiguration (step 1, 7 and 12)

Derivation Path: TS 38.508-1 [6]			
Information Element	Value/remark	Comment	Condition
RRCReconfiguration ::= SEQUENCE {			
criticalExtensions CHOICE {			
rrcReconfiguration ::= SEQUENCE {			
secondaryCellGroup	CellGroupConfig		EN-DC
nonCriticalExtension ::= SEQUENCE {}	Not present		EN-DC
nonCriticalExtension SEQUENCE {			NR
masterCellGroup	CellGroupConfig		
}			
}			
}			
}			

Table 7.1.1.12.3.3.3-2: CellGroupConfig (Table 7.1.1.12.3.3.3-1: RRCReconfiguration)

Derivation Path: TS 38.331 [6], clause 6.3.2			
Information Element	Value/remark	Comment	Condition
CellGroupConfig ::= SEQUENCE {			
cellGroupId	CellGroupId	TS 38.508-1 default value	
mac-CellGroupConfig ::= SEQUENCE {			
drx-Config CHOICE {			
setup	DRX-Config	TS 38.508-1 default value	
}			
}			
physicalCellGroupConfig ::= SEQUENCE {			
dcp-Config-r16 CHOICE {			
setup	DCP-Config-r16	TS 38.508-1 default value	
}			
}			
spCellConfig SEQUENCE {			
spCellConfigDedicated	ServingCellConfig		
}			
}			

Table 7.1.1.12.3.3.3-3: ServingCellConfig (Table 7.1.1.13.3.3.3-2: CellGroupConfig)

Derivation Path: TS 38.508-1 [4] Table 4.6.3-167			
Information Element	Value/remark	Comment	Condition
ServingCellConfig ::= SEQUENCE {			
initialDownlinkBWP ::= SEQUENCE {			
pdcch-Config CHOICE {			Step 1, Step 7, Step 12, Step 20
setup	PDCCH-Config		
}			
}			
}			

Table 7.1.1.12.3.3.3-4: PDCCH-Config (Table 7.1.1.12.3.3.3-3: BWP-DownlinkDedicated)

Derivation Path: TS 38.508-1 [4], Table 4.6.3-95			
Information Element	Value/remark	Comment	Condition
PDCCH-Config ::= SEQUENCE {			
controlResourceSetToAddModList			
SEQUENCE(SIZE (1..3)) OF			
ControlResourceSet ::= SEQUENCE {			
controlResourceSetId	1		
}			
searchSpacesToAddModList SEQUENCE(SIZE			
(1..10)) OF SearchSpace {			
searchSpace ::= SEQUENCE {			
searchSpaceExt-r16 ::= SEQUENCE {			
controlResourceSetId-r16	1		
searchSpaceType-r16 SEQUENCE {			
common SEQUENCE {			
dci-Format2-6-r16 SEQUENCE {			
}			
}			
}			
}			
}			
}			

Table 7.1.1.12.3.3.3-5: CellGroupConfig (Table 7.1.1.13.3.3.3-1: RRCReconfiguration step 7)

Derivation Path: TS 38.331 [6], clause 6.3.2			
Information Element	Value/remark	Comment	Condition
CellGroupConfig ::= SEQUENCE {			
cellGroupId	CellGroupId	TS 38.508-1 default value	
mac-CellGroupConfig ::= SEQUENCE {			
drx-Config CHOICE {			
setup	DRX-Config	TS 38.508-1 default value	
}			
}			
physicalCellGroupConfig ::= SEQUENCE {			
dcp-Config-r16 CHOICE {			
setup SEQUENCE {			
ps-WakeUp-r16	true		
}			
}			
}			
}			

Table 7.1.1.12.3.3.3-6: CellGroupConfig (Table 7.1.1.13.3.3.3-1: RRCReconfiguration step 12)

Derivation Path: TS 38.331 [6], clause 6.3.2			
Information Element	Value/remark	Comment	Condition
CellGroupConfig ::= SEQUENCE {			
cellGroupld	CellGroupld	TS 38.508-1 default value	
mac-CellGroupConfig ::= SEQUENCE {			
drx-Config CHOICE {			
setup SEQUENCE {			
drx-onDurationTimer	ms10		
drx-InactivityTimer	ms5		
drx-HARQ-RTT-TimerDL	56		
drx-HARQ-RTT-TimerUL	56		
drx-RetransmissionTimerDL	sl320		
drx-RetransmissionTimerUL	sl320		
drx-LongCycleStartOffset CHOICE {			
ms20	0		
}			
shortDRX	Not present		
drx-SlotOffset	ms0		
}			
physicalCellGroupConfig ::= SEQUENCE {			
dcp-Config-r16 CHOICE {			
setup SEQUENCE {			
ps-Offset-r16	40		
}			
}			
}			
}			

Table 7.1.1.12.3.3.3-7: RRCReconfiguration (step 20)

Derivation Path: TS 38.508-1 [6], Table 4.6.1-13			
Information Element	Value/remark	Comment	Condition
RRCReconfiguration ::= SEQUENCE {			
criticalExtensions CHOICE {			
rrcReconfiguration ::= SEQUENCE {			
secondaryCellGroup	CellGroupConfig		EN-DC
measConfig ::= SEQUENCE {			
measGapConfig ::= SEQUENCE {			
gapUE CHOICE {			
setup SEQUENCE {			
gapOffset	34		
mgl	ms6		
mgrp	ms40		
mgta	ms0		
}			
}			
}			
}			
}			
nonCriticalExtension SEQUENCE {			NR
masterCellGroup	CellGroupConfig		
}			
}			

Table 7.1.1.12.3.3.3-8: CellGroupConfig (Table 7.1.1.12.3.3.3-7: RRCReconfiguration step 20)

Derivation Path: TS 38.331 [6], clause 6.3.2			
Information Element	Value/remark	Comment	Condition
CellGroupConfig ::= SEQUENCE {			
cellGroupld	CellGroupld	TS 38.508-1 default value	
mac-CellGroupConfig ::= SEQUENCE {			
drx-Config CHOICE {			
setup SEQUENCE {			
drx-onDurationTimer	ms10		
drx-InactivityTimer	ms5		
drx-LongCycleStartOffset CHOICE {			
ms40	39		
}			
shortDRX	Not present		
drx-SlotOffset	ms0		
}			
}			
physicalCellGroupConfig ::= SEQUENCE {			
dcp-Config-r16 CHOICE {			
setup SEQUENCE {			
ps-Offset-r16	40		
}			
}			
}			
}			

7.1.2 RLC

Editor's note: Intended to capture tests of RLC Layer behaviour defined in TS 38.322

7.1.2.1 Default Pre-Test Conditions for all RLC test cases

The following pre-test conditions shall be applied in all RLC test cases until the test case explicitly over writes these conditions.

7.1.2.1.1 Default Pre-Test Conditions for AM RLC test cases

System Simulator:

- The SS configures the test environment in accordance to the execution conditions in Table 7.1.2.1.1-1.

UE:

- None

Preamble:

- The SS performs the generic procedure in [4] to get UE in state RRC_CONNECTED in accordance to the execution conditions in Table 7.1.2.1.1-2 and the message condition UE TEST LOOP MODE A to return one UL PDCP SDU per DL PDCP SDU.

Table 7.1.2.1.1-1: Test environment

Execution Condition	Cell configuration	System Information Combination
IF pc_NG_RAN_NR	NR Cell 1	NR: System information Combination NR-1
ELSE IF pc_EN_DC	E-UTRA Cell 1 is PCell, NR Cell 1 is PSCell	EUTRA: System information Combination 1 NR: N/A
ELSE IF pc_NGEN_DC	NG-RAN E-UTRA Cell 1 is PCell, NR Cell 1 is PSCell	EUTRA: System information Combination 1 NR: N/A

Table 7.1.2.1.1-2: Preamble parameters

Execution Condition	Multi-PDN / Multi-PDU Sessions Condition	Generic Procedure Parameters	Primary DRB used for Data testing
IF pc_NG_RAN_NR	FALSE	Connectivity(NR), Test loop function(On) One DRB	Default DRB of the first PDU session on NR Cell
	TRUE	Connectivity(NR), Test loop function(On) N DRBs ($N \geq 2$)	
ELSE IF pc_EN_DC	FALSE	Connectivity(EN-DC), DC bearer(One MN Terminated MCG bearer and One SN terminated SCG bearer), Test loop function(On)	SN Terminated SCG bearer unless explicitly specified in test case
	TRUE	Connectivity(EN-DC), DC bearer(Two MN Terminated MCG bearer and One SN terminated SCG bearer), Test loop function(On)	
ELSE IF pc_NGEN_DC	FALSE	Connectivity(NGEN-DC), DC bearer(One MN Terminated MCG bearer and One SN terminated SCG bearer), Test loop function(On)	SN Terminated SCG bearer unless explicitly specified in test case
	TRUE	Connectivity(EN-DC), DC bearer(Two MN Terminated MCG bearer and One SN terminated SCG bearer), Test loop function(On)	

Table 7.1.2.1.1-3: Message conditions

Execution Condition	Message condition exceptions
IF pc_NG_RAN_NR	Message with condition AM is used for step 7 in 4.5.4.2 according to [4]
ELSE IF pc_EN_DC	Message condition MCG_and_SCG with condition SCG-DRB(1,0) is used for step 7 in 4.5.4.2 according to [4]
ELSE IF pc_NGEN_DC	Message condition MCG_and_SCG with condition SCG-DRB(1,0) is used for step 7 in 4.5.4.2 according to [4]

7.1.2.1.2 Default Pre-Test Conditions for UM RLC test cases

Same Pre-test conditions as in clause 7.1.2.1.1 with the exceptions in Table 7.1.2.1.2-1.

Table 7.1.2.1.2-1: Message conditions

Execution Condition	Message condition exceptions
IF pc_NG_RAN_NR	Message with condition UM is used for step 7 in 4.5.4.2 according to [4]
ELSE IF pc_EN_DC	Message condition MCG_and_SCG with condition SCG-DRB(0,1) is used for step 7 in 4.5.4.2 according to [4]
ELSE IF pc_NGEN_DC	Message condition MCG_and_SCG with condition SCG-DRB(0,1) is used for step 7 in 4.5.4.2 according to [4]

7.1.2.2 RLC Unacknowledged mode

7.1.2.2.1 UM RLC / Segmentation and reassembly / 6-bit SN / Segmentation Info (SI) field

7.1.2.2.1.1 Test Purpose (TP)

(1)

```
with { UE in RRC_CONNECTED state configured for 6 bit SN in RLC UM }
ensure that {
  when { UE receives UMD PDU containing a SI field set to 00 }
  then { UE correctly decodes the received UMD PDU }
}
```

(2)

```
with { UE in RRC_CONNECTED state configured for 6 bit SN in RLC UM }
ensure that {
  when { UE receives a 6 bit SN configured UMD PDU containing a SI field set to 01 }
  then { UE correctly decodes the received UMD PDU }
}
```

(3)

```
with { UE in RRC_CONNECTED state configured for 6 bit SN in RLC UM }
ensure that {
  when { UE receives a 6 bit SN configured UMD PDU containing a SI field set to 11 and SO field }
  then { UE correctly decodes the received UMD PDU }
}
```

(4)

```
with { UE in RRC_CONNECTED state configured for 6 bit SN in RLC UM }
ensure that {
  when { UE receives a 6 bit SN configured UMD PDU containing a SI field set to 10 and SO field }
  then { UE correctly decodes the received UMD PDU }
}
```

(5)

```
with { UE in RRC_CONNECTED state configured for 6 bit SN in RLC UM }
ensure that {
  when { UE has UL SDU to send and UL grant available is sufficient to send whole SDU in one PDU }
  then { UE transmits RLC SDU containing a SI field set to 00 }
}
```

(6)

```
with { UE in RRC_CONNECTED state configured for 6 bit SN in RLC UM }
ensure that {
  when { UE has UL SDU to send and UL grant available is not sufficient to send whole SDU in one PDU }
}
```

```

    then { UE transmits first RLC SDU segment containing a SI field set to 01 and including 6 bit SN
  }
    }

```

(7)

```

with { UE in RRC_CONNECTED state configured for 6 bit SN in RLC UM }
ensure that {
  when { UE has UL SDU to send and UL grant available is not sufficient to send whole SDU in one PDU
}
  then { UE transmits middle RLC SDU segment containing a SI field set to 11, including SO field
and including 6 bit SN }
}

```

(8)

```

with { UE in RRC_CONNECTED state configured for 6 bit SN in RLC UM }
ensure that {
  when { UE has UL SDU to send and UL grant available is not sufficient to send whole SDU in one PDU
}
  then { UE transmits last RLC SDU segment containing a SI field set to 10, including SO field and
including 6 bit SN }
}

```

7.1.2.2.1.2 Conformance requirements

References: The conformance requirements covered in the present TC are specified in: TS 38.322, clauses 5.2.2.2.1, 5.2.2.2.2, 6.2.3.4 and 6.2.2.3. Unless otherwise stated these are Rel-15 requirements.

[TS 38.322, clause 5.2.2.2.1]

The receiving UM RLC entity shall maintain a reassembly window according to state variable `RX_Next_Highest` as follows:

- a SN falls within the reassembly window if $(RX_Next_Highest - UM_Window_Size) \leq SN < RX_Next_Highest$;
- a SN falls outside of the reassembly window otherwise.

When receiving an UMD PDU from lower layer, the receiving UM RLC entity shall:

- either deliver the UMD PDU after removing the RLC header, discard the received UMD PDU, or place it in the reception buffer (see sub clause 5.2.2.2.2);
- if the received UMD PDU was placed in the reception buffer:
 - update state variables, reassemble and deliver RLC SDUs to upper layer and start/stop *t-Reassembly* as needed (see sub clause 5.2.2.2.3).

When *t-Reassembly* expires, the receiving UM RLC entity shall:

- update state variables, discard RLC SDU segments and start *t-Reassembly* as needed (see sub clause 5.2.2.2.4).

[TS 38.322, clause 5.2.2.2.2]

When an UMD PDU is received from lower layer, the receiving UM RLC entity shall:

- if the UMD PDU header does not contain an SN:
 - remove the RLC header and deliver the RLC SDU to upper layer.
- else if $(RX_Next_Highest - UM_Window_Size) \leq SN < RX_Next_Reassembly$:
 - discard the received UMD PDU.
- else:
 - place the received UMD PDU in the reception buffer.

[TS 38.322, clause 6.2.2.3]

UMD PDU consists of a Data field and an UMD PDU header. The UMD PDU header is byte aligned

When an UMD PDU contains a complete RLC SDU, the UMD PDU header only contains the SI and R fields.

An UM RLC entity is configured by RRC to use either a 6 bit SN or a 12 bit SN. An UMD PDU header contains the SN field only when the corresponding RLC SDU is segmented. An UMD PDU carrying the first segment of an RLC SDU does not carry the SO field in its header. The length of the SO field is 16 bits.

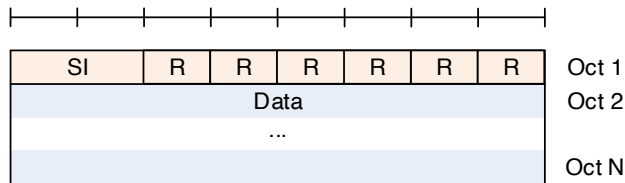

Figure 6.2.2.3-1: UMD PDU containing a complete RLC SDU

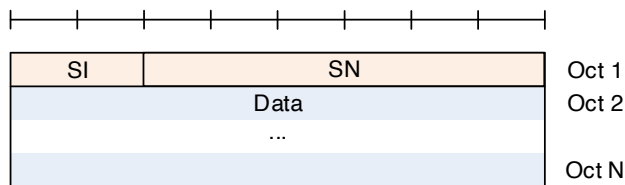

Figure 6.2.2.3-2: UMD PDU with 6 bit SN (No SO)

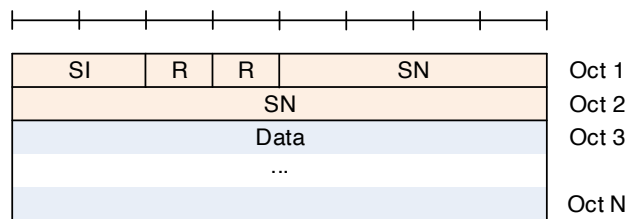

Figure 6.2.2.3-3: UMD PDU with 12 bit SN (No SO)

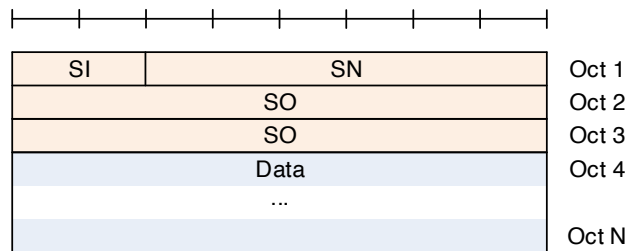

Figure 6.2.2.3-4: UMD PDU with 6 bit SN and with SO

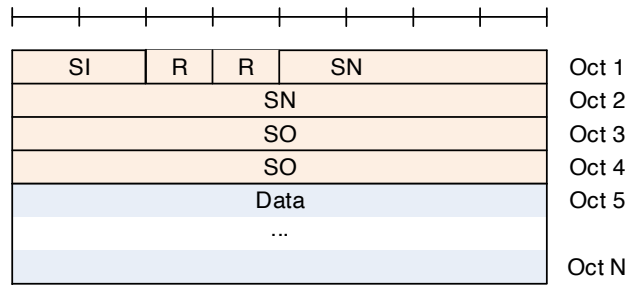

Figure 6.2.2.3-5: UMD PDU with 12 bit SN and with SO

[TS 38.322, clause 6.2.3.4]

Length: 2 bits.

The SI field indicates whether a RLC PDU contains a complete RLC SDU or the first, middle, last segment of a RLC SDU.

Table 6.2.2.6-1: SI field interpretation

Value	Description
00	Data field contains all bytes of a RLC SDU
01	Data field contains the first segment of a RLC SDU
10	Data field contains the last segment of a RLC SDU
11	Data field contains neither the first nor last segment of a RLC SDU

7.1.2.2.1.3 Test description

7.1.2.2.1.3.1 Pre-test conditions

Same Pre-test conditions as in clause 7.1.2.1.2 with the exception for the UM DRB is configured according to Table 7.1.2.2.1.3.1-1.

Table 7.1.2.2.1.3.1-1: RLC parameters

Uplink UM RLC sn-FieldLength	size6
Downlink UM RLC sn-FieldLength	size6

7.1.2.2.1.3.2 Test procedure sequence

Table 7.1.2.2.1.3.2-1: Main behaviour

St	Procedure	Message Sequence		TP	Verdict
		U - S	Message		
0	The SS stops allocating any UL grant.	-	-	-	-
1	The SS transmits UMD PDU#1 containing a complete RLC SDU#1 (SI field = 00).	<-	UMD PDU#1	-	-
2	SS allocates an UL grant sufficient to loop back RLC SDU#1 in one RLC/MAC PDU	<-	UL Grant	-	-
3	Check: Does the UE transmit RLC SDU#1?	-->	(RLC SDU#1)	1,5	P
4	The SS transmits UMD PDU#2 containing the first segment of RLC SDU#2 (SI field = 01). Note 3	<-	UMD PDU#2	-	-
5	The SS transmits UMD PDU#3 containing the second segment of RLC SDU#2 (SI field = 11) and including SO field. Note 3	<-	UMD PDU#3	-	-
6	The SS transmits UMD PDU#4 containing the last segment of RLC SDU#2 (SI field = 10) and including SO field. Note 3	<-	UMD PDU#4	-	-
7	SS allocates 3 UL grants at an interval of 20 ms so as to loop back RLC SDU#2 in 3 RLC/MAC PDUs. Note 1 & 2	<-	UL Grants	-	-
8	Check: Does the UE transmit UMD PDU#2 containing the first segment of RLC SDU#2 (SI field = 01)?	-->	(RLC SDU#2, first segment)	2,3, 4,6	P
9	Check: Does the UE transmit UMD PDU#3 containing the second segment of RLC SDU#2 (SI field = 11) and including SO field?	-->	(RLC SDU#2, second segment)	2,3, 4,7	P
10	Check: Does the UE transmit UMD PDU#4 containing the last segment of RLC SDU#2 (SI field = 10) and including SO field?	-->	(RLC SDU#2, last segment)	2,3, 4,8	P
Note 1: The UL grants for step 8,9,10 are sufficiently small (240 bits, L_{RBs} & I_{MCS} as per 38.523-3[3] annex B) that UE transmits RLC SDU#2 in 3 UL RLC PDUs by segmenting.					
Note 2: The RLC PDU containing a segment shall be of size 208 bits resp. 224 bits and a MAC sub PDU header of 16 bits and a 16-bit MAC BSR CE included in step 8 resulting in a MAC PDU of size 240 bits.					
Note 3: The data part in step 4 first segment not including SO is 200 bits (25 bytes). Step 5, second segment SO=25 and data is 200 bits (25 bytes). Step 6, third segment SO=25+25=50 and data is 200 bits (25 bytes).					

7.1.2.2.1.3.3 Specific message contents

None.

7.1.2.2.2 UM RLC / Segmentation and reassembly / 12-bit SN / Segmentation Info (SI) field

7.1.2.2.2.1 Test Purpose (TP)

(1)

```
with { UE in RRC_CONNECTED state configured for 12 bit SN in RLC UM }
ensure that {
  when { UE receives UMD PDU containing a SI field set to 00 }
  then { UE correctly decodes the received UMD PDU }
}
```

(2)

```
with { UE in RRC_CONNECTED state configured for 12 bit SN in RLC UM }
ensure that {
  when { UE receives a 12 bit SN configured UMD PDU containing a SI field set to 01 }
  then { UE correctly decodes the received UMD PDU }
}
```

(3)

```

with { UE in RRC_CONNECTED state configured for 12 bit SN in RLC UM }
ensure that {
  when { UE receives a 12 bit SN configured UMD PDU containing a SI field set to 11 and SO field }
  then { UE correctly decodes the received UMD PDU }
}

```

(4)

```

with { UE in RRC_CONNECTED state configured for 12 bit SN in RLC UM }
ensure that {
  when { UE receives a 12 bit SN configured UMD PDU containing a SI field set to 10 and SO field }
  then { UE correctly decodes the received UMD PDU }
}

```

(5)

```

with { UE in RRC_CONNECTED state configured for 12 bit SN in RLC UM }
ensure that {
  when { UE has UL SDU to send and UL grant available is sufficient to send whole SDU in one PDU }
  then { UE transmits RLC SDU containing a SI field set to 00 }
}

```

(6)

```

with { UE in RRC_CONNECTED state configured for 12 bit SN in RLC UM }
ensure that {
  when { UE has UL SDU to send and UL grant available is not sufficient to send whole SDU in one PDU }
}
  then { UE transmits first RLC SDU segment containing a SI field set to 01 and including 12 bit
SN}
}

```

(7)

```

with { UE in RRC_CONNECTED state configured for 12 bit SN in RLC UM }
ensure that {
  when { UE has UL SDU to send and UL grant available is not sufficient to send whole SDU in one PDU }
}
  then { UE transmits middle RLC SDU segment containing a SI field set to 11, including SO field
and including 12 bit SN }
}

```

(8)

```

with { UE in RRC_CONNECTED state configured for 12 bit SN in RLC UM }
ensure that {
  when { UE has UL SDU to send and UL grant available is not sufficient to send whole SDU in one PDU }
}
  then { UE transmits last RLC SDU segment containing a SI field set to 10, including SO field and
including 12 bit SN }
}

```

7.1.2.2.2.2 Conformance requirements

Same conformance requirements as clause 7.1.2.2.1.2

7.1.2.2.2.3 Test description

7.1.2.2.2.3.1 Pre-test conditions

Same Pre-test conditions as in clause 7.1.2.1.2 with the exception for the UM DRB is configured according to Table 7.1.2.2.2.3.1-1.

Table 7.1.2.2.3.1-1: RLC parameters

Uplink UM RLC sn-FieldLength	size12
Downlink UM RLC sn-FieldLength	size12

7.1.2.2.3.2 Test procedure sequence

Same test procedure sequence as 7.1.2.2.1.3.2 except that RLC UM SN is 12 bit and the data part in step 4 first segment not including SO is 192 bits (24 Bytes). Step 5, second segment SO=24 and data is 192 bits (24 bytes). Step 6, third segment SO=24+24=48 and data is 192 bits (24 bytes).

7.1.2.2.3.3 Specific message contents

None.

7.1.2.2.3 UM RLC / 6-bit SN / Correct use of sequence numbering

7.1.2.2.3.1 Test Purpose (TP)

(1)

```
with { UE in RRC_CONNECTED state with UM RLC 6 bit SN }
ensure that {
  when { UE transmits the first PDU which is segmented }
  then { UE includes the SN field equal to 0 in each RLC segment }
}
```

(2)

```
with { UE in RRC_CONNECTED state with UM RLC 6 bit SN }
ensure that {
  when { UE transmit subsequent segmented PDUs }
  then { UE includes the SN field incremented by 1 for each segmented PDU of one RLC SDU }
}
```

(3)

```
with { UE in RRC_CONNECTED state with UM RLC 6 bit SN }
ensure that {
  when { UE transmit segments belonging to more than 64 SDUs }
  then { UE wraps the SN after transmitting the segments of 64 SDUs }
}
```

(4)

```
with { UE in RRC_CONNECTED state with UM RLC 6 bit SN }
ensure that {
  when { segments of more than 64 SDUs are sent to UE }
  then { UE accepts PDUs with SNs that wrap around every 64 segmented SDUs }
}
```

7.1.2.2.3.2 Conformance requirements

References: The conformance requirements covered in the present TC are specified in: 3GPP TS 38.322, clause 5.2.2.1.1, 5.2.2.2, 6.2.2.3, 6.2.3.3 and 7.1. Unless otherwise stated these are Rel-15 requirements.

[TS 38.322, clause 5.2.2.1.1]

When submitting a UMD PDU to lower layer, the transmitting UM RLC entity shall:

- if the UMD PDU contains a segment of an RLC SDU, set the SN of the UMD PDU to TX_Next;
- if the UMD PDU contains a segment that maps to the last byte of an RLC SDU, then increment TX_Next by one.

[TS 38.322, clause 5.2.2.2]

The receiving UM RLC entity shall maintain a reassembly window according to state variable `RX_Next_Highest` as follows:

- a SN falls within the reassembly window if $(RX_Next_Highest - UM_Window_Size) \leq SN < RX_Next_Highest$;
- a SN falls outside of the reassembly window otherwise.

When receiving an UMD PDU from lower layer, the receiving UM RLC entity shall:

- either deliver the UMD PDU after removing the RLC header, discard the received UMD PDU, or place it in the reception buffer (see sub clause 5.2.2.2.2);
- if the received UMD PDU was placed in the reception buffer:
 - update state variables, reassemble and deliver RLC SDUs to upper layer and start/stop *t-Reassembly* as needed (see sub clause 5.2.2.2.3).

...

When an UMD PDU is received from lower layer, the receiving UM RLC entity shall:

- if the UMD PDU header does not contain an SN:
 - remove the RLC header and deliver the RLC SDU to upper layer.
- else if $(RX_Next_Highest - UM_Window_Size) \leq SN < RX_Next_Reassembly$:
 - discard the received UMD PDU.
- else:
 - place the received UMD PDU in the reception buffer.

...

When an UMD PDU with $SN = x$ is placed in the reception buffer, the receiving UM RLC entity shall:

- if all byte segments with $SN = x$ are received:
 - reassemble the RLC SDU from all byte segments with $SN = x$, remove RLC headers and deliver the reassembled RLC SDU to upper layer;
 - if $x = RX_Next_Reassembly$:
 - update `RX_Next_Reassembly` to the SN of the first $SN >$ current `RX_Next_Reassembly` that has not been reassembled and delivered to upper layer.
- else if x falls outside of the reassembly window:
 - update `RX_Next_Highest` to $x + 1$;
 - discard any UMD PDUs with SN that falls outside of the reassembly window;
 - if `RX_Next_Reassembly` falls outside of the reassembly window:
 - set `RX_Next_Reassembly` to the SN of the first $SN \geq (RX_Next_Highest - UM_Window_Size)$ that has not been reassembled and delivered to upper layer.

[TS 38.322, clause 6.2.2.3]

An UM RLC entity is configured by RRC to use either a 6 bit SN or a 12 bit SN. An UMD PDU header contains the SN field only when the corresponding RLC SDU is segmented.

[TS 38.322, clause 6.2.3.3]

The SN field indicates the sequence number of the corresponding RLC SDU. For RLC UM, the sequence number is incremented by one for every segmented RLC SDU..

[TS 38.322, clause 7.1]

All state variables and all counters are non-negative integers.

...

All state variables related to UM data transfer can take values from 0 to 63 for 6 bit SN or from 0 to 4095 for 12 bit SN. All arithmetic operations contained in the present document on state variables related to UM data transfer are affected by the UM modulus (i.e. final value = [value from arithmetic operation] modulo 64 for 6 bit SN and 4096 for 12 bit SN).

...

Each transmitting UM RLC entity shall maintain the following state variables:

a) TX_Next

This state variable holds the value of the SN to be assigned for the next newly generated UMD PDU with segment. It is initially set to 0, and is updated after the UM RLC entity submits a UMD PDU including the last segment of an RLC SDU to lower layers.

Each receiving UM RLC entity shall maintain the following state variables and constant:

b) RX_Next_Reassembly – UM receive state variable

This state variable holds the value of the earliest SN that is still considered for reassembly. It is initially set to 0.

c) RX_Timer_Trigger – UM *t-Reassembly* state variable

This state variable holds the value of the SN following the SN which triggered *t-Reassembly*.

d) RX_Next_Highest– UM receive state variable

This state variable holds the value of the SN following the SN of the UMD PDU with the highest SN among received UMD PDUs. It serves as the higher edge of the reassembly window. It is initially set to 0.

7.1.2.2.3.3 Test description

7.1.2.2.3.3.1 Pre-test conditions

Same Pre-test conditions as in clause 7.1.2.1.2 with the exception for the UM DRB is configured according to Table 7.1.2.2.3.3.1-1.

Table 7.1.2.2.3.3.1-1: RLC parameters

Uplink UM RLC sn-FieldLength	size6
Downlink UM RLC sn-FieldLength	size6

7.1.2.2.3.3.2 Test procedure sequence

Table 7.1.2.2.3.3.2-1: Main behaviour

St	Procedure	Message Sequence		TP	Verdict
		U - S	Message		
0	The SS stops allocating any UL grant.	-	-	-	-
1	The SS transmits UMD PDU#1 with 6 bit SN = 0 containing the first segment of RLC SDU#1 (SI field = 01).	<-	UMD PDU#1	-	-
2	The SS transmits UMD PDU#2 with 6 bit SN=0 containing the last segment of RLC SDU#1 (SI field = 10) and including SO field.	<-	UMD PDU#2	-	-
3	SS allocates 2 UL grants at an interval of 20 ms so as to loop back RLC SDU#1 in 2 RLC/MAC PDUs. (Note 1)	<-	UL Grants	-	-
4	Check: Does the UE transmit UMD PDU#1 with 6 bit SN = 0 containing the first segment of RLC SDU#1 (SI field = 01)?	-->	(RLC SDU#1, first segment)	1	P
5	Check: Does the UE transmit UMD PDU#2 with 6 bit SN = 0 containing the last segment of RLC SDU#1 (SI field = 10)?	-->	(RLC SDU#1, last segment)	1	P
-	EXCEPTION: Steps 6 to 10 are executed 63 times, the initial value of k = 1, it is incremented by one for each iteration.	-	-	-	-
6	The SS transmits UMD PDU#(2*k+1) with 6 bit SN = k containing the first segment of RLC SDU#(k+1) (SI field = 01).	<-	UMD PDU#(2*k+1)	-	-
7	The SS transmits UMD PDU#(2*(k+1)) with 6 bit SN=k containing the last segment of RLC SDU#(k+1) (SI field = 10)	<-	UMD PDU#(2*(k+1))	-	-
8	SS allocates 2 UL grants at an interval of 20 ms so as to loop back RLC SDU#(k+1) in 2 RLC/MAC PDUs. (Note 1)	<-	UL Grants	-	-
9	Check: Does the UE transmit UMD PDU#(2*k+1) with 6 bit SN = k containing the first segment of RLC SDU#(k+1) (SI field = 01)? (Note 2)	-->	(RLC SDU#(k+1), first segment)	2	P
10	Check: Does the UE transmit UMD PDU#(2*(k+1)) with 6 bit SN = k containing the last segment of RLC SDU#(k+1) (SI field = 10) and including SO field? (Note 2)	-->	(RLC SDU#(k+1), last segment)	2	P
11	The SS transmits UMD PDU#129 with 6 bit SN = 0 containing the first segment of RLC SDU#65 (SI field = 01).	<-	UMD PDU#129	-	-
12	The SS transmits UMD PDU#130 with 6 bit SN= 0 containing the last segment of RLC SDU#65 (SI field = 10) and including SO field	<-	UMD PDU#130	-	-
13	SS allocates 2 UL grants at an interval of 20 ms so as to loop back RLC SDU#65 in 2 RLC/MAC PDUs. (Note 1)	<-	UL Grants	-	-
14	Check: Does the UE transmit UMD PDU#129 with 6 bit SN = 0 containing the first segment of RLC SDU#65 (SI field = 01)?	-->	(RLC SDU#65, first segment)	3,4	P
15	Check: Does the UE transmit UMD PDU#130 with 6 bit SN = 0 containing the last segment of RLC SDU#65 (SI field = 10) and including SO field?	-->	(RLC SDU#65, last segment)	3,4	P
<p>Note 1: The RLC SDU size shall be 12 octets which are segmented into 6 and 6 octets. With 2 octets of MAC header, 2 octets of Short BSR and 1 octet of RLC header (without SO) the first segment consists of 88 bits and a TBS of this size shall be allocated. With 2 octets of MAC header and 3 octets of RLC header (with SO) the second segment consists of 88 bits and a TBS of this size shall be allocated. (L_{RBs} & I_{MCS} as per 38.523-3[3] annex B)</p> <p>Note 2: The verdict shall be provided each time (SN+1) mod 16 = 0.</p>					

7.1.2.2.3.3.3 Specific message contents

None.

7.1.2.2.4 UM RLC / 12-bit SN / Correct use of sequence numbering

7.1.2.2.4.1 Test Purpose (TP)

(1)

```
with { UE in RRC_CONNECTED state with UM RLC 12 bit SN }
ensure that {
  when { UE transmits the first PDU which is segmented }
  then { UE includes the SN field equal to 0 in each RLC segment }
}
```

(2)

```
with { UE in RRC_CONNECTED state with UM RLC 12 bit SN }
ensure that {
  when { UE transmit subsequent segmented PDUs }
  then { UE includes the SN field incremented by 1 for each segmented PDU of one RLC SDU }
}
```

(3)

```
with { UE in RRC_CONNECTED state with UM RLC 12 bit SN }
ensure that {
  when { UE transmit segments belonging to more than 4096 SDUs }
  then { UE wraps the SN after transmitting the segments of 4096 SDUs }
}
```

(4)

```
with { UE in RRC_CONNECTED state with UM RLC 12 bit SN }
ensure that {
  when { segments of more than 4096 SDUs are sent to UE }
  then { UE accepts PDUs with SNs that wrap around every 4096 segmented SDUs }
}
```

7.1.2.2.4.2 Conformance requirements

References: The conformance requirements covered in the present TC are specified in: 3GPP TS 38.322, clause 5.2.2.1.1, 5.2.2.2, 6.2.2.3, 6.2.3.3 and 7.1. Unless otherwise stated these are Rel-15 requirements.

[TS 38.322, clause 5.2.2.1.1]

When submitting a UMD PDU to lower layer, the transmitting UM RLC entity shall:

- if the UMD PDU contains a segment of an RLC SDU, set the SN of the UMD PDU to TX_Next;
- if the UMD PDU contains a segment that maps to the last byte of an RLC SDU, then increment TX_Next by one.

[TS 38.322, clause 5.2.2.2]

The receiving UM RLC entity shall maintain a reassembly window according to state variable RX_Next_Highest as follows:

- a SN falls within the reassembly window if $(RX_Next_Highest - UM_Window_Size) \leq SN < RX_Next_Highest$;
- a SN falls outside of the reassembly window otherwise.

When receiving an UMD PDU from lower layer, the receiving UM RLC entity shall:

- either deliver the UMD PDU after removing the RLC header, discard the received UMD PDU, or place it in the reception buffer (see sub clause 5.2.2.2.2);
- if the received UMD PDU was placed in the reception buffer:
 - update state variables, reassemble and deliver RLC SDUs to upper layer and start/stop *t-Reassembly* as needed (see sub clause 5.2.2.2.3).

...

When an UMD PDU is received from lower layer, the receiving UM RLC entity shall:

- if the UMD PDU header does not contain an SN:
 - remove the RLC header and deliver the RLC SDU to upper layer.
- else if $(RX_Next_Highest - UM_Window_Size) \leq SN < RX_Next_Reassembly$:
 - discard the received UMD PDU.
- else:
 - place the received UMD PDU in the reception buffer.

...

When an UMD PDU with SN = x is placed in the reception buffer, the receiving UM RLC entity shall:

- if all byte segments with SN = x are received:
 - reassemble the RLC SDU from all byte segments with SN = x, remove RLC headers and deliver the reassembled RLC SDU to upper layer;
 - if $x = RX_Next_Reassembly$:
 - update *RX_Next_Reassembly* to the SN of the first SN > current *RX_Next_Reassembly* that has not been reassembled and delivered to upper layer.
- else if x falls outside of the reassembly window:
 - update *RX_Next_Highest* to x + 1;
 - discard any UMD PDUs with SN that falls outside of the reassembly window;
 - if *RX_Next_Reassembly* falls outside of the reassembly window:
 - set *RX_Next_Reassembly* to the SN of the first SN $\geq (RX_Next_Highest - UM_Window_Size)$ that has not been reassembled and delivered to upper layer.

[TS 38.322, clause 6.2.2.3]

An UM RLC entity is configured by RRC to use either a 6 bit SN or a 12 bit SN. An UMD PDU header contains the SN field only when the corresponding RLC SDU is segmented.

[TS 38.322, clause 6.2.3.3]

The SN field indicates the sequence number of the corresponding RLC SDU. ... For RLC UM, the sequence number is incremented by one for every segmented RLC SDU.

[TS 38.322, clause 7.1]

All state variables and all counters are non-negative integers.

...

All state variables related to UM data transfer can take values from 0 to 63 for 6 bit SN or from 0 to 4095 for 12 bit SN. All arithmetic operations contained in the present document on state variables related to UM data transfer are affected

by the UM modulus (i.e. final value = [value from arithmetic operation] modulo 64 for 6 bit SN and 4096 for 12 bit SN).

...

Each transmitting UM RLC entity shall maintain the following state variables:

a) TX_Next

This state variable holds the value of the SN to be assigned for the next newly generated UMD PDU with segment. It is initially set to 0, and is updated after the UM RLC entity submits a UMD PDU including the last segment of an RLC SDU to lower layers.

Each receiving UM RLC entity shall maintain the following state variables and constant:

b) RX_Next_Reassembly – UM receive state variable

This state variable holds the value of the earliest SN that is still considered for reassembly. It is initially set to 0.

c) RX_Timer_Trigger – UM *t-Reassembly* state variable

This state variable holds the value of the SN following the SN which triggered *t-Reassembly*.

d) RX_Next_Highest – UM receive state variable

This state variable holds the value of the SN following the SN of the UMD PDU with the highest SN among received UMD PDUs. It serves as the higher edge of the reassembly window. It is initially set to 0.

7.1.2.2.4.3 Test description

7.1.2.2.4.3.1 Pre-test conditions

Same Pre-test conditions as in clause 7.1.2.1.2 with the exception for the UM DRB is configured according to Table 7.1.2.2.4.3.1-1.

Table 7.1.2.2.4.3.1-1: RLC parameters

Uplink RLC sn-FieldLength	size12
Downlink RLC sn-FieldLength	size12

7.1.2.2.4.3.2 Test procedure sequence

Table 7.1.2.2.4.3.2-1: Main behaviour

St	Procedure	Message Sequence		TP	Verdict
		U - S	Message		
1	The SS transmits UMD PDU#1 with 12 bit SN = 0 containing the first segment of RLC SDU#1 (SI field = 01).	<--	UMD PDU#1	-	-
2	The SS transmits UMD PDU#2 with 12 bit SN=0 containing the last segment of RLC SDU#1 (SI field = 10) and including SO field	<--	UMD PDU#2	-	-
3	SS allocates 2 UL grants at an interval of 20 ms so as to loop back RLC SDU#1 in 2 RLC/MAC PDUs. (Note 1)	<--	UL Grants	-	-
4	Check: Does the UE transmit UMD PDU#1 with 12 bit SN = 0 containing the first segment of RLC SDU#1 (SI field = 01)?	-->	(RLC SDU#1, first segment)	1	P
5	Check: Does the UE transmit UMD PDU#2 with 12 bit SN = 0 containing the last segment of RLC SDU#1 (SI field = 10)?	-->	(RLC SDU#1, last segment)	1	P
-	EXCEPTION: Steps 6 to 10 are executed 4095 times, the initial value of k = 1, it is incremented by one for each iteration.	-	-	-	-
6	The SS transmits UMD PDU#(2*k+1) with 12 bit SN = k containing the first segment of RLC SDU#(k+1) (SI field = 01).	<--	UMD PDU#(2*k+1)	-	-
7	The SS transmits UMD PDU#(2*(k+1)) with 12 bit SN=k containing the last segment of RLC SDU#(k+1) (SI field = 10)	<--	UMD PDU#(2*(k+1))	-	-
8	SS allocates 2 UL grants at an interval of 20 ms so as to loop back RLC SDU#(k+1) in 2 RLC/MAC PDUs. (Note 1)	<--	UL Grants	-	-
9	Check: Does the UE transmit UMD PDU#(2*k+1) with 12 bit SN = k containing the first segment of RLC SDU#(k+1) (SI field = 01)? (Note 2)	-->	(RLC SDU#(k+1), first segment)	2	P
10	Check: Does the UE transmit UMD PDU#(2*(k+1)) with 12 bit SN = k containing the last segment of RLC SDU#(k+1) (SI field = 10) and including SO field? (Note 2)	-->	(RLC SDU#(k+1), last segment)	2	P
11	The SS transmits UMD PDU#8193 with 12 bit SN = 0 containing the first segment of RLC SDU#4097 (SI field = 01).	<--	UMD PDU#8193	-	-
12	The SS transmits UMD PDU#8194 with 12 bit SN= 0 containing the last segment of RLC SDU#4097 (SI field = 10) and including SO field	<--	UMD PDU#8194	-	-
13	SS allocates 2 UL grants at an interval of 20 ms so as to loop back RLC SDU#4097 in 2 RLC/MAC PDUs. (Note 1)	<--	UL Grants	-	-
14	Check: Does the UE transmit UMD PDU#8193 with 12 bit SN = 0 containing the first segment of RLC SDU#4097 (SI field = 01)?	-->	(RLC SDU#4097, first segment)	3,4	P
15	Check: Does the UE transmit UMD PDU#8194 with 12 bit SN = 0 containing the last segment of RLC SDU#4097 (SI field = 10) and including SO field?	-->	(RLC SDU#4097, last segment)	3,4	P
<p>Note 1: The RLC SDU size shall be 10 octets which are segmented into 5 and 5 octets. With 2 octets of MAC header, 2 octets of Short BSR and 2 octets of RLC header (without SO) the first segment consists of 88 bits and a TBS of this size shall be allocated. With 2 octets of MAC header and 4 octets of RLC header (with SO) the second segment consists of 88 bits and a TBS of this size shall be allocated. (L_{RBs} & I_{MCS} as per 38.523-3[3] annex B)</p> <p>Note 2: The verdict shall be provided each time (SN+1) mod 256 = 0.</p>					

7.1.2.2.4.3.3 Specific message contents

None.

7.1.2.2.5 UM RLC / Receive Window operation and t-Reassembly expiry

7.1.2.2.5.1 Test Purpose (TP)

(1)

```
with { UE in RRC_CONNECTED state and using UM RLC }
ensure that {
  when { UE receives a RLC PDU including SN and '(RX_Next_Highest - UM_Window_Size) <= SN <
RX_Next_Highest' }
  then { UE discards any UMD PDUs with SN that falls outside of the reassembly window }
}
```

(2)

```
with { UE in RRC_CONNECTED state and using UM RLC }
ensure that {
  when { UE receives a RLC PDU including SN and '(RX_Next_Highest - UM_Window_Size) > SN or SN >=
RX_Next_Reassembly' }
  then { UE stores the PDU in receive buffer }
}
```

(3)

```
with { UE in RRC_CONNECTED state and using UM RLC }
ensure that {
  when { UE places a RLC PDU including SN into the reception buffer and all byte segments with that
SN are received }
  then { UE delivers the reassembled SDU to upper layers}
}
```

(4)

```
with { UE in RRC_CONNECTED state and using UM RLC }
ensure that {
  when { t-Reassembly expires }
  then { UE updates RX_Next_Reassembly and discards all segments with SN < updated
RX_Next_Reassembly }
}
```

7.1.2.2.5.2 Conformance requirements

References: The conformance requirements covered in the present TC are specified in: TS 38.322, clauses 5.2.2.2.1, 5.2.2.2.2, 5.2.2.2.3, 5.2.2.2.4 and 7.1. Unless otherwise stated these are Rel-15 requirements.

[TS 38.322, clause 5.2.2.2.1]

The receiving UM RLC entity shall maintain a reassembly window according to state variable `RX_Next_Highest` as follows:

- a SN falls within the reassembly window if $(RX_Next_Highest - UM_Window_Size) \leq SN < RX_Next_Highest$;
- a SN falls outside of the reassembly window otherwise.

When receiving an UMD PDU from lower layer, the receiving UM RLC entity shall:

- either deliver the UMD PDU to upper layer after removing the RLC header, discard the received UMD PDU, or place it in the reception buffer (see sub clause 5.2.2.2.2);
- if the received UMD PDU was placed in the reception buffer:
 - update state variables, reassemble and deliver RLC SDUs to upper layer and start/stop *t-Reassembly* as needed (see sub clause 5.2.2.2.3).

When *t-Reassembly* expires, the receiving UM RLC entity shall:

- update state variables, discard RLC SDU segments and start *t-Reassembly* as needed (see sub clause 5.2.2.2.4).

[TS 38.322, clause 5.2.2.2.2]

When an UMD PDU is received from lower layer, the receiving UM RLC entity shall:

- if the UMD PDU header does not contain an SN:
 - remove the RLC header and deliver the RLC SDU to upper layer.
- else if $(RX_Next_Highest - UM_Window_Size) \leq SN < RX_Next_Reassembly$:
 - discard the received UMD PDU.
- else:
 - place the received UMD PDU in the reception buffer.

[TS 38.322, clause 5.2.2.2.3]

When an UMD PDU with $SN = x$ is placed in the reception buffer, the receiving UM RLC entity shall:

- if all byte segments with $SN = x$ are received:
 - reassemble the RLC SDU from all byte segments with $SN = x$, remove RLC headers and deliver the reassembled RLC SDU to upper layer;
- if $x = RX_Next_Reassembly$:
 - update $RX_Next_Reassembly$ to the SN of the first $SN > current\ RX_Next_Reassembly$ that has not been reassembled and delivered to upper layer.
- else if x falls outside of the reassembly window:
 - update $RX_Next_Highest$ to $x + 1$;
 - discard any UMD PDUs with SN that falls outside of the reassembly window;
 - if $RX_Next_Reassembly$ falls outside of the reassembly window:
 - set $RX_Next_Reassembly$ to the SN of the first $SN \geq (RX_Next_Highest - UM_Window_Size)$ that has not been reassembled and delivered to upper layer.
- if *t-Reassembly* is running:
 - if $RX_Timer_Trigger \leq RX_Next_Reassembly$; or
 - if $RX_Timer_Trigger$ falls outside of the reassembly window and $RX_Timer_Trigger$ is not equal to $RX_Next_Highest$; or
 - if $RX_Next_Highest = RX_Next_Reassembly + 1$ and there is no missing byte segment of the RLC SDU associated with $SN = RX_Next_Reassembly$ before the last byte of all received segments of this RLC SDU:
 - stop and reset *t-Reassembly*.
- if *t-Reassembly* is not running (includes the case when *t-Reassembly* is stopped due to actions above):
 - if $RX_Next_Highest > RX_Next_Reassembly + 1$; or
 - if $RX_Next_Highest = RX_Next_Reassembly + 1$ and there is at least one missing byte segment of the RLC SDU associated with $SN = RX_Next_Reassembly$ before the last byte of all received segments of this RLC SDU:
 - start *t-Reassembly*;
 - set $RX_Timer_Trigger$ to $RX_Next_Highest$.

[TS 38.322, clause 5.2.2.2.4]

When *t-Reassembly* expires, the receiving UM RLC entity shall:

- update RX_Next_Reassembly to the SN of the first SN \geq RX_Timer_Trigger that has not been reassembled;
- discard all segments with SN $<$ updated RX_Next_Reassembly;
- if RX_Next_Highest $>$ RX_Next_Reassembly + 1; or
- if RX_Next_Highest = RX_Next_Reassembly + 1 and there is at least one missing byte segment of the RLC SDU associated with SN = RX_Next_Reassembly before the last byte of all received segments of this RLC SDU:
 - start *t-Reassembly*;
 - set RX_Timer_Trigger to RX_Next_Highest.

[TS 38.322, clause 5.2.2.2.4]

This sub clause describes the state variables used in AM and UM entities in order to specify the RLC protocol. The state variables defined in this subclause are normative.

All state variables and all counters are non-negative integers.

...

All state variables related to UM data transfer can take values from 0 to 63 for 6 bit SN or from 0 to 4095 for 12 bit SN. All arithmetic operations contained in the present document on state variables related to UM data transfer are affected by the UM modulus (i.e. final value = [value from arithmetic operation] modulo 64 for 6 bit SN and 4096 for 12 bit SN).

When performing arithmetic comparisons of state variables or SN values, a modulus base shall be used.

...

$RX_Next_Highest - UM_Window_Size$ shall be assumed as the modulus base at the receiving side of an UM RLC entity. This modulus base is subtracted from all the values involved, and then an absolute comparison is performed (e.g. $(RX_Next_Highest - UM_Window_Size) \leq SN < RX_Next_Highest$ is evaluated as $[(RX_Next_Highest - UM_Window_Size) - (RX_Next_Highest - UM_Window_Size)] \text{ modulo } 2^{sn-FieldLength} \leq [SN - (RX_Next_Highest - UM_Window_Size)] \text{ modulo } 2^{sn-FieldLength} < [RX_Next_Highest - (RX_Next_Highest - UM_Window_Size)] \text{ modulo } 2^{sn-FieldLength}$), where *sn-FieldLength* is 6 or 12 for 6 bit SN and 12 bit SN, respectively.

...

Each transmitting UM RLC entity shall maintain the following state variables:

a) TX_Next

This state variable holds the value of the SN to be assigned for the next newly generated UMD PDU with segment. It is initially set to 0, and is updated after the UM RLC entity submits a UMD PDU including the last segment of an RLC SDU to lower layers.

Each receiving UM RLC entity shall maintain the following state variables and constant:

b) RX_Next_Reassembly – UM receive state variable

This state variable holds the value of the earliest SN that is still considered for reassembly. It is initially set to 0.

c) RX_Timer_Trigger – UM *t-Reassembly* state variable

This state variable holds the value of the SN following the SN which triggered *t-Reassembly*.

d) RX_Next_Highest– UM receive state variable

This state variable holds the value of the SN following the SN of the UMD PDU with the highest SN among received UMD PDUs. It serves as the higher edge of the reassembly window. It is initially set to 0.

7.1.2.2.5.3 Test description

7.1.2.2.5.3.1 Pre-test conditions

Same Pre-test conditions as in clause 7.1.2.1.2 with the exception that the UM DRB is configured according to Table 7.1.2.2.5.3.1-1.

Table 7.1.2.2.5.3.1-1: RLC parameters

t-Reassembly	ms200
Uplink UM RLC sn-FieldLength	IF (pc_um_WithShortSN) size6 ELSE size12
Downlink UM RLC sn-FieldLength	F (pc_um_WithShortSN) size6 ELSE size12

Table 7.1.2.2.5.3.1-2: PDCP Settings

Parameter	Value
t-Reordering	ms30

7.1.2.2.5.3.2 Test procedure sequence

Table 7.1.2.2.5.3.2-1: Main behaviour

St	Procedure	Message Sequence		TP	Verdict
		U - S	Message		
0	The SS ignores scheduling requests and does not allocate any uplink grant.	-	-	-	-
1	The SS transmits UMD PDU#1 containing first segment of RLC SDU#1, SN=0.	<--	UMD PDU#1	-	-
2	20 ms after step 1 the SS transmits UMD PDU#3 containing first segment of RLC SDU#2, SN=1.	<--	UMD PDU#3	-	-
3	40 ms after step 1 the SS transmits UMD PDU#4 containing last segment of RLC SDU#2, SN=1.	<--	UMD PDU#4	-	-
3A	60 ms after step 1 the SS transmits UMD PDU#9 containing first segment of RLC SDU#5, SN=w	<--	UMD PDU#9	-	-
3B	80 ms after step 1 the SS transmits UMD PDU#10 containing last segment of RLC SDU#5, SN=w	<--	UMD PDU#10	-	-
3C	100 ms after step 1 the SS assigns 2 UL grants (UL grant allocation type 2) with a time spacing of 20 ms so as to loop back RLC SDU#2.	-	-	-	-
4	Check: Does the UE transmit RLC SDU#2? (Note 3)	-->	(RLC SDU#2)	2,3	P
4A	Check: Does the UE transmit RLC SDU#5? (Note 4)	-->	(RLC SDU#5)	2,3	P
5	160 ms after step 1 the SS transmits UMD PDU#2 last segment of RLC SDU#1, SN=0.	<--	UMD PDU#2	-	-
5A	The SS starts the UL default grant transmissions.	-	-	-	-
6	Check: For 1 sec after step 5, does the UE transmit RLC SDU#1, SN=0? (Note 6)	-->	(RLC SDU#1)	1	F
6A		-	-	-	-
7	The SS transmits UMD PDU#5 containing first segment of RLC SDU#3, SN=5.	<--	UMD PDU#5	-	-
8	Wait for 200 ms to ensure that t - Reassembly for the UMD PDU#5 expires.	-	-	-	-
9	The SS transmits UMD PDU#6 containing last segment of RLC SDU#3, SN=5 (Note 7).	<--	UMD PDU#6	-	-
10	Check: For 1 sec after step 9, does the UE transmit RLC SDU#3? (Note 7)	-->	(RLC SDU#3)	4	F
11	The SS transmits UMD PDU#7 containing first segment of RLC SDU#6, SN=8.	<--	UMD PDU#7	-	-
12	The SS transmits UMD PDU#8 containing last segment of RLC SDU#6, SN=8.	<--	UMD PDU#8	-	-
13	Check: Does the UE transmit RLC SDU#6? (Note 5)	-->	(RLC SDU#4)	2,3	P
<p>Note 1: The RLC SDU size shall be 12 octets which are segmented into 7 and 5 octets.</p> <p>Note 2: UL grant of 144 bits (L_{RBs} & l_{MCS} as per 38.523-3[3] annex B) is chosen to allow the UE to transmit one PDU at a time (12 bytes RLC SDU + 1 or 2 bytes RLC Header + 2 bytes MAC Sub PDU header + 2 or 3 bytes for short BSR and/or padding).</p> <p>Note 3: The UE transmits the looped back PDCP data of RLC SDU#2 in a PDCP PDU with PDCP SN=0.</p> <p>Note 4: The UE transmits the looped back PDCP data of RLC SDU#5 in a PDCP PDU with PDCP SN=1.</p> <p>Note 5: The UE transmits the looped back PDCP data of RLC SDU#6 in a PDCP PDU with PDCP SN=2.</p> <p>Note 6: The UE transmits the looped back PDCP data of RLC SDU#1 in a PDCP PDU with PDCP SN=2.</p> <p>Note 7: The UE transmits the looped back PDCP data of RLC SDU#3 in a PDCP PDU with PDCP SN=2.</p>					

7.1.2.2.5.3.3 Specific message contents

None

7.1.2.2.6 UM RLC / RLC re-establishment procedure

7.1.2.2.6.1 Test Purpose (TP)

(1)

```
with { UE in RRC_CONNECTED state and using UM RLC }
ensure that {
  when { RLC re-establishment is performed upon request by RRC }
  then { The UE discards all UMD PDUs where no RLC SDUs can be reassembled }
}
```

(2)

```
with { UE in RRC_CONNECTED state and using UM RLC }
ensure that {
  when { RLC re-establishment is performed upon request by RRC }
  then { The UE resets variables TX_Next, RX_Next_Reassembly, and RX_Next_Highest to their initial
value of 0 }
}
```

7.1.2.2.6.2 Conformance requirements

References: The conformance requirements covered in the present TC are specified in: TS 38.322, clauses 5.1.2 and 7.1, TS 38.331 clause 5.3.5.5.4. Unless otherwise stated these are Rel-15 requirements.

[TS 38.322, clause 5.1.2]

When upper layers request an RLC entity re-establishment, the UE shall:

- discard all RLC SDUs, RLC SDU segments, and RLC PDUs, if any;
- stop and reset all timers;
- reset all state variables to their initial values.

[TS 38.322, clause 7.1]

d) RX_Next_Highest – Highest received state variable

This state variable holds the value of the SN following the SN of the RLC SDU with the highest SN among received RLC SDUs. It is initially set to 0.

Each transmitting UM RLC entity shall maintain the following state variables:

a) TX_Next

This state variable holds the value of the SN to be assigned for the next newly generated UMD PDU with segment. It is initially set to 0, and is updated after the UM RLC entity submits a UMD PDU including the last segment of an RLC SDU to lower layers.

Each receiving UM RLC entity shall maintain the following state variables and constant:

b) RX_Next_Reassembly – UM receive state variable

This state variable holds the value of the earliest SN that is still considered for reassembly. It is initially set to 0.

c) RX_Timer_Trigger – UM *t-Reassembly* state variable

This state variable holds the value of the SN following the SN which triggered *t-Reassembly*.

d) RX_Next_Highest– UM receive state variable

This state variable holds the value of the SN following the SN of the UMD PDU with the highest SN among received UMD PDUs. It serves as the higher edge of the reassembly window. It is initially set to 0.

[TS 38.331, clause 5.3.5.5.4]

For each *RLC-Bearer-Config* received in the *rlc-BearerToAddModList* IE the UE shall:

- 1> if the UE's current configuration contains a RLC bearer with the received *logicalChannelIdentity*:
 - 2> if *reestablishRLC* is received:
 - 3> re-establish the RLC entity as specified in TS 38.322 [4];
 - 2> reconfigure the RLC entity or entities in accordance with the received *rlc-Config*;
 - 2> reconfigure the logical channel in accordance with the received *mac-LogicalChannelConfig*;

NOTE: The network does not re-associate an already configured logical channel with another radio bearer. Hence *servedRadioBearer* is not present in this case.

7.1.2.2.6.3 Test description

7.1.2.2.6.3.1 Pre-test conditions

Same Pre-test conditions as in clause 7.1.2.1.2 with the exception that the UM DRB is configured according to Table 7.1.2.2.6.3.1-1.

Table 7.1.2.2.6.3.1-1: RLC parameters

t-Reassembly	ms200
Uplink UM RLC sn-FieldLength	IF (pc_um_WithShortSN) size6 ELSE size12
Downlink UM RLC sn-FieldLength	IF (pc_um_WithShortSN) size6 ELSE size12

7.1.2.2.6.3.2 Test procedure sequence

Table 7.1.2.2.6.3.2-1: Main behaviour

St	Procedure	Message Sequence		TP	Verdict
		U - S	Message		
1	The SS transmits UMD PDU#1. Header of UMD PDU#1 does not contain an SN. This PDU carries RLC SDU#1.	<--	UMD PDU#1	-	-
2	The UE transmits RLC SDU#1.	-->	(RLC SDU#1)	-	-
3	The SS transmits UMD PDU#2. Header of UMD PDU#2 contains SN=0. This PDU carries the first segment of SDU#2.	<--	UMD PDU#2	-	-
4	The SS transmits NR <i>RRCReconfiguration</i> message to trigger RLC re-establishment on DRB using Reconfig with sync procedure. (Note 3)(Note 5)	<--	<i>RRCReconfiguration</i>	-	-
4A	The UE transmits a NR <i>RRCReconfigurationcomplete</i> message. (Note 4)	-->	<i>RRCReconfigurationComplete</i>	-	-
5	100 ms after step 4A the SS transmits UMD PDU#3. Header of UMD PDU#3 contains SN=0. This PDU carries the last segment of RLC SDU#2. The UE starts t-Reassembly.	<--	UMD PDU#3	-	-
6	Check: For 250 ms after step 5 does the UE transmit RLC SDU#2?	-->	(RLC SDU#2)	1	F
6A	The SS stops allocating any UL grant.				
7	300 ms (1.5 * t-Reassembly) after step 5 the SS transmits UMD PDU#4. This PDU carries the first segment of RLC SDU#3.SN=1.	<--	UMD PDU#4	-	-
8	20 ms after step 7 the SS transmits UMD PDU#5. This PDU carries the second and last segment of RLC SDU#3.SN=1.	<--	UMD PDU#5	-	-
8A	20 ms after step 8 the SS allocates 2 UL grants at an interval of 20 ms so as to loop back RLC SDU#3 in 2 RLC/MAC PDUs. Note 1 & 2	-	-	-	-
9	Check: Does the UE transmit first segment of RLC SDU#3? Header of UMD PDU contains SN=0.	-->	(RLC SDU#3 first segment)	2	P
10	Check: Does the UE transmit second and last segment of RLC SDU#3? Header of UMD PDU contains SN=0.	-->	(RLC SDU#3 last segment)	2	P
10A	The SS starts the UL default grant transmissions				
11	The SS transmits NR <i>RRCReconfiguration</i> message to trigger RLC re-establishment on DRB using Reconfig with sync procedure. (Note 3)	<--	<i>RRCReconfiguration</i>	-	-
11A	The UE transmits a NR <i>RRCReconfigurationcomplete</i> message. (Note 4)	-->	<i>RRCReconfigurationComplete</i>	-	-
11B	The SS stops allocating any UL grant.				
12	After 100 ms the SS transmits UMD PDU#6. Header of UMD PDU#6 contains SN=0. This PDU carries the first segment of SDU#4.	<--	UMD PDU#6	-	-
13	20 ms after step 12 the SS transmits UMD PDU#7. Header of UMD PDU#6 contains SN=0. This PDU carries the second segment of SDU#4.	<--	UMD PDU#7	-	-
13A	20 ms after step 13 the SS allocates 2 UL grants at an interval of 20 ms so as to loop back RLC SDU#4 in 2 RLC/MAC PDUs. Note 1 & 2	-	-	-	-
14	Check: Does the UE transmit first segment of RLC SDU#4? Header of UMD PDU contains SN=0.	-->	(RLC SDU#4 first segment)	2	P

15	Check: Does the UE transmit second and last segment of RLC SDU#4? Header of UMD PDU contains SN=0.	-->	(RLC SDU#4 last segment)	2	P
Note 1:	For SN size = size6 the RLC SDU size shall be 12 octets which are segmented into 6 and 6 octets. With 2 octets of MAC BSR and 2 octets of MAC header and 1 octet of RLC header (without SO) the first segment consists of 88 bits and a TBS of this size shall be allocated. With 2 octets of MAC header and 3 octets of RLC header (with SO) the second segment consists of 88 bits and a TBS of this size shall be allocated. (L _{RBS} & l _{MCS} as per 38.523-3[3] annex B)				
Note 2:	For SN size = size12 the RLC SDU size shall be 10 octets which are segmented into 5 and 5 octets. With 2 octets of MAC BSR and 2 octets of MAC header and 2 octets of RLC header (without SO) the first segment consists of 88 bits and a TBS of this size shall be allocated. With 2 octets of MAC header and 4 octets of RLC header (with SO) the second segment consists of 88 bits and a TBS of this size shall be allocated. (L _{RBS} & l _{MCS} as per 38.523-3[3] annex B)				
Note 3:	For EN-DC, the NR RRCReconfiguration message is contained in RRCConnectionReconfiguration as defined in Table 7.1.2.2.6.3.3-2				
Note 4:	For EN-DC, the NR RRCReconfigurationComplete message is contained in RRCConnectionReconfigurationComplete.				

7.1.2.2.6.3.3 Specific message contents

Table 7.1.2.2.6.3.3-1: RRCReconfiguration for NR (steps 4, 11, Table 7.1.2.2.6.3.2-1)

Derivation Path: 38.508-1 [4], Table 4.6.1-13			
Information Element	Value/remark	Comment	Condition
RRCReconfiguration ::= SEQUENCE {			
criticalExtensions CHOICE {			
rrcReconfiguration ::= SEQUENCE {			
radioBearerConfig	RadioBearerConfig according to TS 38.508-1 [4], table 4.6.3-132 with conditions SRB1 and SRB2 and DRBn	n set to the default DRB of the first PDU session	
}			
nonCriticalExtension ::= SEQUENCE {			
masterCellGroup	CellGroupConfig according to TS 38.508-1 [4], table 4.6.3-19 with condition PCell_change		
}			
}			
}			

Table 7.1.2.2.6.3.3-2: RRCConnectionReconfiguration for EN-DC (steps 4, 11 Table 7.1.2.2.6.3.2-1)

Derivation Path: 36.508 Table 4.6.1-8			
Information Element	Value/remark	Comment	Condition
RRCConnectionReconfiguration ::= SEQUENCE {			
criticalExtensions CHOICE {			
c1 CHOICE{			
rrcConnectionReconfiguration-r8 ::= SEQUENCE			
{			
nonCriticalExtension ::= SEQUENCE {			
nonCriticalExtension ::= SEQUENCE {			
nonCriticalExtension ::= SEQUENCE {			
nr-Config-r15 CHOICE {			
nr-SecondaryCellGroupConfig-r15	OCTET STRING including the RRCReconfiguration message and the IE secondaryCellGroup according TS 38.508-1 [67], table 4.6.1-13 with condition EN-DC_HO		
}			
}			
nr-RadioBearerConfig1-r15	OCTET STRING including RadioBearerConfig according TS 38.508-1 [67], table 4.6.3-132 with conditions EN-DC_DRB		
}			
}			
}			
}			
}			

7.1.2.3 RLC Acknowledged Mode

7.1.2.3.1 AM RLC / 12-bit SN / Segmentation and reassembly / Segmentation Info (SI) field

7.1.2.3.1.1 Test Purpose (TP)

(1)

```
with { UE in RRC_CONNECTED state }
ensure that {
  when { UE receives a 12 bit SN configured AMD PDU containing a SI field set to 00 }
  then { UE correctly decodes the received AMD PDU }
}
```

(2)

```
with { UE in RRC_CONNECTED state }
ensure that {
  when { UE receives a 12 bit SN configured AMD PDU containing a SI field set to 01 }
  then { UE correctly decodes the received AMD PDU }
}
```

(3)

```
with { UE in RRC_CONNECTED state }
ensure that {
  when { UE receives a 12 bit SN configured AMD PDU containing a SI field set to 11 and SO field }
  then { UE correctly decodes the received AMD PDU }
}
```

(4)

```

with { UE in RRC_CONNECTED state }
ensure that {
  when { UE receives a 12 bit SN configured AMD PDU containing a SI field set to 10 and SO field }
  then { UE correctly decodes the received AMD PDU }
}

```

(5)

```

with { UE in RRC_CONNECTED state }
ensure that {
  when { UE has UL RLC SDU to send and the UL Grant is sufficient to send complete PDU }
  then { UE transmits AMD PDU containing a complete AMD SDU and SI field set to 00 }
}

```

(6)

```

with { UE in RRC_CONNECTED state }
ensure that {
  when { UE has UL RLC SDU to send and the UL Grant is sufficient to send first segment only }
  then { UE transmits AMD PDU containing first segment of AMD SDU and SI field set to 01 }
}

```

(7)

```

with { UE in RRC_CONNECTED state }
ensure that {
  when { UE has UL RLC SDU to send and the UL Grant is sufficient to send middle segment only }
  then { UE transmits AMD PDU containing middle segment of AMD SDU and SI field set to 11,
including SO field }
}

```

(8)

```

with { UE in RRC_CONNECTED state }
ensure that {
  when { UE has UL RLC SDU to send and the UL Grant is sufficient to send last segment only }
  then { UE transmits AMD PDU containing last segment of AMD SDU and SI field set to 10, including
SO field }
}

```

7.1.2.3.1.2 Conformance requirements

References: The conformance requirements covered in the present TC are specified in: TS 38.322, clauses 6.2.2.4 and 6.2.3.4. Unless otherwise stated these are Rel-15 requirements.

[TS 38.322, clause 6.2.2.4]

AMD PDU consists of a Data field and an AMD PDU header. The AMD PDU header is byte aligned.

An AM RLC entity is configured by RRC to use either a 12 bit SN or a 18 bit SN. The length of the AMD PDU header is two and three bytes respectively.

An AMD PDU header contains a D/C, a P, a SI, and a SN. An AMD PDU header contains the SO field only when the Data field consists of an RLC SDU segment which is not the first segment, in which case a 16 bit SO is present.

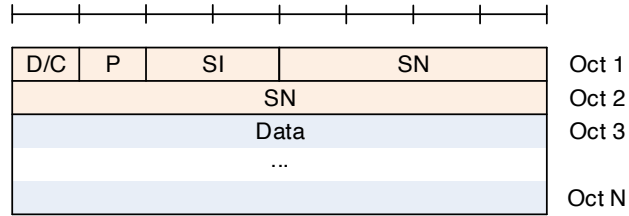

Figure 6.2.2.4-1: AMD PDU with 12 bit SN (No SO)

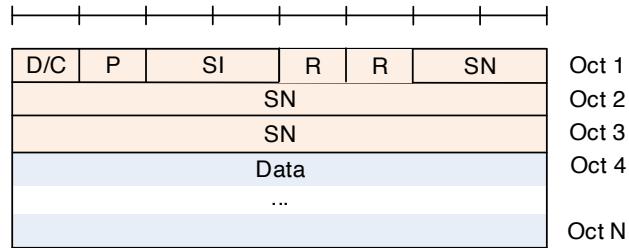

Figure 6.2.2.4-2: AMD PDU with 18 bit SN (No SO)

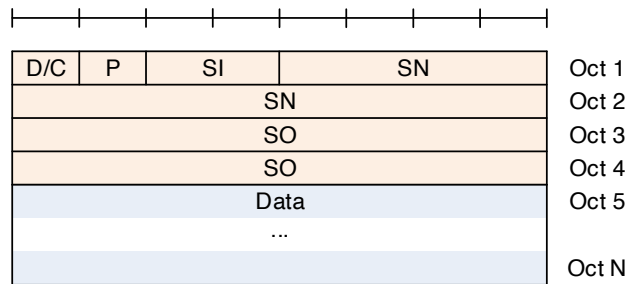

Figure 6.2.2.4-3: AMD PDU with 12 bit SN with SO

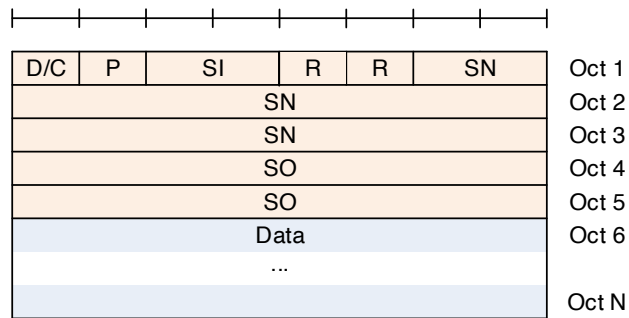

Figure 6.2.2.4-4: AMD PDU with 18 bit SN with SO

[TS 38.322, clause 6.2.3.4]

Length: 2 bits.

The SI field indicates whether an RLC PDU contains a complete RLC SDU or the first, middle, last segment of an RLC SDU.

Table 6.2.3.4-1: SI field interpretation

Value	Description
00	Data field contains all bytes of an RLC SDU
01	Data field contains the first segment of an RLC SDU
10	Data field contains the last segment of an RLC SDU
11	Data field contains neither the first nor last segment of an RLC SDU

7.1.2.3.1.3 Test description

7.1.2.3.1.3.1 Pre-test conditions

Same Pre-test conditions as in clause 7.1.2.1.1 with the exception that the AM DRB is configured according to Table 7.1.2.3.1.3.1-1.

Table 7.1.2.3.1.3.1-1: RLC parameters

Uplink SN-FieldLength-AM	size12
Downlink SN-FieldLength-AM	size12

7.1.2.3.1.3.2 Test procedure sequence

Table 7.1.2.3.1.3.2-1: Main behaviour

St	Procedure	Message Sequence		TP	Verdict
		U - S	Message		
0	The SS stops allocating any UL grant.	-	-	-	-
1	The SS transmits AMD PDU#1 containing a complete RLC SDU#1 (SI field = 00).	<--	AMD PDU#1	-	-
1A	60 ms after Step1, SS allocates an UL grant sufficient to loop back RLC SDU#1 in one RLC/MAC PDU	<--	UL Grant	-	-
2	Check: Does the UE transmit AMD PDU#1 containing a complete RLC SDU#1 (SI field = 00)?	-->	(RLC SDU#1)	1,5	P
3	The SS transmits a STATUS PDU.	<--	STATUS PDU (ACK SN=1)	-	-
4	The SS transmits AMD PDU#2 containing the first segment of RLC SDU#2 (SI field = 01). Note 3	<--	AMD PDU#2	-	-
5	The SS transmits AMD PDU#3 containing the second segment of RLC SDU#2 (SI field = 11) and including SO field. Note 3	<--	AMD PDU#3	-	-
6	The SS transmits AMD PDU#4 containing the last segment of RLC SDU#2 (SI field = 10) and including SO field. Note 3	<--	AMD PDU#4	-	-
6A	SS allocates 3 UL grants at an interval of 20 ms so as to loop back RLC SDU#2 in 3 RLC/MAC PDUs. (Note 1 and Note 2)	<--	UL Grants	-	-
7	Check: Does the UE transmit AMD PDU#2 containing the first segment of RLC SDU#2 (SI field = 01)?	-->	(RLC SDU#2)	2,3, 4,6	P
8	Check: Does the UE transmit AMD PDU#3 containing the middle segment of RLC SDU#2 (SI field = 11) and including SO field?	-->	(RLC SDU#2)	2,3, 4,7	P
9	Check: Does the UE transmit AMD PDU#4 containing the last segment of RLC SDU#2 (SI field = 10) and including SO field?	-->	(RLC SDU#2)	2,3, 4,8	P
10	The SS transmits a STATUS PDU.	<--	STATUS PDU (ACK SN=2)	-	-
<p>Note 1: The UL grants for step 7,8,9 are sufficiently small (240 bits, L_{RBs} & I_{MCS} as per 38.523-3[3] annex B) that UE transmits RLC SDU#2 in 3 UL RLC PDUs by segmenting.</p> <p>Note 2: The RLC PDU containing a segment shall be of size 208 bits resp. 224 bits and a MAC sub PDU header of 16 bits and a 16-bit MAC BSR CE included in step 8 resulting in a MAC PDU of size 240 bits.</p> <p>Note 3: The data part in step 4 first segment not including SO is 192 bits (24 bytes). Step 5, second segment SO=24 and data is 192 bits (24 bytes). Step 6, third segment SO=24+24=48 and data is 192 bits (24 bytes).</p>					

7.1.2.3.1.3.3 Specific message contents

None

7.1.2.3.2 AM RLC / 18-bit SN / Segmentation and reassembly / Segmentation Info (SI) field

7.1.2.3.2.1 Test Purpose (TP)

(1)

```

with { UE in RRC_CONNECTED state }
ensure that {
  when { UE receives a 18 bit SN configured AMD PDU containing a SI field set to 00 }
  then { UE correctly decodes the received AMD PDU or AMD PDU segment }
}

```

(2)

```

with { UE in RRC_CONNECTED state }
ensure that {
  when { UE receives a 18 bit SN configured AMD PDU containing a SI field set to 01 }
  then { UE correctly decodes the received AMD PDU or AMD PDU segment }
}

```

(3)

```

with { UE in RRC_CONNECTED state }
ensure that {
  when { UE receives a 18 bit SN configured AMD PDU containing a SI field set to 11 and SO field }
  then { UE correctly decodes the received AMD PDU or AMD PDU segment }
}

```

(4)

```

with { UE in RRC_CONNECTED state }
ensure that {
  when { UE receives a 18 bit SN configured AMD PDU containing a SI field set to 10 and SO field }
  then { UE correctly decodes the received AMD PDU or AMD PDU segment }
}

```

(5)

```

with { UE in RRC_CONNECTED state }
ensure that {
  when { UE has UL RLC SDU to send and the UL Grant is sufficient to send complete PDU }
  then { UE transmits AMD PDU containing a complete AMD SDU and SI field set to 00 }
}

```

(6)

```

with { UE in RRC_CONNECTED state }
ensure that {
  when { UE has UL RLC SDU to send and the UL Grant is sufficient to send first segment only }
  then { UE transmits AMD PDU containing first segment of AMD SDU and SI field set to 01 }
}

```

(7)

```

with { UE in RRC_CONNECTED state }
ensure that {
  when { UE has UL RLC SDU to send and the UL Grant is sufficient to send middle segment only }
  then { UE transmits AMD PDU containing middle segment of AMD SDU and SI field set to 11,
including SO field }
}

```

(8)

```

with { UE in RRC_CONNECTED state }
ensure that {
  when { UE has UL RLC SDU to send and the UL Grant is sufficient to send last segment only }
  then { UE transmits AMD PDU containing last segment of AMD SDU and SI field set to 10, including
SO field }
}

```

7.1.2.3.2.2 Conformance requirements

Same conformance requirements as in clause 7.1.2.3.1.2

7.1.2.3.2.3 Test description

7.1.2.3.2.3.1 Pre-test conditions

Same Pre-test conditions as in clause 7.1.2.1.1 with the exception that the AM DRB is configured according to Table 7.1.2.3.2.3.1-1.

Table 7.1.2.3.2.3.1-1: RLC parameters

Uplink SN-FieldLength-AM	size18
Downlink SN-FieldLength-AM	size18

7.1.2.3.2.3.2 Test procedure sequence

Same test procedure as in clause 7.1.2.3.1.3.2 except that SN is 18 bit and the data part in step 4 first segment not including SO is 184 bits (23 Bytes). Step 5, second segment SO=23 and data is 184 bits (23 bytes). Step 6, third segment SO=23+23=46 and data is 184 bits (23 bytes).

7.1.2.3.2.3.3 Specific message contents

None

7.1.2.3.3 AM RLC / 12-bit SN / Correct use of sequence numbering**7.1.2.3.3.1 Test Purpose (TP)**

(1)

```
with { UE in RRC_CONNECTED state with AM RLC 12 bit SN }
ensure that {
  when { UE transmits the PDU corresponding to first SDU }
  then { UE includes the SN field equal to 0 in PDU }
}
```

(2)

```
with { UE in RRC_CONNECTED state with AM RLC 12 bit SN }
ensure that {
  when { UE transmits subsequent SDUs }
  then { UE includes the SN field incremented by 1 per SDU of each PDU transmitted }
}
```

(3)

```
with { UE in RRC_CONNECTED state with AM RLC 12 bit SN }
ensure that {
  with { UE transmits more than 4096 SDUs }
  then { UE wraps the SN after transmitting the 4096 SDUs }
}
```

(4)

```
with { UE in RRC_CONNECTED state with AM RLC 12 bit SN }
ensure that {
  with { more than 4096 SDUs are sent to UE }
  then { UE accepts PDUs with SNs that wrap around every 4096 SDUs }
}
```

7.1.2.3.3.2 Conformance requirements

References: The conformance requirements covered in the present TC are specified in: TS 38.322, clauses 5.2.3.1.1, 5.2.3.2.1, 5.2.3.2.2, 6.2.2.4 and 7.1. Unless otherwise stated these are Rel-15 requirements.

[TS 38.322, clause 5.2.3.2.1]

The receiving side of an AM RLC entity shall maintain a receiving window according to the state variable RX_Next as follows:

- a SN falls within the receiving window if $RX_Next \leq SN < RX_Next + AM_Window_Size$;
- a SN falls outside of the receiving window otherwise.

When receiving an AMD PDU from lower layer, the receiving side of an AM RLC entity shall:

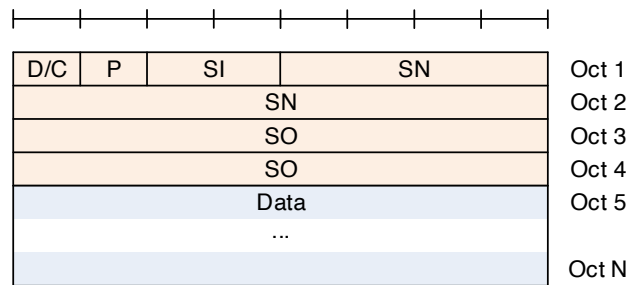

Figure 6.2.2.4-3: AMD PDU with 12 bit SN with SO

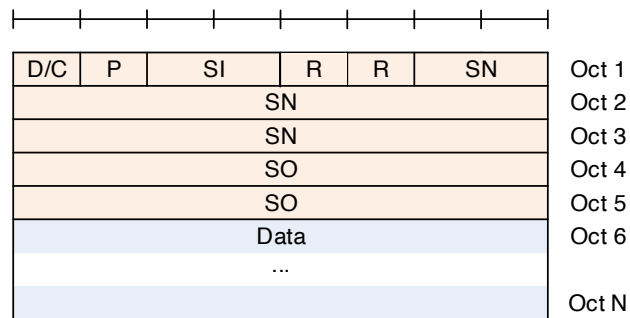

Figure 6.2.2.4-4: AMD PDU with 18 bit SN with SO

[TS 38.322, clause 7.1]

c) RETX_COUNT – Counter

This counter counts the number of retransmissions of an RLC SDU or RLC SDU segment (see subclause 5.3.2). There is one RETX_COUNT counter maintained per RLC SDU.

The receiving side of each AM RLC entity shall maintain the following state variables:

a) RX_Next – Receive state variable

This state variable holds the value of the SN following the last in-sequence completely received RLC SDU, and it serves as the lower edge of the receiving window. It is initially set to 0, and is updated whenever the AM RLC entity receives an RLC SDU with SN = RX_Next.

b) RX_Next_Status_Trigger – *t-Reassembly* state variable

This state variable holds the value of the SN following the SN of the RLC SDU which triggered *t-Reassembly*.

c) RX_Highest_Status – Maximum STATUS transmit state variable

This state variable holds the highest possible value of the SN which can be indicated by "ACK_SN" when a STATUS PDU needs to be constructed. It is initially set to 0.

d) RX_Next_Highest – Highest received state variable

This state variable holds the value of the SN following the SN of the RLC SDU with the highest SN among received RLC SDUs. It is initially set to 0.

Each transmitting UM RLC entity shall maintain the following state variables:

a) TX_Next

This state variable holds the value of the SN to be assigned for the next newly generated UMD PDU with segment. It is initially set to 0, and is updated after the UM RLC entity submits a UMD PDU including the last segment of an RLC SDU to lower layers.

Each receiving UM RLC entity shall maintain the following state variables and constant:

b) RX_Next_Reassembly – UM receive state variable

This state variable holds the value of the earliest SN that is still considered for reassembly. It is initially set to 0.

c) RX_Timer_Trigger – UM *t-Reassembly* state variable

This state variable holds the value of the SN following the SN which triggered *t-Reassembly*.

d) RX_Next_Highest– UM receive state variable

This state variable holds the value of the SN following the SN of the UMD PDU with the highest SN among received UMD PDUs. It serves as the higher edge of the reassembly window. It is initially set to 0.

7.1.2.3.3.3 Test description

7.1.2.3.3.3.1 Pre-test conditions

Same Pre-test conditions as in clause 7.1.2.1.1 with the exception that the AM DRB is configured according to Table 7.1.2.3.3.1-1.

Table 7.1.2.3.3.1-1: RLC parameters

Uplink SN-FieldLength-AM	size12
Downlink SN-FieldLength-AM	size12
pollPDU	p2048
pollByte	kB25

7.1.2.3.3.3.2 Test procedure sequence

Table 7.1.2.3.3.3.2-1: Main behaviour

St	Procedure	Message Sequence		TP	Verdict
		U - S	Message		
-	EXCEPTION: Steps 1 – 3a1 shall be repeated from $j=0$ to $j=\text{FLOOR}(\frac{\text{Maximum_RLC_SN}}{\text{iteration_size}})$. (Note 1, 3, 4, 6)	-	-	-	-
1	SS transmits several RLC PDUs in a RLC PDU List, the number of RLC PDUs sent is defined by the iteration_size. (Note 5). Each RLC Data PDU contains one RLC SDU.	<--	RLC Data PDU (SN = $j \cdot \text{iteration_size}$, SN = $((j+1) \cdot \text{iteration_size}) - 1$)	-	-
-	EXCEPTION: In Step 2, SS may receive a RLC PDU or several RLC PDUs, then step 2 may be repeated multiple times until all RLC PDUs with SN = $j \cdot \text{iteration_size}$ to SN = $((j+1) \cdot \text{iteration_size}) - 1$ for each iteration are received.	-	-	-	-
2	CHECK: Does UE transmit RLC Data PDUs with SN=0 for the first iteration and all RLC Data PDUs for each iteration? (Note 2)	-->	RLC Data PDU (SN = $j \cdot \text{iteration_size}$, SN = $((j+1) \cdot \text{iteration_size}) - 1$)	1,2	P
-	EXCEPTION: Step 3a1 describes behaviour that depends on the contents of the AMD PDU transmitted at Step 2.	-	-	-	-
3a1	IF the UE has set the poll bit in the AMD PDU transmitted at Step 2 THEN the SS transmits a Status Report.	<--	STATUS PDU	-	-
4	SS transmits a RLC Data PDU containing one RLC SDU.	<--	RLC Data PDU (SN = 0)	-	-
5	CHECK: Does UE transmit a RLC Data PDU with SN=0?	-->	RLC Data PDU (SN = 0)	3,4	P
6	The SS transmits a STATUS PDU with ACK_SN = 1.	<--	STATUS PDU	-	-
<p>Note 1: $\text{Maximum_RLC_SN} = 2^{\lfloor \frac{\text{RLC-SN-SizeUL}}{2} \rfloor} - 1$.</p> <p>Note 2: The verdict shall be provided each time $[(\text{SN}+1) \bmod 256 = 0]$ for 12 bit SN and $[(\text{SN}+1) \bmod 4096 = 0]$ for 18 bit SN respectively.</p> <p>Note 3: Iteration will be incremented by iteration_size of 1 in case of 12 bit SN, and it shall be repeated Maximum_RLC_SN.</p> <p>Note 4: Iteration will be incremented by iteration_size of 2^5 for 18 bit SN. Small RLC SDU size will be used and it shall be repeated $\text{FLOOR}(\frac{\text{Maximum_RLC_SN}}{\text{iteration_size}})$.</p> <p>Note 5: SS shall transmit a RLC PDU list with size equal to iteration_size and incrementing SN by 1 till SN = $((j + 1) \cdot \text{iteration_size}) - 1$.</p> <p>Note 6: The RLC SDU size shall be 4 octets (3 octets of PDCP header + 1 octet PDCP SDU).</p>					

7.1.2.3.3.3.3 Specific message contents

None.

7.1.2.3.4 AM RLC / 18-bit SN / Correct use of sequence numbering

7.1.2.3.4.1 Test Purpose (TP)

(1)

```

with { UE in RRC_CONNECTED state with AM RLC 18 bit SN }
ensure that {
  when { UE transmits the PDU corresponding to first SDU }
  then { UE includes the SN field equal to 0 in PDU }
}

```

(2)

```

with { UE in RRC_CONNECTED state with AM RLC 18 bit SN }
ensure that {
  when { UE transmits subsequent SDUs }
  then { UE includes the SN field incremented by 1 per SDU of each PDU transmitted }
}

```

(3)

```

with { UE in RRC_CONNECTED state with AM RLC 18 bit SN }
ensure that {
  with { UE transmits more than 262144 SDUs }
  then { UE wraps the SN after transmitting the 262144 SDUs }
}

```

(4)

```

with { UE in RRC_CONNECTED state with AM RLC 18 bit SN }
ensure that {
  with { more than 262144 SDUs are sent to UE }
  then { UE accepts PDUs with SNs that wrap around every 262144 SDUs }
}

```

7.1.2.3.4.2 Conformance requirements

Same as conformance requirements in clause 7.1.2.3.3.2

7.1.2.3.4.3 Test description

7.1.2.3.4.3.1 Pre-test conditions

Same Pre-test conditions as in clause 7.1.2.1.1 with the exception that the AM DRB is configured according to Table 7.1.2.3.4.3.1-1.

Table 7.1.2.3.4.3.1-1: RLC parameters

Uplink SN-FieldLength-AM	size18
Downlink SN-FieldLength-AM	size18
pollPDU	p2048
pollByte	kB25

7.1.2.3.4.3.2 Test procedure sequence

Same as test procedure in clause 7.1.2.3.3.2

7.1.2.3.4.3.3 Specific message contents

None.

7.1.2.3.5 AM RLC / 12-bit SN / Control of transmit window/Control of receive window

7.1.2.3.5.1 Test Purpose (TP)

(1)

```

with { UE in RRC_CONNECTED state with AM RLC 12 bit SN and pending uplink data for transmission }
ensure that {
  when { AMD PDUs in transmission buffer fall outside TX_Next_Ack <= SN < TX_Next_Ack +
  AM_Window_Size }
  then { UE does not transmit these AMD PDUs }
}

```

(2)

```

with { UE in RRC_CONNECTED state with AM RLC 12 bit SN and pending uplink data for transmission }
ensure that {
  when { receiving a STATUS PDU where ACK_SN acknowledges at least one AMD PDU not yet acknowledged }
  then { UE transmits AMD PDUs within updated window range }
}

```

(3)

```

with { UE in RRC_CONNECTED state with AM RLC 12 bit SN }
ensure that {
  when { the UE receives AMD PDUs with SN outside the upper boundary of the receive window }
  then { the UE discards these AMD PDUs }
}

```

(4)

```

with { UE in RRC_CONNECTED state with AM RLC 12 bit SN }
ensure that {
  when { the receive window has been moved }
  then { UE continues accepting AMD PDUs within updated window range }
}

```

7.1.2.3.5.2 Conformance requirements

References: The conformance requirements covered in the present TC are specified in: TS 38.322, clauses 5.2.3.2.1, 5.2.3.2.2, 5.2.3.2.3 and 7.2. Unless otherwise stated these are Rel-15 requirements.

[TS 38.322, clause 5.2.3.2.2]

When an AMD PDU is received from lower layer, where the AMD PDU contains byte segment numbers y to z of an RLC SDU with SN = x , the receiving side of an AM RLC entity shall:

- if x falls outside of the receiving window; or
- if byte segment numbers y to z of the RLC SDU with SN = x have been received before:
 - discard the received AMD PDU.
- else:
 - place the received AMD PDU in the reception buffer;
 - if some byte segments of the RLC SDU contained in the AMD PDU have been received before:
 - discard the duplicate byte segments.

[TS 38.322, clause 5.2.3.2.3]

When an AMD PDU with SN = x is placed in the reception buffer, the receiving side of an AM RLC entity shall:

- if $x \geq \text{RX_Next_Highest}$
 - update RX_Next_Highest to $x + 1$.
- if all bytes of the RLC SDU with SN = x are received:
 - reassemble the RLC SDU from AMD PDU(s) with SN = x , remove RLC headers when doing so and deliver the reassembled RLC SDU to upper layer;
 - if $x = \text{RX_Highest_Status}$,
 - update RX_Highest_Status to the SN of the first RLC SDU with SN > current RX_Highest_Status for which not all bytes have been received.
 - if $x = \text{RX_Next}$:

- update RX_Next to the SN of the first RLC SDU with SN > current RX_Next for which not all bytes have been received.
- if *t-Reassembly* is running:
 - if RX_Next_Status_Trigger = RX_Next; or
 - if RX_Next_Status_Trigger = RX_Next + 1 and there is no missing byte segment of the SDU associated with SN = RX_Next before the last byte of all received segments of this SDU; or
 - if RX_Next_Status_Trigger falls outside of the receiving window and RX_Next_Status_Trigger is not equal to RX_Next + AM_Window_Size:
 - stop and reset *t-Reassembly*.
- if *t-Reassembly* is not running (includes the case *t-Reassembly* is stopped due to actions above):
 - if RX_Next_Highest > RX_Next + 1; or
 - if RX_Next_Highest = RX_Next + 1 and there is at least one missing byte segment of the SDU associated with SN = RX_Next before the last byte of all received segments of this SDU:
 - start *t-Reassembly*;
 - set RX_Next_Status_Trigger to RX_Next_Highest.

[TS 38.322, clause 7.2]

a) AM_Window_Size

This constant is used by both the transmitting side and the receiving side of each AM RLC entity. AM_Window_Size = 2048 when a 12 bit SN is used, AM_Window_Size = 131072 when an 18 bit SN is used.

7.1.2.3.5.3 Test description

7.1.2.3.5.3.1 Pre-test conditions

Same Pre-test conditions as in clause 7.1.2.1.1 with the exception that the AM DRB is configured according to Table 7.1.2.3.5.3.1-1.

Table 7.1.2.3.5.3.1-1: RLC parameters

t-PollRetransmit	ms300
pollPDU	infinity
pollByte	infinity
sn-FieldLength(UL-AM-RLC)	size12
sn-FieldLength(DL-AM-RLC)	size12

7.1.2.3.5.3.2 Test procedure sequence

Table 7.1.2.3.5.3.2-1: Main behaviour

St	Procedure	Message Sequence		TP	Verdict
		U - S	Message		
0	The SS does not allocate any uplink grant.	-	-	-	-
-	EXCEPTION: The SS is configured for step 1 500 ms in advance. The transmissions are performed every second radio frame. Step 2 is started 100 ms after the first DL AMD PDU has been transmitted in step 1.	-	-	-	-
-	EXCEPTION: Step 1 shall be repeated from $j=0$ to $j=\text{FLOOR}(\text{Maximum_RLC_SN}/\text{iteration size})$. (Note 1) (Note 3) (Note 4) (Note 6)	-	-	-	-
1	The SS transmits several RLC PDUs in a RLC PDU List, the number of RLC PDUs sent is defined by the iteration_size. Each RLC Data PDU contains one RLC SDU. (Note 8) (Note 9)	<--	RLC Data PDU (SN = $j*\text{iteration_size}$, SN= $((j+1)*\text{iteration_size})-1$)	-	-
1A	The SS transmits one RLC PDU in the slot following the transmissions of step 1. (Note 5)	<--	AMD PDU(SN=W)	-	-
2	In the following steps the SS transmits 1 UL grant in every second radio frame to enable the UE to return each received AMD PDU in one looped back AMD PDU. (Note 2)	<--	(UL grants)	-	-
-	EXCEPTION: Step 2A shall be repeated from $j=0$ to $j=\text{FLOOR}(\text{Maximum_RLC_SN}/\text{iteration size})$. (Note 1) (Note 3) (Note 4) (Note 6)	-	-	-	-
-	EXCEPTION: In Step 2A, SS shall receive a RLC PDU and step 2A is repeated from SN= $j*\text{iteration_size}$ to SN= $((j+1)*\text{iteration_size})-1$. (Note 1) (Note 3) (Note 4) (Note 6) (Note 8) (Note 9)	-	-	-	-
2A	Check: Does UE transmit a RLC Data PDU with the Poll bit not set and with SN=0 for the first RLC Data PDU and then incremented by 1 at each RLC Data PDU? (Note 7)(Note 10)	-->	RLC Data PDU (SN = $j*\text{iteration_size}$, SN= $((j+1)*\text{iteration_size})-1$)	1	P
3	Check: Does the UE transmit the (W)st AMD PDU with the Poll bit set and with the contents of the SDU?	-->	AMD PDU(SN=W-1), Poll	1	P
4	The SS starts the UL default grant transmission.	-	-	-	-
5	Check: Does the UE transmit an AMD PDU within $t\text{-PollRetransmit}2$?	-->	AMD PDU	1	F
6	The SS transmits a STATUS PDU to acknowledge the W uplink AMD PDUs with SN=0 to SN=W-1. ACK_SN = W.	<--	STATUS PDU	-	-
7	Check: Does the UE transmit an AMD PDU with the Poll bit set and with the contents of the SDU?	-->	AMD PDU(SN=W), Poll	2	P
8	The SS transmits a STATUS PDU with ACK_SN = W+1.	<--	STATUS PDU	-	-
9	The SS transmits the (W+2)nd AMD PDU containing a SDU to the UE with the Sequence Number field set to $((2W+1 \text{ mod } \text{AM_Modulus}) = 1)$ and the Polling bit set. (Note 3) (Note 5)	<--	AMD PDU	-	-
10	Check: Does the UE transmit a STATUS PDU acknowledging W+1 SDUs? (ACK_SN = W+1). (Note 1)	-->	STATUS PDU	3	P
11	The SS transmits the (W+2)nd AMD PDU to the UE with the Sequence Number field set to W+1 and the Polling bit set. (Note 5)	<--	AMD PDU	-	-
-	EXCEPTION: Steps 12 and 13 can happen in any order	-	-	-	-
12	Check: Does the UE transmit a STATUS PDU	-->	STATUS PDU	4	P

	acknowledging W+1 PDUs? (ACK_SN field = W+2).				
13	Check: Does the UE transmit an AMD PDU with the same data as received in the corresponding DL AMD PDU in step 11?	-->	AMD PDU	4	P
14	The SS transmits a STATUS PDU with ACK_SN = W+2.	<--	STATUS PDU	-	-
<p>Note 1: PDUs are numbered 1,2, ..., W+2.</p> <p>Note 2: 20 ms gap between transmissions both in DL and UL respectively allows TTCN to tolerate one HARQ retransmission (FDD/TDD) per transport block.</p> <p>Note 3: AM_Modulus is 4096 resp 262144 for SN size is size12 or size18.</p> <p>Note 4: The RLC SDU size shall be 4 octets(3 octets of PDCP header + 1 octet PDCP SDU). If SN size is size18 is used the RLC SDU size shall be 7 octets. With 2 octets of BSR or padding, 2 octets of MAC header and 3 octets of RLC header (without SO) the RLC PDU consists of 56 bits and a TBS of 112 bits shall be allocated</p> <p>Note 5: PDCP SN=W+1</p> <p>Note 6: Maximum_RLC_SN = W-1.</p> <p>Note 7: The verdict shall be provided each time (SN+1) mod 256 = 0 resp. (SN+1) mod 4096 = 0, if SN size is size12 or size18.</p> <p>Note 8: Iteration will be 2¹¹ in case of len12bits. Small RLC SDU size will be used and no repetition will be needed.</p> <p>Note 9: Iteration will be incremented by iteration_size of 2¹¹ for SN len18bits. Small RLC SDU size will be used and it shall be repeated FLOOR(Maximum_RLC_SN/iteration_size).</p> <p>Note 10: -2 for the last iteration, as the last reception will be handled by step 3.</p>					

7.1.2.3.5.3.3 Specific message contents

None

7.1.2.3.5a AM RLC / 18-bit SN / Control of transmit window/Control of receive window

7.1.2.3.5a.1 Test Purpose (TP)

(1)

```
with { UE in RRC_CONNECTED state with AM RLC 18 bit SN and pending uplink data for transmission }
ensure that {
  when { AMD PDUs in transmission buffer fall outside TX_Next_Ack <= SN < TX_Next_Ack +
AM_Window_Size }
  then { UE does not transmit these AMD PDUs }
}
```

(2)

```
with { UE in RRC_CONNECTED state with AM RLC 18 bit SN and pending uplink data for transmission }
ensure that {
  when { receiving a STATUS PDU where ACK_SN acknowledges at least one AMD PDU not yet acknowledged }
  then { UE transmits AMD PDUs within updated window range }
}
```

(3)

```
with { UE in RRC_CONNECTED state with AM RLC 18 bit SN }
ensure that {
  when { the UE receives AMD PDUs with SN outside the upper boundary of the receive window }
  then { the UE discards these AMD PDUs }
}
```

(4)

```
with { UE in RRC_CONNECTED state with AM RLC 18 bit SN }
ensure that {
  when { the receive window has been moved }
  then { UE continues accepting AMD PDUs within updated window range }
}
```

7.1.2.3.5a.2 Conformance requirements

Same as conformance requirements in clause 7.1.2.3.5.2.

7.1.2.3.5a.3 Test description

7.1.2.3.5a.3.1 Pre-test conditions

Same Pre-test conditions as in clause 7.1.2.1.1 with the exception that the AM DRB is configured according to Table 7.1.2.3.5a.3.1-1.

Table 7.1.2.3.5a.3.1-1: RLC parameters

t-PollRetransmit	ms300
pollPDU	infinity
pollByte	infinity
sn-FieldLength(UL-AM-RLC)	size18
sn-FieldLength(DL-AM-RLC)	size18

7.1.2.3.5a.3.2 Test procedure sequence

Same as test procedure in clause 7.1.2.3.5.3.2

7.1.2.3.5a.3.3 Specific message contents

None.

7.1.2.3.6 AM RLC / Polling for status

7.1.2.3.6.1 Test Purpose (TP)

(1)

```
with { UE in RRC_CONNECTED state and using AM RLC }
ensure that {
  when { last data in the UL buffer is being transmitted }
  then { UE transmits a Poll }
}
```

(2)

```
with { UE in RRC_CONNECTED state and using AM RLC }
ensure that {
  when { the t-PollRetransmit timer expires }
  then { UE transmits a Poll }
}
```

(3)

```
with { UE in RRC_CONNECTED state and using AM RLC }
ensure that {
  when { PDU_WITHOUT_POLL >= pollPDU }
  then { UE transmits a Poll }
}
```

(4)

```
with { UE in RRC_CONNECTED state and using AM RLC }
ensure that {
  when { BYTE_WITHOUT_POLL >= pollByte }
  then { UE transmits a Poll }
}
```

7.1.2.3.6.2 Conformance requirements

References: The conformance requirements covered in the present TC are specified in: TS 38.322, clauses 5.3.3.2, 7.3 and 7.4. Unless otherwise stated these are Rel-15 requirements.

[TS 38.322, clause 5.3.3.2]

Upon notification of a transmission opportunity by lower layer, for each AMD PDU submitted for transmission such that the AMD PDU contains either a not previously transmitted RLC SDU or an RLC SDU segment containing not previously transmitted byte segment, the transmitting side of an AM RLC entity shall:

- increment PDU_WITHOUT_POLL by one;
- increment BYTE_WITHOUT_POLL by every new byte of Data field element that it maps to the Data field of the AMD PDU;
- if PDU_WITHOUT_POLL >= pollPDU; or
- if BYTE_WITHOUT_POLL >= pollByte:
 - include a poll in the AMD PDU as described below.

Upon notification of a transmission opportunity by lower layer, for each AMD PDU submitted for transmission, the transmitting side of an AM RLC entity shall:

- if both the transmission buffer and the retransmission buffer becomes empty (excluding transmitted RLC SDUs or RLC SDU segments awaiting acknowledgements) after the transmission of the AMD PDU; or
- if no new RLC SDU can be transmitted after the transmission of the AMD PDU (e.g. due to window stalling);
- include a poll in the AMD PDU as described below.

NOTE: Empty RLC buffer (excluding transmitted RLC SDUs or RLC SDU segments awaiting acknowledgements) should not lead to unnecessary polling when data awaits in the upper layer. Details are left up to UE implementation.

To include a poll in an AMD PDU, the transmitting side of an AM RLC entity shall:

- set the P field of the AMD PDU to "1";
- set PDU_WITHOUT_POLL to 0;
- set BYTE_WITHOUT_POLL to 0.

After submitting an AMD PDU including a poll to lower layer and after incrementing of TX_Next if necessary, the transmitting side of an AM RLC entity shall:

- set POLL_SN to TX_Next – 1;
- if *t-PollRetransmit* is not running:
 - start *t-PollRetransmit*.
- else:
 - restart *t-PollRetransmit*.

[TS 38.322, clause 5.3.3.4]

Upon expiry of *t-PollRetransmit*, the transmitting side of an AM RLC entity shall:

- if both the transmission buffer and the retransmission buffer are empty (excluding transmitted RLC SDU or RLC SDU segment awaiting acknowledgements); or
- if no new RLC SDU or RLC SDU segment can be transmitted (e.g. due to window stalling):
 - consider the RLC SDU with SN = TX_Next – 1 for retransmission; or

- consider any RLC SDU which has not been positively acknowledged for retransmission.
- include a poll in an AMD PDU as described in section 5.3.3.2.

[TS 38.322, clause 7.3]

a) t-PollRetransmit

This timer is used by the transmitting side of an AM RLC entity in order to retransmit a poll (see sub clause 5.3.3).

[TS 38.322, clause 7.4]

b) pollPDU

This parameter is used by the transmitting side of each AM RLC entity to trigger a poll for every pollPDU PDUs (see subclause 5.3.3).

c) pollByte

This parameter is used by the transmitting side of each AM RLC entity to trigger a poll for every pollByte bytes (see subclause 5.3.3).

7.1.2.3.6.3 Test description

7.1.2.3.6.3.1 Pre-test conditions

Same Pre-test conditions as in clause 7.1.2.1.1 with the exception that the AM DRB is configured according to Table 7.1.2.3.6.3.1-1.

Table 7.1.2.3.6.3.1-1: RLC parameters

t-PollRetransmit	ms400
pollPDU	p256
pollByte	kB25

7.1.2.3.6.3.2 Test procedure sequence

Table 7.1.2.3.6.3.2-1: Main behaviour

St	Procedure	Message Sequence		TP	Verdict
		U - S	Message		
1	During the whole test sequence, the SS should not allocate UL grants unless when explicitly stated so in the procedure.	-	-	-	-
2	The SS transmits 4 AMD PDUs such that 1 AMD PDU is sent every two radio frame, each containing an RLC SDU of 976 bits. (Note 2)	<--	AMD PDU (SN=0) AMD PDU (SN=1) AMD PDU (SN=2) AMD PDU (SN=3)	-	-
-	EXCEPTION: In parallel to the events described in step 3, the step specified in Table 7.1.2.3.6.3.2-2 should take place.	-	-	-	-
3	The SS waits for 100 ms after the first DL AMD PDU has been transmitted in step 2, then starts assigning UL grants in every second radio frame of size 1032 bits. (Note 1) (Note 2)	-	-	-	-
4	Check 1: Does the UE transmit an AMD PDU with a SN in range 0 to 3 and P=1? Record time T_B . Check 2: Is $(T_B - T_A) = t\text{-PollRetransmit}$?	-->	AMD PDU	2	P
5	The SS starts the UL default grant transmission on reception of SR.	-	-	-	-
6	The SS transmits an RLC Status Report ACKing reception of PDU's 0-3.	<--	STATUS PDU	-	-
7	Check: Does the UE retransmit an AMD PDU within 1 sec?	-->	AMD PDU	2	F
8	The SS transmits NR RRCReconfiguration message changing <i>pollPDU</i> to p4. (Note 3)	<--	RRCReconfiguration	-	-
8A	The UE transmits a NR <i>RRCReconfigurationcomplete</i> message. (Note 4)	-->	RRCReconfigurationComplete	-	-
9	The SS stops allocating any UL grant.	-	-	-	-
10	The SS transmits 8 AMD PDUs such that 1 AMD PDU is sent every second radio frame, each containing an RLC SDU of 976 bits. (Note 2)	<--	AMD PDU (SN=4) AMD PDU (SN=5) ... AMD PDU (SN=11)	-	-
-	EXCEPTION: In parallel to the events described in step 11, the step specified in Table 7.1.2.3.6.3.2-3 should take place.	-	-	-	-
11	The SS waits for 100 ms after the first DL AMD PDU has been transmitted in step 10, then starts assigning UL grants (UL grant allocation type 2) in every second radio frame of size 1032 bits. (Note 1) (Note 2)	-	-	-	-
12	The SS transmits a Status Report with ACK_SN=12, NACK_SN=4, NACK_SN=5, NACK_SN=6 (constructed by NACK_SN Range), NACK_SN=8 and NACK_SN=9 (constructed by NACK_SN Range).	<--	STATUS PDU	-	-
12 A	Void.	-	-	-	-
13	Check: Does the UE transmit AMD PDUs with the following SN and P values? AMD PDU, SN=4, P=0 AMD PDU, SN=5, P=0 AMD PDU, SN=6, P=0 AMD PDU, SN=8, P=0 AMD PDU, SN=9, P=1	-->	AMD PDU (SN=4, P=0) AMD PDU (SN=5, P=0) AMD PDU (SN=6, P=0) AMD PDU (SN=8, P=0) AMD PDU (SN=9, P=1)	2	P
14	The SS starts the UL default grant transmission on reception of SR.	-	-	-	-
15	The SS transmits a Status Report with ACK_SN=12 and no NACK_SN.	<--	STATUS PDU	-	-

16	The SS transmits NR RRCReconfiguration message changing <i>pollPDU</i> to p256. (Note 3)	<-	RRCReconfiguration	-	-
16 A	The UE transmits a NR <i>RRCReconfigurationComplete</i> message. (Note 4)	-->	RRCReconfigurationComplete	-	-
17	The SS does not allocate any UL grant.	-	-	-	-
18	After 500 ms the SS transmits 412 AMD PDUs such that 1 AMD PDU is sent every second radio frame, each containing an RLC SDU of size 976 bits. (Note 2)	<-	AMD PDU (SN=12) AMD PDU (SN=13) ... AMD PDU (SN=423)	-	-
-	EXCEPTION: In parallel to the events described in step 19, the steps specified in Table 7.1.2.3.6.3.2-4 should take place.	-	-	-	-
19	The SS waits for 100 ms after the first DL AMD PDU has been transmitted in step 10, then starts assigning UL grants (UL grant allocation type 2) in every second radio frame of size 1032 bits. (Note 1) (Note 2)	-	-	-	-
20	The SS starts the UL default grant transmission	-	-	-	-
<p>Note 1: UL grant of 1032 bits (L_{RBs} & l_{MCS} as per 38.523-3[3] annex B) is chosen to allow the UE to loop back one SDU of size 976 bits and one short BSR (16 bits) into each MAC PDU sent in the uplink (1032 bits - 24 bit AMD PDU header - 16 bit MAC BSR CE- 16 bit MAC PDU subheader). The UE will include an SDU of size 976 bits and one short BSR in the looped back MAC PDU.</p> <p>Note 2: 20ms gap between transmissions both in DL and UL respectively allows TTCN to tolerate one HARQ retransmission (FDD/TDD) per transport block, if such happen (TS 38.523-3 [3]).</p> <p>Note 3: For EN-DC the NR RRCReconfiguration message is contained in RRCConnectionReconfiguration 36.508 [7] Table 4.6.1-8 using condition EN-DC_EmbedNR_RRCRecon.</p> <p>Note 4: For EN-DC the NR RRCReconfigurationComplete message is contained in RRCConnectionReconfigurationComplete.</p>					

Table 7.1.2.3.6.3.2-2: Parallel behaviour

St	Procedure	Message Sequence		TP	Verdict
		U - S	Message		
1	Check: Does the UE transmit 4 AMD PDUs, with only the last one having the poll bit set? Record time T_A when the PDU with the poll bit set is received at the SS.	-->	AMD PDUs	1	P

Table 7.1.2.3.6.3.2-3: Parallel behaviour

St	Procedure	Message Sequence		TP	Verdict
		U - S	Message		
1	Check: Does the UE transmit 8 AMD PDUs, with the poll bit set only in the 4 th and the 8 th PDUs?	-->	AMD PDUs	3	P

Table 7.1.2.3.6.3.2-4: Parallel behaviour

St	Procedure	Message Sequence		TP	Verdict
		U - S	Message		
1	Check: Does the UE transmit 205 AMD PDUs, with the poll bit set only in the last (205 th) one? (Note 1)	-->	AMD PDUs	4	P
2	The SS transmits an RLC Status Report.	<--	STATUS PDU	-	-
3	Check: Does the UE transmit 205 AMD PDUs, with the poll bit set only in the last (410 th) one? (Note 1)	-->	AMD PDUs	4	P
4	The SS transmits an RLC Status Report.	<--	STATUS PDU	-	-
5	Check: Does the UE transmit 2 AMD PDUs, with the poll bit set only in the last (412 th) one?	-->	AMD PDUs	1	P
6	The SS transmits an RLC Status Report.	<--	STATUS PDU	-	-

Note 1: (976 bits x 205PDUs) / 8 = 25010 > 25 KB, with 1 kB = 1000 bytes (TS 38.331 [12], clause 3.2)

7.1.2.3.6.3.3 Specific message contents

Table 7.1.2.3.6.3.3-1: RRCReconfiguration (steps 8 and 16, Table 7.1.2.3.6.3.2-1)

Derivation Path: 38.508-1 [4], Table 4.6.1-13			
Information Element	Value/remark	Comment	Condition
RRCReconfiguration ::= SEQUENCE {			
criticalExtensions CHOICE {			
rrcReconfiguration ::= SEQUENCE {			
secondaryCellGroup	CellGroupConfig		EN-DC
nonCriticalExtension SEQUENCE {			NR
masterCellGroup	CellGroupConfig		
}			
}			
}			
}			

Table 7.1.2.3.6.3.3-2: CellGroupConfig (Table 7.1.2.3.6.3.3-1)

Derivation Path: 38.508-1 [4], Table 4.6.3-19			
Information Element	Value/remark	Comment	Condition
CellGroupConfig ::= SEQUENCE {			
rlc-BearerToAddModList SEQUENCE (SIZE(1..maxLCH)) OF RLC-BearerConfig {	1 entry		
RLC-BearerConfig[1]	RLC-BearerConfig	entry 1	
}			
mac-CellGroupConfig	Not present		
physicalCellGroupConfig	Not present		
spCellConfig	Not present		
}			

Table 7.1.2.3.6.3.3-3: RLC-BearerConfig (Table 7.1.2.3.6.3.3-2)

Derivation Path: 38.508-1 [4], Table 4.6.3-148 with condition AM			
Information Element	Value/remark	Comment	Condition
RLC-BearerConfig ::= SEQUENCE {			
logicalChannelIdentity	Set to LCID of the DRB under test		
rlc-Config	RLC-Config		
}			

Table 7.1.2.3.6.3.3-4: RLC-Config (Table 7.1.2.3.6.3.3-3)

Derivation Path: 38.508-1 [4], Table 4.6.3-149 with condition AM			
Information Element	Value/remark	Comment	Condition
RLC-Config ::= CHOICE {			
am SEQUENCE {			
ul-AM-RLC SEQUENCE {			
sn-FieldLength	Not present		
t-PollRetransmit	ms400		
pollPDU	p4		step 8
	p256		step 16
pollByte	kB25		
}			
dl-AM-RLC SEQUENCE {			
sn-FieldLength	Not present		
}			

7.1.2.3.7 AM RLC / Receiver status triggers

7.1.2.3.7.1 Test Purpose (TP)

(1)

```
with { UE in RRC_CONNECTED state and using AM RLC }
ensure that {
  when { Reception failure of an RLC data PDU is detected and t-Reassembly expires }
  then { UE initiates Status Reporting }
}
```

(2)

```
with { UE in RRC_CONNECTED state and using AM RLC }
ensure that {
  when { Status Reporting is triggered and t-StatusProhibit is running }
  then { UE wait until t-StatusProhibit has expired to send Status Report }
}
```

(3)

```
with { UE in RRC_CONNECTED state and using AM RLC }
ensure that {
  when { Polling from peer AM RLC entity is detected and the sequence number 'x' of the PDU that
  carries the Poll satisfies x < RX_Highest_Status or x >= RX_Next + AM_Window_Size }
  then { UE initiates Status Reporting }
}
```

(4)

```
with { UE in RRC_CONNECTED state and using AM RLC }
ensure that {
  when { Polling from peer AM RLC entity is detected and the sequence number 'x' of the PDU that
  carries the Poll does not satisfies x < RX_Highest_Status or x >= RX_Next + AM_Window_Size }
  then { UE waits until 'x < RX_Highest_Status or x >= RX_Next + AM_Window_Size' before initiating
  Status Reporting }
}
```

(5)

```
with { UE in RRC_CONNECTED state and using AM RLC }
ensure that {
  when { the UE needs to send a Status Report and the UL grant is not large enough to accommodate
  the whole report }
  then { UE includes as many NACK_SNs in the Status Report as allowed by the UL grant }
}
```

(6)

```

with { UE in RRC_CONNECTED state and using AM RLC }
ensure that {
  when { the UE needs to send a Status Report and continuous sequence of RLC SDUs that have not been
received yet }
  then { UE includes NACK_SN with NACK range }
}

```

7.1.2.3.7.2 Conformance requirements

References: The conformance requirements covered in the present TC are specified in: TS 38.322, clause 5.3.4. Unless otherwise stated these are Rel-15 requirements.

[TS 38.322, clause 5.3.4]

An AM RLC entity sends STATUS PDUs to its peer AM RLC entity in order to provide positive and/or negative acknowledgements of RLC SDUs (or portions of them).

Triggers to initiate STATUS reporting include:

- Polling from its peer AM RLC entity:
 - When an AMD PDU with SN = x and the P field set to "1" is received from lower layer, the receiving side of an AM RLC entity shall:
 - if the AMD PDU is to be discarded as specified in subclause 5.2.3.2.2; or
 - if $x < \text{RX_Highest_Status}$ or $x \geq \text{RX_Next} + \text{AM_Window_Size}$:
 - trigger a STATUS report.
 - else:
 - delay triggering the STATUS report until $x < \text{RX_Highest_Status}$ or $x \geq \text{RX_Next} + \text{AM_Window_Size}$.

NOTE 1: This ensures that the RLC Status report is transmitted after HARQ reordering.

- Detection of reception failure of an AMD PDU
 - The receiving side of an AM RLC entity shall trigger a STATUS report when *t-Reassembly* expires.

NOTE 2: The expiry of *t-Reassembly* triggers both RX_Highest_Status to be updated and a STATUS report to be triggered, but the STATUS report shall be triggered after RX_Highest_Status is updated.

When STATUS reporting has been triggered, the receiving side of an AM RLC entity shall:

- if *t-StatusProhibit* is not running:
 - at the first transmission opportunity indicated by lower layer, construct a STATUS PDU and submit it to lower layer.
- else:
 - at the first transmission opportunity indicated by lower layer after *t-StatusProhibit* expires, construct a single STATUS PDU even if status reporting was triggered several times while *t-StatusProhibit* was running and submit it to lower layer.

When a STATUS PDU has been submitted to lower layer, the receiving side of an AM RLC entity shall:

- start *t-StatusProhibit*.

When constructing a STATUS PDU, the AM RLC entity shall:

- for the RLC SDUs with SN such that $\text{RX_Next} \leq \text{SN} < \text{RX_Highest_Status}$ that has not been completely received yet, in increasing SN order of RLC SDUs and increasing byte segment order within RLC SDUs,

starting with SN = RX_Next up to the point where the resulting STATUS PDU still fits to the total size of RLC PDU(s) indicated by lower layer:

- for an RLC SDU for which no byte segments have been received yet:
 - include in the STATUS PDU a NACK_SN which is set to the SN of the RLC SDU.
- for a continuous sequence of byte segments of a partly received RLC SDU that have not been received yet:
 - include in the STATUS PDU a set of NACK_SN, SOstart and SOend.
- for a continuous sequence of RLC SDUs that have not been received yet:
 - include in the STATUS PDU a set of NACK_SN and NACK range;
 - include in the STATUS PDU, if required, a pair of SOstart and SOend.
- set the ACK_SN to the SN of the next not received RLC SDU which is not indicated as missing in the resulting STATUS PDU.

7.1.2.3.7.3 Test description

7.1.2.3.7.3.1 Pre-test conditions

Same Pre-test conditions as in clause 7.1.2.1.1 with the exception that the AM DRB is configured according to Table 7.1.2.3.7.3.1-1.

Table 7.1.2.3.7.3.1-1: RLC parameters

<i>t-Reassembly</i>	ms150
<i>t-StatusProhibit</i>	ms300
<i>t-PollRetransmit</i>	ms500

7.1.2.3.7.3.2 Test procedure sequence

Table 7.1.2.3.7.3.2-1: Main behaviour

St	Procedure	Message Sequence		TP	Verdict
		U - S	Message		
-	The SS ignores scheduling requests and does not allocate any uplink grant.	-	-	-	-
1	The SS transmits 4 AMD PDUs with SN=0, 1, 2, and 4. The SS sets the P field of all the AMD PDUs to 0. A time spacing of 20 ms is applied. Record time T_A when the AMD PDU with SN=4 is sent.	<--	AMD PDU (SN=0, P=0) AMD PDU (SN=1, P=0) AMD PDU (SN=2, P=0) AMD PDU (SN=4, P=0)	-	-
2	The SS waits for 70 ms after the transmission of the first AMD PDU to ensure UE RLC has all the required SDUs available and then assigns 3 UL grants (UL grant allocation type 2) with a time spacing of 20 ms of size 848 bits (UL Grant Allocation type 2). (Note 1)	<--	(UL grants, 848 bits)	-	-
3	The UE transmits RLC SDU#1.	-->	(RLC SDU#1)	-	-
4	The UE transmits RLC SDU#2.	-->	(RLC SDU#2)	-	-
5	The UE transmits RLC SDU#3.	-->	(RLC SDU#3)	-	-
6	60 ms after step 5, the SS transmits a STATUS PDU	<--	STATUS PDU	-	-
7	80 ms after step 5, the SS starts the UL default grant transmission.	-	-	-	-
8	Check 1: Does the UE transmit a Status Report with NACK_SN=3 and ACK_SN=5? Record time T_B (Note 5) Check 2: $(T_B - T_A) = t\text{-Reassembly?}$	-->	STATUS PDU	1	P
9	100 ms after the Status Report is received at Step 8, the SS transmits 4 AMD PDUs with SN=5, 6, 8 and 9. The SS sets the P field of all the AMD PDUs to 0. A time spacing of 20 ms is applied.	<--	AMD PDU (SN=5, P=0) AMD PDU (SN=6, P=0) AMD PDU (SN=8, P=0) AMD PDU (SN=9, P=0)	-	-
10	Check 1: Does the UE transmit a Status Report with NACK_SN=3 and ACK_SN=7? Record time T_C Check 2: $(T_C - T_B) = t\text{-StatusProhibit?}$	-->	STATUS PDU	2	P
11	The SS ignores scheduling requests unless otherwise specified and does not allocate any uplink grant.	-	-	-	-
12	After 200 ms the SS transmits 2 AMD PDUs with SN=3, SN=7. The SS sets the P field of all the AMD PDUs to 0 except for that of the AMD PDU with SN=7. A time spacing of 20 ms is applied.	<--	AMD PDU (SN=3, P=0) AMD PDU (SN=7, P=1)	-	-
13	The SS waits for 100 ms after the transmission of the last AMD PDU to ensure UE RLC has all the required SDUs available and then assigns 1 UL grant (UL grant allocation type 3) of size 88 bits. (Note 2)	<--	(UL grant, 88 bits)	-	-
14	Check: Does the UE transmit a Status Report with no NACK_SN and ACK_SN = 10?	-->	STATUS PDU	3	P
15	In the second frame following the one scheduled in step 13 the SS assigns 7 UL grants (UL grant allocation type 2) with a time spacing of 20 ms of size 848 bits. (Note 1)	<--	(UL grant, 848 bits)	-	-
16	The UE transmits RLC SDU#4.	-->	(RLC SDU#4)	-	-
17	The UE transmits RLC SDU#5.	-->	(RLC SDU#5)	-	-
18	The UE transmits RLC SDU#6.	-->	(RLC SDU#6)	-	-
19	The UE transmits RLC SDU#7.	-->	(RLC SDU#7)	-	-
20	The UE transmits RLC SDU#8.	-->	(RLC SDU#8)	-	-
21	The UE transmits RLC SDU#9.	-->	(RLC SDU#9)	-	-
22	The UE transmits RLC SDU#10.	-->	(RLC SDU#10)	-	-
23	The SS transmits a STATUS PDU	<--	STATUS PDU	-	-

24	After 300 ms the SS transmits an AMD PDU with SN=11 and P=0, and an AMD PDU with SN=12 and P=1. A time spacing of 20 ms is applied.	<--	AMD PDU (SN=11, P=0) AMD PDU (SN=12, P=1)	-	-
25	Check: Does the UE transmit a scheduling request within t -Reassembly/ 2 ms after the transmission of the first AMD PDU of Step 24?	-->	(SR)	4	F
26	At t -Reassembly/ 2 ms after the transmission of the second AMD PDU of Step 24, the SS transmits an AMD PDU with SN=10 and P=0.	<--	AMD PDU (SN=10, P=0)	-	-
27	The SS waits for 60 ms to ensure UE RLC has all the required SDUs available and then assigns 1 UL grant (UL grant allocation type 3) of size 88 bits. (Note 2)	<--	(UL grant, 88 bits)	-	-
28	Check: Does the UE transmit a Status Report with no NACK_SN and ACK_SN=13?	-->	STATUS PDU	4	P
29	The SS assigns 3 UL grants (UL grant allocation type 2) with a time spacing of 20 ms of size 848 bits. (Note 1)	<--	(UL grant, 848 bits)	-	-
30	The UE transmits RLC SDU#11.	-->	(RLC SDU#11)	-	-
31	The UE transmits RLC SDU#12.	-->	(RLC SDU#12)	-	-
32	The UE transmits RLC SDU#13.	-->	(RLC SDU#13)	-	-
33	The SS transmits a STATUS PDU.	<--	STATUS PDU	-	-
34	After 300 ms the SS transmits an AMD PDU with SN=17 and P=0, and an AMD PDU with SN=19 and P=1. A time spacing of 20 ms is applied.	<--	AMD PDU (SN=17, P=0) AMD PDU (SN=19, P=1)	-	-
35	The SS waits for t -Reassembly ms to ensure expiry.	-	-	-	-
36	60 ms after step 35 the SS assigns an UL grant (UL grant allocation type 3) of size 88 bits. (Note 3)	<--	(UL Grant, 88 bits)	-	-
37	Check: Does the UE transmit a Status Report with ACK_SN=18 and NACK_SN: 13 including NACK Range 4 (SN 13, 14, 15, 16)?	-->	STATUS PDU	5,6	P
38	After 300 ms the SS transmits an AMD PDU with SN=16 and P=1.	<--	AMD PDU (SN=16, P=1)	-	-
39	30 ms after step 38 the SS assigns an UL grant (UL grant allocation type 3) of size 112 bits. (Note 4)	<--	(UL Grant, size 112)	-	-
40	Check: Does the UE transmit a Status Report with ACK_SN=20 and NACK_SN: 13 including NACK Range 3 (SN 13, 14, 15) and NACK_SN=18 without NACK Range?	-->	STATUS PDU	5,6	P
41	60 ms after step 38 the SS transmits 4 AMD PDUs with SN=13, 14, 15 and 18. A time spacing of 20 ms is applied.	<--	AMD PDU (SN=13, P=0) AMD PDU (SN=14, P=0) AMD PDU (SN=15, P=0) AMD PDU (SN=18, P=0)	-	-
42	130 ms after the transmission of the first AMD PDU the SS assigns 7 UL grant (UL grant allocation type 3 with a time spacing of 20 ms of size 848 bits. (Note 1)	<--	(UL grant, 848 bits)	-	-
43	The UE loopbacks the complete RLC SDU.	-->	(RLC SDU#14)	-	-
44	The UE loopbacks the complete RLC SDU.	-->	(RLC SDU#15)	-	-
45	The UE loopbacks the complete RLC SDU.	-->	(RLC SDU#16)	-	-
46	The UE loopbacks the complete RLC SDU.	-->	(RLC SDU#17)	-	-
47	The UE loopbacks the complete RLC SDU.	-->	(RLC SDU#18)	-	-
48	The UE loopbacks the complete RLC SDU.	-->	(RLC SDU#19)	-	-
49	The UE loopbacks the complete RLC SDU.	-->	(RLC SDU#20)	-	-
50	The SS transmits a STATUS PDU.	<--	STATUS PDU	-	-

Note 1:	UL grant of 848 bits (L_{RBs} & I_{MCS} as per 38.523-3[3] annex B) is chosen to allow the UE to transmit one PDU at a time (99 bytes RLC SDU + 3 bytes RLC Header + 2 bytes MAC Sub PDU header + 2 bytes for short BSR or padding).
Note 2:	UL grant of 88 bits (L_{RBs} & I_{MCS} as per 38.523-3[3] annex B) is chosen to allow the UE to transmit a Status Report with ACK_SN(3 byte) + 2 byte MAC PDU subheader and (2 byte short BSR). 4 Bytes additional space provided to confirm UE does not include NACK_SN and conformant UE instead will include MAC Padding.
Note 3:	UL grant of 88 bits (L_{RBs} & I_{MCS} as per 38.523-3[3] annex B) is chosen to allow the UE to transmit (a Status Report with ACK_SN (3 Bytes)and 1 NACK_SNs with NACK Range(4 Bytes) + MAC PDU subheader (2 Bytes) + Short BSR (2 Byte).
Note 4:	UL grant of 112 bits (L_{RBs} & I_{MCS} as per 38.523-3[3] annex B) is chosen to allow the UE to transmit (a Status Report with ACK_SN (3 Bytes)and 1 NACK_SNs with NACK Range(4 Bytes) +NACK SN (3 Bytes) + MAC PDU subheader (2 Bytes) + Short BSR (2 Byte).
Note 5:	Time T_B should be recorded by factoring in the SR-Periodicity as configured in the <i>SchedulingRequestResourceConfig->periodicityAndOffset</i>

7.1.2.3.7.3.3 Specific message contents

None

7.1.2.3.8 AM RLC / Reconfiguration of RLC parameters by upper layers

7.1.2.3.8.1 Test Purpose (TP)

(1)

```
with { UE in RRC_CONNECTED state and using AM RLC }
ensure that {
  when { t-PollRetransmit value is changed during reconfiguration of RLC parameters by upper layers }
  then { UE starts using new t-PollRetransmit value }
}
```

(2)

```
with { UE in RRC_CONNECTED state and using AM RLC }
ensure that {
  when { t-Reassembly value is changed during reconfiguration of RLC parameters by upper layers }
  then { UE starts using new t-Reassembly value }
}
```

(3)

```
with { UE in RRC_CONNECTED state and using AM RLC }
ensure that {
  when { t-StatusProhibit value is changed during reconfiguration of RLC parameters by upper layers }
  then { UE starts using new t-StatusProhibit value }
}
```

7.1.2.3.8.2 Conformance requirements

References: The conformance requirements covered in the present TC are specified in: TS 38.322, clauses 5.3.3.1, 5.3.3.2, 5.3.3.3, 5.3.4 and 7.3. TS 38.331 clause 5.3.5.5.4. Unless otherwise stated these are Rel-15 requirements.

[TS 38.322, clause 5.3.3.1]

An AM RLC entity can poll its peer AM RLC entity in order to trigger STATUS reporting at the peer AM RLC entity.

[TS 38.322, clause 5.3.3.2]

Upon notification of a transmission opportunity by lower layer, for each AMD PDU submitted for transmission such that the AMD PDU contains either a not previously transmitted RLC SDU or an RLC SDU segment containing not previously transmitted byte segment, the transmitting side of an AM RLC entity shall:

- increment PDU_WITHOUT_POLL by one;

- increment BYTE_WITHOUT_POLL by every new byte of Data field element that it maps to the Data field of the AMD PDU;
- if PDU_WITHOUT_POLL >= pollPDU; or
- if BYTE_WITHOUT_POLL >= pollByte:
 - include a poll in the AMD PDU as described below.

Upon notification of a transmission opportunity by lower layer, for each AMD PDU submitted for transmission, the transmitting side of an AM RLC entity shall:

- if both the transmission buffer and the retransmission buffer becomes empty (excluding transmitted RLC SDUs or RLC SDU segments awaiting acknowledgements) after the transmission of the AMD PDU; or
- if no new RLC SDU can be transmitted after the transmission of the AMD PDU (e.g. due to window stalling);
 - include a poll in the AMD PDU as described below.

NOTE: Empty RLC buffer (excluding transmitted RLC SDUs or RLC SDU segments awaiting acknowledgements) should not lead to unnecessary polling when data awaits in the upper layer. Details are left up to UE implementation.

To include a poll in an AMD PDU, the transmitting side of an AM RLC entity shall:

- set the P field of the AMD PDU to "1";
- set PDU_WITHOUT_POLL to 0;
- set BYTE_WITHOUT_POLL to 0.

After submitting an AMD PDU including a poll to lower layer and after incrementing of TX_Next if necessary, the transmitting side of an AM RLC entity shall:

- set POLL_SN to TX_Next – 1;
- if *t-PollRetransmit* is not running:
 - start *t-PollRetransmit*.
- else:
 - restart *t-PollRetransmit*.

[TS 38.322, clause 5.3.3.3]

Upon reception of a STATUS report from the receiving RLC AM entity the transmitting side of an AM RLC entity shall:

- if the STATUS report comprises a positive or negative acknowledgement for the RLC SDU with sequence number equal to POLL_SN:
 - if *t-PollRetransmit* is running:
 - stop and reset *t-PollRetransmit*.

[TS 38.322, clause 5.3.4]

Upon expiry of *t-PollRetransmit*, the transmitting side of an AM RLC entity shall:

- if both the transmission buffer and the retransmission buffer are empty (excluding transmitted RLC SDU or RLC SDU segment awaiting acknowledgements); or
- if no new RLC SDU or RLC SDU segment can be transmitted (e.g. due to window stalling):
 - consider the RLC SDU with SN = TX_Next – 1 for retransmission; or
 - consider any RLC SDU which has not been positively acknowledged for retransmission.

- include a poll in an AMD PDU as described in section 5.3.3.2.

[TS 38.322, clause 7.3]

The following timers are configured by 3GPP TS 38.331 [5]:

a) *t-PollRetransmit*

This timer is used by the transmitting side of an AM RLC entity in order to retransmit a poll (see sub clause 5.3.3).

b) *t-Reassembly*

This timer is used by the receiving side of an AM RLC entity and receiving UM RLC entity in order to detect loss of RLC PDUs at lower layer (see sub clauses 5.2.2.2 and 5.2.3.2). If *t-Reassembly* is running, *t-Reassembly* shall not be started additionally, i.e. only one *t-Reassembly* per RLC entity is running at a given time.

c) *t-StatusProhibit*

This timer is used by the receiving side of an AM RLC entity in order to prohibit transmission of a STATUS PDU (see sub clause 5.3.4).

[TS 38.331, clause 5.3.5.5.4]

For each RLC-Bearer-Config received in the *rlc-BearerToAddModList* IE the UE shall:

- 1> if the UE's current configuration contains a RLC bearer with the received *logicalChannelIdentity*:
 - 2> if *reestablishRLC* is received:
 - 3> re-establish the RLC entity as specified in TS 38.322 [4];
 - 2> reconfigure the RLC entity or entities in accordance with the received *rlc-Config*;
 - 2> reconfigure the logical channel in accordance with the received *mac-LogicalChannelConfig*;

NOTE: The network does not re-associate an already configured logical channel with another radio bearer. Hence *servedRadioBearer* is not present in this case.

7.1.2.3.8.3 Test description

7.1.2.3.8.3.1 Pre-test conditions

Same Pre-test conditions as in clause 7.1.2.1.1 with the exception that the AM DRB is configured according to Table 7.1.2.3.8.3.1-1.

Table 7.1.2.3.8.3.1-1: RLC parameters

Parameter	Value
<i>t-Reassembly</i>	ms150
<i>t-StatusProhibit</i>	ms300
<i>t-PollRetransmit</i>	ms400
<i>pollPDU</i>	infinity
<i>pollByte</i>	infinity

7.1.2.3.8.3.2 Test procedure sequence

Table 7.1.2.3.8.3.2-1: Main behaviour

St	Procedure	Message Sequence		TP	Verdict
		U - S	Message/PDU/SDU		
1-29	Same expected sequence as in Table 7.1.2.3.8.3.2-2 with (X=0, t-Reassembly = ms150, t-StatusProhibit = ms300, t-PollRetransmit=ms400) Note 1.	-	-	1,2,3	-
30	The SS transmits NR RRCReconfiguration message to reconfigure RLC in the UE and set: - t-Reassembly to ms200, - t-StatusProhibit to ms400, - t-PollRetransmit to ms500. (Note 1)	<--	RRCReconfiguration	-	-
30A	The UE transmits a NR RRCReconfigurationcomplete message. (Note 2)	-->	RRCReconfigurationComplete	-	-
31-59	Same expected sequence as in Table 7.1.2.3.8.3.2-2 with (X=11, t-Reassembly = ms200, t-StatusProhibit = ms400, t-PollRetransmit=ms500).	-	-	1,2,3	-
Note 1: For EN-DC the NR RRCReconfiguration message is contained in RRCConnectionReconfiguration 36.508 [7], Table 4.6.1-8 using condition EN-DC_EmbedNR_RRCRecon. Note 2: For EN-DC the NR RRCReconfigurationComplete message is contained in RRCConnectionReconfigurationComplete.					

Table 7.1.2.3.8.3.2-2: Behaviour Sequence (X, t-Reassembly, t-StatusProhibit, t-PollRetransmit)

St	Procedure	Message Sequence		TP	Verdict
		U - S	Message/PDU/SDU		
1	The SS ignores scheduling requests and does not allocate any uplink grant.	-	-	-	-
2	The SS transmits 4 AMD PDUs with P=0 and SN=X, X+1, X+2 and X+4. The SS record time T_A when AMD PDU#5 (with SN=X+4) is sent. A time spacing of 20 ms is applied.	<--	AMD PDU#1 (SN=X, P=0) AMD PDU#2 (SN=X+1, P=0) AMD PDU#3 (SN=X+2, P=0) AMD PDU#5 (SN=X+4, P=0)	-	-
3	The SS waits for 70 ms after the transmission of the first AMD PDU to ensure UE RLC has all the required SDUs available and then assigns 3 UL grants of size 848 bits with a time spacing of 20 ms. (Note 1)	<--	(UL grants, 848 bits)	-	-
4	The UE transmits RLC SDU#1+X.	-->	(RLC SDU#1+X)	-	-
5	The UE transmits RLC SDU#2+X.	-->	(RLC SDU#2+X)	-	-
6	The UE transmits RLC SDU#3+X.	-->	(RLC SDU#3+X)	-	-
7	60 ms after step 3 the SS transmits a STATUS PDU.	<--	STATUS PDU	-	-
8	The SS starts the UL default grant transmission.	-	-	-	-
9	Check 1: Does the UE transmit a STATUS PDU with NACK_SN=X+3 and ACK_SN=X+5? Record time T_B (Note 5). Check 2: Is $(T_B - T_A) = t\text{-Reassembly}$?	-->	STATUS PDU	2	P
10	100 ms after the Status Report received at Step 9, the SS sends 4 AMD PDUs with P=0 and SN=X+5, X+6, X+8 and X+9. A time spacing of 20 ms is applied.	<--	AMD PDU#6 (SN=X+5, P=0) AMD PDU#7 (SN=X+6, P=0) AMD PDU#9 (SN=X+8, P=0) AMD PDU#10 (SN=X+9, P=0)	-	-
11	Check 1: Does the UE transmit a Status Report with NACK_SN=X+3 and ACK_SN=X+7? Record time T_C Check 2: $(T_C - T_B) = t\text{-StatusProhibit}$?	-->	STATUS PDU	3	P
12	The SS ignores scheduling requests and does not allocate any uplink grant.	-	-	-	-
13	After 250 ms the SS transmits 3 AMD PDUs with SN=X+3, X+7 and X+9. The SS sets the P field of all the AMD PDUs to 0 except for that of the AMD PDU with SN=X+9. A time spacing of 20 ms is applied.	<--	AMD PDU#4 (SN=X+3, P=0) AMD PDU#8 (SN=X+7, P=0) AMD PDU#10 (SN=X+9, P=1)	-	-
14	The SS waits for 150 ms after AMD PDU#4 transmission to ensure UE RLC has all the required SDUs available and then assigns 1 UL grant of size 88 bits (UL Grant Allocation type 3). (Note 2)(Note 4)	<--	(UL grant, 88 bits)	-	-
15	The UE transmits a Status Report with no NACK_SN and ACK_SN=X+10.	-->	STATUS PDU	-	-
16	In the subframe following the one scheduled in step 14 the SS assigns 7 UL grants of size 848 bits (UL Grant Allocation type 2) with a time spacing of 20 ms. (Note 1)	<--	(UL grants, 848 bits)	-	-
17	The UE transmits RLC SDU#4+X.	-->	(RLC SDU#4+X)	-	-
18	The UE transmits RLC SDU#5+X.	-->	(RLC SDU#5+X)	-	-
19	The UE transmits RLC SDU#6+X.	-->	(RLC SDU#6+X)	-	-
20	The UE transmits RLC SDU#7+X.	-->	(RLC SDU#7+X)	-	-
21	The UE transmits RLC SDU#8+X.	-->	(RLC SDU#8+X)	-	-
22	The UE transmits RLC SDU#9+X.	-->	(RLC SDU#9+X)	-	-
23	The UE transmits RLC SDU#10+X.	-->	(RLC SDU#10+X)	-	-
24	The SS transmits a STATUS PDU.	<--	STATUS PDU	-	-
25	The SS transmits an AMD PDU to the UE.	<--	AMD PDU#11 (SN=X+10, P=0)	-	-
26	The SS starts the UL default grant transmission.	-	-	-	-

27	The UE transmits an AMD PDU with the same data as received in the corresponding DL AMD PDU. Record time T_D .	-->	AMD PDU#11 (SN=X+10, P=1)	-	-
28	Check 1: Does the UE set the poll bit as both the transmission and retransmission buffers become empty? Record time T_E . Check 2: Is $(T_E - T_D) = t\text{-PollRetransmit?}$	-->	AMD PDU#11 (SN=X+10, P=1)	1	P
29	The SS transmits a STATUS PDU	<--	STATUS PDU	-	-
<p>Note 1: UL grant of 848 bits (L_{RBs} & I_{MCS} as per 38.523-3[3] annex B) is chosen to allow the UE to transmit one PDU at a time.</p> <p>Note 2: UL grant of 88 bits (L_{RBs} & I_{MCS} as per 38.523-3[3] annex B) is chosen to allow the UE to transmit a Status Report with ACK_SN(3 byte) + 2 byte MAC PDU subheader and (2 byte short BSR). 4 Bytes additional space provided to confirm UE does not include NACK_SN and conformant UE instead will include MAC Padding.</p> <p>Note 3: Every DL AMD PDU contains 1 RLC SDU size of 99 bytes.</p> <p>Note 4: Timing difference between step 11 to step 15 is equal to $t\text{-statusProhibit}$ timer. UE starts SR from step 13 with AMD-PDU#4. 150 ms is chosen so that UE does not reach $sr\text{-transMax}(n16)$ otherwise UE RACHes.</p> <p>Note 5: Time T_B should be recorded by factoring in the SR-Periodicity as configured in the <i>SchedulingRequestResourceConfig->periodicityAndOffset</i>.</p>					

7.1.2.3.8.3.3 Specific message contents

Table 7.1.2.3.8.3.3-1: RRCReconfiguration (step 30, Table 7.1.2.3.8.3.2-1)

Derivation Path: 38.508-1 [4], Table 4.6.1-13			
Information Element	Value/remark	Comment	Condition
RRCReconfiguration ::= SEQUENCE {			
criticalExtensions CHOICE {			
rrcReconfiguration ::= SEQUENCE {			
secondaryCellGroup	CellGroupConfig		EN-DC
nonCriticalExtension SEQUENCE {			NR
masterCellGroup	CellGroupConfig		
}			
}			
}			
}			

Table 7.1.2.3.8.3.3-2: CellGroupConfig (Table 7.1.2.3.8.3.3-1)

Derivation Path: 38.508-1 [4], Table 4.6.3-19			
Information Element	Value/remark	Comment	Condition
CellGroupConfig ::= SEQUENCE {			
rlc-BearerToAddModList SEQUENCE (SIZE(1..maxLCH)) OF RLC-BearerConfig {	1 entry		
RLC-BearerConfig[1]	RLC-BearerConfig	entry 1	
}			
}			

Table 7.1.2.2.8.3.3-3: RLC-BearerConfig (Table 7.1.2.3.8.3.3-2)

Derivation Path: 38.508-1 [4], Table 4.6.3-148 with condition AM			
Information Element	Value/remark	Comment	Condition
RLC-BearerConfig ::= SEQUENCE {			
logicalChannelIdentity	Set to LCID of the DRB under test		
rlc-Config	RLC-Config		
}			

Table 7.1.2.2.8.3.3-4: RLC-Config (Table 7.1.2.3.8.3.3-3)

Derivation Path: 38.508-1 [4], Table 4.6.3-149 with condition AM			
Information Element	Value/remark	Comment	Condition
RLC-Config ::= CHOICE {			
am SEQUENCE {			
ul-AM-RLC SEQUENCE {			
sn-FieldLength	Not present		
t-PollRetransmit	ms500		
}			
dl-AM-RLC SEQUENCE {			
sn-FieldLength	Not present		
t-Reassembly	ms200		
t-StatusProhibit	ms400		
}			
}			
}			

7.1.2.3.9 AM RLC / Reassembling of AMD PDUs

7.1.2.3.9.1 Test Purpose (TP)

(1)

```
with { UE in RRC_CONNECTED state }
ensure that {
  when { UE receives AMD PDUs, and all bytes of the RLC SDU(s) with SN = x are received }
  then { UE reassembles the RLC SDU(s) from AMD PDU(s) with SN = x }
}
```

(2)

```
with { UE in RRC_CONNECTED state }
ensure that {
  when { t-Reassembly expires }
  then { update RX_Highest_Status to the SN of the first RLC SDU with SN >= RX_Next_Status_Trigger
for which not all bytes have been received }
}
```

(3)

```
with { UE in RRC_CONNECTED state }
ensure that {
  when { UE receives AM PDU segments }
  then { UE delivers reassembled RLC SDU to upper layer }
}
```

(4)

```
with { UE in RRC_CONNECTED state }
ensure that {
  when { UE receives duplicate RLC AM PDU segments }
  then { UE discards duplicate RLC AMD PDU segments }
}
```

(5)

```
with { UE in RRC_CONNECTED state }
ensure that {
  when { UE receives RLC AMD PDU segments with segments lost }
  then { UE transmits STATUS PDU to request retransmission of missing segments }
}
```

(6)

```
with { UE in RRC_CONNECTED state }
```

```

ensure that {
  when { UE receives overlapping RLC AMD PDU segments }
  then { UE discards duplicate RLC AMD PDU byte segments }
}

```

(7)

```

with { UE in RRC_CONNECTED state }
ensure that {
  when { UE receives an AMD PDU with a SN gap }
  then { UE sends STATUS PDU to request retransmissions of PDUs in the SN gap }
}

```

7.1.2.3.9.2 Conformance requirements

References: The conformance requirements covered in the present TC are specified in: 3GPP TS 38.322 clauses 4.2.1.3.3, 5.2.3.2.1, 5.2.3.2.2, 5.2.3.2.3, 5.2.3.2.4 and 5.3.4. Unless otherwise stated these are Rel-15 requirements.

[TS 38.322, clause 4.2.1.3.3]

When the receiving side of an AM RLC entity receives AMD PDUs, it shall:

- detect whether or not the AMD PDUs have been received in duplication, and discard duplicated AMD PDUs;
- detect the loss of AMD PDUs at lower layers and request retransmissions to its peer AM RLC entity;
- reassemble RLC SDUs from the received AMD PDUs and deliver the RLC SDUs to upper layer as soon as they are available.

[TS 38.322, clause 5.2.3.2.1]

The receiving side of an AM RLC entity shall maintain a receiving window according to the state variable `RX_Next` as follows:

- a SN falls within the receiving window if $RX_Next \leq SN < RX_Next + AM_Window_Size$;
- a SN falls outside of the receiving window otherwise.

When receiving an AMD PDU from lower layer, the receiving side of an AM RLC entity shall:

- either discard the received AMD PDU or place it in the reception buffer (see sub clause 5.2.3.2.2);
- if the received AMD PDU was placed in the reception buffer:
 - update state variables, reassemble and deliver RLC SDUs to upper layer and start/stop t-Reassembly as needed (see sub clause 5.2.3.2.3).

When t-Reassembly expires, the receiving side of an AM RLC entity shall:

- update state variables and start t-Reassembly as needed (see sub clause 5.2.3.2.4).

[TS 38.322, clause 5.2.3.2.2]

When an AMD PDU is received from lower layer, where the AMD PDU contains byte segment numbers `y` to `z` of an RLC SDU with `SN = x`, the receiving side of an AM RLC entity shall:

- if `x` falls outside of the receiving window; or
- if byte segment numbers `y` to `z` of the RLC SDU with `SN = x` have been received before:
 - discard the received AMD PDU.
- else:
 - place the received AMD PDU in the reception buffer;
 - if some byte segments of the RLC SDU contained in the AMD PDU have been received before:
 - discard the duplicate byte segments.

[TS 38.322, clause 5.2.3.2.3]

When an AMD PDU with SN = x is placed in the reception buffer, the receiving side of an AM RLC entity shall:

- if $x \geq \text{RX_Next_Highest}$
 - update RX_Next_Highest to $x + 1$.
- if all bytes of the RLC SDU with SN = x are received:
 - reassemble the RLC SDU from AMD PDU(s) with SN = x, remove RLC headers when doing so and deliver the reassembled RLC SDU to upper layer;
 - if $x = \text{RX_Highest_Status}$,
 - update RX_Highest_Status to the SN of the first RLC SDU with SN > current RX_Highest_Status for which not all bytes have been received.
 - if $x = \text{RX_Next}$:
 - update RX_Next to the SN of the first RLC SDU with SN > current RX_Next for which not all bytes have been received.
- if t-Reassembly is running:
 - if $\text{RX_Next_Status_Trigger} = \text{RX_Next}$; or
 - if $\text{RX_Next_Status_Trigger} = \text{RX_Next} + 1$ and there is no missing byte segment of the SDU associated with SN = RX_Next before the last byte of all received segments of this SDU; or
 - if $\text{RX_Next_Status_Trigger}$ falls outside of the receiving window and $\text{RX_Next_Status_Trigger}$ is not equal to $\text{RX_Next} + \text{AM_Window_Size}$:
 - stop and reset t-Reassembly.
- if t-Reassembly is not running (includes the case t-Reassembly is stopped due to actions above):
 - if $\text{RX_Next_Highest} > \text{RX_Next} + 1$; or
 - if $\text{RX_Next_Highest} = \text{RX_Next} + 1$ and there is at least one missing byte segment of the SDU associated with SN = RX_Next before the last byte of all received segments of this SDU:
 - start t-Reassembly;
 - set $\text{RX_Next_Status_Trigger}$ to RX_Next_Highest .

[TS 38.322, clause 5.2.3.2.4]

When t-Reassembly expires, the receiving side of an AM RLC entity shall:

- update RX_Highest_Status to the SN of the first RLC SDU with SN $\geq \text{RX_Next_Status_Trigger}$ for which not all bytes have been received;
- if $\text{RX_Next_Highest} > \text{RX_Highest_Status} + 1$: or
- if $\text{RX_Next_Highest} = \text{RX_Highest_Status} + 1$ and there is at least one missing byte segment of the SDU associated with SN = RX_Highest_Status before the last byte of all received segments of this SDU:
 - start t-Reassembly;
 - set $\text{RX_Next_Status_Trigger}$ to RX_Next_Highest .

[TS 38.322, clause 5.3.4]

An AM RLC entity sends STATUS PDUs to its peer AM RLC entity in order to provide positive and/or negative acknowledgements of RLC SDUs (or portions of them).

Triggers to initiate STATUS reporting include:

- Polling from its peer AM RLC entity:
 - When an AMD PDU with SN = x and the P field set to "1" is received from lower layer, the receiving side of an AM RLC entity shall:
 - if the AMD PDU is to be discarded as specified in subclause 5.2.3.2.2; or
 - if $x < \text{RX_Highest_Status}$ or $x \geq \text{RX_Next} + \text{AM_Window_Size}$:
 - trigger a STATUS report.
 - else:
 - delay triggering the STATUS report until $x < \text{RX_Highest_Status}$ or $x \geq \text{RX_Next} + \text{AM_Window_Size}$.

NOTE 1: This ensures that the RLC Status report is transmitted after HARQ reordering.

- Detection of reception failure of an AMD PDU
 - The receiving side of an AM RLC entity shall trigger a STATUS report when t-Reassembly expires.

NOTE 2: The expiry of t-Reassembly triggers both RX_Highest_Status to be updated and a STATUS report to be triggered, but the STATUS report shall be triggered after RX_Highest_Status is updated.

When STATUS reporting has been triggered, the receiving side of an AM RLC entity shall:

- if *t-StatusProhibit* is not running:
 - at the first transmission opportunity indicated by lower layer, construct a STATUS PDU and submit it to lower layer.
- else:
 - at the first transmission opportunity indicated by lower layer after *t-StatusProhibit* expires, construct a single STATUS PDU even if status reporting was triggered several times while *t-StatusProhibit* was running and submit it to lower layer.

When a STATUS PDU has been submitted to lower layer, the receiving side of an AM RLC entity shall:

- start *t-StatusProhibit*.

When constructing a STATUS PDU, the AM RLC entity shall:

- for the RLC SDUs with SN such that $\text{RX_Next} \leq \text{SN} < \text{RX_Highest_Status}$ that has not been completely received yet, in increasing SN order of RLC SDUs and increasing byte segment order within RLC SDUs, starting with SN = RX_Next up to the point where the resulting STATUS PDU still fits to the total size of RLC PDU(s) indicated by lower layer:
 - for an RLC SDU for which no byte segments have been received yet:
 - include in the STATUS PDU a NACK_SN which is set to the SN of the RLC SDU.
 - for a continuous sequence of byte segments of a partly received RLC SDU that have not been received yet:
 - include in the STATUS PDU a set of NACK_SN, SOstart and SOend.
 - for a continuous sequence of RLC SDUs that have not been received yet:
 - include in the STATUS PDU a set of NACK_SN and NACK range;
 - include in the STATUS PDU, if required, a pair of SOstart and SOend.
- set the ACK_SN to the SN of the next not received RLC SDU which is not indicated as missing in the resulting STATUS PDU.

When STATUS reporting has been triggered, the receiving side of an AM RLC entity shall:

- if *t-StatusProhibit* is not running:
 - at the first transmission opportunity indicated by lower layer, construct a STATUS PDU and submit it to lower layer.
- else:
 - at the first transmission opportunity indicated by lower layer after *t-StatusProhibit* expires, construct a single STATUS PDU even if status reporting was triggered several times while *t-StatusProhibit* was running and submit it to lower layer.

When a STATUS PDU has been submitted to lower layer, the receiving side of an AM RLC entity shall:

- start *t-StatusProhibit*.

When constructing a STATUS PDU, the AM RLC entity shall:

- for the RLC SDUs with SN such that $RX_Next \leq SN < RX_Highest_Status$ that has not been completely received yet, in increasing SN order of RLC SDUs and increasing byte segment order within RLC SDUs, starting with SN = RX_Next up to the point where the resulting STATUS PDU still fits to the total size of RLC PDU(s) indicated by lower layer:
 - for an RLC SDU for which no byte segments have been received yet:
 - include in the STATUS PDU a NACK_SN which is set to the SN of the RLC SDU.
 - for a continuous sequence of byte segments of a partly received RLC SDU that have not been received yet:
 - include in the STATUS PDU a set of NACK_SN, SOstart and SOend.
 - for a continuous sequence of RLC SDUs that have not been received yet:
 - include in the STATUS PDU a set of NACK_SN and NACK range;
 - include in the STATUS PDU, if required, a pair of SOstart and SOend.
 - set the ACK_SN to the SN of the next not received RLC SDU which is not indicated as missing in the resulting STATUS PDU.

7.1.2.3.9.3 Test description

7.1.2.3.9.3.1 Pre-test conditions

Same Pre-test conditions as in clause 7.1.2.1.1 with the exception that the AM DRB is configured according to Table 7.1.2.3.9.3.1-1.

Table 7.1.2.3.9.3.1-1: RLC parameters

Parameter	Value
<i>t-Reassembly</i>	ms150
<i>t-StatusProhibit</i>	ms300
<i>t-PollRetransmit</i>	ms500

7.1.2.3.9.3.2 Test procedure sequence

Table 7.1.2.3.9.3.2-1: Main behaviour

St	Procedure	Message Sequence		TP	Verdict
		U - S	Message/PDU/SDU		
0	The SS stops the UL grant transmission.	-	-	-	-
1	The SS transmits AMD PDU#1 containing a complete RLC SDU#4 (89 bytes and SI field=00). (Note 4)	<--	AMD PDU#1 (SN=3)	-	-
2	The SS transmits AMD PDU#2 containing the last segment (44 bytes) of RLC SDU#1 (SI field=10, SO=45).	<--	AMD PDU#2 (SN=0) segment 2	-	-
3	The SS transmits AMD PDU#3 containing the last segment (44 bytes) of RLC SDU#2 (SI field=10, SO=45).	<--	AMD PDU#3 (SN=1) segment 2	-	-
4	The SS transmits AMD PDU#4 containing the first segment (45 bytes) of RLC SDU#2 (SI field=01).	<--	AMD PDU#4 (SN=1) segment 1	-	-
5	The SS transmits AMD PDU#5 containing the first segment (45 bytes) of RLC SDU#1 (SI field=01).	<--	AMD PDU#5 (SN=0) segment 1	-	-
6	The SS waits for 20 ms then SS transmits 2 uplink grants with a time spacing of 20 ms. (Note 1)	<--	UL Grants	-	-
7	Check: Does the UE transmit an AMD PDU containing RLC SDU#1 in its data field?	-->	AMD PDU (RLC SDU#1)	1,3	P
8	Check: Does the UE transmit an AMD PDU containing RLC SDU#2 in its data field?	-->	AMD PDU (RLC SDU#2)	1,3	P
9	Void				
9A	110 ms after step 5 the SS starts the UL default grant transmission.	<--	UL Grant	-	-
10	Wait for t-reassembly of UE side to expire. Check: Does the UE transmit an RLC STATUS PDU with NACK_SN=2 and ACK_SN=4 to correctly to inform SS of missing RLC SDU#3?	-->	STATUS PDU (ACK_SN=4, NACK_SN=2)	2,7	P
10A	The SS stops the UL grant transmission.	-	-	-	-
11	120 ms after step 10 the SS transmits AMD PDU#6 containing the first 45 bytes of SDU#3 in its data field. SO=0 and LSF=0. No header extension part is provided.(Note 5)	<--	AMD PDU#6 (SN=2) segment 1	-	-
11A	20 ms after step 11 the SS transmits AMD PDU#6 containing the first 45 bytes of SDU#3 in its data field. SO=0 and LSF=0. No header extension part is provided.	<--	AMD PDU#6 (SN=2) segment 1	-	-
12	40 ms after step 11 the SS transmits AMD PDU#12 containing the last 44 bytes of SDU#3 in its data field, with the P-bit set. SO=45 and LSF=1. No header extension part is provided.	<--	AMD PDU#12 (SN=2, P=1) segment 2	-	-

13	After the expiry of t-StatusProhibit timer started at step 10, the SS assigns 1 UL grant (UL grant allocation type 3) of size 88 bits. (Note 2)	<--	UL Grant	-	-
14	Check: Does the UE transmit a STATUS PDU with ACK_SN=4, thus acknowledging the reception of PDUs with SN=0 to SN=3, and no NACK_SN provided?	-->	STATUS PDU	1,3,4	P
14A	The SS waits for 40 ms to ensure UE has all the required SDUs available and then assigns 2 UL grants of 768 bits (Note 1).	<--	UL Grant	-	-
15	Check: Does the UE transmit RLC SDU#3?	-->	(RLC SDU#3)	1,3,4	P
15A	Check: Does the UE transmit RLC SDU#4 with the P-bit set?	-->	(RLC SDU#4)	1,3,4	P
16	The SS transmits a STATUS PDU.	<--	STATUS PDU (ACK SN=4)	-	-
17	The SS transmits AMD PDU#7 containing the last segment (44 bytes) of RLC SDU#5 (SI field=10, SO=45).	<--	AMD PDU#7 (SN=4) segment 2	-	-
17A	The SS starts the UL default grant transmission.	<--	UL Grant	-	-
18	Wait for t-reassembly of UE side to expire. Check: Does the UE transmit an RLC STATUS PDU with ACK_SN=5, NACK_SN=4 with SOStart=0 and SOEnd=44?	-->	STATUS PDU (ACK_SN=5, NACK_SN=4 with SOStart=0 /SOEnd=44)	2,5	P
18A	The SS stops the UL grant transmission.	-	-	-	-
19	160 ms after step 18 The SS transmits AMD PDU#8 containing the first segment (45 bytes) of RLC SDU#5 (SI field=01). (Note 6)	<--	AMD PDU#8 (SN=4, P=1) segment 1	-	-
20	Void				
21	Void				
21A	After the expiry of t-StatusProhibit timer started at step 18, the SS assigns 1 UL grant (UL grant allocation type 3) of size 88 bits. (Note 2)	<--	UL Grant	-	-
22	Check: Does the UE transmit an RLC STATUS PDU with ACK_SN=5?	-->	STATUS PDU (ACK_SN=5)	1,3,5	P
22A	The SS waits for 100 ms then SS transmits one uplink grant. (Note 1)	<--	UL Grant	-	-
22B	Check: Does the UE transmit an AMD PDU containing RLC SDU#5 in its data field with the P-bit set?	-->	AMD PDU (RLC SDU#5)	1,3,5	P
22C	The SS transmits a STATUS PDU	<--	STATUS PDU (ACK SN=5)		
23	The SS transmits AMD PDU#9 containing the last 29 bytes of RLC SDU#6 (SI field=10, SO=60).	<--	AMD PDU#9 (SN=5) segment 3	-	-
23A	The SS starts the UL default grant transmission.	<--	UL Grant	-	-

24	Wait for t-reassembly of UE side to expire. Check: Does the UE transmit an RLC STATUS PDU with ACK_SN=6, NACK_SN=5 with SOStart=0 and SOEnd=59?	-->	STATUS PDU (ACK_SN=6, NACK_SN=5 with SOStart=0 / SOEnd=59)	2,5	P
25	The SS transmits AMD PDU#10 containing the last 49 byte of RLC SDU#6 (SI field=10, SO=40).	<--	AMD PDU#10 (SN=5) segment 2	-	-
25A	Void.				
26	Wait for t-reassembly of UE side to expire. Check: Does the UE transmit an RLC STATUS PDU with ACK_SN=6, NACK_SN=5 with SOStart=0 and SOEnd=39?	-->	STATUS PDU (ACK_SN=6, NACK_SN=5 with SOStart=0 / SOEnd=39)	2,6	P
26A	The SS stops the UL grant transmission.	-	-	-	-
27	160 ms after step 26 The SS transmits AMD PDU#11 containing the first 40 bytes of RLC SDU#6 (SI field =01).	<--	AMD PDU#11 (SN=5, P=1) segment 1	-	-
28	Void				
29	Void				
29A	After the expiry of t-StatusProhibit timer started at step 26, the SS assigns 1 UL grant (UL grant allocation type 3) of size 88 bits. (Note 2, Note 7)	<--	UL Grant	-	-
30	Check: Does the UE transmit an RLC STATUS PDU with ACK_SN=6, thus acknowledging the reception of RLC SDUs with SN=0 to SN=5, and no NACK_SN provided?	-->	STATUS PDU (ACK_SN=6)	1,3,6	P
30A	The SS transmits one uplink grant. (Note 1)	<--	UL Grant	-	-
30B	Check: Does the UE transmit an AMD PDU containing RLC SDU#6 in its data field with the P-bit set?	-->	AMD PDU (RLC SDU#6)	1,3,6	P
31	The SS transmits a STATUS PDU.	<--	STATUS PDU (ACK SN=6)	-	-
<p>Note 1: UL grant of 768 bits(L_{RBs} & l_{MCS} as per 38.523-3[3] annex B) is chosen to allow the UE to transmit one PDU at a time(89 bytes RLC SDU + 3 bytes RLC Header + 2 bytes MAC Sub PDU header + 2 bytes for short BSR or padding).</p> <p>Note 2: UL grant of 88 bits (L_{RBs} & l_{MCS} as per 38.523-3 [3] annex B) is chosen to allow the UE to transmit a Status Report with ACK_SN(3 byte) + 2 Bytes MAC PDU subheader and (2 Bytes short BSR). 4 Bytes additional space provided to confirm UE does include resp. does not include NACK_SN and conformant UE instead will include MAC Padding.</p> <p>Note 3: Void</p> <p>Note 4: The PDUs in steps 1-5 are scheduled with a 20 ms time spacing. The UL grant provision in step 6 is scheduled 20 ms later That way this step sequence takes less than t-Reassembly.</p> <p>Note 5: Timing difference between step 10 to step 14 is equal to t-statusProhibit timer. UE starts SR from step 12. 120 ms is chosen so that UE does not reach sr-transMax(n16) otherwise UE RACHes.</p> <p>Note 6: Timing difference between step 18 to step 22 is equal to t-statusProhibit timer. UE starts SR from step 19. 160 ms is chosen so that UE does not reach sr-transMax(n16) otherwise UE RACHes.</p> <p>Note 7: Timing difference between step 26 to step 30 is equal to t-statusProhibit timer. UE starts SR from step 27. 160 ms is chosen so that UE does not reach sr-transMax(n16) otherwise UE RACHes.</p>					

7.1.2.3.9.3.3 Specific message contents

None.

7.1.2.3.10 AM RLC / Re-transmission of RLC PDU with and without re-segmentation

7.1.2.3.10.1 Test Purpose (TP)

(1)

```
with { UE in RRC_CONNECTED state }
ensure that {
  when { UE receives a STATUS PDU including a NACK_SN for missing AMD PDUs and missing AMD PDUs can
be transmitted as indicated by lower layer at the particular transmission opportunity }
  then { UE successfully retransmits missing AMD PDUs without re-segmentation }
}
```

(2)

```
with { UE in RRC_CONNECTED state }
ensure that {
  when { NACK received for missing AMD PDUs and RETX_COUNT < maxRetxThreshold }
  then { UE retransmits AMD PDUs }
}
```

(3)

```
with { UE in RRC_CONNECTED state }
ensure that {
  when { AMD PDU to be retransmitted does not fit in new allocated TBS }
  then { UE segments AMD PDU }
}
```

(4)

```
with { UE in RRC_CONNECTED state }
ensure that {
  when { AMD PDU segment to be retransmitted does not fit in new allocated TBS }
  then { UE re-segments AMD PDU segment to fit TBS }
}
```

7.1.2.3.10.2 Conformance requirements

References: The conformance requirements covered in the present test case are specified in: TS 38.322, clauses 5.3.2, 6.2.2.5, 6.2.3.3, 6.2.3.4, 6.2.3.5, 6.2.3.7, 6.2.3.10, 6.2.3.12, 6.2.3.14 and 6.2.3.15. Unless otherwise stated these are Rel-15 requirements.

[TS 38.322, clause 5.3.2]

The transmitting side of an AM RLC entity can receive a negative acknowledgement (notification of reception failure by its peer AM RLC entity) for an RLC SDU or an RLC SDU segment by the following:

- STATUS PDU from its peer AM RLC entity.

When receiving a negative acknowledgement for an RLC SDU or an RLC SDU segment by a STATUS PDU from its peer AM RLC entity, the transmitting side of the AM RLC entity shall:

- if the SN of the corresponding RLC SDU falls within the range $TX_Next_Ack \leq SN \leq$ the highest SN of the AMD PDU among the AMD PDUs submitted to lower layer:
 - consider the RLC SDU or the RLC SDU segment for which a negative acknowledgement was received for retransmission.

When an RLC SDU or an RLC SDU segment is considered for retransmission, the transmitting side of the AM RLC entity shall:

- if the RLC SDU or RLC SDU segment is considered for retransmission for the first time:
 - set the RETX_COUNT associated with the RLC SDU to zero.

- else, if it (the RLC SDU or the RLC SDU segment that is considered for retransmission) is not pending for retransmission already and the RETX_COUNT associated with the RLC SDU has not been incremented due to another negative acknowledgment in the same STATUS PDU:
 - increment the RETX_COUNT.
- if RETX_COUNT = maxRetxThreshold:
 - indicate to upper layers that max retransmission has been reached.

When retransmitting an RLC SDU or an RLC SDU segment, the transmitting side of an AM RLC entity shall:

- if needed, segment the RLC SDU or the RLC SDU segment;
- form a new AMD PDU which will fit within the total size of AMD PDU(s) indicated by lower layer at the particular transmission opportunity;
- submit the new AMD PDU to lower layer.

When forming a new AMD PDU, the transmitting side of an AM RLC entity shall:

- only map the original RLC SDU or RLC SDU segment to the Data field of the new AMD PDU;
- modify the header of the new AMD PDU in accordance with the description in sub clause 6.2.2.4;
- set the P field according to sub clause 5.3.3.

[TS 38.322, clause 6.2.2.4]

AMD PDU consists of a Data field and an AMD PDU header. The AMD PDU header is byte aligned.

An AM RLC entity is configured by RRC to use either a 12 bit SN or a 18 bit SN. The length of the AMD PDU header is two and three bytes respectively.

An AMD PDU header contains a D/C, a P, a SI, and a SN. An AMD PDU header contains the SO field only when the Data field consists of an RLC SDU segment which is not the first segment, in which case a 16 bit SO is present.

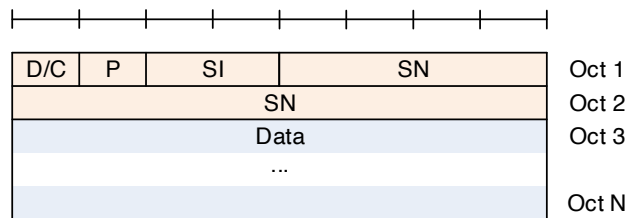

Figure 6.2.2.4-1: AMD PDU with 12 bit SN (No SO)

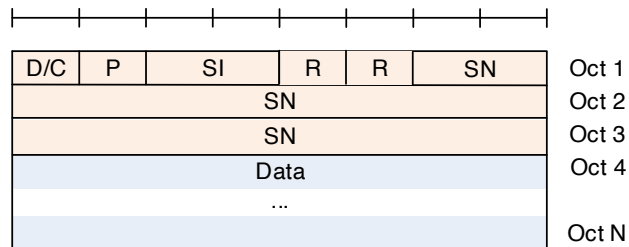

Figure 6.2.2.4-2: AMD PDU with 18 bit SN (No SO)

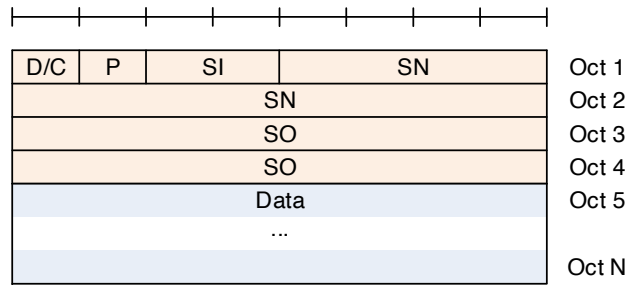

Figure 6.2.2.4-3: AMD PDU with 12 bit SN with SO

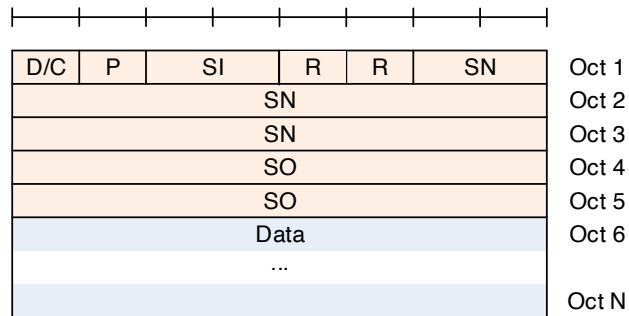

Figure 6.2.2.4-4: AMD PDU with 18 bit SN with SO

[TS 38.322, clause 6.2.2.5]

STATUS PDU consists of a STATUS PDU payload and an RLC control PDU header.

RLC control PDU header consists of a D/C and a CPT field.

The STATUS PDU payload starts from the first bit following the RLC control PDU header, and it consists of one ACK_SN and one E1, zero or more sets of a NACK_SN, an E1, an E2 and an E3, and possibly a pair of a SOstart and a SOend or a NACK range field for each NACK_SN.

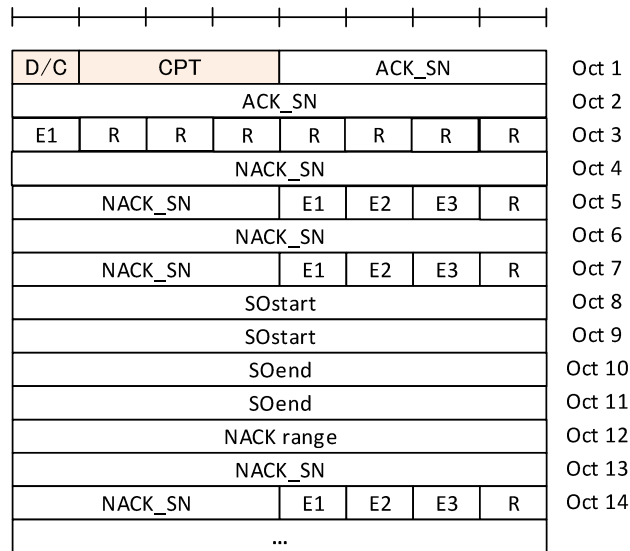

Figure 6.2.2.5-1: STATUS PDU with 12 bit SN

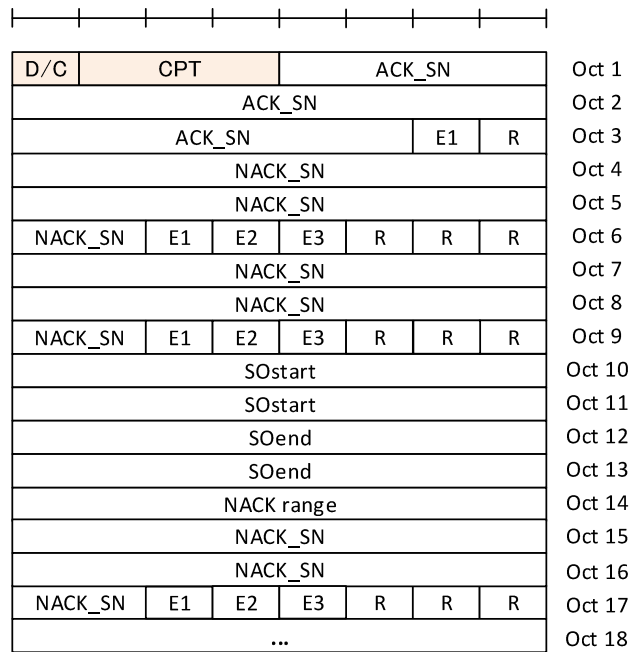

Figure 6.2.2.5-2: STATUS PDU with 18 bit SN

[TS 38.322, clause 6.2.3.3]

Length: 12 bits or 18 bits (configurable) for AMD PDU. 6 bits or 12 bits (configurable) for UMD PDU.

The SN field indicates the sequence number of the corresponding RLC SDU. For RLC AM, the sequence number is incremented by one for every RLC SDU. For RLC UM, the sequence number is incremented by one for every segmented RLC SDU.

[TS 38.322, clause 6.2.3.4]

Length: 2 bits.

The SI field indicates whether an RLC PDU contains a complete RLC SDU or the first, middle, last segment of an RLC SDU.

Table 6.2.3.4-1: SI field interpretation

Value	Description
00	Data field contains all bytes of an RLC SDU
01	Data field contains the first segment of an RLC SDU
10	Data field contains the last segment of an RLC SDU
11	Data field contains neither the first nor last segment of an RLC SDU

[TS 38.322, clause 6.2.3.5]

Length: 16 bits

The SO field indicates the position of the RLC SDU segment in bytes within the original RLC SDU. Specifically, the SO field indicates the position within the original RLC SDU to which the first byte of the RLC SDU segment in the Data field corresponds. The first byte of the original RLC SDU is referred by the SO field value "0000000000000000", i.e., numbering starts at zero.

[TS 38.322, clause 6.2.3.7]

Length: 1 bit.

The P field indicates whether or not the transmitting side of an AM RLC entity requests a STATUS report from its peer AM RLC entity. The interpretation of the P field is provided in Table 6.2.3.7-1.

Table 6.2.3.7-1: P field interpretation

Value	Description
0	Status report not requested
1	Status report is requested

[TS 38.322, clause 6.2.3.10]

Length: 12 bits or 18 bits (configurable).

The ACK_SN field indicates the SN of the next not received RLC SDU which is not reported as missing in the STATUS PDU. When the transmitting side of an AM RLC entity receives a STATUS PDU, it interprets that all RLC SDUs up to but not including the RLC SDU with SN = ACK_SN have been received by its peer AM RLC entity, excluding those RLC SDUs indicated in the STATUS PDU with NACK_SN, portions of RLC SDUs indicated in the STATUS PDU with NACK_SN, SOstart and SOend, RLC SDUs indicated in the STATUS PDU with NACK_SN and NACK_range, and portions of RLC SDUs indicated in the STATUS PDU with NACK_SN, NACK range, SOstart and SOend.

[TS 38.322, clause 6.2.3.12]

Length: 12 bits or 18 bits (configurable).

The NACK_SN field indicates the SN of the RLC SDU (or RLC SDU segment) that has been detected as lost at the receiving side of the AM RLC entity.

[TS 38.322, clause 6.2.3.14]

Length: 16 bits.

The SStart field (together with the SOend field) indicates the portion of the RLC SDU with SN = NACK_SN (the NACK_SN for which the SStart is related to) that has been detected as lost at the receiving side of the AM RLC entity. Specifically, the SStart field indicates the position of the first byte of the portion of the RLC SDU in bytes within the original RLC SDU. The first byte of the original RLC SDU is referred by the SStart field value "0000000000000000", i.e., numbering starts at zero.

[TS 38.322, clause 6.2.3.15]

Length: 16 bits.

When E3 is 0, the SOend field (together with the SStart field) indicates the portion of the RLC SDU with SN = NACK_SN (the NACK_SN for which the SOend is related to) that has been detected as lost at the receiving side of the AM RLC entity. Specifically, the SOend field indicates the position of the last byte of the portion of the RLC SDU in bytes within the original RLC SDU. The first byte of the original RLC SDU is referred by the SOend field value "0000000000000000", i.e., numbering starts at zero. The special SOend value "1111111111111111" is used to indicate that the missing portion of the RLC SDU includes all bytes to the last byte of the RLC SDU.

When E3 is 1, the SOend field indicates the portion of the RLC SDU with SN = NACK_SN + NACK range - 1 that has been detected as lost at the receiving side of the AM RLC entity. Specifically, the SOend field indicates the position of the last byte of the portion of the RLC SDU in bytes within the original RLC SDU. The first byte of the original RLC SDU is referred by the SOend field value "0000000000000000", i.e., numbering starts at zero. The special SOend value "1111111111111111" is used to indicate that the missing portion of the RLC SDU includes all bytes to the last byte of the RLC SDU.

7.1.2.3.10.3 Test description

7.1.2.3.10.3.1 Pre-test conditions

Same Pre-test conditions as in clause 7.1.2.1.1 with the exception for the AM DRB is configured according to Tables 7.1.2.3.10.3.1-1.

Table 7.1.2.3.10.3.1-1: RLC settings

Parameter	Value
<i>t-PollRetransmit</i>	ms150

7.1.2.3.10.3.2 Test procedure sequence

Table 7.1.2.3.10.3.2-1: Main behaviour

St	Procedure	Message Sequence		TP	Verdict
		U - S	Message		
1	The SS transmits one AMD PDU containing SDU#1 (91 bytes) in its data field.	<--	AMD PDU#1	-	-
2	The UE transmits one AMD PDU containing SDU#1 in its data field.	-->	AMD PDU#1 (SN=0)	-	-
3	The SS transmits one AMD PDU containing SDU#2 (91 bytes) in its data field.	<--	AMD PDU#2	-	-
4	The UE transmits one AMD PDU containing SDU#2 in its data field.	-->	AMD PDU#2 (SN=1)	-	-
5	The SS transmits a RLC STATUS PDU. ACK_SN=2, NACK_SN=0.	<--	STATUS PDU	-	-
6	Check: Does the UE transmit the AMD PDU not yet acknowledged?	-->	AMD PDU#1 (SN=0)	1	P
7	The SS transmits a RLC STATUS PDU. ACK_SN=2.	<--	STATUS PDU	-	-
8	The SS transmits one AMD PDU containing SDU#3 (91 bytes) in its data field.	<--	AMD PDU#3	-	-
9	The UE transmits an AMD PDU containing SDU#3 in its data field.	-->	AMD PDU#3 (SN=2)	-	-
-	EXCEPTION: Steps 10 to 11 shall be repeated until RETX_COUNT= maxRetxThreshold-1.	-	-	-	-
10	The SS transmits a RLC STATUS PDU. ACK_SN=3 and NACK_SN=2.	<--	STATUS PDU	-	-
11	Check: Does the UE retransmit the AMD PDU not yet acknowledged?	-->	AMD PDU#3 (SN=2)	2	P
12	The SS transmits a RLC STATUS PDU. ACK_SN=3.	<--	STATUS PDU	-	-
13	The SS stops the UL grant transmission.	-	-	-	-
14	The SS transmits one AMD PDU containing SDU#4 (91 bytes) in its data field.	<--	AMD PDU#4 (SN=3)	-	-
15	The SS waits for 60 ms and allocates one UL grant of size 808 bits. (Note 1)	<--	(UL grant, 808 bits)	-	-
16	The UE transmits an AMD PDU with the same data contents as received in the corresponding part of SDU#4?	-->	AMD PDU#4 (SN=3)	-	-
17	The SS transmits a STATUS PDU. This PDU nacks the AMD PDU with SN=3. ACK_SN=4 and NACK_SN=3.	<--	STATUS PDU	-	-
18	The SS waits for 100 ms and then allocates 1 UL grant of size 408 bits (Note 2)	<--	(UL grant, 408 bits)	-	-
18A	The SS waits for 20 ms and then allocates 1 UL grant of size 456 bits (Note 5)	<--	(UL grant, 456 bits)	-	-
19	Check: Does the UE transmit an SDU segment with SI=01 and SOEnd=43 and the same data contents at the received positions as in the original SDU#4?	-->	SDU#4 segment 1 (SN=3)	3	P
20	Check: Does the UE transmit an SDU segment with SI=10 and SOStart=44 and the same data contents at the received positions as in the original SDU#4?	-->	SDU#4 segment 2 (SN=3)	3	P
21	After 100 ms SS transmits a STATUS PDU. This PDU nacks the SDU with SN=3. NACK_SN=3, SOStart=0, SOEnd=43 and ACK_SN=4.	<--	STATUS PDU	-	-
22	The SS waits for 100 ms and then allocates 2 UL grants (UL grant allocation type 2) at an interval of 20 ms of size 240 bits (Note 3, Note 6)	<--	(UL grant, 240 bits)	-	-
22A	Void			-	-

23	Check: Does the UE transmit an AMD PDU segment with SI=01 and SOEnd=22 and the same data contents at the received positions as in the original SDU#4?	-->	SDU#4 segment 1, first part (SN=3)	4	P
24	Check: Does the UE transmit an AMD PDU segment with SI=11, SOStart=23 and the same data contents at the received positions as in the original SDU#4?	-->	SDU#4 segment 1, second part (SN=3)	4	P
25	The SS transmits a STATUS PDU. This PDU acks the AMD PDUs with SN=3. ACK_SN=4.	<--	STATUS PDU	-	-
<p>Note 1: UL grant of 808 bits=101 bytes (L_{RBs} & I_{MCS} as per 38.523-3[3] annex B) is chosen to allow the UE to transmit one PDU and 2 bytes short BSR + 3 bytes padding or 5 bytes padding at a time.</p> <p>Note 2: UL grant of 408 bits (L_{RBs} & I_{MCS} as per 38.523-3[3] annex B) is chosen such that UE will segment into 2 AMD PDUs. MAC PDU of 408 bits=51 bytes fit an AMD PDU payload of 44 bytes + 3 bytes for the first segment of the AMD PDU header + 2 bytes for MAC header + 2 bytes of MAC BSR CE.</p> <p>Note 3: UL grant of 240 bits (L_{RBs} & I_{MCS} as per 38.523-3[3] annex B) is chosen such that UE will segment into 2 AMD PDUs. MAC PDU of 240 bits=30 bytes fit an AMD PDU payload of = 23 bytes + 3 bytes for the first segment of the AMD PDU header + 2 bytes for MAC header + 2 bytes for MAC BSR CE.</p> <p>Note 4: Void.</p> <p>Note 5: UL grant of 456 bits (L_{RBs} & I_{MCS} as per 38.523-3[3] annex B) is chosen such that UE will segment into 2 AMD PDUs. MAC PDU of 456 bits=57 bytes fit an AMD PDU payload of 46 bytes + 5 bytes for the first segment of the AMD PDU header + 2 bytes for MAC header +2 bytes for possible short BSR or padding</p> <p>Note 6: UL grant of 240 bits (L_{RBs} & I_{MCS} as per 38.523-3[3] annex B) is chosen such that UE will segment into 2 AMD PDUs. MAC PDU of 240 bits=28 bytes fit an AMD PDU payload of 21 bytes + 3 bytes for the first segment of the AMD PDU header + 2 bytes for MAC header +2 bytes for possible short BSR or padding</p>					

7.1.2.3.10.3.3 Specific message contents

None.

7.1.2.3.11 AM RLC / RLC re-establishment procedure

7.1.2.3.11.1 Test Purpose (TP)

(1)

```
with { UE in RRC_CONNECTED state }
ensure that {
  when { RLC re-establishment is performed upon request by RRC }
  then { The UE discards all RLC SDUs, RLC SDU segments, and RLC PDUs, if any }
}
```

(2)

```
with { UE in RRC_CONNECTED state }
ensure that {
  when { RLC re-establishment is performed upon request by RRC }
  then { The UE resets all state variables to their initial values }
}
```

7.1.2.3.11.2 Conformance requirements

References:

The conformance requirements covered in the present test case are specified in: TS 38.322, clauses 5.1.2, 7.1 and TS 38.331 clause 5.3.11. Unless otherwise stated these are Rel-15 requirements.

[TS 38.322, clause 5.1.2]

When upper layers request an RLC entity re-establishment, the UE shall:

- discard all RLC SDUs, RLC SDU segments, and RLC PDUs, if any;
- stop and reset all timers;

- reset all state variables to their initial values.

[TS 38.322, clause 7.1]

This sub clause describes the state variables used in AM and UM entities in order to specify the RLC protocol. The state variables defined in this subclause are normative.

All state variables and all counters are non-negative integers.

All state variables related to AM data transfer can take values from 0 to 4095 for 12 bit SN or from 0 to 262143 for 18 bit SN. All arithmetic operations contained in the present document on state variables related to AM data transfer are affected by the AM modulus (i.e. final value = [value from arithmetic operation] modulo 4096 for 12 bit SN and 262144 for 18 bit SN).

All state variables related to UM data transfer can take values from 0 to 63 for 6 bit SN or from 0 to 4095 for 12 bit SN. All arithmetic operations contained in the present document on state variables related to UM data transfer are affected by the UM modulus (i.e. final value = [value from arithmetic operation] modulo 64 for 6 bit SN and 4096 for 12 bit SN).

When performing arithmetic comparisons of state variables or SN values, a modulus base shall be used.

TX_Next_Ack and RX_Next shall be assumed as the modulus base at the transmitting side and receiving side of an AM RLC entity, respectively. This modulus base is subtracted from all the values involved, and then an absolute comparison is performed (e.g. $RX_Next \leq SN < RX_Next + AM_Window_Size$ is evaluated as $[RX_Next - RX_Next] \bmod 2^{[sn-FieldLength]} \leq [SN - RX_Next] \bmod 2^{[sn-FieldLength]} < [RX_Next + AM_Window_Size - RX_Next] \bmod 2^{[sn-FieldLength]}$), where *sn-FieldLength* is 12 or 18 for 12 bit SN and 18 bit SN, respectively.

RX_Next_Highest-UM_Window_Size shall be assumed as the modulus base at the receiving side of an UM RLC entity. This modulus base is subtracted from all the values involved, and then an absolute comparison is performed (e.g. $(RX_Next_Highest - UM_Window_Size) \leq SN < RX_Next_Highest$ is evaluated as $[(RX_Next_Highest - UM_Window_Size) - (RX_Next_Highest - UM_Window_Size)] \bmod 2^{[sn-FieldLength]} \leq [SN - (RX_Next_Highest - UM_Window_Size)] \bmod 2^{[sn-FieldLength]} < [RX_Next_Highest - (RX_Next_Highest - UM_Window_Size)] \bmod 2^{[sn-FieldLength]}$), where *sn-FieldLength* is 6 or 12 for 6 bit SN and 12 bit SN, respectively.

The transmitting side of each AM RLC entity shall maintain the following state variables:

a) TX_Next_Ack – Acknowledgement state variable

This state variable holds the value of the SN of the next RLC SDU for which a positive acknowledgment is to be received in-sequence, and it serves as the lower edge of the transmitting window. It is initially set to 0, and is updated whenever the AM RLC entity receives a positive acknowledgment for an RLC SDU with SN = TX_Next_Ack.

b) TX_Next – Send state variable

This state variable holds the value of the SN to be assigned for the next newly generated AMD PDU. It is initially set to 0, and is updated whenever the AM RLC entity constructs an AMD PDU with SN = TX_Next and contains an RLC SDU or the last segment of a RLC SDU.

c) POLL_SN – Poll send state variable

This state variable holds the value of the highest SN of the AMD PDU among the AMD PDUs submitted to lower layer when POLL_SN is set according to sub clause 5.3.3.2. It is initially set to 0.

The transmitting side of each AM RLC entity shall maintain the following counters:

a) PDU_WITHOUT_POLL – Counter

This counter is initially set to 0. It counts the number of AMD PDUs sent since the most recent poll bit was transmitted.

b) BYTE_WITHOUT_POLL – Counter

This counter is initially set to 0. It counts the number of data bytes sent since the most recent poll bit was transmitted.

c) RETX_COUNT – Counter

This counter counts the number of retransmissions of an RLC SDU or RLC SDU segment (see subclause 5.3.2). There is one RETX_COUNT counter maintained per RLC SDU.

The receiving side of each AM RLC entity shall maintain the following state variables:

a) RX_Next – Receive state variable

This state variable holds the value of the SN following the last in-sequence completely received RLC SDU, and it serves as the lower edge of the receiving window. It is initially set to 0, and is updated whenever the AM RLC entity receives an RLC SDU with SN = RX_Next.

b) RX_Next_Status_Trigger – *t-Reassembly* state variable

This state variable holds the value of the SN following the SN of the RLC SDU which triggered *t-Reassembly*.

c) RX_Highest_Status – Maximum STATUS transmit state variable

This state variable holds the highest possible value of the SN which can be indicated by "ACK_SN" when a STATUS PDU needs to be constructed. It is initially set to 0.

d) RX_Next_Highest – Highest received state variable

This state variable holds the value of the SN following the SN of the RLC SDU with the highest SN among received RLC SDUs. It is initially set to 0.

Each transmitting UM RLC entity shall maintain the following state variables:

a) TX_Next

This state variable holds the value of the SN to be assigned for the next newly generated UMD PDU with segment. It is initially set to 0, and is updated after the UM RLC entity submits a UMD PDU including the last segment of an RLC SDU to lower layers.

Each receiving UM RLC entity shall maintain the following state variables and constant:

b) RX_Next_Reassembly – UM receive state variable

This state variable holds the value of the earliest SN that is still considered for reassembly. It is initially set to 0.

c) RX_Timer_Trigger – UM *t-Reassembly* state variable

This state variable holds the value of the SN following the SN which triggered *t-Reassembly*.

d) RX_Next_Highest – UM receive state variable

This state variable holds the value of the SN following the SN of the UMD PDU with the highest SN among received UMD PDUs. It serves as the higher edge of the reassembly window. It is initially set to 0.

[TS 38.331, clause 5.3.11]

UE shall:

1> reset MAC;

1> if T302 is running:

2> stop timer T302;

2> perform the actions as specified in 5.3.14.4;

1> stop all timers that are running except T320 and T325;

1> discard the UE Inactive AS context;

1> set the variable *pendingRnaUpdate* to *false*, if that is set to *true*;

1> discard the K_{gNB} , the $K_{RRCCenc}$ key, the K_{RRCint} , the K_{UPint} key and the K_{UPenc} key, if any;

- 1> release all radio resources, including release of the RLC entity, the MAC configuration and the associated PDCP entity and SDAP for all established RBs;
- 1> indicate the release of the RRC connection to upper layers together with the release cause;
- 1> enter RRC_IDLE and perform cell selection as specified in TS 38.304 [20], except if going to RRC_IDLE was triggered by selecting an inter-RAT cell while T311 was running;
- 1> if going to RRC_IDLE was triggered by reception of the *RRCRelease* message including a *waitTime*:
 - 2> start timer T302 with the value set to the *waitTime*;
 - 2> inform the upper layer that access barring is applicable for all access categories except categories '0' and '2'.

7.1.2.3.11.3 Test description

7.1.2.3.11.3.1 Pre-test conditions

Same Pre-test conditions as in clause 7.1.2.1.1 with the exception for the AM DRB is configured according to Table 7.1.2.3.11.3.1-1.

Table 7.1.2.3.11.3.1-1: RLC parameters

Parameter	Value
<i>t-Reassembly</i>	ms200
<i>t-PollRetransmit</i>	ms4000

Table 7.1.2.3.11.3.1-2: PDCP parameters

Parameter	Value
<i>t-Reordering</i>	ms160
<i>statusReportRequired</i>	Not present

7.1.2.3.11.3.2 Test procedure sequence

Table 7.1.2.3.11.3.2-1: Main behaviour

St	Procedure	Message Sequence		TP	Verdict
		U - S	Message		
-	The SS ignores scheduling requests and does not allocate any uplink grant.	-	-	-	-
1	The SS creates 2 RLC SDUs of size 40 bytes segmented into two AMD PDUs each. AMD PDU#1 and AMD PDU#2 belong to RLC SDU#1, AMD PDU#3 and #4 belong to RLC SDU#2. SS transmits AMD PDU#1 (SN=0), AMD PDU#2 (SN=0) and AMD PDU#4 (SN=1).	<--	AMD PDU#1 AMD PDU#2 AMD PDU#4	-	-
2	60 ms after sending PDU#1 in step 1 the SS allocates 1 UL grant of default size.	<--	(UL grant)	-	-
3	The UE returns RLC SDU#1.	-->	(RLC SDU#1)	-	-
4	The SS does not acknowledge the reception of RLC SDU#1.	-	-	-	-
5	The SS transmits NR RRCReconfiguration message to trigger RLC re-establishment on DRB using Reconfig with sync procedure. (Note 1) (Note 4) (Note 6) (Note 7)	<--	<i>RRCReconfiguration</i>	-	-
6	The SS starts the UL default grant transmissions	-	-	-	-
-	EXCEPTION: Steps 7 and 8 can occur in any order. (Note 8)	-	-	-	-
7	The UE transmits a NR RRCReconfigurationComplete message. (Note 5)	-->	<i>RRCReconfigurationComplete</i>	-	-
8	The UE retransmits RLC SDU #1 (SN=0). (Note 2)	-->	(RLC SDU#1)	-	-
9	SS transmits a STATUS PDU (ACK_SN = 1).	<--	STATUS PDU	-	-
10	SS transmits AMD PDU#3 with SN=0 and the P field set to "1"	<--	AMD PDU#3	-	-
11	Void				
12	Check: For 1 second, does the UE return RLC SDU#2 (Note 3)	-->	(RLC SDU#2)	1	F
13	SS transmits AMD PDU#4 with SN=0	<--	AMD PDU#4	-	-
13 A	UE transmits a STATUS PDU (ACK_SN=1)	-->	STATUS PDU	-	-
14	Check: Does the UE return RLC SDU#2 with SN=1?	-->	(RLC SDU#2)	2	P
15	SS transmits a STATUS PDU (ACK_SN = 2)	<--	STATUS PDU	-	-
<p>Note 1: Upon a RLC re-establishment a conformant UE discards any remaining AMD PDUs in the receiver and transmitter side, stops and resets all timers and resets all state variables to their initial values.</p> <p>Note 2: The UE will retransmit the PDCP SDU associated with RLC SDU#1 in accordance to TS 38.323 clause 5.5</p> <p>Note 3: AMD PDU#4 is discarded by a conformant UE in step 5.</p> <p>Note 4: For EN-DC the NR RRCReconfiguration message is contained in RRCConnectionReconfiguration 36.508 [7], Table 4.6.1-8 using condition EN-DC_EmbedNR_RRCRecon, EN-DC_PSCell_HO and RBCConfig_NoKeyChange.</p> <p>Note 5: For EN-DC the NR RRCReconfigurationComplete message is contained in RRCConnectionReconfigurationComplete.</p> <p>Note 6: For NR, the RRCReconfiguration message is as per RRCReconfiguration-HO with condition RBCConfig_NoKeyChange according to 38.508-1 [4], Table 4.8.1-1A.</p> <p>Note 7: The expiry of t-Reassembly timer started in step 1 will trigger STATUS PDU from the UE. This starts SR. The RRC reconfiguration is scheduled 300 ms in advance. sr-transMax is therefore set to n32 so that the UE does not reach sr-transMax and then RACHes before reconfiguring.</p> <p>Note 8: Per 38.508-1 Table 4.6.3-66: <i>LogicalChannelConfig</i>, both SRB1 and DRB have the same logical channel priority with prioritisedBitRate as infinity.</p>					

7.1.2.3.11.3.3 Specific message contents

Table 7.1.2.3.11.3.3-0: SchedulingRequest-Config (Preamble)

Derivation Path: 38.508-1 [4], Table 4.6.3-155			
Information Element	Value/remark	Comment	Condition
sr-TransMax	n32	7.1.2.3.11.3.2-1 Note 7	

Table 7.1.2.3.11.3.3-1: RRCReconfiguration-HO (step 5, Table 7.1.2.3.11.3.3-1)

Derivation Path: 38.508-1 [4], Table 4.8.1-1A with condition RBConfig_NoKeyChange

Table 7.1.2.3.11.3.3-2: Void

7.1.3 PDCP

7.1.3.0 Default Pre-Test Conditions for all PDCP test cases

The following pre-test conditions shall be applied in all PDCP test cases until the test case explicitly over writes these conditions

System Simulator:

- The SS configures the test environment in accordance to the execution conditions in Table 7.1.3.0-1.

UE:

- None

Preamble:

- The SS performs the generic procedure in [4] to get UE in state RRC_CONNECTED in accordance to the execution conditions in Table 7.1.3.0-2 and using the message condition UE TEST LOOP MODE A to return one UL PDCP SDU per DL PDCP SDU.

Table 7.1.3.0-1: Test environment

Execution Condition	Cell configuration	System Information Combination
IF pc_NG_RAN_NR and Connectivity(NR-DC)	NR Cell 1 is PCell NR Cell 10 is PSCell	NR System information Combination NR-4
IF pc_NG_RAN_NR	NR Cell 1	NR System information Combination NR-1
ELSE IF pc_EN_DC	E-UTRA Cell 1 is PCell, NR Cell 1 is PSCell	EUTRA: System information Combination 1 NR: N/A
ELSE IF pc_NGEN_DC	NG-RAN E-UTRA Cell 1 is PCell, NR Cell 1 is PSCell	EUTRA: System information Combination 1 NR: N/A

Table 7.1.3.0-2: Preamble parameters

Execution Condition	Multi-PDN / Multi-PDU Sessions Condition	Generic Procedure Parameters	Primary DRB used for Data testing
IF pc_NG_RAN_NR	FALSE	Connectivity(NR), Test loop function(On) One DRB	Default DRB of the first PDU session on NR Cell
		Connectivity(NR-DC), DC bearer(One MN Terminated MCG bearer and One SN Terminated SCG bearer), Test loop function(On)	SN terminated SCG DRB
	TRUE	Connectivity(NR), Test loop function(On) N DRBs ($N \geq 2$)	Default DRB of the first PDU session on NR Cell
		Connectivity(NR-DC), DC bearer(N MN Terminated MCG bearers and One SN Terminated SCG bearer), N DRBs ($N \geq 2$) Test loop function(On)	SN terminated SCG DRB
ELSE IF pc_EN_DC	FALSE	Connectivity(EN-DC), DC bearer(One MN Terminated MCG bearer and One SN terminated SCG bearer), Test loop function(On)	SN Terminated SCG bearer unless explicitly specified in test case
	TRUE	Connectivity(EN-DC), DC bearer(Two MN Terminated MCG bearer and One SN terminated SCG bearer), Test loop function(On)	
ELSE IF pc_NGEN_DC	FALSE	Connectivity(NGEN-DC), DC bearer(One MN Terminated MCG bearer and One SN terminated SCG bearer), Test loop function(On)	SN Terminated SCG bearer unless explicitly specified in test case
	TRUE	Connectivity(EN-DC), DC bearer(Two MN Terminated MCG bearer and One SN terminated SCG bearer), Test loop function(On)	

Table 7.1.3.0-3: Message conditions

Execution Condition	Message condition exceptions
IF pc_NG_RAN_NR	Message with condition AM is used for step 7 in 4.5.4.2 according to [4]
ELSE IF pc_EN_DC	Message condition MCG_and_SCG with condition AM is used for step 7 in 4.5.4.2 according to [4]
ELSE IF pc_NGEN_DC	Message condition MCG_and_SCG with condition AM is used for step 7 in 4.5.4.2 according to [4]

7.1.3.1 Maintenance of PDCP sequence numbers for radio bearers

7.1.3.1.1 Maintenance of PDCP sequence numbers / User plane / 12 bit SN

7.1.3.1.1.1 Test Purpose (TP)

(1)

with { UE in RRC_CONNECTED state with PDCP configured for 12 bit SN }

```

ensure that {
  when { UE transmits a PDCP Data SDU on a DRB }
  then { UE increments SN with 1 for each transmitted PDU for SN=0 to Maximum_PDCP_SN (2[pdcP-SN-SizeUL]
-1) }
}

```

(2)

```

with { UE in RRC_CONNECTED state with PDCP configured for 12 bit SN }
ensure that {
  when { UE transmits a PDCP Data SDU on a DRB and, after incrementation, TX_NEXT is larger than the
Maximum_PDCP_SN(2[pdcP-SN-SizeUL] -1) }
  then { UE sets SN to 0 in the next transmitted PDCP SDU}
}

```

7.1.3.1.1.2 Conformance requirements

References: The conformance requirements covered in the present TC are specified in: TS 38.323, clauses 5.2.1, 5.2.2.1 and 6.2.2.2. Unless otherwise stated these are Rel-15 requirements.

[TS 38.323, clause 5.2.1]

At reception of a PDCP SDU from upper layers, the transmitting PDCP entity shall:

- start the *discardTimer* associated with this PDCP SDU (if configured).

For a PDCP SDU received from upper layers, the transmitting PDCP entity shall:

- associate the COUNT value corresponding to TX_NEXT to this PDCP SDU;

NOTE 1: Associating more than half of the PDCP SN space of contiguous PDCP SDUs with PDCP SNs, when e.g., the PDCP SDUs are discarded or transmitted without acknowledgement, may cause HFN desynchronization problem. How to prevent HFN desynchronization problem is left up to UE implementation.

- perform header compression of the PDCP SDU as specified in the subclause 5.7.4;
- perform integrity protection, and ciphering using the TX_NEXT as specified in the subclause 5.9 and 5.8, respectively;
- set the PDCP SN of the PDCP Data PDU to TX_NEXT modulo $2^{[pdcP-SN-Size]}$;
- increment TX_NEXT by one;
- submit the resulting PDCP Data PDU to lower layer as specified below.

When submitting a PDCP Data PDU to lower layer, the transmitting PDCP entity shall:

- if the transmitting PDCP entity is associated with one RLC entity:
 - submit the PDCP Data PDU to the associated RLC entity.
- else, if the transmitting PDCP entity is associated with two RLC entities:
 - if *pdcPDuplication* is configured and activated:
 - duplicate the PDCP Data PDU and submit the PDCP Data PDU to both associated RLC entities.
 - else, if *pdcPDuplication* is configured but not activated:
 - submit the PDCP Data PDU to the primary RLC entity.
- else:
 - if the total amount of PDCP data volume and RLC data volume pending for initial transmission (as specified in TS 36.322 [5]) in the two associated RLC entities is less than *ul-DataSplitThreshold*:
 - submit the PDCP Data PDU to the primary RLC entity.

- else:
 - submit the PDCP Data PDU to either the primary RLC entity or the secondary RLC entity.

NOTE 2: If the transmitting PDCP entity is associated with two RLC entities, the UE should minimize the amount of PDCP PDUs submitted to lower layers before receiving request from lower layers and minimize the PDCP SN gap between PDCP PDUs submitted to two associated RLC entities to minimize PDCP reordering delay in the receiving PDCP entity.

[TS 38.323, clause 5.2.2.1]

In this section, following definitions are used:

- HFN(State Variable): the HFN part (i.e. the number of most significant bits equal to HFN length) of the State Variable;
- SN(State Variable): the SN part (i.e. the number of least significant bits equal to PDCP SN length) of the State Variable;
- RCVD_SN: the PDCP SN of the received PDCP Data PDU, included in the PDU header;
- RCVD_HFN: the HFN of the received PDCP Data PDU, calculated by the receiving PDCP entity;
- RCVD_COUNT: the COUNT of the received PDCP Data PDU = [RCVD_HFN, RCVD_SN]

At reception of a PDCP Data PDU from lower layers, the receiving PDCP entity shall determine the COUNT value of the received PDCP Data PDU, i.e. RCVD_COUNT, as follows:

- if $RCVD_SN < SN(RX_DELIV) - Window_Size$:
 - $RCVD_HFN = HFN(RX_DELIV) + 1$.
- else if $RCVD_SN \geq SN(RX_DELIV) + Window_Size$:
 - $RCVD_HFN = HFN(RX_DELIV) - 1$.
- else:
 - $RCVD_HFN = HFN(RX_DELIV)$;
 - $RCVD_COUNT = [RCVD_HFN, RCVD_SN]$.

After determining the COUNT value of the received PDCP Data PDU = RCVD_COUNT, the receiving PDCP entity shall:

- if $RCVD_COUNT < RX_DELIV$; or
- if the PDCP Data PDU with COUNT = RCVD_COUNT has been received before:
 - perform deciphering and integrity verification of the PDCP Data PDU using COUNT = RCVD_COUNT;
 - if integrity verification fails:
 - indicate the integrity verification failure to upper layer;
 - discard the PDCP Data PDU.
- else:
 - perform deciphering and integrity verification of the PDCP Data PDU using COUNT = RCVD_COUNT;
 - if integrity verification fails:
 - indicate the integrity verification failure to upper layer;
 - discard the PDCP Data PDU.

If the received PDCP Data PDU with COUNT value = RCVD_COUNT is not discarded above, the receiving PDCP entity shall:

- store the resulting PDCP SDU in the reception buffer;
- if RCVD_COUNT >= RX_NEXT:
 - update RX_NEXT to RCVD_COUNT + 1.
- if *outOfOrderDelivery* is configured:
 - deliver the resulting PDCP SDU to upper layers.
- if RCVD_COUNT = RX_DELIV:
 - deliver to upper layers in ascending order of the associated COUNT value after performing header decompression, if not decompressed before;
 - all stored PDCP SDU(s) with consecutively associated COUNT value(s) starting from COUNT = RX_DELIV;
 - update RX_DELIV to the COUNT value of the first PDCP SDU which has not been delivered to upper layers, with COUNT value > RX_DELIV;
- if *t-Reordering* is running, and if RX_DELIV >= RX_REORD:
 - stop and reset *t-Reordering*.
- if *t-Reordering* is not running (includes the case when *t-Reordering* is stopped due to actions above), and RX_DELIV < RX_NEXT:
 - update RX_REORD to RX_NEXT;
- start *t-Reordering*.

[TS 38.322, clause 6.2.2.2]

Figure 6.2.2.2-1 shows the format of the PDCP Data PDU with 12 bits PDCP SN. This format is applicable for UM DRBs and AM DRBs.

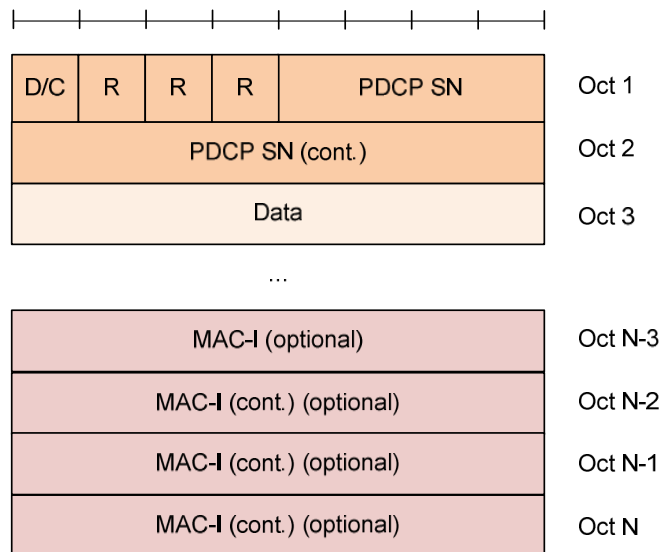

Figure 6.2.2.2-1: PDCP Data PDU format with 12 bits PDCP SN

7.1.3.1.1.3 Test description

7.1.3.1.1.3.1 Pre-test conditions

Same Pre-test conditions as in clause 7.1.3.0 exception of PDCP parameters according to Table 7.1.3.1.1.3.1-1.

Table 7.1.3.1.1.3.1-1: PDCP parameters

PDCP-Config pdcp-SN-SizeUL	len12bits
PDCP-Config pdcp-SN-SizeDL	len12bits

7.1.3.1.1.3.2 Test procedure sequence

Table 7.1.3.1.1.3.2-1: Main behaviour

St	Procedure	Message Sequence		TP	Verdict
		U - S	Message		
-	EXCEPTION: Step 1 shall send several PDCP PDUs in each PDCP PDU List, the number of PDCP PDUs sent is defined by the iteration_size. (Note 4). In Step 2, SS shall receive a PDCP PDU and step 2 is repeated from k=0 to k = Maximum_PDCP_SN – 1, incremented by iteration_size. (Note1)	-	-	-	-
1	SS transmits a PDCP Data PDU containing one PDCP SDU without header compression. (Note5)	<-	PDCP Data PDU (SN = k, SN= k + iteration_size-1)	-	-
2	CHECK: Does UE transmit a PDCP Data PDU with SN=0 for the first iteration and then incremented by 1 at each iteration? (Note 2)	-->	PDCP Data PDU (SN = k)	1	P
3	SS transmits a PDCP Data PDU containing one PDCP SDU without header compression.	<-	PDCP Data PDU (SN = 0)	-	-
4	CHECK: Does UE transmit a PDCP Data PDU with SN=0?	-->	PDCP Data PDU (SN = 0)	2	P
5	SS sends a PDCP Data PDU containing one PDCP SDU without header compression.	<-	PDCP Data PDU (SN = 1)	-	-
6	CHECK: Does UE transmit a PDCP Data PDU with SN=1?	-->	PDCP Data PDU (SN = 1)	1	P
Note 1: Maximum_PDCP_SN = $2^{\lfloor \log_2(\text{pdcp-SN-SizeUL}) \rfloor} - 1$. Note 2: The verdict shall be provided each time $[(SN+1) \bmod 256 = 0]$ respectively $[(SN+1) \bmod 4096 = 0]$, if SN size is len12bits respectively len18bits. Note 3: Void Note 4: Iteration will be incremented by iteration_size of 2^6 . Small PDCP SDU size will be used and it shall be repeated FLOOR(Maximum_PDCP_SN/iteration size). Note 5: SS shall transmit a PDCP PDU list with size equal to iteration size and incrementing SN by 1 till SN = k + iteration_size-1.					

7.1.3.1.1.3.3 Specific message contents

None.

7.1.3.1.2 Maintenance of PDCP sequence numbers / User plane / 18 bit SN

7.1.3.1.2.1 Test Purpose (TP)

(1)

```
with { UE in RRC_CONNECTED state with PDCP configured for 18 bit SN }
ensure that {
```

```

when { UE transmits a PDCP Data SDU on a DRB }
then { UE increments SN with 1 for each transmitted PDU for SN=0 to Maximum_PDCP_SN (2[pdcp-SN-SizeUL]
-1) }
}

```

(2)

```

with { UE in RRC_CONNECTED state with PDCP configured for 18 bit SN }
ensure that {
when { UE transmits a PDCP Data SDU on a DRB and, after incrementation, TX_Next is larger than the
Maximum_PDCP_SN (2[pdcp-SN-SizeUL] -1) }
then { UE sets SN to 0 in the next transmitted PDCP SDU }
}

```

7.1.3.1.2.2 Conformance requirements

Same as conformance requirements in clause 7.1.3.1.1.2

7.1.3.1.2.3 Test description

7.1.3.1.2.3.1 Pre-test conditions

Same Pre-test conditions as in clause 7.1.3.0 exception of PDCP parameters according to Table 7.1.3.1.2.3.1-1.

Table 7.1.3.1.2.3.1-1: PDCP parameters

PDCP-Config pdcP-SN-SizeUL	len18bits
PDCP-Config pdcP-SN-SizeDL	len18bits

7.1.3.1.2.3.2 Test procedure sequence

Same as test procedure in clause 7.1.3.1.1.3.2

7.1.3.1.2.3.3 Specific message contents

None.

7.1.3.2 PDCP integrity protection

7.1.3.2.1 Integrity protection / Correct functionality of integrity algorithm SNOW3G / SRB / DRB

(1)

```

with { UE in RRC_CONNECTED state and SRB is configured with NR-PDCP }
ensure that {
when { Functionality of integrity algorithms with SNOW3G is taken into use on SRB }
then { UE performs correct integrity protection function in NR-PDCP entities associated with SRB }
}
}

```

(2)

```

with { UE in RRC_CONNECTED state and NOT EN-DC }
ensure that {
when { Functionality of integrity algorithms with SNOW3G is taken into use on DRB }
then { UE performs correct integrity protection function in PDCP entities associated with DRB }
}
}

```

(3)

```

with { UE in RRC_CONNECTED state and SRB3 is configured }
ensure that {
when { message on SRB 3 is received and fails the integrity protection check }
}
}

```

```

then { UE transmits SCGFailureInformationNR message with failure type 'srb3-IntegrityFailure' }
}

```

NOTE: TP2 (integrity on DRB) is not applicable to EN-DC as per 38.331 clause 6.3.2, the IE *PDCP-Config.drb.integrityProtection* is 'Cond ConnectedTo5GC'.

7.1.3.2.1.2 Conformance requirements

References: The conformance requirements covered in the present TC are specified in: TS 38.323, clauses 5.9, 5.2.2.1, TS 33.501 clauses 5.6.2, D.3.1 and TS 38.331 clauses 5.7.3.1, 5.7.3.2, 5.7.3.3. Unless otherwise stated these are Rel-15 requirements.

[TS 38.323, clause 5.9]

The integrity protection function includes both integrity protection and integrity verification and is performed in PDCP, if configured. The data unit that is integrity protected is the PDU header and the data part of the PDU before ciphering. The integrity protection is always applied to PDCP Data PDUs of SRBs. The integrity protection is applied to PDCP Data PDUs of DRBs for which integrity protection is configured. The integrity protection is not applicable to PDCP Control PDUs.

The integrity protection algorithm and key to be used by the PDCP entity are configured by upper layers TS 38.331 [3] and the integrity protection method shall be applied as specified in TS 33.501 [6].

The integrity protection function is activated by upper layers TS 38.331 [3]. When security is activated, the integrity protection function shall be applied to all PDUs including and subsequent to the PDU indicated by upper layers TS 38.331 [3] for the downlink and the uplink, respectively.

NOTE: As the RRC message which activates the integrity protection function is itself integrity protected with the configuration included in this RRC message, this message needs first be decoded by RRC before the integrity protection verification could be performed for the PDU in which the message was received.

For downlink and uplink integrity protection and verification, the parameters that are required by PDCP for integrity protection are defined in TS 33.501 [6] and are input to the integrity protection algorithm. The required inputs to the integrity protection function include the COUNT value, and DIRECTION (direction of the transmission: set as specified in TS 33.501 [6]). The parameters required by PDCP which are provided by upper layers TS 38.331 [3] are listed below:

- BEARER (defined as the radio bearer identifier in TS 33.501 [6]. It will use the value RB identity –1 as in TS 38.331 [3]);
- KEY (the integrity protection keys for the control plane and for the user plane are K_{RRCint} and K_{UPint} , respectively).

At transmission, the UE computes the value of the MAC-I field and at reception it verifies the integrity of the PDCP Data PDU by calculating the X-MAC based on the input parameters as specified above. If the calculated X-MAC corresponds to the received MAC-I, integrity protection is verified successfully.

[TS 38.323, clause 5.2.2.1]

At reception of a PDCP Data PDU from lower layers, the receiving PDCP entity shall determine the COUNT value of the received PDCP Data PDU, i.e. RCVD_COUNT, as follows:

- if $\text{RCVD_SN} < \text{SN}(\text{RX_DELIV}) - \text{Window_Size}$:
 - $\text{RCVD_HFN} = \text{HFN}(\text{RX_DELIV}) + 1$.
- else if $\text{RCVD_SN} \geq \text{SN}(\text{RX_DELIV}) + \text{Window_Size}$:
 - $\text{RCVD_HFN} = \text{HFN}(\text{RX_DELIV}) - 1$.
- else:
 - $\text{RCVD_HFN} = \text{HFN}(\text{RX_DELIV})$;
 - $\text{RCVD_COUNT} = [\text{RCVD_HFN}, \text{RCVD_SN}]$.

After determining the COUNT value of the received PDCP Data PDU = RCVD_COUNT, the receiving PDCP entity shall:

- perform deciphering and integrity verification of the PDCP Data PDU using COUNT = RCVD_COUNT;
- if integrity verification fails:
 - indicate the integrity verification failure to upper layer;
 - discard the PDCP Data PDU;
- if RCVD_COUNT < RX_DELIV; or
- if the PDCP Data PDU with COUNT = RCVD_COUNT has been received before:
 - discard the PDCP Data PDU;

[TS 33.501, clause 5.6.2]

All Identifiers and names specified in the present subclause are for 5G.

Each Integrity Algorithm used for 5G will be assigned a 4-bit identifier. The following values for integrity algorithms are defined:

- "0000₂" NIA0 Null Integrity Protection algorithm;
- "0001₂" 128-NIA1 128-bit SNOW 3G based algorithm;
- "0010₂" 128-NIA2 128-bit AES based algorithm; and
- "0011₂" 128-NIA3 128-bit ZUC based algorithm.

128-NIA1 is based on SNOW 3G (see TS35.215 [14]).

128-NIA2 is based on 128-bit AES [15] in CMAC mode [17].

128-NIA3 is based on 128-bit ZUC (see TS35.221 [18]).

Full details of the algorithms are specified in Annex D.

[TS 33.501, clause D.3.1.1]

The input parameters to the integrity algorithm are a 128-bit integrity key named KEY, a 32-bit COUNT, a 5-bit bearer identity called BEARER, the 1-bit direction of the transmission i.e. DIRECTION, and the message itself i.e. MESSAGE. The DIRECTION bit shall be 0 for uplink and 1 for downlink. The bit length of the MESSAGE is LENGTH.

Figure D.3.1.1-1 illustrates the use of the integrity algorithm NIA to authenticate the integrity of messages.

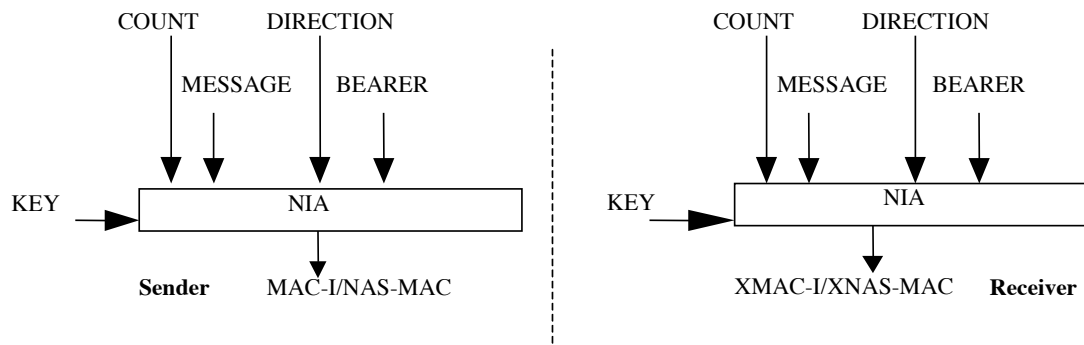

Figure D.3.1.1-1: Derivation of MAC-I/NAS-MAC (or XMAC-I/XNAS-MAC)

Based on these input parameters the sender computes a 32-bit message authentication code (MAC-I/NAS-MAC) using the integrity algorithm NIA. The message authentication code is then appended to the message when sent. For integrity protection algorithms, the receiver computes the expected message authentication code (XMAC-I/XNAS-MAC) on the message received in the same way as the sender computed its message authentication code on the message sent and verifies the data integrity of the message by comparing it to the received message authentication code, i.e. MAC-I/NAS-MAC.

[TS 38.331, clause 5.7.3.1]

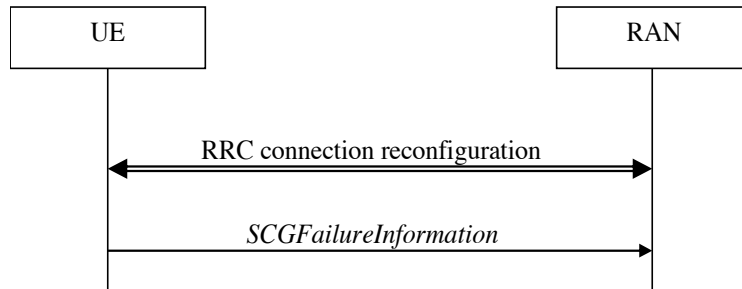

Figure 5.7.3.1-1: SCG failure information

The purpose of this procedure is to inform EUTRAN or NR MN about an SCG failure the UE has experienced i.e. SCG radio link failure, a failure of SCG reconfiguration with sync, SCG configuration failure for RRC message on SRB3, SCG integrity check failure and exceeding the maximum uplink transmission timing difference.

[TS 38.331, clause 5.7.3.2]

A UE initiates the procedure to report SCG failures when SCG transmission is not suspended and when one of the following conditions is met:

- 1> upon detecting radio link failure for the SCG, in accordance with subclause 5.3.10.3;
- 1> upon reconfiguration with sync failure of the SCG, in accordance with subclause 5.3.5.9.3;
- 1> upon SCG configuration failure, in accordance with subclause 5.3.5.9.2;
- 1> upon integrity check failure indication from SCG lower layers, in accordance with subclause 5.3.5.9.1.

Upon initiating the procedure, the UE shall:

- 1> suspend SCG transmission for all SRBs and DRBs;
- 1> reset SCG-MAC;
- 1> stop T304, if running;
- 1> if the UE is operating in EN-DC:
 - 2> initiate transmission of the *SCGFailureInformationNR* message as specified in TS 36.331 [10, 5.6.13a].

[TS 38.331, clause 5.7.3.3]

The UE shall set the SCG failure type as follows:

- ...
- 1> else, if the UE initiates transmission of the *SCGFailureInformationNR* message due to SRB3 IP check failure:
 - 2> set the failureType as srb3-IntegrityFailure;

7.1.3.2.1.3 Test description

7.1.3.2.1.3.1 Pre-test conditions

- Same Pre-test conditions as in clause 7.1.3.0 with the exception that integrity protection algorithm 'nia1 (SNOW3G)' is configured.
- For EN_DC, same Pre-test conditions as in clause 7.1.3.0 with the exception that integrity protection algorithms 'nia1 (SNOW3G)' and 'eia1 (SNOW3G)' are configured and without message condition UE TEST LOOP MODE A.
- For EN_DC or NGEN_DC, RRCConnectionReconfiguration message including MobilityControlInfo IE is transmitted on E-UTRA Cell 1 to reconfigure SRB1 and SRB2 from E-UTRA PDCP to NR PDCP.

7.1.3.2.1.3.2 Test procedure sequence

Table 7.1.3.2.1.3.2-1: Main behaviour

St	Procedure	Message Sequence		TP	Verdict
		U - S	Message		
-	EXCEPTION: Steps 1a1 to 1b2 describe behaviour that depends on UE configuration; the "lower case letter" identifies a step sequence that takes place depending on a particular configuration.	-	-	-	-
1a1	For EN-DC or NGEN-DC, the SS sends EUTRA RRC <i>UECapabilityEnquiry</i> message including <i>RAT-Type eutra-nr</i> to the UE integrity protected.	<--	RRC: <i>UECapabilityEnquiry</i>	-	-
1a2	Check: Does the UE send a EUTRA RRC <i>UECapabilityInformation</i> message integrity protected?	-->	RRC: <i>UECapabilityInformation</i>	1	P
1b1	ELSE the SS sends NR RRC <i>UECapabilityEnquiry</i> message to the UE.	<--	NR RRC: <i>UECapabilityEnquiry</i>	-	-
1b2	Check: Does the UE send a NR RRC <i>UECapabilityInformation</i> message?	-->	NR RRC: <i>UECapabilityInformation</i>	1	P
-	EXCEPTION: Steps 2a1-2a4 describe behaviour that depends on UE configuration; the "lower case letter" identifies a step sequence that takes place if SRB3 is configured	-	-	-	-
2a1	For EN-DC or NGEN-DC, IF <i>pc_srb3</i> then the SS transmits an <i>RRCReconfiguration</i> message to reconfigure NR MAC, sent on SRB3 integrity protected. Note 1	<--	<i>RRCReconfiguration</i>	-	-
2a2	Check: Does the UE transmit an <i>RRCReconfigurationComplete</i> message on SRB3 integrity protected?	-->	<i>RRCReconfigurationComplete</i>	1	P
2a3	The SS sends <i>RRCReconfiguration</i> message to the UE integrity protected on SRB3. The MAC-I is corrupted so as to result in integrity failure at UE.	<--	<i>RRCReconfiguration</i>	-	-
2a4	Check: Does the UE send <i>SCGFailureInformationNR</i> with failureType 'srb3-IntegrityFailure' on SRB1?	-->	<i>SCGFailureInformationNR</i>	3	P
-	EXCEPTION: Steps 3a1-3a2 describe behaviour that depends on whether 5GC is being emulated; the "lower case letter" identifies a step sequence that takes place if 5GC is being emulated.	-	-	-	-
3a1	SS transmits PDCP PDU on DRB integrity protected.	<--	PDCP PDU	-	-
3a2	Check: Does the UE transmit looped back PDCP PDU integrity protected on DRB?	-->	PDCP PDU	2	P
Note 1: For EN-DC the NR RRCReconfiguration is contained in <i>RRCCConnectionReconfiguration</i> Table 7.1.3.2.1.3.3-1					

7.1.3.2.1.3.3 Specific message contents

Table 7.1.3.2.1.3.3-1: RRCConnectionReconfiguration (Preamble for EN-DC or NGEN-DC)

Derivation Path: 36.508 [7] Table 4.6.1-8			
Information Element	Value/remark	Comment	Condition
RRCConnectionReconfiguration ::= SEQUENCE {			
criticalExtensions CHOICE {			
c1 CHOICE{			
rrcConnectionReconfiguration-r8 ::= SEQUENCE			
{			
mobilityControlInfo	MobilityControlInfo-HO-SameCell	As per Table 7.1.3.2.1.3.3-1A	
nonCriticalExtension ::= SEQUENCE {			
nonCriticalExtension ::= SEQUENCE {			
nonCriticalExtension ::= SEQUENCE {			
nonCriticalExtension ::= SEQUENCE {			
nonCriticalExtension ::= SEQUENCE {			
nonCriticalExtension ::= SEQUENCE {			
nonCriticalExtension ::= SEQUENCE {			
nr-Config-r15 CHOICE {			
setup SEQUENCE {			
nr-SecondaryCellGroupConfig-r15	OCTET STRING including the RRCReconfiguration message according to TS 38.508-1 [4], table 4.6.1-13 with condition EN-DC_HO		
}			
}			
sk-Counter-r15	Increment the value by 1 from the previous value		
nr-RadioBearerConfig1-r15	OCTET STRING including RadioBearerConfig according TS 38.508-1 [4], Table 4.6.3-132 with conditions EN-DC_DRB and Re-establish_PDCP		
nr-RadioBearerConfig1-r15	OCTET STRING including RadioBearerConfig according TS 38.508-1 [4], Table 4.6.3-132 with conditions EN-DC_DRB and Re-establish_PDCP and SRB3		SRB3
nr-RadioBearerConfig2-r15	OCTET STRING including RadioBearerConfig according TS 38.508-1 [4], table 4.6.3-132 with condition SRB_NR_PDCP		
}			
}			
}			
}			
}			
}			
}			
}			
}			
}			
}			
}			

}			
Condition	Explanation		
SRB3	Establishment of SRB3		

Table 7.1.3.2.1.3.3-1A: *MobilityControlInfo-HO-SameCell* (Table 7.1.3.2.1.3.3-1)

Derivation Path: 36.508 [7], Table 4.6.5-1			
Information Element	Value/remark	Comment	Condition
MobilityControlInfo-HO ::= SEQUENCE {			
targetPhysCellId	PhysicalCellIdentity of E-UTRA Cell 1		
carrierFreq	Not present		
}			

Table 7.1.3.2.1.3.3-2: *MAC-CellGroupConfig* (step 2a1, Table 7.1.3.2.1.3.2-1)

Derivation Path: TS 38.508-1 [4], Table 4.6.3-68			
Information Element	Value/remark	Comment	Condition
MAC-CellGroupConfig ::= SEQUENCE {			
bsr-Config SEQUENCE {			
periodicBSR-Timer	sf10	Different from default	
}			
}			

Table 7.1.3.2.1.3.3-3: *SCGFailureInformationNR* message (step 2a4, Table 7.1.3.2.1.3.2-1)

Derivation Path: 36.508 [7], Table 4.6.1-18AA			
Information Element	Value/remark	Comment	Condition
SCGFailureInformationNR-r15 ::= SEQUENCE {			
criticalExtensions CHOICE {			
c1 CHOICE {			
scgFailureInformationNR-r15 SEQUENCE {			
failureReportSCG-NR-r15 SEQUENCE {			
failureType-r15	srB3-IntegrityFailure		
measResultFreqListNR-r15	Not checked		
measResultSCG-r15	Not checked		
}			
nonCriticalExtension SEQUENCE {}			
}			
}			
}			

Table 7.1.3.2.1.3.3-4: *RRCReconfiguration* (Preamble for NR/5GC)

Derivation Path: TS 38.508-1 [4], Table 4.6.1-13 with condition NR			
Information Element	Value/remark	Comment	Condition
RRCReconfiguration ::= SEQUENCE {			
criticalExtensions CHOICE {			
rrcReconfiguration ::= SEQUENCE {			
radioBearerConfig	RadioBearerConfig-IntegrityOnDRB		
}			
}			
}			

Table 7.1.3.2.1.3.3-5: RadioBearerConfig-IntegrityOnDRB (Preamble for NR/5GC)

Derivation Path: TS 38.508-1 [4], Table 4.6.3-132 with conditions SRB2 and DRB1			
Information Element	Value/remark	Comment	Condition
RadioBearerConfig ::= SEQUENCE {			
drb-ToAddModList SEQUENCE (SIZE (1..maxDRB))	1 entry	Primary DRB as per Table 7.1.3.0-2	DRB1
OF DRB-ToAddMod {			
DRB-ToAddMod[1] SEQUENCE {		entry 1	
cnAssociation CHOICE {			
sdap-Config	SDAP-Config		
}			
drb-Identity	DRB-Identity using condition DRB1		
reestablishPDCP	Not present		
recoverPDCP	Not present		
pdcpc-Config	PDCP-Config-IntegrityOnDRB		
}			
}			
}			

Table 7.1.3.2.1.3.3-6: PDCP-Config-IntegrityOnDRB (Preamble for NR/5GC)

Derivation Path: TS 38.508-1 [4], Table 4.6.3-99			
Information Element	Value/remark	Comment	Condition
PDCP-Config ::= SEQUENCE {			
drb SEQUENCE {			
discardTimer	infinity		
pdcpc-SN-Size-UL	len18bits		
pdcpc-SN-Size-DL	len18bits		
headerCompression CHOICE {			
notUsed	NULL		
}			
integrityProtection	enabled		
statusReportRequired	true		
outOfOrderDelivery	Not present		
}			
moreThanOneRLC	Not present		
t-Reordering	Not present		
}			

7.1.3.2.2 Integrity protection / Correct functionality of integrity algorithm AES / SRB / DRB

7.1.3.2.2.1 Test Purpose (TP)

(1)

```
with { UE in RRC_CONNECTED state and SRB is configured with NR-PDCP }
ensure that {
  when { Functionality of integrity algorithms with AES is taken into use on SRB }
  then { UE performs correct integrity protection function in NR-PDCP entity associated with SRB }
}
```

(2)

```
with { UE in RRC_CONNECTED state and NOT EN-DC }
ensure that {
  when { Functionality of integrity algorithms with AES is taken into use on DRB }
  then { UE performs correct integrity protection function in PDCP entities associated with DRB }
}
```

(3)

```

with { UE in RRC_CONNECTED state and SRB3 is configured }
ensure that {
  when { message on SRB 3 is received and fails the integrity protection check }
  then { UE transmits SCGFailureInformationNR message with failure type as srb3-IntegrityFailure }
}

```

NOTE: TP2 (integrity on DRB) is not applicable to EN-DC as per TS 38.331 [12] clause 6.3.2, the IE *PDCP-Config.drb.integrityProtection* is 'Cond ConnectedTo5GC'.

7.1.3.2.2.2 Conformance requirements

Same conformance requirements as in clause 7.1.3.2.1.2

7.1.3.2.2.3 Test description

7.1.3.2.2.3.1 Pre-test conditions

Same Pre-test conditions as in clause 7.1.3.2.1.3.1 except that integrity protection algorithm 'nia2 (AES)' and 'eia2 (AES)' is configured.

7.1.3.2.2.3.2 Test procedure sequence

Same test procedure sequence as in clause 7.1.3.2.1.3.2.

7.1.3.2.2.3.3 Specific message contents

Same specific message contents as in clause 7.1.3.2.1.3.3 except for integrity protection algorithm 'nia2 (AES)' and 'eia2 (AES)'.

7.1.3.2.3 Integrity protection / Correct functionality of integrity algorithm ZUC / SRB / DRB

(1)

```

with { UE in RRC_CONNECTED state and SRB is configured with NR-PDCP }
ensure that {
  when { Functionality of integrity algorithms with ZUC is taken into use on SRB }
  then { UE performs correct integrity protection function in NR-PDCP entities associated with SRB }
}

```

(2)

```

with { UE in RRC_CONNECTED state and NOT EN-DC }
ensure that {
  when { Functionality of integrity algorithms with ZUC is taken into use on DRB }
  then { UE performs correct integrity protection function in PDCP entities associated with DRB }
}

```

(3)

```

with { UE in RRC_CONNECTED state and SRB3 is configured }
ensure that {
  when { message on SRB 3 is received and fails the integrity protection check }
  then { UE transmits SCGFailureInformationNR message with failure type as srb3-IntegrityFailure }
}

```

NOTE: TP2 (integrity on DRB) is not applicable to EN-DC as per TS 38.331 [12] clause 6.3.2, the IE *PDCP-Config.drb.integrityProtection* is 'Cond ConnectedTo5GC'.

7.1.3.2.3.2 Conformance requirements

Same conformance requirements as in clause 7.1.3.2.1.2.

7.1.3.2.3.3 Test description

7.1.3.2.3.3.1 Pre-test conditions

Same Pre-test conditions as in clause 7.1.3.2.1.3.1 except that integrity protection algorithm 'nia3 (ZUC)' and 'eia3 (ZUC)' is configured.

7.1.3.2.3.3.2 Test procedure sequence

Same test procedure sequence as in clause 7.1.3.2.1.3.2.

7.1.3.2.3.3.3 Specific message contents

Same specific message contents as in clause 7.1.3.2.1.3.3 except integrity protection algorithm 'nia3 (ZUC)' and 'eia3 (ZUC)'.

7.1.3.3 PDCP Ciphering and deciphering

7.1.3.3.1 Ciphering and deciphering / Correct functionality of encryption algorithm SNOW3G / SRB / DRB

7.1.3.3.1.1 Test Purpose (TP)

(1)

(1)

```
with { UE in RRC_CONNECTED state and SRB is configured with NR-PDCP }
ensure that {
  when { Functionality of encryption algorithms with SNOW3G is taken into use on SRB }
  then { UE performs correct ciphering/deciphering function in NR-PDCP entity associated with SRB }
}
```

(2)

```
with { UE in RRC_CONNECTED state }
ensure that {
  when { Functionality of encryption algorithms with SNOW3G is taken into use on DRB }
  then { UE performs correct ciphering/deciphering function in NR-PDCP entity associated with DRB }
}
```

7.1.3.3.1.2 Conformance requirements

References: The conformance requirements covered in the present TC are specified in: TS 38.323 clause 5.8, TS 33.501 clauses 5.6.1, D.2.1.1 and TS 36.331 clause 6.3.2. Unless otherwise stated these are Rel-15 requirements.

[TS 38.323, clause 5.8]

The ciphering function includes both ciphering and deciphering and is performed in PDCP, if configured. The data unit that is ciphered is the data part of the PDCP Data PDU (see subclause 6.3.3) except the SDAP header if included in the PDCP SDU, and the MAC-I (see subclause 6.3.4). The ciphering is not applicable to PDCP Control PDUs.

The ciphering algorithm and key to be used by the PDCP entity are configured by upper layers TS 38.331 [3] and the ciphering method shall be applied as specified in TS 33.501 [6].

The ciphering function is activated by upper layers TS 38.331 [3]. When security is activated, the ciphering function shall be applied to all PDCP Data PDUs indicated by upper layers TS 38.331 [3] for the downlink and the uplink, respectively.

For downlink and uplink ciphering and deciphering, the parameters that are required by PDCP for ciphering are defined in TS 33.501 [6] and are input to the ciphering algorithm. The required inputs to the ciphering function include the

COUNT value, and DIRECTION (direction of the transmission: set as specified in TS 33.501 [6]). The parameters required by PDCP which are provided by upper layers TS 38.331 [3] are listed below:

- BEARER (defined as the radio bearer identifier in TS 33.501 [6]. It will use the value RB identity –1 as in TS 38.331 [3]);
- KEY (the ciphering keys for the control plane and for the user plane are K_{RRCEnc} and K_{UPenc} , respectively).

[TS 33.501, clause 5.6.1]

All Identifiers and names specified in this subclause are for 5G.

Each Encryption Algorithm used for 5G will be assigned a 4-bit identifier. The following values for ciphering algorithms are defined:

- | | | |
|----------------------|----------|----------------------------------|
| "0000 ₂ " | NEA0 | Null ciphering algorithm; |
| "0001 ₂ " | 128-NEA1 | 128-bit SNOW 3G based algorithm; |
| "0010 ₂ " | 128-NEA2 | 128-bit AES based algorithm; and |
| "0011 ₂ " | 128-NEA3 | 128-bit ZUC based algorithm. |

128-NEA1 is based on SNOW 3G (see TS35.215 [14]).

128-NEA2 is based on 128-bit AES [15] in CTR mode [16].

128-NEA3 is based on 128-bit ZUC (see TS35.221 [18]).

Full details of the algorithms are specified in Annex D.

[TS 33.501, clause D.2.1.1]

The input parameters to the ciphering algorithm are a 128-bit cipher key named KEY, a 32-bit COUNT, a 5-bit bearer identity BEARER, the 1-bit direction of the transmission i.e. DIRECTION, and the length of the keystream required i.e. LENGTH. The DIRECTION bit shall be 0 for uplink and 1 for downlink.

Editor's Note: For NAS layer security, the inputs may need to change depending on the solution that is selected for having simultaneous NAS connections for 3GPP and non-3GPP.

Figure D.2.1.1-1 illustrates the use of the ciphering algorithm NEA to encrypt plaintext by applying a keystream using a bit per bit binary addition of the plaintext and the keystream. The plaintext may be recovered by generating the same keystream using the same input parameters and applying a bit per bit binary addition with the ciphertext.

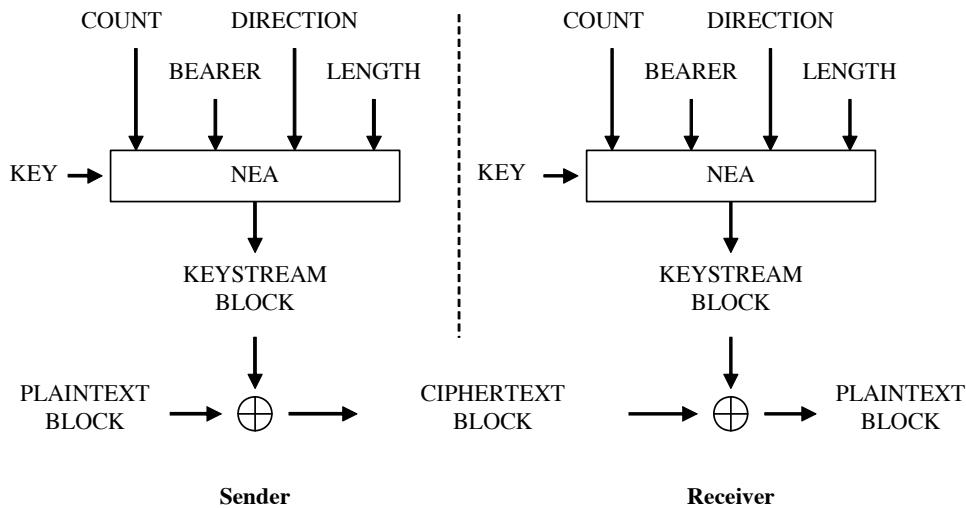

Figure D.2.1.1-1: Ciphering of data

Based on the input parameters the algorithm generates the output keystream block KEYSTREAM which is used to encrypt the input plaintext block PLAINTEXT to produce the output ciphertext block CIPHERTEXT.

The input parameter LENGTH shall affect only the length of the KEYSTREAM BLOCK, not the actual bits in it.

[TS 36.331, clause 6.3.3]

The IE *SecurityAlgorithmConfig* is used to configure AS integrity protection algorithm (SRBs) and AS ciphering algorithm (SRBs and DRBs).

...

SecurityAlgorithmConfig field descriptions
<p>cipheringAlgorithm Indicates the ciphering algorithm to be used for SRBs and DRBs, as specified in TS 33.501 [11]. The algorithms nea0-nea3 are identical to the LTE algorithms eea0-3. For EN-DC, the algorithms configured for bearers using KeNB shall be the same as for all bearers using KeNB.</p>
<p>integrityProtAlgorithm For EN-DC, this IE indicates the integrity protection algorithm to be used for SRBs, as specified in TS 33.501 [11]. The algorithms nia0-nia3 is identical to the LTE algorithms eia0-3. For EN-DC, the algorithms configured for SRBs using KeNB shall be the same as for all SRBs using KeNB.</p>

7.1.3.3.1.3 Test description

7.1.3.3.1.3.1 Pre-test conditions

- Same Pre-test conditions as in clause 7.1.3.0 with the exception that ciphering algorithm ‘nea1 (SNOW3G)’ is configured.
- For EN_DC or NGEN_DC, same Pre-test conditions as in clause 7.1.3.0 with the exception that ciphering algorithms ‘eea1 (SNOW3G)’ and ‘nea1 (SNOW3G)’ are configured, then RRCConnectionReconfiguration message including MobilityControlInfo IE is transmitted on E-UTRA Cell 1 to reconfigure SRB1, SRB2 and MCG DRB from E-UTRA PDCP to NR PDCP.

7.1.3.3.1.3.2 Test procedure sequence

Table 7.1.3.3.1.3.2-1: Main behaviour

St	Procedure	Message Sequence		TP	Verdict
		U – S	Message		
-	Exception steps 1a1 to 1b2 depends on UE configuration.	-	-	-	-
1a1	For EN-DC or NGEN-DC, the SS sends EUTRA RRC <i>UECapabilityEnquiry</i> including <i>RAT-Type eutra</i> message to the UE.	<--	RRC: <i>UECapabilityEnquiry</i>	-	-
1a2	Check: Does the UE send a EUTRA RRC <i>UECapabilityInformation</i> message?	-->	RRC: <i>UECapabilityInformation</i>	1	P
1b1	ELSE the SS sends NR RRC <i>UECapabilityEnquiry</i> message to the UE.	<--	NR RRC: <i>UECapabilityEnquiry</i>	-	-
1b2	Check: Does the UE send a NR RRC <i>UECapabilityInformation</i> message?	-->	NR RRC: <i>UECapabilityInformation</i>	1	P
-	EXCEPTION: steps 2a1-2a2 depends on UE configuration, executed if SCG DRB is configured	-	-	-	-
2a1	For EN-DC or NGEN-DC, SS transmits PDCP PDU on SCG DRB ciphered.	<--	PDCP PDU	-	-
2a2	Check: Does the UE transmit looped back PDCP PDU ciphered on SCG DRB?	-->	PDCP PDU	2	P
3	SS transmits PDCP PDU on MCG DRB ciphered.	<--	PDCP PDU	-	-
4	Check: Does the UE transmit looped back PDCP PDU ciphered on MCG DRB?	-->	PDCP PDU	2	P

Table 7.1.3.3.1.3.3-2: MobilityControlInfo-HO-SameCell (Table 7.1.3.3.1.3.3-1)

Derivation Path: 36.508 [7], Table 4.6.5-1			
Information Element	Value/remark	Comment	Condition
MobilityControlInfo-HO ::= SEQUENCE {			
targetPhysCellId	PhysicalCellIdentity of E-UTRA Cell 1		
carrierFreq	Not present		
}			

Table 7.1.3.3.1.3.3-3: RadioResourceConfigDedicated-DRB-Rel-Add (Table 7.1.3.3.1.3.3-1)

Derivation Path: 36.508 [7], Table 4.6.3-19AAAAAD			
Information Element	Value/remark	Comment	Condition
RadioResourceConfigDedicated-SRB2-DRB ::= SEQUENCE {			
srb-ToAddModList	Not present		
drb-ToAddModList SEQUENCE (SIZE (1..maxDRB)) OF DRB-ToAddMod {	1 entry		
drb-ToAddMod[1]	DRB-ToAddMod-DEFAULT (8) using condition AM except pdcp-Config not included	entry 1 See TS 36.508 subclause 4.8.2	
}			
drb-ToReleaseList SEQUENCE (SIZE (1..maxDRB)) OF DRB-Identity {	1 entry		
DRB-Identity[1]	8	entry 1 Same as the DRB Identity associated with the default EPS bearer	
}			
}			

7.1.3.3.2 Ciphering and deciphering / Correct functionality of encryption algorithm AES / SRB / DRB

7.1.3.3.2.1 Test Purpose (TP)

(1)

```
with { UE in RRC_CONNECTED state and SRB is configured with NR-PDCP }
ensure that {
  when { Functionality of encryption algorithms with AES is taken into use on SRB }
  then { UE performs correct ciphering/deciphering function in NR-PDCP entity associated with SRB }
}
```

(2)

```
with { UE in RRC_CONNECTED state }
ensure that {
  when { Functionality of encryption algorithms with AES is taken into use on DRB }
  then { UE performs correct ciphering/deciphering function in NR-PDCP entity associated with DRB }
}
```

7.1.3.3.2.2 Conformance requirements

Same conformance requirement as in clause 7.1.3.3.1.2.

7.1.3.3.2.3 Test description

7.1.3.3.2.3.1 Pre-test conditions

Same Pre-test conditions as in clause 7.1.3.3.1.3.1 with the exception that ciphering algorithm ‘nea2 (AES)’ and ‘eea2 (AES)’ is configured.

7.1.3.3.2.3.2 Test procedure sequence

Same Test procedure sequence as in clause 7.1.3.3.1.3.2

7.1.3.3.2.3.3 Specific message contents

None

7.1.3.3.3 Ciphering and deciphering / Correct functionality of encryption algorithm ZUC / SRB / DRB

7.1.3.3.3.1 Test Purpose (TP)

(1)

```
with { UE in RRC_CONNECTED state and SRB is configured with NR-PDCP}
ensure that {
  when { Functionality of encryption algorithms with ZUC is taken into use on SRB }
  then { UE performs correct ciphering/deciphering function in NR-PDCP entity associated with SRB }
}
```

(2)

```
with { UE in RRC_CONNECTED state and DRB is configured with NR-PDCP}
ensure that {
  when { Functionality of encryption algorithms with ZUC is taken into use on DRB }
  then { UE performs correct ciphering/deciphering function in NR-PDCP entity associated with DRB }
}
```

7.1.3.3.3.2 Conformance requirements

Same conformance requirement as in clause 7.1.3.3.1.2.

7.1.3.3.3.3 Test description

7.1.3.3.3.3.1 Pre-test conditions

Same Pre-test conditions as in clause 7.1.3.3.1.3.1 with the exception that ciphering algorithm ‘nea3 (ZUC)’ and ‘eea3 (ZUC)’ is configured.

7.1.3.3.3.3.2 Test procedure sequence

Same Test procedure sequence as in clause 7.1.3.3.1.3.2.

7.1.3.3.3.3.3 Specific message contents

None

7.1.3.4 PDCP Handover

7.1.3.4.1 PDCP handover / Lossless handover / PDCP sequence number maintenance / PDCP status report to convey the information on missing or acknowledged PDCP SDUs at handover / In-order delivery and duplicate elimination in the downlink

7.1.3.4.1.1 Test Purpose (TP)

(1)

```
with { UE in RRC_CONNECTED state with default RB using RLC-AM }
ensure that {
  when { UE is requested to make a lossless handover by SS }
  then { UE creates a PDCP status report to SS }
}
```

(2)

```
with { UE in RRC_CONNECTED state with default RB using RLC-AM }
ensure that {
  when { UE is requested to make a lossless handover by SS }
  then { UE retransmits the unacknowledged data }
}
```

(3)

```
with { UE in RRC_CONNECTED state with default RB using RLC-AM }
ensure that {
  when { UE is requested to make a lossless handover by SS }
  then { UE achieves in-order delivery and discards a PDCP PDU already received in the downlink }
}
```

7.1.3.4.1.2 Conformance requirements

References: The conformance requirements covered in the present test case are specified in: TS 38.323, clauses 5.1.2, 5.2.2.1, 5.3, 5.4.1, 5.4.2 and 7.1. Unless otherwise stated these are Rel-15 requirements.

[TS 38.323, clause 5.1.2]

When upper layers request a PDCP entity re-establishment, the UE shall additionally perform once the procedures described in this section. After performing the procedures in this section, the UE shall follow the procedures in subclause 5.2.

When upper layers request a PDCP entity re-establishment, the transmitting PDCP entity shall:

- for UM DRBs and AM DRBs, reset the header compression protocol for uplink and start with an IR state in U-mode (as defined in RFC 3095 [8] and RFC 4815 [9]) if *drb-ContinueROHC* is not configured in TS 38.331 [3];
- for UM DRBs and SRBs, set TX_NEXT to the initial value;
- for SRBs, discard all stored PDCP SDUs and PDCP PDUs;
- apply the ciphering algorithm and key provided by upper layers during the PDCP entity re-establishment procedure;
- apply the integrity protection algorithm and key provided by upper layers during the PDCP entity re-establishment procedure;
- for UM DRBs, for each PDCP SDU already associated with a PDCP SN but for which a corresponding PDU has not previously been submitted to lower layers:
 - consider the PDCP SDUs as received from upper layer;
 - perform transmission of the PDCP SDUs in ascending order of the COUNT value associated to the PDCP SDU prior to the PDCP re-establishment without restarting the *discardTimer*, as specified in subclause 5.2.1;

- for AM DRBs, from the first PDCP SDU for which the successful delivery of the corresponding PDCP Data PDU has not been confirmed by lower layers, perform retransmission or transmission of all the PDCP SDUs already associated with PDCP SNs in ascending order of the COUNT values associated to the PDCP SDU prior to the PDCP entity re-establishment as specified below:
 - perform header compression of the PDCP SDU as specified in the subclause 5.7.4;
 - perform integrity protection and ciphering of the PDCP SDU using the COUNT value associated with this PDCP SDU as specified in the subclause 5.9 and 5.8;
 - submit the resulting PDCP Data PDU to lower layer, as specified in subclause 5.2.1.

When upper layers request a PDCP entity re-establishment, the receiving PDCP entity shall:

- process the PDCP Data PDUs that are received from lower layers due to the re-establishment of the lower layers, as specified in the subclause 5.2.2.1;
- for SRBs, discard all stored PDCP SDUs and PDCP PDUs;
- for SRBs and UM DRBs, if *t-Reordering* is running:
 - stop and reset *t-Reordering*;
 - for UM DRBs, deliver all stored PDCP SDUs to the upper layers in ascending order of associated COUNT values after performing header decompression;
- for AM DRBs, perform header decompression for all stored PDCP SDUs if *drb-ContinueROHC* is not configured in TS 38.331 [3];
- for UM DRBs and AM DRBs, reset the header compression protocol for downlink and start with NC state in U-mode (as defined in RFC 3095 [8] and RFC 4815 [9]) if *drb-ContinueROHC* is not configured in TS 38.331 [3];
- for UM DRBs and SRBs, set RX_NEXT and RX_DELIV to the initial value;
- apply the ciphering algorithm and key provided by upper layers during the PDCP entity re-establishment procedure;
- apply the integrity protection algorithm and key provided by upper layers during the PDCP entity re-establishment procedure.

[TS 38.323, clause 5.2.2.1]

In this section, following definitions are used:

- HFN(State Variable): the HFN part (i.e. the number of most significant bits equal to HFN length) of the State Variable;
- SN(State Variable): the SN part (i.e. the number of least significant bits equal to PDCP SN length) of the State Variable;
- RCVD_SN: the PDCP SN of the received PDCP Data PDU, included in the PDU header;
- RCVD_HFN: the HFN of the received PDCP Data PDU, calculated by the receiving PDCP entity;
- RCVD_COUNT: the COUNT of the received PDCP Data PDU = [RCVD_HFN, RCVD_SN].

At reception of a PDCP Data PDU from lower layers, the receiving PDCP entity shall determine the COUNT value of the received PDCP Data PDU, i.e. RCVD_COUNT, as follows:

- if $RCVD_SN < SN(RX_DELIV) - Window_Size$:
 - $RCVD_HFN = HFN(RX_DELIV) + 1$.
- else if $RCVD_SN \geq SN(RX_DELIV) + Window_Size$:
 - $RCVD_HFN = HFN(RX_DELIV) - 1$.
- else:

- RCVD_HFN = HFN(RX_DELIV);
- RCVD_COUNT = [RCVD_HFN, RCVD_SN].

After determining the COUNT value of the received PDCP Data PDU = RCVD_COUNT, the receiving PDCP entity shall:

- perform deciphering and integrity verification of the PDCP Data PDU using COUNT = RCVD_COUNT;
- if integrity verification fails:
 - indicate the integrity verification failure to upper layer;
 - discard the PDCP Data PDU;
- if RCVD_COUNT < RX_DELIV; or
- if the PDCP Data PDU with COUNT = RCVD_COUNT has been received before:
 - discard the PDCP Data PDU;

If the received PDCP Data PDU with COUNT value = RCVD_COUNT is not discarded above, the receiving PDCP entity shall:

- store the resulting PDCP SDU in the reception buffer;
- if RCVD_COUNT >= RX_NEXT:
 - update RX_NEXT to RCVD_COUNT + 1.
- if *outOfOrderDelivery* is configured:
 - deliver the resulting PDCP SDU to upper layers.
- if RCVD_COUNT = RX_DELIV:
 - deliver to upper layers in ascending order of the associated COUNT value after performing header decompression, if not decompressed before;
 - all stored PDCP SDU(s) with consecutively associated COUNT value(s) starting from COUNT = RX_DELIV;
 - update RX_DELIV to the COUNT value of the first PDCP SDU which has not been delivered to upper layers, with COUNT value > RX_DELIV;
- if *t-Reordering* is running, and if RX_DELIV >= RX_REORD:
 - stop and reset *t-Reordering*.
- if *t-Reordering* is not running (includes the case when *t-Reordering* is stopped due to actions above), and RX_DELIV < RX_NEXT:
 - update RX_REORD to RX_NEXT;
- start *t-Reordering*.

[TS 38.323, clause 5.3]

When the *discardTimer* expires for a PDCP SDU, or the successful delivery of a PDCP SDU is confirmed by PDCP status report, the transmitting PDCP entity shall discard the PDCP SDU along with the corresponding PDCP Data PDU. If the corresponding PDCP Data PDU has already been submitted to lower layers, the discard is indicated to lower layers.

For SRBs, when upper layers request a PDCP SDU discard, the PDCP entity shall discard all stored PDCP SDUs and PDCP PDUs.

NOTE: Discarding a PDCP SDU already associated with a PDCP SN causes a SN gap in the transmitted PDCP Data PDUs, which increases PDCP reordering delay in the receiving PDCP entity. It is up to UE implementation how to minimize SN gap after SDU discard.

[TS 38.323, clause 5.4.1]

For AM DRBs configured by upper layers to send a PDCP status report in the uplink (*statusReportRequired* in TS 38.331 [3]), the receiving PDCP entity shall trigger a PDCP status report when:

- upper layer requests a PDCP entity re-establishment;
- upper layer requests a PDCP data recovery.

If a PDCP status report is triggered, the receiving PDCP entity shall:

- compile a PDCP status report as indicated below by:
 - setting the FMC field to RX_DELIV;
 - if $RX_DELIV < RX_NEXT$:
 - allocating a Bitmap field of length in bits equal to the number of COUNTs from and not including the first missing PDCP SDU up to and including the last out-of-sequence PDCP SDUs, rounded up to the next multiple of 8, or up to and including a PDCP SDU for which the resulting PDCP Control PDU size is equal to 9000 bytes, whichever comes first;
 - setting in the bitmap field as '0' for all PDCP SDUs that have not been received, and optionally PDCP SDUs for which decompression have failed;
 - setting in the bitmap field as '1' for all PDCP SDUs that have been received;
- submit the PDCP status report to lower layers as the first PDCP PDU for transmission via the transmitting PDCP entity as specified in subclause 5.2.1..

[TS 38.323, clause 5.4.2]

For AM DRBs, when a PDCP status report is received in the downlink, the transmitting PDCP entity shall:

- consider for each PDCP SDU, if any, with the bit in the bitmap set to '1', or with the associated COUNT value less than the value of FMC field as successfully delivered, and discard the PDCP SDU as specified in the subclause 5.3.

[TS 38.323, clause 7.1]

This sub clause describes the state variables used in PDCP entities in order to specify the PDCP protocol. The state variables defined in this subclause are normative.

All state variables are non-negative integers, and take values from 0 to $[2^{32} - 1]$.

PDCP Data PDUs are numbered integer sequence numbers (SN) cycling through the field: 0 to $[2^{pdcp-SN-Size} - 1]$.

The transmitting PDCP entity shall maintain the following state variables:

a) TX_NEXT

This state variable indicates the COUNT value of the next PDCP SDU to be transmitted. The initial value is 0.

The receiving PDCP entity shall maintain the following state variables:

a) RX_NEXT

This state variable indicates the COUNT value of the next PDCP SDU expected to be received. The initial value is 0.

b) RX_DELIV

This state variable indicates the COUNT value of the first PDCP SDU not delivered to the upper layers, but still waited for. The initial value is 0.

c) RX_REORD

This state variable indicates the COUNT value following the COUNT value associated with the PDCP Data PDU which triggered *t-Reordering*.

7.1.3.4.1.3 Test description

7.1.3.4.1.3.1 Pre-test conditions

Same Pre-test conditions as in clause 7.1.3.0 except the following:

- 2 NR cells (NR Cell 1 and NR Cell 2) are configured with DRBs in RLC AM mode.
- The cell power levels are configured as per the Table 7.1.3.4.1.3.1-1.
- DRB of NR Cell 1 is configured according to Table 7.1.3.4.1.3.1-3.

Table 7.1.3.4.1.3.1-1: Time instances of cell power level in FR1

	Parameter	Unit	EUTRA Cell 1	NR Cell 1	NR Cell 2	Remark
T0	Cell-specific RS EPRE	dBm/SCS	-85	-	-	
	SS/PBCH SSS EPRE	dBm/SCS	-	-88	Off	
T1	Cell-specific RS EPRE	dBm/SCS	-85	-	-	
	SS/PBCH SSS EPRE	dBm/SCS	-	-88	-82	
T2	Cell-specific RS EPRE	dBm/SCS	-85	-	-	
	SS/PBCH SSS EPRE	dBm/SCS	-	-82	-88	

Table 7.1.3.4.1.3.1-2: Time instances of cell power level in FR2

	Parameter	Unit	EUTRA Cell 1	NR Cell 1	NR Cell 2	Remark
T0	Cell-specific RS EPRE	dBm/SCS	-96	-	-	
	SS/PBCH SSS EPRE	dBm/SCS	-	-91	Off	
T1	Cell-specific RS EPRE	dBm/SCS	-96	-	-	
	SS/PBCH SSS EPRE	dBm/SCS	-	-91	-82	
T2	Cell-specific RS EPRE	dBm/SCS	-96	-	-	
	SS/PBCH SSS EPRE	dBm/SCS	-	-82	-91	

Table 7.1.3.4.1.3.1-3: RLC parameters

<i>t-PollRetransmit</i>	ms150
-------------------------	-------

7.1.3.4.1.3.2 Test procedure sequence

Table 7.1.3.4.1.3.2-1: Main behaviour

St	Procedure	Message Sequence		TP	Verdict
		U - S	Message		
1	The SS creates 5 PDCP Data PDUs and the TX_NEXT is set to "0".	-	-	-	-
-	EXCEPTION: Step 2 and 3 shall be repeated for k=0 to 1(increment=1).	-	-	-	-
2	The SS sends the PDCP Data PDU#k via RLC-AM RB with the following content to the UE: D/C field = 1 (PDCP Data PDU) and PDCP SN = k on NR Cell 1. After having sent a PDU, the SS set TX_NEXT = k+1.	<-	PDCP PDU DATA #k	-	-
3	The UE sends the PDCP Data PDU#k via RLC-AM RB with the following content to the UE: D/C field = 1 (PDCP Data PDU) and PDCP SN = k on NR Cell 1. Data is previously received data from PDU #k. (Note 1)	-->	PDCP PDU DATA #k	-	-
3A	The SS changes NR Cell 2 parameters according to the row "T1" in table 7.1.3.4.1.3.1-1(FR1) / 7.1.3.4.1.3.1-2(FR2).				
-	EXCEPTION: Step 4 to 6 shall be repeated for m=2 to 4 (increment=1).	-	-	-	-
4	The SS is configured on NR Cell 1 not to send RLC acknowledgement (RLC ACK) to the next received RLC SDU to the UE.	-	-	-	-
5	The SS sends the PDCP Data PDU #m via RLC-AM RB with the following content to the UE: D/C field = 1 (PDCP Data PDU) and PDCP SN =m. After having sent a PDU, the SS set TX_NEXT = m+1. (Note 6)	<-	PDCP PDU DATA #m	-	-
6	The UE sends the PDCP Data PDU#m via RLC-AM RB with the following content to the UE: D/C field = 1 (PDCP Data PDU) and PDCP SN = m. Data is previously received data from PDU #m. (Note 2)	-->	PDCP PDU DATA #m	-	-
6A	Configure SS not to allocate UL grant to the UE in NR Cell 1				
7	Void	-	-	-	-
8	The SS transmits NR RRCReconfiguration message to perform SpCell change from NR Cell1 to NR Cell2 (Note 3)	<-	<i>RRCReconfiguration</i>	-	-
9	The SS assigns UL grant during the Random Access procedure on NR Cell 2 to allow the UE to send PDCP status report.(Note 5)	-	-	-	-
-	EXCEPTION: Steps 10 and 11 can occur in any order. (Note 7)	-	-	-	-
10	The UE transmits a NR <i>RRCReconfigurationComplete</i> message. (Note 4)	-->	<i>RRCReconfigurationComplete</i>	-	-
11	Check: Does the UE send PDCP Control PDUs via RLC-AM RB with the following content to the SS: D/C field = 0 (PDCP control PDU) and PDU Type =000, FMC field = 5 on NR Cell 2?	-->	PDCP STATUS REPORT	1	P

12	The SS generates a PDCP status report message and sends it to UE: D/C field = 0 (PDCP control PDU) and PDU Type =000, FMC field = 2 on NR Cell 2.	<--	PDCP STATUS REPORT	-	-
13	Configure the SS to allocate Default UL grants to the UE in NR Cell 2.	-	-	-	-
14	Void	-	-	-	-
-	EXCEPTION: Step 15 shall be repeated for m=2 to 4 (increment=1).	-	-	-	-
15	Check: Does the UE send the PDCP Data PDU #m via RLC-AM RB with the following content to the SS: D/C field = 1 (PDCP Data PDU) and PDCP SN = m on NR Cell 2? Note: Data is previously received data from PDU #m.	-->	PDCP PDU DATA #m	2	P
16	The SS sends the PDCP Data PDU#5 via RLC-AM RB with the following content to the UE: PDCP Data PDU #5 (D/C field = 1 (PDCP Data PDU) and PDCP SN=5) on NR Cell 2.	<--	PDCP DATA PDU#5	-	-
17	The UE transmits a PDCP Data PDU via RLC-AM RB with the following content back to the SS: D/C field = 1 (PDCP Data PDU) and PDCP SN=5 on NR Cell 2. Note: Data is previously received packet in PDCP Data PDU#5. (Note 1)	-->	PDCP DATA PDU #5	-	-
18	TX_NEXT is set to "6". The SS creates a PDCP Data PDU#6 (not transmitted).	-	-	-	-
19	The TX_NEXT is set to "7". The SS creates a PDCP Data PDU #7.	-	-	-	-
20	The SS sends PDCP Data PDU#7 via RLC-AM RB with the following content to the UE: PDCP Data PDU#7; D/C field = 1 (PDCP Data PDU) and PDCP SN=7 on NR Cell 2.	<--	PDCP DATA PDU #7	-	-
21	Check: Does the UE transmit a PDCP DATA PDU#7 on NR Cell 2?	-->	PDCP DATA PDU#7	3	F
21A	Configure SS not to allocate UL grant to the UE in NR Cell 1	-	-	-	-
22	The SS changes NR Cell 1 and NR Cell 2 parameters according to row "T2" in Table 7.1.3.4.1.3.1-1(FR1) / 7.1.3.4.1.3.1-2(FR2).	-	-	-	-
23	The SS requests transmits NR RRCReconfiguration message to perform SpCell change from NR Cell2 to NR Cell1 with key change. (Note 3)	<--	<i>RRCReconfiguration</i>	-	-
24	SS assigns UL grant during the Random Access procedure on NR Cell 1 to allow the UE to send PDCP status report.(Note 5)	-	-	-	-
-	EXCEPTION: Steps 25 and 26 can occur in any order. (Note 7)	-	-	-	-
25	The UE transmits a NR <i>RRCReconfigurationComplete</i> message. (Note 4)	-->	<i>RRCReconfigurationComplete</i>	-	-
26	The UE sends PDCP Control PDUs via RLC-AM RB with the following content to the SS: D/C field = 0 (PDCP control PDU) and PDU Type =000, FMC field = 6, Bitmap = 0x80 on NR Cell 1.	-->	PDCP STATUS REPORT	-	-

27	The SS generates a PDCP status report message and sends it to UE: D/C field = 0 (PDCP control PDU) and PDU Type =000, FMC field = 6 on NR Cell 1.	<--	PDCP STATUS REPORT	-	-
28	Configure the SS to allocate Default UL grants to the UE in NR Cell 1	-	-	-	-
28A	The SS sends the PDCP Data PDU#5 via RLC-AM RB with the following content to the UE: PDCP Data PDU #5 (D/C field = 1 (PDCP Data PDU) and PDCP SN=5) on NR Cell 1.	<--	PDCP DATA PDU#5	-	-
28B	Check: Does the UE transmit a PDCP Data PDU via RLC-AM RB with the following content back to the SS: D/C field = 1 (PDCP Data PDU) and PDCP SN=5 on NR Cell 1 within the next 5 seconds?	-->	PDCP DATA PDU #5	3	F
29	The SS sends the PDCP Data PDU#6 via RLC-AM RB with the following content to the UE: PDCP Data PDU#6 (D/C field = 1 (PDCP Data PDU) and PDCP SN=6) on NR Cell 1.	<--	PDCP DATA PDU #6	-	-
30	Check: Does the UE transmit a PDCP Data PDU via RLC-AM RB with the following content back to the SS? D/C field = 1 (PDCP Data PDU) and PDCP SN=6 on NR Cell 1. Note: Data is previously received packet in PDCP Data PDU#6	-->	PDCP DATA PDU #6	3	P
31	Check: Does the UE transmit PDCP Data PDU via RLC-AM RB with the following content back to the SS? D/C field = 1 (PDCP Data PDU) and PDCP SN=7 on NR Cell 1. Note: Data is previously received packet in PDCP Data PDU#7	-->	PDCP DATA PDU #7	3	P
<p>Note 1: The SS acknowledges the received data.</p> <p>Note 2: SS doesn't send the RLC ACK for this data.</p> <p>Note 3: For EN-DC the NR RRCReconfiguration (Table 7.1.3.4.1.3.3-1 with <i>cond EN-DC</i>) and <i>RadioBearerConfig</i> message (Table 7.1.3.4.1.3.3-2) are contained in RRCConnectionReconfiguration 36.508 [7], Table 4.6.1-8 using conditions EN-DC_EmbedNR_RRCRecon, EN-DC_PSCell_HO and RBConfig_KeyChange. IE sk-Counter-r15 is included with a value incremented by 1 than previous value.</p> <p>Note 4: For EN-DC the NR RRCReconfigurationComplete message is contained in RRCConnectionReconfigurationComplete.</p> <p>Note 5: The PDCP STATUS REPORT PDU size shall be 6 octets with 3 octets of RLC header, 2 octets of MAC header and 3 octets of MAC BSR or padding, so TBS of 112 bits shall be allocated.</p> <p>Note 6: PDCP PDU with $m = 2$ is sent at $t = 0$ and the subsequent PDCP PDUs are sent at $t = (m-2)*75$.</p> <p>Note 7: Per 38.508-1 Table 4.6.3-66: <i>LogicalChannelConfig</i>, both SRB1 and DRB have the same logical channel priority with <i>prioritisedBitRate</i> as infinity.</p>					

7.1.3.4.1.3.3 Specific message contents

Table 7.1.3.4.1.3.3-0: SchedulingRequest-Config (Preamble)

Derivation Path: 38.508-1 [4], Table: 4.6.3-155			
Information Element	Value/remark	Comment	Condition
sr-TransMax	n64		

Table 7.1.3.4.1.3.3-1: RRCReconfiguration (steps 8, 23)

Derivation Path: 38.508-1 [4], Table: 4.6.1-13			
Information Element	Value/remark	Comment	Condition
RRCReconfiguration ::= SEQUENCE {			
criticalExtensions CHOICE {			
rrcReconfiguration ::= SEQUENCE {			
radioBearerConfig	RadioBearerConfig		NR
secondaryCellGroup	CellGroupConfig		EN-DC
}			
nonCriticalExtension ::= SEQUENCE {			NR
masterCellGroup	CellGroupConfig		
masterKeyUpdate ::= SEQUENCE {			
keySetChangeIndicator	false		
nextHopChainingCount	0		
nas-Container	Not present	Horizontal key derivation	
}			
}			
}			
}			

Table 7.1.3.4.1.3.3-2: RadioBearerConfig (Table 7.1.3.4.1.3.3-1)

Derivation Path: 38.508-1 [4], Table: 4.6.3-132			
Information Element	Value/remark	Comment	Condition
RadioBearerConfig ::= SEQUENCE {			
drb-ToAddModList SEQUENCE (SIZE (1..maxDRB)) OF DRB-ToAddMod {	1 entry		
DRB-ToAddMod[1] SEQUENCE {		entry 1	
drb-Identity	2	SCG DRB Id	EN-DC
	Default DRB of the first PDU session		NR
reestablishPDCP	True		
recoverPDCP	Not present		
pdcpc-Config	PDCP-Config		
}			
}			
}			

Table 7.1.3.4.1.3.3-3: PDCP-Config (Table 7.1.3.4.1.3.3-2)

Derivation Path: 38.508-1 [4], Table: 4.6.3-99			
Information Element	Value/remark	Comment	Condition
PDCP-Config ::= SEQUENCE {			
drb SEQUENCE {			
statusReportRequired	True		
}			
}			

Table 7.1.3.4.1.3.3-4: CellGroupConfig for EN-DC (Table 7.1.3.4.1.3.3-1)

Derivation Path: 38.508-1 [4], Table: 4.6.3-19 with condition PSCell_change			
Information Element	Value/remark	Comment	Condition
CellGroupConfig ::= SEQUENCE {			
spCellConfig SEQUENCE {			
reconfigurationWithSync SEQUENCE {			
spCellConfigCommon	ServingCellConfigCommon		
}			
}			
}			

Table 7.1.3.4.1.3.3-4A: CellGroupConfig for NR/5GC (Table 7.1.3.4.1.3.3-1)

Derivation Path: 38.508-1 [4], Table: 4.6.3-19 with condition PCell_change
--

Table 7.1.3.4.1.3.3-5: Void**Table 7.1.3.4.1.3.3-6: Void**

7.1.3.4.2 PDCP handover / Non-lossless handover / PDCP sequence number maintenance

7.1.3.4.2.1 Test Purpose (TP)

(1)

```
with { UE in RRC_CONNECTED state with default RB using RLC-UM }
ensure that {
  when { UE is requested to make a non-lossless handover by SS }
  then { UE transmits next PDCP Data PDU with SN value 0 }
}
```

(2)

```
with { UE in RRC_CONNECTED state with default RB using RLC-UM }
ensure that {
  when { UE is requested to make a non-lossless handover by SS }
  then { UE is able to receive next PDCP Data PDU with SN value 0 }
}
```

7.1.3.4.2.2 Conformance requirements

References: The conformance requirements covered in the present TC are specified in: TS 38.323, clause 5.1.2. Unless otherwise stated these are Rel-15 requirements.

[TS 38.323, clause 5.1.2]

When upper layers request a PDCP entity re-establishment, the UE shall additionally perform once the procedures described in this section. After performing the procedures in this section, the UE shall follow the procedures in subclause 5.2.

When upper layers request a PDCP entity re-establishment, the transmitting PDCP entity shall:

- for UM DRBs and AM DRBs, reset the header compression protocol for uplink and start with an IR state in U-mode (as defined in RFC 3095 [8] and RFC 4815 [9]) if *drb-ContinueROHC* is not configured in TS 38.331 [3];
- for UM DRBs and SRBs, set TX_NEXT to the initial value;
- for SRBs, discard all stored PDCP SDUs and PDCP PDUs;

- apply the ciphering algorithm and key provided by upper layers during the PDCP entity re-establishment procedure;
- apply the integrity protection algorithm and key provided by upper layers during the PDCP entity re-establishment procedure;
- for UM DRBs, for each PDCP SDU already associated with a PDCP SN but for which a corresponding PDU has not previously been submitted to lower layers:
 - consider the PDCP SDUs as received from upper layer;
 - perform transmission of the PDCP SDUs in ascending order of the COUNT value associated to the PDCP SDU prior to the PDCP re-establishment without restarting the *discardTimer*.
- for AM DRBs, from the first PDCP SDU for which the successful delivery of the corresponding PDCP Data PDU has not been confirmed by lower layers, perform retransmission or transmission of all the PDCP SDUs already associated with PDCP SNs in ascending order of the COUNT values associated to the PDCP SDU prior to the PDCP entity re-establishment as specified below:
 - perform header compression of the PDCP SDU as specified in the subclause 5.7.4;
 - perform integrity protection and ciphering of the PDCP SDU using the COUNT value associated with this PDCP SDU as specified in the subclause 5.9 and 5.8;
- submit the resulting PDCP Data PDU to lower layer.

When upper layers request a PDCP entity re-establishment, the receiving PDCP entity shall:

- process the PDCP Data PDUs that are received from lower layers due to the re-establishment of the lower layers, as specified in the subclause 5.2.2.1;
- for SRBs, discard all stored PDCP SDUs and PDCP PDUs;
- for UM DRBs, if *t-Reordering* is running:
 - stop and reset *t-Reordering*;
 - deliver all stored PDCP SDUs to the upper layers in ascending order of associated COUNT values after performing header decompression.
- for AM DRBs, perform header decompression for all stored PDCP SDUs if *drb-ContinueROHC* is not configured in TS 38.331 [3];
- for UM DRBs and AM DRBs, reset the header compression protocol for downlink and start with NC state in U-mode (as defined in RFC 3095 [8] and RFC 4815 [9]) if *drb-ContinueROHC* is not configured in TS 38.331 [3];
- for UM DRBs and SRBs, set RX_NEXT and RX_DELIV to the initial value;
- apply the ciphering algorithm and key provided by upper layers during the PDCP entity re-establishment procedure;
- apply the integrity protection algorithm and key provided by upper layers during the PDCP entity re-establishment procedure.

7.1.3.4.2.3 Test description

7.1.3.4.2.3.1 Pre-test conditions

Same Pre-test conditions as in clause 7.1.3.0 except that the DRB under test is configured in RLC UM mode. For EN-DC, ciphering algorithm is configured as null on E-UTRA.

7.1.3.4.2.3.2 Test procedure sequence

Table 7.1.3.4.2.3.2-1: Main behaviour

St	Procedure	Message Sequence		TP	Verdict
		U - S	Message		
1	The SS creates 3 PDCP Data PDUs and the TX_NEXT is set to "0".	-	-	-	-
-	EXCEPTION: Step 2 and 3 shall be repeated for k=0 to 1 (increment=1).	-	-	-	-
2	The SS sends the PDCP Data PDU #k via RLC-UM RB with the following content to the UE: D/C field = 1 (PDCP Data PDU) and PDCP SN = k. After having sent a PDU, the SS set TX_NEXT= k+1.	<--	PDCP PDU DATA #k	-	-
3	The UE sends the PDCP Data PDU #k via RLC-UM RB with the following content to the SS: D/C field = 1 (PDCP Data PDU) and PDCP SN = k.	-->	PDCP PDU DATA #k	-	-
4	The SS transmits NR <i>RRCReconfiguration</i> message to trigger non-lossless handover to the same SpCell . (Note 1, Note 3 and Note4)	<--	<i>RRCReconfiguration</i>	-	-
5	The UE transmits a NR <i>RRCReconfigurationComplete</i> message. (Note 2)	-->	<i>RRCReconfigurationComplete</i>	-	-
6	The SS sends the PDCP Data PDU #2 via RLC-UM RB with the following content to the UE: D/C field = 1 (PDCP Data PDU) and PDCP SN = 0. After having sent a PDU, the SS set TX_NEXT= 1.	<--	PDCP PDU DATA #2	-	-
7	Check: Does the UE send the PDCP Data PDU #2 via RLC-UM RB with the following content back to the SS: D/C field = 1 (PDCP Data PDU) and PDCP SN = 0?	-->	PDCP PDU DATA #2	1, 2	P
<p>Note 1: For EN-DC the NR <i>RRCReconfiguration</i> message with SCG Key change (secondary to master) is contained in <i>RRCCConnectionReconfiguration</i> 36.508 [7], Table 4.6.1-8 using condition EN-DC_PSCell_HO and <i>RBConfig_KeyChange</i>.</p> <p>Note 2: For EN-DC the NR <i>RRCReconfigurationComplete</i> message is contained in <i>RRCCConnectionReconfigurationComplete</i>.</p> <p>Note 3: The <i>RRCReconfiguration</i> message triggers UE to perform the Random Access procedure, MAC reset, RLC and PDCP re-establishment.</p> <p>Note 4: For NR, the <i>RRCReconfiguration</i> message with master key change is as per <i>RRCReconfiguration-HO</i> with condition <i>RBConfig_KeyChange</i> according to 38.508-1 [4], Table 4.8.1-1A.</p>					

7.1.3.4.2.3 Specific message contents

Table 7.1.3.4.2.3-1: *RRCReconfiguration* for EN-DC (step 4, Table 7.1.3.4.2.3.2-1)

Derivation Path: TS 38.508-1 [4], Table 4.6.1-13 with condition EN-DC_HO.

Table 7.1.3.4.2.3-1A: RRCReconfiguration for NR/5GC (step 4, Table 7.1.3.4.2.3.2-1)

Derivation Path: TS 38.508-1 [4], Table 4.8.1-1A with condition RBConfig_KeyChange			
Information Element	Value/remark	Comment	Condition
RRCReconfiguration ::= SEQUENCE {			
criticalExtensions CHOICE {			
rrcReconfiguration ::= SEQUENCE {			
nonCriticalExtension SEQUENCE {			
masterCellGroup	CellGroupConfig	OCTET STRING (CONTAINING CellGroupConfig)	
masterKeyUpdate SEQUENCE {			
keySetChangeIndicator	false	K	
nextHopChainingCount	0	Horizontal key derivation	
nas-Container	not present		
}			

Table 7.1.3.4.2.3-2: RadioBearerConfig for EN-DC (step 4, Table 7.1.3.4.2.3.2-1)

Derivation Path: 38.508-1 [4], Table 4.6.3-132 with condition EN-DC_DRB AND Re-establish_PDCP			
Information Element	Value/remark	Comment	Condition
RadioBearerConfig ::= SEQUENCE {			
securityConfig SEQUENCE {			
securityAlgorithmConfig	SecurityAlgorithmConfig		
keyToUse	master		
}			

Table 7.1.3.4.2.3-3: SecurityAlgorithmConfig for EN-DC (Table 7.1.3.4.2.3-2)

Derivation Path: 38.508-1 [4], Table 4.6.3-165			
Information Element	Value/remark	Comment	Condition
SecurityAlgorithmConfig ::= SEQUENCE {			
cipheringAlgorithm	nea0		
}			

Table 7.1.3.4.2.3-4: CellGroupConfig for EN-DC (step 4, Table 7.1.3.4.2.3.2-1)

Derivation Path: 38.508-1 [4], Table 4.6.3-19 with condition PSCell_change			
Information Element	Value/remark	Comment	Condition
CellGroupConfig ::= SEQUENCE {			
rlc-BearerToAddModList SEQUENCE (SIZE(1..maxLCH)) OF RLC-BearerConfig {	1 entry		EN-DC
RLC-Bearer-Config[1]	RLC-BearerConfig with conditions UM and DRB2 and Re-establish_RLC	entry 1	
}			

Table 7.1.3.4.2.3-5: CellGroupConfig for NR/5GC (step 4, Table 7.1.3.4.2.3.2-1)

Derivation Path: 38.508-1 [4], Table 4.6.3-19 with condition PCell_change			
---	--	--	--

7.1.3.5 PDCP other

7.1.3.5.1 PDCP Discard

7.1.3.5.1.1 Test Purpose (TP)

(1)

```
with { UE in RRC_CONNECTED state }
ensure that {
  when { the Discard Timer for a PDCP SDU expires }
  then { UE discards the corresponding PDCP SDU }
}
```

7.1.3.5.1.2 Conformance requirements

References: The conformance requirements covered in the present TC are specified in: TS 38.323, clause 5.3. Unless otherwise stated these are Rel-15 requirements.

[TS 38.323, clause 5.3]

When the *discardTimer* expires for a PDCP SDU, or the successful delivery of a PDCP SDU is confirmed by PDCP status report, the transmitting PDCP entity shall discard the PDCP SDU along with the corresponding PDCP Data PDU. If the corresponding PDCP Data PDU has already been submitted to lower layers, the discard is indicated to lower layers.

For SRBs, when upper layers request a PDCP SDU discard, the PDCP entity shall discard all stored PDCP SDUs and PDCP PDUs.

NOTE: Discarding a PDCP SDU already associated with a PDCP SN causes a SN gap in the transmitted PDCP Data PDUs, which increases PDCP reordering delay in the receiving PDCP entity. It is up to UE implementation how to minimize SN gap after SDU discard.

[TS 38.323, clause 7.1]

This sub clause describes the state variables used in PDCP entities in order to specify the PDCP protocol. The state variables defined in this subclause are normative.

All state variables are non-negative integers, and take values from 0 to $[2^{32} - 1]$.

PDCP Data PDUs are numbered integer sequence numbers (SN) cycling through the field: 0 to $[2^{pdcp-SN-Size} - 1]$.

The transmitting PDCP entity shall maintain the following state variables:

a) TX_NEXT

This state variable indicates the COUNT value of the next PDCP SDU to be transmitted. The initial value is 0.

The receiving PDCP entity shall maintain the following state variables:

a) RX_NEXT

This state variable indicates the COUNT value of the next PDCP SDU expected to be received. The initial value is 0.

b) RX_DELIV

This state variable indicates the COUNT value of the first PDCP SDU not delivered to the upper layers, but still waited for. The initial value is 0.

c) RX_REORD

This state variable indicates the COUNT value following the COUNT value associated with the PDCP Data PDU which triggered *t-Reordering*.

[TS 38.323, clause 6.3.5]

Length: 32 bits

The COUNT value is composed of a HFN and the PDCP SN. The size of the HFN part in bits is equal to 32 minus the length of the PDCP SN.



Figure 6.3.5-1: Format of COUNT

NOTE: COUNT does not wrap around.

7.1.3.5.1.3 Test description

7.1.3.5.1.3.1 Pre-test conditions

Same Pre-test conditions as in clause 7.1.3.0 with exceptions listed in Table 7.1.3.5.1.3.1-1 applicable for the configured UM DRB and Table 7.1.3.5.1.3.3-1 for SR configuration except that PDCP is configured for 18 bit SN.

Table 7.1.3.5.1.3.1-1: PDCP Settings

Parameter	Value
Discard_Timer	500 ms

7.1.3.5.1.3.2 Test procedure sequence

Table 7.1.3.5.1.3.2-1: Main behaviour

St	Procedure	Message Sequence		TP	Verdict
		U - S	Message		
-	EXCEPTION: The SS does not allocate UL grants unless when explicitly stated so in the procedure.	-	-	-	-
1	The SS creates 5 PDCP Data PDUs and the PDCP SN = "0" within TX_NEXT.		-	-	-
2	Void				
-	EXCEPTION: Step 3 shall be repeated for k=0 to 2 (increment=1) with the below specified PDU size sent to the UE: Data PDU#1 = 46 bytes for k=0 Data PDU#2 = 62 bytes for k=1 Data PDU#3 = 78 bytes for k=2	-	-	-	-
3	The SS sends a PDCP Data PDU via RLC-UM RB with the following content to the UE: D/C field = 1 (PDCP Data PDU) and PDCP SN = k After having sent a PDU, the SS sets PDCP SN is set to k+1 within TX_NEXT.	<-	PDCP DATA PDU (SN=k)	-	-
4	Wait for Discard_Timer to expire. Note: According to TS38.508-1, timer tolerance should be 10% of Discard_Timer.	-	-	-	-
-	EXCEPTION: Step 5 shall be repeated for k=3 to 4 (increment=1) with the below specified PDU size sent to the UE: Data PDU#4 = 94 bytes for k=3 Data PDU#5 = 110 bytes for k=4	-	-	-	-
5	The SS sends a PDCP Data PDU via RLC-UM RB with the following content to the UE: D/C field = 1 (PDCP Data PDU) and PDCP SN = k After having sent a PDU, the SS sets PDCP SN is set to k+1 within TX_NEXT.	<-	PDCP DATA PDU (SN=k)	-	-
6	The SS resumes normal UL grant allocation.	-	-	-	-
7	Check: Does UE transmit a PDCP Data PDU # 4 of size 94 bytes? (Note1)	-->	PDCP Data PDU # 4	1	P
8	Check: Does UE transmit a PDCP Data PDU # 5 of size 110 bytes? (Note1)	-->	PDCP Data PDU # 5	1	P
Note 1	PDCP Data PDU contents are checked to verify that the UL PDU is same as the DL PDU. According to the Note in TS 38.323 [19] clause 5.3 in case of PDCP SDUs being discarded it is up to the UE implementation which SN to be used and therefore the SN cannot be checked.				

7.1.3.5.1.3.3 Specific message contents

Table 7.1.3.5.1.3.3-1: SchedulingRequest-Config (Preamble)

Derivation Path: 38.508-1 [4], Table 4.6.3-155			
Information Element	Value/remark	Comment	Condition
sr-TransMax	n64		

7.1.3.5.2 PDCP Uplink Routing / Split DRB

7.1.3.5.2.1 Test Purpose

(1)

```

with { UE in RRC_CONNECTED state with SCG activated with a Split DRB established and total amount of
PDCP data volume is less than ul-DataSplitThreshold and not yet transmitted RLC data volume in the
two associated RLC entities }
ensure that {
  when { UE has PDCP SDUs available for transmission }
  then { the UE transmits the PDCP SDUs on the Primary RLC entity }

```

```

    }

```

(2)

```

with { UE in RRC_CONNECTED state with SCG activated with a Split DRB established and total amount of
PDCP data volume is not less than ul-DataSplitThreshold and not yet transmitted RLC data volume in
the two associated RLC entities }
ensure that {
  when { UE has PDCP SDUs available for transmission }
  then { the UE transmits the PDCP SDUs on the primary or secondary RLC entity }
}

```

7.1.3.5.2.2 Conformance requirements

References: The conformance requirements covered in the present TC are specified in: TS 38.323, clause 5.2.1. Unless otherwise stated these are Rel-15 requirements.

[TS 38.323, clause 5.2.1]

At reception of a PDCP SDU from upper layers, the transmitting PDCP entity shall:

- start the *discardTimer* associated with this PDCP SDU (if configured).

For a PDCP SDU received from upper layers, the transmitting PDCP entity shall:

- associate the COUNT value corresponding to TX_NEXT to this PDCP SDU;

NOTE 1: Associating more than half of the PDCP SN space of contiguous PDCP SDUs with PDCP SNs, when e.g., the PDCP SDUs are discarded or transmitted without acknowledgement, may cause HFN desynchronization problem. How to prevent HFN desynchronization problem is left up to UE implementation.

- perform header compression of the PDCP SDU as specified in the subclause 5.7.4;
- perform integrity protection, and ciphering using the TX_NEXT as specified in the subclause 5.9 and 5.8, respectively;
- set the PDCP SN of the PDCP Data PDU to TX_NEXT modulo $2^{[pdcp-SN-Size]}$;
- increment TX_NEXT by one;
- submit the resulting PDCP Data PDU to lower layer as specified below.

When submitting a PDCP Data PDU to lower layer, the transmitting PDCP entity shall:

- if the transmitting PDCP entity is associated with one RLC entity:
 - submit the PDCP Data PDU to the associated RLC entity.
- else, if the transmitting PDCP entity is associated with two RLC entities:
 - if the PDCP duplication is activated:
 - if the PDCP PDU is a PDCP Data PDU:
 - duplicate the PDCP Data PDU and submit the PDCP Data PDU to both associated RLC entities.
 - else:
 - if the two associated RLC entities belong to the different Cell Groups; and
 - if the total amount of PDCP data volume and RLC data volume pending for initial transmission (as specified in TS 36.322 [5]) in the two associated RLC entities is equal to or larger than *ul-DataSplitThreshold*:
 - submit the PDCP Data PDU to either the primary RLC entity or the secondary RLC entity;
 - else:

- submit the PDCP Data PDU to the primary RLC entity.

NOTE 2: If the transmitting PDCP entity is associated with two RLC entities, the UE should minimize the amount of PDCP PDUs submitted to lower layers before receiving request from lower layers and minimize the PDCP SN gap between PDCP PDUs submitted to two associated RLC entities to minimize PDCP reordering delay in the receiving PDCP entity.

7.1.3.5.2.3 Test description

7.1.3.5.2.3.1 Pre-test conditions

Same Pre-test conditions as in clause 7.1.3.0 with exceptions listed in Table 7.1.3.5.2.3.1-1 and Generic procedure parameter DC bearer(MCG and *split*).

For NR 5GC, NRCell 1 is the PCell and NR Cell 10 is the PSCell and same Pre-test conditions as in clause 7.1.3.0 using generic procedure parameter Connectivity (NR-DC) with DC bearer(MCG and *split*).

Table 7.1.3.5.2.3.1-1: PDCP Settings

Parameter	Value
Discard_Timer	500 ms
ul-DataSplitThreshold	b100

7.1.3.5.2.3.2 Test procedure sequence

Table 7.1.3.5.2.3.2-1: Main behaviour

St	Procedure	Message Sequence		TP	Verdict
		U - S	Message		
1	The SS sends a PDCP Data PDU on the split DRB on AM RLC entity configured for SCG on PSCell. Data PDU = 64 bytes.	<--	PDCP DATA PDU	-	-
-	EXCEPTION: In parallel with step 2, UE may execute parallel behaviour defined in table 7.1.3.5.2.3.2-2.	-	-	-	-
2	Check: Does UE transmit a PDCP Data PDU on the AM RLC entity configured for SCG on PSCell?	-->	PDCP DATA PDU	1	P
3	The SS sends a PDCP Data PDU on the split DRB on AM RLC entity configured for SCG on PSCell. Data PDU = 164 bytes.	<--	PDCP DATA PDU	-	-
-	EXCEPTION: Steps 4a1 to 4b2 describe optional behaviour that depends on the UE uplink path	-	-	-	-
4a1	Check: Does UE transmit a PDCP Data PDU on the AM RLC entity configured for MCG on PCell?	-->	PDCP DATA PDU	2	P
4a2	Check: Does UE transmit a PDCP Data PDU on the AM RLC entity configured for SCG on PSCell?	-->	PDCP DATA PDU	2	F
4b1	Check: Does UE transmit a PDCP Data PDU on the AM RLC entity configured for SCG on PSCell?	-->	PDCP DATA PDU	2	P
4b2	Check: Does UE transmit a PDCP Data PDU on the AM RLC entity configured for MCG PCell?	-->	PDCP DATA PDU	2	F
5	SS transmits NR RRCReconfiguration message to configure new split DRB parameters, where the ul-DataSplitThreshold is equal to 0 bytes (Note 1).	<--	<i>RRCReconfiguration</i>	-	-
6	UE transmits RRCReconfigurationComplete (Note 2).	-->	<i>RRCReconfigurationComplete</i>	-	-
7	The SS sends a PDCP Data PDU on the split DRB on AM RLC entity configured for SCG on PSCell. Data PDU = 64 bytes	<--	PDCP Data PDU	-	-
-	EXCEPTION: Steps 8a1 to 8b2 describe optional behaviour that depends on the UE uplink path	-	-	-	-
8a1	Check: Does UE transmit a PDCP Data PDU on the AM RLC entity configured for MCG on PCell?	-->	PDCP DATA PDU	2	P
8a2	Check: Does UE transmit a PDCP Data PDU on the AM RLC entity configured for SCG on PSCell?	-->	PDCP DATA PDU	2	F
8b1	Check: Does UE transmit a PDCP Data PDU on the AM RLC entity configured for SCG on PSCell?	-->	PDCP DATA PDU	2	P
8b2	Check: Does UE transmit a PDCP Data PDU on the AM RLC entity configured for MCG PCell?	-->	PDCP DATA PDU	2	F
Note 1: For EN-DC the NR <i>RRCReconfiguration</i> message is contained in <i>RRCConnectionReconfiguration</i> .					
Note 2: For EN-DC the NR <i>RRCReconfigurationComplete</i> message is contained in <i>RRCConnectionReconfigurationComplete</i> .					

Table 7.1.3.5.2.3.2-2: Parallel behaviour

St	Procedure	Message Sequence		TP	Verdict
		U - S	Message		
1	Check: Does UE transmit a PDCP Data PDU on the AM RLC entity configured for MCG on PCell in next two seconds? NOTE: Two seconds sufficient time to discard PDCP PDU.	-->	PDCP DATA PDU	1	F

7.1.3.5.2.3.3 Specific message contents

Table 7.1.3.5.2.3.3-0A: RRCConnectionReconfiguration (step 5, Table 7.1.3.5.3.3.2-1)

Derivation Path: 36.508 [7], Table 4.6.1-8			
Information Element	Value/remark	Comment	Condition
RRCConnectionReconfiguration ::= SEQUENCE {			
criticalExtensions CHOICE {			
c1 CHOICE{			
rrcConnectionReconfiguration-r8 ::= SEQUENCE			
{			
nonCriticalExtension SEQUENCE {			
nonCriticalExtension SEQUENCE {			
nonCriticalExtension SEQUENCE {			
nonCriticalExtension SEQUENCE {			
nonCriticalExtension SEQUENCE {			
nonCriticalExtension SEQUENCE {			
nonCriticalExtension SEQUENCE {			
nr-RadioBearerConfig1-r15	OCTET STRING including RadioBearerConfig		
}			
}			
}			
}			
}			
}			
}			
}			
}			

Table 7.1.3.5.2.3.3-0B: RRCReconfiguration (step 5, Table 7.1.3.5.2.3.2-1)

Derivation Path: 38.508-1 [4], Table 4.6.1-13			
Information Element	Value/remark	Comment	Condition
RRCReconfiguration ::= SEQUENCE {			
criticalExtensions CHOICE {			
rrcReconfiguration SEQUENCE {			
nonCriticalExtension SEQUENCE {			
nonCriticalExtension SEQUENCE {			
nonCriticalExtension SEQUENCE {			
radioBearerConfig2	OCTET STRING including RadioBearerConfig		
}			
}			
}			
}			
}			

Table 7.1.3.5.2.3.3-1: RadioBearerConfig (Table 7.1.3.5.2.3.3-0A and Table 7.1.3.5.2.3.3-0B)

Derivation Path: 38.508-1 [4], Table 4.6.3-132			
Information Element	Value/remark	Comment	Condition
RadioBearerConfig ::= SEQUENCE {			
drb-ToAddModList SEQUENCE (SIZE (1..maxDRB))	1 entry		
OF DRB-ToAddMod {			
DRB-ToAddMod[1] SEQUENCE {		entry 1	
pdcp-Config SEQUENCE {			
moreThanOneRLC SEQUENCE {			
primaryPath SEQUENCE {			
cellGroup	1		EN-DC
	0		NR
logicalChannel	LogicalChannelIdentity		
}			
ul-DataSplitThreshold	b0		
}			
}			

7.1.3.5.3 PDCP Data Recovery

7.1.3.5.3.1 Test Purpose (TP)

(1)

```
with { UE in RRC_CONNECTED state with a DRB established using RLC-AM }
ensure that {
  when { network requests reconfiguration and recovery of the DRB (without handover) }
    then { UE reconfigures the DRB and performs retransmission of all the PDCP PDUs previously
submitted to re-established AM RLC entity in ascending order of the associated COUNT values from the
first PDCP PDU for which the successful delivery has not been confirmed by lower layers }
}
```

7.1.3.5.3.2 Conformance requirements

References: The conformance requirements covered in the present TC are specified in: TS 38.323, clauses 5.2.1, 5.4.1 and 5.5; TS 38.331, clause 5.3.5.4.3. Unless otherwise stated these are Rel-15 requirements.

[TS 38.323, clause 5.2.1]

At reception of a PDCP SDU from upper layers, the transmitting PDCP entity shall:

- start the *discardTimer* associated with this PDCP SDU (if configured).

For a PDCP SDU received from upper layers, the transmitting PDCP entity shall:

- associate the COUNT value corresponding to TX_NEXT to this PDCP SDU;

NOTE 1: Associating more than half of the PDCP SN space of contiguous PDCP SDUs with PDCP SNs, when e.g., the PDCP SDUs are discarded or transmitted without acknowledgement, may cause HFN desynchronization problem. How to prevent HFN desynchronization problem is left up to UE implementation.

- perform header compression of the PDCP SDU as specified in the subclause 5.7.4;
- perform integrity protection, and ciphering using the TX_NEXT as specified in the subclause 5.9 and 5.8, respectively;
- set the PDCP SN of the PDCP Data PDU to TX_NEXT modulo $2^{\lfloor \text{ndcp-SN-Size} \rfloor}$;
- increment TX_NEXT by one;

- submit the resulting PDCP Data PDU to lower layer as specified below.

When submitting a PDCP PDU to lower layer, the transmitting PDCP entity shall:

- if the transmitting PDCP entity is associated with one RLC entity:
 - submit the PDCP PDU to the associated RLC entity;
- else, if the transmitting PDCP entity is associated with two RLC entities:
 - if *pdcp-Duplication* is configured and activated:
 - duplicate the PDCP Data PDU and submit the PDCP Data PDU to both associated RLC entities;
 - else, if *pdcp-Duplication* is configured but not activated:
 - submit the PDCP Data PDU to the primary RLC entity;
 - else:
 - if the total amount of PDCP data volume and RLC data volume pending for initial transmission (as specified in TS 38.322 [5]) in the two associated RLC entities is less than *ul-DataSplitThreshold*:
 - submit the PDCP PDU to the primary RLC entity;
 - else:
 - submit the PDCP PDU to either the primary RLC entity or the secondary RLC entity.

NOTE 2: If the transmitting PDCP entity is associated with two RLC entities, the UE should minimize the amount of PDCP PDUs submitted to lower layers before receiving request from lower layers and minimize the PDCP SN gap between PDCP PDUs submitted to two associated RLC entities to minimize PDCP reordering delay in the receiving PDCP entity.

[TS 38.323, clause 5.4.1]

For AM DRBs configured by upper layers to send a PDCP status report in the uplink (*statusReportRequired* in TS 38.331 [3]), the receiving PDCP entity shall trigger a PDCP status report when:

- upper layer requests a PDCP entity re-establishment;
- upper layer requests a PDCP data recovery.

If a PDCP status report is triggered, the receiving PDCP entity shall:

- compile a PDCP status report as indicated below by:
 - setting the FMC field to RX_DELIV;
 - if $RX_DELIV < RX_NEXT$:
 - allocating a Bitmap field of length in bits equal to the number of COUNTs from and not including the first missing PDCP SDU up to and including the last out-of-sequence PDCP SDUs, rounded up to the next multiple of 8, or up to and including a PDCP SDU for which the resulting PDCP Control PDU size is equal to 9000 bytes, whichever comes first;
 - setting in the bitmap field as '0' for all PDCP SDUs that have not been received, and optionally PDCP SDUs for which decompression have failed;
 - setting in the bitmap field as '1' for all PDCP SDUs that have been received;
- submit the PDCP status report to lower layers as the first PDCP PDU for transmission.

[TS 38.323, clause 5.4.2]

For AM DRBs, when a PDCP status report is received in the downlink, the transmitting PDCP entity shall:

- consider for each PDCP SDU, if any, with the bit in the bitmap set to '1', or with the associated COUNT value less than the value of FMC field as successfully delivered, and discard the PDCP SDU as specified in the subclause 5.3.

[TS 38.323, clause 5.5]

For AM DRBs, when upper layers request a PDCP data recovery for a radio bearer, the transmitting PDCP entity shall:

- perform retransmission of all the PDCP Data PDUs previously submitted to re-established or released AM RLC entity in ascending order of the associated COUNT values for which the successful delivery has not been confirmed by lower layers.

After performing the above procedures, the transmitting PDCP entity shall follow the procedures in subclause 5.2.1.

7.1.3.5.3.3 Test description

7.1.3.5.3.3.1 Pre-test conditions

Same Pre-test conditions as in clause 7.1.3.0 except that DRB is configured in RLC AM mode according to Table 7.1.3.5.3.3.1-1.

For NR 5GC, NRCell 1 is the PCell and NR Cell 10 is the PSCell and same Pre-test conditions as in clause 7.1.3.0 using generic procedure parameter Connectivity (*NR-DC*).

Table 7.1.3.5.3.3.1-1: RLC parameters

<i>t-PollRetransmit</i>	ms150
-------------------------	-------

7.1.3.5.3.3.2 Test procedure sequence

Table 7.1.3.5.3.3.2-1: Main behaviour

St	Procedure	Message Sequence		TP	Verdict
		U - S	Message		
1	Void	-	-	-	-
2	The SS creates 3 PDCP Data PDUs and the Next_PDCP_TX_SN is set to "0".	-	-	-	-
-	EXCEPTION: Steps 2A and 4 shall be repeated for k=0 to 2 (increment=1).	-	-	-	-
2A	The SS is configured on PSCell to not send RLC acknowledgement (RLC ACK) to the UE	-	-	-	-
3	The SS sends the PDCP Data PDU #k on SCG DRB on (PSCell): D/C field = 1 (PDCP Data PDU) and PDCP SN = k. After having sent a PDU, the SS sets Next_PDCP_TX_SN= k+1.	<-	PDCP PDU DATA #k	-	-
4	The UE sends the PDCP Data PDU #k on the AM RLC entity configured for PSCell: D/C field = 1 (PDCP Data PDU) and PDCP SN = k. Data is previously received data from PDU #k.	-->	PDCP PDU DATA #k	-	-
4A	The SS does not allocate any UL grant.	-	-	-	-
5	The SS transmits a NR <i>RRCReconfiguration</i> . (Note 1).	<-	<i>RRCReconfiguration</i>	-	-
6	The UE transmits a NR <i>RRCReconfigurationComplete</i> . (Note 2).	-->	<i>RRCReconfigurationComplete</i>	-	-
7	The SS assigns 1 UL grant of sufficient size to allow the UE to send only PDCP status report.	-	-	-	-
8	The UE sends PDCP Control PDUs on PSCell via RLC-AM RB with the following content to the SS: D/C field = 0 (PDCP control PDU) and PDU Type =000, FMC field = 3.	-->	PDCP STATUS REPORT	-	-
8A	After 100 ms the SS allocates 3 UL grants every 20ms of sufficient size to enable the UE to return each received PDCP PDU in one looped back PDCP PDU on PSCell.	-	-	-	-
-	EXCEPTION: Step 9 shall be repeated for k=0 to 2 (increment=1).	-	-	-	-
9	Check: Does the UE send the PDCP Data PDU #k via the AM RLC entity configured for PSCell for Connectivity ENDC and PCell for Connectivity (NR-DC). D/C field = 1 (PDCP Data PDU) and PDCP SN = k. Data is previously received data from PDU #k ?	-->	PDCP DATA PDU #k	1	P
Note 1: For EN-DC the NR <i>RRCReconfiguration</i> message is contained in <i>RRCCConnectionReconfiguration</i> . Note 2: For EN-DC the NR <i>RRCReconfigurationComplete</i> message is contained in <i>RRCCConnectionReconfigurationComplete</i> .					

7.1.3.5.3.3.3 Specific message contents

Table 7.1.3.5.3.3-1: RRCConnectionReconfiguration (step 5, Table 7.1.3.5.3.3.2-1)

Derivation Path: 36.508 [7], Table 4.6.1-8 with condition MCG_and_SCG			
Information Element	Value/remark	Comment	Condition
RRCConnectionReconfiguration ::= SEQUENCE {			
criticalExtensions CHOICE {			
c1 CHOICE{			
rrcConnectionReconfiguration-r8 ::= SEQUENCE			
{			
nonCriticalExtension SEQUENCE {			
nonCriticalExtension SEQUENCE {			
nonCriticalExtension SEQUENCE {			
nonCriticalExtension SEQUENCE {			
nonCriticalExtension SEQUENCE {			
nonCriticalExtension SEQUENCE {			
nonCriticalExtension SEQUENCE {			
nr-Config-r15 CHOICE {			
setup SEQUENCE {			
nr-SecondaryCellGroupConfig-r15	OCTET STRING including the RRCReconfiguration-PDCP message and the IE secondaryCellGroup		
}			
}			
}			
}			
}			
}			
}			
}			
}			
}			
}			
nr-RadioBearerConfig1-r15	OCTET STRING including RadioBearerConfig-PDCP-ENDC		
}			
}			
}			
}			
}			
}			
}			
}			
}			
}			
}			
}			
}			
}			
}			

Table 7.1.3.5.3.3.3-2: RRCReconfiguration-PDCP (Step 5, Table 7.1.3.5.3.3.3-1)

Derivation Path: 38.508-1 [4], Table 4.6.1-13			
Information Element	Value/remark	Comment	Condition
RRCReconfiguration ::= SEQUENCE {			
criticalExtensions CHOICE {			
rrcReconfiguration SEQUENCE {			
radioBearerConfig	Not present		NR-DC
secondaryCellGroup	CellGroupConfig-PDCP- ENDC		EN-DC
	Not present		NR-DC
nonCriticalExtension SEQUENCE {			NR-DC
masterCellGroup	CellGroupConfig with condition DRBn as per 38.508-1[4] Table 4.6.3- 19	SCG DRBn added in master cell group	
nonCriticalExtension SEQUENCE {			
nonCriticalExtension SEQUENCE {			
mrdc-SecondaryCellGroupConfig CHOICE {			
setup SEQUENCE {			
mrdc-SecondaryCellGroup CHOICE {			
nr-SCG	RRCReconfiguration- SCGRLCreEst	OCTET STRING (CONTAINING RRCReconfigurati on)	
radioBearerConfig2	RadioBearerConfig- PDCPsplit		
}			
}			
}			
}			
}			
}			
}			
}			
}			
}			
}			

Table 7.1.3.5.3.3.3-2A: RRCReconfiguration-SCGRLCreEst (Table 7.1.3.5.3.3.3-2)

Derivation Path: 38.508-1 [4], Table 4.6.1-13 with condition NR-DC_SCG			
Information Element	Value/remark	Comment	Condition
RRCReconfiguration ::= SEQUENCE {			
criticalExtensions CHOICE {			
rrcReconfiguration SEQUENCE {			
secondaryCellGroup	CellGroupConfig-SCG- RLC	OCTET STRING (CONTAINING CellGroupConfig)	
}			
}			
}			

Table 7.1.3.5.3.3.3-2B: CellGroupConfig-PDCP-ENDC(Table 7.1.3.5.3.3.3-2)

Derivation Path: 38.508-1 [4], Table 4.6.3-19			
Information Element	Value/remark	Comment	Condition
CellGroupConfig ::= SEQUENCE {			
rlc-BearerToAddModList SEQUENCE (SIZE(1..maxLCH)) OF RLC-BearerConfig {	1 entry		
RLC-BearerConfig[1]	RLC-BearerConfig with conditions AM and DRB2 and Re-establish_RLC	entry 1	
}			
}			

Table 7.1.3.5.3.3.3-2C: CellGroupConfig-SCG-RLC (Table 7.1.3.5.3.3.3-2A)

Derivation Path: 38.508-1 [4], Table 4.6.1-19 with condition NR-DC_SCG			
Information Element	Value/remark	Comment	Condition
CellGroupConfig ::= SEQUENCE {			
rlc-BearerToAddModList SEQUENCE (SIZE(1..maxLCH)) OF RLC-BearerConfig {	1 entry		
	RLC-BearerConfig with conditions AM and DRBn and Re-establish_RLC		
}			
}			

Table 7.1.3.5.3.3.3-3: RadioBearerConfig-PDCP-ENDC (Table 4.1.3.5.3.3.3-2)

Derivation Path: TS 38.508-1 [7], Table 4.6.3-132			
Information Element	Value/remark	Comment	Condition
RadioBearerConfig ::= SEQUENCE {			
srb3-ToRelease	Not present		
drb-ToAddModList	Not present		
drb-ToAddModList SEQUENCE (SIZE (1..maxDRB)) OF DRB-ToAddMod {	1 entry		
DRB-ToAddMod[1] SEQUENCE {		entry 1	
cnAssociation CHOICE {			
eps-BearerIdentity	6		
sdap-Config	Not present		
}			
drb-Identity	2		
reestablishPDCP	Not present		
recoverPDCP	true		
pdcp-Config	PDCP-Config-Split		
}			
}			
drb-ToReleaseList	Not present		
}			

Table 7.1.3.5.3.3-3A: RadioBearerConfig-PDCPSplit (Table 7.1.3.5.3.3-2)

Derivation Path: TS 38.508-1 [4], Table 4.6.3-132			
Information Element	Value/remark	Comment	Condition
RadioBearerConfig ::= SEQUENCE {			
drb-ToAddModList SEQUENCE (SIZE (1..maxDRB))	1 entry		
OF {			
DRB-ToAddMod[1] SEQUENCE {			
cnAssociation	Not present		
drb-Identity	DRB-Identity with condition DRBn	SGC DRBn	
reestablishPDCP	Not present		
recoverPDCP	true		
pdcp-Config	PDCP-Config-Split		
}			
}			
}			

Table 7.1.3.5.3.3-4: PDCP-Config-Split (Table 7.1.3.5.3.3-3)

Derivation Path: 38.508-1 [4], Table 4.6.3-99 condition EN-DC			
Information Element	Value/remark	Comment	Condition
PDCP-Config ::= SEQUENCE {			
moreThanOneRLC SEQUENCE {			
primaryPath SEQUENCE {			
cellGroup	1		EN-DC
	0	MCG Path	NR-DC
}			
ul-DataSplitThreshold	infinity		
}			
}			

7.1.3.5.4 PDCP reordering / Maximum re-ordering delay below t-Reordering / t-Reordering timer operations

7.1.3.5.4.1 Test Purpose (TP)

(1)

```
with { UE in RRC_CONNECTED state using RLC-AM }
ensure that {
  when { a PDCP PDU is received from the lower layers and the COUNT value of the received PDCP Data PDU is out of the re-ordering window }
  then { UE discards the PDCP PDU }
}
```

(2)

```
with { UE in RRC_CONNECTED state using RLC-AM }
ensure that {
  when { a PDCP PDU is received from the lower layers and the COUNT value of the received PDCP Data PDU is within the re-ordering window }
  then { UE stores the resulting PDCP SDU }
}
```

(3)

```
with { UE in RRC_CONNECTED state using RLC-AM, and the RX_DELIV is not equal to the COUNT value of the RX_NEXT (there is missing PDCP PDUs) }
ensure that {
  when { a PDCP PDU is received from the lower layers and the RCVD_COUNT = RX_DELIV }
  then { UE delivers the resulting PDCP SDU and all stored PDCP SDUs with consecutive COUNT value to upper layer, in ascending order }
}
```

(4)

```

with { UE in RRC_CONNECTED state using RLC-AM and the associated PDCP t-Reordering timer is running
}
ensure that {
  when { RX_DELIV >= RX_REORD }
  then { UE stops and resets t-Reordering timer }
}

```

(5)

```

with { UE in RRC_CONNECTED state using RLC-AM and the associated PDCP t-Reordering timer is running
}
ensure that {
  when { the t-Reordering timer expires }
  then { UE delivers all stored PDCP SDUs to upper layer }
}

```

(6)

```

with { UE in RRC_CONNECTED state using RLC-AM and the associated PDCP t-Reordering timer is running
}
ensure that {
  when { the t-Reordering is reconfigured by upper layers }
  then { UE stops and resets t-Reordering timer }
}

```

7.1.3.5.4.2 Conformance requirements

References: The conformance requirements covered in the present test case are specified in: TS 38.323, clause 5.2.2.1, 5.2.2.2 and 5.2.2.3. Unless otherwise stated these are Rel-15 requirements.

[TS 38.323, clause 5.2.2.1]

In this section, following definitions are used:

- HFN(State Variable): the HFN part (i.e. the number of most significant bits equal to HFN length) of the State Variable;
- SN(State Variable): the SN part (i.e. the number of least significant bits equal to PDCP SN length) of the State Variable;
- RCVD_SN: the PDCP SN of the received PDCP Data PDU, included in the PDU header;
- RCVD_HFN: the HFN of the received PDCP Data PDU, calculated by the receiving PDCP entity;
- RCVD_COUNT: the COUNT of the received PDCP Data PDU = [RCVD_HFN, RCVD_SN].

At reception of a PDCP Data PDU from lower layers, the receiving PDCP entity shall determine the COUNT value of the received PDCP Data PDU, i.e. RCVD_COUNT, as follows:

- if $RCVD_SN < SN(RX_DELIV) - Window_Size$:
 - $RCVD_HFN = HFN(RX_DELIV) + 1$.
- else if $RCVD_SN \geq SN(RX_DELIV) + Window_Size$:
 - $RCVD_HFN = HFN(RX_DELIV) - 1$.
- else:
 - $RCVD_HFN = HFN(RX_DELIV)$;
 - $RCVD_COUNT = [RCVD_HFN, RCVD_SN]$.

After determining the COUNT value of the received PDCP Data PDU = RCVD_COUNT, the receiving PDCP entity shall:

- perform deciphering and integrity verification of the PDCP Data PDU using $COUNT = RCVD_COUNT$;

- if integrity verification fails:
 - indicate the integrity verification failure to upper layer;
 - discard the PDCP Data PDU;
- if RCVD_COUNT < RX_DELIV; or
- if the PDCP Data PDU with COUNT = RCVD_COUNT has been received before:
 - discard the PDCP Data PDU;

If the received PDCP Data PDU with COUNT value = RCVD_COUNT is not discarded above, the receiving PDCP entity shall:

- store the resulting PDCP SDU in the reception buffer;
- if RCVD_COUNT >= RX_NEXT:
 - update RX_NEXT to RCVD_COUNT + 1.
- if *outOfOrderDelivery* is configured:
 - deliver the resulting PDCP SDU to upper layers.
- if RCVD_COUNT = RX_DELIV:
 - deliver to upper layers in ascending order of the associated COUNT value after performing header decompression, if not decompressed before;
 - all stored PDCP SDU(s) with consecutively associated COUNT value(s) starting from COUNT = RX_DELIV;
 - update RX_DELIV to the COUNT value of the first PDCP SDU which has not been delivered to upper layers, with COUNT value > RX_DELIV;
- if *t-Reordering* is running, and if RX_DELIV >= RX_REORD:
 - stop and reset *t-Reordering*.
- if *t-Reordering* is not running (includes the case when *t-Reordering* is stopped due to actions above), and RX_DELIV < RX_NEXT:
 - update RX_REORD to RX_NEXT;
 - start *t-Reordering*.

[TS 38.323, clause 5.2.2.2]

When *t-Reordering* expires, the receiving PDCP entity shall:

- deliver to upper layers in ascending order of the associated COUNT value after performing header decompression, if not decompressed before:
 - all stored PDCP SDU(s) with associated COUNT value(s) < RX_REORD;
 - all stored PDCP SDU(s) with consecutively associated COUNT value(s) starting from RX_REORD;
- update RX_DELIV to the COUNT value of the first PDCP SDU which has not been delivered to upper layers, with COUNT value >= RX_REORD;
- if RX_DELIV < RX_NEXT:
 - update RX_REORD to RX_NEXT;
 - start *t-Reordering*.

[TS 38.323, clause 5.2.2.3]

When the value of the *t-Reordering* is reconfigured by upper layers while the *t-Reordering* is running, the receiving PDCP entity shall:

- update RX_REORD to RX_NEXT;
- stop and restart *t-Reordering*.

7.1.3.5.4.3 Test description

7.1.3.5.4.3.1 Pre-test conditions

Same Pre-test conditions as in clause 7.1.3.0 exception of PDCP parameters according to Table 7.1.3.5.4.3.1-1.

Table 7.1.3.5.4.3.1-1: PDCP parameters

t-Reordering	ms300
--------------	-------

7.1.3.5.4.3.2 Test procedure sequence

Table 7.1.3.5.4.3.2-1: Main behaviour

St	Procedure	Message Sequence		TP	Verdict
		U - S	Message		
1	The SS sends the PDCP SDU #131072 D/C field = 1 (PDCP Data PDU) and PDCP SN = 131072. (Note 1)	<--	(PDCP SDU #131072)	-	-
2	Check: Does the UE transmit a PDCP SDU via the AM RLC entity in the next 1s?	-->	(PDCP SDU)	1	F
3	The SS sends the PDCP SDU #1 D/C field = 1 (PDCP Data PDU) and PDCP SN = 1. The UE starts <i>t-Reordering</i> .	<--	(PDCP SDU #1)	-	-
4	The SS sends the PDCP SDU #2 D/C field = 1 (PDCP Data PDU) and PDCP SN =2.	<--	(PDCP SDU #2)	-	-
5	Wait for 100ms (< configured <i>t-Reordering</i>).	-	-	-	-
6	The SS sends the PDCP SDU #0 D/C field = 1 (PDCP Data PDU) and PDCP SN = 0.	<--	(PDCP SDU #0)	-	-
7	Check: Does the UE transmit the PDCP SDU #0 via the AM RLC entity D/C field = 1 (PDCP Data PDU) and PDCP SN = 0?	-->	(PDCP SDU #0)	2, 3	P
8	Check: Does the UE transmit the PDCP SDU #1 via the AM RLC entity D/C field = 1 (PDCP Data PDU) and PDCP SN = 1?	-->	(PDCP SDU #1)	2, 3	P
9	Check: Does the UE transmit the PDCP SDU #2 via the AM RLC entity D/C field = 1 (PDCP Data PDU) and PDCP SN = 2?	-->	(PDCP SDU #2)	2, 3	P
10	The SS sends the PDCP SDU #4 D/C field = 1 (PDCP Data PDU) and PDCP SN = 4. The UE starts <i>t-Reordering</i> .	<--	(PDCP SDU #4)	-	-
11	Wait for 100ms (< configured <i>t-Reordering</i>)	-	-	-	-
12	The SS sends the PDCP SDU #7 D/C field = 1 (PDCP Data PDU) and PDCP SN = 7.	<--	(PDCP SDU #7)	-	-
13	The SS sends the PDCP SDU #3 D/C field = 1 (PDCP Data PDU) and PDCP SN = 3. The UE restarts <i>t-Reordering</i> timer. Note T ₁	<--	(PDCP SDU #3)	-	-
14	Check: Does the UE transmit the PDCP SDU #3 via the AM RLC entity?	-->	(PDCP SDU #3)	3	P
15	Check: Does the UE transmit the PDCP SDU #4 via the AM RLC entity?	-->	(PDCP SDU #4)	3	P
16	Check 1: Does the UE transmit the PDCP SDU #7 with PDCP SN=5 via the AM RLC entity after <i>t-Reordering</i> expiry? Note T ₂ Check 2: Is (T ₂ – T ₁) > <i>t-Reordering</i> ?	-->	(PDCP SDU #7)	4,5	P
17	The SS sends the PDCP SDU #9 D/C field = 1 (PDCP Data PDU) and PDCP SN = 9. The UE starts <i>t-Reordering</i> .	<--	(PDCP SDU #9)	-	-
18	Wait for 100ms (< configured <i>t-Reordering</i>)	-	-	-	-
19	The SS reconfigures the <i>t-Reordering</i> by sending a NR <i>RRCReconfiguration</i> message. The UE restarts <i>t-Reordering</i> timer. (Note 2) Note T ₃	<--	<i>RRCReconfiguration</i>	-	-
20	The UE transmits a NR <i>RRCReconfigurationComplete</i> message. (Note 3)	-->	<i>RRCReconfigurationComplete</i>	-	-
21	Check 1: Does the UE transmit the PDCP SDU #9 with PDCP SN=6 via the AM RLC entity after <i>t-Reordering</i> expiry? Note T ₄ Check 2: Is (T ₄ – T ₃) > <i>t-Reordering</i> ?	-->	(PDCP SDU #9)	6	P

Note 1: The Reordering Window size is 131072 when 18 bit SN length is used.

Note 2: For EN-DC the NR RRCReconfiguration message is contained in RRCConnectionReconfiguration 36.508 [7], Table 4.6.1-8 using condition EN-DC_Embed_RBConfig.
 Note 3: For EN-DC the NR RRCReconfigurationComplete message is contained in RRCConnectionReconfigurationComplete.

7.1.3.5.4.3.3 Specific message contents

Table 7.1.3.5.4.3.3-1: RRCReconfiguration (step 19, Table 7.1.3.5.4.3.2-1)

Derivation Path: 38.508-1 [4], Table: 4.6.1-13			
Information Element	Value/remark	Comment	Condition
RRCReconfiguration ::= SEQUENCE {			
criticalExtensions CHOICE {			
rrcReconfiguration ::= SEQUENCE {			
radioBearerConfig	RadioBearerConfig		Not EN-DC
secondaryCellGroup	CellGroupConfig		EN-DC
}			
RRCReconfiguration-v1530-IEs ::= SEQUENCE {			
masterCellGroup	CellGroupConfig		Not-EN-DC
}			
}			

Table 7.1.3.5.4.3.3-2: RadioBearerConfig (Table 7.1.3.5.4.3.3-1)

Derivation path: 38.508-1 [4], Table 4.6.3-132			
Information Element	Value/Remark	Comment	Condition
RadioBearerConfig ::= SEQUENCE {			
drb-ToAddModList ::= SEQUENCE (SIZE 1..2) OF DRB-ToAddMod {	1 entry		
DRB-ToAddMod[1] SEQUENCE {		entry 1	
pdcp-Config SEQUENCE {			
drb SEQUENCE {			
outOfOrderDelivery	False		
}			
t-Reordering	ms750		
}			
}			
}			

7.1.3.5.5 PDCP Duplication

7.1.3.5.5.1 Test Purpose (TP)

(1)

```
with { UE in RRC_CONNECTED state and pdcpDuplication is configured and activated}
ensure that {
  when { UE has PDCP SDUs available for transmission}
  then { the UE transmits the PDCP SDUs on both the associated RLC entities }
}
```

(2)

```
with { UE in RRC_CONNECTED state and pdcpDuplication is configured and not activated }
ensure that {
  when { UE receives MAC Control Element to Activate PDCP Duplication on a DRB configured with PDCP duplication }
  then { the UE activates PDCP Duplication on the PDCP associated with the DRB }
}
```

(3)

```

with { UE in RRC_CONNECTED state and pdcpDuplication is configured }
ensure that {
  when { UE has PDCP SDUs available for transmission }
  then { the UE transmits the PDCP SDUs on the primary RLC entity }
}

```

(4)

```

with { UE in RRC_CONNECTED state and pdcpDuplication is configured and activated}
ensure that {
  when { the UE had transmitted the PDCP SDUs on both the associated RLC entities and successful
  delivery of a PDCP Data PDU is confirmed by one of the two associated AM RLC entities}
  then { the other AM RLC entity discards the duplicated PDCP Data PDU}
}

```

7.1.3.5.5.2 Conformance requirements

References: The conformance requirements covered in the present TC are specified in: TS 38.321:5.10, 6.1.3.10 and TS 38.323:5.2.1, 5.11.1, 5.11.2 and TS 38.331: 5.3.5.6.4. Unless otherwise stated these are Rel-15 requirements.

[TS 38.323, clause 5.2.1]

When submitting a PDCP PDU to lower layer, the transmitting PDCP entity shall:

- if the transmitting PDCP entity is associated with one RLC entity:
 - submit the PDCP PDU to the associated RLC entity;
- else, if the transmitting PDCP entity is associated with two RLC entities:
 - if the PDCP duplication is activated:
 - if the PDCP PDU is a PDCP Data PDU:
 - duplicate the PDCP Data PDU and submit the PDCP Data PDU to both associated RLC entities;
 - else:
 - submit the PDCP Control PDU to the primary RLC entity;
 - else:
 - if the two associated RLC entities belong to the different Cell Groups; and
 - if the total amount of PDCP data volume and RLC data volume pending for initial transmission (as specified in TS 38.322 [5]) in the two associated RLC entities is equal to or larger than *ul-DataSplitThreshold*:
 - submit the PDCP PDU to either the primary RLC entity or the secondary RLC entity;
 - else:
 - submit the PDCP PDU to the primary RLC entity.

[TS 38.331, clause 5.3.5.6.4]

The UE shall:

- 1> for each *drb-Identity* value included in the *drb-ToReleaseList* that is part of the current UE configuration; or
- 1> for each *drb-Identity* value that is to be released as the result of full configuration according to 5.3.5.11:
 - 2> release the PDCP entity and the *drb-Identity*;
- 2> if SDAP entity associated with this DRB is configured:
 - 3> indicate the release of the DRB to SDAP entity associated with this DRB (TS 37.324 [24], clause 5.3.3);

2> if the UE is operating in EN-DC:

3> if a new bearer is not added either with NR or E-UTRA with same *eps-BearerIdentity*:

4> indicate the release of the DRB and the *eps-BearerIdentity* of the released DRB to upper layers.

NOTE 1: The UE does not consider the message as erroneous if the *drb-ToReleaseList* includes any *drb-Identity* value that is not part of the current UE configuration.

NOTE 2: Whether or not the RLC and MAC entities associated with this PDCP entity are reset or released is determined by the *CellGroupConfig*.

[TS 38.323, clause 5.11.1]

For the PDCP entity configured with *pdcp-Duplication*, the transmitting PDCP entity shall:

- for SRBs:
 - activate the PDCP duplication;
- for DRBs:
 - if the activation of PDCP duplication is indicated:
 - activate the PDCP duplication;
 - if the deactivation of PDCP duplication is indicated:
 - deactivate the PDCP duplication.

[TS 38.323, clause 5.11.2]

For the PDCP entity configured with *pdcp-Duplication*, the transmitting PDCP entity shall:

- if the successful delivery of a PDCP Data PDU is confirmed by one of the two associated AM RLC entities:
 - indicate to the other AM RLC entity to discard the duplicated PDCP Data PDU;
- if the deactivation of PDCP duplication is indicated:
 - indicate to the secondary RLC entity to discard all duplicated PDCP Data PDUs.

[TS 38.321, clause 5.10]

If one or more DRBs are configured with PDCP duplication, the network may activate and deactivate the PDCP duplication for the configured DRB(s).

The PDCP duplication for the configured DRB(s) is activated and deactivated by:

- receiving the Duplication Activation/Deactivation MAC CE described in subclause 6.1.3.11;
- indication by RRC.

The MAC entity shall for each DRB configured with PDCP duplication:

1> if a Duplication Activation/Deactivation MAC CE is received activating the PDCP duplication of the DRB:

2> indicate the activation of PDCP duplication of the DRB to upper layers.

1> if a Duplication Activation/Deactivation MAC CE is received deactivating the PDCP duplication of the DRB:

2> indicate the deactivation of PDCP duplication of the DRB to upper layers.

7.1.3.5.5.3 Test description

7.1.3.5.5.3.1 Pre-test conditions

System Simulator:

- For NR 5GC NR Cell 1 and NR Cell 10

UE:

- None

Preamble:

- Same Pre-test conditions as in clause 7.1.3.0 and Generic procedure parameter DC bearer (MCG and split).
- For NR 5GC, Same Pre-test conditions as in clause 7.1.3.0 using generic procedure parameter Connectivity (*NR-DC*), Bearers(MCG(s) and Split),

7.1.3.5.5.3.2 Test procedure sequence

Table 7.1.3.5.5.3.2-1: Main behaviour

St	Procedure	Message Sequence		TP	Verdict
		U - S	Message		
1	Void			-	-
2	SS transmits a Duplication Activation MAC CE to activate PDCP Duplication for split DRB.	<--	MAC PDU (Duplication Activation MAC Control Element)		
3	The SS sends a PDCP Data PDU on the split DRB on the AM RLC primary entity.	<--	PDCP DATA PDU	-	-
-	EXCEPTION: Steps 4-4A below occur in any sequence	-	-	-	-
4	Check: Does UE transmit a PDCP Data PDU on the AM RLC primary entity?	-->	PDCP DATA PDU	3	P
4A	Check: Does UE transmit a PDCP Data PDU on the AM RLC secondary entity?	-->	PDCP DATA PDU	2	P
5	SS transmits a Duplication Deactivation MAC CE to deactivate PDCP Duplication for split DRB.	<--	MAC PDU (Duplication Deactivation MAC Control Element)	-	-
6	The SS sends a PDCP Data PDU on the split DRB on the AM RLC primary entity.	<--	PDCP DATA PDU	-	-
7	Check: Does UE transmit a PDCP Data PDU on the AM RLC entity configured on the AM RLC primary entity?	-->	PDCP DATA PDU	3	P
8	The SS transmits an NR <i>RRCReconfiguration</i> message to activate parameters for <i>PdcpDuplication</i> .(Note 2)	<--	<i>RRCReconfiguration</i>	-	-
8A	UE responses NR <i>RRCReconfigurationComplete</i> message.(Note 3)	-->	<i>RRCReconfigurationComplete</i>	-	-
8B	The SS sends a PDCP Data PDU on the split DRB on the AM RLC primary entity.	<--	PDCP DATA PDU	-	-
-	EXCEPTION: Steps 8C-8D below occur in any sequence	-	-	-	-
8C	Check: Does UE transmit a PDCP Data PDU on the AM RLC primary entity?	-->	PDCP DATA PDU	1	P
8D	Check: Does UE transmit a PDCP Data PDU on the AM RLC secondary entity?	-->	PDCP DATA PDU	1	P
9	The SS stops allocating any UL grant for the AM RLC secondary entity.(Note)	-	-	-	-
10	The SS sends a PDCP Data PDU on the split DRB on the AM RLC primary entity.	<--	PDCP DATA PDU	-	-
11	UE transmits a PDCP Data PDU on the AM RLC primary entity	-->	PDCP DATA PDU	-	-
12	The SS resumes normal UL grant allocation for the AM RLC secondary entity.	-	-	-	-
13	Check: Does UE transmit a PDCP Data PDU on the AM RLC primary or secondary entity in next five seconds?	-->	PDCP DATA PDU	4	F
Note 1:	Discard of RLC SDU is not possible if submitted to lower layers. Therefore, Grant is not provided so that RLC SDU is not submitted to lower layers.				
Note 2:	For EN-DC the NR <i>RRCReconfiguration</i> is contained in <i>RRCConnectionReconfiguration</i> Table 7.1.3.5.5.3.3-4				
Note 3:	For EN-DC the NR <i>RRCReconfigurationComplete</i> message is contained in <i>RRCConnectionReconfigurationComplete</i> .				

7.1.3.5.5.3.3 Specific message contents

Table 7.1.3.5.5.3.3-0A: RRCConnectionReconfiguration (step 8, Table 7.1.3.5.5.3.2-1)

Derivation Path: 36.508 [7], Table 4.6.1-8			
Information Element	Value/remark	Comment	Condition
RRCConnectionReconfiguration ::= SEQUENCE {			
criticalExtensions CHOICE {			
c1 CHOICE{			
rrcConnectionReconfiguration-r8 ::= SEQUENCE			
{			
nonCriticalExtension SEQUENCE {			
nonCriticalExtension SEQUENCE {			
nonCriticalExtension SEQUENCE {			
nonCriticalExtension SEQUENCE {			
nonCriticalExtension SEQUENCE {			
nonCriticalExtension SEQUENCE {			
nonCriticalExtension SEQUENCE {			
nr-RadioBearerConfig1-r15	OCTET STRING including <i>RadioBearerConfig-PDCP</i>		
}			
}			
}			
}			
}			
}			
}			
}			
}			

Table 7.1.3.5.5.3.3-0B: RRCReconfiguration (step 8, Table 7.1.3.5.5.3.2-1)

Derivation Path: 38.508-1 [4], Table 4.6.1-13			
Information Element	Value/remark	Comment	Condition
RRCReconfiguration ::= SEQUENCE {			
criticalExtensions CHOICE {			
rrcReconfiguration SEQUENCE {			
nonCriticalExtension SEQUENCE {			
nonCriticalExtension SEQUENCE {			
radioBearerConfig2	OCTET STRING including <i>RadioBearerConfig-PDCP</i>		
}			
}			
}			
}			

Table 7.1.3.5.5.3.3-1: RadioBearerConfig-PDCP (Table 7.1.3.5.5.3.3-0A and Table 7.1.3.5.5.3.3-0B , Step 8)

Derivation Path: TS 38.508-1 [7], Table 4.6.3-132			
Information Element	Value/remark	Comment	Condition
RadioBearerConfig ::= SEQUENCE {			
srb3-ToRelease	Not present		
drb-ToAddModList	Not present		
drb-ToAddModList SEQUENCE (SIZE (1..maxDRB))	1 entry		
OF DRB-ToAddMod {			
DRB-ToAddMod[1] SEQUENCE {		entry 1	
drb-Identity	2		EN-DC
	SCG DRBn		NR
pdcp-Config	PDCP-Config-Split		
}			
}			
drb-ToReleaseList	Not present		
}			

Table 7.1.3.5.5.3.3-2: PDCP-Config-Split (Table 7.1.3.5.5.3.3-1)

Derivation Path: 38.508-1 [4], Table 4.6.3-99 condition Split			
Information Element	Value/remark	Comment	Condition
PDCP-Config ::= SEQUENCE {			
moreThanOneRLC SEQUENCE {			
primaryPath SEQUENCE {			
cellGroup	1		EN-DC
	0		NR
}			
ul-DataSplitThreshold	infinity		
pdcp-Duplication	true		
}			
}			

7.1.3.5.6 PDCP Duplication / 3 RLC entities

7.1.3.5.6.1 Test Purpose (TP)

(1)

```
with { UE in RRC_CONNECTED state and pdcpDuplication is configured and activated}
ensure that {
  when { UE has PDCP SDUs available for transmission}
  then { the UE transmits the PDCP SDUs on all the associated RLC entities}
}
```

(2)

```
with { UE in RRC_CONNECTED state and pdcpDuplication is configured and not activated}
ensure that {
  when { UE receives MAC Control Element to Activate PDCP Duplication on a DRB configured with PDCP
duplication}
  then { the UE activates PDCP Duplication on the PDCP associated with the DRB}
}
```

(3)

```
with { UE in RRC_CONNECTED state and pdcpDuplication is configured}
ensure that {
  when { UE has PDCP SDUs available for transmission}
  then { the UE transmits the PDCP SDUs on the primary RLC entity}
}
```

(4)

```

with { UE in RRC_CONNECTED state and pdcpDuplication is configured and activated}
ensure that {
  when { the UE had transmitted the PDCP SDUs on all the associated RLC entities and successful
  delivery of a PDCP Data PDU is confirmed by one of the associated AM RLC entities}
  then { the other AM RLC entities discard the duplicated PDCP Data PDU}
}

```

(5)

```

with { UE in RRC_CONNECTED state and pdcpDuplication is configured and activated}
ensure that {
  when { UE receives MAC Control Element to deactivate PDCP Duplication on one of the associated RLC
  entity configured with PDCP duplication}
  then { the UE deactivate the PDCP duplication for the indicated associated RLC entity}
}

```

7.1.3.5.6.2 Conformance requirements

References: The conformance requirements covered in the present TC are specified in: TS 38.321:5.10, 6.1.3.11, 6.1.3.32, TS 38.323:5.2.1, 5.11.1, 5.11.2 and TS 38.331: 5.3.5.6.4. Unless otherwise stated these are Rel-16 requirements.

[TS 38.323, clause 5.2.1]

When submitting a PDCP PDU to lower layer, the transmitting PDCP entity shall:

- if the transmitting PDCP entity is associated with one RLC entity:
 - submit the PDCP PDU to the associated RLC entity;
- else, if the transmitting PDCP entity is associated with at least two RLC entities:
 - if the PDCP duplication is activated for the RB:
 - if the PDCP PDU is a PDCP Data PDU:
 - duplicate the PDCP Data PDU and submit the PDCP Data PDU to the associated RLC entities activated for PDCP duplication;
 - else:
 - submit the PDCP Control PDU to the primary RLC entity;
 - else (i.e. the PDCP duplication is deactivated for the RB):
 - if the split secondary RLC entity is configured; and
 - if the total amount of PDCP data volume and RLC data volume pending for initial transmission (as specified in TS 38.322 [5]) in the primary RLC entity and the split secondary RLC entity is equal to or larger than *ul-DataSplitThreshold*:
 - submit the PDCP PDU to either the primary RLC entity or the split secondary RLC entity;
 - else, if the transmitting PDCP entity is associated with the DAPS bearer:
 - if the uplink data switching has not been requested:
 - submit the PDCP PDU to the RLC entity associated with the source cell;
 - else:
 - if the PDCP PDU is a PDCP Data PDU:
 - submit the PDCP Data PDU to the RLC entity associated with the target cell;
 - else:
 - if the PDCP Control PDU is associated with source cell:

- submit the PDCP Control PDU to the RLC entity associated with the source cell;
- else:
 - submit the PDCP Control PDU to the RLC entity associated with the target cell;
- else:
 - submit the PDCP PDU to the primary RLC entity.

[TS 38.323, clause 5.11.1]

For the PDCP entity configured with *pdcp-Duplication*, the transmitting PDCP entity shall:

- for SRBs:
 - activate the PDCP duplication;
- for DRBs:
 - if the activation of PDCP duplication is indicated for the DRB:
 - activate the PDCP duplication for the DRB;
 - if the activation of PDCP duplication is indicated for at least one associated RLC entities:
 - activate the PDCP duplication for the indicated associated RLC entities;
 - activate the PDCP duplication for the DRB;
 - if the deactivation of PDCP duplication is indicated for the DRB:
 - deactivate the PDCP duplication for the DRB;
 - if the deactivation of PDCP duplication is indicated for at least one associated RLC entities:
 - deactivate the PDCP duplication for the indicated associated RLC entities;
 - if all associated RLC entities other than the primary RLC entity are deactivated for PDCP duplication:
 - deactivate the PDCP duplication for the DRB.

[TS 38.323, clause 5.11.2]

For the PDCP entity configured with *pdcp-Duplication*, the transmitting PDCP entity shall:

- if the successful delivery of a PDCP Data PDU is confirmed by one of the associated AM RLC entities:
 - indicate to the other AM RLC entities to discard the duplicated PDCP Data PDU;
- if the deactivation of PDCP duplication is indicated for the DRB:
 - indicate to the RLC entities other than the primary RLC entity to discard all duplicated PDCP Data PDUs;
- if the deactivation of PDCP duplication is indicated for at least one associated RLC entities:
 - indicate to the RLC entities deactivated for PDCP duplication to discard all duplicated PDCP Data PDUs.

[TS 38.321, clause 5.10]

If one or more DRBs are configured with PDCP duplication, the network may activate and deactivate the PDCP duplication for all or a subset of associated RLC entities for the configured DRB(s).

The PDCP duplication for the configured DRB(s) is activated and deactivated by:

- receiving the Duplication Activation/Deactivation MAC CE described in clause 6.1.3.11;
- receiving the Duplication RLC Activation/Deactivation MAC CE described in clause 6.1.3.32;

- indication by RRC.

The PDCP duplication for all or a subset of associated RLC entities for the configured DRB(s) is activated and deactivated by:

- receiving the Duplication RLC Activation/Deactivation MAC CE described in clause 6.1.3.32;
- indication by RRC.

The MAC entity shall for each DRB configured with PDCP duplication:

- 1> if a Duplication Activation/Deactivation MAC CE is received activating the PDCP duplication of the DRB:
 - 2> indicate the activation of PDCP duplication of the DRB to upper layers.
- 1> if a Duplication Activation/Deactivation MAC CE is received deactivating the PDCP duplication of the DRB:
 - 2> indicate the deactivation of PDCP duplication of the DRB to upper layers.
- 1> if a Duplication RLC Activation/Deactivation MAC CE is received activating PDCP duplication for associated RLC entities of a DRB configured with PDCP duplication:
 - 2> indicate the activation of PDCP duplication for the indicated secondary RLC entity(ies) of the DRB to upper layers.
- 1> if a Duplication RLC Activation/Deactivation MAC CE is received deactivating PDCP duplication for associated RLC entities of a DRB configured with PDCP duplication:
 - 2> indicate the deactivation of PDCP duplication for the indicated secondary RLC entity(ies) of the DRB to upper layers.

[TS 38.331, clause 5.3.5.6.4]

The UE shall:

- 1> for each *drb-Identity* value included in the *drb-ToReleaseList* that is part of the current UE configuration; or
- 1> for each *drb-Identity* value that is to be released as the result of full configuration according to 5.3.5.11:
 - 2> release the PDCP entity and the *drb-Identity*;
 - 2> if SDAP entity associated with this DRB is configured:
 - 3> indicate the release of the DRB to SDAP entity associated with this DRB (TS 37.324 [24], clause 5.3.3);
 - 2> if the UE is operating in EN-DC:
 - 3> if a new bearer is not added either with NR or E-UTRA with same *eps-BearerIdentity*:
 - 4> indicate the release of the DRB and the *eps-BearerIdentity* of the released DRB to upper layers.

NOTE 1: The UE does not consider the message as erroneous if the *drb-ToReleaseList* includes any *drb-Identity* value that is not part of the current UE configuration.

NOTE 2: Whether or not the RLC and MAC entities associated with this PDCP entity are reset or released is determined by the *CellGroupConfig*.7.1.3.5.6.3 Test description

7.1.3.5.6.3.1 Pre-test conditions

System Simulator:

- NR Cell 1 is the PCell, NR Cell 3 and NR Cell 6 are the SCells

UE:

- None

Preamble:

- Same Pre-test conditions as in clause 7.1.3.0 and NR Cell 3 and NR Cell 6 are configured as NR Active Scells.

7.1.3.5.6.3.2 Test procedure sequence

Table 7.1.3.5.6.3.2-1: Main behaviour

St	Procedure	Message Sequence		TP	Verdict
		U - S	Message		
1	SS transmits a MAC CE to activate PDCP Duplication for split DRB.		MAC PDU (Duplication RLCActivation MAC Control Element)		
2	The SS sends a PDCP Data PDU on the split DRB on the AM RLC primary entity.	<--	PDCP DATA PDU	-	-
-	EXCEPTION: Steps 3-4 below occur in any sequence	-	-	-	-
3	Check: Does UE transmit a PDCP Data PDU on the AM RLC primary entity?	-->	PDCP DATA PDU	3	P
4	Check: Does UE transmit a PDCP Data PDU on the associated AM RLC entities?	-->	PDCP DATA PDU	2	P
5	SS transmits a MAC CE to deactivate PDCP Duplication for split DRB.	<--	MAC PDU (Duplication RLC Deactivation MAC Control Element)	-	-
6	The SS sends a PDCP Data PDU on the split DRB on the AM RLC primary entity.	<--	PDCP DATA PDU	-	-
7	Check: Does UE transmit a PDCP Data PDU on the indicated associated RLC entity configured on the AM RLC primary entity?	-->	PDCP DATA PDU	5	F
8	SS transmits a MAC CE to deactivate PDCP Duplication for split DRB.	<--	MAC PDU (Duplication RLC Deactivation MAC Control Element)	-	-
9	Check: Does UE transmit a PDCP Data PDU on the AM RLC primary entity?	-->	PDCP DATA PDU	3	P
10	The SS transmits an NR <i>RRCReconfiguration</i> message to activate parameters for PdcpDuplication.	<--	<i>RRCReconfiguration</i>	-	-
11	UE responses NR <i>RRCReconfigurationComplete</i> message.	-->	<i>RRCReconfigurationComplete</i>	-	-
12	The SS sends a PDCP Data PDU on the split DRB on the AM RLC primary entity.	<--	PDCP DATA PDU	-	-
-	EXCEPTION: Steps 13-14 below occur in any sequence	-	-	-	-
13	Check: Does UE transmit a PDCP Data PDU on the AM RLC primary entity?	-->	PDCP DATA PDU	1	P
14	Check: Does UE transmit a PDCP Data PDU on the associated AM RLC entities?	-->	PDCP DATA PDU	1	P
15	The SS stops allocating any UL grant for the associated AM RLC entities.(Note)	-	-	-	-
16	The SS sends a PDCP Data PDU on the split DRB on the AM RLC primary entity.	<--	PDCP DATA PDU	-	-
17	UE transmits a PDCP Data PDU on the AM RLC primary entity	-->	PDCP DATA PDU	-	-
18	The SS resumes normal UL grant allocation for the associated AM RLC entities.	-	-	-	-
19	Check: Does UE transmit a PDCP Data PDU on the AM RLC primary or the associated AM RLC entities in next five seconds?	-->	PDCP DATA PDU	4	F

Note: Discard of RLC SDU is not possible if submitted to lower layers. Therefore, Grant is not provided so that RLC SDU is not submitted to lower layers.

7.1.3.5.6.3.3 Specific message contents

Table 7.1.3.5.6.3.3-1: RadioBearerConfig (step 10, Table 7.1.3.5.6.3.2-1)

Derivation Path: TS 38.508-1 [7], Table 4.6.3-132			
Information Element	Value/remark	Comment	Condition
RadioBearerConfig ::= SEQUENCE {			
srb3-ToRelease	Not present		
drb-ToAddModList SEQUENCE (SIZE (1..maxDRB))	1 entry		
OF DRB-ToAddMod {			
DRB-ToAddMod[1] SEQUENCE {		entry 1	
drb-Identity	DRBn		
pdcp-Config	PDCP-Config		
}			
}			
}			

Table 7.1.3.5.6.3.3-2: PDCP-Config (Table 7.1.3.5.6.3.3-1)

Derivation Path: 38.508-1 [4], Table 4.6.3-99 condition Split			
Information Element	Value/remark	Comment	Condition
PDCP-Config ::= SEQUENCE {			
t-Reordering	Not present		
moreThanTwoRLC-DRB-r16 SEQUENCE {			
duplicationState-r16 SEQUENCE (SIZE (3))	3 entries		
duplicationState-r16[1]	true		
duplicationState-r16[2]	true		
duplicationState-r16[3]	true		
}			
}			

7.1.3.5.7 Ethernet header compression and decompression / Correct functionality of ethernet header compression and decompression

Editor's note: Configuration of ethernet protocol is FFS.

7.1.3.5.7.1 Test Purpose (TP)

(1)

```
with { UE in RRC_CONNECTED state }
ensure that {
  when { Ethernet header compression functionality is taken into use on DRB }
  then { UE performs correct ethernet header compression and decompression function on DRB }
}
```

7.1.3.5.7.2 Conformance requirements

References: The conformance requirements covered in the present TC are specified in: TS 38.323, clause 5.12. These are Rel-16 requirements.

[TS 38.323, clause 5.12.2]

PDCP entities associated with DRBs can be configured by upper layers TS 38.331 [3] to use EHC. Each PDCP entity carrying user plane data may be configured to use EHC. Every PDCP entity uses at most one EHC compressor instance and at most one EHC decompressor instance.

[TS 38.323, clause 5.12.3]

The usage and definition of the parameters shall be as specified below.

- MAX_CID_EHC_UL: This is the maximum CID value that can be used for uplink. One CID value shall always be reserved for uncompressed flows. The parameter MAX_CID_EHC_UL is configured by upper layers (*maxCID-EHC-UL* in TS 38.331 [3]);

[TS 38.323, clause 5.12.4]

If EHC is configured, the EHC protocol generates two types of output packets:

- EHC compressed packets (i.e. EHC full header packets and EHC compressed header packets), each associated with one PDCP SDU;
- standalone packets not associated with a PDCP SDU, i.e. EHC feedback.

An EHC compressed packet is associated with the same PDCP SN and COUNT value as the related PDCP SDU. The header compression is not applicable to the SDAP header and the SDAP Control PDU if included in the PDCP SDU.

EHC feedback are not associated with a PDCP SDU. They are not associated with a PDCP SN and are not ciphered.

[TS 38.323, clause 5.12.5]

If EHC is configured by upper layers for PDCP entities associated with user plane data, the PDCP Data PDUs are decompressed by the EHC protocol after performing deciphering as explained in clause 5.8. The header decompression is not applicable to the SDAP header and the SDAP Control PDU if included in the PDCP Data PDU.

[TS 38.323, clause 5.12.6.1]

When an EHC feedback is generated by the EHC protocol, the transmitting PDCP entity shall:

- submit to lower layers the corresponding PDCP Control PDU as specified in clause 6.2.3.3 i.e. without associating a PDCP SN, nor performing ciphering.

[TS 38.323, clause 5.12.6.2]

At reception of a PDCP Control PDU for EHC feedback from lower layers, the receiving PDCP entity shall:

- deliver the corresponding EHC feedback to the EHC protocol without performing deciphering.

7.1.3.5.7.3 Test description

7.1.3.5.7.3.1 Pre-test conditions

Pre-test conditions as in clause 7.1.3.0 with condition *pc_NG_RAN_NR*, one PDN/PDU session and message with condition UM used for step 7 in 4.5.4.2 according to [4].

7.1.3.5.7.3.2 Test procedure sequence

Table 7.1.3.5.7.3.2-1: Main behaviour

St	Procedure	Message Sequence		TP	Verdict
		U - S	Message		
1	SS transmits an <i>RRCReconfiguration</i> message to configure DRB to use ethernet header compression.	<--	<i>RRCReconfiguration</i>	-	-
2	UE transmits <i>RRCReconfigurationComplete</i> message to confirm that reconfiguration with ethernet header compression configuration is completed.	-->	<i>RRCReconfigurationComplete</i>	-	-
3	SS Transmits a ciphered PDCP Data PDU with unique Context ID containing full header ethernet packet.	<--	PDCP Data PDU #0	-	-
4	CHECK: Does UE transmit unciphered EHC feedback packet with Context ID set in step 3?	-->	PDCP Control PDU #0	1	P
5	CHECK: Does UE transmit ciphered looped back PDCP Data PDU with unique Context ID containing full header ethernet packet?	-->	PDCP Data PDU #0	1	P
6	SS Transmits unciphered EHC feedback packet with Context ID set in step 5	<--	PDCP Control PDU #0	-	-
7	SS Transmits a ciphered PDCP Data PDU with unique Context ID set in step 3 containing compressed header ethernet packet.	-->	PDCP Data PDU #1	-	-
8	CHECK: Does UE transmit ciphered looped back PDCP Data PDU with Context ID set in step 5 containing compressed header ethernet packet?	-->	PDCP Data PDU #1	1	P

7.1.3.5.7.3.3 Specific message contents

Table 7.1.3.5.7.3.3-1: *RRCReconfiguration* (step 1, Table 7.1.3.5.7.3.2-1)

Derivation Path: TS 38.508 [4], clause 4.6.1, table 4.6.1-13 <i>RRCReconfiguration</i>			
Information Element	Value/remark	Comment	Condition
<i>RRCReconfiguration</i> ::= SEQUENCE {			
criticalExtensions CHOICE {			
<i>rrcReconfiguration</i> SEQUENCE {			
radioBearerConfig	RadioBearerConfig-EHC		
}			
}			
}			

Table 7.1.3.5.7.3.3-2: *RadioBearerConfig-EHC* (Table 7.1.3.5.7.3.3-1)

Derivation Path: TS 38.331 [12], clause 6.3.2			
Information Element	Value/remark	Comment	Condition
<i>RadioBearerConfig</i> ::= SEQUENCE {			
drb-ToAddModList SEQUENCE (SIZE (1..maxDRB))	1 entry		
OF DRB-ToAddMod {			
DRB-ToAddMod[1] SEQUENCE {		entry 1	
drb-Identity	DRB-Identity for DRB created in pre-test conditions		
pdcp-Config	PDCP-Config-EHC		
}			
}			
}			

Table 7.1.3.5.7.3.3-3: *PDCP-Config-EHC*

Derivation Path: TS38.331 [12], clause 6.3.2			
Information Element	Value/remark	Comment	Condition
PDCP-Config ::= SEQUENCE {			
ethernetHeaderCompression-r16 SEQUENCE {			
ehc-Common-r16 SEQUENCE {			
ehc-CID-Length-r16	bits15		
}			
ehc-Downlink-r16 SEQUENCE {			
drb-ContinueEHC-DL-r16	true		
}			
ehc-Uplink-r16 SEQUENCE {			
maxCID-EHC-UL-r16	32767		
drb-ContinueEHC-UL-r16	true		
}			
}			
}			

7.1.4 SDAP

7.1.4.1 SDAP Data Transfer and PDU Header Handling UL/DL

7.1.4.1.1 Test Purpose (TP)

(1)

```
with { UE in RRC_CONNECTED state with multiple DRB's established, each mapping more than one QoS flow }
ensure that {
  when { UE receives an SDAP PDU with SDAP header }
  then { UE SDAP entity retrieves the SDAP SDU from the SDAP PDU and delivers it to upper layer }
}
```

(2)

```
with { UE in RRC_CONNECTED state with multiple DRB's established configured with UL SDAP header, each mapping more than one QoS flow configured by RRC }
ensure that {
  when { UE has to transmit a SDAP PDU with header to be included }
  then { UE builds an SDAP PDU from the SDAP SDU including the header, and maps it to the DRB as per stored DRB mapping rule for the QoS flow }
}
```

(3)

```
with { UE in RRC_CONNECTED state with multiple DRB's and QoS flows established }
ensure that {
  when { UE receives a SDAP PDU with SDAP header and RDI fields set to 1 }
  then { the UE stores the QoS flow to DRB mapping of the DL SDAP PDU as the QoS flow to DRB mapping rule for the UL and uses it for further UL SDAP PDU transmissions }
}
```

(4)

```
with { UE in RRC_CONNECTED state with multiple DRB's and QoS flows established }
ensure that {
  when { UE receives a SDAP PDU with SDAP header and RDI field set to 1 and the stored QoS flow to DRB mapping rule for the QoS flow is different from the QoS flow to DRB mapping of the DL SDAP data PDU }
  then { the UE stores the QoS flow to DRB mapping of the DL SDAP PDU as the QoS flow to DRB mapping rule for the UL, to be used for further UL SDAP PDU transmissions and transmits an end-marker control PDU for the QoS flow on the old DRB }
}
```

(5)

```

with { UE in RRC_CONNECTED state with multiple DRB's and QoS flows established with QoS flow to DRB
mapping }
ensure that {
  when { RRC configures a new QoS flow to DRB mapping, different from the existing mapping } then
then { the UE stores the QoS flow to DRB mapping to be used for further UL SDAP PDU transmissions
and transmits an end-marker control PDU for the QoS flow on the old DRB }
}

```

7.1.4.1.2 Conformance requirements

References: The conformance requirements covered in the present test case are specified in: TS 37.324, clauses 5.2.1, 5.2.2, 5.3.1, 5.3.2, 6.2.2.1, 6.2.2.2, 6.2.2.3, 6.2.3 and 6.3.4, TS 24.501 clause 6.2.5.1.3. Unless otherwise stated these are Rel-15 requirements.

[TS 37.324 clause 5.2.1]

At the reception of an SDAP SDU from upper layer for a QoS flow, the transmitting SDAP entity shall:

- if there is no stored QoS flow to DRB mapping rule for the QoS flow as specified in the subclause 5.3:
 - map the SDAP SDU to the default DRB;
- else:
 - map the SDAP SDU to the DRB according to the stored QoS flow to DRB mapping rule;
- if the DRB to which the SDAP SDU is mapped is configured by RRC (3GPP TS 38.331 [3]) with the presence of SDAP header,
 - construct the UL SDAP data PDU as specified in the subclause 6.2.2.3;
- else:
 - construct the UL SDAP data PDU as specified in the subclause 6.2.2.1;
- submit the constructed UL SDAP data PDU to the lower layers.

NOTE 1: UE behaviour is not defined if there is neither a default DRB nor a stored QoS flow to DRB mapping rule for the QoS flow.

NOTE 2: Default DRB is always configured with UL SDAP header (3GPP TS 38.331 [3]).

[TS 37.324 clause 5.2.2]

At the reception of an SDAP data PDU from lower layers for a QoS flow, the receiving SDAP entity shall:

- if the DRB from which this SDAP data PDU is received is configured by RRC (3GPP TS 38.331 [3]) with the presence of SDAP header:
 - perform reflective QoS flow to DRB mapping as specified in the subclause 5.3.2;
 - perform RQI handling as specified in the subclause 5.4;
 - retrieve the SDAP SDU from the DL SDAP data PDU as specified in the subclause 6.2.2.2.
- else:
 - retrieve the SDAP SDU from the DL SDAP data PDU as specified in the subclause 6.2.2.1;
- deliver the retrieved SDAP SDU to the upper layer.

[TS 37.324 clause 5.3.1]

When RRC (3GPP TS 38.331 [3]) configures an UL QoS flow to DRB mapping rule for a QoS flow, the SDAP entity shall:

- if the SDAP entity has already been established and there is no stored QoS flow to DRB mapping rule for the QoS flow and a default DRB is configured:
 - construct an end-marker control PDU, as specified in the subclause 6.2.3, for the QoS flow;
 - map the end-marker control PDU to the default DRB;
 - submit the end-marker control PDU to the lower layers.
- if the stored UL QoS flow to DRB mapping rule is different from the configured QoS flow to DRB mapping rule for the QoS flow and the DRB according to the stored QoS flow to DRB mapping rule is configured by RRC (3GPP TS 38.331 [3]) with the presence of UL SDAP header:
 - construct an end-marker control PDU, as specified in the subclause 6.2.3, for the QoS flow;
 - map the end-marker control PDU to the DRB according to the stored QoS flow to DRB mapping rule;
 - submit the end-marker control PDU to the lower layers.
- store the configured UL QoS flow to DRB mapping rule for the QoS flow.

When RRC (3GPP TS 38.331 [3]) releases an UL QoS flow to DRB mapping rule for a QoS flow, the SDAP entity shall:

- remove the UL QoS flow to DRB mapping rule for the QoS flow.

[TS 37.324 clause 5.3.2]

For each received DL SDAP dataPDU with RDI set to 1, the SDAP entity shall:

- process the QFI field in the SDAP header and determine the QoS flow;
- if there is no stored QoS flow to DRB mapping rule for the QoS flow and a default DRB is configured:
 - construct an end-marker control PDU, as specified in the subclause 6.2.3, for the QoS flow;
 - map the end-marker control PDU to the default DRB;
 - submit the end-marker control PDU to the lower layers;
- if the stored QoS flow to DRB mapping rule for the QoS flow is different from the QoS flow to DRB mapping of the DL SDAP data PDU and the DRB according to the stored QoS flow to DRB mapping rule is configured by RRC (3GPP TS 38.331 [3]) with the presence of UL SDAP header:
 - construct an end-marker control PDU, as specified in the subclause 6.2.3, for the QoS flow;
 - map the end-marker control PDU to the DRB according to the stored QoS flow to DRB mapping rule;
 - submit the end-marker control PDU to the lower layers;
- store the QoS flow to DRB mapping of the DL SDAP data PDU as the QoS flow to DRB mapping rule for the UL.

[TS 37.324 clause 6.2.2.1]

An SDAP PDU consists only of a data field and does not consist of any SDAP header, as described in Figure 6.2.2.1-1.

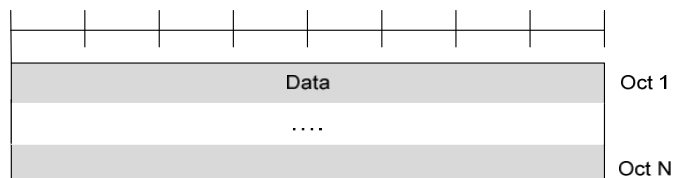

Figure 6.2.2.1-1: SDAP Data PDU format without SDAP header

[TS 37.324 clause 6.2.2.2]

Figure 6.2.2.2 – 1 shows the format of SDAP Data PDU of DL with SDAP header being configured.

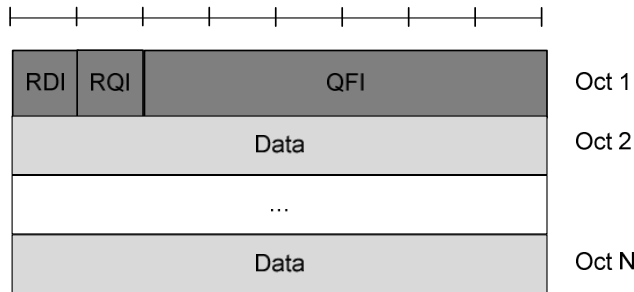

Figure 6.2.2.2-1: DL SDAP Data PDU format with SDAP header

[TS 37.324 clause 6.2.2.3]

Figure 6.2.2.3 – 1 shows the format of SDAP Data PDU of UL with SDAP header being configured.

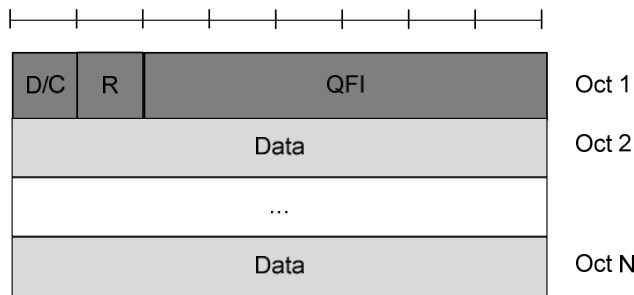

Figure 6.2.2.3-1: UL SDAP Data PDU format with SDAP header

[TS 37.324 clause 6.2.3]

Figure 6.2.3 – 1 shows the format of End-Marker Control PDU.

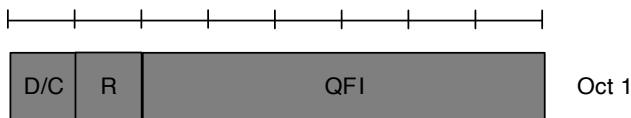

Figure 6.2.2.3-1: UL SDAP Data PDU format with SDAP header

[TS 37.324 clause 6.3.4]

Length: 6 bits

The QFI field indicates the ID of the QoS flow (3GPP TS 23.501 [4]) to which the SDAP PDU belongs.

[TS 24.501 clause 6.2.5.1.3]

For PDU session of IPv4, IPv6, IPv4v6 or Ethernet PDU session type, upon receiving an UL user data packet from the upper layers for transmission via a PDU session, the UE shall attempt to associate the UL user data packet with:

- a) the QFI of a signalled QoS rule associated with the PDU session which has a set of packet filters containing a packet filter for UL direction matching the UL user data packet or containing a packet filter for both UL and DL directions matching the UL user data packet; or
- b) the QFI of a derived QoS rule associated with the PDU session which has the packet filter for UL direction matching the UL user data packet;

by evaluating the QoS rules in increasing order of their precedence values until the UL user data packet is associated with a QFI or all QoS rules are evaluated.

For PDU session of unstructured PDU session type, upon receiving an UL user data packet from the upper layers for transmission via a PDU session, the UE shall associate the UL user data packet with the QFI of the default QoS rule associated with the PDU session.

If the UL user data packet is associated with a QFI, the UE shall pass the QFI along the UL user data packet to the lower layers for transmission.

NOTE: Marking of the UL user data packet with the QFI is performed by the lower layers.

If all QoS rules are evaluated and the UL user data packet is not associated with a QFI, the UE shall discard the UL user data packet.

7.1.4.1.3 Test description

7.1.4.1.3.1 Pre-test conditions

System Simulator:

- NR Cell 1

UE:

- None.

Preamble:

The UE is in 5GS state 3N-A with one PDU session active according to TS 38.508-1 [4], clause 4.4A.3 Table 4.4A.3-1 and using the message condition UE TEST LOOP MODE B active with IP PDU delay = 1 second, to return one SDAP SDU per DL SDAP SDU. 2 DRBs are configured where DRB j is defined as default DRB. The NAS QoS rules for the QoS flows with QFI=1, QFI=2, QFI=5 and QFI=6 are configured. QoS flows with QFI=5 and QFI=6 are mapped to DRB j, QoS flows with QFI=1 and QFI=2 are mapped to DRB k

7.1.4.1.3.2 Test procedure sequence

Table 7.1.4.1.3.2-1: Main behaviour

St	Procedure	Message Sequence		TP	Verdict
		U - S	Message		
1	The SS sends the SDAP Data PDU with SDAP header on DRB k and the following content to the UE: RDI=0, RQI=0, QFI=1.	<--	SDAP DL Data PDU	-	-
2	Check: Does the UE re-transmit SDAP Data PDU on DRB k with SDAP header as per the stored DRB mapping flow with QFI=1?	-->	SDAP UL Data PDU	1,2	P
3	The SS sends the SDAP Data PDU with SDAP header on DRB k and the following content to the UE: RDI=1, RQI=0, QFI=5.	<--	SDAP DL Data PDU	-	-
-	EXCEPTION: In parallel to the event described in step 4 the events specified in Table 7.1.4.1.3.2-2 shall take place.	-	-	-	-
4	Check: Does the UE re-transmit SDAP Data PDU on DRB k with SDAP header as per the stored DRB mapping Flow with QFI=5?	-->	SDAP UL Data PDU	3	P
5	The SS transmits an RRCReconfiguration message including a PDU SESSION MODIFICATION COMMAND	<--	<i>RRCReconfiguration</i> (PDU SESSION MODIFICATION COMMAND)	-	-
-	EXCEPTION: In parallel to the event described in step 6 the events specified in Tables 7.1.4.1.3.2-3 and 7.1.4.1.3.2-4 shall take place.	-	-	-	-
6	The UE transmits an RRCReconfigurationComplete message.	-->	<i>RRCReconfigurationComplete</i>	-	-
7	The SS sends the SDAP Data PDU with SDAP header on DRB k and the following content to the UE: RDI=0, RQI=0, QFI=4.	<--	SDAP DL Data PDU	-	-
8	Check: Does the UE re-transmit SDAP Data PDU on DRB k with SDAP header as per the stored DRB mapping Flow with QFI=4?	-->	SDAP UL Data PDU	5	P

Table 7.1.4.1.3.2-2: Parallel behaviour

St	Procedure	Message Sequence		TP	Verdict
		U - S	Message		
1	Check: Does the UE transmit End-Marker Control PDU on DRB j for QFI=5?	-->	SDAP UL Control PDU	4	P

Table 7.1.4.1.3.2-3: Parallel behaviour

St	Procedure	Message Sequence		TP	Verdict
		U - S	Message		
1	Check: Does the UE transmit End-Marker Control PDU on DRB j for QFI=4?	-->	SDAP UL Control PDU	5	P

Table 7.1.4.1.3.2-4: Parallel behaviour

St	Procedure	Message Sequence		TP	Verdict
		U - S	Message		
1	The UE Transmits PDU SESSION MODIFICATION COMPLETE	-	-	-	-

7.1.4.1.3.3 Specific message contents

Table 7.1.4.1.3.3-1: RadioBearerConfig-DRB (Preamble)

Derivation Path: TS 38.508-1 [4], table 4.6.3-132 and condition NR			
Information Element	Value/remark	Comment	Condition
RadioBearerConfig ::= SEQUENCE {			
drb-ToAddModList SEQUENCE (SIZE (1..maxDRB))	2 entries		
OF DRB-ToAddMod {			
DRB-ToAddMod[1] SEQUENCE {		entry 1	
cnAssociation CHOICE {			
sdap-Config SEQUENCE {			
pdu-Session	The same as the PDU session ID in PDU SESSION ESTABLISHMENT REQUEST		
sdap-HeaderDL	present		
sdap-HeaderUL	present		
defaultDRB	false		
mappedQoS-FlowsToAdd SEQUENCE {			
QFI	1		
QFI	2		
}			
}			
}			
drb-Identity	k	k is allocated according to internal TTCN mapping	
}			
DRB-ToAddMod[2] SEQUENCE {		entry 2	
cnAssociation CHOICE {			
sdap-Config ::= SEQUENCE {			
pdu-Session	The same as the PDU session ID in PDU SESSION ESTABLISHMENT REQUEST		
sdap-HeaderDL	present		
sdap-HeaderUL	present		
defaultDRB	true		
mappedQoS-FlowsToAdd SEQUENCE {			
QFI	5		
QFI	6		
}			
}			
}			
}			
drb-Identity	j	j is allocated according to internal TTCN mapping	
}			
}			
}			

Table 7.1.4.1.3.3-2: RadioBearerConfig-DRB (step 5, Table 7.1.4.1.3.2-1)

Derivation Path: TS 38.508-1 [4], table 4.6.3-132 and condition NR			
Information Element	Value/remark	Comment	Condition
RadioBearerConfig ::= SEQUENCE {	-	-	-
drb-ToAddModList SEQUENCE (SIZE (1..maxDRB)) OF DRB-ToAddMod {	1 entry	BID is the total number of established DRBs in the UE, before applying the contents of this IE	-
DRB-ToAddMod[1] SEQUENCE {		entry 1	-
cnAssociation CHOICE {	-	-	-
sdap-Config ::= SEQUENCE {	-	-	-
pdu-Session	The same as the PDU session ID in PDU SESSION ESTABLISHMENT REQUEST	-	-
sdap-HeaderDL	present	-	-
sdap-HeaderUL	present	-	-
defaultDRB	false	-	-
mappedQoS-FlowsToAdd ::= SEQUENCE {	-	-	-
QFI	4	-	-
}	-	-	-
}	-	-	-
drb-Identity	k	-	-
}	-	-	-
}	-	-	-
}	-	-	-
}	-	-	-

Table 7.1.4.1.3.3-3: PDU SESSION MODIFICATION COMMAND (step 5, Table 7.1.4.1.3.2-1)

Derivation Path: TS 38.508-1, table 4.7.2-9			
Information Element	Value/remark	Comment	Condition
PDU session ID	The same as the PDU session ID in PDU SESSION ESTABLISHMENT REQUEST		
Authorized QoS rules	One entry		
QoS rule [1]	Reference QoS rule #4a as defined in Table 4.8.2.1-4a.	QFI=4	
Authorized QoS flow descriptions	One entry		
QoS flow [1]	Reference QoS flow #2a as defined in Table 4.8.2.3-2a.	QFI=4	

Table 7.1.4.1.3.3-4: PDU SESSION ESTABLISHMENT ACCEPT (Preamble)

Derivation Path: TS 38.508-1, table 4.7.2-2			
Information Element	Value/remark	Comment	Condition
PDU session ID	The same as the PDU session ID in PDU SESSION ESTABLISHMENT REQUEST		
Authorized QoS rules	4 entries		
QoS rule [1]	Reference QoS rule #3 as defined in Table 4.8.2.1-3.	QFI=1	
QoS rule [2]	Reference QoS rule #4 as defined in Table 4.8.2.1-4.	QFI=2	
QoS rule [3]	Reference QoS rule #5 as defined in Table 4.8.2.1-5.	QFI=5	
QoS rule [4]	Reference QoS rule #6 as defined in Table 4.8.2.1-6.	QFI=6	
Mapped EPS Bearer contexts	Not Present		
Authorized QoS flow descriptions	4 entries		
QoS flow [1]	Reference QoS flow #1 as defined in Table 4.8.2.3-1.	QFI=1	
QoS flow [2]	Reference QoS flow #2 as defined in Table 7.1.4.1.3.3-5	QFI=2	
QoS flow [3]	Reference QoS flow #3 as defined in Table 7.1.4.1.3.3-6	QFI=5	
QoS flow [4]	Reference QoS flow #4 as defined in Table 4.8.2.3-4.	QFI=6	

Table 7.1.4.1.3.3-5: Reference QoS flow #1 (Preamble)

Derivation Path: TS 38.508-1, table 4.8.2.3-1			
Information Element	Value/remark	Comment	Condition
QoS flow descriptions			
QFI	'00 0001'B	QFI 1	
Operation code	'001'B	Create new QoS flow description	
E bit	'1'B	Parameters list is included	
Number of parameters	'00 0001'B	1 parameter	
5QI	'0000 1001'B	5QI 9	

Table 7.1.4.1.3.3-6: Reference QoS flow #2 (Preamble)

Derivation Path: TS 38.508-1, table 4.8.2.3-2			
Information Element	Value/remark	Comment	Condition
QoS flow descriptions			
QoS flow description			
QFI	'00 0010'B	QFI 2	
Operation code	'001'B	Create new QoS flow description	
E bit	'1'B	Parameters list is included	
Number of parameters	'00 0001'B	1 parameter	
5QI	'0000 0101'B	5QI 5	

7.1.4.2 SDAP Data Transfer handling without Header UL/DL

7.1.4.2.1 Test Purpose (TP)

(1)

```
with { UE in RRC_CONNECTED state with multiple DRB's established. SDAP configured without header and
no stored QoS flow mapping }
ensure that{
  when { UE receives a SDAP SDU from upper layers }
  then { UE SDAP entity transmits the SDAP PDU with header on default DRB }
```

(2)

```
with { UE in RRC_CONNECTED state with multiple DRB's established. SDAP configured without header and
no stored QoS flow mapping }
ensure that {
  when { UE SDAP receives from RRC new QoS Flow mapping }
  then { UE SDAP entity transmits an end-marker control PDU for the QoS flow on default DRB }
}
```

(3)

```
with { UE in RRC_CONNECTED state with multiple DRB's established. SDAP configured without header and
stored QoS flow mapping configured by RRC }
ensure that{
  when { UE receives a SDAP SDU from upper layers }
  then { UE SDAP entity transmits the SDAP PDU without header on non default DRB as per configured
QoS flow mapping}
```

7.1.4.2.2 Conformance requirements

References: The conformance requirements covered in the present test case are specified in: TS 37.324, clauses 5.2.1, 5.2.2, 5.3.1, 6.2.2.1 and 6.2.3, TS 24.501 clause 6.2.5.1.3. Unless otherwise stated these are Rel-15 requirements.

[TS 37.324 clause 5.2.1]

At the reception of an SDAP SDU from upper layer for a QoS flow, the transmitting SDAP entity shall:

- if there is no stored QoS flow to DRB mapping rule for the QoS flow as specified in the subclause 5.3:
 - map the SDAP SDU to the default DRB;
- else:
 - map the SDAP SDU to the DRB according to the stored QoS flow to DRB mapping rule;
- if the DRB to which the SDAP SDU is mapped is configured by RRC (3GPP TS 38.331 [3]) with the presence of SDAP header,
 - construct the UL SDAP data PDU as specified in the subclause 6.2.2.3;
- else:
 - construct the UL SDAP data PDU as specified in the subclause 6.2.2.1;
- submit the constructed UL SDAP data PDU to the lower layers.

NOTE 1: UE behaviour is not defined if there is neither a default DRB nor a stored QoS flow to DRB mapping rule for the QoS flow.

NOTE 2: Default DRB is always configured with UL SDAP header (3GPP TS 38.331 [3]).

[TS 37.324 clause 5.2.2]

At the reception of an SDAP data PDU from lower layers for a QoS flow, the receiving SDAP entity shall:

- if the DRB from which this SDAP data PDU is received is configured by RRC (3GPP TS 38.331 [3]) with the presence of SDAP header:
 - perform reflective QoS flow to DRB mapping as specified in the subclause 5.3.2;
 - perform RQI handling as specified in the subclause 5.4;
 - retrieve the SDAP SDU from the DL SDAP data PDU as specified in the subclause 6.2.2.2.
- else:
 - retrieve the SDAP SDU from the DL SDAP data PDU as specified in the subclause 6.2.2.1;
- deliver the retrieved SDAP SDU to the upper layer.

[TS 37.324 clause 5.3.1]

When RRC (3GPP TS 38.331 [3]) configures an UL QoS flow to DRB mapping rule for a QoS flow, the SDAP entity shall:

- if the SDAP entity has already been established and there is no stored QoS flow to DRB mapping rule for the QoS flow and a default DRB is configured:
 - construct an end-marker control PDU, as specified in the subclause 6.2.3, for the QoS flow;
 - map the end-marker control PDU to the default DRB;
 - submit the end-marker control PDU to the lower layers.
- if the stored UL QoS flow to DRB mapping rule is different from the configured QoS flow to DRB mapping rule for the QoS flow and the DRB according to the stored QoS flow to DRB mapping rule is configured by RRC (3GPP TS 38.331 [3]) with the presence of UL SDAP header:
 - construct an end-marker control PDU, as specified in the subclause 6.2.3, for the QoS flow;
 - map the end-marker control PDU to the DRB according to the stored QoS flow to DRB mapping rule;
 - submit the end-marker control PDU to the lower layers.
- store the configured UL QoS flow to DRB mapping rule for the QoS flow.

When RRC (3GPP TS 38.331 [3]) releases an UL QoS flow to DRB mapping rule for a QoS flow, the SDAP entity shall:

- remove the UL QoS flow to DRB mapping rule for the QoS flow.

[TS 37.324 clause 6.2.2.1]

An SDAP PDU consists only of a data field and does not consist of any SDAP header, as described in Figure 6.2.2.1-1.

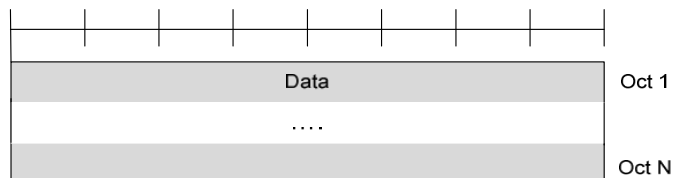

Figure 6.2.2.1-1: SDAP Data PDU format without SDAP header

[TS 37.324 clause 6.2.3]

Figure 6.2.3 – 1 shows the format of End-Marker Control PDU.

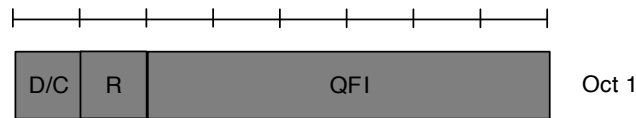

Figure 6.2.3-1: End-Marker Control PDU

[TS 24.501 clause 6.2.5.1.3]

For PDU session of IPv4, IPv6, IPv4v6 or Ethernet PDU session type, upon receiving an UL user data packet from the upper layers for transmission via a PDU session, the UE shall attempt to associate the UL user data packet with:

- a) the QFI of a signalled QoS rule associated with the PDU session which has a set of packet filters containing a packet filter for UL direction matching the UL user data packet or containing a packet filter for both UL and DL directions matching the UL user data packet; or
- b) the QFI of a derived QoS rule associated with the PDU session which has the packet filter for UL direction matching the UL user data packet;

by evaluating the QoS rules in increasing order of their precedence values until the UL user data packet is associated with a QFI or all QoS rules are evaluated.

For PDU session of unstructured PDU session type, upon receiving an UL user data packet from the upper layers for transmission via a PDU session, the UE shall associate the UL user data packet with the QFI of the default QoS rule associated with the PDU session.

If the UL user data packet is associated with a QFI, the UE shall pass the QFI along the UL user data packet to the lower layers for transmission.

NOTE: Marking of the UL user data packet with the QFI is performed by the lower layers.

If all QoS rules are evaluated and the UL user data packet is not associated with a QFI, the UE shall discard the UL user data packet.

7.1.4.2.3 Test description

7.1.4.2.3.1 Pre-test conditions

System Simulator:

- NR Cell 1

UE:

- None.

Preamble:

The UE is in 5GS state 3N-A with one PDU session active according to TS 38.508-1 [4], clause 4.4A.3 Table 4.4A.3-1 and using the message condition UE TEST LOOP MODE B active to return one UL SDAP SDU per DL SDAP SDU. 2 DRBs are configured where DRB_j is defined as default DRB. The NAS QoS rules for QoS flows QFI = 5 and QFI = 2 are configured. The 'mappedQoS-Flows' is empty for both DRB's for SDAP layer.

7.1.4.2.3.2 Test procedure sequence

Table 7.1.4.2.3.2-1: Main behaviour

St	Procedure	Message Sequence		TP	Verdict
		U - S	Message		
1	The SS sends the SDAP Data PDU without SDAP header on DRB k for QFI =2.	<--	SDAP DL Data PDU	-	-
2	Check: Does the UE transmit SDAP Data PDU on DRB j, which is default DRB, with SDAP header including QFI=2?	-->	SDAP UL Data PDU	1	P
3	The SS sends the SDAP Data PDU without SDAP header on DRB j for QFI 5.	<--	SDAP DL Data PDU	-	-
4	Check: Does the UE transmit SDAP Data PDU on DRB j, which is default DRB, with SDAP header including QFI=5?	-->	SDAP UL Data PDU	1	P
5	The SS transmits an NR RRCReconfiguration message to configure QoS Flow rules	<--	<i>(RRCReconfiguration)</i>	-	-
-	EXCEPTION: In parallel to the event described in step 6 the events specified in Table 7.1.4.2.3.2-2 shall take place.			-	-
6	The UE transmit an NR <i>RRCReconfigurationComplete</i> message.	-->	<i>(RRCReconfigurationComplete)</i>	-	-
7	The SS sends the SDAP Data PDU without SDAP header on DRB k for QFI =2.	<--	SDAP DL Data PDU	-	-
8	Check: Does the UE transmit SDAP Data PDU on DRB k?	-->	SDAP UL Data PDU	3	P
9	The SS sends the SDAP Data PDU without SDAP header on DRB j for QFI 5.	<--	SDAP DL Data PDU	-	-
10	Check: Does the UE transmit SDAP Data PDU on DRB j, with SDAP header including QFI=5?	-->	SDAP UL Data PDU	3	P

Table 7.1.4.2.3.2-2: Parallel behaviour

St	Procedure	Message Sequence		TP	Verdict
		U - S	Message		
1	Check: Does the UE transmit End-Marker Control PDU on DRBj for QFI=2?	-->	SDAP UL Control PDU	2	P

Table 7.1.4.2.3.2-3: Void

7.1.4.2.3.3 Specific message contents

Table 7.1.4.2.3.3-1: RadioBearerConfig-DRB (Preamble)

Derivation Path: TS 38.508-1 [4], table 4.6.3-132 and condition NR			
Information Element	Value/remark	Comment	Condition
RadioBearerConfig ::= SEQUENCE {			
drb-ToAddModList SEQUENCE (SIZE (1..maxDRB))	2 entries		
OF SEQUENCE {			
{			
DRB-ToAddMod[1] SEQUENCE {		entry 1	
cnAssociation CHOICE {			
sdap-Config SEQUENCE {			
pdu-Session	The same as the PDU session ID in PDU SESSION ESTABLISHMENT REQUEST		
sdap-HeaderDL	absent		
sdap-HeaderUL	absent		
defaultDRB	false		
}			
}			
drb-Identity	k	k is allocated according to internal TTCN mapping	
}			
DRB-ToAddMod[2] SEQUENCE {		entry 2	
cnAssociation CHOICE {			
sdap-Config SEQUENCE {			
pdu-Session	The same as the PDU session ID in PDU SESSION ESTABLISHMENT REQUEST		
sdap-HeaderDL	absent		
sdap-HeaderUL	present		
defaultDRB	true		
}			
}			
drb-Identity	j	j is allocated according to internal TTCN mapping	
}			
}			
}			

Table 7.1.4.2.3.3-2: RadioBearerConfig-DRB (step 5, Table 7.1.4.2.3.2-1)

Derivation Path: TS 38.508-1 [4], table 4.6.3-132 and condition NR			
Information Element	Value/remark	Comment	Condition
RadioBearerConfig ::= SEQUENCE {			
drb-ToAddModList SEQUENCE (SIZE (1..maxDRB))	2 entries		
OF SEQUENCE {			
DRB-ToAddMod[1] SEQUENCE {		entry 1	
cnAssociation CHOICE {			
sdap-Config SEQUENCE {			
pdu-Session	The same as the PDU session ID in PDU SESSION ESTABLISHMENT REQUEST		
sdap-HeaderDL	absent		
sdap-HeaderUL	absent		
defaultDRB	false		
mappedQoS-FlowsToAdd ::= SEQUENCE {			
QFI	2		
}			
}			
}			
drb-Identity	k	k is allocated according to internal TTCN mapping	
}			
DRB-ToAddMod[2] SEQUENCE {		entry 2	
cnAssociation CHOICE {			
sdap-Config SEQUENCE {			
pdu-Session	The same as the PDU session ID in PDU SESSION ESTABLISHMENT REQUEST		
sdap-HeaderDL	absent		
sdap-HeaderUL	present		
defaultDRB	true		
mappedQoS-FlowsToAdd	Not present	The 'mappedQoS-Flows' is empty for the DRB.	
}			
}			
drb-Identity	j	j is allocated according to internal TTCN mapping	
}			
}			
}			
}			

Table 7.1.4.2.3.3-3: PDU SESSION ESTABLISHMENT ACCEPT (Preamble)

Derivation Path: TS 38.508-1, table 4.7.2-2			
Information Element	Value/remark	Comment	Condition
PDU session ID	The same as the PDU session ID in PDU SESSION ESTABLISHMENT REQUEST		
Authorized QoS rules	2 entries		
QoS rule [1]	Reference QoS rule #1 as defined in Table 4.8.2.1-1.	QFI=1	
QoS rule [2]	Reference QoS rule #4 as defined in Table 4.8.2.1-4 except DQR bit set to '0'.	QFI=2	
QoS rule [3]	Reference QoS rule #5 as defined in Table 4.8.2.1-5.	QFI=5	
Mapped EPS bearer contexts	Not Present		
Authorized QoS flow descriptions	2 entries		
QoS flow [1]	Reference QoS flow #1 as defined in Table 7.1.4.2.3.3-4	QFI=1	
QoS flow [2]	Reference QoS flow #2 as defined in Table 7.1.4.2.3.3-5	QFI=2	
QoS flow [3]	Reference QoS flow #3 as defined in Table 4.8.2.3-3.	QFI=5	

Table 7.1.4.2.3.3-4: Reference QoS flow #1 (Preamble)

Derivation Path: TS 38.508-1, table 4.8.2.3-1			
Information Element	Value/remark	Comment	Condition
QoS flow descriptions			
QFI	'00 0001'B	QFI 1	
Operation code	'001'B	Create new QoS flow description	
E bit	'1'B	Parameters list is included	
Number of parameters	'00 0001'B	1 parameter	
5QI	'0000 1001'B	5QI 9	

Table 7.1.4.2.3.3-5: Reference QoS flow #2 (Preamble)

Derivation Path: TS 38.508-1, table 4.8.2.3-2			
Information Element	Value/remark	Comment	Condition
QoS flow descriptions			
QoS flow description			
QFI	'00 0010'B	QFI 2	
Operation code	'001'B	Create new QoS flow description	
E bit	'1'B	Parameters list is included	
Number of parameters	'00 0001'B	1 parameter	
5QI	'0000 0101'B	5QI 5	

8 RRC

8.1 NR RRC

8.1.1 RRC connection management procedures

8.1.1.1 Paging

8.1.1.1.1 RRC / Paging for connection / Multiple paging records

8.1.1.1.1.1 Test Purpose (TP)

(1)

```
with { UE in NR RRC_IDLE state }
ensure that {
  when { UE receives a Paging message including only unmatched identities }
  then { UE does not establish any RRC connection }
}
```

(2)

```
with { UE in NR RRC_IDLE state }
ensure that {
  when { UE receives a Paging message including a matched identity ng-5G-S-TMSI }
  then { UE successfully establishes the RRC connection }
}
```

(3)

```
with { UE in NR RRC_INACTIVE state }
ensure that {
  when { UE receives a Paging message including only unmatched identities }
  then { UE does not resume RRC connection }
}
```

(4)

```
with { UE in NR RRC_INACTIVE state }
ensure that {
  when { UE receives a Paging message including a matched identity fullI-RNTI }
  then { UE successfully resumes the RRC connection }
}
```

8.1.1.1.1.2 Conformance requirements

References: The conformance requirements covered in the current TC is specified in: TS 38.331 clause 5.3.2.3.

[TS 38.331, clause 5.3.2.3]

Upon receiving the *Paging* message, the UE shall:

- 1> if in RRC_IDLE, for each of the *PagingRecord*, if any, included in the *Paging* message:
 - 2> if the *ue-Identity* included in the *PagingRecord* matches the UE identity allocated by upper layers;
 - 3> forward the *ue-Identity* and *accessType* (if present) to the upper layers;
- 1> if in RRC_INACTIVE, for each of the *PagingRecord*, if any, included in the *Paging* message:
 - 2> if the *ue-Identity* included in the *PagingRecord* matches the UE's stored *fullI-RNTI*:

- 3> if the UE is configured by upper layers with Access Identity 1:
 - 4> initiate the RRC connection resumption procedure according to 5.3.13 with *resumeCause* set to *mps-PriorityAccess*;
- 3> else if the UE is configured by upper layers with Access Identity 2:
 - 4> initiate the RRC connection resumption procedure according to 5.3.13 with *resumeCause* set to *mcs-PriorityAccess*;
- 3> else if the UE is configured by upper layers with one or more Access Identities equal to 11-15:
 - 4> initiate the RRC connection resumption procedure according to 5.3.13 with *resumeCause* set to *highPriorityAccess*;
- 3> else:
 - 4> initiate the RRC connection resumption procedure according to 5.3.13 with *resumeCause* set to *mt-Access*;
- 2> else if the *ue-Identity* included in the *PagingRecord* matches the UE identity allocated by upper layers:
 - 3> forward the *ue-Identity* to upper layers and *accessType* (if present) to the upper layers;
 - 3> perform the actions upon going to RRC_IDLE as specified in 5.3.11 with release cause 'other'.

8.1.1.1.1.3 Test Description

8.1.1.1.1.3.1 Pre-test conditions

System Simulator:

- NR Cell 1
- System information combination NR-1 as defined in TS 38.508-1 [4] clause 4.4.3.1.3 is used in NR cell.

UE:

- None.

Preamble:

- The UE is in 5GS state 1N-A according to TS 38.508-1 [4], clause 4.4A.2 Table 4.4A.2-1.

8.1.1.1.1.3.2 Test procedure sequence

Table 8.1.1.1.1.3.2-1: Main behaviour

St	Procedure	Message Sequence		TP	Verdict
		U - S	Message		
1	The SS transmits a <i>Paging</i> message including only unmatched identities (incorrect <i>ng-5G-S-TMSI</i>).	<--	NR RRC: <i>Paging</i>	-	-
2	Check: Does the UE transmit an <i>RRCSetupRequest</i> message within 10s?	-->	NR RRC: <i>RRCSetupRequest</i>	1	F
3	The SS transmits a <i>Paging</i> message including two unmatched identities (incorrect <i>ng-5G-S-TMSI</i>) and a matched identity (correct <i>ng-5G-S-TMSI</i>).	<--	NR RRC: <i>Paging</i>	-	-
4	Check: Does the UE transmit an <i>RRCSetupRequest</i> message?	-->	NR RRC: <i>RRCSetupRequest</i>	2	P
5	The SS transmits an <i>RRCSetup</i> message.	<--	NR RRC: <i>RRCSetup</i>	-	-
6	The UE transmit an <i>RRCSetupComplete</i> message including SERVICE REQUEST to confirm the successful completion of the connection establishment.	-->	NR RRC: <i>RRCSetupComplete</i> 5GMM: SERVICE REQUEST	-	-
7-10	Steps 5 to 8 of the NR RRC_CONNECTED procedure in TS 38.508-1 Table 4.5.4.2-3 are executed to successfully complete the service request procedure.	-	-	-	-
11	The SS transmits an <i>RRCRelease</i> message including <i>suspendConfig</i> .	<--	NR RRC: <i>RRCRelease</i>	-	-
12	The SS transmits a <i>Paging</i> message including only unmatched identities (incorrect <i>fullI-RNTI</i>).	<--	NR RRC: <i>Paging</i>	-	-
13	Check: Does the UE transmit an <i>RRCResumeRequest</i> message within 10s?	-->	NR RRC: <i>RRCResumeRequest</i>	3	F
14	The SS transmits a <i>Paging</i> message including two unmatched identities (incorrect <i>fullI-RNTI</i>) and a matched identity (correct <i>fullI-RNTI</i>).	<--	NR RRC: <i>Paging</i>	-	-
15	Check: Does the UE transmit an <i>RRCResumeRequest</i> message?	-->	NR RRC: <i>RRCResumeRequest</i>	4	P
16	The SS transmits an <i>RRCResume</i> message.	<--	NR RRC: <i>RRCResume</i>	-	-
17	The UE transmits an <i>RRCResumeComplete</i> message.	-->	NR RRC: <i>RRCResumeComplete</i>	-	-

8.1.1.1.1.3.3 Specific message contents

Table 8.1.1.1.1.3.3-1: Paging (step 1, Table 8.1.1.1.1.3.2-1)

Derivation Path: TS 38.508-1 [4], Table 4.6.1-9			
Information Element	Value/remark	Comment	Condition
Paging ::= SEQUENCE {			
pagingRecordList SEQUENCE (SIZE(1..maxNrofPageRec)) OF PagingRecord {	3 entries		
PagingRecord[1] SEQUENCE {		entry 1	
ue-Identity CHOICE {			
ng-5G-S-TMSI	Set to the different value from the NG-5G-S-TMSI of the UE		
}			
}			
PagingRecord[2] SEQUENCE {		entry 2	
ue-Identity CHOICE {			
ng-5G-S-TMSI	Set to the different value from the NG-5G-S-TMSI of the UE		
}			
}			
PagingRecord[3] SEQUENCE {		entry 3	
ue-Identity CHOICE {			
ng-5G-S-TMSI	Set to the different value from the NG-5G-S-TMSI of the UE		
}			
}			
}			
}			

Table 8.1.1.1.1.3.3-2: Paging (step 3, Table 8.1.1.1.1.3.2-1)

Derivation Path: TS 38.508-1[4], Table 4.6.1-9			
Information Element	Value/remark	Comment	Condition
Paging ::= SEQUENCE {			
pagingRecordList SEQUENCE (SIZE(1..maxNrofPageRec)) OF PagingRecord {	3 entries		
PagingRecord[1] SEQUENCE {		entry 1	
ue-Identity CHOICE {			
ng-5G-S-TMSI	Set to the different value from the NG-5G-S-TMSI of the UE		
}			
}			
PagingRecord[2] SEQUENCE {		entry 2	
ue-Identity CHOICE {			
ng-5G-S-TMSI	Set to the different value from the NG-5G-S-TMSI of the UE		
}			
}			
PagingRecord[3] SEQUENCE {		entry 3	
ue-Identity CHOICE {			
ng-5G-S-TMSI	Set to the value of the NG-5G-S-TMSI of the UE		
}			
}			
}			
}			

Table 8.1.1.1.1.3.3-3: RRCSetupRequest (step 4, Table 8.1.1.1.1.3.2-1)

Derivation Path: TS 38.508-1 [4], Table 4.6.1-23			
Information Element	Value/remark	Comment	Condition
RRCSetupRequest ::= SEQUENCE {			
rrcSetupRequest SEQUENCE {			
establishmentCause	mt-Access		
}			
}			

Table 8.1.1.1.1.3.3-4: Paging (step 12, Table 8.1.1.1.1.3.2-1)

Derivation Path: 38.508-1 Table 4.6.1-9			
Information Element	Value/remark	Comment	Condition
Paging ::= SEQUENCE {			
pagingRecordList SEQUENCE	3 entries		
(SIZE(1..maxNrofPageRec)) OF PagingRecord {			
PagingRecord[1] SEQUENCE {		entry 1	
ue-Identity CHOICE {			
fullI-RNTI	Set to the different value from the I-RNTI-Value of the UE		
}			
}			
PagingRecord[2] SEQUENCE {		entry 2	
ue-Identity CHOICE {			
fullI-RNTI	Set to the different value from the I-RNTI-Value of the UE		
}			
}			
PagingRecord[3] SEQUENCE {		entry 3	
ue-Identity CHOICE {			
fullI-RNTI	Set to the different value from the I-RNTI-Value of the UE		
}			
}			
}			
}			

Table 8.1.1.1.3.3-5: *Paging* (step 14, Table 8.1.1.1.3.2-1)

Derivation Path: 38.508-1 Table 4.6.1-9			
Information Element	Value/remark	Comment	Condition
Paging ::= SEQUENCE {			
pagingRecordList SEQUENCE	3 entries		
(SIZE(1..maxNrofPageRec)) OF PagingRecord {			
PagingRecord[1] SEQUENCE {		entry 1	
ue-Identity CHOICE {			
fullI-RNTI	Set to the different value from the I-RNTI-Value of the UE		
}			
}			
PagingRecord[2] SEQUENCE {		entry 2	
ue-Identity CHOICE {			
fullI-RNTI	Set to the different value from the I-RNTI-Value of the UE		
}			
}			
PagingRecord[3] SEQUENCE {		entry 3	
ue-Identity CHOICE {			
fullI-RNTI	Set to the value of the I-RNTI-Value of the UE		
}			
}			
}			
}			

8.1.1.1.2 RRC / Paging for connection / Shared network environment

8.1.1.1.2.1 Test Purpose (TP)

(1)

```
with { UE in NR RRC_IDLE state having been registered in the TA of the current cell which has
broadcasted a SIB1 message including multiple PLMN identities }
ensure that {
  when { UE receives a Paging message including an IE ue-Identity set to the ng-5G-S-TMSI which was
allocated to the UE during the UE registration procedure }
  then { UE initiates RRCSetupRequest with ue-Identity set to ng-5G-S-TMSI-Part1 }
}
```

(2)

```
with { UE having sent RRCSetupRequest with ue-Identity set to ng-5G-S-TMSI-Part1 }
ensure that {
  when { the UE receives RRCSetup message }
  then { UE will set the ng-5G-S-TMSI-Value to ng-5G-S-TMSI-Part2 in RRCSetupComplete message }
}
```

(3)

```
with { UE in NR RRC_INACTIVE state having been registered in the TA of the current cell which has
broadcasted a SIB1 message including multiple PLMN identities }
ensure that {
  when { UE receives a Paging message including an IE ue-Identity set to the ng-5G-S-TMSI which was
allocated to the UE during the UE registration procedure }
  then { UE releases RRC connection with release cause 'other' and goes to NR RRC_IDLE state }
}
```

8.1.1.1.2.2 Conformance requirements

Editor's note: conformance requirements will be updated according to latest core specification.

References: The conformance requirements covered in the current TC are specified in: TS 38.331, clause 5.3.2.3, 5.3.3.3, 5.3.3.4 and 5.3.11, TS 24.501, clause 5.3.1.4 and 5.6.1.1. Unless otherwise stated these are Rel-15 requirements.

[TS 38.331, clause 5.3.2.3]

Upon receiving the *Paging* message, the UE shall:

- 1> if in RRC_IDLE, for each of the *PagingRecord*, if any, included in the *Paging* message:
 - 2> if the *ue-Identity* included in the *PagingRecord* matches the UE identity allocated by upper layers:
 - 3> forward the *ue-Identity* and *accessType* (if present) to the upper layers;
- 1> if in RRC_INACTIVE, for each of the *PagingRecord*, if any, included in the *Paging* message:
 - 2> if the *ue-Identity* included in the *PagingRecord* matches the UE's stored *fullI-RNTI*:
 - ...
 - 2> else if the *ue-Identity* included in the *PagingRecord* matches the UE identity allocated by upper layers:
 - 3> forward the *ue-Identity* to upper layers and *accessType* (if present) to the upper layers;
 - 3> perform the actions upon going to RRC_IDLE as specified in 5.3.11 with release cause 'other'.

[TS 38.331, clause 5.3.3.3]

The UE shall set the contents of *RRCSetupRequest* message as follows:

- 1> set the *ue-Identity* as follows:
 - 2> if upper layers provide an *5G-S-TMSI*:
 - 3> set the *ue-Identity* to *ng-5G-S-TMSI-Part1*;
 - 2> else:
 - 3> draw a 39-bit random value in the range $0..2^{39}-1$ and set the *ue-Identity* to this value;

NOTE 1: Upper layers provide the *5G-S-TMSI* if the UE is registered in the TA of the current cell.

- 1> set the *establishmentCause* in accordance with the information received from upper layers;

The UE shall submit the *RRCSetupRequest* message to lower layers for transmission.

The UE shall continue cell re-selection related measurements as well as cell re-selection evaluation. If the conditions for cell re-selection are fulfilled, the UE shall perform cell re-selection as specified in 5.3.3.6.

[TS 38.331, clause 5.3.3.4]

The UE shall perform the following actions upon reception of the *RRCSetup*:

- ...
- 1> set the content of *RRCSetupComplete* message as follows:
 - 2> if upper layers provide an *5G-S-TMSI*:
 - 3> if the *RRCSetup* is received in response to an *RRCSetupRequest*:
 - 4> set the *ng-5G-S-TMSI-Value* to *ng-5G-S-TMSI-Part2*;
 - 3> else:
 - 4> set the *ng-5G-S-TMSI-Value* to *ng-5G-S-TMSI*;
 - ...
 - 1> submit the *RRCSetupComplete* message to lower layers for transmission, upon which the procedure ends

[TS 38.331, clause 5.3.11]

UE shall:

- 1> reset MAC;
- 1> if T302 is running:
 - 2> stop timer T302;
 - 2> perform the actions as specified in 5.3.14.4;
- 1> stop all timers that are running except T320 and T325;
- 1> discard the UE Inactive AS context;
- 1> set the variable *pendingRnaUpdate* to *false*, if that is set to *true*;
- 1> discard the K_{gNB} , the K_{RRCenc} key, the K_{RRCint} , the K_{UPint} key and the K_{UPenc} key, if any;
- 1> release all radio resources, including release of the RLC entity, the MAC configuration and the associated PDCP entity and SDAP for all established RBs;
- 1> indicate the release of the RRC connection to upper layers together with the release cause;
- 1> enter RRC_IDLE and perform cell selection as specified in TS 38.304 [20], except if going to RRC_IDLE was triggered by selecting an inter-RAT cell while T311 was running;
- 1> if going to RRC_IDLE was triggered by reception of the *RRCRelease* message including a *waitTime*:
 - 2> start timer T302 with the value set to the *waitTime*;
- 2> inform the upper layer that access barring is applicable for all access categories except categories '0' and '2'.

[TS 24.501, clause 5.3.1.4]

...

Upon receiving AMF paging indication from the lower layers, the UE shall transition from 5GMM-CONNECTED mode with RRC inactive indication to 5GMM-IDLE mode over 3GPP access and handle the AMF paging same as the paging request received in the 5GMM-IDLE mode over 3GPP access as specified in clause 5.6.1.

[TS 24.501, clause 5.6.1.1]

...

The UE shall invoke the service request procedure when:

- a) the UE, in 5GMM-IDLE mode over 3GPP access, receives a paging request from the network;

8.1.1.1.2.3 Test description

8.1.1.1.2.3.1 Pre-test conditions

System Simulator:

- NR Cell 1.

UE:

- None.

Preamble:

- The UE is in state 1N-A as defined in TS 38.508-1 [4], clause 4.4A on NR Cell 1 and 5G-GUTI is allocated in REGISTRATION ACCEPT.

8.1.1.1.2.3.2 Test procedure sequence

Table 8.1.1.1.2.3.2-1: Main behaviour

St	Procedure	Message Sequence		TP	Verdict
		U - S	Message		
1	The SS transmits a <i>Paging</i> message including a matched ng-5G-S-TMSI.	<--	NR RRC: <i>Paging</i>	-	-
2	Check: Does the UE transmit an <i>RRCSetupRequest</i> message with ue-Identity set to ng-5G-S-TMSI-Part1?	-->	NR RRC: <i>RRCSetupRequest</i>	1	P
3	The SS transmits an <i>RRCSetup</i> message.	<--	NR RRC: <i>RRCSetup</i>	-	-
4	Check: Does the UE transmit an <i>RRCSetupComplete</i> message including ng-5G-S-TMSI-Part2 and a SERVICE REQUEST message and an IE <i>selectedPLMN-Identity</i> corresponding to the PLMN on which the UE has been registered to confirm the successful completion of the connection establishment?	-->	NR RRC: <i>RRCSetupComplete</i>	2	P
5-8	Steps 5 to 8 of the generic radio bearer establishment procedure (TS 38.508-1 [4] Table 4.5.4.2-3) are executed to successfully complete the service request procedure.	-	-	-	-
9	The SS transmits an <i>RRCRelease</i> message with suspendConfig to suspend RRC connection and move to RRC_INACTIVE state.	<--	NR RRC: <i>RRCRelease</i>	-	-
10	Wait 5s and the SS transmits a <i>Paging</i> message including a matched ng-5G-S-TMSI.	<--	NR RRC: <i>Paging</i>	-	-
11	Check: Does the UE transmit an <i>RRCSetupRequest</i> message on the cell specified in the test case?	-->	NR RRC: <i>RRCSetupRequest</i>	3	P
12-18	Steps 3-9 of Generic procedure for checking UE is in state 5GC RRC_IDLE on a certain cell as specified in Table 4.9.4.2.2-1 of TS 38.508-1 [4] are performed.	-	-	-	-

8.1.1.1.2.3.3 Specific message contents

Table 8.1.1.1.2.3.3-1: SIB1 (preamble and all steps, Table 8.1.1.1.2.3.2-1)

Derivation Path: 38.508-1 [4] Table 4.6.1-28			
Information Element	Value/remark	Comment	Condition
SIB1 ::= SEQUENCE {			
CellAccessRelatedInfo SEQUENCE {			
plmn-IdentityList	PLMN-IdentityInfoList		
}			
}			

Table 8.1.1.1.2.3.3-2: PLMN-IdentityInfoList (Table 8.1.1.1.2.3.3-1)

Derivation Path: 38.508-1 [4] Table 4.6.3-108			
Information Element	Value/remark	Comment	Condition
PLMN-IdentityInfoList ::= SEQUENCE (SIZE (1..maxPLMN)) OF PLMN-IdentityInfo {	1 entry		
PLMN-IdentityInfo[1] SEQUENCE {		entry 1	
plmn-IdentityList SEQUENCE (SIZE (1..maxPLMN)) OF PLMN-Identity {	2 entries		
plmn-Identity[1] SEQUENCE {		entry 1	
mcc	See Table 8.1.1.1.2.3.3-2A	PLMN1	
mnc	See Table 8.1.1.1.2.3.3-2A	PLMN1	
}			
plmn-Identity[2] SEQUENCE {		entry 2	
mcc	See Table 8.1.1.1.2.3.3-2A	PLMN2	
mnc	See Table 8.1.1.1.2.3.3-2A	PLMN2	
}			
}			
}			
}			

The PLMN Identity list broadcasted on the BCCH in NR Cell 1 shall be configured as defined in the table below.

Table 8.1.1.1.2.3.3-2A: PLMN Identity List broadcasted for NR Cell 1

Cell	PLMN Identity [1]		PLMN Identity [2]	
	MCC digits	MNC digits	MCC digits	MNC digits
1	PLMN 1	PLMN 1	PLMN 2	PLMN 2

The definition of each PLMN code is found in table below:

Table 8.1.1.1.2.3.3-2B: definition of each PLMN code

PLMN	MCC digit			MNC digit		
	1	2	3	1	2	3
1	(NOTE 2)			(NOTE 2)		
2	(NOTE 3)			0	2	-

NOTE 1: "-" (dash) denotes "not present"

NOTE 2: Set to the same Mobile Country Code and Mobile Network Code stored in EF_{IMSI} on the test USIM card for PLMN 1.

NOTE 3: Set to the same Mobile Country Code stored in EF_{IMSI} on the test USIM card for PLMN 2.

Table 8.1.1.1.2.3.3-3: RRCSetupRequest (step 2,11, Table 8.1.1.1.2.3.2-1)

Derivation Path: 38.508-1 [4], Table 4.6.1-23			
Information Element	Value/remark	Comment	Condition
RRCSetupRequest ::= SEQUENCE {			
rrcSetupRequest SEQUENCE {			
ue-Identity CHOICE {			
ng-5G-S-TMSI-Part1	ng-5G-S-TMSI-Part1	ng-5G-S-TMSI-Part1 is rightmost 39 bits of 5G-S-TMSI. 5G-S-TMSI is derived from 5G-GUTI in REGISTRATION ACCEPT according to TS 23.003 [34]	
}			
establishmentCause	mt-Access		
}			
}			

Table 8.1.1.1.2.3.3-4: RRCSetupComplete (step 4, Table 8.1.1.1.2.3.2-1)

Derivation Path: 38.508-1 [4], Table 4.6.1-22			
Information Element	Value/remark	Comment	Condition
RRCSetupComplete ::= SEQUENCE {			
rrc-TransactionIdentifier	RRC-TransactionIdentifier		
criticalExtensions CHOICE {			
rrcSetupComplete SEQUENCE {			
ng-5G-S-TMSI-Value	ng-5G-S-TMSI-Part2	ng-5G-S-TMSI-Part2 is the leftmost 9 bits of 5G-S-TMSI. 5G-S-TMSI is derived from 5G-GUTI in REGISTRATION ACCEPT according to TS 23.003 [34]	
selectedPLMN-Identity	1 or 2	PLMN1 or PLMN2 Note1	
}			
}			
}			
Note1: If RPLMN is PLMN1, UE will select PLMN1; if RPLMN is PLMN2, UE will select PLMN2			

Table 8.1.1.1.2.3.3-5: *RRCRelease* (step 9, Table 8.1.1.1.2.3.2-1)

Derivation Path: 38.508-1 [4] Table 4.6.1-16			
Information Element	Value/remark	Comment	Condition
RRCRelease ::= SEQUENCE {			
rrc-TransactionIdentifier	RRC-TransactionIdentifier		
criticalExtensions CHOICE {			
rrcRelease SEQUENCE {			
suspendConfig SEQUENCE {			
fullI-RNTI	I-RNTI-Value	38.508-1[4] Table 4.6.3-64	
shortI-RNTI	ShortI-RNTI-Value	38.508-1[4] Table 4.6.3-170	
ran-PagingCycle	rf256		
ran-NotificationAreaInfo CHOICE {			
cellList SEQUENCE (SIZE (1..maxPLMNIdentities)) OF PLMN-RAN-AreaCell {	2 entries		
PLMN-RAN-AreaCellList[1] SEQUENCE {		entry 1	
plmn-Identity	PLMN1		
ran-AreaCells SEQUENCE (SIZE (1..32)) OF CellIdentity {	1 entry		
CellIdentity[1]	CellIdentity of NR Cell 1	entry 1	
}			
}			
PLMN-RAN-AreaCellList[2] SEQUENCE {		entry 2	
plmn-Identity	PLMN2		
ran-AreaCells SEQUENCE (SIZE (1..32)) OF CellIdentity {	1 entry		
CellIdentity[1]	CellIdentity of NR Cell 1	entry 1	
}			
}			
}			
}			
}			
t380	Not Present		
nextHopChainingCount	NextHopChainingCount	38.508-1[4] Table 4.6.3-83	
}			
}			
}			
}			

8.1.1.2 RRC connection establishment

8.1.1.2.1 RRC connection establishment / Return to idle state after T300 expiry

8.1.1.2.1.1 Test Purpose (TP)

(1)

```
with { UE in NR RRC_IDLE state having sent an RRCSetupRequest message }
ensure that {
  when { the SS does not answer to the UE during T300 }
  then { UE goes to RRC_IDLE state }
}
```

(2)

```
with { UE in NR RRC_IDLE state }
ensure that {
  when { T300 has expired a consecutive connEstFailCount times on the same cell for which
connEstFailureControl is included in SIB1 for a period as indicated by connEstFailOffsetValidity }
  then { UE uses connEstFailOffset for the parameter Qoffsettemp when performing cell reselection }
}
```

```

    }

```

(3)

```

with { UE in NR RRC_IDLE state }
ensure that {
  when { connEstFailOffsetValidity has expired }
  then { UE stops using the parameter Qoffsettemp when performing cell reselection }
}

```

8.1.1.2.1.2 Conformance requirements

References: The conformance requirements covered in the current TC are specified in: TS 38.331, clause 5.3.3.7. Unless otherwise stated these are Rel-15 requirements.

[TS 38.331, clause 5.3.3.7]

The UE shall:

- 1> if timer T300 expires:
 - 2> reset MAC, release the MAC configuration and re-establish RLC for all RBs that are established;
 - 2> if the T300 has expired a consecutive *connEstFailCount* times on the same cell for which *connEstFailureControl* is included in *SIB1*:
 - 3> for a period as indicated by *connEstFailOffsetValidity*:
 - 4> use *connEstFailOffset* for the parameter *Qoffsettemp* for the concerned cell when performing cell selection and reselection according to TS 38.304 [20] and TS 36.304 [27];

NOTE: When performing cell selection, if no suitable or acceptable cell can be found, it is up to UE implementation whether to stop using *connEstFailOffset* for the parameter *Qoffsettemp* during *connEstFailOffsetValidity* for the concerned cell.

- 2> inform upper layers about the failure to establish the RRC connection, upon which the procedure ends;

8.1.1.2.1.3 Test description

8.1.1.2.1.3.1 Pre-test conditions

System Simulator:

- NR Cell 1 and NR Cell 3.
- System information combination NR-4 as defined in TS 38.508-1 [4] clause 4.4.3.1.3 is used in NR cells.

UE:

- None.

Preamble:

- The UE is in state 1N-A as defined in TS 38.508-1 [4], clause 4.4A on NR Cell 1 and 5G-GUTI is allocated in REGISTRATION ACCEPT.

8.1.1.2.1.3.2 Test procedure sequence

Table 8.1.1.2.1.3.2-1/2 illustrates the downlink power levels and other changing parameters to be applied for the NR cells at various time instants of the test execution. The exact instants on which these values shall be applied are described in the texts in this clause. The configuration "T0" indicates the initial conditions. Subsequent configuration marked "T1" is applied at the points indicated in the Main behaviour description in Table 8.1.1.2.1.3.2-3.

Table 8.1.1.2.1.3.2-1: Time instances of cell power level and parameter changes for FR1

	Parameter	Unit	NR Cell 1	NR Cell 3	Remark
T0	SS/PBCH SSS EPRE	dBm/SCS	-78	Off	
T1	SS/PBCH SSS EPRE	dBm/SCS	-78	-88	
Note: Power level "Off" is defined in TS 38.508-1 [4] Table 6.2.2.1-3.					

Table 8.1.1.2.1.3.2-2: Time instances of cell power level and parameter changes for FR2

	Parameter	Unit	NR Cell 1	NR Cell 3	Remark
T0	SS/PBCH SSS EPRE	dBm/SCS	-82	Off	
	Qrxlevmin	dBm	-91+Delta(NRf1)	-	
T1	SS/PBCH SSS EPRE	dBm/SCS	-82	-91	
	Qrxlevmin	dBm	-91+Delta(NRf1)	-100+Delta(NRf2)	

Table 8.1.1.2.1.3.2-3: Main behaviour

St	Procedure	Message Sequence		TP	Verdict
		U - S	Message		
1	The SS transmits a <i>Paging</i> message including a matched ng-5G-S-TMSI.	<--	NR RRC: <i>Paging</i>	-	-
2	The UE transmits an <i>RRCSetupRequest</i> message.	-->	NR RRC: <i>RRCSetupRequest</i>	-	-
3	The SS waits for 2s (T300 expire).	-	-	-	-
4	Check: Does UE send <i>RRCSetupRequest</i> in 5 second?	-->	NR RRC: <i>RRCSetupRequest</i>	1	F
5	Check: Does the test result of generic test procedure step 1-8 in TS 38.508-1 [4] Table 4.9.4.2.2-1 indicate that the UE is in RRC_IDLE?	-	-	1	-
6	SS transmits an <i>RRCRelease</i> message to release RRC connection and move the UE to RRC_IDLE	<--	NR RRC: <i>RRCRelease</i>	-	-
7	The SS remove <i>connEstFailOffset</i> in SIB1.	-	-	-	-
8	The SS transmits a Short message on PDCCH using P-RNTI indicating a <i>systemInfoModification</i> .	-	PDCCH (DCI 1_0): Short Message	-	-
8A	Wait for 2.1* modification period to allow the new system information to take effect.	-	-	-	-
9	Void	-	-	-	-
10	The SS transmits a <i>Paging</i> message including a matched ng-5G-S-TMSI.	<--	NR RRC: <i>Paging</i>	-	-
11	The UE transmits an <i>RRCSetupRequest</i> message.	-->	NR RRC: <i>RRCSetupRequest</i>	-	-
12	The SS waits for 2s to let T300 expire.	-	-	-	-
12 A	The SS re-adjusts the SS levels according to row "T1" in table 8.1.1.2.1.3.2-1/2 and waits for 35s to allow UE to perform cell reselection.	-	-	-	-
13	The SS transmits a <i>Paging</i> message including a matched ng-5G-S-TMSI on NR Cell 1.	<--	NR RRC: <i>Paging</i>	-	-
14	Check: Does UE send <i>RRCSetupRequest</i> in 5 second?	-->	NR RRC: <i>RRCSetupRequest</i>	2	F
15	Void	-	-	-	-
16	After expiry of <i>connEstFailOffsetValidity</i> , the SS waits 35s to allow UE to perform cell reselection.	-	-	-	-
17	Check: Does the test result of generic test procedure step 1-9a1 in TS 38.508-1 [4] Table 4.9.4.2.2-1 indicate that the UE is in RRC_IDLE on NR Cell 1?	-	-	3	-

8.1.1.2.1.3.3 Specific message contents

Table 8.1.1.2.1.3.3-1: *RRCSetupRequest* (steps 2 and 11, Table 8.1.1.2.1.3.2-3)

Derivation Path: 38.508-1 [4], Table 4.6.1-23			
Information Element	Value/remark	Comment	Condition
<i>RRCSetupRequest</i> ::= SEQUENCE {			
<i>rrcSetupRequest</i> SEQUENCE {			
<i>establishmentCause</i>	mt-Access		
}			
}			

Table 8.1.1.2.1.3.3-2: SIB1 (step 7, Table 8.1.1.2.1.3.2-3)

Derivation Path: TS 38.508-1 [4], Table 4.6.1-28			
Information Element	Value/remark	Comment	Condition
SIB1 ::= SEQUENCE {			
connEstFailureControl	ConnEstFailureControl	Table 8.1.1.2.1.3.3-3	
}			

Table 8.1.1.2.1.3.3-3: ConnEstFailureControl (Table 8.1.1.2.1.3.3-2)

Derivation Path: TS 38.508-1 [4], Table 4.6.3-27			
Information Element	Value/remark	Comment	Condition
ConnEstFailureControl ::= SEQUENCE {			
connEstFailOffsetValidity	s60		
connEstFailOffset	Not present	Value of infinity shall be used for $Q_{offset_{temp}}$	
}			

8.1.1.2.2 Void

8.1.1.2.3 RRC connection establishment / RRC Reject with wait time

8.1.1.2.3.1 Test Purpose (TP)

(1)

```
with { UE in NR RRC_IDLE state and has sent an RRCSetupRequest message }
ensure that {
  when { UE receives an RRCReject message including an IE waitTime }
  then { UE doesn't re-send RRCSetupRequest message before the waitTime is expired }
}
```

8.1.1.2.3.2 Conformance requirements

References: The conformance requirements covered in the current TC is specified in: TS 38.331 clause 5.3.15.2.

[TS 38.331, clause 5.3.15.2]

The UE shall:

- 1> stop timer T300, if running;
- 1> stop timer T319, if running;
- 1> stop timer T302, if running;
- 1> reset MAC and release the default MAC Cell Group configuration;
- 1> if *waitTime* is configured in the *RRCReject*:
 - 2> start timer T302, with the timer value set to the *waitTime*;
- 1> if *RRCReject* is received in response to a request from upper layers:
 - 2> inform the upper layer that access barring is applicable for all access categories except categories '0' and '2';
- 1> if *RRCReject* is received in response to an *RRCSetupRequest*:
 - 2> inform upper layers about the failure to setup the RRC connection, upon which the procedure ends;
- 1> else if *RRCReject* is received in response to an *RRCResumeRequest* or an *RRCResumeRequest1*:

- 2> if resume is triggered by upper layers:
 - 3> inform upper layers about the failure to resume the RRC connection;
- 2> if resume is triggered due to an RNA update:
 - 3> set the variable *pendingRnaUpdate* to *true*;
- 2> discard the current K_{gNB} key, the K_{RRCEnc} key, the K_{RRCint} key, the K_{UPint} key and the K_{UPenc} key derived in accordance with 5.3.13.3;
- 2> suspend SRB1, upon which the procedure ends;

The RRC_INACTIVE UE shall continue to monitor paging while the timer T302 is running.

8.1.1.2.3.3 Test Description

8.1.1.2.3.3.1 Pre-test conditions

System Simulator:

- NR Cell 1
- System information combination NR-1 as defined in TS 38.508-1 [4] clause 4.4.3.1.3 is used in NR cell.

UE:

- None.

Preamble:

- The UE is in 5GS state 3N-A according to TS 38.508-1 [4], clause 4.4A.2 Table 4.4A.2-3 and Test Loop Function (On) with UE test loop mode B is established.

8.1.1.2.3.3.2 Test procedure sequence

Table 8.1.1.2.3.3.2-1: Main behaviour

St	Procedure	Message Sequence		TP	Verdict
		U - S	Message		
1	The SS transmits one IP packet to the UE on the DRB associated with the default PDU session on NR Cell 1.	-	-	-	-
2	Wait for 1 second after the IP packet has been transmitted in step 1. (Note 1)	-	-	-	-
3	The SS transmits an <i>RRCRelease</i> message on NR Cell 1.	<--	NR RRC: <i>RRCRelease</i>	-	-
4-4A	Steps 1-2 of the NR RRC_CONNECTED procedure in table 4.5.4.2-3 in TS 38.508-1[4] are performed.	-	-	-	-
5	The SS responds with <i>RRCReject</i> message with IE <i>waitTime</i> set to 10s.	<--	NR RRC: <i>RRCReject</i>	-	-
6	Check: Does the UE transmit an <i>RRCSetupRequest</i> message while timer T302 is running?	-->	NR RRC: <i>RRCSetupRequest</i>	1	F
7	Check: Does UE transmit <i>RRCSetupRequest</i> message for sending the IP packet received in step 1 after timer T302 expires?	-	NR RRC: <i>RRCSetupRequest</i>	1	P
8-12	Steps 3 to 7 of the NR RRC_CONNECTED procedure in TS 38.508-1 [4] Table 4.5.4.2-3 are executed.	-	-	-	-
-	EXCEPTION: Steps 13 and 14 can occur in any order.	-	-	-	-
13	The UE transmits an <i>RRCReconfigurationComplete</i> message on Cell 1.	-->	NR RRC: <i>RRCReconfigurationComplete</i>	-	-
14	The UE loop backs the IP packet received in step 1 on the DRB associated with the default PDU session on Cell 1.	-	-	-	-

Note 1: The 1 second delay is used to secure that the UE has received and forwarded the IP Packet transmitted by the SS in step 1 to the UE test loop function before the *RRCRelease* message is sent by the SS in step 3.

8.1.1.2.3.3.3 Specific message contents

Table 8.1.1.2.3.3.3-1: *RRCReject* (step 5, table 8.1.1.2.3.3.2-1)

Derivation path: 38.508-1 [4] Table 4.6.1-15			
Information Element	Value/remark	Comment	Condition
<i>RRCReject</i> ::= SEQUENCE {			
criticalExtensions CHOICE {			
<i>rrcReject</i> SEQUENCE {			
<i>waitTime</i>	10	10 seconds	
}			
}			
}			

Table 8.1.1.2.3.3.3-2: CLOSE UE TEST LOOP (Preamble, Table 8.1.1.2.3.3.2-1)

Derivation Path: 36.508 [7], Table 4.7A-3, condition UE TEST LOOP MODE B			
Information Element	Value/remark	Comment	Condition
UE test loop mode B LB setup			
IP PDU delay	'0000 0101'B	5 seconds	

Table 8.1.1.2.3.3-3: SERVICE REQUEST (Step 9, Table 8.1.1.2.3.3.2-1)

Derivation Path: 38.508-1[4], Table 4.7.1-16			
Information Element	Value/remark	Comment	Condition
Service type	'0001'B	data	

8.1.1.2.4 RRC connection establishment / Extended and spare fields in SI

8.1.1.2.4.1 Test Purpose (TP)

(1)

```

with { UE is powered on and receives system information }
ensure that {
  when { UE receives an optional spare or extended field in system information that it does not
  comprehend }
  then { UE treats system information as if the spare or extended field were absent and system
  information is not ignored, and UE establishes an RRC connection }
}

```

8.1.1.2.4.2 Conformance requirements

References: The conformance requirements covered in the current TC are specified in: TS 36.331, clauses 5.2.2.3.1, 10.1 and 10.3. Unless otherwise stated, these are Rel-15 requirements.

[TS 38.331, clause 5.2.2.3.1]

The UE shall:

- 1> apply the specified BCCH configuration defined in 9.1.1.1;
- 1> if the UE is in RRC_IDLE or in RRC_INACTIVE; or
- 1> if the UE is in RRC_CONNECTED while T311 is running:
 - 2> acquire the *MIB*, which is scheduled as specified in TS 38.213 [13];
 - 2> if the UE is unable to acquire the *MIB*;
 - 3> perform the actions as specified in clause 5.2.2.5;
 - 2> else:
 - 3> perform the actions specified in clause 5.2.2.4.1.
- 1> if the UE is in RRC_CONNECTED with an active BWP with common search space configured by *searchSpaceSIB1* and *pagingSearchSpace* and has received an indication about change of system information; or
- 1> if the UE is in RRC_IDLE or in RRC_INACTIVE; or
- 1> if the UE is in RRC_CONNECTED while T311 is running:
 - 2> if *ssb-SubcarrierOffset* indicates *SIB1* is transmitted in the cell (TS 38.213 [13]) and if *SIB1* acquisition is required for the UE:
 - 3> acquire the *SIB1*, which is scheduled as specified in TS 38.213 [13];
 - 3> if the UE is unable to acquire the *SIB1*:
 - 4> perform the actions as specified in clause 5.2.2.5;
 - 3> else:
 - 4> upon acquiring *SIB1*, perform the actions specified in clause 5.2.2.4.2.

2> else if *SIB1* acquisition is required for the UE and *ssb-SubcarrierOffset* indicates that *SIB1* is not scheduled in the cell:

3> perform the actions as specified in clause 5.2.2.5.

NOTE: The UE in RRC_CONNECTED is only required to acquire broadcasted *SIB1* if the UE can acquire it without disrupting unicast data reception, i.e. the broadcast and unicast beams are quasi co-located.

[TS 38.331, clause 10.1]

The generic error handling defined in the subsequent clauses applies unless explicitly specified otherwise e.g. within the procedure specific error handling.

The UE shall consider a value as not comprehended when it is set:

- to an extended value that is not defined in the version of the transfer syntax supported by the UE;
- to a spare or reserved value unless the specification defines specific behaviour that the UE shall apply upon receiving the concerned spare/reserved value.

The UE shall consider a field as not comprehended when it is defined:

- as spare or reserved unless the specification defines specific behaviour that the UE shall apply upon receiving the concerned spare/reserved field.

[TS 38.331 clause 10.3]

The UE shall, when receiving an RRC message on any logical channel:

- 1> if the message includes a field that has a value that the UE does not comprehend:
 - 2> if a default value is defined for this field:
 - 3> treat the message while using the default value defined for this field;
 - 2> else if the concerned field is optional:
 - 3> treat the message as if the field were absent and in accordance with the need code for absence of the concerned field;
- 2> else:
 - 3> treat the message as if the field were absent and in accordance with sub-clause 10.4.

8.1.1.2.4.3 Test description

8.1.1.2.4.3.1 Pre-test conditions

System Simulator:

- Cell 1.

UE:

None.

Preamble:

- The UE is switched off

8.1.1.2.4.3.2 Test procedure sequence

Table 8.1.1.2.4.3.2-1: Main behaviour

St	Procedure	Message Sequence		TP	Verdict
		U - S	Message		
1	System information that includes extended and spare fields that the UE does not comprehend is broadcasted on BCCH.	<-	RRC: SYSTEM INFORMATION (BCCH)	-	-
2	The UE is switched on.	-	-	-	-
3	Does the UE transmit an <i>RRCSetupRequest</i> message on Cell 1?	-->	<i>RRCSetupRequest</i>	1	P
4	The SS transmits an <i>RRCSetup</i> message on Cell 1.	<-	<i>RRCSetup</i>	-	-
5	Check: Does the UE transmit an <i>RRCSetupComplete</i> message to confirm the successful completion of the connection establishment and to initiate the Service Setup procedure by including the SERVICE REQUEST message?	-->	<i>RRCSetupComplete</i> 5GMM: SERVICE REQUEST	1	P
6-10a 2	Steps 5 to 9a2 of the Service Accept procedure described in TS 38.508 Table 4.5.4.2-3 are performed on Cell 1.	-	-	-	-

8.1.1.2.4.3.3 Specific message contents

Table 8.1.1.2.4.3.3-1: MIB (step 1, Table 8.1.1.2.4.3.2-1)

Derivation Path: 38.508-1 Table 4.6.1-6			
Information Element	Value/remark	Comment	Condition
MIB ::= SEQUENCE {			
spare	'1'B	In Rel-15, the lowest bit is considered a spare according to TS 38.331 [12].	For Rel-15
}			

Table 8.1.1.2.4.3.3-2: SystemInformation (step 1, Table 8.1.1.2.4.3.2-1)

Derivation Path: TS 38.508-1, Table 4.6.1-29			
Information Element	Value/remark	Comment	Condition
SystemInformation ::= SEQUENCE {			
criticalExtensions CHOICE {			
systemInformation SEQUENCE {			
sib-TypeAndInfo SEQUENCE (SIZE (1..maxSIB))			
OF CHOICE {			
SIB2			
SIB11-r16		In Rel-15, SIB11 is considered an extended field according to TS 38.331 [12].	
}			
lateNonCriticalExtension	Not present		
nonCriticalExtension	Not present		
}			
}			

Table 8.1.1.2.4.3.3-3: *SIB11* (Table 8.1.1.2.4.3.3-2)

Derivation Path: TS 38.508-1, Table 4.6.2-13			
Information Element	Value/remark	Comment	Condition
SIB11-r16 ::= SEQUENCE {			
measIdleConfigSIB-r16	Not Present		
lateNonCriticalExtension	Not Present		
}			

8.1.1.3 RRC release

8.1.1.3.1 RRC connection release / Redirection to another NR frequency

8.1.1.3.1.1 Test Purpose (TP)

(1)

```
with { UE in NR RRC_CONNECTED state }
ensure that {
  when { UE receives an RRCRelease message including an IE redirectedCarrierInfo with nr and
carrierFreq different from the frequency UE was on in RRC_CONNECTED state }
  then { UE enters RRC_IDLE state on new frequency included in IE redirectedCarrierInfo }
}
```

8.1.1.3.1.2 Conformance requirements

References: The conformance requirements covered in the current TC are specified in: TS 38.331, clause 5.3.8.3, TS 38.304, clause 5.2.4.1. Unless otherwise stated these are Rel-15 requirements.

[TS 38.331, clause 5.3.8.3]

The UE shall:

- 1> delay the following actions defined in this clause 60ms from the moment the *RRCRelease* message was received or optionally when lower layers indicate that the receipt of the *RRCRelease* message has been successfully acknowledged, whichever is earlier;
- 1> stop timer T320, if running;
- 1> if the *RRCRelease* message includes *redirectedCarrierInfo* indicating redirection to *eutra*:
 - 2> if *cnType* is included:
 - 3> the received *cnType* is provided to upper layers;

NOTE: Handling the case if the E-UTRA cell selected after the redirection does not support the core network type specified by the *cnType*, is up to UE implementation.

- 1> if the *RRCRelease* message includes the *cellReselectionPriorities*:
 - 2> store the cell reselection priority information provided by the *cellReselectionPriorities*;
 - 2> if the *t320* is included:
 - 3> start timer T320, with the timer value set according to the value of *t320*;
- 1> else:
 - 2> apply the cell reselection priority information broadcast in the system information;

...

[TS 38.304, clause 5.2.4.1]

...

The UE shall only perform cell reselection evaluation for NR frequencies and inter-RAT frequencies that are given in system information and for which the UE has a priority provided.

...

[TS 38.304, clause 5.2.6]

On transition from RRC_CONNECTED to RRC_IDLE state or RRC_INACTIVE state, UE shall attempt to camp on a suitable cell according to *redirectedCarrierInfo* if included in the *RRCRelease* message used for this transition. If the UE cannot find a suitable cell, the UE is allowed to camp on any suitable cell of the indicated RAT. If the *RRCRelease* message does not contain the *redirectedCarrierInfo*, UE shall attempt to select a suitable cell on an NR carrier. If no suitable cell is found according to the above, the UE shall perform cell selection using stored information in order to find a suitable cell to camp on.

When returning to RRC_IDLE state after UE moved to RRC_CONNECTED state from *camped on any cell* state, UE shall attempt to camp on an acceptable cell according to *redirectedCarrierInfo*, if included in the *RRCRelease* message. If the UE cannot find an acceptable cell, the UE is allowed to camp on any acceptable cell of the indicated RAT. If the *RRCRelease* message does not contain *redirectedCarrierInfo* UE shall attempt to select an acceptable cell on an NR frequency. If no acceptable cell is found according to the above, the UE shall continue to search for an acceptable cell of any PLMN in state *any cell selection*.

8.1.1.3.1.3 Test description

8.1.1.3.1.3.1 Pre-test conditions

System Simulator:

- 2 cells on different NR frequencies and different tracking areas:
 - NR Cell 1 (TAI-1) serving cell
 - NR Cell 23 (TAI-2) suitable neighbour inter-frequency cell
- Cell power levels are selected according to 38.508-1 [4] Table 6.2.2.1-3 for FR1 or Table 6.2.2.2-2 for FR2. NR Cell 23 is switched on after UE has registered on NR Cell 1.
- System information combination NR-4 as defined in TS 38.508-1 [4] clause 4.4.3.1.2 is used in NR cells.

UE:

- None.

Preamble:

- If *pc_IP_Ping* is set to TRUE then, the UE is in 5GS state 3N-A according to TS 38.508-1 [4], clause 4.4A.2 Table 4.4A.2-3.
- Else, the UE is in 5GS state 3N-A and Test Loop Function (*On*) with UE test loop mode B on NR Cell 1 according to 38.508-1[4], clause 4.4A.2 Table 4.4A.2-3.

8.1.1.3.1.3.2 Test procedure sequence

Table 8.1.1.3.1.3.2-1: Main behaviour

St	Procedure	Message Sequence		TP	Verdict
		U - S	Message		
1	The SS transmits an <i>RRCRelease</i> message (IE <i>redirectedCarrierInfo</i> including NR Cell 23).	<--	NR RRC: <i>RRCRelease</i>	-	-
2A	Check: Does the UE transmits an <i>RRCSetupRequest</i> message?	-->	NR RRC: <i>RRCSetupRequest</i>	1	P
2B	SS transmit an <i>RRCSetup</i> message on the NGC Cell 23.	<--	NR RRC: <i>RRCSetup</i>	-	-
2C	Check: Does the UE transmits an <i>RRCSetupComplete</i> message to confirm the successful completion of the connection establishment and a <i>REGISTRATION REQUEST</i> message indicating "mobility registration updating" is sent to update the registration of the actual tracking area?	-->	NR RRC: <i>RRCSetupComplete</i> 5GMM: <i>REGISTRATION REQUEST</i>	1	-
3	The SS transmits a <i>SecurityModeCommand</i> message.	<--	NR RRC: <i>SecurityModeCommand</i>	-	-
4	The UE transmits a <i>SecurityModeComplete</i> message.	-->	NR RRC: <i>SecurityModeComplete</i>	-	-
5-6	Steps 4-5 of TS 38.508-1 [4] Table 4.9.5.2.2-1 of the generic procedure are performed.	-	-	-	-
7	The SS transmits an <i>RRCReconfiguration</i> message to establish SRB2 and DRB.	<--	NR RRC: <i>RRCReconfiguration</i>	-	-
8	The UE transmits an <i>RRCReconfigurationComplete</i> message.	-->	NR RRC: <i>RRCReconfigurationComplete</i>	-	-
9	Check: Does the test result of generic test procedure in TS 38.508-1[4] subclause 4.9.1 indicate that the UE is capable of exchanging IP data on DRB#n associated with the first PDU session?	-	-	1	P

8.1.1.3.1.3.3 Specific message contents

Table 8.1.1.3.1.3.3-1: SIB4 for NR cells 1 and 23 (preamble and all steps, Table 8.1.1.3.1.3.2-1)

Derivation Path: 38.508-1 [4] Table 4.6.2-3			
Information Element	Value/remark	Comment	Condition
SIB4 ::= SEQUENCE {			
interFreqCarrierFreqList SEQUENCE (SIZE (1..maxFreq)) OF InterFreqCarrierFreqInfo {	1 entry		
InterFreqCarrierFreqInfo[1] SEQUENCE {		entry 1	
dl-CarrierFreq	Same downlink NR ARFCN as used for NR Cell 23		NR Cell 1
	Same downlink NR ARFCN as used for NR Cell 1		NR Cell 23
cellReselectionPriority	Not present		
}			
}			
}			

Table 8.1.1.3.1.3.3-2: RRCRelease message (step 1, Table 8.1.1.3.1.3.2-1)

Derivation Path: 38.508-1 [4] Table 4.6.1-16			
Information Element	Value/remark	Comment	Condition
RRCRelease ::= SEQUENCE {			
rrc-TransactionIdentifier	RRC-TransactionIdentifier		
criticalExtensions CHOICE {			
rrcRelease SEQUENCE {			
redirectedCarrierInfo CHOICE {			
nr SEQUENCE {			
carrierFreq	ARFCN-ValueNR for NR Cell 23 frequency		
ssbSubcarrierSpacing	Subcarrier spacing of SSB for NR Cell 23		
smtc	SSB-MTC	38.508-1 [4] Table 4.6.3-185	
}			
}			
}			

Table 8.1.1.3.1.3.3-3: RRCReconfiguration message (step 6, Table 8.1.1.3.1.3.2-1)

Derivation Path: TS 38.508-1 [4] Table 4.6.1-13			
Information Element	Value/remark	Comment	Condition
RRCReconfiguration ::= SEQUENCE {			
criticalExtensions CHOICE {			
rrcReconfiguration SEQUENCE {			
radioBearerConfig SRB2-DRB (n, m)	RadioBearerConfig-SRB2-DRB (n, m)	38.508-1 [4] Table 4.8.1-4	
nonCriticalExtension SEQUENCE {			
masterCellGroup	CellGroupConfig-SRB2-DRB(n, m)	38.508-1 [4] Table 4.8.1-2B	
}			
}			
}			

8.1.1.3.2 RRC connection release / Redirection from NR to E-UTRA

8.1.1.3.2.1 Test Purpose (TP)

(1)

```
with { UE in NR RRC_CONNECTED state }
ensure that {
  when { UE receives an RRCRelease message including an IE redirectionInformation with E-UTRA
frequency }
  then { UE enters RRC_IDLE state on E-UTRA frequency included in IE redirectionInformation }
}
```

8.1.1.3.2.2 Conformance requirements

References: The conformance requirements covered in the present TC are specified in: TS 38.331, clause 5.3.8.3, TS 38.304, clause 5.2.6.

[TS 38.331, clause 5.3.8.3]

The UE shall:

- 1> delay the following actions defined in this clause 60ms from the moment the *RRCRelease* message was received or optionally when lower layers indicate that the receipt of the *RRCRelease* message has been successfully acknowledged, whichever is earlier;
- 1> stop timer T320, if running;
- 1> if the *RRCRelease* message includes *redirectedCarrierInfo* indicating redirection to *eutra*:
 - 2> if *cnType* is included:
 - 3> after the cell selection, indicate the available CN Type(s) and the received *cnType* to upper layers;

NOTE: Handling the case if the E-UTRA cell selected after the redirection does not support the core network type specified by the *cnType*, is up to UE implementation.

[TS 38.304, clause 5.2.6]

At reception of *RRCRelease* message to transition the UE to RRC_IDLE or RRC_INACTIVE, UE shall attempt to camp on a suitable cell according to *redirectedCarrierInfo* if included in the *RRCRelease* message used for this transition. If the UE cannot find a suitable cell, the UE is allowed to camp on any suitable cell of the indicated RAT. If the *RRCRelease* message does not contain the *redirectedCarrierInfo*, UE shall attempt to select a suitable cell on an NR carrier. If no suitable cell is found according to the above, the UE shall perform cell selection using stored information in order to find a suitable cell to camp on.

When returning to RRC_IDLE state after UE moved to RRC_CONNECTED state from *camped on any cell* state, UE shall attempt to camp on an acceptable cell according to *redirectedCarrierInfo*, if included in the *RRCRelease* message. If the UE cannot find an acceptable cell, the UE is allowed to camp on any acceptable cell of the indicated RAT. If the *RRCRelease* message does not contain *redirectedCarrierInfo* UE shall attempt to select an acceptable cell on an NR frequency. If no acceptable cell is found according to the above, the UE shall continue to search for an acceptable cell of any PLMN in state *any cell selection*.

8.1.1.3.2.3 Test description

8.1.1.3.2.3.1 Pre-test conditions

System Simulator:

- NR Cell 1 is the serving cell. System information combination NR-6 as defined in TS 38.508 -1 [4] clause 4.4.3.1.2 is used
- E-UTRA Cell 1 is a suitable neighbour cell. System information combination 31 as defined in TS 38.508 [7], subclause 4.4.3.1.1
- The parameters settings and power levels for NR Cell 1, E-UTRA Cell 1 are selected to ensure that camping on NR Cell 1 is guaranteed and no cell re-selection to E-UTRA Cell 1 can take place (E -UTRA Cell 1 priority is lower than serving NR Cell 1).

UE:

- None

Preamble:

- With E-UTRA Cell 1 "Serving cell" and NR Cell 1 "Non-suitable "Off" cell", the UE is brought to state 1E-A, RRC_IDLE Connectivity (EUTRA), in accordance with the procedure described in TS 38.508-1 [4], Table 4.5.2.2-1.
- the UE is switched-off
- With E-UTRA Cell 1 and NR Cell 1 power levels set according to T0, the UE is brought to state 3N-A as defined in TS 38.508-1 [4], clause 4.4A.2.

8.1.1.3.2.3.2 Test procedure sequence

Tables 8.1.1.3.2.3.2-1/ 8.1.1.3.2.3.2-1A illustrates the downlink power levels to be applied for NR Cell 1, E-UTRA Cell 1 for the test execution.

Table 8.1.1.3.2.3.2-1: Time instances of cell power level and parameter changes for FR1

	Parameter	Unit	NR Cell 1	E-UTRA Cell 1	Remark
T0	Cell-specific RS EPRE	dBm/15 kHz		-91	The power levels are such that camping on NR Cell 1 is guaranteed.
	SS/PBCH SSS EPRE	dBm/S CS	-85	-	

Table 8.1.1.3.2.3.2-1A: Time instances of cell power level and parameter changes for FR2

	Parameter	Unit	NR Cell 1	E-UTRA Cell 1	Remark
T0	Cell-specific RS EPRE	dBm/15 kHz		-96	The power levels are such that camping on NR Cell 1 is guaranteed.
	SS/PBCH SSS EPRE	dBm/S CS	-82	-	

Table 8.1.1.3.2.3.2-2: Main behaviour

St	Procedure	Message Sequence		TP	Verdict
		U - S	Message		
1	SS transmits an <i>RRCRelease</i> message (IE <i>redirectionInformation</i> including ARFCN-ValueEUTRA of E-UTRA Cell 1).	<--	NR RRC: <i>RRCRelease</i>	-	-
2	Check: Does the test result of generic test procedure in TS 38.508-1 Table 4.9.7.2.2-1 is performed and the UE is camped on E-UTRAN Cell 1, with connected without release"?	-	-	1	-

8.1.1.3.2.3.3 Specific message contents

Table 8.1.1.3.2.3.3-1 *RRCRelease* (step 1, Table 8.1.1.3.2.3.2-2)

Derivation Path: 38.508-1 table 4.6.1-16			
Information Element	Value/remark	Comment	Condition
<i>RRCRelease</i> ::= SEQUENCE {			
criticalExtensions CHOICE {			
<i>rrcRelease</i> SEQUENCE {			
<i>redirectedCarrierInfo</i> CHOICE {			
<i>eutra</i> SEQUENCE {			
<i>eutraFrequency</i>	EARFCN of E-UTRA Cell 1		
<i>cnType-r15</i>	Epc		
}			
}			
}			
}			
}			

8.1.1.3.3 RRC connection release / Success / With priority information

8.1.1.3.3.1 Test Purpose (TP)

(1)

```
with { UE in NR RRC_IDLE state having received an RRCRelease message with the freqPriorityListNR
with higher priority frequency }
ensure that {
  when { UE detects the cell re-selection criteria are met for the cell which belongs to the higher
priority frequency }
  then { UE reselects the cell which belongs to the higher priority frequency }
}
```

(2)

```
with { UE in NR RRC_IDLE state having received an RRCRelease message with the freqPriorityListNR
with higher priority frequency and timer T320 }
ensure that {
  when { T320 timer expires }
  then { UE discards the cell reselection priority information provided by the
cellReselectionPriorities and apply the cell reselection priority information broadcast in the
system information to perform reselection to another NR cell }
}
```

8.1.1.3.3.2 Conformance requirements

References: The conformance requirements covered in the current TC are specified in: TS 38.331, clause 5.3.8.3 and TS38.304, clause 5.2.4.1, 5.2.4.2 and 5.2.4.5. Unless otherwise stated these are Rel-15 requirements.

[TS 38.331, clause 5.3.8.3]

The UE shall:

- 1> delay the following actions defined in this sub-clause 60 ms from the moment the *RRCRelease* message was received or optionally when lower layers indicate that the receipt of the *RRCRelease* message has been successfully acknowledged, whichever is earlier;
 - 1> stop timer T380, if running;
 - 1> stop timer T320, if running;
 - 1> stop timer T390, if running;
 - 1> if the security is not activated, perform the actions upon going to RRC_IDLE as specified in 5.3.11 with the release cause 'other' upon which the procedure ends;
 - 1> if the *RRCRelease* message includes *redirectedCarrierInfo* indicating redirection to *eutra*:
 - 2> if *cnType* is included:
 - 3> after the cell selection, indicate the available CN Type(s) and the received *cnType* to upper layers;
- NOTE: Handling the case if the E-UTRA cell selected after the redirection does not support the core network type specified by the *cnType*, is up to UE implementation.
- 1> if the *RRCRelease* message includes the *cellReselectionPriorities*:
 - 2> store the cell reselection priority information provided by the *cellReselectionPriorities*;
 - 2> if the *t320* is included:
 - 3> start timer T320, with the timer value set according to the value of *t320*;
 - 1> else:
 - 2> apply the cell reselection priority information broadcast in the system information;
 - 1> if *deprioritisationReq* is included:

- 2> start or restart timer T325 with the timer value set to the *deprioritisationTimer* signalled;
- 2> store the *deprioritisationReq* until T325 expiry;
- 1> if the *RRCRelease* includes *suspendConfig*:
 - 2> apply the received *suspendConfig*;
 - 2> reset MAC and release the default MAC Cell Group configuration, if any;
 - 2> re-establish RLC entities for SRB1;
 - 2> if the *RRCRelease* message with *suspendConfig* was received in response to an *RRCResumeRequest* or an *RRCResumeRequest1*:
 - 3> stop the timer T319 if running;
 - 3> in the stored UE Inactive AS context:
 - 4> replace the K_{gNB} and K_{RRCint} keys with the current K_{gNB} and K_{RRCint} keys;
 - 4> replace the C-RNTI with the temporary C-RNTI in the cell the UE has received the *RRCRelease* message;
 - 4> replace the *cellIdentity* with the *cellIdentity* of the cell the UE has received the *RRCRelease* message;
 - 4> replace the physical cell identity with the physical cell identity of the cell the UE has received the *RRCRelease* message;
 - 4> replace the *suspendConfig* with the current *suspendConfig*;
 - 2> else:
 - 3> store in the UE Inactive AS Context the received *suspendConfig*, all current parameters configured with *RRCReconfiguration* or *RRCResume*, the current K_{gNB} and K_{RRCint} keys, the ROHC state, the C-RNTI used in the source PCell, the *cellIdentity* and the physical cell identity of the source PCell;
 - 2> suspend all SRB(s) and DRB(s), except SRB0;
 - 2> indicate PDCP suspend to lower layers of all DRBs;
 - 2> if the *t380* is included:
 - 3> start timer T380, with the timer value set to *t380*;
 - 2> if the *RRCRelease* message is including the *waitTime*:
 - 3> start timer T302 with the value set to the *waitTime*;
 - 3> inform the upper layer that access barring is applicable for all access categories except categories '0' and '2';
 - 2> indicate the suspension of the RRC connection to upper layers;
 - 2> enter RRC_INACTIVE and perform cell selection as specified in TS 38.304 [20];
- 1> else
 - 2> perform the actions upon going to RRC_IDLE as specified in 5.3.11, with the release cause 'other'.

[TS 38.331, clause 5.3.8.4]

The UE shall:

- 1> if T320 expires:
 - 2> if stored, discard the cell reselection priority information provided by the *cellReselectionPriorities* or inherited from another RAT;

2> apply the cell reselection priority information broadcast in the system information.

[TS 38.304, clause 5.2.4.1]

Absolute priorities of different NR frequencies or inter-RAT frequencies may be provided to the UE in the system information, in the *RRCRelease* message, or by inheriting from another RAT at inter-RAT cell (re)selection. In the case of system information, an NR frequency or inter-RAT frequency may be listed without providing a priority (i.e. the field *cellReselectionPriority* is absent for that frequency). If priorities are provided in dedicated signalling, the UE shall ignore all the priorities provided in system information. If UE is in *camped on any cell* state, UE shall only apply the priorities provided by system information from current cell, and the UE preserves priorities provided by dedicated signalling and *deprioritisationReq* received in *RRCRelease* unless specified otherwise. When the UE in *camped normally* state, has only dedicated priorities other than for the current frequency, the UE shall consider the current frequency to be the lowest priority frequency (i.e. lower than any of the network configured values).

The UE shall only perform cell reselection evaluation for NR frequencies and inter-RAT frequencies that are given in system information and for which the UE has a priority provided.

In case UE receives *RRCRelease* with *deprioritisationReq*, UE shall consider current frequency and stored frequencies due to the previously received *RRCRelease* with *deprioritisationReq* or all the frequencies of NR to be the lowest priority frequency (i.e. lower than any of the network configured values) while T325 is running irrespective of *camped* RAT. The UE shall delete the stored deprioritisation request(s) when a PLMN selection is performed on request by NAS (TS 23.122 [9]).

NOTE: UE should search for a higher priority layer for cell reselection as soon as possible after the change of priority. The minimum related performance requirements specified in TS 38.133 [8] are still applicable.

The UE shall delete priorities provided by dedicated signalling when:

- the UE enters a different RRC state; or
- the optional validity time of dedicated priorities (T320) expires; or
- a PLMN selection is performed on request by NAS (TS 23.122 [9]).

NOTE 2: Equal priorities between RATs are not supported.

The UE shall not consider any black listed cells as candidate for cell reselection.

The UE shall inherit the priorities provided by dedicated signalling and the remaining validity time (i.e. T320 in NR and E-UTRA), if configured, at inter-RAT cell (re)selection.

NOTE 3: The network may assign dedicated cell reselection priorities for frequencies not configured by system information.

[TS 38.304, clause 5.2.4.1]

Absolute priorities of different NR frequencies or inter-RAT frequencies may be provided to the UE in the system information, in the *RRCRelease* message, or by inheriting from another RAT at inter-RAT cell (re)selection. In the case of system information, an NR frequency or inter-RAT frequency may be listed without providing a priority (i.e. the field *cellReselectionPriority* is absent for that frequency). If priorities are provided in dedicated signalling, the UE shall ignore all the priorities provided in system information. If UE is in *camped on any cell* state, UE shall only apply the priorities provided by system information from current cell, and the UE preserves priorities provided by dedicated signalling and *deprioritisationReq* received in *RRCRelease* unless specified otherwise. When the UE in *camped normally* state, has only dedicated priorities other than for the current frequency, the UE shall consider the current frequency to be the lowest priority frequency (i.e. lower than any of the network configured values).

The UE shall only perform cell reselection evaluation for NR frequencies and inter-RAT frequencies that are given in system information and for which the UE has a priority provided.

In case UE receives *RRCRelease* with *deprioritisationReq*, UE shall consider current frequency and stored frequencies due to the previously received *RRCRelease* with *deprioritisationReq* or all the frequencies of NR to be the lowest priority frequency (i.e. lower than any of the network configured values) while T325 is running irrespective of *camped* RAT. The UE shall delete the stored deprioritisation request(s) when a PLMN selection is performed on request by NAS (TS 23.122 [9]).

NOTE: UE should search for a higher priority layer for cell reselection as soon as possible after the change of priority. The minimum related performance requirements specified in TS 38.133 [8] are still applicable.

The UE shall delete priorities provided by dedicated signalling when:

- the UE enters a different RRC state; or
- the optional validity time of dedicated priorities (T320) expires; or
- a PLMN selection is performed on request by NAS (TS 23.122 [9]).

NOTE 2: Equal priorities between RATs are not supported.

The UE shall not consider any black listed cells as candidate for cell reselection.

The UE shall inherit the priorities provided by dedicated signalling and the remaining validity time (i.e. T320 in NR and E-UTRA), if configured, at inter-RAT cell (re)selection.

NOTE 3: The network may assign dedicated cell reselection priorities for frequencies not configured by system information.

[TS 38.304, clause 5.2.4.2]

Following rules are used by the UE to limit needed measurements:

- If the serving cell fulfils $S_{rxlev} > S_{IntraSearchP}$ and $S_{qual} > S_{IntraSearchQ}$, the UE may choose not to perform intra-frequency measurements.
- Otherwise, the UE shall perform intra-frequency measurements.
- The UE shall apply the following rules for NR inter-frequencies and inter-RAT frequencies which are indicated in system information and for which the UE has priority provided as defined in 5.2.4.1:
 - For a NR inter-frequency or inter-RAT frequency with a reselection priority higher than the reselection priority of the current NR frequency, the UE shall perform measurements of higher priority NR inter-frequency or inter-RAT frequencies according to TS 38.133 [8].
 - For a NR inter-frequency with an equal or lower reselection priority than the reselection priority of the current NR frequency and for inter-RAT frequency with lower reselection priority than the reselection priority of the current NR frequency:
 - If the serving cell fulfils $S_{rxlev} > S_{nonIntraSearchP}$ and $S_{qual} > S_{nonIntraSearchQ}$, the UE may choose not to perform measurements of NR inter-frequencies or inter-RAT frequency cells of equal or lower priority;
 - Otherwise, the UE shall perform measurements of NR inter-frequencies or inter-RAT frequency cells of equal or lower priority according to TS 38.133 [8].

[TS 38.304, clause 5.2.4.5]

If *threshServingLowQ* is broadcast in system information and more than 1 second has elapsed since the UE camped on the current serving cell, cell reselection to a cell on a higher priority NR frequency or inter-RAT frequency than the serving frequency shall be performed if:

- A cell of a higher priority NR or EUTRAN RAT/frequency fulfils $S_{qual} > Thresh_{X, HighQ}$ during a time interval $T_{reselection_{RAT}}$

Otherwise, cell reselection to a cell on a higher priority NR frequency or inter-RAT frequency than the serving frequency shall be performed if:

- A cell of a higher priority RAT/ frequency fulfils $S_{rxlev} > Thresh_{X, HighP}$ during a time interval $T_{reselection_{RAT}}$; and
- More than 1 second has elapsed since the UE camped on the current serving cell.

Cell reselection to a cell on an equal priority NR frequency shall be based on ranking for intra-frequency cell reselection as defined in sub-clause 5.2.4.6.

If *threshServingLowQ* is broadcast in system information and more than 1 second has elapsed since the UE camped on the current serving cell, cell reselection to a cell on a lower priority NR frequency or inter-RAT frequency than the serving frequency shall be performed if:

- The serving cell fulfils $S_{qual} < \text{Thresh}_{\text{Serving, LowQ}}$ and a cell of a lower priority NR or E-UTRAN RAT/ frequency fulfils $S_{qual} > \text{Thresh}_{X, \text{LowQ}}$ during a time interval $\text{Treselection}_{\text{RAT}}$.

Otherwise, cell reselection to a cell on a lower priority NR frequency or inter-RAT frequency than the serving frequency shall be performed if:

- The serving cell fulfils $S_{rxlev} < \text{Thresh}_{\text{Serving, LowP}}$ and a cell of a lower priority RAT/ frequency fulfils $S_{rxlev} > \text{Thresh}_{X, \text{LowP}}$ during a time interval $\text{Treselection}_{\text{RAT}}$; and
- More than 1 second has elapsed since the UE camped on the current serving cell.

Cell reselection to a higher priority RAT/frequency shall take precedence over a lower priority RAT/frequency if multiple cells of different priorities fulfil the cell reselection criteria.

If more than one cell meets the above criteria, the UE shall reselect a cell as follows:

- If the highest-priority frequency is an NR frequency, the highest ranked cell among the cells on the highest priority frequency(ies) meeting the criteria according to clause 5.2.4.6;
- If the highest-priority frequency is from another RAT, the highest ranked cell among the cells on the highest priority frequency(ies) meeting the criteria of that RAT.

[TS 38.304, clause 5.2.4.6]

The cell-ranking criterion R_s for serving cell and R_n for neighbouring cells is defined by:

$$R_s = Q_{\text{meas},s} + Q_{\text{hyst}} - Q_{\text{offset,temp}}$$

$$R_n = Q_{\text{meas},n} - Q_{\text{offset}} - Q_{\text{offset,temp}}$$

where:

Q_{meas}	RSRP measurement quantity used in cell reselections.
Q_{offset}	For intra-frequency: Equals to $Q_{\text{offset},s,n}$, if $Q_{\text{offset},s,n}$ is valid, otherwise this equals to zero. For inter-frequency: Equals to $Q_{\text{offset},s,n}$ plus $Q_{\text{offset,frequency}}$, if $Q_{\text{offset},s,n}$ is valid, otherwise this equals to $Q_{\text{offset,frequency}}$.
$Q_{\text{offset,temp}}$	Offset temporarily applied to a cell as specified in TS 38.331 [3].

The UE shall perform ranking of all cells that fulfil the cell selection criterion S , which is defined in 5.2.3.2.

The cells shall be ranked according to the R criteria specified above by deriving $Q_{\text{meas},n}$ and $Q_{\text{meas},s}$ and calculating the R values using averaged RSRP results.

If *rangeToBestCell* is not configured, the UE shall perform cell reselection to the highest ranked cell. If this cell is found to be not-suitable, the UE shall behave according to clause 5.2.4.4.

If *rangeToBestCell* is configured, then the UE shall perform cell reselection to the cell with the highest number of beams above the threshold (i.e. *absThreshSS-BlocksConsolidation*) among the cells whose R value is within *rangeToBestCell* of the R value of the highest ranked cell. If there are multiple such cells, the UE shall perform cell reselection to the highest ranked cell among them. If this cell is found to be not-suitable, the UE shall behave according to clause 5.2.4.4.

In all cases, the UE shall reselect the new cell, only if the following conditions are met:

- the new cell is better than the serving cell according to the cell reselection criteria specified above during a time interval $\text{Treselection}_{\text{RAT}}$;
- more than 1 second has elapsed since the UE camped on the current serving cell.

NOTE: If *rangeToBestCell* is configured but *absThreshSS-BlocksConsolidation* is not configured on an NR frequency, the UE considers that there is one beam above the threshold for each cell on that frequency.

8.1.1.3.3.3 Test description

8.1.1.3.3.3.1 Pre-test conditions

System Simulator:

- NR Cell 1, NR Cell 3 and NR Cell 6.
- NR Cell 1 (TAI-1) serving cell.
- System information combination NR-4 as defined in TS 38.508-1 [4] clause 4.4.3.1.2-1 is used in NR cells.

NOTE: For Cell 3 and 6 TAI is set to TAI-2

UE:

- None.

Preamble:

- If *pc_IP_Ping* is set to TRUE then, the UE is in 5GS state 3N-A according to TS 38.508-1 [4], clause 4.4A.2 Table 4.4A.2-3.
- Else, the UE is in 5GS state 3N-A and Test Loop Function (On) with UE test loop mode B on NR Cell 1 according to 38.508-1[4], clause 4.4A.2 Table 4.4A.2-3.

8.1.1.3.3.3.2 Test procedure sequence

Table 8.1.1.3.3.3.2-1/2 illustrates the downlink power levels and other changing parameters to be applied for the cells at various time instants of the test execution. Row marked "T0" denotes the initial conditions after preamble, while columns marked "T1" is to be applied subsequently. The exact instants on which these values shall be applied are described in the texts in this clause.

Table 8.1.1.3.3.3.2-1: Time instances of cell power level and parameter changes for FR1

	Parameter	Unit	NR Cell 1	NR Cell 3	NR Cell 6	Remark
T0	SS/PBCH SSS EPRE	dBm/ SCS	-88	Off	Off	The power level values are assigned to satisfy $S_{rxlevCell 1} > S_{intra search}$. (NOTE 1)
T1	SS/PBCH SSS EPRE	dBm/ SCS	-88	-94	-88	The power level values are assigned to satisfy both $Thresh_{x, high} < S_{rxlevCell 3}$ and $Thresh_{x, low} < S_{rxlevCell 6}$.
T2	SS/PBCH SSS EPRE	dBm/ SCS	-88	Off	-88	The power level values are assigned to satisfy $Thresh_{x, high} < S_{rxlevCell 6}$.

NOTE 1: Power level "Off" is defined in TS38.508 Table 6.2.2.1-3.

Table 8.1.1.3.3.2-2 Time instances of cell power level and parameter changes for FR2

	Parameter	Unit	NR Cell 1	NR Cell 3	NR Cell 6	Remark
T0	SS/PBCH SSS EPRE	dBm/ SCS	-82	Off	Off	The power level values are assigned to satisfy $Srxlev_{Cell 1} > S_{intra search}$. (NOTE 1)
T1	SS/PBCH SSS EPRE	dBm/ SCS	-82	-91	-82	The power level values are assigned to satisfy both $Thresh_{x, high} < Srxlev_{Cell 3}$ and $Thresh_{x, low} < Srxlev_{Cell 6}$.
T2	SS/PBCH SSS EPRE	dBm/ SCS	-82	Off	-82	The power level values are assigned to satisfy $Thresh_{x, high} < Srxlev_{Cell 6}$.
NOTE 1: Power level "Off" is defined in TS38.508 Table 6.2.2.1-3.						

Table 8.1.1.3.3.3.2-3: Main behaviour

St	Procedure	Message Sequence		TP	Verdict
		U - S	Message		
1	The SS changes NR Cell 1, NR Cell 3 and NR Cell 6 power level according to the row "T1" in table 8.1.1.3.3.3.2-1/2.	-	-	-	-
2	The SS transmits an <i>RRCRelease</i> message including the <i>freqPriorityListNR</i> on NR Cell 1.	<--	NR RRC: <i>RRCRelease</i>	-	-
2A	Check: Does the UE transmits an <i>RRCSetupRequest</i> message on NR Cell3?	-->	NR RRC: <i>RRCSetupRequest</i>	1	P
2B	SS transmit an <i>RRCSetup</i> message on NR Cell3.	<--	NR RRC: <i>RRCSetup</i>	-	-
2C	Check: Does the UE transmits an <i>RRCConnectionSetupComplete</i> message to confirm the successful completion of the connection establishment and a <i>REGISTRATION REQUEST</i> message indicating "mobility registration updating" is sent to update the registration of the actual tracking area?	-->	NR RRC: <i>RRCSetupComplete</i> 5GMM: <i>REGISTRATION REQUEST</i>	1	P
3	Void				
3A	The SS transmits a <i>SecurityModeCommand</i> message.	<--	NR RRC: <i>SecurityModeCommand</i>		
3B	The UE transmits a <i>SecurityModeComplete</i> message.	-->	NR RRC: <i>SecurityModeComplete</i>		
3C-3D	Steps 4-5 of TS 38.508-1 [4] Table 4.9.5.2.2-1 of the generic procedure are performed.	-	-	-	-
3E	The SS transmits an <i>RRCReconfiguration</i> message to establish SRB2 and DRB.	<--	NR RRC: <i>RRCReconfiguration</i>	-	-
3F	The UE transmits an <i>RRCReconfigurationComplete</i> message.	-->	NR RRC: <i>RRCReconfigurationComplete</i>	-	-
3G	Check: Does the test result of generic test procedure in TS 38.508-1 [4] subclause 4.9.1 indicate that the UE is capable of exchanging IP data on DRB #n associated with the first PDU session on NR Cell 3?	-	-	1	-
3H	The SS releases RRC connection.	-	-	-	-
4	The SS changes NR Cell 1, NR Cell 3 and NR Cell 6 power level according to the row "T0" in table 8.1.1.3.3.3.2-1/2.	-	-	-	-
5-5B	Steps 1-3 in TS 38.508-1 [4] Table 4.9.5.2.2-1 are performed on NR Cell 1.	-	-	-	-
5C	The SS transmits a <i>SecurityModeCommand</i> message.	<--	NR RRC: <i>SecurityModeCommand</i>	-	-
5D	The UE transmits a <i>SecurityModeComplete</i> message.	-->	NR RRC: <i>SecurityModeComplete</i>	-	-
5E-5F	Steps 4-5 in TS 38.508-1 [4] Table 4.9.5.2.2-1 are performed.			-	-
6	The SS transmits an <i>RRCRelease</i> message containing IE <i>freqPriorityListNR</i> to update the cell reselection priority of NR Cell 6 and the timer T320.	<--	NR RRC: <i>RRCRelease</i>	-	-
7	The SS changes NR Cell 1, NR Cell 3 and NR Cell 6 power level according to the row "T2" in table 8.1.1.3.3.3.2-1/2.	-	-	-	-
8	Check: Does the UE transmit an <i>RRCSetupRequest</i> message within T320 running?	-->	NR RRC: <i>RRCSetupRequest</i>	2	F
9	Check: After timer T320 expiry, does the UE perform the Registration procedure for mobility registration update as described in steps 1-3 of Table 4.9.5.2.2-1 on NR Cell 6?	-	-	2	-
10	The SS transmits a <i>SecurityModeCommand</i> message.	<--	NR RRC: <i>SecurityModeCommand</i>	-	-
11	The UE transmits a <i>SecurityModeComplete</i> message.	-->	NR RRC: <i>SecurityModeComplete</i>	-	-

Table 8.1.1.3.3.3.2-2: SIB4 for Cell 1 (preamble and all steps, Table 8.1.1.3.3.3.2-3)

Derivation path: 38.508-1 [4], Table 4.6.2-3			
Information Element	Value/Remark	Comment	Condition
SystemInformationBlockType4 ::= SEQUENCE {			
interFreqCarrierFreqList SEQUENCE (SIZE (1..maxFreq)) OF InterFreqCarrierFreqInfo {	2 entries		
InterFreqCarrierFreqInfo[1] SEQUENCE {		entry 1	
dl-CarrierFreq	Same downlink NR ARFCN as used for NR Cell 3		
cellReselectionPriority	1		
}			
InterFreqCarrierFreqInfo[2] SEQUENCE {		entry 2	
dl-CarrierFreq	Same downlink NR ARFCN as used for NR Cell 6		
cellReselectionPriority	5		
}			
}			
}			

Table 8.1.1.3.3.3.3-3: SIB4 for Cell 6 (all steps, Table 8.1.1.3.3.3.2-3)

Derivation path: 38.508-1 [4], Table 4.6.2-3			
Information Element	Value/Remark	Comment	Condition
SystemInformationBlockType4 ::= SEQUENCE {			
interFreqCarrierFreqList SEQUENCE (SIZE (1..maxFreq)) OF InterFreqCarrierFreqInfo {	2 entries		
InterFreqCarrierFreqInfo[1] SEQUENCE {		entry 1	
dl-CarrierFreq	Same downlink NR ARFCN as used for NR Cell 1		
cellReselectionPriority	4		
}			
InterFreqCarrierFreqInfo[2] SEQUENCE {		entry 2	
dl-CarrierFreq	Same downlink NR ARFCN as used for NR Cell 3		
cellReselectionPriority	1		
}			
}			
}			

(2)

```

with { UE in NR RRC_IDLE state having received an RRCRelease message with the freqPriorityListEUTRA
with higher priority frequency and timer T320 }
ensure that {
  when { T320 timer expires }
  then { UE discards the cell reselection priority information provided by the
cellReselectionPriorities and apply the cell reselection priority information broadcast in the
system information to perform reselection to an E-UTRA cell }
}

```

8.1.1.3.4.2 Conformance requirements

References: The conformance requirements covered in the current TC are specified in: TS 38.331, clause 5.3.8.3 and T 38.304, clause 5.2.4.1. Unless otherwise stated these are Rel-15 requirements.

[TS 38.331, clause 5.3.8.3]

The UE shall:

- 1> delay the following actions defined in this sub-clause 60 ms from the moment the *RRCRelease* message was received or optionally when lower layers indicate that the receipt of the *RRCRelease* message has been successfully acknowledged, whichever is earlier;
- 1> stop timer T380, if running;
- 1> stop timer T320, if running;
- 1> stop timer T390, if running;
- 1> if the security is not activated, perform the actions upon going to RRC_IDLE as specified in 5.3.11 with the release cause 'other' upon which the procedure ends;
- ...
- 1> if the *RRCRelease* message includes the *cellReselectionPriorities*:
 - 2> store the cell reselection priority information provided by the *cellReselectionPriorities*;
 - 2> if the *t320* is included:
 - 3> start timer T320, with the timer value set according to the value of *t320*;
- 1> else:
 - 2> apply the cell reselection priority information broadcast in the system information;

[TS 38.304, clause 5.2.4.1]

Absolute priorities of different NR frequencies or inter-RAT frequencies may be provided to the UE in the system information, in the *RRCRelease* message, or by inheriting from another RAT at inter-RAT cell (re)selection. In the case of system information, an NR frequency or inter-RAT frequency may be listed without providing a priority (i.e. the field *cellReselectionPriority* is absent for that frequency). If priorities are provided in dedicated signalling, the UE shall ignore all the priorities provided in system information. If UE is in *camped on any cell* state, UE shall only apply the priorities provided by system information from current cell, and the UE preserves priorities provided by dedicated signalling and *deprioritisationReq* received in *RRCRelease* unless specified otherwise. When the UE in *camped normally* state, has only dedicated priorities other than for the current frequency, the UE shall consider the current frequency to be the lowest priority frequency (i.e. lower than any of the network configured values).

The UE shall only perform cell reselection evaluation for NR frequencies and inter-RAT frequencies that are given in system information and for which the UE has a priority provided.

In case UE receives *RRCRelease* with *deprioritisationReq*, UE shall consider current frequency and stored frequencies due to the previously received *RRCRelease* with *deprioritisationReq* or all the frequencies of NR to be the lowest priority frequency (i.e. lower than any of the network configured values) while T325 is running irrespective of *camped* RAT. The UE shall delete the stored *deprioritisationReq* request(s) when a PLMN selection is performed on request by NAS (TS 23.122 [9]).

NOTE: UE should search for a higher priority layer for cell reselection as soon as possible after the change of priority. The minimum related performance requirements specified in TS 38.133 [8] are still applicable.

The UE shall delete priorities provided by dedicated signalling when:

- the UE enters a different RRC state; or
- the optional validity time of dedicated priorities (T320) expires; or
- a PLMN selection is performed on request by NAS (TS 23.122 [9]).

NOTE 2: Equal priorities between RATs are not supported.

The UE shall not consider any black listed cells as candidate for cell reselection.

The UE shall inherit the priorities provided by dedicated signalling and the remaining validity time (i.e. T320 in NR and E-UTRA), if configured, at inter-RAT cell (re)selection.

NOTE 3: The network may assign dedicated cell reselection priorities for frequencies not configured by system information.

[TS 38.331, clause 5.3.8.4]

The UE shall:

- 1> if T320 expires:
 - 2> if stored, discard the cell reselection priority information provided by the *cellReselectionPriorities* or inherited from another RAT;
 - 2> apply the cell reselection priority information broadcast in the system information.

[TS 38.304, clause 5.2.4.2]

Following rules are used by the UE to limit needed measurements:

- If the serving cell fulfils $S_{rxlev} > S_{IntraSearchP}$ and $S_{qual} > S_{IntraSearchQ}$, the UE may choose not to perform intra-frequency measurements.
- Otherwise, the UE shall perform intra-frequency measurements.
- The UE shall apply the following rules for NR inter-frequencies and inter-RAT frequencies which are indicated in system information and for which the UE has priority provided as defined in 5.2.4.1:
 - For a NR inter-frequency or inter-RAT frequency with a reselection priority higher than the reselection priority of the current NR frequency, the UE shall perform measurements of higher priority NR inter-frequency or inter-RAT frequencies according to TS 38.133 [8].
 - For a NR inter-frequency with an equal or lower reselection priority than the reselection priority of the current NR frequency and for inter-RAT frequency with lower reselection priority than the reselection priority of the current NR frequency:
 - If the serving cell fulfils $S_{rxlev} > S_{nonIntraSearchP}$ and $S_{qual} > S_{nonIntraSearchQ}$, the UE may choose not to perform measurements of NR inter-frequencies or inter-RAT frequency cells of equal or lower priority;
 - Otherwise, the UE shall perform measurements of NR inter-frequencies or inter-RAT frequency cells of equal or lower priority according to TS 38.133 [8].

[TS 38.304, clause 5.2.4.5]

If *threshServingLowQ* is broadcast in system information and more than 1 second has elapsed since the UE camped on the current serving cell, cell reselection to a cell on a higher priority NR frequency or inter-RAT frequency than the serving frequency shall be performed if:

- A cell of a higher priority NR or EUTRAN RAT/frequency fulfils $S_{qual} > Thresh_{X, HighQ}$ during a time interval $T_{reselectionRAT}$

Otherwise, cell reselection to a cell on a higher priority NR frequency or inter-RAT frequency than the serving frequency shall be performed if:

- A cell of a higher priority RAT/ frequency fulfils $Srxlev > Thresh_{X, HighP}$ during a time interval $Treselection_{RAT}$; and
- More than 1 second has elapsed since the UE camped on the current serving cell.

Cell reselection to a cell on an equal priority NR frequency shall be based on ranking for intra-frequency cell reselection as defined in sub-clause 5.2.4.6.

If $thresh_{ServingLowQ}$ is broadcast in system information and more than 1 second has elapsed since the UE camped on the current serving cell, cell reselection to a cell on a lower priority NR frequency or inter-RAT frequency than the serving frequency shall be performed if:

- The serving cell fulfils $Squal < Thresh_{Serving, LowQ}$ and a cell of a lower priority NR or E-UTRAN RAT/ frequency fulfils $Squal > Thresh_{X, LowQ}$ during a time interval $Treselection_{RAT}$.

Otherwise, cell reselection to a cell on a lower priority NR frequency or inter-RAT frequency than the serving frequency shall be performed if:

- The serving cell fulfils $Srxlev < Thresh_{Serving, LowP}$ and a cell of a lower priority RAT/ frequency fulfils $Srxlev > Thresh_{X, LowP}$ during a time interval $Treselection_{RAT}$; and
- More than 1 second has elapsed since the UE camped on the current serving cell.

Cell reselection to a higher priority RAT/frequency shall take precedence over a lower priority RAT/frequency if multiple cells of different priorities fulfil the cell reselection criteria.

If more than one cell meets the above criteria, the UE shall reselect a cell as follows:

- If the highest-priority frequency is an NR frequency, the highest ranked cell among the cells on the highest priority frequency(ies) meeting the criteria according to clause 5.2.4.6;
- If the highest-priority frequency is from another RAT, the highest ranked cell among the cells on the highest priority frequency(ies) meeting the criteria of that RAT.

[TS 38.304, clause 5.2.4.6]

The cell-ranking criterion R_s for serving cell and R_n for neighbouring cells is defined by:

$$R_s = Q_{meas,s} + Q_{hyst} - Q_{offset_{temp}}$$

$$R_n = Q_{meas,n} - Q_{offset} - Q_{offset_{temp}}$$

where:

Q_{meas}	RSRP measurement quantity used in cell reselections.
Q_{offset}	For intra-frequency: Equals to $Q_{offset_{s,n}}$, if $Q_{offset_{s,n}}$ is valid, otherwise this equals to zero. For inter-frequency: Equals to $Q_{offset_{s,n}}$ plus $Q_{offset_{frequency}}$, if $Q_{offset_{s,n}}$ is valid, otherwise this equals to $Q_{offset_{frequency}}$.
$Q_{offset_{temp}}$	Offset temporarily applied to a cell as specified in TS 38.331 [3].

The UE shall perform ranking of all cells that fulfil the cell selection criterion S , which is defined in 5.2.3.2.

The cells shall be ranked according to the R criteria specified above by deriving $Q_{meas,n}$ and $Q_{meas,s}$ and calculating the R values using averaged RSRP results.

If *rangeToBestCell* is not configured, the UE shall perform cell reselection to the highest ranked cell. If this cell is found to be not-suitable, the UE shall behave according to subclause 5.2.4.4.

If *rangeToBestCell* is configured, then the UE shall perform cell reselection to the cell with the highest number of beams above the threshold (i.e. *absThreshSS-BlocksConsolidation*) among the cells whose R value is within *rangeToBestCell* of the R value of the highest ranked cell. If there are multiple such cells, the UE shall perform cell

reselection to the highest ranked cell among them. If this cell is found to be not-suitable, the UE shall behave according to subclause 5.2.4.4.

In all cases, the UE shall reselect the new cell, only if the following conditions are met:

- the new cell is better than the serving cell according to the cell reselection criteria specified above during a time interval $T_{\text{reselection,RAT}}$;
- more than 1 second has elapsed since the UE camped on the current serving cell.

8.1.1.3.4.3 Test description

8.1.1.3.4.3.1 Pre-test conditions

System Simulator:

- NR Cell 1, E-UTRA Cell 1 and E-UTRA Cell 3.
- System information combination NR-6 as defined in TS 38.508-1 [4] clause 4.4.3.1.2 is used in NR cell.
- System information combination 1 as defined in TS 36.508 [7] clause 4.4.3.1 is used in E-UTRA cells.

UE:

None.

Preamble:

- With E-UTRA Cell 1 "Serving cell", E-UTRA Cell 3 "Non-suitable "Off" cell" and NR Cell 1 "Non-suitable "Off" cell" in accordance with TS 38.508-1 [4], Table 6.2.2.1-3, the UE is brought to state RRC_IDLE Connectivity (*E-UTRA/EPC*) in accordance with the procedure described in TS 38.508-1 [4], Table 4.5.2.2-1. 4G GUTI and eKSI are assigned and security context established.
- the UE is switched-off.
- With E-UTRA Cell 1 "Non-suitable "Off" cell" and NR Cell 1 "Serving cell" in accordance with TS 38.508-1 [4], Table 6.2.2.1-3, the UE is brought to state 3N-A, NR RRC_CONNECTED, in accordance with the procedure described in TS 38.508-1 [4], Table 4.5.2.2-2. 5G-GUTI and ngKSI are assigned and security context established.
- The UE is in 5GS state 3N-A and Test Loop Function (*On*) with UE test loop mode B on NR Cell 1 according to 38.508-1[4], clause 4.4A.2 Table 4.4A.2-3.

8.1.1.3.4.3.2 Test procedure sequence

Table 8.1.1.3.4.3.2-1/2 illustrates the downlink power levels and other changing parameters to be applied for the cells at various time instants of the test execution. Row marked "T0" denotes the initial conditions after preamble, while columns marked "T1" is to be applied subsequently. The exact instants on which these values shall be applied are described in the texts in this clause.

Table 8.1.1.3.4.3.2-1: Time instances of cell power level and parameter changes in FR1

	Parameter	Unit	NR Cell 1	E-UTRA Cell 1	E-UTRA Cell 3	Remark
T0	Cell-specific RS EPRE	dBm/15kHz	-	"off"	"off"	
	SS/PBCH SSS EPRE	dBm/SCS	-88	-	-	
T1	Cell-specific RS EPRE	dBm/15kHz	-	-73	-73	The power level values are assigned to satisfy both $\text{Thresh}_{x, \text{low}} < \text{Srxlev}_{\text{E-UTRACell 1}}$ and $\text{Thresh}_{x, \text{high}} < \text{Srxlev}_{\text{E-UTRACell 3}}$ but not to satisfy $\text{Srxlev}_{\text{NR Cell 1}} < \text{Thresh}_{\text{Serving, low}}$
	SS/PBCH SSS EPRE	dBm/SCS	-88	-	-	

T2	Cell-specific RS EPRE	dBm/15kHz	-	"off"	"off"	The power level values are assigned to satisfy $S_{rxlev_{NR\ Cell\ 1}} > S_{nonintrasearch}$. (NOTE 1)
	SS/PBCH SSS EPRE	dBm/SCS	-88	-	-	
T3	Cell-specific RS EPRE	dBm/15kHz	-	-73	"off"	The power level values are assigned to satisfy $Thresh_{x, high} < S_{rxlev_{E-UTRA\ Cell\ 1}}$.
	SS/PBCH SSS EPRE	dBm/SCS	-88	-	-	
NOTE 1: Power level "Off" is defined in TS36.508 [7] Table 6.2.2.1-3.						

Table 8.1.1.3.4.3.2-2: Time instances of cell power level and parameter changes in FR2

	Parameter	Unit	NR Cell 1	E-UTRA Cell 1	E-UTRA Cell 3	Remark
T0	Cell-specific RS EPRE	dBm/15kHz	-	"off"	"off"	
	SS/PBCH SSS EPRE	dBm/SCS	FFS	-	-	
T1	Cell-specific RS EPRE	dBm/15kHz	-	FFS	FFS	The power level values are assigned to satisfy both $Thresh_{x, low} < S_{rxlev_{E-UTRA\ Cell\ 1}}$ and $Thresh_{x, high} < S_{rxlev_{E-UTRA\ Cell\ 3}}$ but not to satisfy $S_{rxlev_{NR\ Cell\ 1}} < Thresh_{serving, low}$
	SS/PBCH SSS EPRE	dBm/SCS	FFS	-	-	
T2	Cell-specific RS EPRE	dBm/15kHz	-	"off"	"off"	The power level values are assigned to satisfy $S_{rxlev_{NR\ Cell\ 1}} > S_{nonintrasearch}$. (NOTE 1)
	SS/PBCH SSS EPRE	dBm/SCS	FFS	-	-	
T3	Cell-specific RS EPRE	dBm/15kHz	-	FFS	"off"	The power level values are assigned to satisfy $Thresh_{x, high} < S_{rxlev_{E-UTRA\ Cell\ 1}}$.
	SS/PBCH SSS EPRE	dBm/SCS	FFS	-	-	
NOTE 1: Power level "Off" is defined in TS36.508 [7] Table 6.2.2.1-3.						

Table 8.1.1.3.4.3.2-3: Main behaviour

St	Procedure	Message Sequence		TP	Verdict
		U - S	Message		
1	The SS changes NR Cell 1, E-UTRA Cell 1 and E-UTRA Cell 3 level according to the row "T1" in Table 8.1.1.3.4.3.2-1/2	-	-	-	-
2	The SS transmits an <i>RRRelease</i> message including the <i>freqPriorityListEUTRA</i> on NR Cell 1.	<--	NR RRC: <i>RRRelease</i>	-	-
2A	Check: Does the UE transmits an <i>RRConnectionRequest</i> message on E-UTRA cell 3?	-->	RRC: <i>RRConnectionRequest</i>	1	P
2B	SS transmits an <i>RRConnectionSetup</i> message on E-UTRA cell 3.	<--	RRC: <i>RRConnectionSetup</i>	-	-
2C	Check: Does the UE transmits an <i>RRConnectionSetupComplete</i> message to confirm the successful completion of the connection establishment and a TRACKING AREA UPDATE REQUEST message is sent to update the registration of the actual tracking area?	-->	RRC: <i>RRConnectionSetupComplete</i> NAS: TRACKING AREA UPDATE REQUEST	1	P

3	Void				
3A	The SS transmits a <i>SecurityModeCommand</i> message.	<--	E-UTRA RRC: <i>SecurityModeCommand</i>	-	-
3B	The UE transmits a <i>SecurityModeComplete</i> message.	-->	E-UTRA RRC: <i>SecurityModeComplete</i>	-	-
3C-3D	Steps 5-6 of TS 38.508-1 [4] Table 4.9.7.2.2-1 of the generic procedure are performed.	-	-	-	-
3E	The SS transmits an <i>RRCConnectionReconfiguration</i> message to establish DRB #n	<--	E-UTRA RRC: <i>RRCConnectionReconfiguration</i>	-	-
3F	The UE transmits an <i>RRCReconfigurationComplete</i> message.	-->	E-UTRA RRC: <i>RRCConnectionReconfigurationComplete</i>	-	-
3G	Void	-	-	1	-
3GA	The SS sends one IP Packet to the UE on the default DRB associated with the first PDU session.	-	-	-	-
3GB	The UE loop backs the IP packet received in step 3GA.	-	-	1	P
3H	The SS transmits an <i>RRCConnectionRelease</i>	<--	E-UTRA RRC: <i>RRCConnectionRelease</i>	-	-
4	The SS changes NR Cell 1, E-UTRA Cell 1 and E-UTRA Cell 3 level according to the row "T2" in Table 8.1.1.3.4.3.2-1/2	-	-	-	-
5	UE perform on the NR Cell 1 the mobility and periodic registration update procedure in TS 38.508-1[4] subclause 4.9.9.2.2	-	-	-	-
5AA	The SS transmits an <i>RRCReconfiguration</i> message to establish SRB2 and DRB.	<--	NR RRC: <i>RRCReconfiguration</i>	-	-
5AB	The UE transmits an <i>RRCReconfigurationComplete</i> message.	-->	NR RRC: <i>RRCReconfigurationComplete</i>	-	-
5A	Void	-	-	1	-
5B	The SS sends one IP Packet to the UE on the default DRB associated with the first PDU session.	-	-	-	-
5C	The UE loop backs the IP packet received in step 5B.	-	-	1	P
6	The SS transmits an <i>RRCRelease</i> message containing IE <i>freqPriorityListEUTRA</i> to update the cell reselection priority of E-UTRA Cell 1 and the timer T320.	<--	NR RRC: <i>RRCRelease</i>	-	-
7	The SS changes power levels of NR Cell 1, E-UTRA Cell 1 and E-UTRA Cell 3 according to row "T3" in Table 8.1.1.3.4.3.2-1/2.	-	-	-	-
8	Check: While timer T320 is running, does the UE transmit an <i>RRCSetupRequest</i> message?	-	-	2	F
9	Void	-	-	2	-
9A	Check: Does the UE transmits an <i>RRCConnectionRequest</i> message on E-UTRA cell 1?	-->	RRC: <i>RRCConnectionRequest</i>	2	P
9B	SS transmits an <i>RRCConnectionSetup</i> message on E-UTRA cell 1.	<--	RRC: <i>RRCConnectionSetup</i>	-	-
9C	Check: Does the UE transmits an <i>RRCConnectionSetupComplete</i> message to confirm the successful completion of the connection establishment and a TRACKING AREA UPDATE REQUEST message is sent to update the registration of the actual tracking area?	-->	RRC: <i>RRCConnectionSetupComplete</i> NAS: TRACKING AREA UPDATE REQUEST	2	P

10	The SS transmits a SecurityModeCommand message.	<-	E-UTRA RRC: <i>SecurityModeCommand</i>	-	-
11	The UE transmits a SecurityModeComplete message.	-->	E-UTRA RRC: <i>SecurityModeComplete</i>	-	-
12-13	Steps 5-6 of TS 38.508-1 [4] Table 4.9.7.2.2-1 of the generic procedure are performed.	-	-	-	-
14	The SS transmits an <i>RRCConnectionReconfiguration</i> message to establish DRB #n	<-	E-UTRA RRC: <i>RRCConnectionReconfiguration</i>	-	-
15	The UE transmits an <i>RRCReconfigurationComplete</i> message.	-->	E-UTRA RRC: <i>RRCConnectionReconfigurationComplete</i>	-	-
16	Void	-	-	2	-
16A	The SS sends one IP Packet to the UE on the default DRB associated with the first PDU session.	-	-	-	-
16B	The UE loop backs the IP packet received in step 16A.	-	-	2	P

8.1.1.3.4.3.3 Specific message contents

Table 8.1.1.3.4.3.3-1: RRCRelease (step 1, Table 8.1.1.3.4.3.2-3)

Derivation Path: 38.508-1 [4] Table 4.6.1-16			
Information Element	Value/remark	Comment	Condition
RRCRelease ::= SEQUENCE {			
criticalExtensions CHOICE {			
rrcRelease SEQUENCE {			
cellReselectionPriorities SEQUENCE {			
freqPriorityListEUTRA SEQUENCE (SIZE (1..maxFreq)) OF FreqPriorityEUTRA {	2 entries		
freqPriorityListEUTRA[1] SEQUENCE {		entry 1	
carrierFreq	ARFCN-ValueEUTRA for EUTRA Cell 1 frequency		
cellReselectionPriority	3		
cellReselectionSubPriority	Not present		
}			
freqPriorityListEUTRA[1] SEQUENCE {		entry 2	
carrierFreq	ARFCN-ValueEUTRA for EUTRA Cell 3 frequency		
cellReselectionPriority	5		
cellReselectionSubPriority	Not present		
}			
freqPriorityListNR SEQUENCE (SIZE (1..maxFreq)) OF FreqPriorityNR {	1 entry		
FreqPriorityNR[1] SEQUENCE {		entry 1	
carrierFreq	ARFCN-ValueNR for NR Cell 1 frequency		
cellReselectionPriority	4		
cellReselectionSubPriority	Not present		
}			
t320	Not Present		
}			
}			
}			
}			

Table 8.1.1.3.4.3.2-2: SIB5 for NR cell 1 (preamble and all steps, Table 8.1.1.3.4.3.2-3)

Derivation Path: TS 38.508-1 [4] Table 4.6.2-4			
Information Element	Value/remark	Comment	Condition
SIB5 ::= SEQUENCE {			
carrierFreqListEUTRA SEQUENCE (SIZE (1..maxEUTRA-Carrier)) OF CarrierFreqEUTRA {	2 entries		
CarrierFreqEUTRA[1] SEQUENCE {		entry 1	
carrierFreq	ARFCN-ValueEUTRA for EUTRA Cell 1 frequency		
cellReselectionPriority	5		
}			
CarrierFreqEUTRA[2] SEQUENCE {		entry 2	
carrierFreq	ARFCN-ValueEUTRA for EUTRA Cell 3 frequency		
cellReselectionPriority	3		
}			
}			
}			

Table 8.1.1.3.4.3.3-3: RRCRelease (step 6, Table 8.1.1.3.4.3.2-3)

Derivation Path: TS 38.508-1 [4], Table 4.6.1-16			
Information Element	Value/remark	Comment	Condition
RRCRelease ::= SEQUENCE {			
criticalExtensions CHOICE {			
rrcRelease SEQUENCE {			
cellReselectionPriorities SEQUENCE {			
freqPriorityListEUTRA SEQUENCE (SIZE (1..maxFreq)) OF FreqPriorityEUTRA {	1 entry		
freqPriorityListEUTRA[1] SEQUENCE {		entry 1	
carrierFreq	ARFCN-ValueEUTRA of E-UTRA Cell 1		
cellReselectionPriority	3		
cellReselectionSubPriority	Not present		
}			
freqPriorityListNR SEQUENCE (SIZE (1..maxFreq)) OF FreqPriorityNR {	1 entry		
FreqPriorityNR[1] SEQUENCE {		entry 1	
carrierFreq	ARFCN-ValueNR for NR Cell 1 frequency		
cellReselectionPriority	4		
cellReselectionSubPriority	Not present		
}			
}			
t320	min5		
}			
}			
}			

Table 8.1.1.3.4.3.3-4: RRCConnectionReconfiguration (steps 3E and 14 Table 8.1.1.3.4.3.2-3)

Derivation Path: 36.508[7] Table 4.6.1-8			
Information Element	Value/remark	Comment	Condition
RRCConnectionReconfiguration ::= SEQUENCE {			
criticalExtensions CHOICE {			
c1 CHOICE{			
rrcConnectionReconfiguration-r8 SEQUENCE {			
radioResourceConfigDedicated	RadioResourceConfigDe dicated-DRB(n, m)		
}			
}			
}			
}			

Table 8.1.1.3.4.3.3-5: RRCReconfiguration-SRB2-DRB (n, m) (step 5AA, Table 8.1.1.3.4.3.2-3)

Derivation Path: TS 38.508-1 [4] Table 4.8.1-1B

Table 8.1.1.3.4.3.3-6: REGISTRATION REQUEST (Step 5, Table 8.1.1.3.4.3.2-3)

Derivation Path: TS 38.508-1 [4], Table 4.7.1-6.			
Information Element	Value/remark	Comment	Condition
EPS NAS message container	TRACKING AREA UPDATE REQUEST message	See Table 8.1.1.3.4.3.3-7	

Table 8.1.1.3.4.3.3-7: TRACKING AREA UPDATE REQUEST (Table 8.1.1.3.4.3.3-6)

Derivation Path: TS 38.508-1 [4], Table 4.9.9.2.3-2 with condition Mapped EPS security context
--

8.1.1.3.5 Void

8.1.1.3.6 Void

8.1.1.4 RRC resume

8.1.1.4.1 RRC resume / Suspend-Resume / RNA update / Success

8.1.1.4.1.1 Test Purpose (TP)

(1)

```

with { UE in NR RRC_INACTIVE state, with stored shortI-RNTI and useFullResumeID is not signalled in
SIB1 }
ensure that {
  when { UE receives a Paging message to resume RRC connection }
  then { UE sends RRCResumeRequest message by setting resumeIdentity to the stored shortI-RNTI
value }
}

```

(2)

```

with { UE in NR RRC_INACTIVE state, with stored fullI-RNTI and useFullResumeID is signalled in SIB1
}
ensure that {
  when { UE receives a Paging message to resume RRC connection }
  then { UE sends RRCResumeRequest1 message by setting resumeIdentity to the stored fullI-RNTI
value }
}

```

(3)

```

with { UE in NR RRC_INACTIVE state }
ensure that {
  when { UE performs cell reselection and enters an RNA not belonging to the configured ran-
NotificationAreaInfo }
  then { UE shall initiate RRC connection resume procedure with cause value set to rna-Update }
}

```

8.1.1.4.1.2 Conformance requirements

References: The conformance requirements covered in the current TC is specified in: TS 38.331 clause 5.2.2.4.2, 5.3.8.3, 5.3.13.2, 5.3.13.3 and 5.3.13.8. Unless otherwise stated these are Rel-15 requirements.

[TS 38.331, clause 5.2.2.4.2]

Upon receiving the *SIB1* the UE shall:

- 1> store the acquired *SIB1*;
- 1> if the *cellAccessRelatedInfo* contains an entry with the *PLMN-Identity* of the selected PLMN:
 - 2> in the remainder of the procedures use *plmn-IdentityList*, *trackingAreaCode*, and *cellIdentity* for the cell as received in the corresponding *PLMN-IdentityInfo* containing the selected PLMN;
- ...
- 1> else:
 - ...
 - 2> if the UE supports the bandwidth of the initial uplink BWP and of the initial downlink BWPs indicated in the *locationAndBandwidth* fields in *uplinkConfigCommon*:
 - 3> select the first frequency band in the *frequencyBandList* which the UE supports and for which the UE supports at least one of the *additionalSpectrumEmission* values in *nr-NS-PmaxList*, if present;
 - 3> forward the *cellIdentity* to upper layers;
 - 3> if *trackingAreaCode* is not provided for the selected PLMN nor the registered PLMN nor PLMN of the equivalent PLMN list:
 - 4> consider the cell as barred in accordance with TS 38.304 [20];
 - 4> if *intraFreqReselection* is set to *notAllowed*:
 - 5> consider cell re-selection to other cells on the same frequency as the barred cell as not allowed, as specified in TS 38.304 [20];
 - 4> else:
 - 5> consider cell re-selection to other cells on the same frequency as the barred cell as allowed, as specified in TS 38.304 [20];
 - 3> else:
 - 4> forward the *trackingAreaCode* to upper layers;
 - 3> forward the PLMN identity to upper layers;
 - 3> if in *RRC_INACTIVE* and the forwarded information does not trigger message transmission by upper layers:
 - 4> if the serving cell does not belong to the configured *ran-NotificationAreaInfo*:
 - 5> initiate an RNA update as specified in 5.3.13.8;

[TS 38.331, clause 5.3.8.3]

The UE shall:

...

- 1> if the *RRCRelease* includes *suspendConfig*:
 - 2> apply the received *suspendConfig*;
 - 2> reset MAC and release the default MAC Cell Group configuration, if any;
 - 2> re-establish RLC entities for SRB1;
 - 2> if the *RRCRelease* message with *suspendConfig* was received in response to an *RRCResumeRequest* or an *RRCResumeRequest1*:
 - 3> stop the timer T319 if running;
 - 3> in the stored UE Inactive AS context:
 - 4> replace the K_{gNB} and K_{RRCint} keys with the current K_{gNB} and K_{RRCint} keys;
 - 4> replace the C-RNTI with the temporary C-RNTI in the cell the UE has received the *RRCRelease* message;
 - 4> replace the *cellIdentity* with the *cellIdentity* of the cell the UE has received the *RRCRelease* message;
 - 4> replace the physical cell identity with the physical cell identity of the cell the UE has received the *RRCRelease* message;
 - 4> replace the *suspendConfig* with the current *suspendConfig*;
 - 2> else:
 - 3> store in the UE Inactive AS Context the configured *suspendConfig*, the current K_{gNB} and K_{RRCint} keys, the ROHC state, the C-RNTI used in the source PCell, the *cellIdentity* and the physical cell identity of the source PCell, and all other parameters configured except with *ReconfigurationWithSync*;

...

[TS 38.331, clause 5.3.13.2]

The UE initiates the procedure when upper layers or AS (when responding to RAN paging or upon triggering RNA updates while the UE is in RRC_INACTIVE) requests the resume of a suspended RRC connection.

The UE shall ensure having valid and up to date essential system information as specified in clause 5.2.2.2 before initiating this procedure.

Upon initiation of the procedure, the UE shall:

- 1> if the resumption of the RRC connection is triggered by response to NG-RAN paging:
 - 2> select '0' as the Access Category;
 - 2> perform the unified access control procedure as specified in 5.3.14 using the selected Access Category and one or more Access Identities provided by upper layers;
 - 3> if the access attempt is barred, the procedure ends;
- 1> else if the resumption of the RRC connection is triggered by upper layers:
 - 2> if the upper layers provide an Access Category and one or more Access Identities:
 - 3> perform the unified access control procedure as specified in 5.3.14 using the Access Category and Access Identities provided by upper layers;
 - 4> if the access attempt is barred, the procedure ends;

2> set the *resumeCause* in accordance with the information received from upper layers;

1> else if the resumption of the RRC connection is triggered due to an RNA update as specified in 5.3.13.8:

2> if an emergency service is ongoing:

NOTE: How the RRC layer in the UE is aware of an ongoing emergency service is up to UE implementation.

3> select '2' as the Access Category;

3> set the *resumeCause* to *emergency*;

2> else:

3> select '8' as the Access Category;

2> perform the unified access control procedure as specified in 5.3.14 using the selected Access Category and one or more Access Identities to be applied as specified in TS 24.501 [23];

3> if the access attempt is barred:

4> set the variable *pendingRnaUpdate* to *true*;

4> the procedure ends;

...

1> release the MCG SCell(s) from the UE Inactive AS context, if stored;

1> apply the default L1 parameter values as specified in corresponding physical layer specifications, except for the parameters for which values are provided in *SIB1*;

1> apply the default SRB1 configuration as specified in 9.2.1;

1> apply the default MAC Cell Group configuration as specified in 9.2.2;

1> release *delayBudgetReportingConfig* from the UE Inactive AS context, if stored;

1> stop timer T342, if running;

1> release *overheatingAssistanceConfig* from the UE Inactive AS context, if stored;

1> stop timer T345, if running;

1> apply the CCCH configuration as specified in 9.1.1.2;

1> apply the *timeAlignmentTimerCommon* included in *SIB1*;

1> start timer T319;

1> set the variable *pendingRnaUpdate* to *false*;

1> initiate transmission of the *RRCResumeRequest* message or *RRCResumeRequest1* in accordance with 5.3.13.3.

[TS 38.331, clause 5.3.13.3]

The UE shall set the contents of *RRCResumeRequest* or *RRCResumeRequest1* message as follows:

1> if field *useFullResumeID* is signalled in *SIB1*:

2> select *RRCResumeRequest1* as the message to use;

2> set the *resumeIdentity* to the stored *fullI-RNTI* value;

1> else:

2> select *RRCResumeRequest* as the message to use;

2> set the *resumeIdentity* to the stored *shortI-RNTI* value;

...

1> submit the selected message *RRCResumeRequest* or *RRCResumeRequest1* for transmission to lower layers.

NOTE 2: Only DRBs with previously configured UP ciphering shall resume ciphering.

...

[TS 38.331, clause 5.3.13.8]

In RRC_INACTIVE state, the UE shall:

- 1> if T380 expires; or
- 1> if RNA Update is triggered at reception of SIB1, as specified in 5.2.2.4.2:
 - 2> initiate RRC connection resume procedure in 5.3.13.2 with *resumeCause* set to *rna-Update*;
- 1> if barring is alleviated for Access Category '8', as specified in 5.3.14.4:
 - 2> if upper layers do not request RRC the resumption of an RRC connection, and
 - 2> if the variable *pendingRnaUpdate* is set to *true*:
 - 3> initiate RRC connection resume procedure in 5.3.13.2 with *resumeCause* value set to *rna-Update*.

If the UE in RRC_INACTIVE state fails to find a suitable cell and camps on the acceptable cell to obtain limited service as defined in TS 38.304 [20], the UE shall:

- 1> perform the actions upon going to RRC_IDLE as specified in 5.3.11 with release cause 'other'.

NOTE: It is left to UE implementation how to behave when T380 expires while the UE is camped neither on a suitable nor on an acceptable cell.

8.1.1.4.1.3 Test Description

8.1.1.4.1.3.1 Pre-test conditions

System Simulator:

- NR Cell 1 is the serving cell and NR Cell 2 is a suitable neighbour intra-frequency cell.
- Cell power levels are selected according to 38.508-1 [4] Table 6.2.2.1-3 and NR Cell 2 is switched on after UE has registered on NR Cell 1.
- System information combination NR-2 as defined in TS 38.508-1 [4] clause 4.4.3.1.2 is used in NR cells.

UE:

- None.

Preamble:

- If *pc_IP_Ping* is set to TRUE then, the UE is in 5GS state 2N-A according to TS 38.508-1 [4], clause 4.4A.2 Table 4.4A.2-3.
- Else, the UE is in 5GS state 2N-A and Test Loop Function (*On*) with UE test loop mode B on NR Cell 1 according to 38.508-1[4], clause 4.4A.2 Table 4.4A.2-3.

8.1.1.4.1.3.2 Test procedure sequence

Table 8.1.1.4.1.3.2-1 for FR1 and table 8.1.1.4.1.3.2-2 for FR2 illustrate the downlink power levels to be applied for the cells at various time instants of the test execution. Row marked "T0" denotes the initial conditions after preamble, while columns marked "T1" is to be applied subsequently in the Main behaviour. The exact instants on which these values shall be applied are described in the texts in this clause.

Table 8.1.1.4.1.3.2-1: Cell configuration changes over time for FR1

	Parameter	Unit	NR Cell 1	NR Cell 2	Remarks
T0	SS/PBCH SSS EPRE	dBm/SCS	-88	-94	
T1	SS/PBCH SSS EPRE	dBm/SCS	"Off"	-94	Power level "Off" is defined in TS 38.508-1 [4] Table 6.2.2.1-3

Table 8.1.1.4.1.3.2-2: Cell configuration changes over time for FR2

	Parameter	Unit	NR Cell 1	NR Cell 2	Remarks
T0	SS/PBCH SSS EPRE	dBm/SCS	-82	-91	
	Qrxlevmin	dBm	- 110+Delta(NRf1)	- 110+Delta(NRf1)	
T1	SS/PBCH SSS EPRE	dBm/SCS	"Off"	-91	Power level "Off" is defined in TS 38.508-1 [4] Table 6.2.2.2-2
	Qrxlevmin	dBm	-	- 110+Delta(NRf1)	

Table 8.1.1.4.1.3.2-3: Main behaviour

St	Procedure	Message Sequence		TP	Verdict
		U - S	Message		
-	The following messages are to be observed on NR Cell 1 unless explicitly stated otherwise	-	-	-	-
1	The SS transmits a <i>Paging</i> message including a matched identity (correct <i>fullI-RNTI</i>).	<-	NR RRC: <i>Paging</i>	-	-
2	Check: Does the UE transmit an <i>RRCResumeRequest</i> message by setting <i>resumeIdentity</i> to the stored <i>shortI-RNTI</i> value?	-->	NR RRC: <i>RRCResumeRequest</i>	1	P
3	The SS transmits an <i>RRCResume</i> message.	<-	NR RRC: <i>RRCResume</i>	-	-
4	The UE transmits an <i>RRCResumeComplete</i> message.	-->	NR RRC: <i>RRCResumeComplete</i>	-	-
5	Check: Does the test result of generic test procedure in TS 38.508-1 subclause 4.9.1 indicate that the UE is capable of exchanging IP data on DRB#n associated with default Internet PDU session?	-	-	1	-
6	The SS transmits an <i>RRCRelease</i> message including both <i>fullI-RNTI</i> and <i>shortI-RNTI</i> in <i>suspendConfig</i> .	<-	NR RRC: <i>RRCRelease</i>	-	-
7	The SS changes the SIB1 of NR Cell 1 to set the <i>useFullResumeID</i> to True.	-	-	-	-
8	The SS transmits a Short message on PDCCH using P-RNTI indicating a <i>systemInfoModification</i> .	<-	PDCCH (DCI 1_0): Short Message	-	-
9	Wait for 2.1* modification period second for the UE to receive new system information. (Note 1)	-	-	-	-
10	The SS transmits a <i>Paging</i> message including a matched identity (correct <i>fullI-RNTI</i>).	<-	NR RRC: <i>Paging</i>	-	-
11	Check: Does the UE transmit an <i>RRCResumeRequest1</i> message by setting <i>resumeIdentity</i> to the stored <i>fullI-RNTI</i> value?	-->	NR RRC: <i>RRCResumeRequest1</i>	2	P
12	The SS transmits an <i>RRCResume</i> message.	<-	NR RRC: <i>RRCResume</i>	-	-
13	The UE transmits an <i>RRCResumeComplete</i> message.	-->	NR RRC: <i>RRCResumeComplete</i>	-	-
14	The SS transmits an <i>RRCRelease</i> message including both <i>fullI-RNTI</i> and <i>shortI-RNTI</i> in <i>suspendConfig</i> .	<-	NR RRC: <i>RRCRelease</i>	-	-
15	The SS adjusts cell levels according to row T1 of table 8.1.1.4.1.3.2-1 for FR1 and table 8.1.1.4.1.3.2-2 for FR2.	-	-	-	-
-	The following messages are to be observed on NR Cell 2 unless explicitly stated otherwise.	-	-	-	-
16	Check: Does the UE transmit an <i>RRCResumeRequest</i> message with <i>resumeCause</i> set to <i>ra-Update</i> on NR Cell 2 within 60s?	-->	NR RRC: <i>RRCResumeRequest</i>	3	P
17	The SS transmits an <i>RRCResume</i> message.	<-	NR RRC: <i>RRCResume</i>	-	-
18	The UE transmit an <i>RRCResumeComplete</i> message.	-->	NR RRC: <i>RRCResumeComplete</i>	-	-
19	Check: Does the test result of generic test procedure in TS 38.508-1 subclause 4.9.1 indicate that the UE is capable of exchanging IP data on DRB#n associated with default Internet PDU session?	-	-	3	-
Note 1: The modification period, expressed in number of radio frames = $\text{modificationPeriodCoeff} * \text{defaultPagingCycle}$.					

8.1.1.4.1.3.3 Specific message contents

Table 8.1.1.4.1.3.3-1: Paging (step 1, Table 8.1.1.4.1.3.2-3)

Derivation Path: TS 38.508-1 [4], Table 4.6.1-9 with condition NR_RRC_RESUME
--

Table 8.1.1.4.1.3.3-2: RRCRelease (step 6, 13, Table 8.1.1.4.1.3.2-3)

Derivation Path: TS 38.508-1 [4], Table 4.6.1-16 with condition NR_RRC_INACTIVE

Table 8.1.1.4.1.3.3-3: SIB1 (step 7, Table 8.1.1.4.1.3.2-3)

Derivation Path: TS 38.508-1 [4], Table 4.6.1-28			
Information Element	Value/remark	Comment	Condition
SIB1 ::= SEQUENCE {			
useFullResumeID	true		
}			

Table 8.1.1.4.1.3.3-4: Paging (step 10, Table 8.1.1.4.1.3.2-3)

Derivation Path: TS 38.508-1 [4], Table 4.6.1-9 with condition NR_RRC_RESUME
--

Table 8.1.1.4.1.3.3-5: RRCResumeRequest (step 16, Table 8.1.1.4.1.3.2-3)

Derivation Path: 38.508-1 [4], Table 4.6.1-19			
Information Element	Value/remark	Comment	Condition
RRCResumeRequest ::= SEQUENCE {			
rrcResumeRequest SEQUENCE {			
resumeCause	rna-Update		
}			
}			

Table 8.1.1.4.1.3.3-6: RRCResume (step 3, 12, Table 8.1.1.4.1.3.2-3)

Derivation Path: TS 38.508-1 [4], Table 4.6.1-17
--

Table 8.1.1.4.1.3.3-7: Void**Table 8.1.1.4.1.3.3-8: RRCResume (step 17, Table 8.1.1.4.1.3.2-3)**

Derivation Path: TS 38.508-1 [4], Table 4.6.1-17			
Information Element	Value/remark	Comment	Condition
RRCResume ::= SEQUENCE {			
criticalExtensions CHOICE {			
rrcResume SEQUENCE {			
masterCellGroup ::= SEQUENCE {	CellGroupConfig	Table 8.1.1.4.1.3.3-10	
}			
}			
}			

Table 8.1.1.4.1.3.3-9: Void

Table 8.1.1.4.1.3.3-10: CellGroupConfig (Table 8.1.1.4.1.3.3-8)

Derivation Path: 38.508-1 [4], Table 4.6.3-19 with condition RESUME			
Information Element	Value/remark	Comment	Condition
CellGroupConfig ::= SEQUENCE {			
spCellConfigDedicated	ServingCellConfig		
}			

Table 8.1.1.4.1.3.3-11: ServingCellConfig (Table 8.1.1.4.1.3.3-10: CellGroupConfig)

Derivation Path: TS 38.508-1 [4], Table 4.6.3-167 with condition RESUME			
Information Element	Value/remark	Comment	Condition
ServingCellConfig ::= SEQUENCE {			
initialDownlinkBWP	BWP-DownlinkDedicated		
}			

Table 8.1.1.4.1.3.3-12: BWP-DownlinkDedicated (Table 8.1.1.4.1.3.3-11: ServingCellConfig)

Derivation Path: TS 38.508-1 [4], Table 4.6.3-11			
Information Element	Value/remark	Comment	Condition
BWP-DownlinkDedicated ::= SEQUENCE {			
pdch-Config	Not present		
pdsch-Config CHOICE {			
setup	PDSCH-Config		
}			
}			

Table 8.1.1.4.1.3.3-13: PDSCH-Config (Table 8.1.1.4.1.3.3-12: BWP-DownlinkDedicated)

Derivation Path: TS 38.508-1 [4], Table 4.6.3-100			
Information Element	Value/remark	Comment	Condition
PDSCH-Config ::= SEQUENCE {			
dmrs-DownlinkForPDSCH-MappingTypeA	Not present		
tci-StatesToAddModList SEQUENCE(SIZE (1.. maxNrofTCI-States)) OF TCI-State {	1 entry		
TCI-State[1] SEQUENCE {		entry 1	
tci-StateId	0		
qcl-type1 SEQUENCE {			
referenceSignal CHOICE {			
ssb	SSB index #n	SSB index of NR Cell 2	
}			
}			
}			
}			

8.1.1.4.2 RRC resume / Suspend-Resume / RRC setup / T319 expiry

8.1.1.4.2.1 Test Purpose (TP)

(1)

```

with { UE in NR RRC_INACTIVE state and sends RRCResumeRequest message to resume RRC Connection }
ensure that {
  when { UE receives a RRCSetup message }
  then { UE shall discards any stored UE Inactive AS context, suspendConfig and send
RRCSetupComplete message with ng-5G-S-TMSI-Value set to ng-5G-S-TMSI }
}

```

(2)

```

with { UE in NR RRC_INACTIVE state and sends RRCResumeRequest message to resume RRC Connection }
ensure that {
  when { T319 expires }
  then { UE shall release RRC connection with release cause RRC Resume failure and go to NR
RRC_IDLE state }
}

```

8.1.1.4.2.2 Conformance requirements

References: The conformance requirements covered in the present TC are specified in: TS 38.331, clauses 5.3.3.4, 5.3.11, 5.3.13.5 and 5.3.13.7 and TS 24.501 clause 5.3.1.4. Unless otherwise stated these are Rel-15 requirements.

[TS 38.331, clause 5.3.3.4]

The UE shall perform the following actions upon reception of the *RRCSetup*:

...

- 1> if the *RRCSetup* is received in response to an *RRCResumeRequest* or *RRCResumeRequest1*:
 - 2> discard any stored UE Inactive AS context and *suspendConfig*;
 - 2> discard any current AS security context including the K_{RRCEnc} key, the K_{RRCint} key, the K_{UPint} key and the K_{UPenc} key;
 - 2> release radio resources for all established RBs except SRB0, including release of the RLC entities, of the associated PDCP entities and of SDAP;
 - 2> release the RRC configuration except for the default MAC Cell Group configuration and CCCH configuration;
 - 2> indicate to upper layers fallback of the RRC connection;
 - 2> stop timer T380, if running;
- 1> perform the cell group configuration procedure in accordance with the received *masterCellGroup* and as specified in 5.3.5.5;
- 1> perform the radio bearer configuration procedure in accordance with the received *radioBearerConfig* and as specified in 5.3.5.6;
- 1> if stored, discard the cell reselection priority information provided by the *cellReselectionPriorities* or inherited from another RAT;
- 1> stop timer T300, T301 or T319 if running;
- 1> if T390 is running:
 - 2> stop timer T390 for all access categories;
 - 2> perform the actions as specified in 5.3.14.4.
- 1> stop timer T302, if running;
- 1> stop timer T320, if running;
- 1> if the *RRCSetup* is received in response to an *RRCResumeRequest*, *RRCResumeRequest1* or *RRCSetupRequest*:
 - 2> enter RRC_CONNECTED;
 - 2> stop the cell re-selection procedure;
- 1> consider the current cell to be the PCell;
- 1> set the content of *RRCSetupComplete* message as follows:

- 2> if upper layers provide an *5G-S-TMSI*:
 - 3> if the *RRCSetup* is received in response to an *RRCSetupRequest*:
 - 4> set the *ng-5G-S-TMSI-Value* to *ng-5G-S-TMSI-Part2*;
 - 3> else:
 - 4> set the *ng-5G-S-TMSI-Value* to *ng-5G-S-TMSI*;
- 2> set the *selectedPLMN-Identity* to the PLMN selected by upper layers (TS 24.501 [23]) from the PLMN(s) included in the *plmn-IdentityList* in *SIB1*;
- 2> if upper layers provide the 'Registered AMF':
 - 3> include and set the *registeredAMF* as follows:
 - 4> if the PLMN identity of the 'Registered AMF' is different from the PLMN selected by the upper layers:
 - 5> include the *plmnIdentity* in the *registeredAMF* and set it to the value of the PLMN identity in the 'Registered AMF' received from upper layers;
 - 4> set the *amf-Identifier* to the value received from upper layers;
 - 3> include and set the *guami-Type* to the value provided by the upper layers;
- 2> if upper layers provide one or more S-NSSAI (see TS 23.003 [21]):
 - 3> include the *s-nssai-List* and set the content to the values provided by the upper layers;
- 2> set the *dedicatedNAS-Message* to include the information received from upper layers;
- 1> submit the *RRCSetupComplete* message to lower layers for transmission, upon which the procedure ends

[TS 38.331, clause 5.3.11]

UE shall:

- 1> reset MAC;
- 1> if T302 is running:
 - 2> stop timer T302;
 - 2> perform the actions as specified in 5.3.14.4;
- 1> stop all timers that are running except T320 and T325;
- 1> discard the UE Inactive AS context;
- 1> set the variable *pendingRnaUpdate* to *false*, if that is set to *true*;
- 1> discard the K_{gNB} , the K_{RRCenc} key, the K_{RRCint} , the K_{UPint} key and the K_{UPenc} key, if any;
- 1> release all radio resources, including release of the RLC entity, the MAC configuration and the associated PDCP entity and SDAP for all established RBs;
- 1> indicate the release of the RRC connection to upper layers together with the release cause;
- 1> enter RRC_IDLE and perform cell selection as specified in TS 38.304 [20], except if going to RRC_IDLE was triggered by selecting an inter-RAT cell while T311 was running;

[TS 38.331, clause 5.3.13.5]

The UE shall:

- 1> if timer T319 expires or upon receiving Integrity check failure indication from lower layers while T319 is running:
- 2> perform the actions upon going to RRC_IDLE as specified in 5.3.11 with release cause 'RRC Resume failure'.

[TS 38.331, clause 5.3.13.7]

The UE shall:

- 1> perform the RRC connection setup procedure as specified in 5.3.3.4.

[TS 24.501, clause 5.3.1.4]

...

If the UE in 5GMM-CONNECTED mode with RRC inactive indication receives an indication from the lower layers that the resumption of the RRC connection has failed, and:

- a) if the lower layers indicate that access barring is applicable for all access categories except categories 0 and 2, the UE shall:
 - 1) stay in 5GMM-CONNECTED mode with RRC inactive indication;
- b) else, the UE shall:
 - 1) enter 5GMM-IDLE mode; and
 - 2) initiate the registration procedure for mobility and periodic registration update used for mobility (i.e. the 5GS registration type IE set to "mobility registration updating" in the REGISTRATION REQUEST message) for N1 NAS signalling connection recovery as specified in subclause 5.5.1.3.2.

NOTE 2: An indication from the lower layer that the RRC connection has been released with cause "RRC resume failure" can be considered as an indication that the resumption of the RRC connection has failed.

8.1.1.4.2.3 Test description

8.1.1.4.2.3.1 Pre-test conditions

System Simulator:

- NR Cell 1 is the serving cell.
- System information combination NR-1 as defined in TS 38.508-1 [4] clause 4.4.3.1.2 is used in NR cell.

UE:

- None.

Preamble:

- The UE is in state 2N-A as defined in TS 38.508-1 [4], Table 4.4A.2-2 on NR Cell 1.

8.1.1.4.2.3.2 Test procedure sequence

Table 8.1.1.4.2.3.2-1: Main behaviour

St	Procedure	Message Sequence		TP	Verdict
		U - S	Message		
1	The SS transmits a <i>Paging</i> message including a matched identity (correct <i>fullI-RNTI</i>).	<--	NR RRC: <i>Paging</i>	-	-
2	The UE transmit an <i>RRCResumeRequest</i> message to resume RRC Connection by setting <i>resumIdentity</i> to the stored <i>shortI-RNTI</i> value?	-->	NR RRC: <i>RRCResumeRequest</i>	-	-
3	The SS transmits an <i>RRCSetup</i> message in response to <i>RRCResumeRequest</i> message.	<--	NR RRC: <i>RRCSetup</i>	-	-
4	Check: Does the UE transmits an <i>RRCSetupComplete</i> message and a REGISTRATION REQUEST message by discarding any stored UE Inactive AS context and suspendConfig, setting the <i>ng-5G-S-TMSI-Value</i> to <i>ng-5G-S-TMSI</i> ?	-->	NR RRC: <i>RRCSetupComplete</i> 5GMM: REGISTRATION REQUEST	1	P
4A-4B	Steps 4-5 as defined in TS 38.508-1 [4] Table 4.9.5.2.2-1.	-	-	-	-
4C-4F	Steps 5-8 as defined in TS 38.508-1 [4] Table 4.5.4.2-3.	-	-	-	-
5	The SS transmits an <i>RRCRelease</i> message including both <i>fullI-RNTI</i> and <i>shortI-RNTI</i> in <i>suspendConfig</i> .	<--	NR RRC: <i>RRCRelease</i>	-	-
6	The SS transmits a <i>Paging</i> message including a matched identities (correct <i>fullI-RNTI</i>).	<--	NR RRC: <i>Paging</i>	-	-
7	The UE transmits an <i>RRCResumeRequest</i> message to resume RRC Connection by setting <i>resumIdentity</i> to the stored <i>shortI-RNTI</i> value?	-->	NR RRC: <i>RRCResumeRequest</i>	-	-
8	The SS waits for T319 expiry.	-	-	-	-
9	Check: Does the test result of test procedure in TS 38.508-1 [4] subclause 4.9.5 indicate that the UE has performed mobility registration on NR cell 1 started in NR RRC_IDLE?	-	-	2	-

8.1.1.4.2.3.3 Specific message contents

Table 8.1.1.4.2.3.3-1: *RRCRelease* (preamble and step 5 in Table 8.1.1.4.2.3.2-1)

Derivation Path: 38.508-1 [4], Table 4.6.1-16			
Information Element	Value/remark	Comment	Condition
<i>RRCRelease</i> ::= SEQUENCE {			
<i>criticalExtensions</i> CHOICE {			
<i>rrcRelease</i> SEQUENCE {			
<i>suspendConfig</i> SEQUENCE {			NR_RRC_I NACTIVE
<i>fullI-RNTI</i>	I-RNTI-Value		
<i>shortI-RNTI</i>	ShortI-RNTI-Value		
}			
}			
}			
}			

Table 8.1.1.4.2.3.3-1a: *Void*

Table 8.1.1.4.2.3.3-2: RRCResumeRequest (step 2 and 7 Table 8.1.1.4.2.3.2-1)

Derivation Path: 38.508-1 [4], Table 4.6.1-19			
Information Element	Value/remark	Comment	Condition
RRCResumeRequest ::= SEQUENCE {			
rrcResumeRequest SEQUENCE {			
resumeCause	mt-Access		
}			
}			

Table 8.1.1.4.2.3.3-3: RRCSetupComplete (step 4 in Table 8.1.1.4.2.3.2-1)

Derivation Path: 38.508-1 [4], Table 4.6.1-22			
Information Element	Value/remark	Comment	Condition
RRCSetupComplete ::= SEQUENCE {			
criticalExtensions CHOICE {			
rrcSetupComplete SEQUENCE {			
ng-5G-S-TMSI-Value	ng-5G-S-TMSI		
}			
}			
}			

Table 8.1.1.4.2.3.3-4: REGISTRATION REQUEST (step 4 in Table 8.1.1.4.2.3.2-1)

Derivation Path: 38.508-1 [4], Table 4.7.1-6			
Information Element	Value/remark	Comment	Condition
5GS registration type			
5GS registration type value	'010'B	Mobility registration updating	
Uplink data status	Present but contents not checked		

Table 8.1.1.4.2.3.3-5: RRCReconfiguration (step 4E in Table 8.1.1.4.2.3.2-1)

Derivation Path: 38.508-1 [4], Table 4.6.1-13 condition NR and SRB2			
Information Element	Value/remark	Comment	Condition
RRCReconfiguration ::= SEQUENCE {			
dedicatedNAS-MessageList	Not present		
}			

8.1.1.4.3 Void

8.1.2 RRC reconfiguration

8.1.2.1 Radio bearer establishment / reconfiguration / release

8.1.2.1.1 RRC reconfiguration / DRB / SRB / Establishment / Modification / Release / Success

8.1.2.1.1.1 Test Purpose (TP)

(1)

```
with { UE having completed the RRC connection establishment procedure}
ensure that {
  when { SS sends in sequence a SecurityModeCommand and an RRCReconfiguration message to establish a
DRB }

```

```

    then { UE establishes the initial security configuration in accordance with the received
securityConfigSMC included in SecurityModeCommand and successfully completes the reconfiguration }
}

```

(2)

```

with { UE in NR RRC_CONNECTED state without SRB2 }
ensure that {
  when { SS sends an RRCReconfiguration message including SRB2 configuration }
  then { UE successfully establish the signalling radio bearer }
}

```

(3)

```

with { UE in NR RRC_CONNECTED state }
ensure that {
  when { UE receives an RRCReconfiguration message to reconfigure the current UE configuration of
SRB and DRB }
  then { UE reconfigures the data and signalling radio bearers and sends an
RRCReconfigurationComplete message }
}

```

(4)

```

with { UE in NR RRC_CONNECTED state }
ensure that {
  when { UE receives an RRCReconfiguration message including a drb-ToReleaseList }
  then { for each drb-Identity release the PDCP entity and RLC entity and logical channel and
indicate release of the DRB(s) to upper layers }
}

```

8.1.2.1.1.2 Conformance requirements

References: The conformance requirements covered in the present TC are specified in: TS 38.331, clauses 5.3.4.3, 5.3.5.6.3, 5.3.5.6.4, and 5.3.5.6.5. Unless otherwise stated these are Rel-15 requirements.

[TS 38.331, clause 5.3.4.3]

The UE shall:

- 1> derive the K_{gNB} key, as specified in TS 33.501 [11];
- 1> derive the K_{RRCint} key associated with the *integrityProtAlgorithm* indicated in the *SecurityModeCommand* message, as specified in TS 33.501 [11];
- 1> request lower layers to verify the integrity protection of the *SecurityModeCommand* message, using the algorithm indicated by the *integrityProtAlgorithm* as included in the *SecurityModeCommand* message and the K_{RRCint} key;
- 1> if the *SecurityModeCommand* message passes the integrity protection check:
 - 2> derive the K_{RRCenc} key and the K_{UPenc} key associated with the *cipheringAlgorithm* indicated in the *SecurityModeCommand* message, as specified in TS 33.501 [11];
 - 2> derive the K_{UPint} key associated with the *integrityProtAlgorithm* indicated in the *SecurityModeCommand* message, as specified in TS 33.501 [11];
 - 2> configure lower layers to apply SRB integrity protection using the indicated algorithm and the K_{RRCint} key immediately, i.e. integrity protection shall be applied to all subsequent messages received and sent by the UE, including the *SecurityModeComplete* message;

[TS 38.331, clause 5.3.5.6.3]

The UE shall:

- 1> for each *srb-Identity* value included in the *srb-ToAddModList* that is not part of the current UE configuration (SRB establishment or reconfiguration from E-UTRA PDCP to NR PDCP):
 - 2> establish a PDCP entity;

- 2> if AS security has been activated:
 - 3> if target RAT of handover is E-UTRA/5GC, or;
 - 3> if the UE is only connected to E-UTRA/5GC:
 - 4> configure the PDCP entity with the security algorithms and keys (K_{RRCEnc} and K_{RRCint}) configured/derived as specified in TS 36.331 [10];
 - 3> else:
 - 4> configure the PDCP entity with the security algorithms according to *securityConfig* and apply the keys (K_{RRCEnc} and K_{RRCint}) associated with the master key (K_{eNB}/K_{gNB}) or secondary key ($S-K_{gNB}$) as indicated in *keyToUse*, if applicable;
- 2> if the current UE configuration as configured by E-UTRA in TS 36.331 [10] includes an SRB identified with the same *srb-Identity* value:
 - 3> associate the E-UTRA RLC entity and DCCH of this SRB with the NR PDCP entity;
 - 3> release the E-UTRA PDCP entity of this SRB;
- 2> if the *pdc-Config* is included:
 - 3> configure the PDCP entity in accordance with the received *pdc-Config*;
- 2> else:
 - 3> configure the PDCP entity in accordance with the default configuration defined in 9.2.1 for the corresponding SRB;
- 1> for each *srb-Identity* value included in the *srb-ToAddModList* that is part of the current UE configuration:
 - 2> if the *reestablishPDCP* is set:
 - 3> if target RAT of handover is E-UTRA/5GC, or;
 - 3> if the UE is only connected to E-UTRA/5GC:
 - 4> configure the PDCP entity to apply the integrity protection algorithm and K_{RRCint} key configured/derived as specified in TS 36.331 [10], i.e. the integrity protection configuration shall be applied to all subsequent messages received and sent by the UE, including the message used to indicate the successful completion of the procedure;
 - 4> configure the PDCP entity to apply the ciphering algorithm and K_{RRCEnc} key configured/derived as specified in TS 36.331 [10], i.e. the ciphering configuration shall be applied to all subsequent messages received and sent by the UE, including the message used to indicate the successful completion of the procedure;
 - 3> else:
 - 4> configure the PDCP entity to apply the integrity protection algorithm and K_{RRCint} key associated with the master key (K_{eNB}/K_{gNB}) or secondary key ($S-K_{gNB}$), as indicated in *keyToUse*, i.e. the integrity protection configuration shall be applied to all subsequent messages received and sent by the UE, including the message used to indicate the successful completion of the procedure;
 - 4> configure the PDCP entity to apply the ciphering algorithm and K_{RRCEnc} key associated with the master key (K_{eNB}/K_{gNB}) or secondary key ($S-K_{gNB}$) as indicated in *keyToUse*, i.e. the ciphering configuration shall be applied to all subsequent messages received and sent by the UE, including the message used to indicate the successful completion of the procedure;
 - 4> re-establish the PDCP entity of this SRB as specified in TS 38.323 [5];
 - 2> else, if the *discardOnPDCP* is set:
 - 3> trigger the PDCP entity to perform SDU discard as specified in TS 38.323 [5];

2> if the *pdcp-Config* is included:

3> reconfigure the PDCP entity in accordance with the received *pdcp-Config*.

[TS 38.331, clause 5.3.5.6.4]

The UE shall:

1> for each *drb-Identity* value included in the *drb-ToReleaseList* that is part of the current UE configuration; or

1> for each *drb-Identity* value that is to be released as the result of full configuration according to 5.3.5.11:

2> release the PDCP entity and the *drb-Identity*;

2> if SDAP entity associated with this DRB is configured:

3> indicate the release of the DRB to SDAP entity associated with this DRB (TS 37.324 [24], clause 5.3.3);

2> if the UE is operating in EN-DC:

3> if a new bearer is not added either with NR or E-UTRA with same *eps-BearerIdentity*:

4> indicate the release of the DRB and the *eps-BearerIdentity* of the released DRB to upper layers.

NOTE 1: The UE does not consider the message as erroneous if the *drb-ToReleaseList* includes any *drb-Identity* value that is not part of the current UE configuration.

NOTE 2: Whether or not the RLC and MAC entities associated with this PDCP entity are reset or released is determined by the *CellGroupConfig*.

[TS 38.331, clause 5.3.5.6.5]

The UE shall:

1> for each *drb-Identity* value included in the *drb-ToAddModList* that is not part of the current UE configuration (DRB establishment including the case when full configuration option is used):

2> establish a PDCP entity and configure it in accordance with the received *pdcp-Config*;

2> if the PDCP entity of this DRB is not configured with *cipheringDisabled*:

3> if target RAT of handover is E-UTRA/5GC, or;

3> if the UE is only connected to E-UTRA/5GC:

4> configure the PDCP entity with the ciphering algorithm and K_{UPenc} key configured/derived as specified in TS 36.331 [10];

3> else:

4> configure the PDCP entity with the ciphering algorithms according to *securityConfig* and apply the K_{UPenc} key associated with the master key (K_{eNB}/K_{gNB}) or the secondary key ($S-K_{gNB}$) as indicated in *keyToUse*;

2> if the PDCP entity of this DRB is configured with *integrityProtection*:

3> configure the PDCP entity with the integrity algorithms according to *securityConfig* and apply the K_{UPint} key associated with the master (K_{eNB}/K_{gNB}) or the secondary key ($S-K_{gNB}$) as indicated in *keyToUse*;

2> if an *sdap-Config* is included:

3> if an SDAP entity with the received *pdu-Session* does not exist:

4> establish an SDAP entity as specified in TS 37.324 [24] clause 5.1.1;

4> If an SDAP entity with the received *pdu-Session* did not exist prior to receiving this reconfiguration:

5> indicate the establishment of the user plane resources for the *pdu-Session* to upper layers;

- 3> configure the SDAP entity in accordance with the received *sdap-Config* as specified in TS 37.324 [24] and associate the DRB with the SDAP entity;
- 2> if the UE is operating in EN-DC:
 - 3> if the DRB was configured with the same *eps-BearerIdentity* either by NR or E-UTRA prior to receiving this reconfiguration:
 - 4> associate the established DRB with the corresponding *eps-BearerIdentity*;
 - 3> else:
 - 4> indicate the establishment of the DRB(s) and the *eps-BearerIdentity* of the established DRB(s) to upper layers;

8.1.2.1.1.3 Test description

8.1.2.1.1.3.1 Pre-test conditions

System Simulator:

- NR Cell 1

UE:

- None

Preamble:

- If *pc_IP_Ping* is set to TRUE then the UE is in 5GS state 1N-A, PDU SESSION ACTIVE according to TS 38.508-1 [4], clause 4.4A.2 Table 4.4A.2-1
- Else, the UE is in 5GS state 1N-A and Test Loop Function (*On*) with UE test loop mode B on NR Cell 1 according to 38.508-1[4], clause 4.4A.2 Table 4.4A.2-3.

8.1.2.1.1.3.2 Test procedure sequence

Table 8.1.2.1.1.3.2-1: Main behaviour

St	Procedure	Message Sequence		TP	Verdict
		U - S	Message		
1	SS transmits a <i>Paging</i> message to the UE on the appropriate paging block, and including the UE identity in one entry of the IE <i>pagingRecordList</i> .	<--	NR RRC: <i>Paging</i>	-	-
2	UE transmits an <i>RRCSetupRequest</i> message.	-->	NR RRC: <i>RRCSetupRequest</i>	-	-
3	SS transmit an <i>RRCSetup</i> message	<--	NR RRC: <i>RRCSetup</i>	-	-
4	The UE transmits an <i>RRCSetupComplete</i> to confirm the successful completion of the connection establishment.	-->	NR RRC: <i>RRCSetupComplete</i>	-	-
5	SS transmits a <i>SecurityModeCommand</i> message to activate AS security.	<--	NR RRC: <i>SecurityModeCommand</i>	-	-
6	Using the same slot as the <i>SecurityModeCommand</i> message in step 5, the SS transmits an <i>RRCReconfiguration</i> message to establish a data radio bearer, DRB1.	<--	NR RRC: <i>RRCReconfiguration</i>	-	-
7	Check: Does the UE transmit a <i>SecurityModeComplete</i> message?	-->	NR RRC: <i>SecurityModeComplete</i>	1	P
8	Check: Does the UE transmit an <i>RRCReconfigurationComplete</i> message to confirm the establishment of data radio bearer, DRB1?	-->	NR RRC: <i>RRCReconfigurationComplete</i>	1	P
9	SS transmits an <i>RRCReconfiguration</i> message to establish SRB2.	<--	NR RRC: <i>RRCReconfiguration</i>	-	-
10	Check: Does the UE transmit an <i>RRCReconfigurationComplete</i> message to confirm the establishment of signalling radio bearer, SRB2?	-->	NR RRC: <i>RRCReconfigurationComplete</i>	2	P
11	The SS transmits an <i>RRCReconfiguration</i> message to modify SRB and DRB configuration.	<--	NR RRC: <i>RRCReconfiguration</i>	-	-
12	Check: Does the UE transmit an <i>RRCReconfigurationComplete</i> message?	-->	NR RRC: <i>RRCReconfigurationComplete</i>	3	P
12A	Check: Does the test result of generic test procedure in TS 38.508-1 subclause 4.9.1 indicate that the UE is capable of exchanging IP data on DRB#1 established in Step 11?	-	-	3	-
13	The SS transmits an <i>RRCReconfiguration</i> message with a <i>drb-ToReleaseList</i> and PDU SESSION RELEASE COMMAND	<--	NR RRC: <i>RRCReconfiguration</i> 5GMM: DL NAS TRANSPORT 5GSM: PDU SESSION RELEASE COMMAND	-	-
14	Check: Does the UE transmit an <i>RRCReconfigurationComplete</i> message?	-->	NR RRC: <i>RRCReconfigurationComplete</i>	4	P
16	The UE transmits an <i>ULInformationTransfer</i> message and a UL NAS TRASPORT containing PDU SESSION RELEASE COMPLETE.	-->	NR RRC: <i>ULInformationTransfer</i> 5GMM: UL NAS TRANSPORT 5GSM: PDU SESSION RELEASE COMPLETE	-	-

8.1.2.1.1.3.3 Specific message contents

Table 8.1.2.1.1.3.3-1: RRCReconfiguration (Step 6, Table 8.1.2.1.1.3.2-1)

Derivation Path: TS 38.508-1, table 4.6.1-13			
Information Element	Value/remark	Comment	Condition
RRCReconfiguration ::= SEQUENCE {			
criticalExtensions CHOICE {			
rrcReconfiguration SEQUENCE {			
radioBearerConfig	RadioBearerConfig with condition DRB1		
nonCriticalExtension SEQUENCE {			
masterCellGroup	CellGroupConfig	OCTET STRING (CONTAINING CellGroupConfig)	
}			
}			
}			

Table 8.1.2.1.1.3.3-1A: CellGroupConfig (Table 8.1.2.1.1.3.3-1)

Derivation Path: TS 38.508-1, table 4.6.3-19			
Information Element	Value/remark	Comment	Condition
CellGroupConfig ::= SEQUENCE {			
rlc-BearerToAddModList SEQUENCE (SIZE(1..maxLC-ID)) OF RLC-BearerConfig {	1 entry		
RLC-Bearer-Config[1] SEQUENCE {		entry 1	
logicalChannelIdentity	LogicalChannelIdentity		
servedRadioBearer CHOICE {			
drb-Identity	DRB-Identity with condition DRB1		
}			
reestablishRLC	Not present		
RLC-Config	Not present		
mac-LogicalChannelConfig	Not present		
}			
}			
mac-CellGroupConfig	Not present		
physicalCellGroupConfig	Not present		
spCellConfig SEQUENCE	Not present		
}			

Table 8.1.2.1.1.3.3-2: RRCReconfiguration (Step 9, Table 8.1.2.1.1.3.2-1)

Derivation Path: TS 38.508-1, table 4.6.1-13			
Information Element	Value/remark	Comment	Condition
RRCReconfiguration ::= SEQUENCE {			
criticalExtensions CHOICE {			
rrcReconfiguration SEQUENCE {			
radioBearerConfig	RadioBearerConfig with condition SRB2		
nonCriticalExtension SEQUENCE {			
masterCellGroup	CellGroupConfig	OCTET STRING (CONTAINING CellGroupConfig)	
}			
}			
}			

Table 8.1.2.1.1.3.3-2A: CellGroupConfig (Table 8.1.2.1.1.3.3-2)

Derivation Path: TS 38.508-1, table 4.6.3-19			
Information Element	Value/remark	Comment	Condition
CellGroupConfig ::= SEQUENCE {			
rlc-BearerToAddModList SEQUENCE (SIZE(1..maxLC-ID)) OF RLC-BearerConfig {	1 entry		
RLC-Bearer-Config[1] SEQUENCE {		entry 1	
logicalChannelIdentity	LogicalChannelIdentity		
servedRadioBearer CHOICE {			
srb-Identity	SRB-Identity with condition SRB2		
}			
reestablishRLC	Not present		
RLC-Config	Not present		
mac-LogicalChannelConfig	Not present		
}			
}			
mac-CellGroupConfig	Not present		
physicalCellGroupConfig	Not present		
spCellConfig SEQUENCE	Not present		
}			

Table 8.1.2.1.1.3.3-3: RRCReconfiguration (Step 11, Table 8.1.2.1.1.3.2-1)

Derivation Path: TS 38.508-1, table 4.6.1-13			
Information Element	Value/remark	Comment	Condition
RRCReconfiguration ::= SEQUENCE {			
criticalExtensions CHOICE {			
rrcReconfiguration SEQUENCE {			
nonCriticalExtension SEQUENCE {			
masterCellGroup	CellGroupConfig	OCTET STRING (CONTAINING CellGroupConfig)	
}			
}			
}			
}			

Table 8.1.2.1.1.3.3-4: CellGroupConfig (Table 8.1.2.1.1.3.2-3)

Derivation Path: TS 38.508-1, table 4.6.1-13			
Information Element	Value/remark	Comment	Condition
CellGroupConfig ::= SEQUENCE {			
rlc-BearerToAddModList SEQUENCE (SIZE(1..maxLC-ID)) OF RLC-BearerConfig {	2 entries		
RLC-Bearer-Config[1] SEQUENCE {		entry 1	
logicalChannelIdentity	LogicalChannelIdentity		
servedRadioBearer CHOICE {			
srb-Identity	SRB-Identity with condition SRB2		
}			
reestablishRLC	true		
RLC-Config	Not present		
mac-LogicalChannelConfig	Not present		
}			
RLC-Bearer-Config[2] SEQUENCE {		entry 2	
logicalChannelIdentity	LogicalChannelIdentity		
servedRadioBearer CHOICE {			
drb-Identity	DRB-Identity with condition DRB1		
}			
reestablishRLC	true		
RLC-Config	Not present		
mac-LogicalChannelConfig	Not present		
}			
mac-CellGroupConfig	Not present		
physicalCellGroupConfig	Not present		
spCellConfig SEQUENCE	Not present		
}			

Table 8.1.2.1.1.3.3-5: RRCReconfiguration (Step 13, Table 8.1.2.1.1.3.2-1)

Derivation Path: TS 38.508-1, table 4.6.1-3			
Information Element	Value/remark	Comment	Condition
RRCReconfiguration ::= SEQUENCE {			
criticalExtensions CHOICE {			
rrcReconfiguration SEQUENCE {			
radioBearerConfig	RadioBearerConfig		
nonCriticalExtension SEQUENCE {			
masterCellGroup	CellGroupConfig	OCTET STRING (CONTAINING CellGroupConfig)	
}			
}			
}			

Table 8.1.2.1.1.3.3-6: RadioBearerConfig (Table 8.1.2.1.1.3.3-5)

Derivation Path: 38.508-1 [4], Table 4.6.3-132			
Information Element	Value/remark	Comment	Condition
RadioBearerConfig ::= SEQUENCE {			
drb-ToReleaseList	1	DRB1	
}			

Table 8.2.1.1.1.3.3-7: *CellGroupConfig* (Table 8.2.1.1.1.3.3-5)

Derivation Path: 38.508-1 [4], Table 4.6.3-19			
Information Element	Value/remark	Comment	Condition
CellGroupConfig ::= SEQUENCE {			
cellGroupId	1		
rlc-BearerToAddModList	Not Present		
rlc-BearerToReleaseList SEQUENCE (SIZE(1..maxLC-ID)) OF LogicalChannelIdentity {	1 entry		
logicalChannelIdentity[1]	LogicalChannelIdentit y	entry 1	
}			
mac-CellGroupConfig	Not Present		
tag-Config	Not Present		
phr-Config	Not Present		
physicalCellGroupConfig	Not Present		
rlf-TimersAndConstants	Not Present		
}			

8.1.2.1.2 RRC reconfiguration / RRC bearer establishment / uplinkTxDirectCurrentList

8.1.2.1.2.1 Test Purpose (TP)

(1)

```

with { UE in NR RRC_CONNECTED state }
ensure that {
  when { UE receives a RRCReconfiguration message containing reportUplinkTxDirectCurrent }
  then { UE will include the uplinkTxDirectCurrentList in RRCReconfigurationComplete message. }
}

```

8.1.2.1.2.2 Conformance requirements

References: The conformance requirements covered in the current TC are specified in: TS 38.331 clauses 5.3.5.3. Unless otherwise stated these are Rel-15 requirements.

[TS 38.331, clause 5.3.5.3]

The UE shall perform the following actions upon reception of the *RRCReconfiguration*:

...

1> set the content of *RRCReconfigurationComplete* message as follows:

2> if the *RRCReconfiguration* includes the *masterCellGroup* containing the *reportUplinkTxDirectCurrent*, or;

2> if the *RRCReconfiguration* includes the *secondaryCellGroup* containing the *reportUplinkTxDirectCurrent*:

3> include the *uplinkTxDirectCurrentList*;

8.1.2.1.2.3 Test description

8.1.2.1.2.3.1 Pre-test conditions

System Simulator:

- NR Cell 1.
- System information combination NR-1 as defined in TS 38.508-1 [4] clause 4.4.3.1 is used in NR cell.

UE:

- None.

Preamble:

- The UE is in state 3N-A according to TS 38.508-1 [4], clause 4.4A.2 Table 4.4A.2-3.

8.1.2.1.2.3.2 Test procedure sequence

Table 8.1.2.1.2.3.2-1: Main behaviour

St	Procedure	Message Sequence		TP	Verdict
		U - S	Message		
1	The SS transmits a <i>RRCReconfiguration</i> message containing uplinkBWP-ToAddModList IE to add BWP#1 and including reportUplinkTxDirectCurrent IE.	<--	NR RRC: RRCReconfiguration	-	-
2	Check: Does the UE transmit the <i>RRCReconfigurationComplete</i> message including the uplinkTxDirectCurrentList?	-->	NR RRC: RRCReconfigurationComplete	1	P

8.1.2.1.2.3.3 Specific message contents

Table 8.1.2.1.2.3.3-1: *RRCReconfiguration* (step 1, Table 8.1.2.1.2.3.2-1)

Derivation Path: 38.508-1 [4], Table 4.6.1-13			
Information Element	Value/remark	Comment	Condition
RRCReconfiguration ::= SEQUENCE {			
criticalExtensions CHOICE {			
rrcReconfiguration SEQUENCE {			
nonCriticalExtension SEQUENCE {			
masterCellGroup	CellGroupConfig		
}			
}			
}			
}			

Table 8.1.2.1.2.3.3-2: *CellGroupConfig* (Table 8.1.2.1.2.3.3-1)

Derivation Path: 38.508-1 [4], Table 4.6.3-19			
Information Element	Value/remark	Comment	Condition
CellGroupConfig ::= SEQUENCE {			
spCellConfig SEQUENCE {			
spCellConfigDedicated	ServingCellConfig		
}			
reportUplinkTxDirectCurrent-v1530	true		
}			

Table 8.1.2.1.2.3.3-3: ServingCellConfig (Table 8.1.2.1.2.3.3-2)

Derivation Path: 38.508-1 [4] Table 4.6.3-167			
Information Element	Value/remark	Comment	Condition
ServingCellConfigCommon ::= SEQUENCE {			
uplinkConfig SEQUENCE {			
uplinkBWP-ToAddModList SEQUENCE (SIZE (1..maxNrofBWPs)) OF BWP-Uplink {	1 entry		
BWP-Uplink[1]	BWP-Uplink	entry 1 TS 38.508-1 [4], Table 4.6.3-13 to add BWP#1	
}			
}			
}			

Table 8.1.2.1.2.3.3-4: RRCReconfigurationComplete (step 2, Table 8.1.2.1.2.3.2-1)

Derivation Path: 38.508-1 [4], Table 4.6.1-14			
Information Element	Value/remark	Comment	Condition
RRCReconfigurationComplete ::= SEQUENCE {			
rrc-TransactionIdentifier	Not checked		
criticalExtensions CHOICE {			
rrcReconfigurationComplete SEQUENCE {			
lateNonCriticalExtension	Not checked		
nonCriticalExtension SEQUENCE {			
UplinkTxDirectCurrentList SEQUENCE (SIZE (1..maxNrofServingCells)) OF UplinkTxDirectCurrentCell {	1 entry		
UplinkTxDirectCurrentCell[1] SEQUENCE {		entry 1	
servCellIndex	0		
UplinkTxDirectCurrentBWP SEQUENCE (SIZE (1..maxNrofBWPs)) OF UplinkTxDirectCurrentBWP {	2 entries		
UplinkTxDirectCurrentBWP[1] SEQUENCE {		entry 1	
bwp-Id	0		
shift7dot5kHz	Not checked		
txDirectCurrentLocation	Any value between 0 and 3299		
}			
UplinkTxDirectCurrentBWP[2] SEQUENCE {		entry 2	
bwp-Id	1		
shift7dot5kHz	Not checked		
txDirectCurrentLocation	Any value between 0 and 3299		
}			
}			
}			
nonCriticalExtension	Not checked		
}			
}			
}			

8.1.2.1.3 Void

8.1.2.1.4 RRC reconfiguration / Dedicated RLF timer

8.1.2.1.4.1 Test Purpose (TP)

(1)

```
with { UE in NR RRC_CONNECTED state configured with timers according rlf-TimersAndConstants }
ensure that {
  when { UE detecting radio link failure on expiring of timer T310 }
  then { UE sends an RRCReestablishmentRequest message according rlf-TimersAndConstants }
}
```

(2)

```
with { UE in NR RRC_CONNECTED state with rlf-TimersAndConstants released}
ensure that {
  when { UE detecting radio link failure on expiring of timer T310 }
  then { UE sends an RRCReestablishmentRequest message according ue-TimersAndConstants }
}
```

8.1.2.1.4.2 Conformance requirements

References: The conformance requirements covered in the current TC are specified in: TS 38.331 clauses 5.3.5.3, 5.3.5.5, 5.3.5.5.6 and 5.3.5.5.7.

[TS 38.331 clause 5.3.5.3]

The UE shall perform the following actions upon reception of the *RRCReconfiguration*:

...

1> if the *RRCReconfiguration* includes the *masterCellGroup*:

2> perform the cell group configuration for the received *masterCellGroup* according to 5.3.5.5;

...

1> else:

2> submit the *RRCReconfigurationComplete* message via SRB1 to lower layers for transmission using the new configuration;

[TS 38.331 clause 5.3.5.5]

The UE performs the following actions based on a received *CellGroupConfig* IE:

...

1> if the *CellGroupConfig* contains the *spCellConfig*:

2> configure the SpCell as specified in 5.3.5.5.7;

[TS 38.331 clause 5.3.5.5.7]

The UE shall:

1> if the *SpCellConfig* contains the *rlf-TimersAndConstants*:

2> configure the RLF timers and constants for this cell group as specified in 5.3.5.5.6;

[TS 38.331 clause 5.3.5.5.6]

The UE shall:

1> if the received *rlf-TimersAndConstants* is set to *release*:

2> use values for timers T301, T310, T311 and constants N310, N311, as included in *ue-TimersAndConstants* received in *SIB1*;

1> else:

2> (re-)configure the value of timers and constants in accordance with received *rlf-TimersAndConstants*;

8.1.2.1.4.3 Test description

8.1.2.1.4.3.1 Pre-test conditions

System Simulator:

- NR Cell 1 and NR Cell 2.
- System information combination NR-2 as defined in TS 38.508-1 [4] clause 4.4.3.1.2 is used in NR cells.

None.

Preamble:

- The UE is in state 3N-A as defined in TS 38.508-1 [4], subclause 4.4A on NR Cell 1.

8.1.2.1.4.3.2 Test procedure sequence

Table 8.1.2.1.4.3.2-1: Time instances of cell power level and parameter changes for FR1

	Parameter	Unit	NR Cell 1	NR Cell 2
T1	SS/PBCH SSS EPRE	dBm/SCS	"Off"	-88
T2	SS/PBCH SSS EPRE	dBm/SCS	"-88"	"Off"

Table 8.1.2.1.4.3.2-2: Time instances of cell power level and parameter changes for FR2

	Parameter	Unit	NR Cell 1	NR Cell 2
T1	SS/PBCH SSS EPRE	dBm/SCS	"Off"	-82
T2	SS/PBCH SSS EPRE	dBm/SCS	"-82"	"Off"

Table 8.1.2.1.4.3.2-3: Main behaviour

St	Procedure	Message Sequence		TP	Verdict
		U - S	Message		
1	The SS changes NR Cell 1 and NR Cell 2 parameters according to the row "T1" in table 8.1.2.1.4.3.2-1 or 8.1.2.1.4.3.2-2 in order that the radio link quality of NR Cell 1 is degraded, and NR Cell 2 is suitable for camping.	-	-	-	-
2	Check: Does the UE send <i>RRCReestablishmentRequest</i> message on NR Cell 2 after T310 expired (ms6000)?	-->	NR RRC: <i>RRCReestablishmentRequest</i>	1	P
3	The SS transmits an <i>RRCReestablishment</i> message.	<--	NR RRC: <i>RRCReestablishment</i>	-	-
4	The UE transmits an <i>RRCReestablishmentComplete</i> message.	-->	NR RRC: <i>RRCReestablishmentComplete</i>	-	-
5	The SS transmits an <i>RRCReconfiguration</i> message containing <i>RLF-TimersAndConstants</i> set to release.	<--	NR RRC: <i>RRCReconfiguration</i>	-	-
6	The UE transmits an <i>RRCReconfigurationComplete</i> message.	-->	NR RRC: <i>RRCReconfigurationComplete</i>	-	-
7	The SS changes NR Cell 1 and NR Cell 2 parameters according to the row "T2" in table 8.1.2.1.4.3.2-1 or 8.1.2.1.4.3.2-2 in order that the radio link quality of NR Cell 2 is degraded, and NR Cell 1 is suitable for camping.	-	-	-	-
8	Check: Does the UE send <i>RRCReestablishmentRequest</i> message on NR Cell 1 after T310 expired (ms1000)?	-->	NR RRC: <i>RRCReestablishmentRequest</i>	2	P
9	The SS transmits <i>RRCReestablishment</i> message.	<--	NR RRC: <i>RRCReestablishment</i>	-	-
10	The UE transmits an <i>RRCReestablishmentComplete</i> message.	-->	NR RRC: <i>RRCReestablishmentComplete</i>	-	-
11	The SS transmits an <i>RRCReconfiguration</i> message to establish SRB2 and DRB.	<--	NR RRC: <i>RRCReconfiguration</i>	-	-
12	The UE transmits an <i>RRCReconfigurationComplete</i> message.	-->	NR RRC: <i>RRCReconfigurationComplete</i>	-	-

8.1.2.1.4.3.3 Specific message contents

Table 8.1.2.1.4.3.3-1: *RLF-TimersAndConstants* (preamble)

Derivation Path: 38.508-1 [4] Table 4.6.1-150			
Information Element	Value/remark	Comment	Condition
<i>RLF-TimersAndConstants</i> ::= SEQUENCE {			
t310	ms6000		
n310	n20		
}			

Table 8.1.2.1.4.3.3-2: *RRCReconfiguration* (step 5, Table 8.1.2.1.4.3.2-3)

Derivation Path: 38.508-1 [4] Table 4.6.1-13 with condition REEST			
Information Element	Value/remark	Comment	Condition
<i>RRCReconfiguration</i> ::= SEQUENCE {			
criticalExtensions CHOICE {			
rrcReconfiguration SEQUENCE {			
nonCriticalExtension SEQUENCE {			
masterCellGroup	CellGroupConfig		
}			
}			
}			
}			

Table 8.1.2.1.4.3.3-3: CellGroupConfig (Table 8.1.2.1.4.3.3-2)

Derivation Path: 38.508-1 [4] Table 4.6.3-19 with condition REEST			
Information Element	Value/remark	Comment	Condition
CellGroupConfig ::= SEQUENCE {			
spCellConfig SEQUENCE {			
rlf-TimersAndConstants CHOICE {			
release	NULL		
}			
}			
}			

Table 8.1.2.1.4.3.3-4: RRCReconfiguration (step 11 Table 8.1.2.1.4.3.2-3)

Derivation Path: 38.508-1 [4] Table 4.6.1-13 with condition REEST			
---	--	--	--

8.1.2.1.5 NR CA / RRC reconfiguration / SCell addition / modification / release / Success

8.1.2.1.5.1 NR CA / RRC reconfiguration / SCell addition / modification / release / Success / Intra-band Contiguous CA

8.1.2.1.5.1.1 Test Purpose (TP)

(1)

```
with { UE in NR RRC_CONNECTED state }
ensure that {
  when { UE receives an RRCReconfiguration message containing sCellToAddModList for SCell addition }
  then { UE adds the new SCell and sends an RRCReconfigurationComplete message }
}
```

(2)

```
with { UE in NR RRC_CONNECTED state with SCell configured}
ensure that {
  when { UE receives an RRCReconfiguration message containing sCellToAddModList for SCell
modification }
  then { UE modifies the SCell configuration and sends an RRCReconfigurationComplete message }
}
```

(3)

```
with { UE in NR RRC_CONNECTED state with SCell configured}
ensure that {
  when { UE receives an RRCReconfiguration message containing sCellToReleaseList }
  then { UE sends an RRCReconfigurationComplete message }
}
```

8.1.2.1.5.1.2 Conformance requirements

References: The conformance requirements covered in the current TC are specified in: TS 38.331 clauses 5.3.5.3, 5.3.5.5.1 and 5.3.5.5.9.

[TS 38.331 clause 5.3.5.3]

The UE shall perform the following actions upon reception of the *RRCReconfiguration*:

...

1> if the *RRCReconfiguration* includes the *masterCellGroup*:

 2> perform the cell group configuration for the received *masterCellGroup* according to 5.3.5.5;

...

1> else:

- 2> submit the *RRCReconfigurationComplete* message via SRB1 to lower layers for transmission using the new configuration;

[TS 38.331 clause 5.3.5.5.1]

The UE performs the following actions based on a received *CellGroupConfig* IE:

...

1> if the *CellGroupConfig* contains the *sCellToReleaseList*:

- 2> perform SCell release as specified in 5.3.5.5.8;

...

1> if the *CellGroupConfig* contains the *sCellToAddModList*:

- 2> perform SCell addition/modification as specified in 5.3.5.5.9.

[TS 38.331 clause 5.3.5.5.9]

The UE shall:

1> for each *sCellIndex* value included in the *sCellToAddModList* that is not part of the current UE configuration (SCell addition):

- 2> add the SCell, corresponding to the *sCellIndex*, in accordance with the *sCellConfigCommon* and *sCellConfigDedicated*;

- 2> configure lower layers to consider the SCell to be in deactivated state;

...

1> for each *sCellIndex* value included in the *sCellToAddModList* that is part of the current UE configuration (SCell modification):

- 2> modify the SCell configuration in accordance with the *sCellConfigDedicated*.

8.1.2.1.5.1.3 Test description

8.1.2.1.5.1.3.1 Pre-test conditions

System Simulator:

- NR Cell 1 is the PCell, NR Cell 3 is the SCell.

None.

Preamble:

- The UE is in state 3N-A, and with UE test loop mode B active if *pc_IP_Ping* is set to FALSE, as defined in TS 38.508-1 [4], subclause 4.4A on NR Cell 1.

8.1.2.1.5.1.3.2 Test procedure sequence

Table 8.1.2.1.5.1.3.2-1: Main behaviour

St	Procedure	Message Sequence		TP	Verdict
		U - S	Message		
1	The SS transmits an <i>RRCReconfiguration</i> message containing an <i>sCellToAddModList</i> with <i>SCell NR Cell 3</i> addition.	<--	NR RRC: <i>RRCReconfiguration</i>	-	-
2	Check: Does the UE transmits an <i>RRCReconfigurationComplete</i> message?	-->	NR RRC: <i>RRCReconfigurationComplete</i>	1	P
3	Check: Does the test result of generic test procedure in TS 38.508-1 subclause 4.9.1 indicate that the UE is capable of exchanging IP data on DRB1 and Cell 3?	-	-	1	P
4	The SS transmits an <i>RRCReconfiguration</i> message containing an <i>sCellToAddModList</i> with <i>SCell NR Cell 3</i> modification.	<--	NR RRC: <i>RRCReconfiguration</i>	-	-
5	Check: Does the UE transmit an <i>RRCReconfigurationComplete</i> message?	-->	NR RRC: <i>RRCReconfigurationComplete</i>	2	P
6	Check: Does the test result of generic test procedure in TS 38.508-1 subclause 4.9.1 indicate that the UE is capable of exchanging IP data on DRB1 and Cell 3?	-	-	2	P
7	The SS transmits an <i>RRCReconfiguration</i> message containing an <i>sCellToReleaseList</i> with <i>SCell NR Cell 3</i> .	<--	NR RRC: <i>RRCReconfiguration</i>	-	-
8	Check: Does the UE transmit an <i>RRCReconfigurationComplete</i> message?	-->	NR RRC: <i>RRCReconfigurationComplete</i>	3	P

8.1.2.5.1.1.3.3 Specific message contents

Table 8.1.2.5.1.1.3.3-1: *RRCReconfiguration* (step 1, Table 8.1.2.1.5.1.3.2-1)

Derivation Path: 38.508-1 [4] Table 4.6.1-13 with condition <i>SCell_add</i>
--

Table 8.1.2.5.1.1.3.3-2: *RRCReconfiguration* (step 4, Table 8.1.2.1.5.1.3.2-1)

Derivation Path: 38.508-1 [4] Table 4.6.1-13 with condition <i>SCell_add</i>			
Information Element	Value/remark	Comment	Condition
<i>RRCReconfiguration</i> ::= SEQUENCE {			
<i>criticalExtensions</i> CHOICE {			
<i>rrcReconfiguration</i> SEQUENCE {			
<i>nonCriticalExtension</i> SEQUENCE{			
<i>masterCellGroup</i>	<i>CellGroupConfig</i>		
}			
}			
}			
}			

Table 8.1.2.5.1.1.3.3-3: CellGroupConfig (Table 8.1.2.5.1.1.3.3-2)

Derivation Path: 38.508-1 [4] Table 4.6.3-19 with condition SCell_add			
Information Element	Value/remark	Comment	Condition
CellGroupConfig ::= SEQUENCE {			
sCellToAddModList SEQUENCE (SIZE (1..maxNrofSCells)) OF SCellConfig {	1 entry		
SCellConfig[1] SEQUENCE {		entry 1	
sCellConfigCommon	Not present		
sCellConfigDedicated	ServingCellConfig		
}			
}			
}			

Table 8.1.2.5.1.1.3.3-4: ServingCellConfig (Table 8.1.2.5.1.1.3.3-3)

Derivation Path: 38.508-1 [4] Table 4.6.3-167			
Information Element	Value/remark	Comment	Condition
ServingCellConfig ::= SEQUENCE {			
pdsch-ServingCellConfig CHOICE {			
setup	PDSCH-ServingCellConfig		
}			
}			

Table 8.1.2.5.1.1.3.3-5: PDSCH-ServingCellConfig (Table 8.1.2.5.1.1.3.3-4)

Derivation Path: 38.508-1 [4] Table 4.6.3-102			
Information Element	Value/remark	Comment	Condition
PDSCH-ServingCellConfig ::= SEQUENCE {			
nrofHARQ-ProcessesForPDSCH	Not present	The UE uses 8 HARQ processes.	
}			

Table 8.1.2.5.1.1.3.3-6: RRCReconfiguration (step 7, Table 8.1.2.5.1.1.3.2-1)

Derivation Path: 38.508-1 [4] Table 4.6.1-13 with condition SCell_add			
Information Element	Value/remark	Comment	Condition
RRCReconfiguration ::= SEQUENCE {			
criticalExtensions CHOICE {			
rrcReconfiguration SEQUENCE {			
nonCriticalExtension SEQUENCE{			
masterCellGroup	CellGroupConfig		
}			
}			
}			
}			

Table 8.1.2.5.1.1.3.3-7: CellGroupConfig (Table 8.1.2.5.1.1.3.3-6)

Derivation Path: 38.508-1 [4] Table 4.6.3-19 with condition SCell_add			
Information Element	Value/remark	Comment	Condition
CellGroupConfig ::= SEQUENCE {			
sCellToAddModList	Not present		
sCellToReleaseList SEQUENCE (SIZE (1..maxNrofSCells)) OF SCellIndex {	1 entry		
SCellIndex[1]	1	entry 1	
}			
}			

8.1.2.1.5.2 NR CA / RRC reconfiguration / SCell addition / modification / release / Success / Inter-band CA

8.1.2.1.5.2.1 Test Purpose (TP)

Same as TC 8.1.2.1.5.1 but applied to Inter-band CA.

8.1.2.1.5.2.2 Conformance requirements

Same as TC 8.1.2.1.5.1 but applied to Inter-band CA.

8.1.2.1.5.2.3 Test description

8.1.2.1.5.2.3.1 Pre-test conditions

Same as TC 8.1.2.1.5.1 with the following differences:

- CA configuration: Inter-band CA replaces Intra-band Contiguous CA
- Cells configuration: NR Cell 10 replaces NR Cell 3

8.1.2.1.5.2.3.2 Test procedure sequence

Same as TC 8.1.2.1.5.1 with the following differences:

- CA configuration: Inter-band CA replaces Intra-band Contiguous CA
- Cells configuration: NR Cell 10 replaces NR Cell 3

8.1.2.1.5.3 NR CA / RRC reconfiguration / SCell addition / modification / release / Success / Intra-band non-contiguous CA

8.1.2.1.5.3.1 Test Purpose (TP)

Same as TC 8.1.2.1.5.1 but applied to Intra-band non-contiguous CA.

8.1.2.1.5.3.2 Conformance requirements

Same as TC 8.1.2.1.5.1 but applied to Intra-band non-contiguous CA.

8.1.2.1.5.3.3 Test description

8.1.2.1.5.3.3.1 Pre-test conditions

Same as TC 8.1.2.1.5.1 with the following differences:

- CA configuration: Intra-band non-contiguous replaces Intra-band Contiguous CA

8.1.2.1.5.3.3.2 Test procedure sequence

Same as TC 8.1.2.1.5.1 with the following differences:

- CA configuration: Intra-band non-contiguous replaces Intra-band Contiguous CA

8.1.3 Measurement configuration control and reporting

8.1.3.1 Intra NR measurements

8.1.3.1.1 Measurement configuration control and reporting / Intra NR measurements / Event A1 / Event A2

8.1.3.1.1.1 Test Purpose (TP)

(1)

```
with { UE in NR RRC_CONNECTED and measurement configured for event A1 and event A2 with event based
periodical reporting }
ensure that {
  when { Serving cell becomes better than absolute threshold plus hysteresis and entering condition
for event A1 is met }
  then { UE sends MeasurementReport message at regular intervals while entering condition for
event A1 is satisfied }
}
```

(2)

```
with { UE in NR RRC_CONNECTED and periodical measurement reporting triggered by event A1 ongoing }
ensure that {
  when { Serving cell becomes worse than absolute threshold minus hysteresis }
  then { UE stops sending MeasurementReport message }
}
```

(3)

```
with { UE in NR RRC_CONNECTED and measurement configured for event A1 and event A2 with event based
periodical reporting }
ensure that {
  when { Serving cell becomes worse than absolute threshold minus hysteresis and entering condition
for event A2 is met }
  then { UE sends MeasurementReport message at regular intervals while entering condition for
event A2 is satisfied }
}
```

(4)

```
with { UE in NR RRC_CONNECTED state and periodical measurement reporting triggered by event A2
ongoing }
ensure that {
  when { Serving cell becomes better than absolute threshold plus hysteresis }
  then { UE stops sending MeasurementReport message }
}
```

(5)

```
with { UE in NR RRC_CONNECTED and measurements are re-configured for event A1 with event based
periodical reporting to report on leaving condition }
ensure that {
  when { Serving cell becomes worse than absolute threshold minus hysteresis }
  then { UE sends MeasurementReport message while leaving condition for event A1 is satisfied }
}
```

8.1.3.1.1.2 Conformance requirements

References: The conformance requirements covered in the current TC are specified in: TS 38.331, clause 5.3.5.3, 5.5.2, 5.5.4.1, 5.5.4.2, 5.5.4.3 and 5.5.5. Unless otherwise stated these are Rel-15 requirements.

[TS 38.331, clause 5.3.5.3]

The UE shall perform the following actions upon reception of the *RRCReconfiguration*:

...

- 1> if the *RRCReconfiguration* message includes the *measConfig*:
 - 2> perform the measurement configuration procedure as specified in 5.5.2;
 - ...
- 1> if the UE is configured with E-UTRA *nr-SecondaryCellGroupConfig* (MCG is E-UTRA):
 - ...
- 1> else:
 - 2> submit the *RRCReconfigurationComplete* message via SRB1 to lower layers for transmission using the new configuration;
 - ...

[TS 38.331, clause 5.5.2.1]

...

The UE shall:

...

- 1> if the received *measConfig* includes the *measObjectToAddModList*:
 - 2> perform the measurement object addition/modification procedure as specified in 5.5.2.5;
 - ...
- 1> if the received *measConfig* includes the *reportConfigToAddModList*:
 - 2> perform the reporting configuration addition/modification procedure as specified in 5.5.2.7;
- 1> if the received *measConfig* includes the *quantityConfig*:
 - 2> perform the quantity configuration procedure as specified in 5.5.2.8;
- 1> if the received *measConfig* includes the *measIdToRemoveList*:
 - 2> perform the measurement identity removal procedure as specified in 5.5.2.2;
- 1> if the received *measConfig* includes the *measIdToAddModList*:
 - 2> perform the measurement identity addition/modification procedure as specified in 5.5.2.3;

[TS 38.331, clause 5.5.4.1]

If security has been activated successfully, the UE shall:

- 1> for each *measId* included in the *measIdList* within *VarMeasConfig*:
 - 2> if the corresponding *reportConfig* includes a *reportType* set to *eventTriggered* or *periodical*;
 - 3> if the corresponding *measObject* concerns NR;
 - 4> if the *eventA1* or *eventA2* is configured in the corresponding *reportConfig*;
 - 5> consider only the serving cell to be applicable;
 - ...
 - 2> if the *reportType* is set to *eventTriggered* and if the entry condition applicable for this event, i.e. the event corresponding with the *eventId* of the corresponding *reportConfig* within *VarMeasConfig*, is fulfilled for one or more applicable cells for all measurements after layer 3 filtering taken during *timeToTrigger* defined for this event within the *VarMeasConfig*, while the *VarMeasReportList* does not include a measurement reporting entry for this *measId* (a first cell triggers the event);

- 3> include a measurement reporting entry within the *VarMeasReportList* for this *measId*;
- 3> set the *numberOfReportsSent* defined within the *VarMeasReportList* for this *measId* to 0;
- 3> include the concerned cell(s) in the *cellsTriggeredList* defined within the *VarMeasReportList* for this *measId*;
- 3> initiate the measurement reporting procedure, as specified in 5.5.5;
- ...
- 2> else if the *reportType* is set to *eventTriggered* and if the leaving condition applicable for this event is fulfilled for one or more of the cells included in the *cellsTriggeredList* defined within the *VarMeasReportList* for this *measId* for all measurements after layer 3 filtering taken during *timeToTrigger* defined within the *VarMeasConfig* for this event:
 - 3> remove the concerned cell(s) in the *cellsTriggeredList* defined within the *VarMeasReportList* for this *measId*;
 - 3> if *reportOnLeave* is set to *TRUE* for the corresponding reporting configuration:
 - 4> initiate the measurement reporting procedure, as specified in 5.5.5;
 - 3> if the *cellsTriggeredList* defined within the *VarMeasReportList* for this *measId* is empty:
 - 4> remove the measurement reporting entry within the *VarMeasReportList* for this *measId*;
 - 4> stop the periodical reporting timer for this *measId*, if running;
- ...
- 2> upon expiry of the periodical reporting timer for this *measId*:
 - 3> initiate the measurement reporting procedure, as specified in 5.5.5.
- ...

[TS 38.331, clause 5.5.4.2]

The UE shall:

- 1> consider the entering condition for this event to be satisfied when condition A1-1, as specified below, is fulfilled;
- 1> consider the leaving condition for this event to be satisfied when condition A1-2, as specified below, is fulfilled;
- 1> for this measurement, consider the NR serving cell corresponding to the associated *measObjectNR* associated with this event.

Inequality A1-1 (Entering condition)

$$Ms - Hys > Thresh$$

Inequality A1-2 (Leaving condition)

$$Ms + Hys < Thresh$$

The variables in the formula are defined as follows:

Ms is the measurement result of the serving cell, not taking into account any offsets.

Hys is the hysteresis parameter for this event (i.e. *hysteresis* as defined within *reportConfigNR* for this event).

Thresh is the threshold parameter for this event (i.e. *a1-Threshold* as defined within *reportConfigNR* for this event).

Ms is expressed in dBm in case of RSRP, or in dB in case of RSRQ and RS-SINR.

Hys is expressed in dB.

Thresh is expressed in the same unit as *Ms*.

[TS 38.331, clause 5.5.4.3]

The UE shall:

- 1> consider the entering condition for this event to be satisfied when condition A2-1, as specified below, is fulfilled;
- 1> consider the leaving condition for this event to be satisfied when condition A2-2, as specified below, is fulfilled;
- 1> for this measurement, consider the serving cell indicated by the *measObjectNR* associated to this event.

Inequality A2-1 (Entering condition)

$$Ms + Hys < Thresh$$

Inequality A2-2 (Leaving condition)

$$Ms - Hys > Thresh$$

The variables in the formula are defined as follows:

Ms is the measurement result of the serving cell, not taking into account any offsets.

Hys is the hysteresis parameter for this event (i.e. *hysteresis* as defined within *reportConfigNR* for this event).

Thresh is the threshold parameter for this event (i.e. *a2-Threshold* as defined within *reportConfigNR* for this event).

Ms is expressed in dBm in case of RSRP, or in dB in case of RSRQ and RS-SINR.

Hys is expressed in dB.

Thresh is expressed in the same unit as *Ms*.

[TS 38.331, clause 5.5.5]



Figure 5.5.5.1-1: Measurement reporting

The purpose of this procedure is to transfer measurement results from the UE to the network. The UE shall initiate this procedure only after successful security activation.

For the *measId* for which the measurement reporting procedure was triggered, the UE shall set the *measResults* within the *MeasurementReport* message as follows:

- 1> set the *measId* to the measurement identity that triggered the measurement reporting;
- 1> set the *measResultServingCell* within *measResultServingMOList* to include , for each NR serving cell that is configured with *servingCellMO*, RSRP, RSRQ and the available SINR derived based on the *rsType* if indicated in the associated *reportConfig* , otherwise based on SSB if available, otherwise based on CSI-RS;
- 1> set the *measResultServingCell* within *measResultServingMOList* to include for each NR serving cell that is configured with *servingCellMO*, if any, the *servCellId*;

...

- 1> increment the *numberOfReportsSent* as defined within the *VarMeasReportList* for this *measId* by 1;
- 1> stop the periodical reporting timer, if running;
- 1> if the *numberOfReportsSent* as defined within the *VarMeasReportList* for this *measId* is less than the *reportAmount* as defined within the corresponding *reportConfig* for this *measId*:
 - 2> start the periodical reporting timer with the value of *reportInterval* as defined within the corresponding *reportConfig* for this *measId*;
- 1> else:
 - 2> if the *reportType* is set to *periodical*:
 - 3> remove the entry within the *VarMeasReportList* for this *measId*;
 - 3> remove this *measId* from the *measIdList* within *VarMeasConfig*;
- 1> if the UE is configured with EN-DC:
 - ...
- 1> else:
 - 2> submit the *MeasurementReport* message to lower layers for transmission, upon which the procedure ends.

8.1.3.1.1.3 Test description

8.1.3.1.1.3.1 Pre-test conditions

System Simulator:

- NR Cell 1

UE:

- None.

Preamble:

- The UE is in state 3N-A as defined in TS 38.508-1 [4], subclause 4.4A on NR Cell 1.

8.1.3.1.1.3.2 Test procedure sequence

Table 8.1.3.1.1.3.2-1/2 illustrates the downlink power levels and other changing parameters to be applied for the cells at various time instants of the test execution. Row marked "T0" denotes the initial conditions after preamble, while columns marked "T1" and "T2", are to be applied subsequently. The exact instants on which these values shall be applied are described in the texts in this clause.

Table 8.1.3.1.1.3.2-1: Time instances of cell power level and parameter changes in FR1

	Parameter	Unit	NR Cell 1	Remark
T0	SS/PBCH SSS EPRE	dBm/SCS	-98	Power level is such that entry condition for event A2 is satisfied $Ms + Hys < Thresh$
T1	SS/PBCH SSS EPRE	dBm/SCS	-78	Power level is such that entry condition for event A1 is satisfied $Ms - Hys > Thresh$ and exit condition for event A2 is satisfied too.
T2	SS/PBCH SSS EPRE	dBm/SCS	-98	Power level is such that exit condition for event A1 is satisfied $Ms + Hys < Thresh$

Table 8.1.3.1.1.3.2-2: Time instances of cell power level and parameter changes in FR2

	Parameter	Unit	NR Cell 1	Remark
T0	SS/PBCH SSS EPRE	dBm/SCS	FFS	Power level is such that entry condition for event A2 is satisfied $M_s + H_{ys} < Thresh$
T1	SS/PBCH SSS EPRE	dBm/SCS	FFS	Power level is such that entry condition for event A1 is satisfied $M_s - H_{ys} > Thresh$ and exit condition for event A2 is satisfied too.
T2	SS/PBCH SSS EPRE	dBm/SCS	FFS	Power level is such that exit condition for event A1 is satisfied $M_s + H_{ys} < Thresh$

Table 8.1.3.1.1.3.2-3: Main behaviour

St	Procedure	Message Sequence		TP	Verdict
		U - S	Message		
1	SS transmits an <i>RRCReconfiguration</i> message including <i>measConfig</i> to setup intra NR measurement and reporting for event A1 and event A2.	<--	NR RRC: <i>RRCReconfiguration</i>	-	-
2	The UE transmits an <i>RRCReconfigurationComplete</i> message.	-->	NR RRC: <i>RRCReconfigurationComplete</i>	-	-
3	Check: Does the UE transmit a <i>MeasurementReport</i> message to report event A2 with the measured RSRP, RSRQ and SINR value for NR Cell 1?	-->	NR RRC: <i>MeasurementReport</i>	3	P
-	EXCEPTION: Step 4 below is repeated until 3 <i>MeasurementReport</i> messages are received from the UE and Interval between two <i>MeasurementReport</i> is same as the IE <i>reportInterval</i> configured in <i>measConfig</i> .	-	-	-	-
4	Check: Does the UE transmit a <i>MeasurementReport</i> message at regular intervals, with the measured RSRP, RSRQ and SINR value for NR Cell 1?	-->	NR RRC: <i>MeasurementReport</i>	3	P
5	SS re-adjusts the SS/PBCH EPRE level according to row "T1" in Table 8.1.3.1.1.3.2-1/2.	-	-	-	-
6	Wait and ignore <i>MeasurementReport</i> messages for 15 s to allow change of power levels for NR Cell 1 and UE measurement.	-	-	-	-
-	EXCEPTION: In parallel with step 7, parallel behaviour defined in table 8.1.3.1.1.3.2-4 is executed	-	-	-	-
7	Check: Does the UE transmit a <i>MeasurementReport</i> message to report event A1 with the measured RSRP, RSRQ and SINR value for NR Cell 1?	-->	NR RRC: <i>MeasurementReport</i>	1	P
-	EXCEPTION: Step 8 below is repeated until 3 <i>MeasurementReport</i> messages are received from the UE and Interval between two <i>MeasurementReport</i> is same as the IE <i>reportInterval</i> configured in <i>measConfig</i> .	-	-	-	-
8	Check: Does the UE transmit a <i>MeasurementReport</i> message at regular intervals, with the measured RSRP, RSRQ and SINR value for NR Cell 1?	-->	NR RRC: <i>MeasurementReport</i>	1	P
9	SS re-adjusts the SS/PBCH EPRE level according to row "T2" in Table 8.1.3.1.1.3.2-1/2.	-	-	-	-
10	Wait and ignore <i>MeasurementReport</i> messages for 15 s to allow change of power levels for NR Cell 1 and UE measurement.	-	-	-	-
11	Check: Does the UE transmit a <i>MeasurementReport</i> message to report event A1 with the measured RSRP, RSRQ and SINR value for NR Cell 1 within the next 10s? NOTE: SS ignore <i>MeasurementReport</i> message for event A2.	-	-	2	F
12	SS transmits an <i>RRCReconfiguration</i> message to re-configure for event A1 with event based periodical reporting to report on leaving condition and release event A2.	<--	NR RRC: <i>RRCReconfiguration</i>	-	-
13	The UE transmits an <i>RRCReconfigurationComplete</i> message.	-->	NR RRC: <i>RRCReconfigurationComplete</i>	-	-
14	SS re-adjusts the SS/PBCH EPRE level according to row "T1" in Table 8.1.3.1.1.3.2-1/2.	-	-	-	-
15	SS receive four <i>MeasurementReport</i>	-	-	-	-

	messages for A1 and then wait 5s.				
16	SS re-adjusts the SS/PBCH EPRE level according to row "T2" in Table 8.1.3.1.1.3.2-1/2.	-	-	-	-
17	Check: Does the UE transmit a <i>MeasurementReport</i> message to report event A1 with the measured RSRP, RSRQ and SINR value for NR Cell 1?	-->	NR RRC: <i>MeasurementReport</i>	5	P
18	Check: Does the UE attempt to transmit <i>MeasurementReport</i> message within the next 10s?	-	-	5	F

Table 8.1.3.1.1.3.2-4: Parallel behaviour

St	Procedure	Message Sequence		TP	Verdict
		U - S	Message		
1	Check: Does the UE transmit a <i>MeasurementReport</i> message to report event A2 with the measured RSRP, RSRQ and SINR value for NR Cell 1?	-	-	4	F

8.1.3.1.1.3.3 Specific message contents

Table 8.1.3.1.1.3.3-1: RRCReconfiguration (step 1 Table 8.1.3.1.1.3.2-3)

Derivation Path: TS 38.508-1 [4], Table 4.6.1-13 with condition NR_MEAS

Table 8.1.3.1.1.3.3-2: MeasConfig (Table 8.1.3.1.1.3.3-1)

Derivation path: 38.508-1 [4] Table 4.6.3-69			
Information Element	Value/Remark	Comment	Condition
measConfig ::= SEQUENCE {			
measObjectToAddModList SEQUENCE (SIZE (1..maxNrofObjectId)) OF MeasObjectToAddMod {	1 entry		
MeasObjectToAddMod[1] SEQUENCE {		entry 1	
measObjectId	1		
measObject CHOICE {			
measObjectNR	MeasObjectNR(57)	Thres=57(-100dBm ≤ SS-RSRP < 99dBm)	
}			
}			
reportConfigToAddModList SEQUENCE (SIZE (1..maxReportConfigId)) OF ReportConfigToAddMod {	2 entries		
ReportConfigToAddMod[1] SEQUENCE {		entry 1	
reportConfigId	1		
reportConfig	ReportConfigNR-EventA1		
}			
ReportConfigToAddMod[2] SEQUENCE {		entry 2	
reportConfigId	2		
reportConfig	ReportConfigNR-EventA2		
}			
}			
measIdToAddModList SEQUENCE (SIZE (1..maxNrofMeasId)) OF MeasIdToAddMod {	2 entries		
MeasIdToAddMod[1] SEQUENCE {		entry 1	
measId	1		
measObjectId	1		
reportConfigId	1		
}			
MeasIdToAddMod[2] SEQUENCE {		entry 2	
measId	2		
measObjectId	1		
reportConfigId	2		
}			
}			
quantityConfig	QuantityConfig		
}			

Table 8.1.3.1.1.3.3-3: MeasObjectNR (Table 8.1.3.1.1.3.3-2)

Derivation Path: 38.508-1 [4], Table 4.6.3-76			
Information Element	Value/remark	Comment	Condition
MeasObjectNR ::= SEQUENCE {			
ssbFrequency	Downlink ARFCN of NR cell 1 SSB		
}			

Table 8.1.3.1.1.3.3-4: ReportConfigNR-EventA1 (Table 8.1.3.1.1.3.3-2)

Derivation Path: 38.508-1 [4], Table 4.6.3-142 with condition EVENT_A1			
Information Element	Value/remark	Comment	Condition
ReportConfigNR::= SEQUENCE {			
reportType CHOICE {			
eventTriggered SEQUENCE {			
eventId CHOICE {			
eventA1 SEQUENCE {			EVENT_A1
a1-Threshold CHOICE {			
rsrp	69	-88dBm ≤ SS-RSRP<- 87dBm	FR1
rsrp	FFS		FR2
}			
}			
}			
reportAmount	Infinity		
}			
}			

Table 8.1.3.1.1.3.3-5: ReportConfigNR-EventA2 (Table 8.1.3.1.1.3.3-2)

Derivation Path: 38.508-1 [4], Table 4.6.3-142 with condition EVENT_A2			
Information Element	Value/remark	Comment	Condition
ReportConfigNR::= SEQUENCE {			
reportType CHOICE {			
eventTriggered SEQUENCE {			
eventId CHOICE {			
eventA2 SEQUENCE {			EVENT_A2
a2-Threshold CHOICE {			
rsrp	69	-88dBm ≤ SS-RSRP<- 87dBm	FR1
rsrp	73	-84dBm ≤ SS-RSRP<- 83dBm	FR2
}			
}			
}			
reportAmount	Infinity		
}			

Table 8.1.3.1.1.3.3-6: QuantityConfig (Table 8.1.3.1.1.3.3-2)

Derivation Path: 38.508-1 [4], Table 4.6.3-127			
Information Element	Value/remark	Comment	Condition
QuantityConfig ::= SEQUENCE {			
quantityConfigNR-List SEQUENCE (SIZE (1..maxNrofQuantityConfig)) OF QuantityConfigNR {	1 entry		
QuantityConfigNR[1] SEQUENCE {		entry 1	
quantityConfigCell SEQUENCE {			
ssb-FilterConfig SEQUENCE {			
filterCoefficientRSRP	fc4		
filterCoefficientRSRQ	fc4		
filterCoefficientRS-SINR	fc4		
}			
}			
}			
}			
}			

Table 8.1.3.1.1.3.3-7: MeasurementReport (steps 3, 4, 7, 8, 17, Table 8.1.3.1.1.3.2-3)

Derivation Path: TS 38.508-1 [4], Table 4.6.1-5A			
Information Element	Value/remark	Comment	Condition
MeasurementReport ::= SEQUENCE {			
criticalExtensions CHOICE {			
measurementReport SEQUENCE {			
measResults SEQUENCE {			
measId	2		Step 3, 4
measId	1		Step 7,8,17
measResultServingMOList SEQUENCE {	1 entry		
servCellId	ServCellIndex of NR Cell 1		
measResultServingCell SEQUENCE {			
physCellId	Physical CellID of the NR Cell 1		
measResult SEQUENCE {			
cellResults SEQUENCE {			
resultsSSB-Cell SEQUENCE {			
rsrp	(0..127)		
rsrq	(0..127)		
sinr	Not present		
sinr	(0..127)		pc_ss_SINR_Meas
}			
}			
}			
}			
}			
}			

Table 8.1.3.1.1.3.3-8: RRCReconfiguration (step 12, Table 8.1.3.1.1.3.2-3)

Derivation Path: TS 38.508-1 [4], Table 4.6.1-13 with condition NR_MEAS

Table 8.1.3.1.1.3.3-9: MeasConfig (Table 8.1.3.1.1.3.3-8)

Derivation path: 38.508-1 [4] Table 4.6.3-69			
Information Element	Value/Remark	Comment	Condition
measConfig ::= SEQUENCE {			
measObjectToAddModList	Not Present		
reportConfigToAddModList SEQUENCE (SIZE (1..maxReportConfigId)) OF ReportConfigToAddMod {	1 entry		
ReportConfigToAddMod[1] SEQUENCE {		entry 1	
reportConfigId	ReportConfigId		
reportConfig	ReportConfigNR-EventA1		
}			
}			
measIdToAddModList	Not Present		
measIdToRemoveList SEQUENCE (SIZE (1..maxNrofMeasId)) OF MeasId {	1 entry		
MeasId[1]	2	entry 1 Release event A2	
}			
quantityConfig	Not Present		
}			

Table 8.1.3.1.1.3.3-10: ReportConfigNR-EventA1 (Table 8.1.3.1.1.3.3-9)

Derivation Path: 38.508-1 [4], Table 4.6.3-142 with condition EVENT_A1			
Information Element	Value/remark	Comment	Condition
ReportConfigNR ::= SEQUENCE {			
reportType CHOICE {			
eventTriggered SEQUENCE {			
eventId CHOICE {			
eventA1 SEQUENCE {			
a1-Threshold CHOICE {			
rsrp	69	-88dBm ≤ SS-RSRP <- 87dBm	FR1
rsrp	FFS		FR2
}			
reportOnLeave	true		
}			
}			
reportAmount	r4		
}			
}			

8.1.3.1.2 Measurement configuration control and reporting / Event A3 / Measurement of Neighbor NR cell / Intra-frequency measurements

8.1.3.1.2.1 Test Purpose (TP)

(1)

```
with { UE in NR RRC_CONNECTED state and intra-frequency measurements configured for event A3 }
ensure that {
  when { Entry condition for event A3 is not met for neighbor cell }
  then { UE does not send MeasurementReport }
}
```

(2)

```
with { UE in NR RRC_CONNECTED state and intra-frequency measurements configured for event A3 }
ensure that {
```



```

when { Neighbor cell becomes offset better than serving cell }
  then { UE sends MeasurementReport with correct measId for event A3 }

```

8.1.3.1.2.2 Conformance requirements

References: The conformance requirements covered in the current TC are specified in: TS 38.331, clause 5.3.5.3, 5.5.2, 5.5.4.1, 5.5.4.4 and 5.5.5. Unless otherwise stated these are Rel-15 requirements.

[TS 38.331, clause 5.3.5.3]

The UE shall perform the following actions upon reception of the *RRCReconfiguration*:

...

1> if the *RRCReconfiguration* message includes the *measConfig*:

2> perform the measurement configuration procedure as specified in 5.5.2;

...

1> if the UE is configured with E-UTRA *nr-SecondaryCellGroupConfig* (MCG is E-UTRA):

...

1> else:

2> submit the *RRCReconfigurationComplete* message via SRB1 to lower layers for transmission using the new configuration;

...

[TS 38.331, clause 5.5.2.1]

...

The UE shall:

...

1> if the received *measConfig* includes the *measObjectToAddModList*:

2> perform the measurement object addition/modification procedure as specified in 5.5.2.5;

...

1> if the received *measConfig* includes the *reportConfigToAddModList*:

2> perform the reporting configuration addition/modification procedure as specified in 5.5.2.7;

1> if the received *measConfig* includes the *quantityConfig*:

2> perform the quantity configuration procedure as specified in 5.5.2.8;

[TS 38.331, clause 5.5.4.1]

If security has been activated successfully, the UE shall:

1> for each *measId* included in the *measIdList* within *VarMeasConfig*:

2> if the corresponding *reportConfig* includes a *reportType* set to *eventTriggered* or *periodical*;

3> if the corresponding *measObject* concerns NR;

4> if the *eventA3* or *eventA5* is configured in the corresponding *reportConfig*:

5> if a serving cell is associated with a *measObjectNR* and neighbors are associated with another *measObjectNR*, consider any serving cell associated with the other *measObjectNR* to be a neighboring cell as well;

...

- 2> if the *reportType* is set to *eventTriggered* and if the entry condition applicable for this event, i.e. the event corresponding with the *eventId* of the corresponding *reportConfig* within *VarMeasConfig*, is fulfilled for one or more applicable cells for all measurements after layer 3 filtering taken during *timeToTrigger* defined for this event within the *VarMeasConfig*, while the *VarMeasReportList* does not include a measurement reporting entry for this *measId* (a first cell triggers the event):
 - 3> include a measurement reporting entry within the *VarMeasReportList* for this *measId*;
 - 3> set the *numberOfReportsSent* defined within the *VarMeasReportList* for this *measId* to 0;
 - 3> include the concerned cell(s) in the *cellsTriggeredList* defined within the *VarMeasReportList* for this *measId*;
 - 3> initiate the measurement reporting procedure, as specified in 5.5.5;

[TS 38.331, clause 5.5.4.4]

The UE shall:

- 1> consider the entering condition for this event to be satisfied when condition A3-1, as specified below, is fulfilled;
- 1> consider the leaving condition for this event to be satisfied when condition A3-2, as specified below, is fulfilled;
- 1> use the SpCell for *Mp*, *Ofp* and *Ocp*.

NOTE The cell(s) that triggers the event has reference signals indicated in the *measObjectNR* associated to this event which may be different from the NR SpCell *measObjectNR*.

Inequality A3-1 (Entering condition)

$$Mn + Ofn + Ocn - Hys > Mp + Ofp + Ocp + Off$$

Inequality A3-2 (Leaving condition)

$$Mn + Ofn + Ocn + Hys < Mp + Ofp + Ocp + Off$$

The variables in the formula are defined as follows:

Mn is the measurement result of the neighboring cell, not taking into account any offsets.

Ofn is the measurement object specific offset of the reference signal of the neighbor cell (i.e. *offsetMO* as defined within *measObjectNR* corresponding to the neighbor cell).

Ocn is the cell specific offset of the neighbor cell (i.e. *cellIndividualOffset* as defined within *measObjectNR* corresponding to the frequency of the neighbor cell), and set to zero if not configured for the neighbor cell.

Mp is the measurement result of the SpCell, not taking into account any offsets.

Ofp is the measurement object specific offset of the SpCell (i.e. *offsetMO* as defined within *measObjectNR* corresponding to the SpCell).

Ocp is the cell specific offset of the SpCell (i.e. *cellIndividualOffset* as defined within *measObjectNR* corresponding to the SpCell), and is set to zero if not configured for the SpCell.

Hys is the hysteresis parameter for this event (i.e. *hysteresis* as defined within *reportConfigNR* for this event).

Off is the offset parameter for this event (i.e. *a3-Offset* as defined within *reportConfigNR* for this event).

Mn*, *Mp are expressed in dBm in case of RSRP, or in dB in case of RSRQ and RS-SINR.

Ofn*, *Ocn*, *Ofp*, *Ocp*, *Hys*, *Off are expressed in dB.

[TS 38.331, clause 5.5.5]



Figure 5.5.5.1-1: Measurement reporting

The purpose of this procedure is to transfer measurement results from the UE to the network. The UE shall initiate this procedure only after successful security activation.

For the *measId* for which the measurement reporting procedure was triggered, the UE shall set the *measResults* within the *MeasurementReport* message as follows:

- 1> set the *measId* to the measurement identity that triggered the measurement reporting;
- 1> set the *measResultServingCell* within *measResultServingMOList* to include, for each NR serving cell that is configured with *servingCellMO*, RSRP, RSRQ and the available SINR, derived based on the *rsType* if indicated in the associated *reportConfig*, otherwise based on SSB if available, otherwise based on CSI-RS;
- 1> set the *servCellId* within *measResultServingMOList* to include each NR serving cell that is configured with *servingCellMO*, if any;
- ...
- 1> if the *numberOfReportsSent* as defined within the *VarMeasReportList* for this *measId* is less than the *reportAmount* as defined within the corresponding *reportConfig* for this *measId*:
 - 2> start the periodical reporting timer with the value of *reportInterval* as defined within the corresponding *reportConfig* for this *measId*;
- 1> if there is at least one applicable neighboring cell to report:
 - 2> if the *reportType* is set to *eventTriggered* or *periodical*:
 - 3> set the *measResultNeighCells* to include the best neighboring cells up to *maxReportCells* in accordance with the following:
 - 4> if the *reportType* is set to *eventTriggered*:
 - 5> include the cells included in the *cellsTriggeredList* as defined within the *VarMeasReportList* for this *measId*;
 - 4> for each cell that is included in the *measResultNeighCells*, include the *physCellId*;
 - 4> if the *reportType* is set to *eventTriggered* or *periodical*:
 - 5> for each included cell, include the layer 3 filtered measured results in accordance with the *reportConfig* for this *measId*, ordered as follows:
 - 6> if the *measObject* associated with this *measId* concerns NR:
 - 7> if *rsType* in the associated *reportConfig* is set to *ssb*:
 - 8> set *resultsSSB-Cell* within the *measResult* to include the SS/PBCH block based quantity(ies) indicated in the *reportQuantityCell* within the concerned *reportConfig*, in decreasing order of the sorting quantity, determined as specified in 5.5.5.3, i.e. the best cell is included first;

8.1.3.1.2.3 Test description

8.1.3.1.2.3.1 Pre-test conditions

System Simulator:

- NR Cell 1 is the serving cell.
- NR Cell 2 is the intra-frequency neighbor cell.
- System information combination NR-2 as defined in TS 38.508-1 [4] clause 4.4.3.1.2 is used in NR cells.

UE:

- None.

Preamble:

- The UE is in state 3N-A as defined in TS 38.508-1 [4], subclause 4.4A.

8.1.3.1.2.3.2 Test procedure sequence

Table 8.1.3.1.2.3.2-1 and 8.1.3.1.2.3.2-2 illustrates the downlink power levels to be applied for NR Cell 1 and NR Cell 2 at various time instants of the test execution. Row marked "T0" denotes the conditions after the preamble, while the configuration marked "T1" and "T2", are applied at the point indicated in the Main behaviour description in Table 8.1.3.1.2.3.2-3.

Table 8.1.3.1.2.3.2-1: Time instances of cell power level and parameter changes for NR Cell 1 and NR Cell 2 in FR1

	Parameter	Unit	NR Cell 1	NR Cell 2	Remark
T0	SS/PBCH SSS EPRE	dBm/ SCS	-85	-91	Power levels are such that entry condition for event A3 is not satisfied for the neighbour NR cell: $Mn + Ofn + Ocn - Hys > Mp + Ofp + Ocp + Off$
T1	SS/PBCH SSS EPRE	dBm/ SCS	-85	-79	Power levels are such that entry condition for event A3 is satisfied for intra-frequency neighbour NR cell (measId 1): $Mn + Ofn + Ocn - Hys > Mp + Ofp + Ocp + Off$
T2	SS/PBCH SSS EPRE	dBm/ SCS	-85	-91	Power levels are such that leaving condition for event A3 is satisfied (measId 1): $Mn + Ofn + Ocn + Hys < Mp + Ofp + Ocp + Off$

Table 8.1.3.1.2.3.2-2: Time instances of cell power level and parameter changes for NR Cell 1 and NR Cell 2 in FR2

	Parameter	Unit	NR Cell 1	NR Cell 2	Remark
T0	SS/PBCH SSS EPRE	dBm/ SCS	FFS	FFS	Power levels are such that entry condition for event A3 is not satisfied for the neighbour NR cell: $Mn + Ofn + Ocn - Hys > Mp + Ofp + Ocp + Off$
T1	SS/PBCH SSS EPRE	dBm/ SCS	FFS	FFS	Power levels are such that entry condition for event A3 is satisfied for intra-frequency neighbour NR cell (measId 1): $Mn + Ofn + Ocn - Hys > Mp + Ofp + Ocp + Off$
T2	SS/PBCH SSS EPRE	dBm/ SCS	FFS	FFS	Power levels are such that leaving condition for event A3 is satisfied (measId 1): $Mn + Ofn + Ocn + Hys < Mp + Ofp + Ocp + Off$

Table 8.1.3.1.2.3.2-3: Main behaviour

St	Procedure	Message Sequence		TP	Verdict
		U - S	Message		
1	The SS transmits an <i>RRCReconfiguration</i> message including <i>MeasConfig</i> to setup NR measurement and reporting for intra-frequency event A3 (<i>measId</i> 1).	<--	NR RRC: <i>RRCReconfiguration</i>	-	-
2	The UE transmits an <i>RRCReconfigurationComplete</i> message.	-->	NR RRC: <i>RRCReconfigurationComplete</i>	-	-
3	SS re-adjusts the cell-specific reference signal level according to row "T1" in table 8.1.3.1.2.3.2-1/2.	-	-	-	-
4	Check: Does the UE transmit a <i>MeasurementReport</i> message to report event A3 (<i>measId</i> 1) with the measured RSRP value for NR Cell 2?	-->	NR RRC: <i>MeasurementReport</i>	2	P
5A	Wait and ignore <i>MeasurementReport</i> messages for 10s to allow change of power levels for NR Cell 2 and UE measurement				
5	SS re-adjusts the cell-specific reference signal level according to row "T2" in table 8.1.3.1.2.2-1/2.	-	-	-	-
6	Check: Does the UE transmit a <i>MeasurementReport</i> message within the next 10s?	-	-	1	F

8.1.3.1.2.3.3 Specific message contents

Table 8.1.3.1.2.3.3-1: *RRCReconfiguration* (step 1, Table 8.1.3.1.2.3.2-3)

Derivation Path: 38.508-1 [4] Table 4.6.1-13 with condition NR_MEAS

Table 8.1.3.1.2.3.3-2: MeasConfig (Table 8.1.3.1.2.3.3-1)

Derivation Path: 38.508-1 [4] Table 4.6.3-69			
Information Element	Value/remark	Comment	Condition
MeasConfig ::= SEQUENCE {			
measObjectToAddModList SEQUENCE (SIZE (1..maxNrofMeasId)) OF MeasObjectToAddMod {	1 entry		
MeasObjectToAddMod[1] SEQUENCE {		entry 1	
measObjectId	1		
measObject CHOICE {			
measObjectNR	MeasObjectNR	Table 8.1.3.1.2.3.3-3	
}			
}			
}			
reportConfigToAddModList SEQUENCE(SIZE (1..maxReportConfigId)) OF ReportConfigToAddMod {	1 entry		
ReportConfigToAddMod[1] SEQUENCE {		entry 1	
reportConfigId	1		
reportConfig CHOICE {			
reportConfigNR	ReportConfigNR-EventA3	Table 8.1.3.1.2.3.3-4	
}			
}			
}			
measIdToAddModList SEQUENCE (SIZE (1..maxNrofMeasId)) OF MeasIdToAddMod {	1 entry		
MeasIdToAddMod[1] SEQUENCE {		entry 1	
measId	1		
measObjectId	1		
reportConfigId	1		
}			
}			
}			

Table 8.1.3.1.2.3.3-3: MeasObjectNR (Table 8.1.3.1.2.3.3-2)

Derivation Path: TS 38.508-1 [4], Table 4.6.3-76			
Information Element	Value/remark	Comment	Condition
MeasObjectNR ::= SEQUENCE {			
ssbFrequency	ARFCN-ValueNR for SSB of NR Cell 1		
absThreshSS-BlocksConsolidation	Not present		
nrofSS-BlocksToAverage	Not present		
}			

Table 8.1.3.1.2.3.3-4: ReportConfigNR-EventA3 (Table 8.1.3.1.2.3.3-2)

Derivation Path: 38.508-1 [4] Table 4.6.3-142 with condition EVENT_A3			
Information Element	Value/remark	Comment	Condition
ReportConfigNR ::= SEQUENCE {			
reportType CHOICE {			
eventTriggered SEQUENCE {			
eventId CHOICE {			
eventA3 SEQUENCE {			
a3-Offset CHOICE {			
rsrp	2	1 dB (2*0.5 dB)	FR1
	FFS		FR2
}			
}			
}			
reportAmount	infinity		
reportQuantityCell SEQUENCE {			
rsrp	true		
rsrq	false		
sinr	false		
}			
}			
}			

Table 8.1.3.1.2.3.3-5: *MeasurementReport* (step 4, Table 8.1.3.1.2.3.2-3)

Derivation Path: 38.508-1 [4] Table 4.6.1-5A			
Information Element	Value/remark	Comment	Condition
MeasurementReport ::= SEQUENCE {			
criticalExtensions CHOICE {			
measurementReport SEQUENCE {			
measResults SEQUENCE {			
measId	1		
measResultServingMOList SEQUENCE (SIZE (1..maxNrofServingCells)) OF MeasResultServMO {	1 entry	Measurement report for NR Cell 1	
MeasResultServMO[1] SEQUENCE {		entry 1	
servCellId	ServCellIndex of NR Cell 1		
measResultServingCell SEQUENCE {			
physCellId	PCI of NR Cell 1		
measResult SEQUENCE {			
cellResults SEQUENCE {			
resultsSSB-Cell SEQUENCE {			
rsrp	(0..127)		
rsrq	(0..127)		
sinr	Not present		
}			
}			
}			
}			
}			
}			
measResultNeighCells CHOICE {			
measResultListNR SEQUENCE (SIZE (1..maxCellReport)) OF MeasResultNR {	1 entry	Measurement report for NR Cell 2	
MeasResultNR[1] SEQUENCE {		entry 1	
physCellId	Physical layer cell identity of NR Cell 2		
measResult SEQUENCE {			
cellResults SEQUENCE {			
resultsSSB-Cell SEQUENCE {			
rsrp	(0..127)		
rsrq	Not present		
sinr	Not present		
}			
resultsCSI-RS-Cell	Not present		
}			
rsIndexResults	Not present		
}			
cgi-Info	Not present		
}			
}			
}			
}			
}			
}			

8.1.3.1.3 Measurement configuration control and reporting / Event A3 / Measurement of Neighbour NR cell / Inter-frequency measurements

8.1.3.1.3.1 Test Purpose (TP)

(1)

with { UE in NR RRC_CONNECTED state and inter-frequency measurements configured for event A3 }

```

ensure that {
  when { Entry condition for event A3 is not met for neighbour cell }
  then { UE does not send MeasurementReport }
}

```

(2)

```

with { UE in NR RRC_CONNECTED state and inter-frequency measurements configured for event A3 }
ensure that {
  when { Neighbour cell becomes offset better than serving cell }
  then { UE sends MeasurementReport with correct measId for event A3 }
}

```

8.1.3.1.3.2 Conformance requirements

Same as test case 8.1.3.1.2 with the following difference:

[TS 38.331, clause 5.5.2.9]

The UE shall:

...

- 1> if *gapUE* is set to *setup*:
 - 2> if a per UE measurement gap configuration is already setup, release the per UE measurement gap configuration;
 - 2> setup the per UE measurement gap configuration indicated by the *measGapConfig* in accordance with the received *gapOffset*, i.e., the first subframe of each gap occurs at an SFN and subframe meeting the following condition:

$$\text{SFN mod } T = \text{FLOOR}(\text{gapOffset}/10);$$

$$\text{subframe} = \text{gapOffset mod } 10;$$
 with $T = \text{MGRP}/10$ as defined in TS 38.133 [14];
 - 2> if *mgta* is configured, apply the specified timing advance to the gap occurrences calculated above (i.e. the UE starts the measurement *mgta* ms before the gap subframe occurrences);

...

8.1.3.1.3.3 Test description

8.1.3.1.3.3.1 Pre-test conditions

Same as test case 8.1.3.1.2 with the following differences:

- Cells configuration: NR Cell 3 replaces NR Cell 2.
- System information combination: NR-4 replaces NR-2.

8.1.3.1.3.3.2 Test procedure sequence

Same as test case 8.1.3.1.2 with the following differences:

- Cells configuration: NR Cell 3 replaces NR Cell 2.

8.1.3.1.3.3.3 Specific message contents

Same as test case 8.1.3.1.2 with the following difference:

- Cells configuration: NR Cell 3 replaces NR Cell 2.

Table 8.1.3.1.3.3.3-1: MeasConfig (Table 8.1.3.1.2.3.3-1)

Derivation Path: 38.508-1 [4] Table 4.6.3-69			
Information Element	Value/remark	Comment	Condition
MeasConfig ::= SEQUENCE {			
measObjectToAddModList SEQUENCE (SIZE (1..maxNrofMeasId)) OF MeasObjectToAddMod {	2 entries		
MeasObjectToAddMod[1] SEQUENCE {		entry 1	
measObjectId	1		
measObject CHOICE {			
measObjectNR	MeasObjectNR-f1	Table 8.1.3.1.3.3.3-2	
}			
}			
MeasObjectToAddMod[2] SEQUENCE {		entry 2	
measObjectId	2		
measObject CHOICE {			
measObjectNR	MeasObjectNR-f2	Table 8.1.3.1.3.3.3-3	
}			
}			
reportConfigToAddModList SEQUENCE(SIZE (1..maxReportConfigId)) OF ReportConfigToAddMod {	1 entry		
ReportConfigToAddMod[1] SEQUENCE {		entry 1	
reportConfigId	1		
reportConfig CHOICE {			
reportConfigNR	ReportConfigNR-EventA3	Table 8.1.3.1.2.3.3-4	
}			
}			
measIdToAddModList SEQUENCE (SIZE (1..maxNrofMeasId)) OF MeasIdToAddMod {	1 entry		
MeasIdToAddMod[1] SEQUENCE {		entry 1	
measId	1		
measObjectId	2		
reportConfigId	1		
}			
}			
measGapConfig	MeasGapConfig		
}			

Table 8.1.3.1.3.3.3-2: MeasObjectNR-f1 (Table 8.1.3.1.3.3.3-1)

Derivation Path: TS 38.508-1 [4], Table 4.6.3-76			
Information Element	Value/remark	Comment	Condition
MeasObjectNR ::= SEQUENCE {			
ssbFrequency	ARFCN-ValueNR for SSB of NR Cell 1		
absThreshSS-BlocksConsolidation	Not present		
nrofSS-BlocksToAverage	Not present		
}			

Table 8.1.3.1.3.3.3-3: MeasObjectNR-f2 (Table 8.1.3.1.3.3.3-1)

Derivation Path: TS 38.508-1 [4], Table 4.6.3-76			
Information Element	Value/remark	Comment	Condition
MeasObjectNR ::= SEQUENCE {			
ssbFrequency	ARFCN-ValueNR for SSB of NR Cell 3		
absThreshSS-BlocksConsolidation	Not present		
nrofSS-BlocksToAverage	Not present		
}			

8.1.3.1.4 Measurement configuration control and reporting / Event A3 / Measurement of Neighbour NR cell / Inter-band measurements

8.1.3.1.4.1 Test Purpose (TP)

(1)

```
with { UE in NR RRC_CONNECTED state and inter-band measurements configured for event A3 }
ensure that {
  when { Entry condition for event A3 is not met for neighbour cell }
  then { UE does not send MeasurementReport }
}
```

(2)

```
with { UE in NR RRC_CONNECTED state and inter-band measurements configured for event A3 }
ensure that {
  when { Neighbour cell becomes offset better than serving cell }
  then { UE sends MeasurementReport with correct measId for event A3 }
}
```

8.1.3.1.4.2 Conformance requirements

Same as test case 8.1.3.1.2 with the following difference:

[TS 38.331, clause 5.5.2.9]

The UE shall:

...

1> if *gapUE* is set to *setup*:

2> if a per UE measurement gap configuration is already setup, release the per UE measurement gap configuration;

2> setup the per UE measurement gap configuration indicated by the *measGapConfig* in accordance with the received *gapOffset*, i.e., the first subframe of each gap occurs at an SFN and subframe meeting the following condition:

SFN mod $T = \text{FLOOR}(\text{gapOffset}/10)$;

subframe = $\text{gapOffset} \bmod 10$;

with $T = \text{MGRP}/10$ as defined in TS 38.133 [14];

2> if *mgta* is configured, apply the specified timing advance to the gap occurrences calculated above (i.e. the UE starts the measurement *mgta* ms before the gap subframe occurrences);

...

8.1.3.1.4.3 Test description

8.1.3.1.4.3.1 Pre-test conditions

Same as test case 8.1.3.1.2 with the following differences:

- Cells configuration: NR Cell 10 replaces NR Cell 2.
- System information combination: NR-4 replaces NR-2.

8.1.3.1.4.3.2 Test procedure sequence

Same as test case 8.1.3.1.2 with the following differences:

- Cells configuration: NR Cell 10 replaces NR Cell 2.

Specific message contents

Same as test case 8.1.3.1.222 with the following difference:

- Cells configuration: NR Cell 10 replaces NR Cell 2.

Table 8.1.3.1.4.3.3-1: MeasConfig (Table 8.1.3.1.2.3.3-1)

Derivation Path: 38.508-1 [4] Table 4.6.3-69			
Information Element	Value/remark	Comment	Condition
MeasConfig ::= SEQUENCE {			
measObjectToAddModList SEQUENCE (SIZE (1..maxNrofMeasId)) OF MeasObjectToAddMod {	2 entries		
MeasObjectToAddMod[1] SEQUENCE {		entry 1	
measObjectId	1		
measObject CHOICE {			
measObjectNR	MeasObjectNR-f1	Table 8.1.3.1.4.3.3-2	
}			
}			
MeasObjectToAddMod[2] SEQUENCE {		entry 2	
measObjectId	2		
measObject CHOICE {			
measObjectNR	MeasObjectNR-f2	Table 8.1.3.1.4.3.3-3	
}			
}			
}			
reportConfigToAddModList SEQUENCE(SIZE (1..maxReportConfigId)) OF ReportConfigToAddMod {	1 entry		
ReportConfigToAddMod[1] SEQUENCE {		entry 1	
reportConfigId	1		
reportConfig CHOICE {			
reportConfigNR	ReportConfigNR-EventA3	Table 8.1.3.1.2.3.3-4	
}			
}			
}			
measIdToAddModList SEQUENCE (SIZE (1..maxNrofMeasId)) OF MeasIdToAddMod {	1 entry		
MeasIdToAddMod[1] SEQUENCE {		entry 1	
measId	1		
measObjectId	2		
reportConfigId	1		
}			
}			
measGapConfig	MeasGapConfig		
}			

Table 8.1.3.1.4.3.3-2: MeasObjectNR-f1 (Table 8.1.3.1.4.3.3-1)

Derivation Path: TS 38.508-1 [4], Table 4.6.3-76			
Information Element	Value/remark	Comment	Condition
MeasObjectNR ::= SEQUENCE {			
ssbFrequency	ARFCN-ValueNR for SSB of NR Cell 1		
absThreshSS-BlocksConsolidation	Not present		
nrofSS-BlocksToAverage	Not present		
}			

Table 8.1.3.1.4.3.3-3: MeasObjectNR-f2 (Table 8.1.3.1.4.3.3-1)

Derivation Path: TS 38.508-1 [4], Table 4.6.3-76			
Information Element	Value/remark	Comment	Condition
MeasObjectNR ::= SEQUENCE {			
ssbFrequency	ARFCN-ValueNR for SSB of NR Cell 10		
absThreshSS-BlocksConsolidation	Not present		
nrofSS-BlocksToAverage	Not present		
}			

8.1.3.1.5 Measurement configuration control and reporting / Event A4 / Measurement of Neighbour NR cell / Intra-frequency measurements

8.1.3.1.5.1 Test Purpose (TP)

(1)

```
with { UE in NR RRC_CONNECTED state and intra-frequency measurements configured for event A4 with
event based periodical reporting }
ensure that {
  when { Neighbour cell becomes better than absolute threshold }
  then { UE sends MeasurementReport message at regular intervals while entering condition for
event A4 is satisfied }
}
```

(2)

```
with { UE in NR RRC_CONNECTED state and periodical measurement reporting triggered by event A4
ongoing }
ensure that {
  when { Neighbour cell becomes worse than absolute threshold }
  then { UE stops sending MeasurementReport message }
}
```

8.1.3.1.5.2 Conformance requirements

References: The conformance requirements covered in the current TC are specified in: TS 38.331, clauses 5.3.5.3, 5.5.2.1, 5.5.4.1, 5.5.4.5 and 5.5.5.1. Unless otherwise stated these are Rel-15 requirements.

[TS 38.331, clause 5.3.5.3]

The UE shall perform the following actions upon reception of the *RRCReconfiguration*:

...

1> if the *RRCReconfiguration* message includes the *measConfig*:

2> perform the measurement configuration procedure as specified in 5.5.2;

...

1> if the UE is configured with E-UTRA *nr-SecondaryCellGroupConfig* (MCG is E-UTRA):

...

1> else:

- 2> submit the *RRCReconfigurationComplete* message via SRB1 to lower layers for transmission using the new configuration;

...

[TS 38.331, clause 5.5.2.1]

...

The UE shall:

...

1> if the received *measConfig* includes the *measObjectToAddModList*:

- 2> perform the measurement object addition/modification procedure as specified in 5.5.2.5;

...

1> if the received *measConfig* includes the *reportConfigToAddModList*:

- 2> perform the reporting configuration addition/modification procedure as specified in 5.5.2.7;

...

1> if the received *measConfig* includes the *measIdToAddModList*:

- 2> perform the measurement identity addition/modification procedure as specified in 5.5.2.3;

...

[TS 38.331, clause 5.5.4.1]

If AS security has been activated successfully, the UE shall:

1> for each *measId* included in the *measIdList* within *VarMeasConfig*:

- 2> if the corresponding *reportConfig* includes a *reportType* set to *eventTriggered* or *periodical*;

- 3> if the corresponding *measObject* concerns NR;

...

- 4> for measurement events other than *eventA1* or *eventA2*:

...

5> else:

- 6> consider any neighbouring cell detected based on parameters in the associated *measObjectNR* to be applicable when the concerned cell is not included in the *blackCellsToAddModList* defined within the *VarMeasConfig* for this *measId*;

...

- 4> if the *eventA1* or *eventA2* is configured in the corresponding *reportConfig*;

...

4> else:

- 5> for events involving a serving cell associated with a *measObjectNR* and neighbours associated with another *measObjectNR*, consider any serving cell associated with the other *measObjectNR* to be a neighbouring cell as well;

...

- 2> if the *reportType* is set to *eventTriggered* and if the entry condition applicable for this event, i.e. the event corresponding with the *eventId* of the corresponding *reportConfig* within *VarMeasConfig*, is fulfilled for one or more applicable cells for all measurements after layer 3 filtering taken during *timeToTrigger* defined for this event within the *VarMeasConfig*, while the *VarMeasReportList* does not include a measurement reporting entry for this *measId* (a first cell triggers the event):
 - 3> include a measurement reporting entry within the *VarMeasReportList* for this *measId*;
 - 3> set the *numberOfReportsSent* defined within the *VarMeasReportList* for this *measId* to 0;
 - 3> include the concerned cell(s) in the *cellsTriggeredList* defined within the *VarMeasReportList* for this *measId*;
 - 3> initiate the measurement reporting procedure, as specified in 5.5.5;
- 2> else if the *reportType* is set to *eventTriggered* and if the entry condition applicable for this event, i.e. the event corresponding with the *eventId* of the corresponding *reportConfig* within *VarMeasConfig*, is fulfilled for one or more applicable cells not included in the *cellsTriggeredList* for all measurements after layer 3 filtering taken during *timeToTrigger* defined for this event within the *VarMeasConfig* (a subsequent cell triggers the event):
 - 3> set the *numberOfReportsSent* defined within the *VarMeasReportList* for this *measId* to 0;
 - 3> include the concerned cell(s) in the *cellsTriggeredList* defined within the *VarMeasReportList* for this *measId*;
 - 3> initiate the measurement reporting procedure, as specified in 5.5.5;
- 2> else if the *reportType* is set to *eventTriggered* and if the leaving condition applicable for this event is fulfilled for one or more of the cells included in the *cellsTriggeredList* defined within the *VarMeasReportList* for this *measId* for all measurements after layer 3 filtering taken during *timeToTrigger* defined within the *VarMeasConfig* for this event:
 - 3> remove the concerned cell(s) in the *cellsTriggeredList* defined within the *VarMeasReportList* for this *measId*;
- ...
- 3> if *reportOnLeave* is set to *TRUE* for the corresponding reporting configuration:
 - 4> initiate the measurement reporting procedure, as specified in 5.5.5;
- 3> if the *cellsTriggeredList* defined within the *VarMeasReportList* for this *measId* is empty:
 - 4> remove the measurement reporting entry within the *VarMeasReportList* for this *measId*;
 - 4> stop the periodical reporting timer for this *measId*, if running;
- ...
- 2> upon expiry of the periodical reporting timer for this *measId*:
 - 3> initiate the measurement reporting procedure, as specified in 5.5.5.
- ...

[TS 38.331, clause 5.5.4.5]

The UE shall:

- 1> consider the entering condition for this event to be satisfied when condition A4-1, as specified below, is fulfilled;
- 1> consider the leaving condition for this event to be satisfied when condition A4-2, as specified below, is fulfilled.

Inequality A4-1 (Entering condition)

$$Mn + Ofn + Ocn - Hys > Thresh$$

Inequality A4-2 (Leaving condition)

$$Mn + Ofn + Ocn + Hys < Thresh$$

The variables in the formula are defined as follows:

Mn is the measurement result of the neighbouring cell, not taking into account any offsets.

Ofn is the measurement object specific offset of the neighbour cell (i.e. *offsetMO* as defined within *measObjectNR* corresponding to the neighbour cell).

Ocn is the measurement object specific offset of the neighbour cell (i.e. *cellIndividualOffset* as defined within *measObjectNR* corresponding to the neighbour cell), and set to zero if not configured for the neighbour cell.

Hys is the hysteresis parameter for this event (i.e. *hysteresis* as defined within *reportConfigNR* for this event).

Thresh is the threshold parameter for this event (i.e. *a4-Threshold* as defined within *reportConfigNR* for this event).

Mn is expressed in dBm in case of RSRP, or in dB in case of RSRQ and RS-SINR.

Ofn, Ocn, Hys are expressed in dB.

Thresh is expressed in the same unit as ***Mn***.

[TS 38.331, clause 5.5.5.1]



Figure 5.5.5-1: Measurement reporting

The purpose of this procedure is to transfer measurement results from the UE to the network. The UE shall initiate this procedure only after successful AS security activation.

For the *measId* for which the measurement reporting procedure was triggered, the UE shall set the *measResults* within the *MeasurementReport* message as follows:

- 1> set the *measId* to the measurement identity that triggered the measurement reporting;
- 1> set the *measResultServingCell* within *measResultServingMOList* to include RSRP, RSRQ and the available SINR for each configured serving cell derived based on the *rsType* indicated in the associated *reportConfig*;
- 1> set the *measResultServingCell* within *measResultServingMOList* to include for each NR serving cell that is configured with *servingCellMO*, if any, the *servCellId*;
- ...
- 1> if there is at least one applicable neighbouring cell to report:
 - 2> if the *reportType* is set to *eventTriggered* or *periodical*:
 - 3> set the *measResultNeighCells* to include the best neighbouring cells up to *maxReportCells* in accordance with the following:
 - 4> if the *reportType* is set to *eventTriggered*:
 - 5> include the cells included in the *cellsTriggeredList* as defined within the *VarMeasReportList* for this *measId*;

...

4> for each cell that is included in the *measResultNeighCells*, include the *physCellId*;

4> if the *reportType* is set to *eventTriggered* or *periodical*:

5> for each included cell, include the layer 3 filtered measured results in accordance with the *reportConfig* for this *measId*, ordered as follows:

6> if the *measObject* associated with this *measId* concerns NR:

7> if *rsType* in the associated *reportConfig* is set to *ssb*:

8> set *resultsSSB-Cell* within the *measResult* to include the SS/PBCH block based quantity(ies) indicated in the *reportQuantityCell* within the concerned *reportConfig*, in decreasing order of the sorting quantity, determined as specified in 5.5.5.3, i.e. the best cell is included first;

...

2> set the *measResultNeighCells* to include the best neighbouring cells up to *maxReportCells* in accordance with the following:

3> if the *reportType* is set to *eventTriggered*:

4> include the cells included in the *cellsTriggeredList* as defined within the *VarMeasReportList* for this *measId*;

...

3> for each cell that is included in the *measResultNeighCells*, include the *physCellId*;

3> if the *reportType* is set to *eventTriggered*:

4> for each included cell, include the layer 3 filtered measured results in accordance with the *reportConfig* for this *measId*, ordered as follows:

5> if the *measObject* associated with this *measId* concerns NR:

6> if *rsType* in the associated *reportConfig* is set to *ssb*:

7> set *resultsSSB-Cell* within the *measResult* to include the SS/PBCH block based quantity(ies) indicated in the *reportQuantityCell* within the concerned *reportConfig*, in order of decreasing trigger quantity, i.e. the best cell is included first:

...

1> increment the *numberOfReportsSent* as defined within the *VarMeasReportList* for this *measId* by 1;

1> stop the periodical reporting timer, if running;

1> if the *numberOfReportsSent* as defined within the *VarMeasReportList* for this *measId* is less than the *reportAmount* as defined within the corresponding *reportConfig* for this *measId*:

2> start the periodical reporting timer with the value of *reportInterval* as defined within the corresponding *reportConfig* for this *measId*;

...

...

1> if the UE is configured with EN-DC:

...

1> else:

2> submit the *MeasurementReport* message to lower layers for transmission, upon which the procedure ends.

8.1.3.1.5.3 Test description

8.1.3.1.5.3.1 Pre-test conditions

System Simulator:

- NR Cell 1 is the serving cell, NR Cell 2 is the intra-frequency neighbour cell of NR Cell 1.
- System information combination NR-2 as defined in TS 38.508-1 [4] clause 4.4.3.1.2 is used in NR cells.

UE:

- None.

Preamble:

- The UE is in state 3N-A as defined in TS 38.508-1 [4], subclause 4.4A.

8.1.3.1.5.3.2 Test procedure sequence

Table 8.1.3.1.5.3.2-1 and 8.1.3.1.5.3.2-2 illustrates the downlink power levels to be applied for NR Cell 1 and NR Cell 2 at various time instants of the test execution. Row marked "T0" denotes the conditions after the preamble, while the configuration marked "T1" and "T2", are applied at the point indicated in the Main behaviour description in Table 8.1.3.1.5.3.2-3.

Table 8.1.3.1.5.3.2-1: Time instances of cell power level and parameter changes in FR1

	Parameter	Unit	NR Cell 1	NR Cell 2	Remark
T0	SS/PBCH SSS EPRE	dBm/ SCS	-85	-91	Power levels are such that entry condition for event A4 (measId 1) is not satisfied: $Mn + Ofn + Ocn - Hys \leq Thresh$
T1	SS/PBCH SSS EPRE	dBm/ SCS	-85	-79	Power levels are such that entry condition for event A4 (measId 1) is satisfied: $Mn + Ofn + Ocn - Hys > Thresh$
T2	SS/PBCH SSS EPRE	dBm/ SCS	-85	-93	Power levels are such that leaving condition for event A4 (measId 1) is satisfied: $Mn + Ofn + Ocn + Hys < Thresh$

Table 8.1.3.1.5.3.2-2: Time instances of cell power level and parameter changes in FR2

	Parameter	Unit	NR Cell 1	NR Cell 2	Remark
T0	SS/PBCH SSS EPRE	dBm/ SCS	FFS	FFS	Power levels are such that entry condition for event A4 (measId 1) is not satisfied: $Mn + Ofn + Ocn - Hys \leq Thresh$
T1	SS/PBCH SSS EPRE	dBm/ SCS	FFS	FFS	Power levels are such that entry condition for event A4 (measId 1) is satisfied: $Mn + Ofn + Ocn - Hys > Thresh$
T2	SS/PBCH SSS EPRE	dBm/ SCS	FFS	FFS	Power levels are such that leaving condition for event A4 (measId 1) is satisfied: $Mn + Ofn + Ocn + Hys < Thresh$

Table 8.1.3.1.5.3.2-3: Main behaviour

St	Procedure	Message Sequence		TP	Verdict
		U - S	Message		
1	The SS transmits an <i>RRCReconfiguration</i> message including <i>MeasConfig</i> to setup NR measurement and reporting for intra-frequency event A4 (<i>measId</i> 1).	<--	NR RRC: <i>RRCReconfiguration</i>	-	-
2	The UE transmits an <i>RRCReconfigurationComplete</i> message.	-->	NR RRC: <i>RRCReconfigurationComplete</i>	-	-
3	SS re-adjusts the cell-specific reference signal level according to row "T1" in table 8.1.3.1.5.3.2-1/2.	-	-	-	-
-	EXCEPTION: In parallel to events described in step 4 the steps specified in table 8.1.3.1.5.3.2-4 shall take place	-	-	-	-
4	Wait for 30 seconds to ensure that the UE performs a periodical intra-frequency reporting for NR Cell 2	-	-	1	-
5	SS re-adjusts the cell-specific reference signal level according to row "T2" in table 8.1.3.1.5.3.2-1/2.	-	-	-	-
6	Wait and ignore <i>MeasurementReport</i> messages for 10s to allow change of power levels for NR Cell 2 and UE measurement	-	-	-	-
7	Check: Does the UE transmit a <i>MeasurementReport</i> message within the next 10s?	-->	NR RRC: <i>MeasurementReport</i>	2	F

Table 8.1.3.1.5.3.2-4: Parallel behaviour

St	Procedure	Message Sequence		TP	Verdict
		U - S	Message		
-	EXCEPTION: After the 1st message is received, step 1 below shall be repeated every time the duration indicated in the IE <i>reportInterval</i> has elapsed	-	-	-	-
1	Check: Does the UE transmit a <i>MeasurementReport</i> message to report event A4 (<i>measId</i> 1) with the measured RSRP value for NR Cell 2?	-->	NR RRC: <i>MeasurementReport</i>	1	P

8.1.3.1.5.3.3 Specific message contents

Table 8.1.3.1.5.3.3-1: *RRCReconfiguration* (step 1, Table 8.1.3.1.5.3.2-3)

Derivation Path: 38.508-1 [4] Table 4.6.1-13 with condition NR_MEAS

Table 8.1.3.1.5.3.3-2: MeasConfig (Table 8.1.3.1.5.3.3-1)

Derivation Path: 38.508-1 [4] Table 4.6.3-69			
Information Element	Value/remark	Comment	Condition
MeasConfig ::= SEQUENCE {			
measObjectToAddModList SEQUENCE (SIZE (1..maxNrofMeasId)) OF MeasObjectToAddMod {	1 entry		
MeasObjectToAddMod[1] SEQUENCE {		entry 1	
measObjectId	1	MeasObjectIdNR-f1	
measObject CHOICE {			
measObjectNR SEQUENCE {			
ssbFrequency	ssbFrequency IE equals the ARFCN for NR Cell 2		
absThreshSS-BlocksConsolidation	Not present		
}			
}			
}			
reportConfigToAddModList SEQUENCE(SIZE (1..maxReportConfigId)) OF ReportConfigToAddMod {	1 entry		
ReportConfigToAddMod[1] SEQUENCE {		entry 1	
reportConfigId	1		
reportConfig CHOICE {			
reportConfigNR	ReportConfigNR-EventA4	Table 8.1.3.1.5.3.3-3	
}			
}			
}			
measIdToAddModList SEQUENCE (SIZE (1..maxNrofMeasId)) OF MeasIdToAddMod {	1 entry		
MeasIdToAddMod[1] SEQUENCE {		entry 1	
measId	1		
measObjectId	1		
reportConfigId	1		
}			
}			
}			

Table 8.1.3.1.5.3.3-3: ReportConfigNR-EventA4 (Table 8.1.3.1.5.3.3-2)

Derivation Path: 38.508-1 [4] Table 4.6.3-142 with condition EVENT_A4			
Information Element	Value/remark	Comment	Condition
ReportConfigNR ::= SEQUENCE {			
reportType CHOICE {			
eventTriggered SEQUENCE {			
eventId CHOICE {			
eventA4 SEQUENCE {			
a4-Threshold CHOICE {			
rsrp	70 FFS	-86dBm	FR1 FR2
}			
hysteresis	2	1 dB	
}			
}			
}			
reportAmount	infinity		
reportQuantityCell SEQUENCE {			
rsrp	true		
rsrq	false		
sinr	false		
}			
}			

Table 8.1.3.1.5.3.3-4: *MeasurementReport* (step 1, Table 8.1.3.1.5.3.2-4)

Derivation Path: 38.508-1 [4] Table 4.6.1-5A			
Information Element	Value/remark	Comment	Condition
MeasurementReport ::= SEQUENCE {			
criticalExtensions CHOICE {			
measurementReport SEQUENCE {			
measResults SEQUENCE {			
measId	1		
measResultServingMOList SEQUENCE (SIZE (1..maxNrofServingCells)) OF MeasResultServMO {	1 entry	Report NR Cell 1	
MeasResultServMO[1] SEQUENCE {		entry 1	
servCellId	ServCellIndex of NR Cell 1		
measResultServingCell SEQUENCE {			
physCellId	Physical layer cell identity of NR Cell 1		
measResult SEQUENCE {			
cellResults SEQUENCE {			
resultsSSB-Cell SEQUENCE {			
rsrp	(0..127)		
rsrq	(0..127)		
sinr	Not present		
}			
}			
}			
}			
}			
}			
}			
measResultNeighCells CHOICE {			
measResultListNR SEQUENCE (SIZE (1..maxCellReport)) OF OF MeasResultNR {	1 entry	Report NR neighbour cell	
MeasResultNR[1] SEQUENCE {		entry 1	
physCellId	Physical layer cell identity of NR Cell 2		
measResult SEQUENCE {			
cellResults SEQUENCE {			
resultsSSB-Cell SEQUENCE {			
rsrp	(0..127)		
rsrq	Not present		
sinr	Not present		
}			
resultsCSI-RS-Cell	Not present		
}			
rsIndexResults	Not present		
}			
cgi-Info	Not present		
}			
}			
}			
}			

8.1.3.1.6 Measurement configuration control and reporting / Event A4 / Measurement of Neighbour NR cell / Inter-frequency measurements

8.1.3.1.6.1 Test Purpose (TP)

Same as test case 8.1.3.1.5 but applied to inter-frequency case.

8.1.3.1.6.2 Conformance requirements

Same as test case 8.1.3.1.5 with the following difference:

[TS 38.331, clause 5.5.2.9]

The UE shall:

...

1> if *gapUE* is set to *setup*:

2> if a per UE measurement gap configuration is already setup, release the per UE measurement gap configuration;

2> setup the per UE measurement gap configuration indicated by the *measGapConfig* in accordance with the received *gapOffset*, i.e., the first subframe of each gap occurs at an SFN and subframe meeting the following condition:

$$\text{SFN mod } T = \text{FLOOR}(\text{gapOffset}/10);$$

$$\text{subframe} = \text{gapOffset mod } 10;$$

with $T = \text{MGRP}/10$ as defined in TS 38.133 [14];

2> if *mgta* is configured, apply the specified timing advance to the gap occurrences calculated above (i.e. the UE starts the measurement *mgta* ms before the gap subframe occurrences);

...

8.1.3.1.6.3 Test description

8.1.3.1.6.3.1 Pre-test conditions

Same as test case 8.1.3.1.5 with the following differences:

- Cells configuration: NR Cell 3 replaces NR Cell 2.
- System information combination: NR-4 replaces NR-2.

8.1.3.1.6.3.2 Test procedure sequence

Same as test case 8.1.3.1.5 with the following differences:

- Cells configuration: NR Cell 3 replaces NR Cell 2.

8.1.3.1.6.3.3 Specific message contents

Same as test case 8.1.3.1.5 with the following difference:

- Cells configuration: NR Cell 3 replaces NR Cell 2.

Table 8.1.3.1.6.3.3-1: MeasConfig (Table 8.1.3.1.5.3.3-1)

Derivation Path: 38.508-1 [4] Table 4.6.3-69			
Information Element	Value/remark	Comment	Condition
MeasConfig ::= SEQUENCE {			
measObjectToAddModList SEQUENCE (SIZE (1..maxNrofMeasId)) OF MeasObjectToAddMod {	2 entries		
MeasObjectToAddMod[1] SEQUENCE {		entry 1	
measObjectId	1		
measObject CHOICE {			
measObjectNR	MeasObjectNR-f1	Table 8.1.3.1.6.3.3-2	
}			
}			
MeasObjectToAddMod[2] SEQUENCE {		entry 2	
measObjectId	2		
measObject CHOICE {			
measObjectNR	MeasObjectNR-f2	Table 8.1.3.1.6.3.3-3	
}			
}			
reportConfigToAddModList SEQUENCE(SIZE (1..maxReportConfigId)) OF ReportConfigToAddMod {	1 entry		
ReportConfigToAddMod[1] SEQUENCE {		entry 1	
reportConfigId	1		
reportConfig CHOICE {			
reportConfigNR	ReportConfigNR-EventA4	Table 8.1.3.1.5.3.3-3	
}			
}			
measIdToAddModList SEQUENCE (SIZE (1..maxNrofMeasId)) OF MeasIdToAddMod {	1 entry		
MeasIdToAddMod[1] SEQUENCE {		entry 1	
measId	1		
measObjectId	2		
reportConfigId	1		
}			
}			
measGapConfig	MeasGapConfig		
}			

Table 8.1.3.1.6.3.3-2: MeasObjectNR-f1 (Table 8.1.3.1.6.3.3-1)

Derivation Path: TS 38.508-1 [4], Table 4.6.3-76			
Information Element	Value/remark	Comment	Condition
MeasObjectNR ::= SEQUENCE {			
ssbFrequency	ARFCN-ValueNR for SSB of NR Cell 1		
absThreshSS-BlocksConsolidation	Not present		
nrofSS-BlocksToAverage	Not present		
}			

Table 8.1.3.1.6.3.3-3: MeasObjectNR-f2 (Table 8.1.3.1.6.3.3-1)

Derivation Path: TS 38.508-1 [4], Table 4.6.3-76			
Information Element	Value/remark	Comment	Condition
MeasObjectNR ::= SEQUENCE {			
ssbFrequency	ARFCN-ValueNR for SSB of NR Cell 3		
absThreshSS-BlocksConsolidation	Not present		
nrofSS-BlocksToAverage	Not present		
}			

8.1.3.1.7 Measurement configuration control and reporting / Event A4 / Measurement of Neighbour NR cell / Inter-band measurements

8.1.3.1.7.1 Test Purpose (TP)

Same as test case 8.1.3.1.5 but applied to inter-band case.

8.1.3.1.7.2 Conformance requirements

Same as test case 8.1.3.1.5 with the following differences:

[TS 38.331, clause 5.5.2.9]

The UE shall:

...

1> if *gapUE* is set to *setup*:

2> if a per UE measurement gap configuration is already setup, release the per UE measurement gap configuration;

2> setup the per UE measurement gap configuration indicated by the *measGapConfig* in accordance with the received *gapOffset*, i.e., the first subframe of each gap occurs at an SFN and subframe meeting the following condition:

$$\text{SFN mod } T = \text{FLOOR}(\text{gapOffset}/10);$$

$$\text{subframe} = \text{gapOffset mod } 10;$$

with $T = \text{MGRP}/10$ as defined in TS 38.133 [14];

2> if *mgta* is configured, apply the specified timing advance to the gap occurrences calculated above (i.e. the UE starts the measurement *mgta* ms before the gap subframe occurrences);

...

8.1.3.1.7.3 Test description

8.1.3.1.7.3.1 Pre-test conditions

Same as test case 8.1.3.1.5 with the following differences:

- Cells configuration: NR Cell 10 replaces NR Cell 2.
- System information combination: NR-4 replaces NR-2.

8.1.3.1.7.3.2 Test procedure sequence

Same as test case 8.1.3.1.5 with the following differences:

- Cells configuration: NR Cell 10 replaces NR Cell 2.

8.1.3.1.7.3.3 Specific message contents

Same as test case 8.1.3.1.5 with the following difference:

- Cells configuration: NR Cell 10 replaces NR Cell 2.

Table 8.1.3.1.7.3.3-1: MeasConfig (Table 8.1.3.1.5.3.3-1)

Derivation Path: 38.508-1 [4] Table 4.6.3-69			
Information Element	Value/remark	Comment	Condition
MeasConfig ::= SEQUENCE {			
measObjectToAddModList SEQUENCE (SIZE (1..maxNrofMeasId)) OF MeasObjectToAddMod {	2 entries		
MeasObjectToAddMod[1] SEQUENCE {		entry 1	
measObjectId	1		
measObject CHOICE {			
measObjectNR	MeasObjectNR-f1	Table 8.1.3.1.7.3.3-2	
}			
}			
MeasObjectToAddMod[2] SEQUENCE {		entry 2	
measObjectId	2		
measObject CHOICE {			
measObjectNR	MeasObjectNR-f2	Table 8.1.3.1.7.3.3-3	
}			
}			
reportConfigToAddModList SEQUENCE(SIZE (1..maxReportConfigId)) OF ReportConfigToAddMod {	1 entry		
ReportConfigToAddMod[1] SEQUENCE {		entry 1	
reportConfigId	1		
reportConfig CHOICE {			
reportConfigNR	ReportConfigNR-EventA4	Table 8.1.3.1.5.3.3-3	
}			
}			
measIdToAddModList SEQUENCE (SIZE (1..maxNrofMeasId)) OF MeasIdToAddMod {	1 entry		
MeasIdToAddMod[1] SEQUENCE {		entry 1	
measId	1		
measObjectId	2		
reportConfigId	1		
}			
}			
measGapConfig	MeasGapConfig		
}			

Table 8.1.3.1.7.3.3-2: MeasObjectNR-f1 (Table 8.1.3.1.7.3.3-1)

Derivation Path: TS 38.508-1 [4], Table 4.6.3-76			
Information Element	Value/remark	Comment	Condition
MeasObjectNR ::= SEQUENCE {			
ssbFrequency	ARFCN-ValueNR for SSB of NR Cell 1		
absThreshSS-BlocksConsolidation	Not present		
nrofSS-BlocksToAverage	Not present		
}			

Table 8.1.3.1.7.3.3-3: MeasObjectNR-f2 (Table 8.1.3.1.7.3.3-1)

Derivation Path: TS 38.508-1 [4], Table 4.6.3-76			
Information Element	Value/remark	Comment	Condition
MeasObjectNR ::= SEQUENCE {			
ssbFrequency	ARFCN-ValueNR for SSB of NR Cell 10		
absThreshSS-BlocksConsolidation	Not present		
nrofSS-BlocksToAverage	Not present		
}			

8.1.3.1.8 Measurement configuration control and reporting / Event A5 / Measurement of Neighbour NR cell / Intra-frequency measurements

8.1.3.1.8.1 Test Purpose (TP)

(1)

```
with { UE in NR RRC_CONNECTED state and intra-frequency measurements configured for event A5 with
event based periodical reporting }
ensure that {
  when { Serving cell becomes worse than absolute threshold1 and neighbour cell becomes better than
absolute threshold2 }
  then { UE sends MeasurementReport message at regular intervals while entering conditions for
event A5 are satisfied }
}
```

(2)

```
with { UE in NR RRC_CONNECTED state and periodical measurement reporting triggered by event A5
ongoing }
ensure that {
  when { Serving cell becomes better than absolute threshold1 or neighbour cell becomes worse than
absolute threshold2 }
  then { UE stops sending MeasurementReport message }
}
```

8.1.3.1.8.2 Conformance requirements

References: The conformance requirements covered in the current TC are specified in: TS 38.331, clauses 5.3.5.3, 5.5.2.1, 5.5.4.1, 5.5.4.6 and 5.5.5.1. Unless otherwise stated these are Rel-15 requirements.

[TS 38.331, clause 5.3.5.3]

The UE shall perform the following actions upon reception of the *RRCReconfiguration*:

...

1> if the *RRCReconfiguration* message includes the *measConfig*:

2> perform the measurement configuration procedure as specified in 5.5.2;

...

1> if the UE is configured with E-UTRA *nr-SecondaryCellGroupConfig* (MCG is E-UTRA):

...

1> else:

2> submit the *RRCReconfigurationComplete* message via SRB1 to lower layers for transmission using the new configuration;

...

[TS 38.331, clause 5.5.2.1]

...

The UE shall:

...

1> if the received *measConfig* includes the *measObjectToAddModList*:

2> perform the measurement object addition/modification procedure as specified in 5.5.2.5;

...

1> if the received *measConfig* includes the *reportConfigToAddModList*:

2> perform the reporting configuration addition/modification procedure as specified in 5.5.2.7;

...

1> if the received *measConfig* includes the *measIdToAddModList*:

2> perform the measurement identity addition/modification procedure as specified in 5.5.2.3;

...

[TS 38.331, clause 5.5.4.1]

If AS security has been activated successfully, the UE shall:

1> for each *measId* included in the *measIdList* within *VarMeasConfig*:

2> if the corresponding *reportConfig* includes a *reportType* set to *eventTriggered* or *periodical*;

3> if the corresponding *measObject* concerns NR;

...

4> if the *eventA3* or *eventA5* is configured in the corresponding *reportConfig*:

5> if a serving cell is associated with a *measObjectNR* and neighbours are associated with another *measObjectNR*, consider any serving cell associated with the other *measObjectNR* to be a neighbouring cell as well;

...

4> if the *eventA1* or *eventA2* is configured in the corresponding *reportConfig*:

...

4> else:

5> for events involving a serving cell associated with a *measObjectNR* and neighbours associated with another *measObjectNR*, consider any serving cell associated with the other *measObjectNR* to be a neighbouring cell as well;

...

2> if the *reportType* is set to *eventTriggered* and if the entry condition applicable for this event, i.e. the event corresponding with the *eventId* of the corresponding *reportConfig* within *VarMeasConfig*, is fulfilled for one or more applicable cells for all measurements after layer 3 filtering taken during *timeToTrigger* defined for this event within the *VarMeasConfig*, while the *VarMeasReportList* does not include a measurement reporting entry for this *measId* (a first cell triggers the event):

3> include a measurement reporting entry within the *VarMeasReportList* for this *measId*;

3> set the *numberOfReportsSent* defined within the *VarMeasReportList* for this *measId* to 0;

3> include the concerned cell(s) in the *cellsTriggeredList* defined within the *VarMeasReportList* for this *measId*;

- 3> initiate the measurement reporting procedure, as specified in 5.5.5;
- 2> else if the *reportType* is set to *eventTriggered* and if the entry condition applicable for this event, i.e. the event corresponding with the *eventId* of the corresponding *reportConfig* within *VarMeasConfig*, is fulfilled for one or more applicable cells not included in the *cellsTriggeredList* for all measurements after layer 3 filtering taken during *timeToTrigger* defined for this event within the *VarMeasConfig* (a subsequent cell triggers the event):
 - 3> set the *numberOfReportsSent* defined within the *VarMeasReportList* for this *measId* to 0;
 - 3> include the concerned cell(s) in the *cellsTriggeredList* defined within the *VarMeasReportList* for this *measId*;
 - 3> initiate the measurement reporting procedure, as specified in 5.5.5;
- 2> else if the *reportType* is set to *eventTriggered* and if the leaving condition applicable for this event is fulfilled for one or more of the cells included in the *cellsTriggeredList* defined within the *VarMeasReportList* for this *measId* for all measurements after layer 3 filtering taken during *timeToTrigger* defined within the *VarMeasConfig* for this event:
 - 3> remove the concerned cell(s) in the *cellsTriggeredList* defined within the *VarMeasReportList* for this *measId*;
 - ...
 - 3> if *reportOnLeave* is set to *TRUE* for the corresponding reporting configuration:
 - 4> initiate the measurement reporting procedure, as specified in 5.5.5;
 - 3> if the *cellsTriggeredList* defined within the *VarMeasReportList* for this *measId* is empty:
 - 4> remove the measurement reporting entry within the *VarMeasReportList* for this *measId*;
 - 4> stop the periodical reporting timer for this *measId*, if running;
 - ...
- 2> upon expiry of the periodical reporting timer for this *measId*:
 - 3> initiate the measurement reporting procedure, as specified in 5.5.5.
 - ...

[TS 38.331, clause 5.5.4.6]

The UE shall:

- 1> consider the entering condition for this event to be satisfied when both condition A5-1 and condition A5-2, as specified below, are fulfilled;
- 1> consider the leaving condition for this event to be satisfied when condition A5-3 or condition A5-4, i.e. at least one of the two, as specified below, is fulfilled;
- 1> use the SpCell for *Mp*.

NOTE: The parameters of the reference signal(s) of the cell(s) that triggers the event are indicated in the *measObjectNR* associated to the event which may be different from the *measObjectNR* of the NR SpCell.

Inequality A5-1 (Entering condition 1)

$$M_p + H_{ys} < Thresh1$$

Inequality A5-2 (Entering condition 2)

$$M_n + O_{fn} + O_{cn} - H_{ys} > Thresh2$$

Inequality A5-3 (Leaving condition 1)

$$Mp - Hys > Thresh1$$

Inequality A5-4 (Leaving condition 2)

$$Mn + Ofn + Ocn + Hys < Thresh2$$

The variables in the formula are defined as follows:

Mp is the measurement result of the NR SpCell, not taking into account any offsets.

Mn is the measurement result of the neighbouring cell/SCell, not taking into account any offsets.

Ofn is the measurement object specific offset of the neighbour/SCell cell (i.e. *offsetMO* as defined within *measObjectNR* corresponding to the neighbour cell/SCell).

Ocn is the cell specific offset of the neighbour cell/SCell (i.e. *cellIndividualOffset* as defined within *measObjectNR* corresponding to the neighbour cell/SCell), and set to zero if not configured for the neighbour cell.

Hys is the hysteresis parameter for this event (i.e. *hysteresis* as defined within *reportConfigNR* for this event).

Thresh1 is the threshold parameter for this event (i.e. *a5-Threshold1* as defined within *reportConfigNR* for this event).

Thresh2 is the threshold parameter for this event (i.e. *a5-Threshold2* as defined within *reportConfigNR* for this event).

Mn, Mp are expressed in dBm in case of RSRP, or in dB in case of RSRQ and RS-SINR.

Ofn, Ocn, Hys are expressed in dB.

Thresh1 is expressed in the same unit as ***Mp***.

Thresh2 is expressed in the same unit as ***Mn***.

[TS 38.331, clause 5.5.5.1]



Figure 5.5.5-1: Measurement reporting

The purpose of this procedure is to transfer measurement results from the UE to the network. The UE shall initiate this procedure only after successful AS security activation.

For the *measId* for which the measurement reporting procedure was triggered, the UE shall set the *measResults* within the *MeasurementReport* message as follows:

- 1> set the *measId* to the measurement identity that triggered the measurement reporting;
 - 1> set the *measResultServingCell* within *measResultServingMOList* to include, for each NR serving cell that is configured with *servingCellMO*, RSRP, RSRQ and the available SINR derived based on the *rsType* if indicated in the associated *reportConfig*, otherwise based on SSB if available, otherwise based on CSI-RS; for each configured serving cell derived based on the *rsType* indicated in the associated *reportConfig*;
- set the *servCellId* within *measResultServingMOList* to include each NR serving cell that is configured with *servingCellMO*, if any;
- 1> set the *measResultServingCell* within *measResultServingMOList* to include for each NR serving cell that is configured with *servingCellMO*, if any, the *servCellId*;

...

1> if there is at least one applicable neighbouring cell to report:

2> if the *reportType* is set to *eventTriggered* or *periodical*:

3> set the *measResultNeighCells* to include the best neighbouring cells up to *maxReportCells* in accordance with the following:

4> if the *reportType* is set to *eventTriggered*:

5> include the cells included in the *cellsTriggeredList* as defined within the *VarMeasReportList* for this *measId*;

...

4> for each cell that is included in the *measResultNeighCells*, include the *physCellId*;

4> if the *reportType* is set to *eventTriggered* or *periodical*:

5> for each included cell, include the layer 3 filtered measured results in accordance with the *reportConfig* for this *measId*, ordered as follows:

6> if the *measObject* associated with this *measId* concerns NR:

7> if *rsType* in the associated *reportConfig* is set to *ssb*:

8> set *resultsSSB-Cell* within the *measResult* to include the SS/PBCH block based quantity(ies) indicated in the *reportQuantityCell* within the concerned *reportConfig*, in decreasing order of the sorting quantity, determined as specified in 5.5.5.3, i.e. the best cell is included first;

...

2> set the *measResultNeighCells* to include the best neighbouring cells up to *maxReportCells* in accordance with the following:

3> if the *reportType* is set to *eventTriggered*:

4> include the cells included in the *cellsTriggeredList* as defined within the *VarMeasReportList* for this *measId*;

...

3> for each cell that is included in the *measResultNeighCells*, include the *physCellId*;

3> if the *reportType* is set to *eventTriggered*:

4> for each included cell, include the layer 3 filtered measured results in accordance with the *reportConfig* for this *measId*, ordered as follows:

5> if the *measObject* associated with this *measId* concerns NR:

6> if *rsType* in the associated *reportConfig* is set to *ssb*:

7> set *resultsSSB-Cell* within the *measResult* to include the SS/PBCH block based quantity(ies) indicated in the *reportQuantityCell* within the concerned *reportConfig*, in order of decreasing trigger quantity, i.e. the best cell is included first;

...

1> increment the *numberOfReportsSent* as defined within the *VarMeasReportList* for this *measId* by 1;

1> stop the periodical reporting timer, if running;

1> if the *numberOfReportsSent* as defined within the *VarMeasReportList* for this *measId* is less than the *reportAmount* as defined within the corresponding *reportConfig* for this *measId*:

2> start the periodical reporting timer with the value of *reportInterval* as defined within the corresponding *reportConfig* for this *measId*;

...

...

1> if the UE is configured with EN-DC:

...

1> else:

2> submit the *MeasurementReport* message to lower layers for transmission, upon which the procedure ends.

8.1.3.1.8.3 Test description

8.1.3.1.8.3.1 Pre-test conditions

System Simulator:

- NR Cell 1 is the PCell, NR Cell 2 is the intra-frequency neighbour cell of NR Cell 1.
- System information combination NR-2 as defined in TS 38.508-1 [4] clause 4.4.3.1.2 is used in NR cells.

UE:

- None.

Preamble:

- The UE is in state 3N-A as defined in TS 38.508-1 [4], subclause 4.4A.

8.1.3.1.8.3.2 Test procedure sequence

Table 8.1.3.1.8.3.2-1 and 8.1.3.1.8.3.2-2 illustrates the downlink power levels to be applied for NR Cell 1 and NR Cell 2 at various time instants of the test execution. Row marked "T0" denotes the conditions after the preamble, while the configuration marked "T1" and "T2" are applied at the point indicated in the Main behaviour description in Table 8.1.3.1.8.3.2-3.

Table 8.1.3.1.8.3.2-1: Time instances of cell power level and parameter changes in FR1

	Parameter	Unit	NR Cell 1	NR Cell 2	Remark
T0	SS/PBCH SSS EPRE	dBm/ SCS	-85	-91	Power levels are such that entry condition for event A5 (measId 1) is not satisfied: $Mp + Hys \geq Thresh1$ or $Mn + Ofn + Ocn + Hys \leq Thresh2$
T1	SS/PBCH SSS EPRE	dBm/ SCS	-85	-79	Power levels are such that entry condition for event A5 (measId 1) is satisfied: $Mp + Hys < Thresh1$ and $Mn + Ofn + Ocn - Hys > Thresh2$
T2	SS/PBCH SSS EPRE	dBm/ SCS	-85	-93	Power levels are such that leaving condition for event A5 (measId 1) is satisfied: $Mp - Hys > Thresh1$ or $Mn + Ofn + Ocn + Hys < Thresh2$

Table 8.1.3.1.8.3.2-2: Time instances of cell power level and parameter changes in FR2

	Parameter	Unit	NR Cell 1	NR Cell 2	Remark
T0	SS/PBCH SSS EPRE	dBm/ SCS	FFS	FFS	Power levels are such that entry condition for event A5 (measId 1) is not satisfied: $Mp + Hys \geq Thresh1$ or $Mn + Ofn + Ocn + Hys \leq Thresh2$
T1	SS/PBCH SSS EPRE	dBm/ SCS	FFS	FFS	Power levels are such that entry condition for event A5 (measId 1) is satisfied: $Mp + Hys < Thresh1$ and $Mn + Ofn + Ocn - Hys > Thresh2$
T2	SS/PBCH SSS EPRE	dBm/ SCS	FFS	FFS	Power levels are such that leaving condition for event A5 (measId 1) is satisfied: $Mp - Hys > Thresh1$ or $Mn + Ofn + Ocn + Hys < Thresh2$

Table 8.1.3.1.8.3.2-3: Main behaviour

St	Procedure	Message Sequence		TP	Verdict
		U - S	Message		
1	The SS transmits an <i>RRCReconfiguration</i> message including <i>MeasConfig</i> to setup NR measurement and reporting for intra-frequency event A5 (<i>measId 1</i>)	<--	NR RRC: <i>RRCReconfiguration</i>	-	-
2	The UE transmits an <i>RRCReconfigurationComplete</i> message.	-->	NR RRC: <i>RRCReconfigurationComplete</i>	-	-
3	SS re-adjusts the cell-specific reference signal level according to row "T1" in table 8.1.3.1.8.3.2-1/2.	-	-	-	-
-	EXCEPTION: In parallel to events described in step 4 the steps specified in table 8.1.3.1.8.3.2-4 shall take place	-	-	-	-
4	Wait for 30 seconds to ensure that the UE performs a periodical intra-frequency reporting for NR Cell 2	-	-	1	-
5	SS re-adjusts the cell-specific reference signal level according to row "T2" in table 8.1.3.1.8.3.2-1/2.	-	-	-	-
6	Wait and ignore <i>MeasurementReport</i> messages for 10s to allow change of power levels for NR Cell 2 and UE measurement	-	-	-	-
7	Check: Does the UE transmit a <i>MeasurementReport</i> message within the next 10s?	-->	NR RRC: <i>MeasurementReport</i>	2	F

Table 8.1.3.1.8.3.2-4: Parallel behaviour

St	Procedure	Message Sequence		TP	Verdict
		U - S	Message		
-	EXCEPTION: After the 1st message is received, step 1 below shall be repeated every time the duration indicated in the IE <i>reportInterval</i> has elapsed	-	-	-	-
1	Check: Does the UE transmit a <i>MeasurementReport</i> message to report event A5 (<i>measId 1</i>) with the measured RSRP value for NR Cell 2?	-->	<i>MeasurementReport</i>	1	P

8.1.3.1.8.3.3 Specific message contents

Table 8.1.3.1.8.3.3-1: RRCReconfiguration (step 1, Table 8.1.3.1.8.3.2-3)

Derivation Path: 38.508-1 [4] Table 4.6.1-13 with condition NR_MEAS

Table 8.1.3.1.8.3.3-2: MeasConfig (Table 8.1.3.1.8.3.3-1)

Derivation Path: 38.508-1 [4] Table 4.6.3-69			
Information Element	Value/remark	Comment	Condition
MeasConfig ::= SEQUENCE {			
measObjectToAddModList SEQUENCE (SIZE (1..maxNrofMeasId)) OF MeasObjectToAddMod {	1 entry		
MeasObjectToAddMod[1] SEQUENCE {		entry 1	
measObjectId	1	MeasObjectIdNR-f1	
measObject CHOICE {			
measObjectNR SEQUENCE {			
ssbFrequency	ssbFrequency IE equals the ARFCN for NR Cell 2		
absThreshSS-BlocksConsolidation	Not present		
}			
}			
}			
reportConfigToAddModList SEQUENCE(SIZE (1..maxReportConfigId)) OF ReportConfigToAddMod {	1 entry		
ReportConfigToAddMod[1] SEQUENCE {		entry 1	
reportConfigId	1		
reportConfig CHOICE {			
reportConfigNR	ReportConfigNR-EventA5	Table 8.1.3.1.8.3.3-3	
}			
}			
measIdToAddModList SEQUENCE (SIZE (1..maxNrofMeasId)) OF MeasIdToAddMod {	1 entry		
MeasIdToAddMod[1] SEQUENCE {		entry 1	
measId	1		
measObjectId	1		
reportConfigId	1		
}			
}			
}			

Table 8.1.3.1.8.3.3-3: ReportConfigNR-EventA5 (Table 8.1.3.1.8.3.3-2)

Derivation Path: 38.508-1 [4] Table 4.6.3-142 with condition EVENT_A5			
Information Element	Value/remark	Comment	Condition
ReportConfigNR ::= SEQUENCE {			
reportType CHOICE {			
eventTriggered SEQUENCE {			
eventId CHOICE {			
eventA5 SEQUENCE {			
a5-Threshold1 CHOICE {			
rsrp	76	-80dBm	FR1
	FFS		FR2
}			
a5-Threshold2 CHOICE {			
rsrp	70	-86dBm	FR1
	FFS		FR2
}			
}			
}			
reportAmount	infinity		
reportQuantityCell SEQUENCE {			
rsrp	true		
rsrq	false		
sinr	false		
}			
}			
}			

8.1.3.1.9.2 Conformance requirements

Same as test case 8.1.3.1.8 with the following difference:

[TS 38.331, clause 5.5.2.9]

The UE shall:

...

1> if *gapUE* is set to *setup*:

2> if a per UE measurement gap configuration is already setup, release the per UE measurement gap configuration;

2> setup the per UE measurement gap configuration indicated by the *measGapConfig* in accordance with the received *gapOffset*, i.e., the first subframe of each gap occurs at an SFN and subframe meeting the following condition:

$$\text{SFN mod } T = \text{FLOOR}(\text{gapOffset}/10);$$

$$\text{subframe} = \text{gapOffset mod } 10;$$

with $T = \text{MGRP}/10$ as defined in TS 38.133 [14];

2> if *mgta* is configured, apply the specified timing advance to the gap occurrences calculated above (i.e. the UE starts the measurement *mgta* ms before the gap subframe occurrences);

...

8.1.3.1.9.3 Test description

8.1.3.1.9.3.1 Pre-test conditions

Same as test case 8.1.3.1.8 with the following difference:

- Cells configuration: NR Cell 3 replaces NR Cell 2.
- System information combination: NR-4 replaces NR-2.

8.1.3.1.9.3.2 Test procedure sequence

Same as test case 8.1.3.1.8 with the following difference:

- Cells configuration: NR Cell 3 replaces NR Cell 2.

8.1.3.1.9.3.3 Specific message contents

Same as test case 8.1.3.1.5 with the following difference:

- Cells configuration: NR Cell 3 replaces NR Cell 2.

Table 8.1.3.1.9.3.3-1: MeasConfig (Table 8.1.3.1.8.3.3-1)

Derivation Path: 38.508-1 [4] Table 4.6.3-69			
Information Element	Value/remark	Comment	Condition
MeasConfig ::= SEQUENCE {			
measObjectToAddModList SEQUENCE (SIZE (1..maxNrofMeasId)) OF MeasObjectToAddMod {	2 entries		
MeasObjectToAddMod[1] SEQUENCE {		entry 1	
measObjectId	1		
measObject CHOICE {			
measObjectNR	MeasObjectNR-f1	Table 8.1.3.1.9.3.3-2	
}			
}			
MeasObjectToAddMod[2] SEQUENCE {		entry 2	
measObjectId	2		
measObject CHOICE {			
measObjectNR	MeasObjectNR-f2	Table 8.1.3.1.9.3.3-3	
}			
}			
reportConfigToAddModList SEQUENCE(SIZE (1..maxReportConfigId)) OF ReportConfigToAddMod {	1 entry		
ReportConfigToAddMod[1] SEQUENCE {		entry 1	
reportConfigId	1		
reportConfig CHOICE {			
reportConfigNR	ReportConfigNR-EventA5	Table 8.1.3.1.8.3.3-3	
}			
}			
measIdToAddModList SEQUENCE (SIZE (1..maxNrofMeasId)) OF MeasIdToAddMod {	1 entry		
MeasIdToAddMod[1] SEQUENCE {		entry 1	
measId	1		
measObjectId	2		
reportConfigId	1		
}			
}			
measGapConfig	MeasGapConfig		
}			

Table 8.1.3.1.9.3.3-2: MeasObjectNR-f1 (Table 8.1.3.1.9.3.3-1)

Derivation Path: TS 38.508-1 [14], Table 4.6.3-76			
Information Element	Value/remark	Comment	Condition
MeasObjectNR ::= SEQUENCE {			
ssbFrequency	ARFCN-ValueNR for SSB of NR Cell 1		
absThreshSS-BlocksConsolidation	Not present		
nrofSS-BlocksToAverage	Not present		
}			

Table 8.1.3.1.9.3.3-3: MeasObjectNR-f2 (Table 8.1.3.1.9.3.3-1)

Derivation Path: TS 38.508-1 [14], Table 4.6.3-76			
Information Element	Value/remark	Comment	Condition
MeasObjectNR ::= SEQUENCE {			
ssbFrequency	ARFCN-ValueNR for SSB of NR Cell 3		
absThreshSS-BlocksConsolidation	Not present		
nrofSS-BlocksToAverage	Not present		
}			

8.1.3.1.10 Measurement configuration control and reporting / Event A5 / Measurement of Neighbour NR cell / Inter-band measurements

8.1.3.1.10.1 Test Purpose (TP)

Same as test case 8.1.3.1.8 but applied to inter-band case.

8.1.3.1.10.2 Conformance requirements

Same as test case 8.1.3.1.8 with the following difference:

[TS 38.331, clause 5.5.2.9]

The UE shall:

...

1> if *gapUE* is set to *setup*:

2> if a per UE measurement gap configuration is already setup, release the per UE measurement gap configuration;

2> setup the per UE measurement gap configuration indicated by the *measGapConfig* in accordance with the received *gapOffset*, i.e., the first subframe of each gap occurs at an SFN and subframe meeting the following condition:

$$\text{SFN mod } T = \text{FLOOR}(\text{gapOffset}/10);$$

$$\text{subframe} = \text{gapOffset mod } 10;$$

with $T = \text{MGRP}/10$ as defined in TS 38.133 [14];

2> if *mgta* is configured, apply the specified timing advance to the gap occurrences calculated above (i.e. the UE starts the measurement *mgta* ms before the gap subframe occurrences);

...

8.1.3.1.10.3 Test description

8.1.3.1.10.3.1 Pre-test conditions

Same as test case 8.1.3.1.8 with the following difference:

- Cells configuration: NR Cell 10 replaces NR Cell 2.
- System information combination: NR-4 replaces NR-2.

8.1.3.1.10.3.2 Test procedure sequence

Same as test case 8.1.3.1.8 with the following difference:

- Cells configuration: NR Cell 10 replaces NR Cell 2.

8.1.3.1.10.3.3 Specific message contents

Same as test case 8.1.3.1.8 with the following difference:

- Cells configuration: NR Cell 10 replaces NR Cell 2.

Table 8.1.3.1.10.3.3-1: MeasConfig (Table 8.1.3.1.8.3.3-1)

Derivation Path: 38.508-1 [4] Table 4.6.3-69			
Information Element	Value/remark	Comment	Condition
MeasConfig ::= SEQUENCE {			
measObjectToAddModList SEQUENCE (SIZE (1..maxNrofMeasId)) OF MeasObjectToAddMod {	2 entries		
MeasObjectToAddMod[1] SEQUENCE {		entry 1	
measObjectId	1		
measObject CHOICE {			
measObjectNR	MeasObjectNR-f1	Table 8.1.3.1.10.3.3-2	
}			
}			
MeasObjectToAddMod[2] SEQUENCE {		entry 2	
measObjectId	2		
measObject CHOICE {			
measObjectNR	MeasObjectNR-f2	Table 8.1.3.1.10.3.3-3	
}			
}			
reportConfigToAddModList SEQUENCE(SIZE (1..maxReportConfigId)) OF ReportConfigToAddMod {	1 entry		
ReportConfigToAddMod[1] SEQUENCE {		entry 1	
reportConfigId	1		
reportConfig CHOICE {			
reportConfigNR	ReportConfigNR-EventA5	Table 8.1.3.1.8.3.3-3	
}			
}			
measIdToAddModList SEQUENCE (SIZE (1..maxNrofMeasId)) OF MeasIdToAddMod {	1 entry		
MeasIdToAddMod[1] SEQUENCE {		entry 1	
measId	1		
measObjectId	2		
reportConfigId	1		
}			
}			
measGapConfig	MeasGapConfig		
}			

Table 8.1.3.1.10.3.3-2: MeasObjectNR-f1 (Table 8.1.3.1.10.3.3-1)

Derivation Path: TS 38.508-1 [4], Table 4.6.3-76			
Information Element	Value/remark	Comment	Condition
MeasObjectNR ::= SEQUENCE {			
ssbFrequency	ARFCN-ValueNR for SSB of NR Cell 1		
absThreshSS-BlocksConsolidation	Not present		
nrofSS-BlocksToAverage	Not present		
}			

Table 8.1.3.1.10.3.3-3: MeasObjectNR-f2 (Table 8.1.3.1.10.3.3-1)

Derivation Path: TS 38.508-1 [4], Table 4.6.3-76			
Information Element	Value/remark	Comment	Condition
MeasObjectNR ::= SEQUENCE {			
ssbFrequency	ARFCN-ValueNR for SSB of NR Cell 10		
absThreshSS-BlocksConsolidation	Not present		
nrofSS-BlocksToAverage	Not present		
}			

8.1.3.1.11 Measurement configuration control and reporting / Intra NR measurements / Two simultaneous events A3 (intra and inter-frequency measurements) / RSRQ based measurements

8.1.3.1.11.1 Test Purpose (TP)

(1)

```
with { UE in NR RRC_CONNECTED state, measurements configured for two event A3 at the same time and
triggerQuantity set to rsrq }
ensure that {
  when { Entry condition for event A3 is not met }
  then { UE does not send MeasurementReport }
}
```

(2)

```
with { UE in NR RRC_CONNECTED state, measurements configured for two event A3 at the same time and
triggerQuantity set to rsrq }
ensure that {
  when { Neighbour becomes offset better than serving }
  then { UE sends MeasurementReport with correct measId for event A3 }
}
```

8.1.3.1.11.2 Conformance requirements

References: The conformance requirements covered in the present TC are specified in: TS 38.331, clause 5.3.5.3, 5.5.2.1, 5.5.2.9, 5.5.4.1, 5.5.4.4 and 5.5.5.

[TS 38.331, clause 5.3.5.3]

The UE shall perform the following actions upon reception of the *RRCReconfiguration*:

...

- 1> if the *RRCReconfiguration* message includes the *measConfig*:
- 2> perform the measurement configuration procedure as specified in 5.5.2;

...

[TS 38.331, clause 5.5.2.1]

The UE shall:

...

- 1> if the received *measConfig* includes the *measObjectToAddModList*:
- 2> perform the measurement object addition/modification procedure as specified in 5.5.2.5;

...

- 1> if the received *measConfig* includes the *reportConfigToAddModList*:
 - 2> perform the reporting configuration addition/modification procedure as specified in 5.5.2.7;
- 1> if the received *measConfig* includes the *quantityConfig*:
 - 2> perform the quantity configuration procedure as specified in 5.5.2.8;

...

- 1> if the received *measConfig* includes the *measIdToAddModList*:
 - 2> perform the measurement identity addition/modification procedure as specified in 5.5.2.3;
- 1> if the received *measConfig* includes the *measGapConfig*:
 - 2> perform the measurement gap configuration procedure as specified in 5.5.2.9;

...

[TS 38.331, clause 5.5.2.9]

The UE shall:

...

- 1> if *gapUE* is set to setup:
 - 2> if a per UE measurement gap configuration is already setup, release the per UE measurement gap configuration;
 - 2> setup the per UE measurement gap configuration indicated by the *measGapConfig* in accordance with the received *gapOffset*, i.e., the first subframe of each gap occurs at an SFN and subframe meeting the following condition:
 - $\text{SFN mod } T = \text{FLOOR}(\text{gapOffset}/10)$;
 - $\text{subframe} = \text{gapOffset mod } 10$;
 - with $T = \text{MGRP}/10$ as defined in TS 38.133 [14];
 - 2> if *mgta* is configured, apply the specified timing advance to the gap occurrences calculated above (i.e. the UE starts the measurement *mgta* ms before the gap subframe occurrences);

...

[TS 38.331, clause 5.5.4.1]

If security has been activated successfully, the UE shall:

- 1> for each *measId* included in the *measIdList* within *VarMeasConfig*:
 - 2> if the corresponding *reportConfig* includes a *reportType* set to *eventTriggered* or *periodical*:
 - 3> if the corresponding *measObject* concerns NR;
 - 4> if the *eventA1* or *eventA2* is configured in the corresponding *reportConfig*:
 - ...
 - 4> else:
 - 5> for events involving a serving cell associated with a *measObjectNR* and neighbours associated with another *measObjectNR*, consider any serving cell associated with the other *measObjectNR* to be a neighbouring cell as well;
 - 5> if *useWhiteCellList* is set to TRUE:

- ...
- 5> else:
- 6> consider any neighbouring cell detected based on parameters in the associated *measObjectNR* to be applicable when the concerned cell is not included in the *blackCellsToAddModList* defined within the *VarMeasConfig* for this *measId*;
- ...
- 2> if the *reportType* is set to *eventTriggered* and if the entry condition applicable for this event, i.e. the event corresponding with the *eventId* of the corresponding *reportConfig* within *VarMeasConfig*, is fulfilled for one or more applicable cells for all measurements after layer 3 filtering taken during *timeToTrigger* defined for this event within the *VarMeasConfig*, while the *VarMeasReportList* does not include a measurement reporting entry for this *measId* (a first cell triggers the event):
- 3> include a measurement reporting entry within the *VarMeasReportList* for this *measId*;
- 3> set the *numberOfReportsSent* defined within the *VarMeasReportList* for this *measId* to 0;
- 3> include the concerned cell(s) in the *cellsTriggeredList* defined within the *VarMeasReportList* for this *measId*;
- 3> initiate the measurement reporting procedure, as specified in 5.5.5;
- 2> if the *reportType* is set to *eventTriggered* and if the entry condition applicable for this event, i.e. the event corresponding with the *eventId* of the corresponding *reportConfig* within *VarMeasConfig*, is fulfilled for one or more applicable cells not included in the *cellsTriggeredList* for all measurements after layer 3 filtering taken during *timeToTrigger* defined for this event within the *VarMeasConfig* (a subsequent cell triggers the event):
- 3> set the *numberOfReportsSent* defined within the *VarMeasReportList* for this *measId* to 0;
- 3> include the concerned cell(s) in the *cellsTriggeredList* defined within the *VarMeasReportList* for this *measId*;
- 3> initiate the measurement reporting procedure, as specified in 5.5.5;
- 2> if the *reportType* is set to *eventTriggered* and if the leaving condition applicable for this event is fulfilled for one or more of the cells included in the *cellsTriggeredList* defined within the *VarMeasReportList* for this *measId* for all measurements after layer 3 filtering taken during *timeToTrigger* defined within the *VarMeasConfig* for this event:
- 3> remove the concerned cell(s) in the *cellsTriggeredList* defined within the *VarMeasReportList* for this *measId*;
- ...3> if the *cellsTriggeredList* defined within the *VarMeasReportList* for this *measId* is empty:
- 4> remove the measurement reporting entry within the *VarMeasReportList* for this *measId*;
- 4> stop the periodical reporting timer for this *measId*, if running;
- ...

[TS 38.331, clause 5.5.4.4]

The UE shall:

- 1> consider the entering condition for this event to be satisfied when condition A3-1, as specified below, is fulfilled;
- 1> consider the leaving condition for this event to be satisfied when condition A3-2, as specified below, is fulfilled;
- 1> use the SpCell for *Mp*, *Ofp* and *Ocp*.

NOTE The cell(s) that triggers the event has reference signals indicated in the *measObjectNR* associated to this event which may be different from the NR SpCell *measObjectNR*.

Inequality A3-1 (Entering condition)

$$Mn + Ofn + Ocn - Hys > Mp + Ofp + Ocp + Off$$

Inequality A3-2 (Leaving condition)

$$Mn + Ofn + Ocn + Hys < Mp + Ofp + Ocp + Off$$

The variables in the formula are defined as follows:

Mn is the measurement result of the neighbouring cell, not taking into account any offsets.

Ofn is the measurement object specific offset of the reference signal of the neighbour cell (i.e. *offsetMO* as defined within *measObjectNR* corresponding to the neighbour cell).

Ocn is the cell specific offset of the neighbour cell (i.e. *cellIndividualOffset* as defined within *measObjectNR* corresponding to the frequency of the neighbour cell), and set to zero if not configured for the neighbour cell.

Mp is the measurement result of the SpCell, not taking into account any offsets.

Ofp is the measurement object specific offset of the SpCell (i.e. *offsetMO* as defined within *measObjectNR* corresponding to the SpCell).

Ocp is the cell specific offset of the SpCell (i.e. *cellIndividualOffset* as defined within *measObjectNR* corresponding to the SpCell), and is set to zero if not configured for the SpCell.

Hys is the hysteresis parameter for this event (i.e. *hysteresis* as defined within *reportConfigNR* for this event).

Off is the offset parameter for this event (i.e. *a3-Offset* as defined within *reportConfigNR* for this event).

Mn, Mp are expressed in dBm in case of RSRP, or in dB in case of RSRQ and RS-SINR.

Ofn, Ocn, Ofp, Ocp, Hys, Off are expressed in dB.

[TS 38.331, clause 5.5.5.1]



Figure 5.5.5.1-1: Measurement reporting

The purpose of this procedure is to transfer measurement results from the UE to the network. The UE shall initiate this procedure only after successful security activation.

For the *measId* for which the measurement reporting procedure was triggered, the UE shall set the *measResults* within the *MeasurementReport* message as follows:

- 1> set the *measId* to the measurement identity that triggered the measurement reporting;
- 1> set the *measResultServingCell* within *measResultServingMOList* to include RSRP, RSRQ and the available SINR for each configured serving cell derived based on the *rsType* indicated in the associated *reportConfig*;
- 1> set the *measResultServingCell* within *measResultServingMOList* to include for each NR serving cell that is configured with *servingCellMO*, if any, the *servCellId*;
- ...
- 1> if there is at least one applicable neighbouring cell to report:
 - 2> if the *reportType* is set to *eventTriggered* or *periodical*:

3> set the *measResultNeighCells* to include the best neighbouring cells up to *maxReportCells* in accordance with the following:

4> if the *reportType* is set to *eventTriggered*:

5> include the cells included in the *cellsTriggeredList* as defined within the *VarMeasReportList* for this *measId*;

4> for each cell that is included in the *measResultNeighCells*, include the *physCellId*;

4> if the *reportType* is set to *eventTriggered* or *periodical*:

5> for each included cell, include the layer 3 filtered measured results in accordance with the *reportConfig* for this *measId*, ordered as follows:

6> if the *measObject* associated with this *measId* concerns NR:

7> if *rsType* in the associated *reportConfig* is set to *ssb*:

8> set *resultsSSB-Cell* within the *measResult* to include the SS/PBCH block based quantity(ies) indicated in the *reportQuantityCell* within the concerned *reportConfig*, in decreasing order of the sorting quantity, determined as specified in 5.5.5.3, i.e. the best cell is included first;

...

1> increment the *numberOfReportsSent* as defined within the *VarMeasReportList* for this *measId* by 1;

1> stop the periodical reporting timer, if running;

1> if the *numberOfReportsSent* as defined within the *VarMeasReportList* for this *measId* is less than the *reportAmount* as defined within the corresponding *reportConfig* for this *measId*:

2> start the periodical reporting timer with the value of *reportInterval* as defined within the corresponding *reportConfig* for this *measId*;

...

1> if the UE is configured with EN-DC:

...

1> else:

2> submit the *MeasurementReport* message to lower layers for transmission, upon which the procedure ends.

8.1.3.1.11.3 Test description

8.1.3.1.11.3.1 Pre-test conditions

System Simulator:

- NR Cell 1 is the serving cell, NR Cell 2 is the intra-frequency neighbour cell, and NR Cell 3 is the inter-frequency neighbour cell.
- System information combination NR-5 as defined in TS 38.508-1 [4] clause 4.4.3.1.2 is used in NR cells.

UE:

- None.

Preamble:

- The UE is in state 3N-A as defined in TS 38.508-1 [4], subclause 4.4A on NR Cell 1.

8.1.3.1.11.3.2 Test procedure sequence

Table 8.1.3.1.11.3.2-1 and 8.1.3.1.11.3.2-2 illustrate the downlink power levels to be applied for NR Cell 1, NR Cell 2 and NR Cell 3 at various time instants of the test execution for FR1 and FR2 respectively. Row marked "T0" denotes the conditions after the preamble, while rows marked "T1" and "T2" are to be applied subsequently. The exact instants on which these values shall be applied are described in the texts in this clause.

Table 8.1.3.1.11.3.2-1: Time instances of cell power level and parameter changes in FR1

	Parameter	Unit	NR Cell 1	NR Cell 2 (DL only)	NR Cell 3 (DL only)	Remark
T0	SS/PBCH SSS EPRE	dBm/S CS	-88	-100	"Off"	Power levels are such that entry condition for event A3 (<i>measld</i> 1 & 2) is not satisfied: $Mn + Ofn + Ocn - Hys < Mp + Ofp + Ocp + Off$
	SS-RSRQ	dB	-11.74	-17.74	-	
	Noc	dBm/S CS	-94		-	
T1	SS/PBCH SSS EPRE	dBm/S CS	-88	-88	"Off"	Power levels are such that entry condition for event A3 (<i>measld</i> 1) is satisfied: $Mn + Ofn + Ocn - Hys > Mp + Ofp + Ocp + Off$
	SS-RSRQ	dB	-11.74	-11.74	-	
	Noc	dBm/S CS	-94		-	
T2	SS/PBCH SSS EPRE	dBm/S CS	-88	"Off"	-88	Power levels are such that entry condition for event A3 (<i>measld</i> 2) is satisfied: $Mn + Ofn + Ocn - Hys > Mp + Ofp + Ocp + Off$
	SS-RSRQ	dB	-11.74	-	-11.74	
	Noc	dBm/S CS	-94		-94	

NOTE 1: The total tolerance used is the sum of downlink signal level uncertainty (TS 38.508-1 Table 6.2.2.1-4) and absolute UE measurement accuracy (TS 38.133 clause 10).

Table 8.1.3.1.11.3.2-2: Time instances of cell power level and parameter changes in FR2

	Parameter	Unit	NR Cell 1	NR Cell 2 (DL only)	NR Cell 10 (DL only)	Remark
T0	SS/PBCH SSS EPRE	dBm/S CS	FFS	FFS	"Off"	Power levels are such that entry condition for event A3 (<i>measld</i> 1 & 2) is not satisfied: $Mn + Ofn + Ocn - Hys < Mp + Ofp + Ocp + Off$
	RSRQ	dB	FFS	FFS	-	
	Noc	dBm/S CS	FFS		FFS	
T1	SS/PBCH SSS EPRE	dBm/S CS	FFS	FFS	"Off"	Power levels are such that entry condition for event A3 (<i>measld</i> 1) is satisfied: $Mn + Ofn + Ocn - Hys > Mp + Ofp + Ocp + Off$
	RSRQ	dB	FFS	FFS	-	
	Noc	dBm/S CS	FFS		FFS	
T2	SS/PBCH SSS EPRE	dBm/S CS	FFS	"Off"	FFS	Power levels are such that entry condition for event A3 (<i>measld</i> 2) is satisfied: $Mn + Ofn + Ocn - Hys > Mp + Ofp + Ocp + Off$
	RSRQ	dB	FFS	-	FFS	
	Noc	dBm/S CS	FFS		FFS	

NOTE 1: The total tolerance used is the sum of downlink signal level uncertainty (TS 38.508-1 Table 6.2.2.2-TBD) and absolute UE measurement accuracy (TS 38.133 clause 10).

Table 8.1.3.1.11.3.2-3: Main behaviour

St	Procedure	Message Sequence		TP	Verdict
		U - S	Message		
1	The SS transmits an <i>RRCReconfiguration</i> message on NR Cell 1 including <i>MeasConfig</i> to setup NR measurement and reporting for two event A3 (<i>measId 1</i> and <i>measId 2</i>) (intra and inter frequency measurement).	<-	NR RRC: <i>RRCReconfiguration</i>	-	-
2	The UE transmits an <i>RRCReconfigurationComplete</i> message on NR Cell 1.	-->	NR RRC: <i>RRCReconfigurationComplete</i>	-	-
3	Check: Does the UE transmit a <i>MeasurementReport</i> message on NR Cell 1 within the next 10s?	-->	NR RRC: <i>MeasurementReport</i>	1	F
4	The SS re-adjusts the cell-specific reference signal level according to row "T1" in Table 8.1.3.1.11.3.2-1/2.	-	-	-	-
5	Check: Does the UE transmit a <i>MeasurementReport</i> message on NR Cell 1 to report event A3 (<i>measId 1</i>) with the measured RSRP and RSRQ values for NR Cell 2?	-->	NR RRC: <i>MeasurementReport</i>	2	P
6	The SS re-adjusts the cell-specific reference signal level according to row "T2" in Table 8.1.3.1.11.3.2-1/2.	-	-	-	-
7	Check: Does the UE transmit a <i>MeasurementReport</i> message on NR Cell 1 to report event A3 (<i>measId 2</i>) with the measured RSRP and RSRQ values for NR Cell 3?	-->	NR RRC: <i>MeasurementReport</i>	2	P

8.1.3.1.11.3.3 Specific message contents

Table 8.1.3.1.11.3.3-1: *RRCReconfiguration* (step 1, Table 8.1.3.1.11.3.2-3)

Derivation Path: 38.508-1 [4] table 4.6.1-13 with condition NR_MEAS

Table 8.1.3.1.11.3.3-2: MeasConfig (step 1, Table 8.1.3.1.11.3.2-3)

Derivation path: 38.508-1[4] table 4.6.3-69			
Information Element	Value/Remark	Comment	Condition
MeasConfig ::= SEQUENCE {			
measObjectToAddModList SEQUENCE (SIZE (1..maxNrofMeasId)) OF MeasObjectToAddMod {	2 entries		
MeasObjectToAddMod[1] SEQUENCE {		entry 1	
measObjectId	1		
measObject CHOICE {			
measObjectNR	MeasObjectNR-f1	Table 8.1.3.1.11.3.3-3	
}			
}			
MeasObjectToAddMod[2] SEQUENCE {		entry 2	
measObjectId	2		
measObject CHOICE {			
measObjectNR	MeasObjectNR-f2	Table 8.1.3.1.11.3.3-4	
}			
}			
}			
reportConfigToAddModList SEQUENCE(SIZE (1..maxReportConfigId)) OF ReportConfigToAddMod {	1 entry		
ReportConfigToAddMod[1] SEQUENCE {		entry 1	
reportConfigId	ReportConfigId		
reportConfig CHOICE {			
reportConfigNR	ReportConfigNR-A3	Table 8.1.3.1.11.3.3-5	
}			
}			
}			
measIdToAddModList SEQUENCE (SIZE (1..maxNrofMeasId)) OF MeasIdToAddMod {	2 entries		
MeasIdToAddMod[1] SEQUENCE {		entry 1	
measId	1		
measObjectId	1		
reportConfigId	ReportConfigId		
}			
MeasIdToAddMod[2] SEQUENCE {		entry 2	
measId	2		
measObjectId	2		
reportConfigId	ReportConfigId		
}			
}			
measGapConfig	MeasGapConfig	Table 8.1.3.1.11.3.3-6	
}			

Table 8.1.3.1.11.3.3-3: MeasObjectNR-f1 (Table 8.1.3.1.11.3.3-2)

Derivation Path: TS 38.508-1 [4], Table 4.6.3-76			
Information Element	Value/remark	Comment	Condition
MeasObjectNR ::= SEQUENCE {			
ssbFrequency	Downlink ARFCN of NR Cell 1 SSB		
absThreshSS-BlocksConsolidation	Not present		
}			

Table 8.1.3.1.11.3.3-4: MeasObjectNR-f2 (Table 8.1.3.1.11.3.3-2)

Derivation Path: TS 38.508-1 [4], Table 4.6.3-76			
Information Element	Value/remark	Comment	Condition
MeasObjectNR ::= SEQUENCE {			
ssbFrequency	Downlink ARFCN of NR Cell 3 SSB		
absThreshSS-BlocksConsolidation	Not present		
}			

Table 8.1.3.1.11.3.3-5: ReportConfigNR-A3 (Table 8.1.3.1.11.3.3-2)

Derivation Path: 38.508-1 [4] table 4.6.3-142 with condition EVENT_A3			
Information Element	Value/remark	Comment	Condition
ReportConfigNR ::= SEQUENCE {			
reportType CHOICE {			
eventTriggered SEQUENCE {			
eventId CHOICE {			
eventA3 SEQUENCE {			
a3-Offset CHOICE {			
rsrq	-6	Actual value = -3dB	
}			
hysteresis	0	Actual value = 0dB	
}			
}			
}			
reportAmount	r1		
}			

Table 8.1.3.1.11.3.3-6: MeasGapConfig (Table 8.1.3.1.11.3.3-2)

Derivation Path: TS 38.508-1 [4], Table 4.6.3-70			
Information Element	Value/remark	Comment	Condition
MeasGapConfig ::= SEQUENCE {			
gapUE CHOICE {			
setup SEQUENCE {			
gapOffset	9		
mgl	ms6		
mgrp	ms160		
mgta	ms0dot25		FR2
	ms0dot5		FR1
}			
}			
}			

8.1.3.1.12 Measurement configuration control and reporting / Intra NR measurements / Two simultaneous events A5 (intra and inter-frequency measurements) / SINR based measurements

8.1.3.1.12.1 Test Purpose (TP)

(1)

```
with { UE in NR RRC_CONNECTED state, measurements configured for two event A5 at the same time and
triggerQuantity set to sinr }
ensure that {
  when { Entry condition for event A5 is not met }
  then { UE does not send MeasurementReport }
}
```

(2)

```
with { UE in NR RRC_CONNECTED state, measurements configured for two event A5 at the same time and
triggerQuantity set to sinr }
ensure that {
  when { SpCell becomes worse than threshold1 and neighbour becomes better than threshold2 }
  then { UE sends MeasurementReport with correct measId for event A5 }
}
```

8.1.3.1.12.2 Conformance requirements

References: The conformance requirements covered in the present TC are specified in: TS 38.331, clause 5.3.5.3, 5.5.2.1, 5.5.2.9, 5.5.4.1, 5.5.4.4 and 5.5.5.

[TS 38.331, clause 5.3.5.3]

The UE shall perform the following actions upon reception of the *RRCReconfiguration*:

...

- 1> if the *RRCReconfiguration* message includes the *measConfig*:
- 2> perform the measurement configuration procedure as specified in 5.5.2;

...

[TS 38.331, clause 5.5.2.1]

The UE shall:

...

- 1> if the received *measConfig* includes the *measObjectToAddModList*:
- 2> perform the measurement object addition/modification procedure as specified in 5.5.2.5;

...

- 1> if the received *measConfig* includes the *reportConfigToAddModList*:
- 2> perform the reporting configuration addition/modification procedure as specified in 5.5.2.7;

- 1> if the received *measConfig* includes the *quantityConfig*:
- 2> perform the quantity configuration procedure as specified in 5.5.2.8;

...

- 1> if the received *measConfig* includes the *measIdToAddModList*:
- 2> perform the measurement identity addition/modification procedure as specified in 5.5.2.3;

- 1> if the received *measConfig* includes the *measGapConfig*:

2> perform the measurement gap configuration procedure as specified in 5.5.2.9;

...

[TS 38.331, clause 5.5.2.9]

The UE shall:

...

1> if *gapUE* is set to setup:

- 2> if a per UE measurement gap configuration is already setup, release the per UE measurement gap configuration;
- 2> setup the per UE measurement gap configuration indicated by the *measGapConfig* in accordance with the received *gapOffset*, i.e., the first subframe of each gap occurs at an SFN and subframe meeting the following condition:

$$\text{SFN mod } T = \text{FLOOR}(\text{gapOffset}/10);$$

$$\text{subframe} = \text{gapOffset mod } 10;$$

with $T = \text{MGRP}/10$ as defined in TS 38.133 [14];

- 2> if *mgta* is configured, apply the specified timing advance to the gap occurrences calculated above (i.e. the UE starts the measurement *mgta* ms before the gap subframe occurrences);

[TS 38.331, clause 5.5.4.1]

If security has been activated successfully, the UE shall:

1> for each *measId* included in the *measIdList* within *VarMeasConfig*:

2> if the corresponding *reportConfig* includes a *reportType* set to *eventTriggered* or *periodical*;

3> if the corresponding *measObject* concerns NR;

4> if the *eventA1* or *eventA2* is configured in the corresponding *reportConfig*:

...

4> else:

5> for events involving a serving cell associated with a *measObjectNR* and neighbours associated with another *measObjectNR*, consider any serving cell associated with the other *measObjectNR* to be a neighbouring cell as well;

5> if *useWhiteCellList* is set to TRUE:

...

5> else:

6> consider any neighbouring cell detected based on parameters in the associated *measObjectNRto* be applicable when the concerned cell is not included in the *blackCellsToAddModList* defined within the *VarMeasConfig* for this *measId*;

...

2> if the *reportType* is set to *eventTriggered* and if the entry condition applicable for this event, i.e. the event corresponding with the *eventId* of the corresponding *reportConfig* within *VarMeasConfig*, is fulfilled for one or more applicable cells for all measurements after layer 3 filtering taken during *timeToTrigger* defined for this event within the *VarMeasConfig*, while the *VarMeasReportList* does not include a measurement reporting entry for this *measId* (a first cell triggers the event):

3> include a measurement reporting entry within the *VarMeasReportList* for this *measId*;

- 3> set the *numberOfReportsSent* defined within the *VarMeasReportList* for this *measId* to 0;
- 3> include the concerned cell(s) in the *cellsTriggeredList* defined within the *VarMeasReportList* for this *measId*;
- 3> initiate the measurement reporting procedure, as specified in 5.5.5;
- 2> if the *reportType* is set to *eventTriggered* and if the entry condition applicable for this event, i.e. the event corresponding with the *eventId* of the corresponding *reportConfig* within *VarMeasConfig*, is fulfilled for one or more applicable cells not included in the *cellsTriggeredList* for all measurements after layer 3 filtering taken during *timeToTrigger* defined for this event within the *VarMeasConfig* (a subsequent cell triggers the event):
 - 3> set the *numberOfReportsSent* defined within the *VarMeasReportList* for this *measId* to 0;
 - 3> include the concerned cell(s) in the *cellsTriggeredList* defined within the *VarMeasReportList* for this *measId*;
 - 3> initiate the measurement reporting procedure, as specified in 5.5.5;
- 2> if the *reportType* is set to *eventTriggered* and if the leaving condition applicable for this event is fulfilled for one or more of the cells included in the *cellsTriggeredList* defined within the *VarMeasReportList* for this *measId* for all measurements after layer 3 filtering taken during *timeToTrigger* defined within the *VarMeasConfig* for this event:
 - 3> remove the concerned cell(s) in the *cellsTriggeredList* defined within the *VarMeasReportList* for this *measId*;
 - ...
 - 3> if the *cellsTriggeredList* defined within the *VarMeasReportList* for this *measId* is empty:
 - 4> remove the measurement reporting entry within the *VarMeasReportList* for this *measId*;
 - 4> stop the periodical reporting timer for this *measId*, if running;
 - ...

[TS 38.331, clause 5.5.4.4]

The UE shall:

- 1> consider the entering condition for this event to be satisfied when both condition A5-1 and condition A5-2, as specified below, are fulfilled;
- 1> consider the leaving condition for this event to be satisfied when condition A5-3 or condition A5-4, i.e. at least one of the two, as specified below, is fulfilled;
- 1> use the SpCell for *Mp*.

NOTE: The parameters of the reference signal(s) of the cell(s) that triggers the event are indicated in the *measObjectNR* associated to the event which may be different from the *measObjectNR* of the NR SpCell.

Inequality A5-1 (Entering condition 1)

$$M_p + H_{ys} < Thresh1$$

Inequality A5-2 (Entering condition 2)

$$M_n + O_{fn} + O_{cn} - H_{ys} > Thresh2$$

Inequality A5-3 (Leaving condition 1)

$$M_p - H_{ys} > Thresh1$$

Inequality A5-4 (Leaving condition 2)

$$Mn + Ofn + Ocn + Hys < Thresh2$$

The variables in the formula are defined as follows:

Mp is the measurement result of the NR SpCell, not taking into account any offsets.

Mn is the measurement result of the neighbouring cell/SCell, not taking into account any offsets.

Ofn is the measurement object specific offset of the neighbour/SCell cell (i.e. *offsetMO* as defined within *measObjectNR* corresponding to the neighbour cell/SCell).

Ocn is the cell specific offset of the neighbour cell/SCell (i.e. *cellIndividualOffset* as defined within *measObjectNR* corresponding to the neighbour cell/SCell), and set to zero if not configured for the neighbour cell.

Hys is the hysteresis parameter for this event (i.e. *hysteresis* as defined within *reportConfigNR* for this event).

Thresh1 is the threshold parameter for this event (i.e. *a5-Threshold1* as defined within *reportConfigNR* for this event).

Thresh2 is the threshold parameter for this event (i.e. *a5-Threshold2* as defined within *reportConfigNR* for this event).

Mn, Mp are expressed in dBm in case of RSRP, or in dB in case of RSRQ and RS-SINR.

Ofn, Ocn, Hys are expressed in dB.

Thresh1 is expressed in the same unit as ***Mp***.

Thresh2 is expressed in the same unit as ***Mn***.

[TS 38.331, clause 5.5.5.1]



Figure 5.5.5.1-1: Measurement reporting

The purpose of this procedure is to transfer measurement results from the UE to the network. The UE shall initiate this procedure only after successful security activation.

For the *measId* for which the measurement reporting procedure was triggered, the UE shall set the *measResults* within the *MeasurementReport* message as follows:

- 1> set the *measId* to the measurement identity that triggered the measurement reporting;
- 1> set the *measResultServingCell* within *measResultServingMOList* to include RSRP, RSRQ and the available SINR for each configured serving cell derived based on the *rsType* indicated in the associated *reportConfig*;
- 1> set the *measResultServingCell* within *measResultServingMOList* to include for each NR serving cell that is configured with *servingCellMO*, if any, the *servCellId*;
- 1> if there is at least one applicable neighbouring cell to report:
 - 2> if the *reportType* is set to *eventTriggered* or *periodical*:
 - 3> set the *measResultNeighCells* to include the best neighbouring cells up to *maxReportCells* in accordance with the following:
 - 4> if the *reportType* is set to *eventTriggered*:

- 5> include the cells included in the *cellsTriggeredList* as defined within the *VarMeasReportList* for this *measId*;
- 4> for each cell that is included in the *measResultNeighCells*, include the *physCellId*;
- 4> if the *reportType* is set to *eventTriggered* or *periodical*:
 - 5> for each included cell, include the layer 3 filtered measured results in accordance with the *reportConfig* for this *measId*, ordered as follows:
 - 6> if the *measObject* associated with this *measId* concerns NR:
 - 7> if *rsType* in the associated *reportConfig* is set to *ssb*:
 - 8> set *resultsSSB-Cell* within the *measResult* to include the SS/PBCH block based quantity(ies) indicated in the *reportQuantityCell* within the concerned *reportConfig*, in decreasing order of the sorting quantity, determined as specified in 5.5.5.3, i.e. the best cell is included first;
- ...
- 1> increment the *numberOfReportsSent* as defined within the *VarMeasReportList* for this *measId* by 1;
- 1> stop the periodical reporting timer, if running;
- 1> if the *numberOfReportsSent* as defined within the *VarMeasReportList* for this *measId* is less than the *reportAmount* as defined within the corresponding *reportConfig* for this *measId*:
 - 2> start the periodical reporting timer with the value of *reportInterval* as defined within the corresponding *reportConfig* for this *measId*;
 - ...
 - 2> if the UE is configured with EN-DC:
 - ...
- 1> else:
 - 2> submit the *MeasurementReport* message to lower layers for transmission, upon which the procedure ends.

8.1.3.1.12.3 Test description

8.1.3.1.12.3.1 Pre-test conditions

System Simulator:

- NR Cell 1 is the serving cell, NR Cell 2 is the intra-frequency neighbour cell, and NR Cell 3 is the inter-frequency neighbour cell.
- System information combination NR-5 as defined in TS 38.508-1 [4] clause 4.4.3.1.2 is used in NR cells.

UE:

- None.

Preamble:

- The UE is in state 3N-A as defined in TS 38.508-1 [4], subclause 4.4A on NR Cell 1.

8.1.3.1.12.3.2 Test procedure sequence

Table 8.1.3.1.12.3.2-1 and Table 8.1.3.1.12.3.2-2 illustrates the downlink power levels to be applied for NR Cell 1, NR Cell 2 and NR Cell 3 at various time instants of the test execution for FR1 and FR2 respectively. Row marked "T0"

denotes the conditions after the preamble, while rows marked "T1" and "T2" are to be applied subsequently. The exact instants on which these values shall be applied are described in the texts in this clause.

Table 8.1.3.1.12.3.2-1: Time instances of cell power level and parameter changes in FR1

	Parameter	Unit	NR Cell 1	NR Cell 2 (DL only)	NR Cell 3 (DL only)	Remark
T0	SS/PBCH SSS EPRE	dBm/S CS	-82	-94	"Off"	Power levels are such that either one entry condition for event A5 (<i>measId</i> 1 & 2) is not satisfied: $Mp + Hys > Thresh1$ or $Mn + Ofn + Ocn - Hys < Thresh2$
	SINR	dB	12	0	-	
	Noc	dBm/S CS	-94		-94	
T1	SS/PBCH SSS EPRE	dBm/S CS	-88	-88	"Off"	Power levels are such that both entry conditions for event A5 (<i>measId</i> 1) is satisfied: $Mp + Hys < Thresh1$ and $Mn + Ofn + Ocn - Hys > Thresh2$
	SINR	dB	-6	6	-	
	Noc	dBm/S CS	-94		-94	
T2	SS/PBCH SSS EPRE	dBm/S CS	-88	"Off"	-88	Power levels are such that both entry conditions for event A5 (<i>measId</i> 2) is satisfied: $Mp + Hys < Thresh1$ and $Mn + Ofn + Ocn - Hys > Thresh2$
	SINR	dB	6	-	6	
	Noc	dBm/S CS	-94		-94	
NOTE 1: The total tolerance used is the sum of downlink signal level uncertainty (TS 38.508-1 Table 6.2.2.1-4) and absolute UE measurement accuracy (TS 38.133 clause 10).						

Table 8.1.3.1.12.3.2-2: Time instances of cell power level and parameter changes in FR2

	Parameter	Unit	Cell 1	Cell 2 (DL only)	Cell 10 (DL only)	Remark
T0	SS/PBCH SSS EPRE	dBm/S CS	FFS	FFS	"Off"	Power levels are such that either one entry condition for event A5 (<i>measId</i> 1 & 2) is not satisfied: $Mp + Hys > Thresh1$ or $Mn + Ofn + Ocn - Hys < Thresh2$
	SINR	dB	FFS	FFS	-	
	Noc	dBm/S CS	FFS		FFS	
T1	SS/PBCH SSS EPRE	dBm/S CS	FFS	FFS	"Off"	Power levels are such that both entry conditions for event A5 (<i>measId</i> 1) is satisfied: $Mp + Hys < Thresh1$ and $Mn + Ofn + Ocn - Hys > Thresh2$
	SINR	dB	FFS	FFS	-	
	Noc	dBm/S CS	FFS		FFS	
T2	SS/PBCH SSS EPRE	dBm/S CS	FFS	"Off"	FFS	Power levels are such that both entry conditions for event A5 (<i>measId</i> 2) is satisfied: $Mp + Hys < Thresh1$ and $Mn + Ofn + Ocn - Hys > Thresh2$
	SINR	dB	FFS	-	FFS	
	Noc	dBm/S CS	FFS		FFS	
NOTE 1: The total tolerance used is the sum of downlink signal level uncertainty (TS 38.508-1 Table 6.2.2.2-TBD) and absolute UE measurement accuracy (TS 38.133 clause 10).						

Table 8.1.3.1.12.3.2-3: Main behaviour

St	Procedure	Message Sequence		TP	Verdict
		U - S	Message		
1	The SS transmits an <i>RRCReconfiguration</i> message on NR Cell 1 including <i>MeasConfig</i> to setup NR measurement and reporting for two event A5 (<i>measId 1</i> and <i>measId 2</i>) (intra and inter frequency measurement).	<-	NR RRC: <i>RRCReconfiguration</i>	-	-
2	The UE transmits an <i>RRCReconfigurationComplete</i> message on NR Cell 1.	-->	NR RRC: <i>RRCReconfigurationComplete</i>	-	-
3	Check: Does the UE transmit a <i>MeasurementReport</i> message on NR Cell 1 within the next 10s?	-->	NR RRC: <i>MeasurementReport</i>	1	F
4	The SS re-adjusts the cell-specific reference signal level according to row "T1" in table 8.1.3.1.12.3.2-1/2.	-	-	-	-
5	Check: Does the UE transmit a <i>MeasurementReport</i> message on NR Cell 1 to report event A3 (<i>measId 1</i>) with the measured SINR values for NR Cell 2?	-->	NR RRC: <i>MeasurementReport</i>	2	P
6	The SS re-adjusts the cell-specific reference signal level according to row "T2" in table 8.1.3.1.12.3.2-1/2.	-	-	-	-
7	Check: Does the UE transmit a <i>MeasurementReport</i> message on NR Cell 1 to report event A5 (<i>measId 2</i>) with the measured SINR values for NR Cell 3?	-->	NR RRC: <i>MeasurementReport</i>	2	P

8.1.3.1.12.3.3 Specific message contents

Table 8.1.3.1.12.3.3-1: *RRCReconfiguration* (step 1, Table 8.1.3.1.12.3.2-3)

Derivation Path: 38.508-1 [4] table 4.6.1-13 with condition NR_MEAS

Table 8.1.3.1.12.3.3-2: MeasConfig (step 1, Table 8.1.3.1.12.3.2-3)

Derivation path: 38.508-1 [4] table 4.6.3-69			
Information Element	Value/Remark	Comment	Condition
MeasConfig ::= SEQUENCE {			
measObjectToAddModList SEQUENCE (SIZE (1..maxNrofMeasId)) OF MeasObjectToAddMod {	2 entries		
MeasObjectToAddMod[1] SEQUENCE {		entry 1	
measObjectId	1		
measObject CHOICE {			
measObjectNR	MeasObjectNR-f1	Table 8.1.3.1.12.3.3-3	
}			
}			
MeasObjectToAddMod[2] SEQUENCE {		entry 2	
measObjectId	2		
measObject CHOICE {			
measObjectNR	MeasObjectNR-f2	Table 8.1.3.1.12.3.3-4	
}			
}			
}			
reportConfigToAddModList SEQUENCE(SIZE (1..maxReportConfigId)) OF ReportConfigToAddMod {	1 entry		
ReportConfigToAddMod[1] SEQUENCE {		entry 1	
reportConfigId	ReportConfigId		
reportConfig CHOICE {			
reportConfigNR	ReportConfigNR-A5	Table 8.1.3.1.12.3.3-6	
}			
}			
}			
measIdToAddModList SEQUENCE (SIZE (1..maxNrofMeasId)) OF MeasIdToAddMod {	2 entries		
MeasIdToAddMod[1] SEQUENCE {		entry 1	
measId	1		
measObjectId	1		
reportConfigId	ReportConfigId		
}			
MeasIdToAddMod[2] SEQUENCE {		entry 2	
measId	2		
measObjectId	2		
reportConfigId	ReportConfigId		
}			
}			
measGapConfig	MeasGapConfig	Table 8.1.3.1.12.3.3-5	
}			

Table 8.1.3.1.12.3.3-3: MeasObjectNR-f1 (Table 8.1.3.1.12.3.3-2)

Derivation Path: TS 38.508-1 [4], Table 4.6.3-76			
Information Element	Value/remark	Comment	Condition
MeasObjectNR ::= SEQUENCE {			
ssbFrequency	Downlink ARFCN of NR Cell 1 SSB		
absThreshSS-BlocksConsolidation	Not present		
}			

Table 8.1.3.1.12.3.3-3A: MeasObjectNR-f2 (Table 8.1.3.1.12.3.3-2)

Derivation Path: TS 38. 508-1 [4], Table 4.6.3-76			
Information Element	Value/remark	Comment	Condition
MeasObjectNR ::= SEQUENCE {			
ssbFrequency	Downlink ARFCN of NR Cell 3 SSB		
absThreshSS-BlocksConsolidation	Not present		
}			

Table 8.1.3.1.12.3.3-4: MeasGapConfig (Table 8.1.3.1.12.3.3-2)

Derivation Path: 38.508-1 [4], Table 4.6.3-70			
Information Element	Value/remark	Comment	Condition
MeasGapConfig ::= SEQUENCE {			
gapUE CHOICE {			
setup SEQUENCE {			
gapOffset	9		
mgl	ms6		
mgrp	ms160		
mgta	ms0dot25		FR2
	ms0dot5		FR1
}			
}			
}			

Table 8.1.3.1.12.3.3-5: ReportConfigNR-A5 (Table 8.1.3.1.12.3.3-2)

Derivation Path: 38.508-1 [4] table 4.6.3-142 with condition EVENT_A5			
Information Element	Value/remark	Comment	Condition
ReportConfigNR ::= SEQUENCE {			
reportType CHOICE {			
eventTriggered SEQUENCE {			
eventId CHOICE {			
eventA5 SEQUENCE {			
a5-Threshold1 CHOICE {			
sinr	68	11 dB	
}			
a5-Threshold2 CHOICE {			
sinr	47	0.5 dB	
}			
}			
}			
reportQuantityCell SEQUENCE {			
rsrp	false		
rsrq	false		
sinr	true		
}			
reportAmount	r1		
}			

Table 8.1.3.1.12.3.3-6: MeasurementReport (steps 5 and 7, Table 8.1.3.1.12.3.2-3)

Derivation Path: TS 38.508-1 [4], Table 4.6.1-5A			
Information Element	Value/remark	Comment	Condition
MeasurementReport ::= SEQUENCE {			
criticalExtensions CHOICE {			
measurementReport SEQUENCE {			
measResults SEQUENCE {			
measId	1		Step 5
	2		Step 7
measResultServingMOList SEQUENCE (SIZE (1..maxNrofServingCells)) OF MeasResultServMO {	1 entry		Step 5
MeasResultServMO[1] SEQUENCE {		entry 1	
servCellId	ServCellIndex of NR Cell 1		
measResultServingCell SEQUENCE {			
physCellId	PhysCellId of NR Cell 1		
measResult SEQUENCE {			
cellResults SEQUENCE {			
resultsSSB-Cell SEQUENCE {			
rsrp	(0..127)		
rsrq	(0..127)		
sinr	(0..127)		
}			
}			
}			
}			
}			
measResultNeighCells CHOICE {			
measResultListNR SEQUENCE (SIZE (1..maxCellReport)) OF MeasResultNR {	1 entry		
MeasResultNR[1] SEQUENCE {		entry 1	
physCellId	PhysCellId of NR Cell 2		Step 5
	PhysCellId of NR Cell 3		Step 7
measResult SEQUENCE {			
cellResults SEQUENCE {			
resultsSSB-Cell SEQUENCE {			
rsrp	Not Present		
rsrq	Not Present		
sinr	(0..127)		
}			
resultsCSI-RS-Cell	Not present		
}			
rsIndexResults	Not present		
}			
cgi-Info	Not present		
}			
}			
}			

8.1.3.1.13 Measurement configuration control and reporting / SS/PBCH block based / CSI-RS based intra-frequency measurements / Measurement of Neighbour NR cell

8.1.3.1.13.1 Test Purpose (TP)

(1)

```
with { UE in NR RRC_CONNECTED state and measurement configured for SS/PBCH measurement reporting of
intra-frequency on specified frequency}
ensure that {
  when { SS/PBCH block sorting quantity is above absThreshSS-BlocksConsolidation for each beam of
Neighbour Cell}
  then { UE sends MeasurementReport message containing rsIndexResults with resultsSSB-Indexes}
}
```

(2)

```
with { UE in NR RRC_CONNECTED state and measurement configured for SS/PBCH measurement reporting of
intra-frequency on specified frequency }
ensure that {
  when { SS/PBCH block sorting quantity is below absThreshSS-BlocksConsolidation for one beam of
Neighbour Cell and another beam(s) is above absThreshSS-BlocksConsolidation}
  then { UE sends MeasurementReport message containing rsIndexResults with resultsSSB-Indexes
includes RsIndex above absThreshSS-BlocksConsolidation and excludes RsIndex below absThreshSS-
BlocksConsolidation }
}
```

(3)

```
with { UE in NR RRC_CONNECTED state and measurement configured for CSI-RS measurement reporting of
intra frequency on specified frequency }
ensure that {
  when { CSI-RS sorting quantity is above absThreshCSI-RS-Consolidation for each beam of Neighbour
Cell}
  then { UE sends MeasurementReport message containing rsIndexResults with results CSI-RS-Indexes}
}
```

(4)

```
with { UE in NR RRC_CONNECTED state and measurement configured for CSI-RS measurement reporting of
intra frequency on specified frequency }
ensure that {
  when { CSI-RS sorting quantity is below absThreshCSI-RS-Consolidation for one beam of Neighbour
Cell and another beam(s) is above absThreshCSI-RS-Consolidation }
  then { UE sends MeasurementReport message containing rsIndexResults with results CSI-RS-Indexes
includes RsIndex above absThreshCSI-RS-Consolidation and excludes RsIndex below absThreshCSI-RS-
Consolidation }
}
```

8.1.3.1.13.2 Conformance requirements

References: The conformance requirements covered in the present TC are specified in: TS 38.331, clauses 5.5.5.1 and 5.5.5.2]. Unless otherwise stated these are Rel-15 requirements.

[TS 38.331, clause 5.5.5.1]

The purpose of this procedure is to transfer measurement results from the UE to the network. The UE shall initiate this procedure only after successful security activation.

For the *measId* for which the measurement reporting procedure was triggered, the UE shall set the *measResults* within the *MeasurementReport* message as follows:

- 1> set the *measId* to the measurement identity that triggered the measurement reporting;
- 1> for each serving cell configured with *servingCellMO*:
- 2> if the *reportConfig* associated with the *measId* that triggered the measurement reporting includes *rsType*:

- 3> if the serving cell measurements based on the *rsType* included in the *reportConfig* that triggered the measurement report are available:
 - 4> set the *measResultServingCell* within *measResultServingMOList* to include RSRP, RSRQ and the available SINR of the serving cell, derived based on the *rsType* included in the *reportConfig* that triggered the measurement report;
- 2> else:
 - 3> if SSB based serving cell measurements are available:
 - 4> set the *measResultServingCell* within *measResultServingMOList* to include RSRP, RSRQ and the available SINR of the serving cell, derived based on SSB;
 - 3> else if CSI-RS based serving cell measurements are available:
 - 4> set the *measResultServingCell* within *measResultServingMOList* to include RSRP, RSRQ and the available SINR of the serving cell, derived based on CSI-RS;
- 1> set the *ServingCellId* within *measResultServingMOList* to include for each NR serving cell that is configured with *servingCellMO*, if any;
- 1> if there is at least one applicable neighbouring cell to report:
 - 2> if the *reportType* is set to *eventTriggered* or *periodical*:
 - 3> set the *measResultNeighCells* to include the best neighbouring cells up to *maxReportCells* in accordance with the following:
 - 4> if the *reportType* is set to *eventTriggered*:
 - 5> include the cells included in the *cellsTriggeredList* as defined within the *VarMeasReportList* for this *measId*;
 - 4> for each cell that is included in the *measResultNeighCells*, include the *physCellId*;
 - 4> if the *reportType* is set to *eventTriggered* or *periodical*:
 - 5> for each included cell, include the layer 3 filtered measured results in accordance with the *reportConfig* for this *measId*, ordered as follows:
 - 6> if the *measObject* associated with this *measId* concerns NR:
 - 7> if *rsType* in the associated *reportConfig* is set to *ssb*:
 - 8> set *resultsSSB-Cell* within the *measResult* to include the SS/PBCH block based quantity(ies) indicated in the *reportQuantityCell* within the concerned *reportConfig*, in decreasing order of the sorting quantity, determined as specified in 5.5.5.3, i.e. the best cell is included first;
 - 8> if *reportQuantityRS-Indexes* and *maxNrofRS-IndexesToReport* are configured, include beam measurement information as described in 5.5.5.2;
 - 7> else if *rsType* in the associated *reportConfig* is set to *csi-rs*:
 - 8> set *resultsCSI-RS-Cell* within the *measResult* to include the CSI-RS based quantity(ies) indicated in the *reportQuantityCell* within the concerned *reportConfig*, in decreasing order of the sorting quantity, determined as specified in 5.5.5.3, i.e. the best cell is included first;
 - 8> if *reportQuantityRS-Indexes* and *maxNrofRS-IndexesToReport* are configured, include beam measurement information as described in 5.5.5.2;

[TS 38.331, clause 5.5.5.1]

- 1> increment the *numberOfReportsSent* as defined within the *VarMeasReportList* for this *measId* by 1;

- 1> stop the periodical reporting timer, if running;
- 1> if the *numberOfReportsSent* as defined within the *VarMeasReportList* for this *measId* is less than the *reportAmount* as defined within the corresponding *reportConfig* for this *measId*:
 - 2> start the periodical reporting timer with the value of *reportInterval* as defined within the corresponding *reportConfig* for this *measId*;
- 1> else:
 - 2> if the *reportType* is set to *periodical*:
 - 3> remove the entry within the *VarMeasReportList* for this *measId*;
 - 3> remove this *measId* from the *measIdList* within *VarMeasConfig*;
- 1> if the UE is configured with EN-DC:
 - 2> if SRB3 is configured:
 - 3> submit the *MeasurementReport* message via SRB3 to lower layers for transmission, upon which the procedure ends;
 - 2>else:
 - 3> submit the *MeasurementReport* message via the EUTRA MCG embedded in E-UTRA RRC message *ULInformationTransferMRDC* as specified in TS 36.331 [10].
- 1> else:
 - 2>submit the *MeasurementReport* message to lower layers for transmission, upon which the procedure ends.

[TS 38.331, clause 5.5.5.2]

For beam measurement information to be included in a measurement report the UE shall:

- 1> if *reportType* is set to *eventTriggered*:
 - 2> consider the trigger quantity as the sorting quantity if available , otherwise RSRP as sorting quantity if available, otherwise RSRQ as sorting quantity if available, otherwise SINR as sorting quantity;
- 1> if *reportType* is set to *periodical*:
 - 2> if a single reporting quantity is set to TRUE in *reportQuantityRs-Indexes*;
 - 3> consider the configured single quantity as the sorting quantity;
 - 2> else:
 - 3> if *rsrp* is set to TRUE;
 - 4> consider RSRP as the sorting quantity;
 - 3> else:
 - 4> consider RSRQ as the sorting quantity;
- 1> set *rsIndexResults* to include up to *maxNrofRs-IndexesToReport* SS/PBCH block indexes or CSI-RS indexes in order of decreasing sorting quantity as follows:
 - 2> if the measurement information to be included is based on SS/PBCH block:
 - 3> include within *resultsSSB-Indexes* the index associated to the best beam for that SS/PBCH block sorting quantity and the remaining beams whose sorting quantity is above *absThreshSS-BlocksConsolidation* defined in the *VarMeasConfig* for the corresponding *measObject*;
 - 3> if *includeBeamMeasurements* is configured, include the SS/PBCH based measurement results for the quantities in *reportQuantity-RsIndexes* set to TRUE for each SS/PBCH blockindex;

2> else if the beam measurement information to be included is based on CSI-RS:

3> include within *resultsCSI-RS-Indexes* the index associated to the best beam for that CSI-RS sorting quantity and the remaining beams whose sorting quantity is above *absThreshCSI-RS-Consolidation* defined in the *VarMeasConfig* for the corresponding *measObject*;

3> if *includeBeamMeasurements* is configured, include the CSI-RS based measurement results for the quantities in *reportQuantity-RsIndexes* set to TRUE for each CSI-RS index.

8.1.3.1.13.3 Test description

8.1.3.1.13.3.1 Pre-test conditions

System Simulator:

- NR Cell 1 is the Serving Cell.
- NR Cell 2 is the intra-frequency neighbour cell of NR Cell 1. NR Cell2 has two beams: SSB/CSI-RS index#0 and SSB/CSI-RS index#1

UE:

- None

Preamble:

- The UE is in state 3N-A as defined in TS 38.508-1 [4], subclause 4.4A on NR Cell 1

8.1.3.1.13.3.2 Test procedure sequence

Table 8.1.3.1.13.3.2-1 and Table 8.1.3.1.13.3.2-1A illustrates the downlink power levels to be applied for NR Cell 1 and NR Cell 2 at various time instants of the test execution. Row marked "T0" denotes the conditions after the preamble, while rows marked "T1" and "T2" are to be applied subsequently. The exact instants on which these values shall be applied are described in the texts in this clause.

Table 8.1.3.1.13.3.2-1: Time instances of cell power level and parameter changes for FR1

	Parameter	Unit	NR Cell 1	NR Cell 2	NR Cell 2 Beam 0 (NOTE)	NR Cell 2 Beam 1 (NOTE)	Remark
T0	SS/PBCH SSS EPRE	dBm/SC S	-94	-	-	-	
	Reference Power	dBm/SC S	-	-90	-	-	
	SS/PBCH SSS EPRE, CSI-RS EPRE offset	dB	-	-	-4	-4	
T1	SS/PBCH SSS EPRE	dBm/SC S	-106	-	-	-	$M_n + O_{fn} + O_{cn} - H_{ys} > M_p + O_{fp} + O_{cp} + O_{ff}$ Power level is such that SS/PBCH quality and CSI-RS quality for both beams of NR Cell 2 are above <i>absThreshSS-BlocksConsolidation</i> .
	Reference Power	dBm/SC S	-	-90	-	-	
	SS/PBCH SSS EPRE, CSI-RS EPRE offset	dB	-	-	-4	-4	
T2	SS/PBCH SSS EPRE	dBm/SC S	-106	-	-	-	$M_n + O_{fn} + O_{cn} + H_{ys} < M_p + O_{fp} + O_{cp} + O_{ff}$ Power level is such that SS/PBCH quality and CSI-RS quality for both beams of NR Cell 2 are below <i>absThreshSS-BlocksConsolidation</i>
	Reference Power	dBm/SC S	-	-90	-	-	
	SS/PBCH SSS EPRE, CSI-RS EPRE offset	dB	-	-	-12	-12	
T3	SS/PBCH SSS EPRE	dBm/SC S	-106	-	-	-	Power level is such that SS/PBCH quality and CSI-RS quality for beam 0 of NR Cell 2 is above <i>absThreshSS-BlocksConsolidation</i> and for beam 1 of NR Cell 2 is below <i>absThreshSS-BlocksConsolidation</i> .
	Reference Power	dBm/SC S	-	-90	-	-	
	SS/PBCH SSS EPRE, CSI-RS EPRE offset	dB	-	-	-4	-12	

Table 8.1.3.1.13.3.2-1A: Time instances of cell power level and parameter changes for FR2

	Parameter	Unit	NR Cell 1	NR Cell 2	NR Cell 2 Beam 0 (NOTE)	NR Cell 2 Beam 1 (NOTE)	Remark
T0	SS/PBCH SSS EPRE	dBm/SC S	-82		-	-	
	Reference Power	dBm/SC S	-	-90	-	-	
	SS/PBCH SSS EPRE, CSI-RS EPRE offset	dB	-	-	-1	-1	
T1	SS/PBCH SSS EPRE	dBm/SC S	-100	-	-	-	$Mn + Ofn + Ocn - Hys > Mp + Ofp + Ocp + Off$ Power level is such that SS/PBCH quality and CSI-RS quality for both beams of NR Cell 2 are above <i>absThreshSS-BlocksConsolidation</i> .
	Reference Power	dBm/SC S	-	-90	-	-	
	SS/PBCH SSS EPRE, CSI-RS EPRE offset	dB	-	-	-1	-1	
T2	SS/PBCH SSS EPRE	dBm/SC S	--100	-	-	-	$Mn + Ofn + Ocn + Hys < Mp + Ofp + Ocp + Off$ Power level is such that SS/PBCH quality and CSI-RS quality for both beams of NR Cell 2 are below <i>absThreshSS-BlocksConsolidation</i>
	Reference Power	dBm/SC S	-	-90	-	-	
	SS/PBCH SSS EPRE, CSI-RS EPRE offset	dB	-	-	-10	-10	
T3	SS/PBCH SSS EPRE	dBm/SC S	-	-	-	-	Power level is such that SS/PBCH quality and CSI-RS quality for beam 0 of NR Cell 2 is above <i>absThreshSS-BlocksConsolidation</i> and for beam 1 of NR Cell 2 is below <i>absThreshSS-BlocksConsolidation</i> .
	Reference Power	dBm/SC S	-	-90	-	-	
	SS/PBCH SSS EPRE, CSI-RS EPRE offset	dB	-	-	-1	-10	

Table 8.1.3.1.13.3.2-1: Main behaviour

St	Procedure	Message Sequence		TP	Verdict
		U - S	Message		
1	The SS transmits an NR <i>RRCReconfiguration</i> message including <i>measConfig</i> to setup SS/PBCH block based intra- frequency NR measurement for NR Cell 1 and reporting for event A3.	<-	NR RRC: <i>RRCReconfiguration</i>	-	-
2	The UE transmits an <i>RRCReconfigurationComplete</i> message	-->	NR RRC: <i>RRCReconfigurationComple</i> <i>te</i>	-	-
3	The SS re-adjusts the cell-specific reference signal level according to row "T1".	-	-	-	-
4	Check: Does the UE transmit a <i>MeasurementReport</i> message to report event A3 with the measured results for NR Cell 2 with beam information containing RsIndex[0] and RsIndex[1]?	-->	NR RRC: <i>MeasurementReport</i>	1	P
4A	The SS re-adjusts the cell-specific reference signal level according to the row "T2".	-	-	-	-
4B	Check: Does the UE transmit a <i>MeasurementReport</i> message on NR Cell 1 to report the event A3 during the next 10s?	-	-	1	F
5	The SS re-adjusts the cell-specific reference signal level according to row "T3".	-	-	-	-
6	Check: Does the UE transmit a <i>MeasurementReport</i> message to report event A3 with the measured results for NR Cell 2 with beam information containing RsIndex[0] and excludes RsIndex[1]?	-->	NR RRC: <i>MeasurementReport</i>	2	P
7-8	Void	-	-	-	-
9	The SS transmits an NR <i>RRCReconfiguration</i> including <i>measConfig</i> to setup CSI-RS based intra-frequency NR measurement for NR Cell 1 and reporting for event A3.	<-	NR RRC: <i>RRCReconfiguration</i>	-	-
10	The UE transmits an <i>RRCConfigurationComplete</i> .	-->	NR RRC: <i>RRCReconfigurationComple</i> <i>te</i>	-	-
11	The SS re-adjusts the cell-specific reference signal level according to row "T1".	-	-	-	-
12	Check: Does the UE transmit a <i>MeasurementReport</i> message to report event A3 with the measured results for NR Cell 2 with beam information containing RsIndex[0] and RsIndex[1]?	-->	NR RRC: <i>MeasurementReport</i>	3	P
12A	The SS re-adjusts the cell-specific reference signal level according to the row "T2".	-	-	-	-
12B	Check: Does the UE transmit a <i>MeasurementReport</i> message on NR Cell 1 to report the event A3 during the next 10s?	-	-	1	F
13	The SS re-adjusts the cell-specific reference signal level according to row "T3".	-	-	-	-
14	Check: Does the UE transmit a <i>MeasurementReport</i> message to report event A3 with the measured results for NR Cell 2 with beam information containing RsIndex[0] and excludes RsIndex[1]?	-->	NR RRC: <i>MeasurementReport</i>	4	P

8.1.3.1.13.3.3 Specific message contents

Table 8.1.3.1.13.3.3-1: RRCReconfiguration (steps 1, 9)

Derivation Path: 38.508-1 [4] Table 4.6.1-13 with condition NR_MEAS

Table 8.1.3.1.13.3.3-2: MeasConfig (Table 8.1.3.1.13.3.3-1)

Derivation Path: 38.508-1 [4], Table 4.6.3-69			
Information Element	Value/remark	Comment	Condition
MeasConfig ::= SEQUENCE {			
measObjectToAddModList	IdMeasObjectToAdd		Step 1
	Not present		Step 9
reportConfigToAddModList	IdReportConfigToAdd		Step 1
	Not present		Step 9
}			

Table 8.1.3.1.13.3.3-3: IdMeasObjectToAdd (Table 8.1.3.1.13.3.3-2)

Derivation Path: TS 38.331 [6], clause 6.3.2			
Information Element	Value/remark	Comment	Condition
MeasObjectToAddModList ::= SEQUENCE (SIZE (1..maxNrofMeasId)) OF MeasObjectToAddMod {	1 entry		
MeasObjectToAddMod[1] SEQUENCE {		entry 1	
measObjectId	1		
measObject CHOICE {			
measObjectNR	Id-MeasObjectNR		
}			
}			
}			

Table 8.1.3.1.13.3.3-4: Id-MeasObjectNR (Table 8.1.3.1.13.3.3-3)

Derivation Path: 38.508-1 [4], Table 4.6.3-76			
Information Element	Value/remark	Comment	Condition
MeasObjectNR ::= SEQUENCE {			
ssbFrequency	Downlink ARFCN of NR Cell1		
refFreqCSI-RS	Same as "Point A" defined for the downlink of NR Cell1		
referenceSignalConfig SEQUENCE {			
ssb-ConfigMobility SEQUENCE {			
ssb-ToMeasure CHOICE {			
setup CHOICE {			
shortBitmap	1100		(FREQ<=3G Hz AND (FR1_FDD OR NOT CASE_C)) OR (FREQ<=2.4 GHz AND FR1_TDD)
mediumBitmap	11000000		(FREQ>3G Hz AND FR1) OR (FREQ>2.4 GHz AND FR1_TDD AND CASE_C)
longBitmap	11000000 00000000 00000000 00000000 00000000 00000000 00000000 00000000		FR2
}			
}			
}			
csi-rs-ResourceConfigMobility CHOICE {			
setup SEQUENCE {			
subcarrierSpacing	SubcarrierSpacing		
csi-RS-CellList-Mobility SEQUENCE (SIZE (1..maxNrofCSI-RS-CellsRRM)) OF CSI-RS-CellMobility {	2 entries		
CSI-RS-CellMobility[1] SEQUENCE {		entry 1	
cellId	Physical CellID of the NR Cell 1		
csi-rs-MeasurementBW SEQUENCE {			
nrofPRBs	size24		
startPRB	same value as 'offsetToCarrier' as defined for the DL frequency of NR Cell 1		
}			
density	d3		
csi-rs-ResourceList-Mobility SEQUENCE (SIZE (1..maxNrofCSI-RS-ResourcesRRM)) OF CSI-RS-Resource-Mobility {	1 entry		
RS-Resource-Mobility[1] SEQUENCE {		entry 1	
csi-RS-Index	0		
slotConfig CHOICE {			
ms20	0	To avoid collision with CSI-RS of NR Cell 2	
}			
associatedSSB	Not present		
}			
}			
associatedSSB SEQUENCE {			pc_csi_RSR

			P_AndRSR Q_MeasWit hSSB
ssb-Index	0		
isQuasiColocated	false		
}			
frequencyDomainAllocation CHOICE {			
row1	1000		
}			
firstOFDMSymbolInTimeDomain	4		
sequenceGenerationConfig	24		
}			
}			
CSI-RS-CellMobility[2] SEQUENCE {		entry 2	
cellId	Physical CellID of the NR Cell 2		
csi-rs-MeasurementBW SEQUENCE {			
nrofPRBs	size24		
startPRB	same value as 'offsetToCarrier' as defined for the DL frequency of the cell		
}			
density	d3		
csi-rs-ResourceList-Mobility SEQUENCE (SIZE (1..maxNrofCSI-RS-ResourcesRRM)) OF CSI- RS-Resource-Mobility {	2 entries		
RS-Resource-Mobility[1] SEQUENCE {		entry 1	
csi-RS-Index	0	CSI-RS with Index 0	
slotConfig CHOICE {			
ms20	$10 * 2^\mu$	μ is numerology index (SCS=15kHz: 0, SCS=30kHz: 1, etc.)	
}			
}			
associatedSSB	Not present		
associatedSSB SEQUENCE {			pc_csi_RSR P_AndRSR Q_MeasWit hSSB
ssb-Index	0		
isQuasiColocated	false		
}			
frequencyDomainAllocation CHOICE {			
row1	1000		
}			
firstOFDMSymbolInTimeDomain	4		
sequenceGenerationConfig	24		
}			
RS-Resource-Mobility[2] SEQUENCE {		entry 2	
csi-RS-Index	1	CSI-RS with Index 1	
slotConfig CHOICE {			
ms20	$10 * 2^\mu$	μ : numerology index (SCS=15kHz: 0, SCS=30kHz: 1, etc.)	
}			
}			
associatedSSB	Not present		
associatedSSB SEQUENCE {			pc_csi_RSR P_AndRSR Q_MeasWit

			hSSB
ssb-Index	1		
isQuasiColocated	false		
}			
frequencyDomainAllocation CHOICE {			
row1	0001		
}			
firstOFDMSymbolInTimeDomain	0		
sequenceGenerationConfig	24		
}			
}			
}			
}			
}			
}			
absThreshSS-BlocksConsolidation SEQUENCE {			
thresholdRSRP	57	corresponding to -100dBm	FR1
	66 +Delta(NRf1)	corresponding to -91dBm	FR2
}			
}			
NOTE 1: delta(NRf1) is derived based on calibration procedure defined in the TS 38.508-1 [4], clause 6.1.3.3 on NR Cell1			

Table 8.1.3.1.13.3.3-5: IdReportConfigToAdd (Table 8.1.3.1.13.3.3-2)

Derivation Path: TS 38.331 [6], clause 6.3.2			
Information Element	Value/remark	Comment	Condition
ReportConfigToAddModList ::= SEQUENCE(SIZE (1..maxReportConfigId)) OF ReportConfigToAddMod {	2 entries		
ReportConfigToAddMod[1] SEQUENCE {		entry 1	
reportConfigId	1		
reportConfig CHOICE {			
reportConfigNR	IdReportConfig-A3-SSB		
}			
}			
ReportConfigToAddMod[2] SEQUENCE {		entry 2	
reportConfigId	2		
reportConfig CHOICE {			
reportConfigNR	IdReportConfig-A3-CSI-RS		
}			
}			
}			

Table 8.1.3.1.13.3.3-6: IdReportConfig-A3-SSB (Table 8.1.3.1.13.3.3-5)

Derivation Path: 38.508-1 [4], Table 4.6.3-142 with condition EVENT_A3			
Information Element	Value/remark	Comment	Condition
ReportConfigNR ::= SEQUENCE {			
reportType CHOICE {			
eventTriggered SEQUENCE {			
eventId CHOICE {			
eventA3 SEQUENCE {			
a3-Offset CHOICE {			
rsrp	2		
	2+ Delta(NRf ₂) - Delta(NRf ₁)	a3-Offset value set to (2+ Delta(NRf ₂) - Delta(NRf ₁)). (Note 1)	FR2
}			
}			
}			
reportAmount	r1		
reportQuantityRS-Indexes SEQUENCE {			
rsrp	true		
rsrq	false		
sinr	false		
}			
maxNrofRS-IndexesToReport	2		
includeBeamMeasurements	true		
}			
}			
Note 1: Void			
Note 2: Delta(NRf ₂) and Delta(NRf ₁) are derived based on calibration procedure defined in the TS 38.508-1 [4], clause 6.1.3.3 where Delta(NRf ₁) is derived for the carrier of NR PCell and Delta(NRf ₂) is derived for the carrier of neighbour cell			

Table 8.1.3.1.13.3.3-8: MeasurementReport (step 4, Table 8.1.3.1.13.3.2-1)

Derivation Path: 38.508-1 [4], Table 4.6.1-7			
Information Element	Value/remark	Comment	Condition
MeasurementReport ::= SEQUENCE {			
criticalExtensions CHOICE {			
measurementReport SEQUENCE {			
measResults	MeasResults		
}			
}			
}			

Table 8.1.3.1.13.3.3-9: MeasResults (Table 8.1.3.1.13.3.3-8)

Derivation Path: 38.508-1 [4], Table 4.6.3-79			
Information Element	Value/remark	Comment	Condition
MeasResults ::= SEQUENCE {			
measId	1		
measResultServingMOList SEQUENCE (SIZE (1..maxNrofServingCells)) OF MeasResultServMO {	1 entry		
MeasResultServMO[1] SEQUENCE {		entry 1	
servCellId	ServCellIndex of NR Cell 1		
measResultServingCell SEQUENCE {			
physCellId	Physical CellID of the NR Cell 1		
measResult SEQUENCE {			
cellResults SEQUENCE {			
resultsSSB-Cell SEQUENCE {			
rsrp	(0..127)		
rsrq	(0..127)		
sinr	(0..127)		pc_ss_SINR Meas
Not present			
}			
}			
rsIndexResults SEQUENCE {			
resultsSSB-Indexes SEQUENCE (SIZE (1..maxNrofIndexesToReport2)) OF ResultsPerSSB-Index {	1 entry		
ResultsPerSSB-Index[1] SEQUENCE {		entry 1	
ssb-Index	Not checked		
ssb-Results SEQUENCE {			
rsrp	(0..127)		
rsrq	Not present		
sinr	Not present		
}			
}			
resultsCSI-RS-Indexes	Not present		
}			
}			
}			
measResultNeighCells CHOICE {			
measResultListNR SEQUENCE (SIZE (1..maxCellReport)) OF MeasResultNR {	1 entry		
MeasResultNR[1] SEQUENCE {		entry 1	
physCellId	Physical CellID of the NR Cell 2		
measResult SEQUENCE {			
cellResults SEQUENCE {			
resultsSSB-Cell SEQUENCE {			
rsrp	(0..127)		
rsrq	(0..127)		
sinr	(0..127)		pc_ss_SINR Meas
Not present			
}			
resultsCSI-RS-Cell	Not present		
}			
rsIndexResults SEQUENCE {			
resultsSSB-Indexes SEQUENCE (SIZE (1..maxNrofIndexesToReport2)) OF ResultsPerSSB-Index {	2 entries that may appear in an arbitrary order		
ResultsPerSSB-Index [1] SEQUENCE {		entry 1	
ssb-Index	SSB index 0		
ssb-Results SEQUENCE {			
rsrp	(0..127)		

rsrq	Not present		
sinr	Not present		
}			
}			
ResultsPerSSB-Index [2] SEQUENCE {		entry 2	
ssb-Index	SSB index 1		
ssb-Results SEQUENCE {			
rsrp	(0..127)		
rsrq	Not present		
sinr	Not present		
}			
}			
}			
resultsCSI-RS-Indexes	Not present		
}			
}			
cgi-Info	Not present		
}			
}			
}			

Table 8.1.3.1.13.3.3-10: MeasurementReport (step 6, Table 8.1.3.1.13.3.2-2)

Derivation Path: 38.508-1 [4], Table 4.6.1-7			
Information Element	Value/remark	Comment	Condition
MeasurementReport ::= SEQUENCE {			
criticalExtensions CHOICE {			
measurementReport SEQUENCE {			
measResults	MeasResults		
}			
}			
}			

ssb-Results[1] SEQUENCE {			
rsrp	(0..127)		
rsrq	Not present		
sinr	Not present		
}			
}			
resultsCSI-RS-Indexes	Not present		
}			
}			
cgi-Info	Not present		
}			
}			
}			
}			

Table 8.1.3.1.13.3.3-12: Void

Table 8.1.3.1.13.3.3-13: Void

Table 8.1.3.1.13.3.3-14: Void

Table 8.1.3.1.13.3.3-15: Void

Table 8.1.3.1.13.3.3-16: Void

Table 8.1.3.1.13.3.3-17: Void

Table 8.1.3.1.13.3.3-18: MeasurementReport (step 12, Table 8.1.3.1.13.3.2-1)

Derivation Path: 38.508-1 [4], Table 4.6.1-7			
Information Element	Value/remark	Comment	Condition
MeasurementReport ::= SEQUENCE {			
criticalExtensions CHOICE {			
measurementReport SEQUENCE {			
measResults	MeasResults		
}			
}			
}			
}			

Table 8.1.3.1.13.3.3-19: MeasResults (Table 8.1.3.1.13.3.3-18)

Derivation Path: 38.508-1 [4], Table 4.6.3-79			
Information Element	Value/remark	Comment	Condition
MeasResults ::= SEQUENCE {			
measId	1		
measResultServingMOList SEQUENCE {(SIZE (1..maxNrofServingCells)) OF MeasResultServMO {	1 entry		
MeasResultServMO[1] SEQUENCE {		entry 1	
servCellId	ServCellIndex of NR Cell 1		
measResultServingCell SEQUENCE {			
physCellId	Physical CellID of the NR Cell 1		
measResult SEQUENCE {			
cellResults SEQUENCE {			
resultsSSB-Cell	Not present		
resultsCSI-RS-Cell SEQUENCE {			
rsrp	(0..127)		
rsrq	(0..127)		
sinr	Not present		
}			
}			
rsIndexResults SEQUENCE {			
resultsSSB-Indexes	Not present		
resultsCSI-RS-Indexes SEQUENCE (SIZE (1..maxNrofIndexesToReport2)) OF ResultsPerSSB-Index {	1 entry		
ResultsPerSSB-Index[1] SEQUENCE {		entry 1	
csi-RS-Index	Not checked		
csi-RS-Results SEQUENCE {			
rsrp	(0..127)		
rsrq	(0..127)		
sinr	Not present		
}			
}			
}			
}			
}			
measResultNeighCells CHOICE {			
measResultListNR SEQUENCE (SIZE (1..maxCellReport)) OF MeasResultNR {	1 entry		
MeasResultNR[1] SEQUENCE {		entry 1	
physCellId	Physical CellID of the NR Cell 2		
measResult SEQUENCE {			
cellResults SEQUENCE {			
resultsSSB-Cell	Not present		
resultsCSI-RS-Cell SEQUENCE {			
rsrp	(0..127)		
rsrq	(0..127)		
sinr	Not present		
}			
}			
rsIndexResults SEQUENCE {			
resultsSSB-Indexes	Not Present		
resultsCSI-RS-Indexes SEQUENCE (SIZE (1..maxNrofIndexesToReport2)) OF ResultsPerCSI-RS-Index {	2 entries that may appear in an arbitrary order		
ResultsPerCSI-RS-Index[1] SEQUENCE {		entry 1	
csi-RS-Index	CSI-RS-index 0		
csi-RS-Results SEQUENCE {			
rsrp	Not checked		

rsrq	Not present		
sinr	Not present		
}			
}			
ResultsPerCSI-RS-Index[2] SEQUENCE {		entry 2	
csi-RS-Index	CSI-RS-index 1		
csi-RS-Results SEQUENCE {			
rsrp	Not checked		
rsrq	Not present		
sinr	Not present		
}			
}			
}			
}			
}			
cgi-Info	Not present		
}			
}			
}			
}			

Table 8.1.3.1.13.3.3-20: MeasurementReport (step 14, Table 8.1.3.1.13.3.2-1)

Derivation Path: 38.508-1 [4], Table 4.6.1-7			
Information Element	Value/remark	Comment	Condition
MeasurementReport ::= SEQUENCE {			
criticalExtensions CHOICE {			
measurementReport SEQUENCE {			
measResults	MeasResults		
}			
}			
}			

Table 8.1.3.1.13.3.3-21: MeasResults (Table 8.1.3.1.13.3.3-20)

Derivation Path: 38.508-1 [4], Table 4.6.3-79			
Information Element	Value/remark	Comment	Condition
MeasResults ::= SEQUENCE {			
measId	1		
measResultServingMOList SEQUENCE (SIZE (1..maxNrofServingCells)) OF MeasResultServMO {	1 entry		
MeasResultServMO[1] SEQUENCE {		entry 1	
servCellId	ServCellIndex of NR Cell 1		
measResultServingCell SEQUENCE {			
physCellId	Physical CellID of the NR Cell 1		
measResult SEQUENCE {			
cellResults SEQUENCE {			
resultsSSB-Cell	Not present		
resultsCSI-RS-Cell SEQUENCE {			
rsrp	(0..127)		
rsrq	(0..127)		
sinr	Not present		
}			
}			
rsIndexResults SEQUENCE {			
resultsSSB-Indexes	Not present		
resultsCSI-RS-Indexes SEQUENCE (SIZE (1..maxNrofIndexesToReport2)) OF ResultsPerSSB-Index {	1 entry		
ResultsPerSSB-Index[1] SEQUENCE {		entry 1	
csi-RS-Index	Not checked		
csi-RS-Results SEQUENCE {			
rsrp	(0..127)		
rsrq	Not present		
sinr	Not present		
}			
}			
}			
}			
}			
measResultNeighCells CHOICE {			
measResultListNR SEQUENCE (SIZE (1..maxCellReport)) OF MeasResultNR {	1 entry		
MeasResultNR[1] SEQUENCE {		entry 1	
physCellId	Physical CellID of the NR Cell 2		
measResult SEQUENCE {			
cellResults SEQUENCE {			
resultsSSB-Cell	Not present		
resultsCSI-RS-Cell SEQUENCE {			
rsrp	(0..127)		
rsrq	(0..127)		
sinr	Not present		
}			
}			
}			
}			
rsIndexResults SEQUENCE {			
resultsSSB-Indexes	Not Present		
resultsCSI-RS-Indexes SEQUENCE (SIZE (1..maxNrofIndexesToReport2)) OF ResultsPerSSB-Index {	1 entry		
ResultsPerSSB-Index[1] SEQUENCE {		entry 1	
csi-RS-Index	CSI-RS-Index 0		
csi-RS-Results SEQUENCE {			

rsrp	(0..127)		
rsrq	Not present		
sinr	Not present		
}			
}			
}			
}			
cgi-Info	Not present		
}			
}			
}			
}			

8.1.3.1.14 Void

8.1.3.1.14A Measurement configuration control and reporting / SS/PBCH block based / CSI-RS based inter-frequency measurements / Measurement of Neighbour NR cell

8.1.3.1.14A.1 Test Purpose (TP)

(1)

```
with { UE in NR RRC_CONNECTED state and measurement configured for SS/PBCH measurement reporting of
inter-frequency on specified frequency }
ensure that {
  when { SS/PBCH block sorting quantity is above absThreshSS-BlocksConsolidation for each beam of
Neighbour Cell }
  then { UE sends MeasurementReport message containing rsIndexResults with resultsSSB-Indexes }
}
```

(2)

```
with { UE in NR RRC_CONNECTED state and measurement configured for SS/PBCH measurement reporting of
inter-frequency on specified frequency }
ensure that {
  when { SS/PBCH block sorting quantity is below absThreshSS-BlocksConsolidation for one beam of
Neighbour Cell and another beam(s) is above absThreshSS-BlocksConsolidation }
  then { UE sends MeasurementReport message containing rsIndexResults with resultsSSB-Indexes
includes RsIndex above absThreshSS-BlocksConsolidation and excludes RsIndex below absThreshSS-
BlocksConsolidation }
}
```

(3)

```
with { UE in NR RRC_CONNECTED state and measurement configured for CSI-RS measurement reporting of
inter frequency on specified frequency }
ensure that {
  when { CSI-RS sorting quantity is above absThreshCSI-RS-Consolidation for each beam of Neighbour
Cell }
  then { UE sends MeasurementReport message containing rsIndexResults with resultsCSI-RS-Indexes }
}
```

(4)

```
with { UE in NR RRC_CONNECTED state and measurement configured for CSI-RS measurement reporting of
inter frequency on specified frequency }
ensure that {
  when { CSI-RS sorting quantity is below absThreshCSI-RS-Consolidation for one beam of Neighbour
Cell and another beam(s) is above absThreshCSI-RS-Consolidation }
  then { UE sends MeasurementReport message containing rsIndexResults with resultsCSI-RS-Indexes
includes RsIndex above absThreshCSI-RS-Consolidation and excludes RsIndex below absThreshCSI-RS-
Consolidation }
}
```

8.1.3.1.14A.2 Conformance requirements

Same as TC 8.1.3.1.13

8.1.3.1.14A.3 Test description

8.1.3.1.14A.3.1 Pre-test conditions

Same as TC 8.1.3.1.13 with the following differences:

- Cells configuration: NR Cell 3 replaces NR Cell 2.
- System information combination NR-4 as defined in TS 38.508-1[4] clause 4.4.3.1.2 is used in NR cells.

8.1.3.1.14A.3.2 Test procedure sequence

Same as TC 8.1.3.1.13 with the following differences:

- Cells configuration: NR Cell 3 replaces NR Cell 2

8.1.3.1.14A.3.3 Specific message contents

Same as TC 8.1.3.1.13 with the following differences:

- Cells configuration: NR Cell 3 replaces NR Cell 2

Table 8.1.3.1.14A.3.3-1: IdMeasObjectToAdd (Table 8.1.3.1.13.3.3-2)

Derivation Path: TS 38.331 [6], clause 6.3.2			
Information Element	Value/remark	Comment	Condition
MeasObjectToAddModList ::= SEQUENCE (SIZE (1..maxNrofMeasId)) OF MeasObjectToAddMod {	2 entries		
MeasObjectToAddMod[1] SEQUENCE {		entry 1	
measObjectId	1		
measObject CHOICE {			
measObjectNR	Id-MeasObjectNR-f1		
}			
}			
MeasObjectToAddMod[2] SEQUENCE {		entry 2	
measObjectId	2		
measObject CHOICE {			
measObjectNR	Id-MeasObjectNR-f2		
}			
}			
}			

		90dBm	
thresholdRSRQ	Not Present		
thresholdSINR	Not Present		
}			
nrofCSI-RS-ResourcesToAverage	2		
}			

Table 8.1.3.1.14A.3.3-2: Id-MeasObjectNR-f2 (Table 8.1.3.1.14A.3.3-1)

Derivation Path: 38.508-1 [4], Table 4.6.3-76			
Information Element	Value/remark	Comment	Condition
MeasObjectNR ::= SEQUENCE {			
ssbFrequency	Downlink ARFCN of NR Cell3		
refFreqCSI-RS	Same as "Point A" defined for the downlink of NR Cell3		
referenceSignalConfig SEQUENCE {			
ssb-ConfigMobility SEQUENCE {			
ssb-ToMeasure CHOICE {			
setup CHOICE {			
shortBitmap	1100		(FREQ<=3G Hz AND (FR1_FDD OR NOT CASE_C)) OR (FREQ<=2.4 GHz AND FR1_TDD)
mediumBitmap	11000000		(FREQ>3G Hz AND FR1) OR (FREQ>2.4 GHz AND FR1_TDD AND CASE_C)
longBitmap	11000000 00000000 00000000 00000000 00000000 00000000 00000000 00000000		FR2
}			
}			
}			
csi-rs-ResourceConfigMobility CHOICE {			
setup SEQUENCE {			
subcarrierSpacing	SubcarrierSpacing		
csi-RS-CellList-Mobility SEQUENCE (SIZE (1..maxNrofCSI-RS-CellsRRM)) OF CSI-RS-CellMobility {	1 entry		
CSI-RS-CellMobility[1] SEQUENCE {		entry 1	
cellId	Physical CellID of the NR Cell 3		
csi-rs-MeasurementBW SEQUENCE {			
nrofPRBs	size24		
startPRB	same value as 'offsetToCarrier' as defined for the DL frequency of the cell		
}			
density	d3		
csi-rs-ResourceList-Mobility SEQUENCE (SIZE (1.. maxNrofCSI-RS-ResourcesRRM)) OF CSI-RS-Resource-Mobility {	2 entries		
CSI-RS-Resource-Mobility[1] SEQUENCE {		entry 1	
csi-RS-Index	0	CSI-RS with Index 0	
slotConfig CHOICE {			
ms20	$10 * 2^\mu$	μ is numerology index (SCS=15kHz: 0, SCS=30kHz: 1, etc.)	

}			
associatedSSB	Not present		
associatedSSB SEQUENCE {			pc_csi_RSR P_AndRSR Q_MeasWit hSSB
ssb-Index	0		
isQuasiColocated	false		
}			
frequencyDomainAllocation CHOICE {			
row1	1000		
}			
firstOFDMSymbolInTimeDomain	4		
sequenceGenerationConfig	24		
}			
CSI-RS-Resource-Mobility[2] SEQUENCE {		entry 2	
csi-RS-Index	1	CSI-RS with Index 1	
slotConfig CHOICE {			
ms20	$10 * 2^\mu$	μ : numerology index (SCS=15kHz: 0, SCS=30kHz: 1, etc.)	
}			
associatedSSB	Not present		
associatedSSB SEQUENCE {			pc_csi_RSR P_AndRSR Q_MeasWit hSSB
ssb-Index	1		
isQuasiColocated	false		
}			
frequencyDomainAllocation CHOICE {			
row1	0001		
}			
firstOFDMSymbolInTimeDomain	0		
sequenceGenerationConfig	24		
}			
}			
}			
}			
}			
}			
}			
absThreshSS-BlocksConsolidation SEQUENCE {			
thresholdRSRP	57	corresponding to - 100dBm	FR1
	66 +Delta(NRf2)	corresponding to - 91dBm	FR2
}			
absThreshCSI-RS-Consolidation SEQUENCE {			
thresholdRSRP	57	corresponding to - 99dBm	FR1
	66	corresponding to - 90dBm	FR2
thresholdRSRQ	Not Present		
thresholdSINR	Not Present		
}			
nrofCSI-RS-ResourcesToAverage	2		
}			
NOTE 1: Delta(NRf2) is derived based on calibration procedure defined in the TS 38.508-1 [4], clause 6.1.3.3 on NR Cell3			

Table 8.1.3.1.14A.3.3-3: Void

Table 8.1.3.1.14A.3.3-4: IdMeasIdToAdd (Table 8.1.3.1.13.3.3-2)

Derivation Path: TS 38.331 [6], clause 6.3.2			
Information Element	Value/remark	Comment	Condition
MeasIdToAddModList ::= SEQUENCE (SIZE (1..maxNrofMeasId)) OF MeasIdToAddMod {	1 entry		
MeasIdToAddMod[1] SEQUENCE {		entry 1	
measId	1		
measObjectId	2		
reportConfigId	1		Step 1
	2		Step 9
}			
}			

Table 8.1.3.1.14A.3.3-5: Void

Table 8.1.3.1.14A.3.3-6: Void

8.1.3.1.15 Void

8.1.3.1.15A Measurement configuration control and reporting / Intra NR measurements / Blacklisting

8.1.3.1.15A.1 Test Purpose (TP)

(1)

```
with { UE in NR RRC_CONNECTED state and measurement configured for event A3 reporting }
ensure that {
  when { Blacklisted neighbour cell satisfies entry condition for event A3 }
  then { It is not considered in event evaluation and UE does not send MeasurementReport message }
}
```

(2)

```
with { UE in NR RRC_CONNECTED state and measurement reporting triggered by event A3 is ongoing and
no neighbour cells are blacklisted }
ensure that {
  when { Neighbour cells satisfies entry condition for event A3 }
  then { Neighbour cells are considered in measurement reporting }
}
```

8.1.3.1.15A.2 Conformance requirements

References: The conformance requirements covered in the current TC are specified in: TS 38.331, clauses 5.5.1, 5.5.4.1, and 5.5.5. Unless otherwise stated these are Rel-15 requirements.

[TS 38.331, clause 5.5.1]

The network may configure an RRC_CONNECTED UE to perform measurements and report them in accordance with the measurement configuration. The measurement configuration is provided by means of dedicated signalling i.e. using the *RRCReconfiguration*

...

- For intra-frequency and inter-frequency measurements a measurement object indicates the frequency/time location and subcarrier spacing of reference signals to be measured. Associated with this measurement object,

the network may configure a list of cell specific offsets, a list of 'blacklisted' cells and a list of 'whitelisted' cells. Blacklisted cells are not applicable in event evaluation or measurement reporting. Whitelisted cells are the only ones applicable in event evaluation or measurement reporting.

...

[TS 38.331, clause 5.5.4.1]

The UE shall:

1> for each measId included in the measIdList within VarMeasConfig:

...

2> if the corresponding reportConfig includes a reportType set to eventTriggered or periodical;

3> if the corresponding measObject concerns NR;

3> if the corresponding measObject concerns EUTRA:

4> consider any neighbouring cell detected based on parameters in the associated measObjectNR to be applicable when the concerned cell is not included in the blackCellsToAddModList defined within the VarMeasConfig for this measId;

...

2> if the reportType is set to eventTriggered and if the entry condition applicable for this event, i.e. the event corresponding with the eventId of the corresponding reportConfig within VarMeasConfig, is fulfilled for one or more applicable cells for all measurements after layer 3 filtering taken during timeToTrigger defined for this event within the VarMeasConfig, while the VarMeasReportList does not include a measurement reporting entry for this measId (a first cell triggers the event):

3> include a measurement reporting entry within the VarMeasReportList for this measId;

3> set the numberOfReportsSent defined within the VarMeasReportList for this measId to 0;

3> include the concerned cell(s) in the cellsTriggeredList defined within the VarMeasReportList for this measId;

3> initiate the measurement reporting procedure, as specified in 5.5.5;

2> else if the reportType is set to eventTriggered and if the entry condition applicable for this event, i.e. the event corresponding with the eventId of the corresponding reportConfig within VarMeasConfig, is fulfilled for one or more applicable cells not included in the cellsTriggeredList for all measurements after layer 3 filtering taken during timeToTrigger defined for this event within the VarMeasConfig (a subsequent cell triggers the event):

3> set the numberOfReportsSent defined within the VarMeasReportList for this measId to 0;

3> include the concerned cell(s) in the cellsTriggeredList defined within the VarMeasReportList for this measId;

3> initiate the measurement reporting procedure, as specified in 5.5.5;

2> else if the reportType is set to eventTriggered and if the leaving condition applicable for this event is fulfilled for one or more of the cells included in the cellsTriggeredList defined within the VarMeasReportList for this measId for all measurements after layer 3 filtering taken during timeToTrigger defined within the VarMeasConfig for this event:

3> remove the concerned cell(s) in the cellsTriggeredList defined within the VarMeasReportList for this measId;

3> if reportOnLeave is set to TRUE for the corresponding reporting configuration:

4> initiate the measurement reporting procedure, as specified in 5.5.5;

3> if the cellsTriggeredList defined within the VarMeasReportList for this measId is empty:

- 4> remove the measurement reporting entry within the *VarMeasReportList* for this *measId*;
- 4> stop the periodical reporting timer for this *measId*, if running;

...

[TS 38.331, clause 5.5.5.1]

The purpose of this procedure is to transfer measurement results from the UE to the network. The UE shall initiate this procedure only after successful security activation.

For the *measId* for which the measurement reporting procedure was triggered, the UE shall set the *measResults* within the *MeasurementReport* message as follows:

- 1> set the *measId* to the measurement identity that triggered the measurement reporting;
- 1> for each serving cell configured with *servingCellMO*:
 - 2> if the *reportConfig* associated with the *measId* that triggered the measurement reporting includes *rsType*:
 - 3> if the serving cell measurements based on the *rsType* included in the *reportConfig* that triggered the measurement report are available:
 - 4> set the *measResultServingCell* within *measResultServingMOList* to include RSRP, RSRQ and the available SINR of the serving cell, derived based on the *rsType* included in the *reportConfig* that triggered the measurement report;
- ...
- 1> set the *servCellId* within *measResultServingMOList* to include each NR serving cell that is configured with *servingCellMO*, if any;
- ...
- 1> if there is at least one applicable neighbouring cell to report:
 - 2> set the *measResultNeighCells* to include the best neighbouring cells up to *maxReportCells* in accordance with the following:
 - 3> if the *reportType* is set to *eventTriggered*:
 - 4> include the cells included in the *cellsTriggeredList* as defined within the *VarMeasReportList* for this *measId*;
 - 3> else:
 - ...
 - 3> for each cell that is included in the *measResultNeighCells*, include the *physCellId*;
 - 3> if the *reportType* is set to *eventTriggered*:
 - 4> for each included cell, include the layer 3 filtered measured results in accordance with the *reportConfig* for this *measId*, ordered as follows:
 - 5> if the *measObject* associated with this *measId* concerns NR:
 - 6> if *rsType* in the associated *reportConfig* is set to *ssb*:
 - 7> set *resultsSSB-Cell* within the *measResult* to include the SS/PBCH block based quantity(ies) indicated in the *reportQuantityCell* within the concerned *reportConfig*, in order of decreasing trigger quantity, i.e. the best cell is included first;
 - 8> if *reportQuantityRSIndexes* and *maxNrofRSIndexesToReport* are configured, include beam measurement information as described in 5.5.5.2;
 - 1> increment the *numberOfReportsSent* as defined within the *VarMeasReportList* for this *measId* by 1;

- 1> stop the periodical reporting timer, if running;
- 1> if the *numberOfReportsSent* as defined within the *VarMeasReportList* for this *measId* is less than the *reportAmount* as defined within the corresponding *reportConfig* for this *measId*:
 - 2> start the periodical reporting timer with the value of *reportInterval* as defined within the corresponding *reportConfig* for this *measId*;
 - ...
- 1> if the UE is configured with EN-DC:
 - ...
- 1> else:
 - 2> submit the *MeasurementReport* message to lower layers for transmission, upon which the procedure ends.

[TS 38.331, clause 5.5.2.5]

The UE shall:

- 1> for each *measObjectId* included in the received *measObjectToAddModList*:
 - 2> if an entry with the matching *measObjectId* exists in the *measObjectList* within the *VarMeasConfig*, for this entry:
 - 3> reconfigure the entry with the value received for this *measObject*, except for the fields *cellsToAddModList*, *blackCellsToAddModList*, *whiteCellsToAddModList*, *cellsToRemoveList*, *blackCellsToRemoveList* and *whiteCellsToRemoveList*;
 - 3> if the received *measObject* includes the *cellsToRemoveList*:
 - 4> for each *physCellId* included in the *cellsToRemoveList*:
 - 5> remove the entry with the matching *physCellId* from the *cellsToAddModList*;
 - 3> if the received *measObject* includes the *cellsToAddModList*:
 - 4> for each *physCellId* value included in the *cellsToAddModList*:
 - 5> if an entry with the matching *physCellId* exists in the *cellsToAddModList*:
 - 6> replace the entry with the value received for this *physCellId*;
 - 5> else:
 - 6> add a new entry for the received *physCellId* to the *cellsToAddModList*;
 - 3> if the received *measObject* includes the *blackCellsToRemoveList*:
 - 4> for each *pci-RangeIndex* included in the *blackCellsToRemoveList*:
 - 5> remove the entry with the matching *pci-RangeIndex* from the *blackCellsToAddModList*;

NOTE: For each *pci-RangeIndex* included in the *blackCellsToRemoveList* that concerns overlapping ranges of cells, a cell is removed from the black list of cells only if all cell indexes containing it are removed.

- 3> if the received *measObject* includes the *blackCellsToAddModList*:
 - 4> for each *pci-RangeIndex* included in the *blackCellsToAddModList*:
 - 5> if an entry with the matching *pci-RangeIndex* is included in the *blackCellsToAddModList*:
 - 6> replace the entry with the value received for this *pci-RangeIndex*;
 - 5> else:

- 6> add a new entry for the received *pci-RangeIndex* to the *blackCellsToAddModList*;
- 3> for each *measId* associated with this *measObjectId* in the *measIdList* within the *VarMeasConfig*, if any:
 - 4> remove the measurement reporting entry for this *measId* from the *VarMeasReportList*, if included;
 - 4> stop the periodical reporting timer or timer T321, whichever one is running, and reset the associated information (e.g. *timeToTrigger*) for this *measId*;
- 2> else:
 - 3> add a new entry for the received *measObject* to the *measObjectList* within *VarMeasConfig*.

[TS 38.331, clause 5.5.4.4]

The UE shall:

- 1> consider the entering condition for this event to be satisfied when condition A3-1, as specified below, is fulfilled;
- 1> consider the leaving condition for this event to be satisfied when condition A3-2, as specified below, is fulfilled;
- 1> use the SpCell for *Mp*, *Ofp* and *Ocp*.

NOTE The cell(s) that triggers the event has reference signals indicated in the *measObjectNR* associated to this event which may be different from the NR SpCell *measObjectNR*.

Inequality A3-1 (Entering condition)

$$Mn + Ofn + Ocn - Hys > Mp + Ofp + Ocp + Off$$

Inequality A3-2 (Leaving condition)

$$Mn + Ofn + Ocn + Hys < Mp + Ofp + Ocp + Off$$

The variables in the formula are defined as follows:

Mn is the measurement result of the neighbouring cell, not taking into account any offsets.

Ofn is the measurement object specific offset of the reference signal of the neighbour cell (i.e. *offsetMO* as defined within *measObjectNR* corresponding to the neighbour cell).

Ocn is the cell specific offset of the neighbour cell (i.e. *cellIndividualOffset* as defined within *measObjectNR* corresponding to the frequency of the neighbour cell), and set to zero if not configured for the neighbour cell.

Mp is the measurement result of the SpCell, not taking into account any offsets.

Ofp is the measurement object specific offset of the SpCell (i.e. *offsetMO* as defined within *measObjectNR* corresponding to the SpCell).

Ocp is the cell specific offset of the SpCell (i.e. *cellIndividualOffset* as defined within *measObjectNR* corresponding to the SpCell), and is set to zero if not configured for the SpCell.

Hys is the hysteresis parameter for this event (i.e. *hysteresis* as defined within *reportConfigNR* for this event).

Off is the offset parameter for this event (i.e. *a3-Offset* as defined within *reportConfigNR* for this event).

Mn*, *Mp are expressed in dBm in case of RSRP, or in dB in case of RSRQ and RS-SINR.

Ofn*, *Ocn*, *Ofp*, *Ocp*, *Hys*, *Off are expressed in dB.

8.1.3.1.15.3A Test description

8.1.3.1.15.3A.1 Pre-test conditions

System Simulator:

- NR Cell 1, Cell 3 and Cell 12:

- NR Cell 1 is the serving cell
- NR Cell 3 and Cell 12 are inter-frequency neighbour cells
- System information combination NR-4 as defined in TS 38.508-1[4] clause 4.4.3.1.2 is used in NR cells.

UE:

- None

Preamble:

- The UE is in state NR RRC_CONNECTED in Established (state 3) according to [18].

8.1.3.1.15A.3.2 Test procedure sequence

Table 8.1.3.1.15A.3.2-1 illustrates the downlink power levels to be applied for NR Cell 1, Cell 3 and Cell 12 at various time instants of the test execution. Row marked "T0" denotes the conditions after the preamble, while rows marked "T1" and "T2" are to be applied subsequently. The exact instants on which these values shall be applied are described in the texts in this clause.

Table 8.1.3.1.15A.3.2-1: Time instances of cell power level and parameter changes for FR1

	Parameter	Unit	NR Cell 1	NR Cell 3 (DL only)	NR Cell 12 (DL only)	Remark
T0	SS/PBCH SSS EPRE	dBm/ SCS	-85	-97	-97	Power levels are such that leaving condition for event A3 is satisfied for all neighbour NR cells: $Mn + Ofn + Ocn + Hys < Mp + Ofp + Ocp + Off$
T1	SS/PBCH SSS EPRE	dBm/ SCS	-85	-79	-97	Power levels are such that entry condition for event A3 is satisfied for inter-frequency neighbour NR cell 3 [<i>measId 1</i>] $Mn + Ofn + Ocn - Hys > Ms + Of_s + Ocs + Off$
T2	SS/PBCH SSS EPRE	dBm/ SCS	-85	-79	-79	Power levels are such that entry condition for event A3 is satisfied for inter-frequency neighbour NR cell 3 and NR Cell 12 [<i>measId 2</i>] $Mn + Ofn + Ocn - Hys > Ms + Of_s + Ocs + Off$

Table 8.1.3.1.15A.3.2-1A: Time instances of cell power level and parameter changes for FR2

	Parameter	Unit	NR Cell 1	NR Cell 3 (DL only)	NR Cell 12 (DL only)	Remark
T0	SS/PBCH SSS EPRE	dBm/ SCS	FFS	FFS	FFS	Power levels are such that leaving condition for event A3 is satisfied for all neighbour NR cells: $Mn + Ofn + Ocn + Hys < Mp + Ofp + Ocp + Off$
T1	SS/PBCH SSS EPRE	dBm/ SCS	FFS	FFS	FFS	Power levels are such that entry condition for event A3 is satisfied for inter-frequency neighbour NR cell 3 [<i>measId 1</i>] $Mn + Ofn + Ocn - Hys > Ms + Of_s + Ocs + Off$
T2	SS/PBCH SSS EPRE	dBm/ SCS	FFS	FFS	FFS	Power levels are such that entry condition for event A3 is satisfied for intr-frequency neighbour NR cell 3 and NR Cell 12 [<i>measId 2</i>] $Mn + Ofn + Ocn - Hys > Ms + Of_s + Ocs + Off$

Table 8.1.3.1.15A.3.2-2: Main behaviour

St	Procedure	Message Sequence		TP	Verdict
		U - S	Message		
1	SS transmits an <i>RRCReconfiguration</i> message including <i>measConfig</i> to setup intraNR measurement and reporting for event A3.	<--	NR RRC: <i>RRCReconfiguration</i>	-	-
2	The UE transmits an <i>RRCReconfigurationComplete</i> message.	-->	NR RRC: <i>RRCReconfigurationComplete</i>	-	-
3	SS re-adjusts the cell-specific reference signal levels according to row "T1" in table 8.1.31.15A.3.2.-1/1A.	-	-	-	-
4	Check: does the UE transmit a <i>MeasurementReport</i> messages within the next 10s?	-	NR RRC: <i>MeasurementReport</i>	1	F
5	SS re-adjusts the cell-specific reference signal levels according to row "T2" in table 8.1.3.1.15A.3.2.-1/1A.	-	-	-	-
6	Check: does the UE transmit a <i>MeasurementReport</i> message to report event A3 with the measured RSRP values for Cell 1 and Cell 12 without Cell 3 results?	-->	NR RRC: <i>MeasurementReport</i>	1	P
7	SS transmits an <i>RRCReconfiguration</i> message including <i>measConfig</i> to remove Cell 3 from the blacklisted cell list.	<--	NR RRC: <i>RRCReconfiguration</i>	-	-
8	The UE transmits an <i>RRCReconfigurationComplete</i> message	-->	NR RRC: <i>RRCReconfigurationComplete</i>	-	-
-	EXCEPTION: Steps 8Aa1 to 8Ab1 describe a transaction that depends on the UE behaviour; the "lower case letter" identifies a step sequence that takes place if a specific behaviour happens.	-	-	-	-
8A a1	IF the UE detects event A3 for Cell 12 before event A3 for Cell 3 THEN the UE may transmit <i>MeasurementReport</i> message to report event A3 with the measured RSRP values for Cell 1 and Cell .	-->	NR RRC: <i>MeasurementReport</i>	-	-
8A b1	IF the UE detects event A3 for Cell 3 before event A3 for Cell 12 THEN the UE may transmit <i>MeasurementReport</i> message to report event A3 with the measured RSRP values for Cell 1 and Cell 3.	-->	NR RRC: <i>MeasurementReport</i>	-	-
9	Check: does the UE transmit a <i>MeasurementReport</i> message to report event A3 with the measured RSRP values for Cell 1, Cell 3 and Cell 12?	-->	NR RRC: <i>MeasurementReport</i>	2	P

8.1.3.1.15A.3.3 Specific message contents

Table 8.1.3.1.15A.3.3-1: *RRCReconfiguration* (step 1 and Step 7 Table 8.1.3.1.15A.3.2-2)

Derivation Path: 38.508-1 [4] Table 4.6.1-13 with condition NR_MEAS

Table 8.1.3.1.15A.3.3-2: *MeasConfig* (Table 8.1.3.1.15A.3.3-1)

Derivation path: 38.508 clause 4.6.3 table 4.6.3-69 with condition EVENT_A3			
Information Element	Value/remark	Comment	Condition
MeasConfig ::= SEQUENCE {			
measObjectToAddModList SEQUENCE (SIZE (1..maxNrofMeasId)) OF MeasObjectToAddMod {	2 entries		
MeasObjectToAddMod[1] SEQUENCE {		entry 1	
measObjectId	1		
measObject CHOICE {			
measObjectNR	MeasObjectNR-f1	Table 8.1.3.1.15A.3.3-2A	
}			
}			
MeasObjectToAddMod[2] SEQUENCE {		entry 2	
measObjectId	2		
measObject CHOICE {			
measObjectNR	MeasObjectNR-f2	Table 8.1.3.1.15A.3.3-3	Step 1 of Table 8.1.3.1.15A.3.3-1
	MeasObjectNR-f2	Table 8.1.3.1.15A.3.3-5	Step 7 of Table 8.1.3.1.15A.3.3-1
}			
}			
}			
reportConfigToAddModList SEQUENCE(SIZE (1..maxReportConfigId)) OF ReportConfigToAddMod {	1 entry		
ReportConfigToAddMod[1] SEQUENCE {		entry 1	
reportConfigId	ReportConfigId		
reportConfig CHOICE {			
reportConfigNR	ReportConfigNR(2) Same as TS 38.508-1 Table 4.6.3-142 except for reportAmount set to 'r1'	a3-Offset value set to 1 dB (2*0.5 dB)	
}			
}			
measIdToAddModList SEQUENCE (SIZE (1..maxNrofMeasId)) OF MeasIdToAddMod {	1 entry		
MeasIdToAddMod[1] SEQUENCE {			
measId	1		
measObjectId	2		
reportConfigId	ReportConfigId		
}			
}			
measGapConfig	MeasGapConfig with condition INTER-FREQ_ODD		
}			

Table 8.1.3.1.15A.3.3-2A: MeasObjectNR-f1 (Table 8.1.3.1.15A.3.3-2)

Derivation Path: TS 38.508-1 [4], Table 4.6.3-76			
Information Element	Value/remark	Comment	Condition
MeasObjectNR ::= SEQUENCE {			
ssbFrequency	ARFCN-ValueNR for SSB of NR Cell 1		
absThreshSS-BlocksConsolidation	Not present		
nrofSS-BlocksToAverage	Not present		
}			

Table 8.1.3.1.15A.3.3-3: MeasObjectNR-f2 (Table 8.1.3.1.15A.3.3-2)

Derivation path: TS 38.508-1 [4], Table 4.6.3-76			
Information Element	Value/remark	Comment	Condition
MeasObjectNR ::= SEQUENCE {			
ssbFrequency	ARFCN-ValueNR for SSB of NR Cell 3		
smtc1	SSB-MTC with condition INTER-FREQ_ODD		
absThreshSS-BlocksConsolidation	Not present		
nrofSS-BlocksToAverage	Not present		
blackCellsToAddModList SEQUENCE (SIZE (1.. maxNrofPCI-Ranges)) OF PCI-RangeElement {	1 entry	Add Cell 3	
PCI-RangeElement[1] SEQUENCE {		entry 1	
PCI-RangeIndex	1		
pci-Range SEQUENCE {			
start	physicalCellIdentity-Cell3		
range	Not present		
}			
}			
}			
}			

Table 8.1.3.1.15A.3.3-5: MeasObjectNR-f2 (Step 7 Table 8.1.3.1.15A.3.3-2)

Derivation path: TS 38.508-1 [4], Table 4.6.3-76			
Information Element	Value/remark	Comment	Condition
MeasObjectNR ::= SEQUENCE {			
ssbFrequency	ARFCN-ValueNR for SSB of NR Cell 3		
smtc1	SSB-MTC with condition INTER-FREQ_ODD		
absThreshSS-BlocksConsolidation	Not present		
nrofSS-BlocksToAverage	Not present		
blackCellsToRemoveList SEQUENCE (SIZE (1.. maxNrofPCI-Ranges)) OF PCI-RangeElement {	1 entry	Remove Cell 3	
PCI-RangeIndex [1]	physicalCellIdentity-Cell3	entry 1	
}			
}			

Table 8.1.3.1.15A.3.3-8: *MeasurementReport* (step 9, Table 8.1.3.1.15A.3.2-2)

Derivation Path: TS 38.508-1 [4] clause 4.6.1 table 4.6.1-5A			
Information Element	Value/remark	Comment	Condition
MeasurementReport ::= SEQUENCE {			
criticalExtensions CHOICE {			
c1 CHOICE {			
measurementReport SEQUENCE {			
measResults SEQUENCE {			
measId	1		
measResultServingMOList SEQUENCE (SIZE (1..maxNrofServingCells)) OF MeasResultServMO {	1 entry		
MeasResultServMO[1] SEQUENCE {		entry 1	
servCellId	ServCellIndex – Cell1		
measResultServingCell SEQUENCE {		Report Cell 1	
physCellId	physicalCellIdentity-Cell1		
measResult SEQUENCE {			
cellResults SEQUENCE {			
resultsSSB-Cell SEQUENCE {			
rsrp	(0..127)		
rsrq	(0..127)		
sinr	(0..127)		pc_ss_SIN R_Meas
	Not Present		
}			
}			
}			
}			
}			
}			
}			
}			
measResultNeighCells CHOICE {			
measResultListNR SEQUENCE (SIZE (1..maxCellReport)) OF MeasResultNR {	2 entries that may appear in an arbitrary order	Report Cell 3 and Cell 12	
MeasResultNR[1] SEQUENCE {		entry 1	
physCellId	physicalCellIdentity-Cell3		
measResult SEQUENCE {			
cellResults SEQUENCE {			
resultsSSB-Cell SEQUENCE {			
rsrp	(0..127)		
rsrq	(0..127)		
sinr	(0..127)		pc_ss_SIN R_Meas
	Not Present		
}			
}			
}			
}			
}			
resultsCSI-RS-Cell	Not present		
}			
rsIndexResults	Not present		
}			
cgi-Info	Not present		
}			
MeasResultNR[2] SEQUENCE {		entry 2	
physCellId	physicalCellIdentity-Cell 12		
measResult SEQUENCE {			
cellResults SEQUENCE {			
resultsSSB-Cell SEQUENCE {			
rsrp	(0..127)		
rsrq	(0..127)		
sinr	(0..127)		pc_ss_SIN R_Meas
	Not Present		
}			
}			
}			
resultsCSI-RS-Cell	Not present		
}			
rsIndexResults	Not present		
}			

cgi-Info	Not present		
}			
}			
}			
}			
}			
}			
}			
}			

8.1.3.1.16 Measurement configuration control and reporting / Intra NR measurements / Whitelisting

8.1.3.1.16.1 Test Purpose (TP)

(1)

```
with { UE in NR RRC_CONNECTED state and measurement configured for event A3 reporting }
ensure that {
  when { Neighbour cell not listed as a white cell satisfies entry condition for event A3 }
  then { It is not considered in event evaluation and UE does not send MeasurementReport message }
}
```

(2)

```
with { UE in NR RRC_CONNECTED state and measurement reporting triggered by event A3 is ongoing and
all of the neighbour cells are whitelisted }
ensure that {
  when { Neighbour cells satisfies entry condition for event A3 }
  then { Neighbour cells are considered in measurement reporting }
}
```

8.1.3.1.16.2 Conformance requirements

References: The conformance requirements covered in the current TC are specified in: TS 38.331, clauses 5.3.5.3, 5.5.2.1, 5.5.2.9, 5.5.4.1, 5.5.4.6 and 5.5.5. Unless otherwise stated these are Rel-15 requirements.

[TS 38.331, clause 5.3.5.3]

The UE shall perform the following actions upon reception of the *RRCReconfiguration*:

...

1> if the *RRCReconfiguration* message includes the *measConfig*:

2> perform the measurement configuration procedure as specified in 5.5.2;

...

1> if the UE is configured with E-UTRA *nr-SecondaryCellGroupConfig* (MCG is E-UTRA):

...

1> else:

2> submit the *RRCReconfigurationComplete* message via SRB1 to lower layers for transmission using the new configuration;

...

[TS 38.331, clause 5.5.2.1]

...

The UE shall:

...

1> if the received *measConfig* includes the *measObjectToAddModList*:

2> perform the measurement object addition/modification procedure as specified in 5.5.2.5;

...

1> if the received *measConfig* includes the *reportConfigToAddModList*:

2> perform the reporting configuration addition/modification procedure as specified in 5.5.2.7;

...

1> if the received *measConfig* includes the *measIdToAddModList*:

2> perform the measurement identity addition/modification procedure as specified in 5.5.2.3;

...

[TS 38.331, clause 5.5.4.1]

If AS security has been activated successfully, the UE shall:

1> for each *measId* included in the *measIdList* within *VarMeasConfig*:

2> if the corresponding *reportConfig* includes a *reportType* set to *eventTriggered* or *periodical*:

3> if the corresponding *measObject* concerns NR:

...

4> if the *eventA3* or *eventA5* is configured in the corresponding *reportConfig*:

5> if a serving cell is associated with a *measObjectNR* and neighbours are associated with another *measObjectNR*, consider any serving cell associated with the other *measObjectNR* to be a neighbouring cell as well;

...

2> if the *reportType* is set to *eventTriggered* and if the entry condition applicable for this event, i.e. the event corresponding with the *eventId* of the corresponding *reportConfig* within *VarMeasConfig*, is fulfilled for one or more applicable cells for all measurements after layer 3 filtering taken during *timeToTrigger* defined for this event within the *VarMeasConfig*, while the *VarMeasReportList* does not include a measurement reporting entry for this *measId* (a first cell triggers the event):

3> include a measurement reporting entry within the *VarMeasReportList* for this *measId*;

3> set the *numberOfReportsSent* defined within the *VarMeasReportList* for this *measId* to 0;

3> include the concerned cell(s) in the *cellsTriggeredList* defined within the *VarMeasReportList* for this *measId*;

3> initiate the measurement reporting procedure, as specified in 5.5.5;

2> else if the *reportType* is set to *eventTriggered* and if the entry condition applicable for this event, i.e. the event corresponding with the *eventId* of the corresponding *reportConfig* within *VarMeasConfig*, is fulfilled for one or more applicable cells not included in the *cellsTriggeredList* for all measurements after layer 3 filtering taken during *timeToTrigger* defined for this event within the *VarMeasConfig* (a subsequent cell triggers the event):

3> set the *numberOfReportsSent* defined within the *VarMeasReportList* for this *measId* to 0;

3> include the concerned cell(s) in the *cellsTriggeredList* defined within the *VarMeasReportList* for this *measId*;

3> initiate the measurement reporting procedure, as specified in 5.5.5;

- 2> else if the *reportType* is set to *eventTriggered* and if the leaving condition applicable for this event is fulfilled for one or more of the cells included in the *cellsTriggeredList* defined within the *VarMeasReportList* for this *measId* for all measurements after layer 3 filtering taken during *timeToTrigger* defined within the *VarMeasConfig* for this event:
 - 3> remove the concerned cell(s) in the *cellsTriggeredList* defined within the *VarMeasReportList* for this *measId*;
 - ...
 - 3> if the *cellsTriggeredList* defined within the *VarMeasReportList* for this *measId* is empty:
 - 4> remove the measurement reporting entry within the *VarMeasReportList* for this *measId*;
 - 4> stop the periodical reporting timer for this *measId*, if running;
 - ...
- 2> upon expiry of the periodical reporting timer for this *measId*:
 - 3> initiate the measurement reporting procedure, as specified in 5.5.5.
 - ...

[TS 38.331, clause 5.5.4.4]

The UE shall:

- 1> consider the entering condition for this event to be satisfied when condition A3-1, as specified below, is fulfilled;
- 1> consider the leaving condition for this event to be satisfied when condition A3-2, as specified below, is fulfilled;
- 1> use the SpCell for *Mp*, *Ofp* and *Ocp*.

NOTE The cell(s) that triggers the event has reference signals indicated in the *measObjectNR* associated to this event which may be different from the NR SpCell *measObjectNR*.

Inequality A3-1 (Entering condition)

$$Mn + Ofn + Ocn - Hys > Mp + Ofp + Ocp + Off$$

Inequality A3-2 (Leaving condition)

$$Mn + Ofn + Ocn + Hys < Mp + Ofp + Ocp + Off$$

The variables in the formula are defined as follows:

Mn is the measurement result of the neighbouring cell, not taking into account any offsets.

Ofn is the measurement object specific offset of the reference signal of the neighbour cell (i.e. *offsetMO* as defined within *measObjectNR* corresponding to the neighbour cell).

Ocn is the cell specific offset of the neighbour cell (i.e. *cellIndividualOffset* as defined within *measObjectNR* corresponding to the frequency of the neighbour cell), and set to zero if not configured for the neighbour cell.

Mp is the measurement result of the SpCell, not taking into account any offsets.

Ofp is the measurement object specific offset of the SpCell (i.e. *offsetMO* as defined within *measObjectNR* corresponding to the SpCell).

Ocp is the cell specific offset of the SpCell (i.e. *cellIndividualOffset* as defined within *measObjectNR* corresponding to the SpCell), and is set to zero if not configured for the SpCell.

Hys is the hysteresis parameter for this event (i.e. *hysteresis* as defined within *reportConfigNR* for this event).

Off is the offset parameter for this event (i.e. *a3-Offset* as defined within *reportConfigNR* for this event).

Mn, **Mp** are expressed in dBm in case of RSRP, or in dB in case of RSRQ and RS-SINR.

Ofn, Ocn, Ofp, Ocp, Hys, Off are expressed in dB.

[TS 38.331, clause 5.5.5.1]



Figure 5.5.5.1-1: Measurement reporting

The purpose of this procedure is to transfer measurement results from the UE to the network. The UE shall initiate this procedure only after successful AS security activation.

For the *measId* for which the measurement reporting procedure was triggered, the UE shall set the *measResults* within the *MeasurementReport* message as follows:

- 1> set the *measId* to the measurement identity that triggered the measurement reporting;
- 1> set the *measResultServingCell* within *measResultServingMOList* to include, for each NR serving cell that is configured with *servingCellMO*, RSRP, RSRQ and the available SINR, derived based on the *rsType* if indicated in the associated *reportConfig*, otherwise based on SSB if available, otherwise based on CSI-RS;
- 1> set the *servCellId* within *measResultServingMOList* to include each NR serving cell that is configured with *servingCellMO*, if any;
- ...
- 1> if there is at least one applicable neighbouring cell to report:
 - 2> if the *reportType* is set to *eventTriggered* or *periodical*:
 - 3> set the *measResultNeighCells* to include the best neighbouring cells up to *maxReportCells* in accordance with the following:
 - 4> if the *reportType* is set to *eventTriggered*:
 - 5> include the cells included in the *cellsTriggeredList* as defined within the *VarMeasReportList* for this *measId*;
 - ...
 - 4> for each cell that is included in the *measResultNeighCells*, include the *physCellId*;
 - 4> if the *reportType* is set to *eventTriggered* or *periodical*:
 - 5> for each included cell, include the layer 3 filtered measured results in accordance with the *reportConfig* for this *measId*, ordered as follows:
 - 6> if the *measObject* associated with this *measId* concerns NR:
 - 7> if *rsType* in the associated *reportConfig* is set to *ssb*:
 - 8> set *resultsSSB-Cell* within the *measResult* to include the SS/PBCH block based quantity(ies) indicated in the *reportQuantityCell* within the concerned *reportConfig*, in decreasing order of the sorting quantity, determined as specified in 5.5.5.3, i.e. the best cell is included first;
 - ...
- 1> increment the *numberOfReportsSent* as defined within the *VarMeasReportList* for this *measId* by 1;

- 1> stop the periodical reporting timer, if running;
- 1> if the *numberOfReportsSent* as defined within the *VarMeasReportList* for this *measId* is less than the *reportAmount* as defined within the corresponding *reportConfig* for this *measId*:
- 2> start the periodical reporting timer with the value of *reportInterval* as defined within the corresponding *reportConfig* for this *measId*;
- ...
- 1> else:
- 2> submit the *MeasurementReport* message to lower layers for transmission, upon which the procedure ends.

8.1.3.1.16.3 Test description

8.1.3.1.16.3.1 Pre-test conditions

System Simulator:

- NR Cell 1 is the PCell, NR Cell 2 and NR Cell 4 are the intra-frequency neighbour cells of NR Cell 1.
- System information combination NR-2 as defined in TS 38.508-1 [4] clause 4.4.3.1.2 is used in NR cells.

UE:

- None.

Preamble:

- The UE is in state 3N-A as defined in TS 38.508-1 [4], subclause 4.4A.

8.1.3.1.16.3.2 Test procedure sequence

Table 8.1.3.1.16.3.2-1 and 8.1.3.1.16.3.2-2 illustrates the downlink power levels to be applied for NR Cell 1, NR Cell 2 and NR Cell 4 at various time instants of the test execution. Row marked "T0" denotes the conditions after the preamble, while the configuration marked "T1" is applied at the point indicated in the Main behaviour description in Table 8.1.3.1.16.3.2-3.

Table 8.1.3.1.16.3.2-1: Time instances of cell power level and parameter changes for NR Cell 1, 2, 4 in FR1

	Parameter	Unit	NR Cell 1	NR Cell 2	NR Cell 4	Remark
T0	SS/PBCH SSS EPRE	dBm/ SCS	-85	-91	-91	Power levels are such that entry condition for event A3 (measId 1) is not satisfied: $Mn + Ofn + Ocn - Hys \leq Mp + Ofp + Ocp + Off$
T1	SS/PBCH SSS EPRE	dBm/ SCS	-85	-78	-91	Power levels are such that entry condition for event A3 (measId 1) is satisfied: $Mn + Ofn + Ocn - Hys > Mp + Ofp + Ocp + Off$
T2	SS/PBCH SSS EPRE	dBm/ SCS	-85	-91	-91	Power levels are such that entry condition for event A3 (measId 1) is not satisfied: $Mn + Ofn + Ocn - Hys \leq Mp + Ofp + Ocp + Off$

Table 8.1.3.1.16.3.2-2: Time instances of cell power level and parameter changes for NR Cell 1, 2, 4 in FR2

	Parameter	Unit	NR Cell 1	NR Cell 2	NR Cell 4	Remark
T0	SS/PBCH SSS EPRE	dBm/ SCS	FFS	FFS	FFS	Power levels are such that entry condition for event A3 (measId 1) is not satisfied: $Mn + Ofn + Ocn - Hys \leq Mp + Ofp + Ocp + Off$
T1	SS/PBCH SSS EPRE	dBm/ SCS	FFS	FFS	FFS	Power levels are such that entry condition for event A3 (measId 1) is satisfied: $Mn + Ofn + Ocn - Hys > Mp + Ofp + Ocp + Off$
T2	SS/PBCH SSS EPRE	dBm/ SCS	FFS	FFS	FFS	Power levels are such that entry condition for event A3 (measId 1) is not satisfied: $Mn + Ofn + Ocn - Hys \leq Mp + Ofp + Ocp + Off$

Table 8.1.3.1.16.3.2-3: Main behaviour

St	Procedure	Message Sequence		TP	Verdict
		U - S	Message		
1	The SS transmits an <i>RRCReconfiguration</i> message including <i>MeasConfig</i> to setup NR measurement and reporting for intra-frequency event A3 (<i>measId</i> 1)	<--	NR RRC: <i>RRCReconfiguration</i>	-	-
2	The UE transmits an <i>RRCReconfigurationComplete</i> message.	-->	NR RRC: <i>RRCReconfigurationComplete</i>	-	-
3	SS re-adjusts the cell-specific reference signal level according to row "T1" in table 8.1.3.1.16.3.2-1/2.	-	-	-	-
4	Check: Does the UE transmit a <i>MeasurementReport</i> message within the next 30s?	-->	NR RRC: <i>MeasurementReport</i>	1	F
5	The SS transmits an <i>RRCReconfiguration</i> message including both NR Cell 2 and NR Cell 4 in <i>whiteCellsToAddModList</i>	<--	NR RRC: <i>RRCReconfiguration</i>	-	-
6	The UE transmits an <i>RRCReconfigurationComplete</i> message.	-->	NR RRC: <i>RRCReconfigurationComplete</i>	-	-
7	Wait and ignore <i>MeasurementReport</i> messages for 10s to allow UE measurement	-	-	-	-
8	Check: Does the UE transmit a <i>MeasurementReport</i> message to report event A3 (<i>measId</i> 1) with the measured RSRP value for NR Cell 2?	-->	NR RRC: <i>MeasurementReport</i>	2	P
9	SS re-adjusts the cell-specific reference signal level according to row "T2" in table 8.1.3.1.16.3.2-1/2.	-	-	-	-
10	Wait and ignore <i>MeasurementReport</i> messages for 10s to allow change of power levels for NR Cell 2 and UE measurement	-	-	-	-
11	Check: Does the UE transmit a <i>MeasurementReport</i> message within the next 10s?	-	-	2	F

8.1.3.1.16.3.3 Specific message contents

Table 8.1.3.1.16.3.3-1: *RRCReconfiguration* (step 1 and 5, Table 8.1.3.1.16.3.2-3)

Derivation Path: 38.508-1 [4] Table 4.6.1-13 with condition NR_MEAS

Table 8.1.3.1.16.3.3-2: *MeasConfig* (Table 8.1.3.1.16.3.3-1)

Derivation Path: 38.508-1 [4] Table 4.6.3-69			
Information Element	Value/remark	Comment	Condition
MeasConfig ::= SEQUENCE {			
measObjectToAddModList SEQUENCE (SIZE (1..maxNrofMeasId)) OF MeasObjectToAddMod {	1 entry		
MeasObjectToAddMod[1] SEQUENCE {		entry 1	
measObjectId	1		
measObject CHOICE {			
measObjectNR	MeasObjectNR-f1		Step 1
	MeasObjectNR-whitelist		Step 5
}			
}			
}			
reportConfigToAddModList	Not present		Step 5
reportConfigToAddModList SEQUENCE (SIZE (1..maxReportConfigId)) OF ReportConfigToAddMod {	1 entry		Step 1
ReportConfigToAddMod[1] SEQUENCE {		entry 1	
reportConfigId	1		
reportConfig CHOICE {			
reportConfigNR	ReportConfigNR-EventA3		
}			
}			
}			
measIdToAddModList	Not present		Step 5
measIdToAddModList SEQUENCE (SIZE (1..maxNrofMeasId)) OF MeasIdToAddMod {	1 entry		Step 1
MeasIdToAddMod[1] SEQUENCE {		entry 1	
measId	1		
measObjectId	1		
reportConfigId	1		
}			
}			
}			

Table 8.1.3.1.16.3.3-3: *MeasObjectNR-f1* (Table 8.1.3.1.16.3.3-2)

Derivation Path: TS 38.508-1 [4], Table 4.6.3-76			
Information Element	Value/remark	Comment	Condition
MeasObjectNR ::= SEQUENCE {			
ssbFrequency	ARFCN-ValueNR for SSB of NR Cell 1		
absThreshSS-BlocksConsolidation	Not present		
nrofSS-BlocksToAverage	Not present		
whiteCellsToAddModList SEQUENCE (SIZE (1..maxNrofPCI-Ranges)) OF PCI-RangeElement {	1 entry		
PCI-RangeElement[1] SEQUENCE {		entry 1	
pci-RangeIndex	1		
pci-Range SEQUENCE {			
start	900		
range	Not present		
}			
}			
}			
}			

Table 8.1.3.1.16.3.3-4: MeasObjectNR-whitelist (Table 8.1.3.1.16.3.3-2)

Derivation Path: TS 38.508-1 [4], Table 4.6.3-76			
Information Element	Value/remark	Comment	Condition
MeasObjectNR ::= SEQUENCE {			
ssbFrequency	ARFCN-ValueNR for SSB of NR Cell 1		
absThreshSS-BlocksConsolidation	Not present		
nrofSS-BlocksToAverage	Not present		
whiteCellsToAddModList SEQUENCE (SIZE (1..maxNrofPCI-Ranges)) OF PCI-RangeElement {	2 entries		
PCI-RangeElement[1] SEQUENCE {		entry 1	
pci-RangeIndex	1		
pci-Range SEQUENCE {			
start	PhyCellId of NR Cell 2		
range	n4		
}			
}			
PCI-RangeElement[2] SEQUENCE {		entry 2	
pci-RangeIndex	2		
pci-Range SEQUENCE {			
start	PhyCellId of NR Cell 4		
range	n4		
}			
}			
}			
}			

Table 8.1.3.1.16.3.3-5: ReportConfigNR-EventA3 (Table 8.1.3.1.16.3.3-2)

Derivation Path: 38.508-1 [4] Table 4.6.3-142 with condition EVENT_A3			
Information Element	Value/remark	Comment	Condition
ReportConfigNR ::= SEQUENCE {			
reportType CHOICE {			
eventTriggered SEQUENCE {			
eventId CHOICE {			
eventA3 SEQUENCE {			
a3-Offset CHOICE {			
rsrp	0	0dB	FR1
}	FFS		FR2
}			
}			
}			
}			
}			
reportInterval	ms10240		
reportAmount	infinity		
reportQuantityCell SEQUENCE {			
rsrp	true		
rsrq	false		
sinr	false		
}			
}			
}			
}			

Table 8.1.3.1.16.3.3-6: *MeasurementReport* (step 8, Table 8.1.3.1.16.3.2-3)

Derivation Path: 38.508-1 [4] Table 4.6.1-5A			
Information Element	Value/remark	Comment	Condition
MeasurementReport ::= SEQUENCE {			
criticalExtensions CHOICE {			
measurementReport SEQUENCE {			
measResults SEQUENCE {			
measId	1		
measResultServingMOList SEQUENCE (SIZE (1..maxNrofServingCells)) OF MeasResultServMO {	1 entry	Measurement report for NR Cell 1	
MeasResultServMO[1] SEQUENCE {		entry 1	
servCellId	ServCellIndex of NR Cell 1		
measResultServingCell SEQUENCE {			
physCellId	PhysCellId of NR Cell 1		
measResult SEQUENCE {			
cellResults SEQUENCE {			
resultsSSB-Cell SEQUENCE {			
rsrp	(0..127)		
rsrq	(0..127)		
sinr	Not present		
}			
}			
}			
}			
}			
}			
}			
measResultNeighCells CHOICE {			
measResultListNR SEQUENCE (SIZE (1..maxCellReport)) OF MeasResultNR {	1 entry	Measurement report for NR Cell 2	
MeasResultNR[1] SEQUENCE {		entry 1	
physCellId	PhysCellId of NR Cell 2		
measResult SEQUENCE {			
cellResults SEQUENCE {			
resultsSSB-Cell SEQUENCE {			
rsrp	(0..127)		
rsrq	Not present		
sinr	Not present		
}			
resultsCSI-RS-Cell	Not present		
}			
rsIndexResults	Not present		
}			
cgi-Info	Not present		
}			
}			
}			

8.1.3.1.17 NR CA / Measurement configuration control and reporting / Intra NR measurements / Event A6

8.1.3.1.17.1 NR CA / Measurement configuration control and reporting / Intra NR measurements / Event A6 / Intra-band Contiguous CA

8.1.3.1.17.1.1 Test Purpose (TP)

(1)

```
with { UE in NR RRC_CONNECTED state and measurements configured for event A6 }
ensure that {
  when { Entry condition for event A6 is not met }
  then { UE does not send MeasurementReport }
}
```

(2)

```
with { UE in NR RRC_CONNECTED state and measurements configured for event A6 }
ensure that {
  when { Intra-frequency neighbour becomes offset better than SCell }
  then { UE sends MeasurementReport with correct measId for event A6 }
}
```

(3)

```
with { UE in NR RRC_CONNECTED state and measurements configured for event A6 }
ensure that {
  when { UE receives a RRCReconfiguration message containing sCellToReleaseList with a sCellIndex
equal to one of the current UE SCell configuration }
  then { UE stops sending MeasurementReport message }
}
```

8.1.3.1.17.1.2 Conformance requirements

References: The conformance requirements covered in the current TC are specified in: TS 38.331, clauses 5.3.5.3, 5.3.5.5.9, 5.5.2.1, 5.5.4.1, 5.5.4.7 and 5.5.5. Unless otherwise stated these are Rel-15 requirements.

[TS 38.331, clause 5.3.5.3]

The UE shall perform the following actions upon reception of the *RRCReconfiguration*:

...

1> if the *RRCReconfiguration* includes the *masterCellGroup*:

2> perform the cell group configuration for the received *masterCellGroup* according to 5.3.5.5;

...

1> if the *RRCReconfiguration* message includes the *measConfig*:

2> perform the measurement configuration procedure as specified in 5.5.2;

...

1> if the UE is configured with E-UTRA *nr-SecondaryCellGroupConfig* (MCG is E-UTRA):

...

1> else:

2> submit the *RRCReconfigurationComplete* message via SRB1 to lower layers for transmission using the new configuration;

...

[TS 38.331, clause 5.3.5.5.9]

The UE shall:

- 1> for each *sCellIndex* value included in the *sCellToAddModList* that is not part of the current UE configuration (SCell addition):
 - 2> add the SCell, corresponding to the *sCellIndex*, in accordance with the *sCellConfigCommon* and *sCellConfigDedicated*;
 - 2> configure lower layers to consider the SCell to be in deactivated state;

Editor's Note: FFS Check automatic measurement handling for SCells.

- 2> for each *measId* included in the *measIdList* within *VarMeasConfig*:
 - 3> if SCells are not applicable for the associated measurement; and
 - 3> if the concerned SCell is included in *cellsTriggeredList* defined within the *VarMeasReportList* for this *measId*;
 - 4> remove the concerned SCell from *cellsTriggeredList* defined within the *VarMeasReportList* for this *measId*;
- 1> for each *sCellIndex* value included in the *sCellToAddModList* that is part of the current UE configuration (SCell modification):
 - 2> modify the SCell configuration in accordance with the *sCellConfigDedicated*.

[TS 38.331, clause 5.5.2.1]

...

The UE shall:

...

- 1> if the received *measConfig* includes the *measObjectToAddModList*:
 - 2> perform the measurement object addition/modification procedure as specified in 5.5.2.5;

...

- 1> if the received *measConfig* includes the *reportConfigToAddModList*:
 - 2> perform the reporting configuration addition/modification procedure as specified in 5.5.2.7;

...

- 1> if the received *measConfig* includes the *measIdToRemoveList*:
 - 2> perform the measurement identity removal procedure as specified in 5.5.2.2;

- 1> if the received *measConfig* includes the *measIdToAddModList*:
 - 2> perform the measurement identity addition/modification procedure as specified in 5.5.2.3;

...

[TS 38.331, clause 5.5.4.1]

If security has been activated successfully, the UE shall:

- 1> for each *measId* included in the *measIdList* within *VarMeasConfig*:
 - 2> if the corresponding *reportConfig* includes a *reportType* set to *eventTriggered* or *periodical*;
 - 3> if the corresponding *measObject* concerns NR;

- 4> if the *eventA1* or *eventA2* is configured in the corresponding *reportConfig*:
- ...
- 4> else:
- 5> for events involving a serving cell associated with a *measObjectNR* and neighbours associated with another *measObjectNR*, consider any serving cell associated with the other *measObjectNR* to be a neighbouring cell as well;
- ...
- 2> if the *reportType* is set to *eventTriggered* and if the entry condition applicable for this event, i.e. the event corresponding with the *eventId* of the corresponding *reportConfig* within *VarMeasConfig*, is fulfilled for one or more applicable cells for all measurements after layer 3 filtering taken during *timeToTrigger* defined for this event within the *VarMeasConfig*, while the *VarMeasReportList* does not include a measurement reporting entry for this *measId* (a first cell triggers the event):
- 3> include a measurement reporting entry within the *VarMeasReportList* for this *measId*;
- 3> set the *numberOfReportsSent* defined within the *VarMeasReportList* for this *measId* to 0;
- 3> include the concerned cell(s) in the *cellsTriggeredList* defined within the *VarMeasReportList* for this *measId*;
- 3> initiate the measurement reporting procedure, as specified in 5.5.5;
- 2> if the *reportType* is set to *eventTriggered* and if the entry condition applicable for this event, i.e. the event corresponding with the *eventId* of the corresponding *reportConfig* within *VarMeasConfig*, is fulfilled for one or more applicable cells not included in the *cellsTriggeredList* for all measurements after layer 3 filtering taken during *timeToTrigger* defined for this event within the *VarMeasConfig* (a subsequent cell triggers the event):
- 3> set the *numberOfReportsSent* defined within the *VarMeasReportList* for this *measId* to 0;
- 3> include the concerned cell(s) in the *cellsTriggeredList* defined within the *VarMeasReportList* for this *measId*;
- 3> initiate the measurement reporting procedure, as specified in 5.5.5;
- 2> if the *reportType* is set to *eventTriggered* and if the leaving condition applicable for this event is fulfilled for one or more of the cells included in the *cellsTriggeredList* defined within the *VarMeasReportList* for this *measId* for all measurements after layer 3 filtering taken during *timeToTrigger* defined within the *VarMeasConfig* for this event:
- 3> remove the concerned cell(s) in the *cellsTriggeredList* defined within the *VarMeasReportList* for this *measId*;
- 3> if *reportOnLeave* is set to *TRUE* for the corresponding reporting configuration:
- 4> initiate the measurement reporting procedure, as specified in 5.5.5;
- 3> if the *cellsTriggeredList* defined within the *VarMeasReportList* for this *measId* is empty:
- 4> remove the measurement reporting entry within the *VarMeasReportList* for this *measId*;
- 4> stop the periodical reporting timer for this *measId*, if running;
- ...
- 2> upon expiry of the periodical reporting timer for this *measId*:
- 3> initiate the measurement reporting procedure, as specified in 5.5.5.
- ...

[TS 38.331, clause 5.5.4.7]

The UE shall:

- 1> consider the entering condition for this event to be satisfied when condition A6-1, as specified below, is fulfilled;
- 1> consider the leaving condition for this event to be satisfied when condition A6-2, as specified below, is fulfilled;
- 1> for this measurement, consider the (secondary) cell corresponding to the *measObjectNR* associated to this event to be the serving cell.

NOTE: The reference signal(s) of the neighbour(s) and the reference signal(s) of the SCell are both indicated in the associated *measObjectNR*.

Inequality A6-1 (Entering condition)

$$Mn + Ocn - Hys > Ms + Ocs + Off$$

Inequality A6-2 (Leaving condition)

$$Mn + Ocn + Hys < Ms + Ocs + Off$$

The variables in the formula are defined as follows:

Mn is the measurement result of the neighbouring cell, not taking into account any offsets.

Ocn is the cell specific offset of the neighbour cell (i.e. *cellIndividualOffset* as defined within the associated *measObjectNR*), and set to zero if not configured for the neighbour cell.

Ms is the measurement result of the serving cell, not taking into account any offsets.

Ocs is the cell specific offset of the serving cell (i.e. *cellIndividualOffset* as defined within the associated *measObjectNR*), and is set to zero if not configured for the serving cell.

Hys is the hysteresis parameter for this event (i.e. *hysteresis* as defined within *reportConfigNR* for this event).

Off is the offset parameter for this event (i.e. *a6-Offset* as defined within *reportConfigNR* for this event).

Mn, Ms are expressed in dBm in case of RSRP, or in dB in case of RSRQ and RS-SINR.

Ocn, Ocs, Hys, Off are expressed in dB.

[TS 38.331, clause 5.5.5]



Figure 5.5.5-1: Measurement reporting

The purpose of this procedure is to transfer measurement results from the UE to the network. The UE shall initiate this procedure only after successful security activation.

For the *measId* for which the measurement reporting procedure was triggered, the UE shall set the *measResults* within the *MeasurementReport* message as follows:

- 1> set the *measId* to the measurement identity that triggered the measurement reporting;
- 1> set the *measResultServingCell* within *measResultServingMOList* to include RSRP, RSRQ and the available SINR for each configured serving cell derived based on the *rsType* indicated in the associated *reportConfig*;
- 1> set the *measResultServingCell* within *measResultServingMOList* to include for each NR serving cell that is configured with *servingCellMO*, if any, the *servCellId*;

...

1> if there is at least one applicable neighbouring cell to report:

2> set the *measResultNeighCells* to include the best neighbouring cells up to *maxReportCells* in accordance with the following:

3> if the *reportType* is set to *eventTriggered*:

4> include the cells included in the *cellsTriggeredList* as defined within the *VarMeasReportList* for this *measId*;

...

3> for each cell that is included in the *measResultNeighCells*, include the *physCellId*;

3> if the *reportType* is set to *eventTriggered*:

4> for each included cell, include the layer 3 filtered measured results in accordance with the *reportConfig* for this *measId*, ordered as follows:

5> if the *measObject* associated with this *measId* concerns NR:

6> if *rsType* in the associated *reportConfig* is set to *ssb*:

7> set *resultsSSB-Cell* within the *measResult* to include the SS/PBCH block based quantity(ies) indicated in the *reportQuantityCell* within the concerned *reportConfig*, in order of decreasing trigger quantity, i.e. the best cell is included first:

...

1> increment the *numberOfReportsSent* as defined within the *VarMeasReportList* for this *measId* by 1;

1> stop the periodical reporting timer, if running;

1> if the *numberOfReportsSent* as defined within the *VarMeasReportList* for this *measId* is less than the *reportAmount* as defined within the corresponding *reportConfig* for this *measId*:

2> start the periodical reporting timer with the value of *reportInterval* as defined within the corresponding *reportConfig* for this *measId*;

...

1> if the UE is configured with EN-DC:

...

1> else:

2> submit the *MeasurementReport* message to lower layers for transmission, upon which the procedure ends.

8.1.3.1.17.1.3 Test description

8.1.3.1.17.1.3.1 Pre-test conditions

System Simulator:

- NR Cell 1 is the PCell, NR Cell 3 is the SCell to be added, and NR Cell 12 is the intra-frequency neighbour cell of NR Cell 3.
- NR Cell 3 is an Inactive SCell according to TS 38.508-1 [4] clause 6.3.1.
- System information combination NR-4 as defined in TS 38.508-1 [4] clause 4.4.3.1.2 is used in NR cells.

UE:

- None.

Preamble:

- The UE is in state 3N-A as defined in TS 38.508-1 [4], subclause 4.4A.

8.1.3.1.17.1.3.2 Test procedure sequence

Table 8.1.3.1.17.1.3.2-1 and 8.1.3.1.17.1.3.2-2 illustrates the downlink power levels to be applied for NR Cell 1, NR Cell 3 and NR Cell 12 at various time instants of the test execution. Row marked "T0" denotes the conditions after the preamble, while the configuration marked "T1" is applied at the point indicated in the Main behaviour description in Table 8.1.3.1.17.1.3.2-3.

Table 8.1.3.1.17.1.3.2-1: Time instances of cell power level and parameter changes in FR1

	Parameter	Unit	NR Cell 1	NR Cell 3	NR Cell 12	Remark
T0	SS/PBCH SSS EPRE	dBm/SCS	-82	-88	-94	Power levels are such that entry condition for event A6 (measId 1) is not satisfied: $Mn + Ocn + Hys < Ms + Ocs + Off$
T1	SS/PBCH SSS EPRE	dBm/SCS	-82	-88	-78	Power levels are such that entry condition for event A6 (measId 1) is satisfied: $Mn + Ocn - Hys > Ms + Ocs + Off$

Table 8.1.3.1.17.1.3.2-2: Time instances of cell power level and parameter changes in FR2

	Parameter	Unit	NR Cell 1	NR Cell 3	NR Cell 12	Remark
T0	SS/PBCH SSS EPRE	dBm/SCS	FFS	FFS	FFS	Power levels are such that entry condition for event A6 (measId 1) is not satisfied: $Mn + Ocn + Hys < Ms + Ocs + Off$
T1	SS/PBCH SSS EPRE	dBm/SCS	FFS	FFS	FFS	Power levels are such that entry condition for event A6 (measId 1) is satisfied: $Mn + Ocn - Hys > Ms + Ocs + Off$

Table 8.1.3.1.17.1.3.2-3: Main behaviour

St	Procedure	Message Sequence		TP	Verdict
		U - S	Message		
1	The SS transmits an <i>RRCReconfiguration</i> message including <i>sCellToAddModList</i> with NR Cell 3 as SCell addition.	<--	NR RRC: <i>RRCReconfiguration</i>	-	-
2	The UE transmits an <i>RRCReconfigurationComplete</i> message.	-->	NR RRC: <i>RRCReconfigurationComplete</i>	-	-
3	The SS transmits an <i>RRCReconfiguration</i> message including <i>measConfig</i> to setup intra NR measurement and reporting for event A6.	<--	NR RRC: <i>RRCReconfiguration</i>	-	-
4	The UE transmits an <i>RRCReconfigurationComplete</i> message.	-->	NR RRC: <i>RRCReconfigurationComplete</i>	-	-
5	Check: Does the UE transmit a <i>MeasurementReport</i> message within the next 10s?	-->	NR RRC: <i>MeasurementReport</i>	1	F
6	The SS re-adjusts the SS/PBCH EPRE level according to row "T1" in table 8.1.3.1.17.1.3.2-1/2.	-	-	-	-
7	Check: Does the UE transmit a <i>MeasurementReport</i> message to report event A6 with the measured RSRP value for NR Cell 12?	-->	NR RRC: <i>MeasurementReport</i>	2	P
8	The SS transmits an <i>RRCReconfiguration</i> message including <i>sCellToReleaseList</i> with NR Cell 3 as SCell release.	<--	NR RRC: <i>RRCReconfiguration</i>	-	-
9	The UE transmits an <i>RRCReconfigurationComplete</i> message.	-->	NR RRC: <i>RRCReconfigurationComplete</i>	-	-
10	Check: Does the UE attempt to transmit an uplink message for the next 15s?	-	-	3	F

8.1.3.1.17.1.3.3 Specific message contents

Table 8.1.3.1.17.1.3.3-1: *RRCReconfiguration* (step 1, Table 8.1.3.1.17.1.3.2-3)

Derivation Path: 38.508-1 [4] Table 4.6.1-13 with condition SCell_add

Table 8.1.3.1.17.1.3.3-2: Void

Table 8.1.3.1.17.1.3.3-3: Void

Table 8.1.3.1.17.1.3.3-4: *RRCReconfiguration* (step 3, Table 8.1.3.1.17.1.3.2-3)

Derivation Path: 38.508-1 [4] Table 4.6.1-13 with condition NR_MEAS

Table 8.1.3.1.17.1.3.3-5: *MeasConfig* (Table 8.1.3.1.17.1.3.3-4)

Derivation Path: 38.508-1 [4] Table 4.6.3-69			
Information Element	Value/remark	Comment	Condition
MeasConfig ::= SEQUENCE {			
measObjectToAddModList SEQUENCE (SIZE (1..maxNrofMeasId)) OF MeasObjectToAddMod {	2 entries		
MeasObjectToAddMod[1] SEQUENCE {		entry 1	
measObjectId	1	MeasObjectIdNR-f1	
measObject CHOICE {			
measObjectNR SEQUENCE {			
ssbFrequency	ssbFrequency IE equals the ARFCN for NR Cell 1		
absThreshSS-BlocksConsolidation	Not present		
}			
}			
MeasObjectToAddMod[2] SEQUENCE {		entry 2	
measObjectId	2	MeasObjectIdNR-f2	
measObject CHOICE {			
measObjectNR SEQUENCE {			
ssbFrequency	ssbFrequency IE equals the ARFCN for NR Cell 3		
absThreshSS-BlocksConsolidation	Not present		
}			
}			
reportConfigToAddModList SEQUENCE(SIZE (1..maxReportConfigId)) OF ReportConfigToAddMod {	1 entry		
ReportConfigToAddMod[1] SEQUENCE {		entry 1	
reportConfigId[1]	1		
reportConfig[1] CHOICE {			
reportConfigNR	ReportConfigNR-EventA6	Table 8.1.3.1.17.1.3.3-6	
}			
}			
measIdToAddModList SEQUENCE (SIZE (1..maxNrofMeasId)) OF MeasIdToAddMod {	1 entry		
MeasIdToAddMod[1] SEQUENCE {		entry 1	
measId[1]	1		
measObjectId[1]	2		
reportConfigId[1]	1		
}			
}			
}			

Table 8.1.3.1.17.1.3.3-6: ReportConfigNR-EventA6 (Table 8.1.3.1.17.1.3.3-5)

Derivation Path: 38.508-1 [4] Table 4.6.3-142 with condition EVENT_A6			
Information Element	Value/remark	Comment	Condition
ReportConfigNR ::= SEQUENCE {			
reportType CHOICE {			
eventTriggered SEQUENCE {			
eventId CHOICE {			
eventA6 SEQUENCE {			
a6-Offset CHOICE {			
rsrp	0		
}			
}			
}			
reportInterval	ms10240		
reportQuantityCell SEQUENCE {			
rsrp	true		
rsrq	false		
sinr	false		
}			
}			
}			

Table 8.1.3.1.17.1.3.3-7: MeasurementReport (step 7, Table 8.1.3.1.17.1.3.2-3)

Derivation Path: TS 38.508-1 [4] Table 4.6.1-5A			
Information Element	Value/remark	Comment	Condition
MeasurementReport ::= SEQUENCE {			
criticalExtensions CHOICE {			
measurementReport SEQUENCE {			
measResults	MeasResults		
}			
}			
}			

Table 8.1.3.1.17.1.3.3-8: *MeasResults* (Table 8.1.3.1.17.1.3.3-7)

Derivation Path: 38.508-1 [4] Table 4.6.3-79			
Information Element	Value/remark	Comment	Condition
MeasResults ::= SEQUENCE {			
measId	1		
measResultServingMOList SEQUENCE (SIZE (1..maxNrofServingCells)) OF MeasResultServMO {	2 entries		
MeasResultServMO[1] SEQUENCE {		entry 1	
servCellId	ServCellIndex of NR Cell 1		
measResultServingCell SEQUENCE {			
physCellId	Physical layer cell identity of NR Cell 1		
measResult SEQUENCE {			
cellResults SEQUENCE {			
resultsSSB-Cell SEQUENCE {			
rsrp	(0..127)		
rsrq	(0..127)		
sinr	Not present		
}			
}			
}			
}			
MeasResultServMO[2] SEQUENCE {		entry 2	
servCellId	ServCellIndex of NR Cell 3		
measResultServingCell SEQUENCE {			
physCellId	Physical layer cell identity of NR Cell 3		
measResult SEQUENCE {			
cellResults SEQUENCE {			
resultsSSB-Cell SEQUENCE {			
rsrp	(0..127)		
rsrq	(0..127)		
sinr	Not present		
}			
}			
}			
}			
measResultNeighCells CHOICE {			
measResultListNR SEQUENCE (SIZE (1..maxCellReport)) OF MeasResultNR {	1 entry	Report NR Cell 12	
MeasResultNR[1] SEQUENCE {		entry 1	
physCellId	Physical layer cell identity of NR Cell 12		
measResult SEQUENCE {			
cellResults SEQUENCE {			
resultsSSB-Cell SEQUENCE {			
rsrp	(0..127)		
rsrq	Not present		
sinr	Not present		
}			
resultsCSI-RS-Cell	Not present		
}			
rsIndexResults	Not present		
}			
cgi-Info	Not present		
}			
}			
}			

Table 8.1.3.1.17.1.3.3-9: RRCReconfiguration (step 8, Table 8.1.3.1.17.1.3.2-3)

Derivation Path: 38.508-1 [4] Table 4.6.1-13 with condition SCell_add			
Information Element	Value/remark	Comment	Condition
RRCReconfiguration ::= SEQUENCE {			
criticalExtensions CHOICE {			
rrcReconfiguration SEQUENCE {			
nonCriticalExtension SEQUENCE{			
masterCellGroup	CellGroupConfig	Table 8.1.3.1.17.1.3.3-10 SCell release for NR Cell 3	
dedicatedSIB1-Delivery	Not present	SCell release	
}			
}			
}			
}			

Table 8.1.3.1.17.1.3.3-10: CellGroupConfig (Table 8.1.3.1.17.1.3.3-9)

Derivation Path: 38.508-1 [4] Table 4.6.3-19 with condition SCell_add			
Information Element	Value/remark	Comment	Condition
CellGroupConfig ::= SEQUENCE {			
sCellToAddModList	Not present		
sCellToReleaseList SEQUENCE (SIZE (1..maxNrofSCells)) OF SCellIndex {	1 entry		
SCellIndex[1]	1	entry 1 SCell release for NR Cell 3	
}			
}			

8.1.3.1.17.2 NR CA / Measurement configuration control and reporting / Intra NR measurements / Event A6 / Inter-band CA

8.1.3.1.17.2.1 Test Purpose (TP)

Same as TC 8.1.3.1.17.1 but applied to Inter-band CA case.

8.1.3.1.17.2.2 Conformance requirements

Same as TC 8.1.3.1.17.1 but applied to Inter-band CA case.

8.1.3.1.17.2.3 Test description

8.1.3.1.17.2.3.1 Pre-test conditions

Same as test case 8.1.3.1.17.1 with the following differences:

- CA configuration: Inter-band CA replaces Intra-band Contiguous CA.
- Cells configuration: NR Cell 10 replaces NR Cell 3, NR Cell 30 replaces NR Cell 12.
- NR Cell 10 is an Inactive SCell according to TS 38.508-1 [4] clause 6.3.1.

8.1.3.1.17.2.3.2 Test procedure sequence

Same as test case 8.1.3.1.17.1 with the following differences:

- CA configuration: Inter-band CA replaces Intra-band Contiguous CA.

- Cells configuration: NR Cell 10 replaces NR Cell 3, NR Cell 30 replaces NR Cell 12.

8.1.3.1.17.2.3.3 Specific message contents

Same as test case 8.1.3.1.17.1 with the following differences.

NOTE: For simplicity the steps referred below are steps in test case 8.1.3.1.17.1.

Table 8.1.3.1.17.2.3.3-1: MeasConfig (Table 8.1.3.1.17.1.3.3-5)

Derivation Path: 38.508-1 [4] Table 4.6.3-69			
Information Element	Value/remark	Comment	Condition
MeasConfig ::= SEQUENCE {			
measObjectToAddModList SEQUENCE (SIZE (1..maxNrofMeasId)) OF MeasObjectToAddMod {	2 entries		
MeasObjectToAddMod[1] SEQUENCE {		entry 1	
measObjectId	1	MeasObjectIdNR-f1	
measObject CHOICE {			
measObjectNR SEQUENCE {			
ssbFrequency	ssbFrequency IE equals the ARFCN for NR Cell 1		
absThreshSS-BlocksConsolidation	Not present		
}			
}			
}			
MeasObjectToAddMod[2] SEQUENCE {		entry 2	
measObjectId	2	MeasObjectIdNR-f5	
measObject CHOICE {			
measObjectNR SEQUENCE {			
ssbFrequency	ssbFrequency IE equals the ARFCN for NR Cell 10		
absThreshSS-BlocksConsolidation	Not present		
}			
}			
}			
reportConfigToAddModList SEQUENCE(SIZE (1..maxReportConfigId)) OF ReportConfigToAddMod {	1 entry		
ReportConfigToAddMod[1] SEQUENCE {		entry 1	
reportConfigId	1		
reportConfig CHOICE {			
reportConfigNR	ReportConfigNR-EventA6		
}			
}			
}			
measIdToAddModList SEQUENCE (SIZE (1..maxNrofMeasId)) OF MeasIdToAddMod {	1 entry		
MeasIdToAddMod[1] SEQUENCE {		entry 1	
measId	1		
measObjectId	2		
reportConfigId	1		
}			
}			
}			

8.1.3.1.17.3 NR CA / Measurement configuration control and reporting / Intra NR measurements / Event A6 / Intra-band non Contiguous CA

8.1.3.1.17.3.1 Test Purpose (TP)

Same as TC 8.1.3.1.17.1 but applied to Intra-band non Contiguous CA case.

8.1.3.1.17.3.2 Conformance requirements

Same as TC 8.1.3.1.17.1 but applied to Intra-band non Contiguous CA case.

8.1.3.1.17.3.3 Test description

8.1.3.1.17.3.3.1 Pre-test conditions

Same as test case 8.1.3.1.17.1 with the following differences:

- CA configuration: Intra-band non Contiguous CA replaces Intra-band Contiguous CA.

8.1.3.1.17.3.3.2 Test procedure sequence

Same as test case 8.1.3.1.17.1 with the following differences:

- CA configuration: Intra-band non Contiguous CA replaces Intra-band Contiguous CA.

8.1.3.1.17.3.3.3 Specific message contents

Same as test case 8.1.3.1.17.1 but applied to Intra-band non Contiguous CA case..

NOTE: For simplicity the steps referred below are steps in test case 8.1.3.1.17.1.

8.1.3.1.18 NR CA / Measurement configuration control and reporting / Intra NR measurements / Additional measurement reporting

8.1.3.1.18.1 NR CA / Measurement configuration control and reporting / Intra NR measurements / Additional measurement reporting / Intra-band Contiguous CA

8.1.3.1.18.1.1 Test Purpose (TP)

(1)

```
with { UE in NR RRC_CONNECTED state and measurements configured for event A2 reporting include
reportAddNeighMeas }
ensure that {
  when { Entry condition for event A2 of the concerned frequency that triggered measurement
reporting is met }
    then { UE sends MeasurementReport that does not include the best non-serving cell of the
concerned frequency in the measResultBestNeighCell }
}
```

(2)

```
with { UE in NR RRC_CONNECTED state and measurements configured for event A2 reporting include
reportAddNeighMeas }
ensure that {
  when { Entry condition for event A2 of other than the concerned frequency that triggered
measurement reporting is met }
    then { UE sends MeasurementReport that includes the best non-serving cell of the concerned
frequency in the measResultBestNeighCell }
}
```

8.1.3.1.18.1.2 Conformance requirements

References: The conformance requirements covered in the current TC are specified in: TS 38.331, clauses 5.3.5.3, 5.3.5.5.9, 5.5.2.1, 5.5.4.1, 5.5.4.7 and 5.5.5. Unless otherwise stated these are Rel-15 requirements.

[TS 38.331, clause 5.3.5.3]

The UE shall perform the following actions upon reception of the *RRCReconfiguration*:

...

1> if the *RRCReconfiguration* includes the *masterCellGroup*:

2> perform the cell group configuration for the received *masterCellGroup* according to 5.3.5.5;

...

1> if the *RRCReconfiguration* message includes the *measConfig*:

2> perform the measurement configuration procedure as specified in 5.5.2;

...

1> if the UE is configured with E-UTRA *nr-SecondaryCellGroupConfig* (MCG is E-UTRA):

...

1> else:

2> submit the *RRCReconfigurationComplete* message via SRB1 to lower layers for transmission using the new configuration;

...

[TS 38.331, clause 5.3.5.5.9]

The UE shall:

1> for each *sCellIndex* value included in the *sCellToAddModList* that is not part of the current UE configuration (SCell addition):

2> add the SCell, corresponding to the *sCellIndex*, in accordance with the *sCellConfigCommon* and *sCellConfigDedicated*;

2> configure lower layers to consider the SCell to be in deactivated state;

Editor's Note: FFS Check automatic measurement handling for SCells.

2> for each *measId* included in the *measIdList* within *VarMeasConfig*:

3> if SCells are not applicable for the associated measurement; and

3> if the concerned SCell is included in *cellsTriggeredList* defined within the *VarMeasReportList* for this *measId*:

4> remove the concerned SCell from *cellsTriggeredList* defined within the *VarMeasReportList* for this *measId*;

1> for each *sCellIndex* value included in the *sCellToAddModList* that is part of the current UE configuration (SCell modification):

2> modify the SCell configuration in accordance with the *sCellConfigDedicated*.

[TS 38.331, clause 5.5.2.1]

...

The UE shall:

...

1> if the received *measConfig* includes the *measObjectToAddModList*:

2> perform the measurement object addition/modification procedure as specified in 5.5.2.5;

...

1> if the received *measConfig* includes the *reportConfigToAddModList*:

2> perform the reporting configuration addition/modification procedure as specified in 5.5.2.7;

...

1> if the received *measConfig* includes the *measIdToAddModList*:

2> perform the measurement identity addition/modification procedure as specified in 5.5.2.3;

[TS 38.331, clause 5.5.4.1]

If security has been activated successfully, the UE shall:

1> for each *measId* included in the *measIdList* within *VarMeasConfig*:

2> if the corresponding *reportConfig* includes a *reportType* set to *eventTriggered* or *periodical*;

3> if the corresponding *measObject* concerns NR;

4> if the *eventA1* or *eventA2* is configured in the corresponding *reportConfig*:

5> consider only the serving cell to be applicable;

...

2> if the *reportType* is set to *eventTriggered* and if the entry condition applicable for this event, i.e. the event corresponding with the *eventId* of the corresponding *reportConfig* within *VarMeasConfig*, is fulfilled for one or more applicable cells for all measurements after layer 3 filtering taken during *timeToTrigger* defined for this event within the *VarMeasConfig*, while the *VarMeasReportList* does not include a measurement reporting entry for this *measId* (a first cell triggers the event):

3> include a measurement reporting entry within the *VarMeasReportList* for this *measId*;

3> set the *numberOfReportsSent* defined within the *VarMeasReportList* for this *measId* to 0;

3> include the concerned cell(s) in the *cellsTriggeredList* defined within the *VarMeasReportList* for this *measId*;

3> initiate the measurement reporting procedure, as specified in 5.5.5;

2> if the *reportType* is set to *eventTriggered* and if the entry condition applicable for this event, i.e. the event corresponding with the *eventId* of the corresponding *reportConfig* within *VarMeasConfig*, is fulfilled for one or more applicable cells not included in the *cellsTriggeredList* for all measurements after layer 3 filtering taken during *timeToTrigger* defined for this event within the *VarMeasConfig* (a subsequent cell triggers the event):

3> set the *numberOfReportsSent* defined within the *VarMeasReportList* for this *measId* to 0;

3> include the concerned cell(s) in the *cellsTriggeredList* defined within the *VarMeasReportList* for this *measId*;

3> initiate the measurement reporting procedure, as specified in 5.5.5;

2> if the *reportType* is set to *eventTriggered* and if the leaving condition applicable for this event is fulfilled for one or more of the cells included in the *cellsTriggeredList* defined within the *VarMeasReportList* for this *measId* for all measurements after layer 3 filtering taken during *timeToTrigger* defined within the *VarMeasConfig* for this event:

3> remove the concerned cell(s) in the *cellsTriggeredList* defined within the *VarMeasReportList* for this *measId*;

3> if *reportOnLeave* is set to *TRUE* for the corresponding reporting configuration:

4> initiate the measurement reporting procedure, as specified in 5.5.5;

3> if the *cellsTriggeredList* defined within the *VarMeasReportList* for this *measId* is empty:

4> remove the measurement reporting entry within the *VarMeasReportList* for this *measId*;

4> stop the periodical reporting timer for this *measId*, if running;

...

2> upon expiry of the periodical reporting timer for this *measId*:

3> initiate the measurement reporting procedure, as specified in 5.5.5.

...

[TS 38.331, clause 5.5.4.7]

The UE shall:

1> consider the entering condition for this event to be satisfied when condition A2-1, as specified below, is fulfilled;

1> consider the leaving condition for this event to be satisfied when condition A2-2, as specified below, is fulfilled;

1> for this measurement, consider the serving cell indicated by the *measObjectNR* associated to this event.

Inequality A2-1 (Entering condition)

$$Ms + Hys < Thresh$$

Inequality A2-2 (Leaving condition)

$$Ms - Hys > Thresh$$

The variables in the formula are defined as follows:

Ms is the measurement result of the serving cell, not taking into account any offsets.

Hys is the hysteresis parameter for this event (i.e. *hysteresis* as defined within *reportConfigNR* for this event).

Thresh is the threshold parameter for this event (i.e. *a2-Threshold* as defined within *reportConfigNR* for this event).

Ms is expressed in dBm in case of RSRP, or in dB in case of RSRQ and RS-SINR.

Hys is expressed in dB.

Thresh is expressed in the same unit as *Ms*.

[TS 38.331, clause 5.5.5]



Figure 5.5.5-1: Measurement reporting

The purpose of this procedure is to transfer measurement results from the UE to the network. The UE shall initiate this procedure only after successful security activation.

For the *measId* for which the measurement reporting procedure was triggered, the UE shall set the *measResults* within the *MeasurementReport* message as follows:

- 1> set the *measId* to the measurement identity that triggered the measurement reporting;
- 1> set the *measResultServingCell* within *measResultServingMOList* to include RSRP, RSRQ and the available SINR for each configured serving cell derived based on the *rsType* indicated in the associated *reportConfig*;
- 1> set the *measResultServingCell* within *measResultServingMOList* to include for each NR serving cell that is configured with *servingCellMO*, if any, the *servCellId*;
- ...
- 1> if the *reportConfig* associated with the *measId* that triggered the measurement reporting includes *reportAddNeighMeas*:
 - 2> for each serving cell *measObjectId* referenced in the *measIdList*, other than the *measObjectId* corresponding with the *measId* that triggered the measurement reporting:
 - 3> set the *measResultBestNeighCell* within *measResultServingMOList* to include the *physCellId* and the available measurement quantities based on the *reportQuantityCell* and *rsType* indicated in *reportConfig* of the non-serving cell corresponding to the concerned *measObjectNR* with the highest measured RSRP if RSRP measurement results are available for cells corresponding to this *measObjectNR*, otherwise with the highest measured RSRQ if RSRQ measurement results are available for cells corresponding to this *measObjectNR*, otherwise with the highest measured SINR;
 - ...
- 1> if there is at least one applicable neighbouring cell to report:
 - 2> set the *measResultNeighCells* to include the best neighbouring cells up to *maxReportCells* in accordance with the following:
 - 3> if the *reportType* is set to *eventTriggered*:
 - 4> include the cells included in the *cellsTriggeredList* as defined within the *VarMeasReportList* for this *measId*;
 - ...
 - 3> for each cell that is included in the *measResultNeighCells*, include the *physCellId*;
 - 3> if the *reportType* is set to *eventTriggered*:
 - 4> for each included cell, include the layer 3 filtered measured results in accordance with the *reportConfig* for this *measId*, ordered as follows:
 - 5> if the *measObject* associated with this *measId* concerns NR:
 - 6> if *rsType* in the associated *reportConfig* is set to *ssb*:
 - 7> set *results SSB-Cell* within the *measResult* to include the SS/PBCH block based quantity(ies) indicated in the *reportQuantityCell* within the concerned *reportConfig*, in order of decreasing trigger quantity, i.e. the best cell is included first;
 - ...
 - 1> increment the *numberOfReportsSent* as defined within the *VarMeasReportList* for this *measId* by 1;
 - 1> stop the periodical reporting timer, if running;
 - 1> if the *numberOfReportsSent* as defined within the *VarMeasReportList* for this *measId* is less than the *reportAmount* as defined within the corresponding *reportConfig* for this *measId*:

2> start the periodical reporting timer with the value of *reportInterval* as defined within the corresponding *reportConfig* for this *measId*;

...

1> if the UE is configured with EN-DC:

...

1> else:

2> submit the *MeasurementReport* message to lower layers for transmission, upon which the procedure ends.

8.1.3.1.18.1.3 Test description

8.1.3.1.18.1.3.1 Pre-test conditions

System Simulator:

- NR Cell 1 is the PCell, NR Cell 3 is the SCell to be added, NR Cell 12 (broadcast only cell) and NR Cell 23 (broadcast only cell) is the intra-frequency neighbour cell of NR Cell 3.
- NR Cell 3 is an Inactive SCell according to TS 38.508-1 [4] clause 6.3.1.
- Relative SS signal level uncertainty between Intra-freq cells is +/-1 dB for FR1 and FFS for FR2.
- System information combination NR-4 as defined in TS 38.508-1 [4] clause 4.4.3.1.2 is used in NR cells.

UE:

- None.

Preamble:

- The UE is in state 3N-A as defined in TS 38.508-1 [4], subclause 4.4A.

8.1.3.1.18.1.3.2 Test procedure sequence

Table 8.1.3.1.18.1.3.2-1 and 8.1.3.1.18.1.3.2-2 illustrates the downlink power levels to be applied for NR Cell 1, NR Cell 3, NR Cell 12 and NR Cell 23 at various time instants of the test execution. Row marked "T0" denotes the conditions after the preamble, while the configuration marked "T1" and "T2" are applied at the point indicated in the Main behaviour description in Table 8.1.3.1.18.1.3.2-3.

Table 8.1.3.1.18.1.3.2-1: Time instances of cell power level and parameter changes in FR1

	Parameter	Unit	NR Cell 1	NR Cell 3	NR Cell 12	NR Cell 23	Remark
T0	SS/PBCH SSS EPRE	dBm/ SCS	-82	-82	-91	Off	Power levels are such that entry condition for event A2 is not satisfied: $Ms + Hys > Thresh$ for NR Cell 1 and NR Cell 3
T1	SS/PBCH SSS EPRE	dBm/ SCS	-82	-98	-91	-88	Power levels are such that entry condition for event A2 in NR Cell 3 is satisfied: $Ms + Hys < Thresh$
T2	SS/PBCH SSS EPRE	dBm/ SCS	-82	-82	-78	-82	Power levels are such that entry condition for event A2 is not satisfied: $Ms + Hys > Thresh$ for NR Cell 1 and NR Cell 3
T3	SS/PBCH SSS EPRE	dBm/ SCS	-98	-82	-78	-82	Power levels are such that entry condition for event A2 in NR Cell 1 is satisfied: $Ms + Hys < Thresh$

Table 8.1.3.1.18.1.3.2-2: Time instances of cell power level and parameter changes in FR2

	Parameter	Unit	NR Cell 1	NR Cell 3	NR Cell 12	NR Cell 23	Remark
T0	SS/PBCH SSS EPRE	dBm/SCS	FFS	FFS	FFS	Off	Power levels are such that entry condition for event A2 is not satisfied: $Ms + Hys > Thresh$ for NR Cell 1 and NR Cell 3
T1	SS/PBCH SSS EPRE	dBm/SCS	FFS	FFS	FFS	Off	Power levels are such that entry condition for event A2 in NR Cell 3 is satisfied: $Ms + Hys < Thresh$
T2	SS/PBCH SSS EPRE	dBm/SCS	FFS	FFS	FFS	Off	Power levels are such that entry condition for event A2 is not satisfied: $Ms + Hys > Thresh$ for NR Cell 1 and NR Cell 3
T3	SS/PBCH SSS EPRE	dBm/SCS	FFS	FFS	FFS	FFS	Power levels are such that entry condition for event A2 in NR Cell 1 is satisfied: $Ms + Hys < Thresh$

Table 8.1.3.1.18.1.3.2-3: Main behaviour

St	Procedure	Message Sequence		TP	Verdict
		U - S	Message		
1	The SS transmits an <i>RRCReconfiguration</i> message including <i>sCellToAddModList</i> with NR Cell 3 as SCell addition.	<--	NR RRC: <i>RRCReconfiguration</i>	-	-
2	The UE transmits an <i>RRCReconfigurationComplete</i> message.	-->	NR RRC: <i>RRCReconfigurationComplete</i>	-	-
3	The SS transmits an <i>RRCReconfiguration</i> message including <i>measConfig</i> to setup intra NR measurement and for event A2 reporting configuration and include <i>reportAddNeighMeas</i> .	<--	NR RRC: <i>RRCReconfiguration</i>	-	-
4	The UE transmits an <i>RRCReconfigurationComplete</i> message.	-->	NR RRC: <i>RRCReconfigurationComplete</i>	-	-
5	The SS re-adjusts the SS/PBCH EPRE level according to row "T1" in table 8.1.3.1.18.1.3.2-1/2.	-	-	-	-
6	Check: Does the UE transmit a <i>MeasurementReport</i> message that does not include the RSRP value of the best non-serving cell on the concerned serving frequency in <i>measResultBestNeighCell</i> ?	-->	NR RRC: <i>MeasurementReport</i>	1	P
7	The SS re-adjusts the cell-specific reference signal level according to row "T2" in table 8.1.3.1.18.1.3.2-1/2.	-	-	-	-
7A	The SS re-adjusts the cell-specific reference signal level according to row "T3" in table 8.1.3.1.18.1.3.2-1/2, 1 second after step 7	-	-	-	-
8	Check: Does the UE transmit a <i>MeasurementReport</i> message included the RSRP value of the best non-serving cell (NR Cell 12) on the concerned serving frequency in <i>measResultBestNeighCell</i> ?	-->	NR RRC: <i>MeasurementReport</i>	2	P

8.1.3.1.18.1.3.3 Specific message contents

Table 8.1.3.1.18.1.3.3-1: *RRCReconfiguration* (step 1, Table 8.1.3.1.18.1.3.2-3)

Derivation Path: 38.508-1 [4] Table 4.6.1-13 with condition SCell_add

Table 8.1.3.1.18.1.3.3-2: Void

Table 8.1.3.1.18.1.3.3-3: Void

Table 8.1.3.1.18.1.3.3-4: *RRCReconfiguration* (step 3, Table 8.1.3.1.18.1.3.2-3)

Derivation Path: 38.508-1 [4] Table 4.6.1-13 with condition NR_MEAS

Table 8.1.3.1.18.1.3.3-5: *MeasConfig* (Table 8.1.3.1.18.1.3.3-4)

Derivation Path: 38.508-1 [4] Table 4.6.3-69			
Information Element	Value/remark	Comment	Condition
MeasConfig ::= SEQUENCE {			
measObjectToAddModList SEQUENCE (SIZE (1..maxNrofMeasId)) OF MeasObjectToAddMod {	2 entries		
MeasObjectToAddMod[1] SEQUENCE {		entry 1	
measObjectId	1	MeasObjectIdNR-f1	
measObject CHOICE {			
measObjectNR SEQUENCE {			
ssbFrequency	ssbFrequency IE equals the ARFCN for NR Cell 1		
absThreshSS-BlocksConsolidation	Not present		
}			
}			
MeasObjectToAddMod[2] SEQUENCE {		entry 2	
measObjectId	2	MeasObjectIdNR-f2	
measObject CHOICE {			
measObjectNR SEQUENCE {			
ssbFrequency	ssbFrequency IE equals the ARFCN for NR Cell 3		
absThreshSS-BlocksConsolidation	Not present		
}			
}			
reportConfigToAddModList SEQUENCE(SIZE (1..maxReportConfigId)) OF ReportConfigToAddMod {	1 entry		
ReportConfigToAddMod[1] SEQUENCE {		entry 1	
reportConfigId	1		
reportConfig CHOICE {			
reportConfigNR	ReportConfigNR-EventA2	Table 8.1.3.1.18.1.3.3-6	
}			
}			
measIdToAddModList SEQUENCE (SIZE (1..maxNrofMeasId)) OF MeasIdToAddMod {	2 entries		
MeasIdToAddMod[1] SEQUENCE {		entry 1	
measId	1		
measObjectId	1		
reportConfigId	1		
}			
MeasIdToAddMod[2] SEQUENCE {		entry 2	
measId	2		
measObjectId	2		
reportConfigId	1		
}			
}			
}			

Table 8.1.3.1.18.1.3.3-8: MeasResults1 (Table 8.1.3.1.18.1.3.3-7)

Derivation Path: 38.508-1 [4] Table 4.6.3-79 with Condition A2			
Information Element	Value/remark	Comment	Condition
MeasResults ::= SEQUENCE {		Step 6	
measId	2		
measResultServingMOList SEQUENCE (SIZE (1..maxNrofServingCells)) OF MeasResultServMO {	2 entries		
MeasResultServMO[1] SEQUENCE {		entry 1	
servCellId	ServCellIndex of NR Cell 1		
measResultServingCell SEQUENCE {			
physCellId	Physical layer cell identity of NR Cell 1		
measResult SEQUENCE {			
cellResults SEQUENCE {			
resultsSSB-Cell SEQUENCE {			
rsrp	(0..127)		
rsrq	(0..127)		
sinr	Not present		
}			
}			
}			
}			
MeasResultServMO[2] SEQUENCE {		entry 2	
servCellId	ServCellIndex of NR Cell 3		
measResultServingCell SEQUENCE {			
physCellId	Physical layer cell identity of NR Cell 3		
measResult SEQUENCE {			
cellResults SEQUENCE {			
resultsSSB-Cell SEQUENCE {			
rsrp	(0..127)		
rsrq	(0..127)		
sinr	Not present		
}			
}			
}			
}			
}			
}			

Table 8.1.3.1.18.1.3.3-9: *MeasResults2* (Table 8.1.3.1.18.1.3.3-7)

Derivation Path: 38.508-1 [4] Table 4.6.3-79 with Condition A2			
Information Element	Value/remark	Comment	Condition
MeasResults ::= SEQUENCE {		Step 8	
measId	1		
measResultServingMOList SEQUENCE (SIZE (1..maxNrofServingCells)) OF MeasResultServMO {	2 entries		
MeasResultServMO[1] SEQUENCE {		entry 1	
servCellId	ServCellIndex of NR Cell 1		
measResultServingCell SEQUENCE {			
physCellId	Physical layer cell identity of NR Cell 1		
measResult SEQUENCE {			
cellResults SEQUENCE {			
resultsSSB-Cell SEQUENCE {			
rsrp	(0..127)		
rsrq	(0..127)		
sinr	Not present		
}			
}			
}			
}			
MeasResultServMO[2] SEQUENCE {		entry 2	
servCellId	ServCellIndex of NR Cell 3		
measResultServingCell SEQUENCE {			
physCellId	Physical layer cell identity of NR Cell 3		
measResult SEQUENCE {			
cellResults SEQUENCE {			
resultsSSB-Cell SEQUENCE {			
rsrp	(0..127)		
rsrq	(0..127)		
sinr	Not present		
}			
}			
}			
measResultBestNeighCell SEQUENCE {		Report NR Cell 12	
physCellId	Physical layer cell identity of NR Cell 12		
measResult SEQUENCE {			
cellResults SEQUENCE {			
resultsSSB-Cell SEQUENCE {			
rsrp	(0..127)		
rsrq	Not present		
sinr	Not present		
}			
resultsCSI-RS-Cell	Not present		
}			
rsIndexResults	Not present		
}			
cgi-Info	Not present		
}			
}			
}			
}			

8.1.3.1.18.2 NR CA / Measurement configuration control and reporting / Intra NR measurements / Additional measurement reporting / Inter-band CA

8.1.3.1.18.2.1 Test Purpose (TP)

Same as TC 8.1.3.1.18.1 but applied to Inter-band CA case.

8.1.3.1.18.2.2 Conformance requirements

Same as TC 8.1.3.1.18.1 but applied to Inter-band CA case.

8.1.3.1.18.2.3 Test description

8.1.3.1.18.2.3.1 Pre-test conditions

Same as test case 8.1.3.1.18.1 with the following differences:

- CA configuration: Inter-band CA replaces Intra-band Contiguous CA.
- Cells configuration: NR Cell 10 replaces NR Cell 3, NR Cell 30 replaces NR Cell 12 and NR Cell 31 replaces NR Cell 23.
- NR Cell 10 is an Inactive SCell according to TS 38.508-1 [4] clause 6.3.1.

8.1.3.1.18.2.3.2 Test procedure sequence

Same as test case 8.1.3.1.18.1 with the following differences:

- CA configuration: Inter-band CA replaces Inter-band Contiguous CA
- Cells configuration: NR Cell 10 replaces NR Cell 3, NR Cell 30 replaces NR Cell 12 and NR Cell 31 replaces NR Cell 23.

8.1.3.1.18.2.3.3 Specific message contents

Same as test case 8.1.3.1.18.1 with the following differences.

NOTE: For simplicity the steps referred below are steps in test case 8.1.3.1.18.1.

Table 8.1.3.1.18.2.3.3-1: MeasConfig (Table 8.1.3.1.18.1.3.3-5)

Derivation Path: 38.508-1 [4] Table 4.6.3-69			
Information Element	Value/remark	Comment	Condition
MeasConfig ::= SEQUENCE {			
measObjectToAddModList SEQUENCE (SIZE (1..maxNrofMeasId)) OF MeasObjectToAddMod {	2 entries		
MeasObjectToAddMod[1] SEQUENCE {		entry 1	
measObjectId	1	MeasObjectIdNR-f1	
measObject CHOICE {			
measObjectNR SEQUENCE {			
ssbFrequency	ssbFrequency IE equals the ARFCN for NR Cell 1		
absThreshSS-BlocksConsolidation	Not present		
}			
}			
MeasObjectToAddMod[2] SEQUENCE {		entry 2	
measObjectId[2]	2	MeasObjectIdNR-f5	
measObject[2] CHOICE {			
measObjectNR SEQUENCE {			
ssbFrequency	ssbFrequency IE equals the ARFCN for NR Cell 10		
absThreshSS-BlocksConsolidation	Not present		
}			
}			
}			
reportConfigToAddModList SEQUENCE(SIZE (1..maxReportConfigId)) OF ReportConfigToAddMod {	1 entry		
ReportConfigToAddMod[1] SEQUENCE {		entry 1	
reportConfigId	1		
reportConfig CHOICE {			
reportConfigNR	ReportConfigNR-EventA2		
}			
}			
measIdToAddModList SEQUENCE (SIZE (1..maxNrofMeasId)) OF MeasIdToAddMod {	2 entries		
MeasIdToAddMod[1] SEQUENCE {		entry 1	
measId	1		
measObjectId	1		
reportConfigId	1		
}			
MeasIdToAddMod[2] SEQUENCE {		entry 2	
measId	2		
measObjectId	2		
reportConfigId	1		
}			
}			
}			

8.1.3.1.18.3 NR CA / Measurement configuration control and reporting / Intra NR measurements / Additional measurement reporting / Intra-band non Contiguous CA

8.1.3.1.18.3.1 Test Purpose (TP)

Same as TC 8.1.3.1.18.1 but applied to Intra-band non Contiguous CA case.

8.1.3.1.18.3.2 Conformance requirements

Same as TC 8.1.3.1.18.1 but applied to Intra-band non Contiguous CA case.

8.1.3.1.18.3.3 Test description

8.1.3.1.18.3.3.1 Pre-test conditions

Same as test case 8.1.3.1.18.1 with the following differences:

- CA configuration: Intra-band non Contiguous CA replaces Intra-band Contiguous CA.

8.1.3.1.18.3.3.2 Test procedure sequence

Same as test case 8.1.3.1.18.1 with the following differences:

- CA configuration: Intra-band non Contiguous CA replaces Inter-band Contiguous CA.

8.1.3.1.18.3.3.3 Specific message contents

Same as test case 8.1.3.1.18.1 but applied to Intra-band non Contiguous CA case.

8.1.3.1.19

8.1.3.1.20 Measurement configuration control and reporting / Measurement Gaps / gapFR1

8.1.3.1.20.1 Test Purpose (TP)

(1)

```
with { UE in NR RRC_CONNECTED state }
ensure that {
  when { UE receives RRCReconfiguration message containing MeasConfig to setup gapFR1 and report
periodical measurements for neighbor cell on FR1 frequency }
  then { UE applies gapFR1 and sends periodical measurements for neighbor cell on FR1 frequency }
}
```

8.1.3.1.20.2 Conformance requirements

References: The conformance requirements covered in the current TC are specified in: TS 38.331, clauses 5.3.5.3, 5.5.2.1, 5.5.2.9, 5.5.4.1, 5.5.4.5 and 5.5.5.1. Unless otherwise stated these are Rel-15 requirements.

[TS 38.331, clause 5.3.5.3]

The UE shall perform the following actions upon reception of the *RRCReconfiguration*:

...

1> if the *RRCReconfiguration* message includes the *measConfig*:

2> perform the measurement configuration procedure as specified in 5.5.2;

...

1> else:

2> submit the *RRCReconfigurationComplete* message via SRB1 to lower layers for transmission using the new configuration;

...

[TS 38.331, clause 5.5.2.1]

...

The UE shall:

...

1> if the received *measConfig* includes the *measObjectToAddModList*:

2> perform the measurement object addition/modification procedure as specified in 5.5.2.5;

...

1> if the received *measConfig* includes the *reportConfigToAddModList*:

2> perform the reporting configuration addition/modification procedure as specified in 5.5.2.7;

...

1> if the received *measConfig* includes the *measIdToAddModList*:

2> perform the measurement identity addition/modification procedure as specified in 5.5.2.3;

...

1> if the received *measConfig* includes the *measGapConfig*:

2> perform the measurement gap configuration procedure as specified in 5.5.2.9;

...

[TS 38.331, clause 5.5.2.9]

The UE shall:

1> if *gapFR1* is set to *setup*:

2> if an FR1 measurement gap configuration is already setup, release the FR1 measurement gap configuration;

2> setup the FR1 measurement gap configuration indicated by the *measGapConfig* in accordance with the received *gapOffset*, i.e., the first subframe of each gap occurs at an SFN and subframe meeting the following condition:

$$\text{SFN mod } T = \text{FLOOR}(\text{gapOffset}/10);$$

$$\text{subframe} = \text{gapOffset mod } 10;$$

with $T = \text{MGRP}/10$ as defined in TS 38.133 [14];

2> if *mgta* is configured, apply the specified timing advance to the gap occurrences calculated above (i.e. the UE starts the measurement *mgta* ms before the gap subframe occurrences);

...

[TS 38.331, clause 5.5.4.1]

If AS security has been activated successfully, the UE shall:

1> for each *measId* included in the *measIdList* within *VarMeasConfig*:

2> if the corresponding *reportConfig* includes a *reportType* set to *eventTriggered* or *periodical*:

3> if the corresponding *measObject* concerns NR:

...

4> for measurement events other than *eventA1* or *eventA2*:

5> else:

- 6> consider any neighbouring cell detected based on parameters in the associated *measObjectNR* to be applicable when the concerned cell is not included in the *blackCellsToAddModList* defined within the *VarMeasConfig* for this *measId*;
- ...
- 2> if *reportType* is set to *periodical* and if a (first) measurement result is available:
- 3> include a measurement reporting entry within the *VarMeasReportList* for this *measId*;
- 3> set the *numberOfReportsSent* defined within the *VarMeasReportList* for this *measId* to 0;
- 3> if the *reportAmount* exceeds 1:
- 4> initiate the measurement reporting procedure, as specified in 5.5.5, immediately after the quantity to be reported becomes available for the NR SpCell;
- 3> else (i.e. the *reportAmount* is equal to 1):
- 4> initiate the measurement reporting procedure, as specified in 5.5.5, immediately after the quantity to be reported becomes available for the NR SpCell and for the strongest cell among the applicable cells;
- 2> upon expiry of the periodical reporting timer for this *measId*:
- 3> initiate the measurement reporting procedure, as specified in 5.5.5.
- ...

[TS 38.331, clause 5.5.5.1]



Figure 5.5.5.1-1: Measurement reporting

The purpose of this procedure is to transfer measurement results from the UE to the network. The UE shall initiate this procedure only after successful AS security activation.

For the *measId* for which the measurement reporting procedure was triggered, the UE shall set the *measResults* within the *MeasurementReport* message as follows:

- 1> set the *measId* to the measurement identity that triggered the measurement reporting;
- 1> set the *measResultServingCell* within *measResultServingMOList* to include, for each NR serving cell that is configured with *servingCellMO*, RSRP, RSRQ and the available SINR, derived based on the *rsType* if indicated in the associated *reportConfig*, otherwise based on SSB if available, otherwise based on CSI-RS;
- 1> set the *servCellId* within *measResultServingMOList* to include each NR serving cell that is configured with *servingCellMO*, if any;
- ...
- 1> if there is at least one applicable neighbouring cell to report:
- 2> if the *reportType* is set to *eventTriggered* or *periodical*:
- 3> set the *measResultNeighCells* to include the best neighbouring cells up to *maxReportCells* in accordance with the following:
- ...

4> else:

5> include the applicable cells for which the new measurement results became available since the last periodical reporting or since the measurement was initiated or reset;

4> for each cell that is included in the *measResultNeighCells*, include the *physCellId*;

4> if the *reportType* is set to *eventTriggered* or *periodical*:

5> for each included cell, include the layer 3 filtered measured results in accordance with the *reportConfig* for this *measId*, ordered as follows:

6> if the *measObject* associated with this *measId* concerns NR:

7> if *rsType* in the associated *reportConfig* is set to *ssb*:

8> set *resultsSSB-Cell* within the *measResult* to include the SS/PBCH block based quantity(ies) indicated in the *reportQuantityCell* within the concerned *reportConfig*, in decreasing order of the sorting quantity, determined as specified in 5.5.5.3, i.e. the best cell is included first;

...

1> increment the *numberOfReportsSent* as defined within the *VarMeasReportList* for this *measId* by 1;

1> stop the periodical reporting timer, if running;

1> if the *numberOfReportsSent* as defined within the *VarMeasReportList* for this *measId* is less than the *reportAmount* as defined within the corresponding *reportConfig* for this *measId*:

2> start the periodical reporting timer with the value of *reportInterval* as defined within the corresponding *reportConfig* for this *measId*;

1> else:

2> if the *reportType* is set to *periodical*:

3> remove the entry within the *VarMeasReportList* for this *measId*;

3> remove this *measId* from the *measIdList* within *VarMeasConfig*;

...

1> else:

2> submit the *MeasurementReport* message to lower layers for transmission, upon which the procedure ends.

8.1.3.1.20.3 Test description

8.1.3.1.20.3.1 Pre-test conditions

System Simulator:

- NR Cell 1 is the serving cell, NR Cell 3 is the inter-frequency neighbour cell of NR Cell 1.
- System information combination NR-4 as defined in TS 38.508-1 [4] clause 4.4.3.1.2 is used in NR cells.

UE:

- None.

Preamble:

- The UE is in state 3N-A as defined in TS 38.508-1 [4], subclause 4.4A.

8.1.3.1.20.3.2 Test procedure sequence

Table 8.1.3.1.20.3.2-1/2 illustrates the downlink power levels to be applied for NR Cell 1 and NR Cell 3 at various time instants of the test execution. Row marked "T1" are applied at the point indicated in the Main behaviour description in Table 8.1.3.1.20.3.2-3.

Table 8.1.3.1.20.3.2-1: Time instances of cell power level and parameter changes in FR1

	Parameter	Unit	NR Cell 1	NR Cell3	Remark
T1	SS/PBCH SSS EPRE	dBm/ SCS	-85	-79	

Table 8.1.3.1.20.3.2-2: Time instances of cell power level and parameter changes in FR2

	Parameter	Unit	NR Cell 1	NR Cell3	Remark
T1	SS/PBCH SSS EPRE	dBm/ SCS	FFS	FFS	

Table 8.1.3.1.20.3.2-3: Main behaviour

St	Procedure	Message Sequence		TP	Verdict
		U - S	Message		
0	SS re-adjusts the cell-specific reference signal level according to row "T1" in table 8.1.3.1.20.3.2.	-	-	-	-
1	The SS transmits an <i>RRCReconfiguration</i> message to setup FR1 independent gap (pattern #0) and inter-frequency measurement on NR Cell 3.	<--	NR RRC: <i>RRCReconfiguration</i>	-	-
2	The UE transmits an <i>RRCReconfigurationComplete</i> message.	-->	NR RRC: <i>RRCReconfigurationComplete</i>	-	-
3	Check: Does the UE transmit at least 10 <i>MeasurementReport</i> messages to periodically report the measured RSRP value for NR Cell 3 within the next 30 seconds?	-->	NR RRC: <i>MeasurementReport</i>	1	P
3A	The SS waits and ignores <i>MeasurementReport</i> messages for 3s to allow UE to measure NR Cell 3	-	-	-	-
4	The SS transmits an <i>RRCConnectionReconfiguration</i> to change gap pattern to pattern #1.	<--	NR RRC: <i>RRCReconfiguration</i>	-	-
5	The UE transmits an <i>RRCConnectionReconfigurationComplete</i> message to confirm the change of pattern.	-->	NR RRC: <i>RRCReconfigurationComplete</i>	-	-
6	Check: Does the UE transmit at least 10 <i>MeasurementReport</i> messages to periodically report the measured RSRP value for NR Cell 3 within the next 30 seconds?	-->	NR RRC: <i>MeasurementReport</i>	1	P
-	EXCEPTION: Steps 7 to 9 shall be repeated for each gap pattern among #2 - #11 and supported by UE (indicated in <i>supportedGapPattern</i>).				
7	The SS transmits an <i>RRCConnectionReconfiguration</i> to change gap pattern to the next pattern supported by UE.	<--	NR RRC: <i>RRCReconfiguration</i>	-	-
8	The UE transmits an <i>RRCReconfigurationComplete</i> message to confirm the change of gap pattern.	-->	NR RRC: <i>RRCReconfigurationComplete</i>	-	-
9	Check: Does the UE transmit at least 10 <i>MeasurementReport</i> messages to periodically report the measured RSRP value for NR Cell 3 within the next 30 seconds?	-->	NR RRC: <i>MeasurementReport</i>	1	P

8.1.3.1.20.3.3 Specific message contents

Table 8.1.3.1.20.3.3-1: RRCReconfiguration (step 1, 4 and 7, Table 8.1.3.1.20.3.2-2)

Derivation Path: 38.508-1 [4] Table 4.6.1-13 with condition NR_MEAS

Table 8.1.3.1.20.3.3-2: MeasConfig (Table 8.1.3.1.20.3.3-1)

Derivation Path: 38.508-1 [4] Table 4.6.3-69			
Information Element	Value/remark	Comment	Condition
MeasConfig ::= SEQUENCE {			
measObjectToAddModList	Not present		Step 4 OR Step 7
measObjectToAddModList SEQUENCE (SIZE (1..maxNrofMeasId)) OF MeasObjectToAddMod {	2 entries		Step 1
MeasObjectToAddMod[1] SEQUENCE {		entry 1	
measObjectId	1		
measObject CHOICE {			
measObjectNR	MeasObjectNR-f1	Table 8.1.3.1.20.3.3-3	
}			
}			
MeasObjectToAddMod[2] SEQUENCE {		entry 2	
measObjectId	2		
measObject CHOICE {			
measObjectNR	MeasObjectNR-f2	Table 8.1.3.1.20.3.3-4	
}			
}			
reportConfigToAddModList	Not present		Step 4 OR Step 7
reportConfigToAddModList SEQUENCE(SIZE (1..maxReportConfigId)) OF ReportConfigToAddMod {	1 entry		Step 1
ReportConfigToAddMod[1] SEQUENCE {		entry 1	
reportConfigId	1		
reportConfig CHOICE {			
reportConfigNR	ReportConfigNR with condition PERIODICAL		
}			
}			
measIdToAddModList	Not present		Step 4 OR Step 7
measIdToAddModList SEQUENCE (SIZE (1..maxNrofMeasId)) OF MeasIdToAddMod {	1 entry		Step 1
MeasIdToAddMod[1] SEQUENCE {		entry 1	
measId	1		
measObjectId	2		
reportConfigId	1		
}			
measGapConfig	MeasGapConfig-gapFR1	Table 8.1.3.1.20.3.3-5	
}			

Table 8.1.3.1.20.3.3-3: MeasObjectNR-f1 (Table 8.1.3.1.20.3.3-2)

Derivation Path: TS 38.508-1 [4], Table 4.6.3-76			
Information Element	Value/remark	Comment	Condition
MeasObjectNR ::= SEQUENCE {			
ssbFrequency	ARFCN-ValueNR for SSB of NR Cell 1		
smtc1 SEQUENCE {			
periodicityAndOffset CHOICE {			
sf20	0	To make sure SMTC for intra-frequency measurement is non-overlapping with MG	
}			
}			
absThreshSS-BlocksConsolidation	Not present		
nrofSS-BlocksToAverage	Not present		
}			

Table 8.1.3.1.20.3.3-4: MeasObjectNR-f2 (Table 8.1.3.1.20.3.3-2)

Derivation Path: TS 38.08-1 [4], Table 4.6.3-76			
Information Element	Value/remark	Comment	Condition
MeasObjectNR ::= SEQUENCE {			
ssbFrequency	ARFCN-ValueNR for SSB of NR Cell 3		
smtc1 SEQUENCE {			
periodicityAndOffset CHOICE {			
sf20	10		
}			
}			
absThreshSS-BlocksConsolidation	Not present		
nrofSS-BlocksToAverage	Not present		
}			

Table 8.1.3.1.20.3.3-5: MeasGapConfig-gapFR1 (Table 8.1.3.1.20.3.3-2)

Derivation Path: TS 38.508-1 [4], Table 4.6.3-70 with condition GAP_FR1			
Information Element	Value/remark	Comment	Condition
MeasGapConfig ::= SEQUENCE {			
gapFR1 CHOICE {	Not present		
setup SEQUENCE {			
gapOffset	9		
mgl	ms3	Pattern #2, #3, #10 or #11	
	ms4	Pattern #6, #7, #8 or #9	
	ms6	Pattern #0, #1, #4 or #5	
mgrp	ms20	Pattern #4, #6 or #10	
	ms40	Pattern #0, #2 or #7	
	ms80	Pattern #1, #3 or #8	
	ms160	Pattern #5, #9 or #11	
mgta	ms0		
}			
}			
}			

Table 8.1.3.1.20.3.3-6: *MeasurementReport* (step 1, Table 8.1.3.1.20.3.2-3)

Derivation Path: 38.508-1 [4] Table 4.6.1-5A			
Information Element	Value/remark	Comment	Condition
MeasurementReport ::= SEQUENCE {			
criticalExtensions CHOICE {			
measurementReport SEQUENCE {			
measResults SEQUENCE {			
measId	1		
measResultServingMOList SEQUENCE (SIZE (1..maxNrofServingCells)) OF MeasResultServMO {	1 entry	Measurement report for NR Cell 1	
MeasResultServMO[1] SEQUENCE {		entry 1	
servCellId	ServCellIndex of NR Cell 1		
measResultServingCell SEQUENCE {			
physCellId	PCI of NR Cell 1		
measResult SEQUENCE {			
cellResults SEQUENCE {			
resultsSSB-Cell SEQUENCE {			
rsrp	(0..127)		
rsrq	(0..127)		
sinr	(0..127)		pc_ss_SINR_Meas
Not present	Not present		
}			
}			
}			
}			
}			
measResultNeighCells CHOICE {			
measResultListNR SEQUENCE (SIZE (1..maxCellReport)) OF MeasResultNR {	1 entry	Measurement report for NR Cell 3	
MeasResultNR[1] SEQUENCE {		entry 1	
physCellId	Physical layer cell identity of NR Cell 3		
measResult SEQUENCE {			
cellResults SEQUENCE {			
resultsSSB-Cell SEQUENCE {			
rsrp	(0..127)		
rsrq	(0..127)		
}			
resultsCSI-RS-Cell	Not present		
}			
rsIndexResults	Not present		
}			
cgi-Info	Not present		
}			
}			
}			
}			
}			
}			
}			
}			

8.1.3.1.21 Measurement configuration control and reporting / Measurement Gaps / gapFR2

8.1.3.1.21.1 Test Purpose (TP)

(1)

```
with { UE in NR RRC_CONNECTED state }
ensure that {
```

```

when { UE receives RRCReconfiguration message containing MeasConfig to setup gapFR2 and report
periodical measurements for neighbor cell on FR2 frequency }
  then { UE applies gapFR2 and sends periodical measurements for neighbor cell on FR2 frequency }
}

```

8.1.3.1.21.2 Conformance requirements

References: The conformance requirements covered in the current TC are specified in: TS 38.331, clauses 5.3.5.3, 5.5.2.1, 5.5.2.9, 5.5.4.1, 5.5.4.5 and 5.5.5.1. Unless otherwise stated these are Rel-15 requirements.

[TS 38.331, clause 5.3.5.3]

The UE shall perform the following actions upon reception of the *RRCReconfiguration*:

...

1> if the *RRCReconfiguration* message includes the *measConfig*:

2> perform the measurement configuration procedure as specified in 5.5.2;

...

1> else:

2> submit the *RRCReconfigurationComplete* message via SRB1 to lower layers for transmission using the new configuration;

...

[TS 38.331, clause 5.5.2.1]

...

The UE shall:

...

1> if the received *measConfig* includes the *measObjectToAddModList*:

2> perform the measurement object addition/modification procedure as specified in 5.5.2.5;

...

1> if the received *measConfig* includes the *reportConfigToAddModList*:

2> perform the reporting configuration addition/modification procedure as specified in 5.5.2.7;

...

1> if the received *measConfig* includes the *measIdToAddModList*:

2> perform the measurement identity addition/modification procedure as specified in 5.5.2.3;

...

1> if the received *measConfig* includes the *measGapConfig*:

2> perform the measurement gap configuration procedure as specified in 5.5.2.9;

...

[TS 38.331, clause 5.5.2.9]

The UE shall:

...

1> if *gapFR2* is set to *setup*:

- 2> if an FR2 measurement gap configuration is already setup, release the FR2 measurement gap configuration;
- 2> setup the FR2 measurement gap configuration indicated by the *measGapConfig* in accordance with the received *gapOffset*, i.e., the first subframe of each gap occurs at an SFN and subframe meeting the following condition:
 - SFN mod $T = \text{FLOOR}(\text{gapOffset}/10)$;
 - subframe = $\text{gapOffset} \bmod 10$;
 - with $T = \text{MGRP}/10$ as defined in TS 38.133 [14];
- 2> if *mgta* is configured, apply the specified timing advance to the gap occurrences calculated above (i.e. the UE starts the measurement *mgta* ms before the gap subframe occurrences);

...

[TS 38.331, clause 5.5.4.1]

If AS security has been activated successfully, the UE shall:

- 1> for each *measId* included in the *measIdList* within *VarMeasConfig*:
 - 2> if the corresponding *reportConfig* includes a *reportType* set to *eventTriggered* or *periodical*:
 - 3> if the corresponding *measObject* concerns NR:
 - ...
 - 4> for measurement events other than *eventA1* or *eventA2*:
 - 5> else:
 - 6> consider any neighbouring cell detected based on parameters in the associated *measObjectNR* to be applicable when the concerned cell is not included in the *blackCellsToAddModList* defined within the *VarMeasConfig* for this *measId*;
 - ...
 - 2> if *reportType* is set to *periodical* and if a (first) measurement result is available:
 - 3> include a measurement reporting entry within the *VarMeasReportList* for this *measId*;
 - 3> set the *numberOfReportsSent* defined within the *VarMeasReportList* for this *measId* to 0;
 - 3> if the *reportAmount* exceeds 1:
 - 4> initiate the measurement reporting procedure, as specified in 5.5.5, immediately after the quantity to be reported becomes available for the NR SpCell;
 - 3> else (i.e. the *reportAmount* is equal to 1):
 - 4> initiate the measurement reporting procedure, as specified in 5.5.5, immediately after the quantity to be reported becomes available for the NR SpCell and for the strongest cell among the applicable cells;
 - 2> upon expiry of the periodical reporting timer for this *measId*:
 - 3> initiate the measurement reporting procedure, as specified in 5.5.5.

...

[TS 38.331, clause 5.5.5.1]



Figure 5.5.5.1-1: Measurement reporting

The purpose of this procedure is to transfer measurement results from the UE to the network. The UE shall initiate this procedure only after successful AS security activation.

For the *measId* for which the measurement reporting procedure was triggered, the UE shall set the *measResults* within the *MeasurementReport* message as follows:

- 1> set the *measId* to the measurement identity that triggered the measurement reporting;
- 1> set the *measResultServingCell* within *measResultServingMOList* to include, for each NR serving cell that is configured with *servingCellMO*, RSRP, RSRQ and the available SINR, derived based on the *rsType* if indicated in the associated *reportConfig*, otherwise based on SSB if available, otherwise based on CSI-RS;
- 1> set the *servCellId* within *measResultServingMOList* to include each NR serving cell that is configured with *servingCellMO*, if any;
- ...
- 1> if there is at least one applicable neighbouring cell to report:
 - 2> if the *reportType* is set to *eventTriggered* or *periodical*:
 - 3> set the *measResultNeighCells* to include the best neighbouring cells up to *maxReportCells* in accordance with the following:
 - ...
 - 4> else:
 - 5> include the applicable cells for which the new measurement results became available since the last periodical reporting or since the measurement was initiated or reset;
 - 4> for each cell that is included in the *measResultNeighCells*, include the *physCellId*;
 - 4> if the *reportType* is set to *eventTriggered* or *periodical*:
 - 5> for each included cell, include the layer 3 filtered measured results in accordance with the *reportConfig* for this *measId*, ordered as follows:
 - 6> if the *measObject* associated with this *measId* concerns NR:
 - 7> if *rsType* in the associated *reportConfig* is set to *ssb*:
 - 8> set *resultsSSB-Cell* within the *measResult* to include the SS/PBCH block based quantity(ies) indicated in the *reportQuantityCell* within the concerned *reportConfig*, in decreasing order of the sorting quantity, determined as specified in 5.5.5.3, i.e. the best cell is included first;
 - ...
 - 1> increment the *numberOfReportsSent* as defined within the *VarMeasReportList* for this *measId* by 1;
 - 1> stop the periodical reporting timer, if running;
 - 1> if the *numberOfReportsSent* as defined within the *VarMeasReportList* for this *measId* is less than the *reportAmount* as defined within the corresponding *reportConfig* for this *measId*:

2> start the periodical reporting timer with the value of *reportInterval* as defined within the corresponding *reportConfig* for this *measId*;

1> else:

2> if the *reportType* is set to *periodical*:

3> remove the entry within the *VarMeasReportList* for this *measId*;

3> remove this *measId* from the *measIdList* within *VarMeasConfig*;

...

1> else:

2> submit the *MeasurementReport* message to lower layers for transmission, upon which the procedure ends.

8.1.3.1.21.3 Test description

8.1.3.1.21.3.1 Pre-test conditions

System Simulator:

- NR Cell 1 is the serving cell, NR Cell 3 is the inter-frequency neighbour cell of NR Cell 1.
- System information combination NR-4 as defined in TS 38.508-1 [4] clause 4.4.3.1.2 is used in NR cells.

UE:

- None.

Preamble:

- The UE is in state 3N-A as defined in TS 38.508-1 [4], subclause 4.4A.

8.1.3.1.21.3.2 Test procedure sequence

Table 8.1.3.1.21.3.2-1: Main behaviour

St	Procedure	Message Sequence		TP	Verdict
		U - S	Message		
1	The SS transmits an <i>RRCReconfiguration</i> message to setup FR2 independent gap (pattern #13) and inter-frequency measurement on NR Cell 3.	<->	NR RRC: <i>RRCReconfiguration</i>	-	-
2	The UE transmits an <i>RRCReconfigurationComplete</i> message.	-->	NR RRC: <i>RRCReconfigurationComplete</i>	-	-
3	Check: Does the UE transmit at least 3 <i>MeasurementReport</i> messages to periodically report the measured RSRP value for NR Cell 3 within the next 30 seconds?	-->	NR RRC: <i>MeasurementReport</i>	1	P
4	The SS transmits an <i>RRCConnectionReconfiguration</i> to change gap pattern to pattern #14.	<->	NR RRC: <i>RRCReconfiguration</i>	-	-
5	The UE transmits an <i>RRCConnectionReconfigurationComplete</i> message to confirm the change of pattern.	-->	NR RRC: <i>RRCReconfigurationComplete</i>	-	-
6	Check: Does the UE transmit at least 3 <i>MeasurementReport</i> messages to periodically report the measured RSRP value for NR Cell 3 within the next 30 seconds?	-->	NR RRC: <i>MeasurementReport</i>	1	P
-	EXCEPTION: Steps 7 to 9 shall be repeated for each gap pattern among #12 and #15 - #23 and supported by UE (indicated in <i>supportedGapPattern</i>).				
7	The SS transmits an <i>RRCConnectionReconfiguration</i> to change gap pattern to the next pattern supported by UE.	<->	NR RRC: <i>RRCReconfiguration</i>	-	-
8	The UE transmits an <i>RRCReconfigurationComplete</i> message to confirm the change of gap pattern.	-->	NR RRC: <i>RRCReconfigurationComplete</i>	-	-
9	Check: Does the UE transmit at least 3 <i>MeasurementReport</i> messages to periodically report the measured RSRP value for NR Cell 3 within the next 30 seconds?	-->	NR RRC: <i>MeasurementReport</i>	1	P

8.1.3.1.21.3.3 Specific message contents

Table 8.1.3.1.21.3.3-1: *RRCReconfiguration* (step 1, 4 and 7, Table 8.1.3.1.21.3.2-2)

Derivation Path: 38.508-1 [4] Table 4.6.1-13 with condition NR_MEAS

Table 8.1.3.1.21.3.3-2: *MeasConfig* (Table 8.1.3.1.21.3.3-1)

Derivation Path: 38.508-1 [4] Table 4.6.3-69			
Information Element	Value/remark	Comment	Condition
MeasConfig ::= SEQUENCE {			
measObjectToAddModList	Not present		Step 4 OR Step 7
measObjectToAddModList SEQUENCE (SIZE (1..maxNrofMeasId)) OF MeasObjectToAddMod {	2 entries		Step 1
MeasObjectToAddMod[1] SEQUENCE {		entry 1	
measObjectId	1		
measObject CHOICE {			
measObjectNR	MeasObjectNR-f1	Table 8.1.3.1.21.3.3-3	
}			
}			
MeasObjectToAddMod[2] SEQUENCE {		entry 2	
measObjectId	2		
measObject CHOICE {			
measObjectNR	MeasObjectNR-f2	Table 8.1.3.1.21.3.3-4	
}			
}			
}			
reportConfigToAddModList	Not present		Step 4 OR Step 7
reportConfigToAddModList SEQUENCE(SIZE (1..maxReportConfigId)) OF ReportConfigToAddMod {	1 entry		Step 1
ReportConfigToAddMod[1] SEQUENCE {		entry 1	
reportConfigId	1		
reportConfig CHOICE {			
reportConfigNR	ReportConfigNR with condition PERIODICAL		
}			
}			
}			
measIdToAddModList SEQUENCE (SIZE	Not present		Step 4 OR Step 7
measIdToAddModList SEQUENCE (SIZE (1..maxNrofMeasId)) OF MeasIdToAddMod {	1 entry		Step 1
MeasIdToAddMod[1] SEQUENCE {		entry 1	
measId	1		
measObjectId	2		
reportConfigId	1		
}			
}			
measGapConfig	MeasGapConfig-gapFR2	Table 8.1.3.1.21.3.3-5	
}			

Table 8.1.3.1.21.3.3-3: MeasObjectNR-f1 (Table 8.1.3.1.21.3.3-2)

Derivation Path: TS 38.508-1 [4], Table 4.6.3-76			
Information Element	Value/remark	Comment	Condition
MeasObjectNR ::= SEQUENCE {			
ssbFrequency	ARFCN-ValueNR for SSB of NR Cell 1		
smc1 SEQUENCE {			
periodicityAndOffset CHOICE {			
sf20	10	To make sure SMTC for intra-frequency measurement is non-overlapping with MG	
}			
}			
absThreshSS-BlocksConsolidation	Not present		
nrofSS-BlocksToAverage	Not present		
}			

Table 8.1.3.1.21.3.3-4: MeasObjectNR-f2 (Table 8.1.3.1.21.3.3-2)

Derivation Path: TS 38.508-1 [4], Table 4.6.3-76			
Information Element	Value/remark	Comment	Condition
MeasObjectNR ::= SEQUENCE {			
ssbFrequency	ARFCN-ValueNR for SSB of NR Cell 3		
smc1 SEQUENCE {			
periodicityAndOffset CHOICE {			
sf20	0		
}			
}			
absThreshSS-BlocksConsolidation	Not present		
nrofSS-BlocksToAverage	Not present		
}			

Table 8.1.3.1.21.3.3-5: MeasGapConfig-gapFR2 (Table 8.1.3.1.21.3.3-2)

Derivation Path: TS 38.508-1 [4], Table 4.6.3-70 with Condition GAP_FR2			
Information Element	Value/remark	Comment	Condition
MeasGapConfig ::= SEQUENCE {			
gapFR2 CHOICE {			
setup SEQUENCE {			
gapOffset	0		
mgl	ms1dot5	Pattern #20, #21, #22 or #23	
	ms3dot5	Pattern #16, #17, #18 or #19	
	ms5dot5	Pattern #12, #13, #14 or #15	
mgrp	ms20	Pattern #12, #16 or #20	
	ms40	Pattern #13, #17 or #21	
	ms80	Pattern #14, #18 or #22	
	ms160	Pattern #15, #19 or #23	
mgta	ms0		
}			
}			
}			

8.1.3.1.22

8.1.3.1.23 Measurement configuration control and reporting / Intra NR measurements / Continuation of the measurements after RRC Resume

8.1.3.1.23.1 Test Purpose (TP)

(1)

```

with { UE in NR RRC_CONNECTED state }
ensure that {
  when { UE receives RRCReconfiguration including measConfig to setup periodical measurement reporting }
  then { UE sends RRCReconfigurationComplete and starts sending periodic measurement reports }
}

```

(2)

```

with { UE in NR RRC_INACTIVE state and measurement configured for periodical reporting }
ensure that {
  when { UE receives RRCResume message without including measconfig }
  then { UE resumes RRC connection and performs periodic measurements as per the measurement configuration }
}

```

(3)

```

with { UE in NR RRC_INACTIVE state and measurement configured for periodical reporting }
ensure that {
  when { UE receives RRCResume message including the measconfig }
  then { UE resumes RRC connection and performs periodic measurements as per the received measconfig in RRCResume message }
}

```

8.1.3.1.23.2 Conformance requirements

References: The conformance requirements covered in the present TC are specified in: TS 38.331, clause 5.3.13.4, 5.5.2 and 5.5.4.1.

[TS 38.331, clause 5.3.13.4]

The UE shall:

...

1> release the *suspendConfig* except the *ran-NotificationAreaInfo*;

...

1> resume SRB2 and all DRBs;

...

1> if the *RRCResume* message includes the *measConfig*:

2> perform the measurement configuration procedure as specified in 5.5.2;

1> resume measurements if suspended;

...

1> enter RRC_CONNECTED;

1> indicate to upper layers that the suspended RRC connection has been resumed;

...

1> consider the current cell to be the PCell;

...

1> submit the *RRCResumeComplete* message to lower layers for transmission;

1> the procedure ends.

[TS 38.331, clause 5.3.13.4]

The UE shall:

...

1> if the received *measConfig* includes the *measObjectToAddModList*:

2> perform the measurement object addition/modification procedure as specified in 5.5.2.5;

...

1> if the received *measConfig* includes the *reportConfigToAddModList*:

2> perform the reporting configuration addition/modification procedure as specified in 5.5.2.7;

1> if the received *measConfig* includes the *quantityConfig*:

2> perform the quantity configuration procedure as specified in 5.5.2.8;

1> if the received *measConfig* includes the *measIdToRemoveList*:

2> perform the measurement identity removal procedure as specified in 5.5.2.2;

1> if the received *measConfig* includes the *measIdToAddModList*:

2> perform the measurement identity addition/modification procedure as specified in 5.5.2.3;

[TS 38.331, clause 5.5.4.1]

If AS security has been activated successfully, the UE shall:

1> for each *measId* included in the *measIdList* within *VarMeasConfig*:

2> if the corresponding *reportConfig* includes a *reportType* set to *eventTriggered* or *periodical*:

3> if the corresponding *measObject* concerns NR:

...

4> if corresponding *reportConfig* includes *reportType* set to *periodical*; or

4> for measurement events other than *eventA1* or *eventA2*:

5> if *useWhiteCellList* is set to *true*:

6> consider any neighbouring cell detected based on parameters in the associated *measObjectNR* to be applicable when the concerned cell is included in the *whiteCellsToAddModList* defined within the *VarMeasConfig* for this *measId*;

5> else:

6> consider any neighbouring cell detected based on parameters in the associated *measObjectNR* to be applicable when the concerned cell is not included in the *blackCellsToAddModList* defined within the *VarMeasConfig* for this *measId*;

...

2> if *reportType* is set to *periodical* and if a (first) measurement result is available:

- 3> include a measurement reporting entry within the *VarMeasReportList* for this *measId*;
- 3> set the *numberOfReportsSent* defined within the *VarMeasReportList* for this *measId* to 0;
- 3> if the *reportAmount* exceeds 1:
 - 4> initiate the measurement reporting procedure, as specified in 5.5.5, immediately after the quantity to be reported becomes available for the NR SpCell;
- 3> else (i.e. the *reportAmount* is equal to 1):
 - 4> initiate the measurement reporting procedure, as specified in 5.5.5, immediately after the quantity to be reported becomes available for the NR SpCell and for the strongest cell among the applicable cells;
- 2> upon expiry of the periodical reporting timer for this *measId*:
 - 3> initiate the measurement reporting procedure, as specified in 5.5.5.

8.1.3.1.23.3 Test description

8.1.3.1.23.3.1 Pre-test conditions

System Simulator:

- NR Cell 1 is the serving cell, NR Cell 2 is the intra-frequency neighbour cell of NR Cell 1.
- System information combination NR-2 as defined in TS 38.508-1 [4] clause 4.4.3.1.2 is used in NR cells.

UE:

- None.

Preamble:

- The UE is in state 3N-A in NR Cell 1 as defined in TS 38.508-1 [4], subclause 4.4A.

8.1.3.1.23.3.2 Test procedure sequence

Tables 8.1.3.1.23.3.2-1 and 8.1.3.1.23.3.2-2 illustrate the downlink power levels to be applied for NR Cell 1 and NR Cell 2 at various time instants of the test execution. Row marked "T0" denotes the conditions after the preamble.

Table 8.1.3.1.23.3.2-1: Power levels in FR1

	Parameter	Unit	NR Cell 1	NR Cell 2	Remark
T0	SS/PBCH SSS EPRE	dBm/ SCS	-85	-91	

Table 8.1.3.1.23.3.2-2: Power levels in FR2

	Parameter	Unit	NR Cell 1	NR Cell 2	Remark
T0	SS/PBCH SSS EPRE	dBm/ SCS	FFS	FFS	

Table 8.1.3.1.23.3.2-3: Main behaviour

St	Procedure	Message Sequence		TP	Verdict
		U - S	Message		
1	The SS transmits an <i>RRCReconfiguration</i> message including <i>MeasConfig</i> to setup intra NR periodic measurement reporting.	<--	NR RRC: <i>RRCReconfiguration</i>	-	-
2	The UE transmits an <i>RRCReconfigurationComplete</i> message.	-->	NR RRC: <i>RRCReconfigurationComplete</i>	-	-
2A	The SS waits and ignores <i>MeasurementReport</i> messages for 3s to allow UE to measure NR Cell 2.	-->	NR RRC: <i>MeasurementReport</i>	-	-
3	Check: Does the UE transmit at least 10 <i>MeasurementReport</i> messages within the next 30 seconds?	-->	NR RRC: <i>MeasurementReport</i>	1	P
4	The SS transmits an <i>RRCRelease</i> message with <i>suspendConfig</i> .	<--	NR RRC: <i>RRCRelease</i>	-	-
5	The SS waits for 5 sec and transmits a <i>Paging</i> message including a matched identity (correct full-I-RNTI).	-	NR RRC: <i>Paging</i>	-	-
6	UE transmits <i>RRCResumeRequest</i> message	-->	NR RRC: <i>RRCResumeRequest</i>	-	-
7	The SS transmits an <i>RRCResume</i> message without including <i>MeasConfig</i> .	<--	NR RRC: <i>RRCResume</i>	-	-
8	The UE transmits an <i>RRCResumeComplete</i> message.	-->	NR RRC: <i>RRCResumeComplete</i>	-	-
8A	The SS waits and ignores <i>MeasurementReport</i> messages for 3s to allow UE to measure NR Cell 2.	-->	NR RRC: <i>MeasurementReport</i>	-	-
9	Check: Does the UE transmit at least 10 <i>MeasurementReport</i> messages within the next 30 seconds?	-->	NR RRC: <i>MeasurementReport</i>	2	P
10	The SS transmits an <i>RRCRelease</i> message with <i>suspendConfig</i> .	<--	NR RRC: <i>RRCRelease</i>	-	-
11	The SS waits for 5 sec and transmits a <i>Paging</i> message including a matched identity (correct full-I-RNTI).	-	NR RRC: <i>Paging</i>	-	-
12	UE transmits <i>RRCResumeRequest</i> message	-->	NR RRC: <i>RRCResumeRequest</i>	-	-
13	The SS transmits an <i>RRCResume</i> message including <i>MeasConfig</i> .	<--	NR RRC: <i>RRCResume</i>	-	-
14	The UE transmits an <i>RRCResumeComplete</i> message.	-->	NR RRC: <i>RRCResumeComplete</i>	-	-
15	The SS waits and ignores <i>MeasurementReport</i> messages for 3s to allow UE to measure NR Cell 2.	-->	NR RRC: <i>MeasurementReport</i>	-	-
16	Check: Does the UE transmit at least 10 <i>MeasurementReport</i> messages within the next 30 seconds?	-->	NR RRC: <i>MeasurementReport</i>	3	P
17	The SS transmits an <i>RRCRelease</i> message	<--	NR RRC: <i>RRCRelease</i>	-	-

8.1.3.1.23.3.3 Specific message contents

Table 8.1.3.1.23.3.3-1: *RRCReconfiguration* (step 1, Table 8.1.3.1.23.3.2-3)

Derivation Path: 38.508-1 [4] Table 4.6.1-13 with condition NR_MEAS

Table 8.1.3.1.23.3.3-2: *MeasConfig* (Table 8.1.3.1.23.3.3-1)

Derivation Path: 38.508-1 [4] Table 4.6.3-69			
Information Element	Value/remark	Comment	Condition
MeasConfig ::= SEQUENCE {			
measObjectToAddModList SEQUENCE (SIZE (1..maxNrofMeasId)) OF MeasObjectToAddMod {	1 entry		
MeasObjectToAddMod[1] SEQUENCE {		entry 1	
measObjectId	1	MeasObjectIdNR-f1	
measObject CHOICE {			
measObjectNR SEQUENCE {			
ssbFrequency	ssbFrequency IE equals the ARFCN for NR Cell 2		
absThreshSS-BlocksConsolidation	Not present		
}			
}			
}			
reportConfigToAddModList SEQUENCE(SIZE (1..maxReportConfigId)) OF ReportConfigToAddMod {	1 entry		
ReportConfigToAddMod[1] SEQUENCE {		entry 1	
reportConfigId	1		
reportConfig CHOICE {			
reportConfigNR	ReportConfigNR with condition PERIODICAL		
}			
}			
}			
measIdToAddModList SEQUENCE (SIZE (1..maxNrofMeasId)) OF MeasIdToAddMod {	1 entry		
MeasIdToAddMod[1] SEQUENCE {		entry 1	
measId	1		
measObjectId	1		
reportConfigId	1		
}			
}			
}			

Table 8.1.3.1.23.3.3-3: MeasurementReport (step 3 and step 9, Table 8.1.3.1.23.3.2-3)

Derivation Path: 38.508-1 [4] Table 4.6.1-5A			
Information Element	Value/remark	Comment	Condition
MeasurementReport ::= SEQUENCE {			
criticalExtensions CHOICE {			
measurementReport SEQUENCE {			
measResults SEQUENCE {			
measId	1		
measResultServingMOList SEQUENCE (SIZE (1..maxNrofServingCells)) OF MeasResultServMO {	1 entry		
MeasResultServMO[1] SEQUENCE {		entry 1	
servCellId	Cell index corresponding to NR Cell 1		
measResultServingCell SEQUENCE {			
physCellId	Physical layer cell identity of NR Cell 1		
}			
}			
}			
measResultNeighCells CHOICE {			
measResultListNR SEQUENCE (SIZE (1..maxCellReport)) OF MeasResultNR {	1 entry		
MeasResultNR[1] SEQUENCE {		entry 1	
physCellId	Physical layer cell identity of NR Cell 2		
measResult	Not Checked		
}			
}			
}			
}			
}			
}			

Table 8.1.3.1.23.3.3-4: RRCRelease (step 4 and step 10, Table 8.1.3.1.23.3.2-3)

Derivation Path: 38.508-1 [4] Table 4.6.1-16 with condition NR_RRC_INACTIVE

Table 8.1.3.1.23.3.3-5: Paging (step 5 and step 11, Table 8.1.3.1.23.3.2-3)

Derivation Path: 38.508-1 [4] Table 4.6.1-9 with condition NR_RRC_RESUME

Table 8.1.3.1.23.3.3-6: RRCResumeRequest (step 6 and step 12, Table 8.1.3.1.23.3.2-3)

Derivation Path: TS 38.331 [6], clause 6.2.2			
Information Element	Value/remark	Comment	Condition
RRCResumeRequest ::= SEQUENCE {			
rrcResumeRequest SEQUENCE {			
resumeCause	mt-Access		
}			
}			

Table 8.1.3.1.23.3.3-7: *RRCResume* (step 13, Table 8.1.3.1.23.3.2-3)

Derivation Path: TS 38.331 [6], clause 6.2.2			
Information Element	Value/remark	Comment	Condition
RRCResume ::= SEQUENCE {			
criticalExtensions CHOICE {			
rrcResume SEQUENCE {			
measConfig	MeasConfigResume		
}			
}			
}			

Table 8.1.3.1.23.3.3-8: MeasConfigResume (Table 8.1.3.1.23.3.3-7)

Derivation Path: 38.508-1 [4] Table 4.6.3-69			
Information Element	Value/remark	Comment	Condition
MeasConfig ::= SEQUENCE {			
measObjectToAddModList SEQUENCE (SIZE (1..maxNrofMeasId)) OF MeasObjectToAddMod {	1 entry		
MeasObjectToAddMod[1] SEQUENCE {		entry 1	
measObjectId	1	MeasObjectIdNR-f1	
measObject CHOICE {			
measObjectNR SEQUENCE {			
ssbFrequency	ssbFrequency IE equals the ARFCN for NR Cell 2		
absThreshSS-BlocksConsolidation	Not present		
}			
}			
}			
reportConfigToAddModList SEQUENCE (SIZE (1..maxReportConfigId)) OF ReportConfigToAddMod {	1 entry		
ReportConfigToAddMod[1] SEQUENCE {		entry 1	
reportConfigId	1		
reportConfig CHOICE {			
reportConfigNR	ReportConfigNR with condition PERIODICAL		
}			
}			
}			
measIdToRemoveList SEQUENCE (SIZE (1..maxNrofMeasId)) OF MeasId {	1 entry		
measId[1]	1		
}			
measIdToAddModList SEQUENCE (SIZE (1..maxNrofMeasId)) OF MeasIdToAddMod {	1 entry		
MeasIdToAddMod[1] SEQUENCE {		entry 1	
measId	2		
measObjectId	1		
reportConfigId	1		
}			
}			
}			

Table 8.1.3.1.23.3.3-9: MeasurementReport (step 16, Table 8.1.3.1.23.3.2-3)

Derivation Path: 38.508-1 [4] Table 4.6.1-5A			
Information Element	Value/remark	Comment	Condition
MeasurementReport ::= SEQUENCE {			
criticalExtensions CHOICE {			
measurementReport SEQUENCE {			
measResults SEQUENCE {			
measId	2		
measResultServingMOList SEQUENCE (SIZE (1..maxNrofServingCells)) OF MeasResultServMO {	1 entry		
MeasResultServMO[1] SEQUENCE {		entry 1	
servCellId	Cell index corresponding to NR Cell 1		
measResultServingCell SEQUENCE {			
physCellId	Physical layer cell identity of NR Cell 1		
}			
}			
}			
measResultNeighCells CHOICE {			
measResultListNR SEQUENCE (SIZE (1..maxCellReport)) OF MeasResultNR {	1 entry		
MeasResultNR[1] SEQUENCE {		entry 1	
physCellId	Physical layer cell identity of NR Cell 2		
measResult	Not Checked		
}			
}			
}			
}			
}			
}			

8.1.3.2 Inter-RAT measurements

8.1.3.2.1 Measurement configuration control and reporting / Inter-RAT measurements / Event B1 / Measurement of E-UTRA cells

8.1.3.2.1.1 Test Purpose (TP)

(1)

```
with { UE is NR RRC_CONNECTED state and inter-RAT measurement event B1 to measure neighbour E-UTRA cell is configured }
ensure that {
  when { Entering condition for the event B1 is not met }
  then { UE does not transmit any MeasurementReport }
}
```

(2)

```
with { UE is NR RRC_CONNECTED state and inter-RAT measurement event B1 to measure neighbour E-UTRA cell is configured }
ensure that {
  when { Entering condition for the event B1 is met }
  then { UE transmits a MeasurementReport }
}
```

8.1.3.2.1.2 Conformance requirements

References: The conformance requirements covered in the current TC are specified in: TS 38.331, clauses 5.3.5.3, 5.5.2, 5.5.4.1, 5.5.4.8 and 5.5.5. Unless otherwise stated these are Rel-15 requirements.

[TS 38.331, clause 5.3.5.3]

The UE shall perform the following actions upon reception of the *RRCReconfiguration*:

...

1> if the *RRCReconfiguration* message includes the *measConfig*:

2> perform the measurement configuration procedure as specified in 5.5.2;

...

1> if the UE is configured with E-UTRA *nr-SecondaryCellGroupConfig* (MCG is E-UTRA):

2> if *RRCReconfiguration* was received via SRB1:

3> submit the *RRCReconfigurationComplete* via the EUTRA MCG embedded in E-UTRA RRC message *RRCConnectionReconfigurationComplete* as specified in TS 36.331 [10];

3> if *reconfigurationWithSync* was included in *spCellConfig* of an SCG:

4> initiate the random access procedure on the SpCell, as specified in TS 38.321 [3];

3> else:

4> the procedure ends;

NOTE: The order the UE sends the *RRCConnectionReconfigurationComplete* message and performs the Random Access procedure towards the SCG is left to UE implementation.

2> else (*RRCReconfiguration* was received via SRB3):

3> submit the *RRCReconfigurationComplete* message via SRB3 to lower layers for transmission using the new configuration;

NOTE: For EN-DC, in the case *RRCReconfiguration* is received via SRB1, the random access is triggered by RRC layer itself as there is not necessarily other UL transmission. In the case *RRCReconfiguration* is received via SRB3, the random access is triggered by the MAC layer due to arrival of *RRCReconfigurationComplete*.

1> else:

2> submit the *RRCReconfigurationComplete* message via SRB1 to lower layers for transmission using the new configuration;

2> if this is the first *RRCReconfiguration* message after successful completion of the RRC re-establishment procedure;

3> resume SRB1 and DRBs that are suspended;

...

[TS 38.331, clause 5.5.2.1]

...

The UE shall:

...

1> if the received *measConfig* includes the *measObjectToAddModList*:

2> perform the measurement object addition/modification procedure as specified in 5.5.2.5;

...

1> if the received *measConfig* includes the *reportConfigToAddModList*:

2> perform the reporting configuration addition/modification procedure as specified in 5.5.2.7;

...

1> if the received *measConfig* includes the *measIdToAddModList*:

2> perform the measurement identity addition/modification procedure as specified in 5.5.2.3;

1> if the received *measConfig* includes the *measGapConfig*:

2> perform the measurement gap configuration procedure as specified in 5.5.2.9;

...

[TS 38.331, clause 5.5.2.9]

The UE shall:

...

1> else if *gapUE* is set to release:

2> release the per UE measurement gap configuration.

NOTE 1: For *gapFR2* configuration, the SFN and subframe of a serving cell on FR2 frequency is used in the gap calculation

NOTE 2: For *gapFR1* or *gapUE* configuration, the SFN and subframe of the PCell is used in the gap calculation.

[TS 38.331, clause 5.5.4.1]

If security has been activated successfully, the UE shall:

1> for each *measId* included in the *measIdList* within *VarMeasConfig*:

2> if the corresponding *reportConfig* includes a *reportType* set to *eventTriggered* or *periodical*;

3> if the corresponding *measObject* concerns NR;

...

4> for measurement events other than *eventA1* or *eventA2*:

5> if *useWhiteCellList* is set to TRUE:

6> consider any neighbouring cell detected based on parameters in the associated *measObjectNR* to be applicable when the concerned cell is included in the *whiteCellsToAddModList* defined within the *VarMeasConfig* for this *measId*;

5> else:

6> consider any neighbouring cell detected based on parameters in the associated *measObjectNR* to be applicable when the concerned cell is not included in the *blackCellsToAddModList* defined within the *VarMeasConfig* for this *measId*;

3> else if the corresponding *measObject* concerns E-UTRA;

4> consider any neighbouring cell detected on the associated frequency to be applicable when the concerned cell is not included in the *blackCellsToAddModListEUTRAN* defined within the *VarMeasConfig* for this *measId*;

...

- 2> if the *reportType* is set to *eventTriggered* and if the entry condition applicable for this event, i.e. the event corresponding with the *eventId* of the corresponding *reportConfig* within *VarMeasConfig*, is fulfilled for one or more applicable cells for all measurements after layer 3 filtering taken during *timeToTrigger* defined for this event within the *VarMeasConfig*, while the *VarMeasReportList* does not include a measurement reporting entry for this *measId* (a first cell triggers the event):
 - 3> include a measurement reporting entry within the *VarMeasReportList* for this *measId*;
 - 3> set the *numberOfReportsSent* defined within the *VarMeasReportList* for this *measId* to 0;
 - 3> include the concerned cell(s) in the *cellsTriggeredList* defined within the *VarMeasReportList* for this *measId*;
 - 3> initiate the measurement reporting procedure, as specified in 5.5.5;
- 2> else if the *reportType* is set to *eventTriggered* and if the entry condition applicable for this event, i.e. the event corresponding with the *eventId* of the corresponding *reportConfig* within *VarMeasConfig*, is fulfilled for one or more applicable cells not included in the *cellsTriggeredList* for all measurements after layer 3 filtering taken during *timeToTrigger* defined for this event within the *VarMeasConfig* (a subsequent cell triggers the event):
 - 3> set the *numberOfReportsSent* defined within the *VarMeasReportList* for this *measId* to 0;
 - 3> include the concerned cell(s) in the *cellsTriggeredList* defined within the *VarMeasReportList* for this *measId*;
 - 3> initiate the measurement reporting procedure, as specified in 5.5.5;
- 2> else if the *reportType* is set to *eventTriggered* and if the leaving condition applicable for this event is fulfilled for one or more of the cells included in the *cellsTriggeredList* defined within the *VarMeasReportList* for this *measId* for all measurements after layer 3 filtering taken during *timeToTrigger* defined within the *VarMeasConfig* for this event:
 - 3> remove the concerned cell(s) in the *cellsTriggeredList* defined within the *VarMeasReportList* for this *measId*;
 - 3> if *reportOnLeave* is set to *TRUE* for the corresponding reporting configuration:
 - 4> initiate the measurement reporting procedure, as specified in 5.5.5;
 - 3> if the *cellsTriggeredList* defined within the *VarMeasReportList* for this *measId* is empty:
 - 4> remove the measurement reporting entry within the *VarMeasReportList* for this *measId*;
 - 4> stop the periodical reporting timer for this *measId*, if running;
- ...
- 2> upon the expiry of T321 for this *measId*:
 - 3> include a measurement reporting entry within the *VarMeasReportList* for this *measId*;
 - 3> set the *numberOfReportsSent* defined within the *VarMeasReportList* for this *measId* to 0;
 - 3> initiate the measurement reporting procedure, as specified in 5.5.5.

[TS 38.331, clause 5.5.4.8]

The UE shall:

- 1> consider the entering condition for this event to be satisfied when condition B1-1, as specified below, is fulfilled;
- 1> consider the leaving condition for this event to be satisfied when condition B1-2, as specified below, is fulfilled;

Inequality B1-1 (Entering condition)

$$Mn + Ofn + Ocn - Hys > Thresh$$

Inequality B1-2 (Leaving condition)

$$Mn + Ofn + Ocn + Hys < Thresh$$

The variables in the formula are defined as follows:

Mn is the measurement result of the inter-RAT neighbour cell, not taking into account any offsets.

Ofn is the measurement object specific offset of the frequency of the inter-RAT neighbour cell (i.e. *eutra-Q-OffsetRange* as defined within the *measObjectEUTRA* corresponding to the frequency of the neighbour inter-RAT cell).

Ocn is the cell specific offset of the inter-RAT neighbour cell (i.e. *cellIndividualOffset* as defined within the *measObjectEUTRA* corresponding to the neighbour inter-RAT cell), and set to zero if not configured for the neighbour cell.

Hys is the hysteresis parameter for this event (i.e. *hysteresis* as defined within *reportConfigInterRAT* for this event).

Thresh is the threshold parameter for this event (i.e. *b1-ThresholdEUTRA* as defined within *reportConfigInterRAT* for this event).

Mn is expressed in dBm or in dB, depending on the measurement quantity of the inter-RAT neighbour cell.

Ofn, Ocn, Hys are expressed in dB.

Thresh is expressed in the same unit as **Mn**.

[TS 38.331, clause 5.5.5]



Figure 5.5.5-1: Measurement reporting

The purpose of this procedure is to transfer measurement results from the UE to the network. The UE shall initiate this procedure only after successful security activation.

For the *measId* for which the measurement reporting procedure was triggered, the UE shall set the *measResults* within the *MeasurementReport* message as follows:

- 1> set the *measId* to the measurement identity that triggered the measurement reporting;
- 1> set the *measResultServingCell* within *measResultServingMOList* to include, for each NR serving cell that is configured with *servingCellMO*, RSRP, RSRQ and the available SINR, derived based on the *rsType* if indicated in the associated *reportConfig*, otherwise based on SSB if available, otherwise based on CSI-RS;
- 1> set the *measResultServingCell* within *measResultServingMOList* to include for each NR serving cell that is configured with *servingCellMO*, if any, the *servCellId*;
- 1> if the *reportConfig* associated with the *measId* that triggered the measurement reporting includes *reportQuantityRsIndexes* and *maxNrofRSIndexesToReport*:
 - 2> for each serving cell configured with *servingCellMO*, include beam measurement information according to the associated *reportConfig* as described in 5.5.5.2;
- ...
- 1> if there is at least one applicable neighbouring cell to report:

2> if the *reportType* is set to *eventTriggered* or *periodical*:

3> set the *measResultNeighCells* to include the best neighbouring cells up to *maxReportCells* in accordance with the following:

4> if the *reportType* is set to *eventTriggered*:

5> include the cells included in the *cellsTriggeredList* as defined within the *VarMeasReportList* for this *measId*;

...

4> for each cell that is included in the *measResultNeighCells*, include the *physCellId*;

4> if the *reportType* is set to *eventTriggered* or *periodical*:

5> for each included cell, include the layer 3 filtered measured results in accordance with the *reportConfig* for this *measId*, ordered as follows:

6> if the *measObject* associated with this *measId* concerns NR:

7> if *rsType* in the associated *reportConfig* is set to *ssb*:

8> set *resultsSSB-Cell* within the *measResult* to include the SS/PBCH block based quantity(ies) indicated in the *reportQuantityCell* within the concerned *reportConfig*, in decreasing order of the sorting quantity, determined as specified in 5.5.5.3, i.e. the best cell is included first:

9> if *reportQuantityRsIndexes* and *maxNrofRSIndexesToReport* are configured, include beam measurement information as described in 5.5.5.2;

...

6> if the *measObject* associated with this *measId* concerns E-UTRA:

7> set the *measResult* to include the quantity(ies) indicated in the *reportQuantity* within the concerned *reportConfigInterRAT* in decreasing order of the sorting quantity, determined as specified in 5.5.5.3, i.e. the best cell is included first;

...

1> increment the *numberOfReportsSent* as defined within the *VarMeasReportList* for this *measId* by 1;

1> stop the periodical reporting timer, if running;

...

1> if the UE is configured with EN-DC:

2> if SRB3 is configured:

3> submit the *MeasurementReport* message via SRB3 to lower layers for transmission, upon which the procedure ends;

2> else:

3> submit the *MeasurementReport* message via the EUTRA MCG embedded in E-UTRA RRC message *ULInformationTransferMRDC* as specified in TS 36.331 [10].

1> else:

2> submit the *MeasurementReport* message to lower layers for transmission, upon which the procedure ends.

8.1.3.2.1.3 Test description

8.1.3.2.1.3.1 Pre-test conditions

System Simulator:

- NR Cell 1 is the PCell, E-UTRA Cell 1 is the inter-RAT neighbour cell of NR Cell 1.
- System information combination NR-6 as defined in TS 38.508-1 [4] clause 4.4.3.1.2.

UE:

- None.

Preamble:

- The UE is in state 3N-A as defined in TS 38.508-1 [4], subclause 4.4A.

8.1.3.2.1.3.2 Test procedure sequence

Table 8.1.3.2.1.3.2-1 and 8.1.3.2.1.3.2-2 illustrates the downlink power levels to be applied for NR Cell 1, and E-UTRA Cell 1 at various time instants of the test execution. Row marked "T0" denotes the conditions after the preamble, while the configuration marked "T1" is applied at the point indicated in the Main behaviour description in Table 8.1.3.2.1.3.2-3.

Table 8.1.3.2.1.3.2-1: Time instances of cell power level and parameter changes for FR1

	Parameter	Unit	NR Cell 1	E-UTRA Cell 1	Remark
T0	SS/PBCH SSS EPRE	dBm/ SCS	-85	-	Power levels are such that entry condition for event B1 is not satisfied: $Mn + Ofn + Ocn + Hys < Thresh$
	Cell-specific RS EPRE	dBm/15 kHz		-93	
T1	SS/PBCH SSS EPRE	dBm/ SCS	-85	-	Power levels are such that entry condition for event B1 is satisfied: $Mn + Ofn + Ocn - Hys > Thresh$
	Cell-specific RS EPRE	dBm/15 kHz		-73	

Table 8.1.3.2.1.3.2-2: Time instances of cell power level and parameter changes for FR2

	Parameter	Unit	NR Cell 1	E-UTRA Cell 1	Remark
T0	SS/PBCH SSS EPRE	dBm/ SCS	FFS	-	Power levels are such that entry condition for event B1 is not satisfied: $Mn + Ofn + Ocn + Hys < Thresh$
	Cell-specific RS EPRE	dBm/15 kHz		FFS	
T1	SS/PBCH SSS EPRE	dBm/ SCS	FFS	-	Power levels are such that entry condition for event B1 is satisfied: $Mn + Ofn + Ocn - Hys > Thresh$
	Cell-specific RS EPRE	dBm/15 kHz		FFS	

Table 8.1.3.2.1.3.2-3: Main behaviour

St	Procedure	Message Sequence		TP	Verdict
		U - S	Message		
1	The SS transmits an <i>RRCReconfiguration</i> message including <i>MeasConfig</i> to setup inter-RAT measurement and reporting for event B1.	<--	NR RRC: <i>RRCReconfiguration</i>	-	-
2	The UE transmits an <i>RRCReconfigurationComplete</i> message.	-->	NR RRC: <i>RRCReconfigurationComplete</i>	-	-
3	Check: Does the UE transmit a <i>MeasurementReport</i> message within the next 10s?	-->	NR RRC: <i>MeasurementReport</i>	2	F
4	SS re-adjusts the cell-specific reference signal level according to row "T1" in table 8.1.3.2.1.3.2-1/2.	-	-	-	-
5	Check: Does the UE transmit a <i>MeasurementReport</i> message to report event B1 with the measured RSRP value for NR Cell 1?	-->	NR RRC: <i>MeasurementReport</i>	1	P

8.1.3.2.1.3.3 Specific message contents

Table 8.1.3.2.1.3.3-1: *RRCReconfiguration* (step 1, Table 8.1.3.2.1.3.2-3)

Derivation Path: 38.508-1 [4] Table 4.6.1-13with condition NR_MEAS
--

Table 8.1.3.2.1.3.3-2: *MeasConfig* (Table 8.1.3.2.1.3.3-1)

Derivation Path: 38.508-1 [4] Table 4.6.3-69			
Information Element	Value/remark	Comment	Condition
MeasConfig ::= SEQUENCE {			
measObjectToAddModList SEQUENCE (SIZE (1..maxNrofMeasId)) OF MeasObjectToAddMod {	2 entries		
MeasObjectToAddMod[1] SEQUENCE {		entry 1	
measObjectId	1	MeasObjectIdNR-f1	
measObject CHOICE {			
measObjectNR SEQUENCE {			
ssbFrequency	ssbFrequency IE equals the ARFCN for NR Cell 1		
absThreshSS-BlocksConsolidation	Not present		
}			
}			
}			
MeasObjectToAddMod[2] SEQUENCE {		entry 2	
measObjectId	2	MeasObjectIdE-UTRA-f1	
measObject CHOICE {			
measObjectEUTRA SEQUENCE {			
carrierFreq	ARFCN-ValueEUTRA for E-UTRA Cell 1		
}			
}			
}			
reportConfigToAddModList SEQUENCE(SIZE (1..maxReportConfigId)) OF ReportConfigToAddMod {	1 entry		
ReportConfigToAddMod[1] SEQUENCE {		entry 1	
reportConfigId	1		
reportConfig CHOICE {			
reportConfigInterRAT	ReportConfigInterRAT-EventB1	Table 8.1.3.2.1.3.3-3	
}			
}			
}			
measIdToAddModList SEQUENCE (SIZE (1..maxNrofMeasId)) OF MeasIdToAddMod {	1 entry		
MeasIdToAddMod[1] SEQUENCE {		entry 1	
measId	1		
measObjectId	2		
reportConfigId	1		
}			
}			
quantityConfig	QuantityConfig with condition INTER-RAT		
measGapConfig	MeasGapConfig		
}			

Table 8.1.3.2.1.3.3-3: ReportConfigInterRAT-EventB1 (Table 8.1.3.2.1.3.3-2)

Derivation Path: 38.508-1 [4] Table 4.6.3-141 with condition EVENT_B1			
Information Element	Value/remark	Comment	Condition
ReportConfigNR ::= SEQUENCE {			
reportType CHOICE {			
eventTriggered SEQUENCE {			
eventId CHOICE {			
eventB1 SEQUENCE {			
b1-ThresholdEUTRA SEQUENCE {			
rsrp	61	-80dBm	FR1
	FFS	FFS	FR2
}			
}			
}			
}			
reportAmount	r1		
}			
}			
}			
}			

Table 8.1.3.2.1.3.3-4: *MeasurementReport* (step 5, Table 8.1.3.2.1.3.2-3)

Derivation Path: 38.508-1 [4] Table 4.6.1-5A			
Information Element	Value/remark	Comment	Condition
MeasurementReport ::= SEQUENCE {			
criticalExtensions CHOICE {			
measurementReport SEQUENCE {			
measResults SEQUENCE {			
measId	1		Step 5
measResultServingMOList SEQUENCE (SIZE (1..maxNrofServingCells)) OF MeasResultServMO {	1 entry	Report NR Cell 1	
MeasResultServMO[1] SEQUENCE {		entry 1	
servCellId	ServCellIndex of NR Cell 1		
measResultServingCell SEQUENCE {			
physCellId	Physical layer cell identity of NR Cell 1		
measResult SEQUENCE {			
cellResults SEQUENCE {			
resultsSSB-Cell SEQUENCE {			
rsrp	(0..127)		
rsrq	(0..127)		
sinr	Not present		
}			
}			
}			
}			
}			
}			
}			
}			
measResultNeighCells CHOICE {			
measResultListEUTRA SEQUENCE (SIZE (1..maxCellReport)) OF MeasResultEUTRA {	1 entry	Report E-UTRA neighbour cell	
MeasResultEUTRA[1] SEQUENCE {		entry 1	
eutra-PhysCellId	Physical layer cell identity of E-UTRA Cell 1		Step 5
measResult SEQUENCE {			
rsrp	(0..97)		
rsrq	(0..34)		
sinr	Not present		
}			
cgi-Info	Not present		
}			
}			
}			
}			

8.1.3.2.2 Measurement configuration control and reporting / Inter-RAT measurements / Event B2 / Measurement of E-UTRA cells

8.1.3.2.2.1 Test Purpose (TP)

(1)

```

with { UE is NR RRC_CONNECTED state and inter-RAT measurement event B2 to measure neighbor E-UTRA cell is configured }
ensure that {
  when { Entering condition 1 for event B2 is not met but Entering condition 2 is met }
  then { UE does not transmit any MeasurementReport }
}

```

(2)

```

with { UE is NR RRC_CONNECTED state and inter-RAT measurement event B2 to measure neighbor E-UTRA
cell is configured }
ensure that {
  when { Entering condition 1 and 2 for event B2 is met }
  then { UE transmits a MeasurementReport }
}

```

8.1.3.2.2.2 Conformance requirements

References: The conformance requirements covered in the current TC are specified in: TS 38.331, clauses 5.3.5.3, 5.5.2, 5.5.4.1, 5.5.4.9 and 5.5.5. Unless otherwise stated these are Rel-15 requirements.

[TS 38.331, clause 5.3.5.3]

The UE shall perform the following actions upon reception of the *RRCReconfiguration*:

...

1> if the *RRCReconfiguration* message includes the *measConfig*:

2> perform the measurement configuration procedure as specified in 5.5.2;

...

1> if the UE is configured with E-UTRA *nr-SecondaryCellGroupConfig* (MCG is E-UTRA):

2> if *RRCReconfiguration* was received via SRB1:

3> submit the *RRCReconfigurationComplete* via the EUTRA MCG embedded in E-UTRA RRC message *RRCConnectionReconfigurationComplete* as specified in TS 36.331 [10];

3> if *reconfigurationWithSync* was included in *spCellConfig* of an SCG:

4> initiate the random access procedure on the SpCell, as specified in TS 38.321 [3];

3> else:

4> the procedure ends;

NOTE: The order the UE sends the *RRCConnectionReconfigurationComplete* message and performs the Random Access procedure towards the SCG is left to UE implementation.

2> else (*RRCReconfiguration* was received via SRB3):

3> submit the *RRCReconfigurationComplete* message via SRB3 to lower layers for transmission using the new configuration;

NOTE: For EN-DC, in the case *RRCReconfiguration* is received via SRB1, the random access is triggered by RRC layer itself as there is not necessarily other UL transmission. In the case *RRCReconfiguration* is received via SRB3, the random access is triggered by the MAC layer due to arrival of *RRCReconfigurationComplete*.

1> else:

2> submit the *RRCReconfigurationComplete* message via SRB1 to lower layers for transmission using the new configuration;

2> if this is the first *RRCReconfiguration* message after successful completion of the RRC re-establishment procedure;

3> resume SRB2 and DRBs that are suspended;

...

[TS 38.331, clause 5.5.2.1]

...

The UE shall:

...

1> if the received *measConfig* includes the *measObjectToAddModList*:

2> perform the measurement object addition/modification procedure as specified in 5.5.2.5;

...

1> if the received *measConfig* includes the *reportConfigToAddModList*:

2> perform the reporting configuration addition/modification procedure as specified in 5.5.2.7;

...

1> if the received *measConfig* includes the *measIdToAddModList*:

2> perform the measurement identity addition/modification procedure as specified in 5.5.2.3;

1> if the received *measConfig* includes the *measGapConfig*:

2> perform the measurement gap configuration procedure as specified in 5.5.2.9;

...

[TS 38.331, clause 5.5.2.9]

The UE shall:

1> if *gapUE* is set to setup:

2> if a per UE measurement gap configuration is already setup, release the per UE measurement gap configuration;

2> setup the per UE measurement gap configuration indicated by the *measGapConfig* in accordance with the received *gapOffset*, i.e., the first subframe of each gap occurs at an SFN and subframe meeting the following condition:

$$\text{SFN mod } T = \text{FLOOR}(\text{gapOffset}/10);$$

$$\text{subframe} = \text{gapOffset mod } 10;$$

with $T = \text{MGRP}/10$ as defined in TS 38.133 [14];

2> if *mgta* is configured, apply the specified timing advance to the gap occurrences calculated above (i.e. the UE starts the measurement *mgta* ms before the gap subframe occurrences);

1> else if *gapUE* is set to release:

2> release the per UE measurement gap configuration.

[TS 38.331, clause 5.5.4.1]

If security has been activated successfully, the UE shall:

1> for each *measId* included in the *measIdList* within *VarMeasConfig*:

2> if the corresponding *reportConfig* includes a *reportType* set to *eventTriggered* or *periodical*;

3> if the corresponding *measObject* concerns NR;

...

4> for measurement events other than *eventA1* or *eventA2*:

5> if *useWhiteCellList* is set to TRUE:

- 6> consider any neighbouring cell detected based on parameters in the associated *measObjectNR* to be applicable when the concerned cell is included in the *whiteCellsToAddModList* defined within the *VarMeasConfig* for this *measId*;
- 5> else:
 - 6> consider any neighbouring cell detected based on parameters in the associated *measObjectNR* to be applicable when the concerned cell is not included in the *blackCellsToAddModList* defined within the *VarMeasConfig* for this *measId*;
- 3> else if the corresponding *measObject* concerns E-UTRA;
 - 4> consider any neighbouring cell detected on the associated frequency to be applicable when the concerned cell is not included in the *blackCellsToAddModListEUTRAN* defined within the *VarMeasConfig* for this *measId*;
- ...
- 2> if the *reportType* is set to *eventTriggered* and if the entry condition applicable for this event, i.e. the event corresponding with the *eventId* of the corresponding *reportConfig* within *VarMeasConfig*, is fulfilled for one or more applicable cells for all measurements after layer 3 filtering taken during *timeToTrigger* defined for this event within the *VarMeasConfig*, while the *VarMeasReportList* does not include a measurement reporting entry for this *measId* (a first cell triggers the event):
 - 3> include a measurement reporting entry within the *VarMeasReportList* for this *measId*;
 - 3> set the *numberOfReportsSent* defined within the *VarMeasReportList* for this *measId* to 0;
 - 3> include the concerned cell(s) in the *cellsTriggeredList* defined within the *VarMeasReportList* for this *measId*;
 - 3> initiate the measurement reporting procedure, as specified in 5.5.5;
- 2> else if the *reportType* is set to *eventTriggered* and if the entry condition applicable for this event, i.e. the event corresponding with the *eventId* of the corresponding *reportConfig* within *VarMeasConfig*, is fulfilled for one or more applicable cells not included in the *cellsTriggeredList* for all measurements after layer 3 filtering taken during *timeToTrigger* defined for this event within the *VarMeasConfig* (a subsequent cell triggers the event):
 - 3> set the *numberOfReportsSent* defined within the *VarMeasReportList* for this *measId* to 0;
 - 3> include the concerned cell(s) in the *cellsTriggeredList* defined within the *VarMeasReportList* for this *measId*;
 - 3> initiate the measurement reporting procedure, as specified in 5.5.5;
- 2> else if the *reportType* is set to *eventTriggered* and if the leaving condition applicable for this event is fulfilled for one or more of the cells included in the *cellsTriggeredList* defined within the *VarMeasReportList* for this *measId* for all measurements after layer 3 filtering taken during *timeToTrigger* defined within the *VarMeasConfig* for this event:
 - 3> remove the concerned cell(s) in the *cellsTriggeredList* defined within the *VarMeasReportList* for this *measId*;
 - 3> if *reportOnLeave* is set to *TRUE* for the corresponding reporting configuration:
 - 4> initiate the measurement reporting procedure, as specified in 5.5.5;
 - 3> if the *cellsTriggeredList* defined within the *VarMeasReportList* for this *measId* is empty:
 - 4> remove the measurement reporting entry within the *VarMeasReportList* for this *measId*;
 - 4> stop the periodical reporting timer for this *measId*, if running;
- ...
- 2> upon the expiry of T321 for this *measId*;

- 3> include a measurement reporting entry within the *VarMeasReportList* for this *measId*;
- 3> set the *numberOfReportsSent* defined within the *VarMeasReportList* for this *measId* to 0;
- 3> initiate the measurement reporting procedure, as specified in 5.5.5.

[TS 38.331, clause 5.5.4.9]

The UE shall:

- 1> consider the entering condition for this event to be satisfied when both condition B2-1 and condition B2-2, as specified below, are fulfilled;
- 1> consider the leaving condition for this event to be satisfied when condition B2-3 or condition B2-4, i.e. at least one of the two, as specified below, is fulfilled;

Inequality B2-1 (Entering condition 1)

$$Mp + Hys < Thresh1$$

Inequality B2-2 (Entering condition 2)

$$Mn + Ofn + Ocn - Hys > Thresh2$$

Inequality B2-3 (Leaving condition 1)

$$Mp - Hys > Thresh1$$

Inequality B2-4 (Leaving condition 2)

$$Mn + Ofn + Ocn + Hys < Thresh2$$

The variables in the formula are defined as follows:

Mp is the measurement result of the PCell, not taking into account any offsets.

Mn is the measurement result of the inter-RAT neighbour cell, not taking into account any offsets.

Ofn is the measurement object specific offset of the frequency of the inter-RAT neighbour cell (i.e. *eutra-Q-OffsetRange* as defined within the *measObjectEUTRA* corresponding to the frequency of the inter-RAT neighbour cell).

Ocn is the cell specific offset of the inter-RAT neighbour cell (i.e. *cellIndividualOffset* as defined within the *measObjectEUTRA* corresponding to the neighbour inter-RAT cell), and set to zero if not configured for the neighbour cell.

Hys is the hysteresis parameter for this event (i.e. *hysteresis* as defined within *reportConfigInterRAT* for this event).

Thresh1 is the threshold parameter for this event (i.e. *b2-Threshold1* as defined within *reportConfigInterRAT* for this event).

Thresh2 is the threshold parameter for this event (i.e. *b2-Threshold2EUTRA* as defined within *reportConfigInterRAT* for this event).

Mp is expressed in dBm in case of RSRP, or in dB in case of RSRQ and SINR.

Mn is expressed in dBm or dB, depending on the measurement quantity of the inter-RAT neighbour cell.

Ofn, Ocn, Hys are expressed in dB.

Thresh1 is expressed in the same unit as ***Mp***.

Thresh2 is expressed in the same unit as ***Mn***.

[TS 38.331, clause 5.5.5]



Figure 5.5.5-1: Measurement reporting

The purpose of this procedure is to transfer measurement results from the UE to the network. The UE shall initiate this procedure only after successful security activation.

For the *measId* for which the measurement reporting procedure was triggered, the UE shall set the *measResults* within the *MeasurementReport* message as follows:

- 1> set the *measId* to the measurement identity that triggered the measurement reporting;
- 1> set the *measResultServingCell* within *measResultServingMOList* to include, for each NR serving cell that is configured with *servingCellMO*, RSRP, RSRQ and the available SINR, derived based on the *rsType* if indicated in the associated *reportConfig*, otherwise based on SSB if available, otherwise based on CSI-RS;
- 1> set the *measResultServingCell* within *measResultServingMOList* to include for each NR serving cell that is configured with *servingCellMO*, if any, the *servCellId*;
- 1> if the *reportConfig* associated with the *measId* that triggered the measurement reporting includes *reportQuantityRsIndexes* and *maxNrofRSIndexesToReport*:
 - 2> for each serving cell configured with *servingCellMO*, include beam measurement information according to the associated *reportConfig* as described in 5.5.5.2;
- ...
- 1> if there is at least one applicable neighbouring cell to report:
 - 2> if the *reportType* is set to *eventTriggered* or *periodical*:
 - 3> set the *measResultNeighCells* to include the best neighbouring cells up to *maxReportCells* in accordance with the following:
 - 4> if the *reportType* is set to *eventTriggered*:
 - 5> include the cells included in the *cellsTriggeredList* as defined within the *VarMeasReportList* for this *measId*;
 - ...
 - 4> for each cell that is included in the *measResultNeighCells*, include the *physCellId*;
 - 4> if the *reportType* is set to *eventTriggered* or *periodical*:
 - 5> for each included cell, include the layer 3 filtered measured results in accordance with the *reportConfig* for this *measId*, ordered as follows:
 - 6> if the *measObject* associated with this *measId* concerns NR:
 - 7> if *rsType* in the associated *reportConfig* is set to *ssb*:
 - 8> set *resultsSSB-Cell* within the *measResult* to include the SS/PBCH block based quantity(ies) indicated in the *reportQuantityCell* within the concerned *reportConfig*, in decreasing order of the sorting quantity, determined as specified in 5.5.5.3, i.e. the best cell is included first;

9> if *reportQuantityRSIndexes* and *maxNrofRSIndexesToReport* are configured, include beam measurement information as described in 5.5.5.2;

...

6> if the *measObject* associated with this *measId* concerns E-UTRA:

7> set the *measResult* to include the quantity(ies) indicated in the *reportQuantity* within the concerned *reportConfigInterRAT* in decreasing order of the sorting quantity, determined as specified in 5.5.5.3, i.e. the best cell is included first;

...

1> increment the *numberOfReportsSent* as defined within the *VarMeasReportList* for this *measId* by 1;

1> stop the periodical reporting timer, if running;

...

1> if the UE is configured with EN-DC:

2> if SRB3 is configured:

3> submit the *MeasurementReport* message via SRB3 to lower layers for transmission, upon which the procedure ends;

2> else:

3> submit the *MeasurementReport* message via the EUTRA MCG embedded in E-UTRA RRC message *ULInformationTransferMRDC* as specified in TS 36.331 [10].

1> else:

2> submit the *MeasurementReport* message to lower layers for transmission, upon which the procedure ends.

8.1.3.2.2.3 Test description

8.1.3.2.2.3.1 Pre-test conditions

System Simulator:

- NR Cell 1 is the PCell, E-UTRA Cell 1 is the inter-RAT neighbour cell of NR Cell 1.
- System information combination NR-6 as defined in TS 38.508-1 [4] clause 4.4.3.1.2.

UE:

- None.

Preamble:

- The UE is in state 3N-A as defined in TS 38.508-1 [4], subclause 4.4A.

8.1.3.2.2.3.2 Test procedure sequence

Table 8.1.3.2.2.3.2-1 and 8.1.3.2.2.3.2-2 illustrates the downlink power levels to be applied for NR Cell 1, and E-UTRA Cell 1 at various time instants of the test execution. Row marked "T0" denotes the conditions after the preamble, while the configuration marked "T1" is applied at the point indicated in the Main behaviour description in Table 8.1.3.2.2.3.2-3.

Table 8.1.3.2.3.2-1: Time instances of cell power level and parameter changes for FR1

	Parameter	Unit	NR Cell 1	E-UTRA Cell 1	Remark
T0	SS/PBCH SSS EPRE	dBm/SCS	-78	-	Power levels are such that entry condition 1 for event B2 is not satisfied and entry condition 2 is satisfied: $M_p + H_{ys} > Thresh1$ and $M_n + O_{fn} + O_{cn} - H_{ys} > Thresh2$
	Cell-specific RS EPRE	dBm/15 kHz		-73	
T1	SS/PBCH SSS EPRE	dBm/SCS	-85	-	Power levels are such that entry condition for event B2 is satisfied: $M_p + H_{ys} < Thresh1$ and $M_n + O_{fn} + O_{cn} - H_{ys} > Thresh2$
	Cell-specific RS EPRE	dBm/15 kHz		-73	

Table 8.1.3.2.3.2-2: Time instances of cell power level and parameter changes for FR2

	Parameter	Unit	NR Cell 1	E-UTRA Cell 1	Remark
T0	SS/PBCH SSS EPRE	dBm/SCS	FFS	-	Power levels are such that entry condition 1 for event B2 is not satisfied and entry condition 2 is satisfied: $M_p + H_{ys} > Thresh1$ and $M_n + O_{fn} + O_{cn} - H_{ys} > Thresh2$
	Cell-specific RS EPRE	dBm/15 kHz		FFS	
T1	SS/PBCH SSS EPRE	dBm/SCS	FFS	-	Power levels are such that entry condition for event B2 is satisfied: $M_p + H_{ys} < Thresh1$ and $M_n + O_{fn} + O_{cn} - H_{ys} > Thresh2$
	Cell-specific RS EPRE	dBm/15 kHz		FFS	

Table 8.1.3.2.3.2-3: Main behaviour

St	Procedure	Message Sequence		TP	Verdict
		U - S	Message		
1	The SS transmits an <i>RRCReconfiguration</i> message including <i>MeasConfig</i> to setup inter-RAT measurement and reporting for event B2.	<--	NR RRC: <i>RRCReconfiguration</i>	-	-
2	The UE transmits an <i>RRCReconfigurationComplete</i> message.	-->	NR RRC: <i>RRCReconfigurationComplete</i>	-	-
3	Check: Does the UE transmit a <i>MeasurementReport</i> message within the next 10s?	-->	NR RRC: <i>MeasurementReport</i>	1	F
4	SS re-adjusts the cell-specific reference signal level according to row "T1" in table 8.1.3.2.3.2-1/2.	-	-	-	-
5	Check: Does the UE transmit a <i>MeasurementReport</i> message to report event B2 with the measured RSRP value for NR Cell 1?	-->	NR RRC: <i>MeasurementReport</i>	2	P

8.1.3.2.2.3.3 Specific message contents

Table 8.1.3.2.2.3.3-1: *RRCReconfiguration* (step 1, Table 8.1.3.2.2.3.2-3)

Derivation Path: 38.508-1 [4] Table 4.6.1-13 with condition NR_MEAS

Table 8.1.3.2.2.3.3-2: *MeasConfig* (Table 8.1.3.2.2.3.3-1)

Derivation Path: 38.508-1 [4] Table 4.6.3-69			
Information Element	Value/remark	Comment	Condition
MeasConfig ::= SEQUENCE {			
measObjectToAddModList SEQUENCE (SIZE (1..maxNrofMeasId)) OF MeasObjectToAddMod {	2 entries		
MeasObjectToAddMod[1] SEQUENCE {		entry 1	
measObjectId	1	MeasObjectIdNR-f1	
measObject CHOICE {			
measObjectNR SEQUENCE {			
ssbFrequency	ssbFrequency IE equals the ARFCN for NR Cell 1		
absThreshSS-BlocksConsolidation	Not present		
}			
}			
MeasObjectToAddMod[2] SEQUENCE {		entry 2	
measObjectId	2	MeasObjectIdE-UTRA-f1	
measObject CHOICE {			
measObjectEUTRA SEQUENCE {			
carrierFreq	ARFCN-ValueEUTRA for E-UTRA Cell 1		
}			
}			
}			
reportConfigToAddModList SEQUENCE(SIZE (1..maxReportConfigId)) OF ReportConfigToAddMod {	1 entry		
ReportConfigToAddMod[1] SEQUENCE {		entry 1	
reportConfigId	1		
reportConfig CHOICE {			
reportConfigInterRAT	ReportConfigInterRAT-EventB2	Table 8.1.3.2.2.3.3-3	
}			
}			
measIdToAddModList SEQUENCE (SIZE (1..maxNrofMeasId)) OF MeasIdToAddMod {	1 entry		
MeasIdToAddMod[1] SEQUENCE {		entry 1	
measId	1		
measObjectId	2		
reportConfigId	1		
}			
quantityConfig	QuantityConfig with Condition INTER-RAT		
measGapConfig	MeasGapConfig		
}			

Table 8.1.3.2.2.3.3-4: *MeasurementReport* (step 5, Table 8.1.3.2.2.3.2-3)

Derivation Path: 38.508-1 [4] Table 4.6.1-5A			
Information Element	Value/remark	Comment	Condition
MeasurementReport ::= SEQUENCE {			
criticalExtensions CHOICE {			
measurementReport SEQUENCE {			
measResults SEQUENCE {			
measId	1		
measResultServingMOList SEQUENCE (SIZE (1..maxNrofServingCells)) OF MeasResultServMO {	1 entry	Report NR Cell 1	
MeasResultServMO[1] SEQUENCE {		entry 1	
servCellId	ServCellIndex of NR Cell 1		
measResultServingCell SEQUENCE {			
physCellId	Physical layer cell identity of NR Cell 1		
measResult SEQUENCE {			
cellResults SEQUENCE {			
resultsSSB-Cell SEQUENCE {			
rsrp	(0..127)		
rsrq	(0..127)		
sinr	Not present		
}			
}			
}			
}			
}			
measResultNeighCells CHOICE {			
measResultListEUTRA SEQUENCE (SIZE (1..maxCellReport)) OF MeasResultEUTRA {	1 entry	Report E-UTRA neighbour cell	
MeasResultEUTRA[1] SEQUENCE {		entry 1	
eutra-PhysCellId	Physical layer cell identity of E-UTRA Cell 1		
measResult SEQUENCE {			
rsrp	(0..97)		
rsrq	(0..34)		
sinr	Not present		
}			
cgi-Info	Not present		
}			
}			
}			
}			
}			
}			

8.1.3.2.3 Measurement configuration control and reporting / Inter-RAT measurements / Event B2 / Measurement of E-UTRA cells / RSRQ based measurements

8.1.3.2.3.1 Test Purpose (TP)

(1)

```

with { UE is NR RRC_CONNECTED state and inter-RAT measurement event B2 to measure neighbor E-UTRA
cell is configured and triggerQuantity set to rsrq }
ensure that {
  when { Entering condition 1 and 2 for event B2 is not met }
  then { UE does not send MeasurementReport }
}

```

(2)

```

with { UE is NR RRC_CONNECTED state and inter-RAT measurement event B2 to measure neighbor E-UTRA
cell is configured and triggerQuantity set to rsrq }
ensure that {
  when { Entering condition 1 and 2 for event B2 is met }
  then { UE transmits a MeasurementReport }
}

```

8.1.3.2.3.2 Conformance requirements

References: The conformance requirements covered in the present TC are specified in: TS 38.331, clause 5.3.5.3, 5.5.2.1, 5.5.4.1, 5.5.4.9 and 5.5.5.

[TS 38.331, clause 5.3.5.3]

The UE shall perform the following actions upon reception of the *RRCReconfiguration*:

...

- 1> if the *RRCReconfiguration* message includes the *measConfig*:
- 2> perform the measurement configuration procedure as specified in 5.5.2;

...

[TS 38.331, clause 5.5.2.1]

The UE shall:

- 1> if the received *measConfig* includes the *measObjectToRemoveList*:
 - 2> perform the measurement object removal procedure as specified in 5.5.2.4;
- 1> if the received *measConfig* includes the *measObjectToAddModList*:
 - 2> perform the measurement object addition/modification procedure as specified in 5.5.2.5;
- 1> if the received *measConfig* includes the *reportConfigToRemoveList*:
 - 2> perform the reporting configuration removal procedure as specified in 5.5.2.6;
- 1> if the received *measConfig* includes the *reportConfigToAddModList*:
 - 2> perform the reporting configuration addition/modification procedure as specified in 5.5.2.7;
- 1> if the received *measConfig* includes the *quantityConfig*:
 - 2> perform the quantity configuration procedure as specified in 5.5.2.8;
- 1> if the received *measConfig* includes the *measIdToRemoveList*:
 - 2> perform the measurement identity removal procedure as specified in 5.5.2.2;
- 1> if the received *measConfig* includes the *measIdToAddModList*:
 - 2> perform the measurement identity addition/modification procedure as specified in 5.5.2.3;
- 1> if the received *measConfig* includes the *measGapConfig*:
 - 2> perform the measurement gap configuration procedure as specified in 5.5.2.9;
- 1> if the received *measConfig* includes the *measGapSharingConfig*:
 - 2> perform the measurement gap sharing configuration procedure as specified in 5.5.2.11;
- 1> if the received *measConfig* includes the *s-MeasureConfig*:

- 2> if *s-MeasureConfig* is set to *ssb-RSRP*, set parameter *ssb-RSRP* of *s-MeasureConfig* within *VarMeasConfig* to the lowest value of the RSRP ranges indicated by the received value of *s-MeasureConfig*;
- 2> else, set parameter *csi-RSRP* of *s-MeasureConfig* within *VarMeasConfig* to the lowest value of the RSRP ranges indicated by the received value of *s-MeasureConfig*.

[TS 38.331, clause 5.5.4.1]

If security has been activated successfully, the UE shall:

- 1> for each *measId* included in the *measIdList* within *VarMeasConfig*:
 - 2> if the corresponding *reportConfig* includes a *reportType* set to *eventTriggered* or *periodical*;
 - ...
 - 3> else if the corresponding *measObject* concerns E-UTRA;
 - 4> consider any neighbouring cell detected on the associated frequency to be applicable when the concerned cell is not included in the *blackCellsToAddModListEUTRAN* defined within the *VarMeasConfig* for this *measId*;
 - ...
 - 2> if the *reportType* is set to *eventTriggered* and if the entry condition applicable for this event, i.e. the event corresponding with the *eventId* of the corresponding *reportConfig* within *VarMeasConfig*, is fulfilled for one or more applicable cells for all measurements after layer 3 filtering taken during *timeToTrigger* defined for this event within the *VarMeasConfig*, while the *VarMeasReportList* does not include a measurement reporting entry for this *measId* (a first cell triggers the event):
 - 3> include a measurement reporting entry within the *VarMeasReportList* for this *measId*;
 - 3> set the *numberOfReportsSent* defined within the *VarMeasReportList* for this *measId* to 0;
 - 3> include the concerned cell(s) in the *cellsTriggeredList* defined within the *VarMeasReportList* for this *measId*;
 - 3> initiate the measurement reporting procedure, as specified in 5.5.5;
 - 2> else if the *reportType* is set to *eventTriggered* and if the entry condition applicable for this event, i.e. the event corresponding with the *eventId* of the corresponding *reportConfig* within *VarMeasConfig*, is fulfilled for one or more applicable cells not included in the *cellsTriggeredList* for all measurements after layer 3 filtering taken during *timeToTrigger* defined for this event within the *VarMeasConfig* (a subsequent cell triggers the event):
 - 3> set the *numberOfReportsSent* defined within the *VarMeasReportList* for this *measId* to 0;
 - 3> include the concerned cell(s) in the *cellsTriggeredList* defined within the *VarMeasReportList* for this *measId*;
 - 3> initiate the measurement reporting procedure, as specified in 5.5.5;
 - 2> else if the *reportType* is set to *eventTriggered* and if the leaving condition applicable for this event is fulfilled for one or more of the cells included in the *cellsTriggeredList* defined within the *VarMeasReportList* for this *measId* for all measurements after layer 3 filtering taken during *timeToTrigger* defined within the *VarMeasConfig* for this event:
 - 3> remove the concerned cell(s) in the *cellsTriggeredList* defined within the *VarMeasReportList* for this *measId*;
 - 3> if *reportOnLeave* is set to *TRUE* for the corresponding reporting configuration:
 - 4> initiate the measurement reporting procedure, as specified in 5.5.5;
 - 3> if the *cellsTriggeredList* defined within the *VarMeasReportList* for this *measId* is empty:
 - 4> remove the measurement reporting entry within the *VarMeasReportList* for this *measId*;

4> stop the periodical reporting timer for this *measId*, if running;

...

2> upon the expiry of T321 for this *measId*:

3> include a measurement reporting entry within the *VarMeasReportList* for this *measId*;

3> set the *numberOfReportsSent* defined within the *VarMeasReportList* for this *measId* to 0;

3> initiate the measurement reporting procedure, as specified in 5.5.5.

[TS 38.331, clause 5.5.4.9]

The UE shall:

1> consider the entering condition for this event to be satisfied when both condition B2-1 and condition B2-2, as specified below, are fulfilled;

1> consider the leaving condition for this event to be satisfied when condition B2-3 or condition B2-4, i.e. at least one of the two, as specified below, is fulfilled;

Inequality B2-1 (Entering condition 1)

$$M_p + H_{ys} < Thresh1$$

Inequality B2-2 (Entering condition 2)

$$M_n + O_{fn} + O_{cn} - H_{ys} > Thresh2$$

Inequality B2-3 (Leaving condition 1)

$$M_p - H_{ys} > Thresh1$$

Inequality B2-4 (Leaving condition 2)

$$M_n + O_{fn} + O_{cn} + H_{ys} < Thresh2$$

The variables in the formula are defined as follows:

M_p is the measurement result of the PCell, not taking into account any offsets.

M_n is the measurement result of the inter-RAT neighbour cell, not taking into account any offsets.

O_{fn} is the measurement object specific offset of the frequency of the inter-RAT neighbour cell (i.e. *eutra-Q-OffsetRange* as defined within the *measObjectEUTRA* corresponding to the frequency of the inter-RAT neighbour cell).

O_{cn} is the cell specific offset of the inter-RAT neighbour cell (i.e. *cellIndividualOffset* as defined within the *measObjectEUTRA* corresponding to the neighbour inter-RAT cell), and set to zero if not configured for the neighbour cell.

H_{ys} is the hysteresis parameter for this event (i.e. *hysteresis* as defined within *reportConfigInterRAT* for this event).

Thresh1 is the threshold parameter for this event (i.e. *b2-Threshold1* as defined within *reportConfigInterRAT* for this event).

Thresh2 is the threshold parameter for this event (i.e. *b2-Threshold2EUTRA* as defined within *reportConfigInterRAT* for this event).

M_p is expressed in dBm in case of RSRP, or in dB in case of RSRQ and SINR.

M_n is expressed in dBm or dB, depending on the measurement quantity of the inter-RAT neighbour cell.

O_{fn}*, ***O_{cn}*, ***H_{ys} are expressed in dB.****

Thresh1 is expressed in the same unit as ***M_p***.

Thresh2 is expressed in the same unit as *Mn*.

[TS 38.331, clause 5.5.5.1]



Figure 5.5.5.1-1: Measurement reporting

For the *measId* for which the measurement reporting procedure was triggered, the UE shall set the *measResults* within the *MeasurementReport* message as follows:

- 1> set the *measId* to the measurement identity that triggered the measurement reporting;
- 1> set the *measResultServingCell* within *measResultServingMOList* to include, for each NR serving cell that is configured with *servingCellMO*, RSRP, RSRQ and the available SINR, derived based on the *rsType* if indicated in the associated *reportConfig*, otherwise based on SSB if available, otherwise based on CSI-RS;
- 1> set the *servCellId* within *measResultServingMOList* to include each NR serving cell that is configured with *servingCellMO*, if any;
- 1> if the *reportConfig* associated with the *measId* that triggered the measurement reporting includes *reportQuantityRS-Indexes* and *maxNrofRS-IndexesToReport*:
 - 2> for each serving cell configured with *servingCellMO*, include beam measurement information according to the associated *reportConfig* as described in 5.5.5.2;
- ...
- 1> if there is at least one applicable neighbouring cell to report:
 - 2> if the *reportType* is set to *eventTriggered* or *periodical*:
 - 3> set the *measResultNeighCells* to include the best neighbouring cells up to *maxReportCells* in accordance with the following:
 - 4> if the *reportType* is set to *eventTriggered*:
 - 5> include the cells included in the *cellsTriggeredList* as defined within the *VarMeasReportList* for this *measId*;
 - ...
 - 4> for each cell that is included in the *measResultNeighCells*, include the *physCellId*;
 - 4> if the *reportType* is set to *eventTriggered* or *periodical*:
 - 5> for each included cell, include the layer 3 filtered measured results in accordance with the *reportConfig* for this *measId*, ordered as follows:
 - ...
 - 6> if the *measObject* associated with this *measId* concerns E-UTRA:
 - 7> set the *measResult* to include the quantity(ies) indicated in the *reportQuantity* within the concerned *reportConfigInterRAT* in decreasing order of the sorting quantity, determined as specified in 5.5.5.3, i.e. the best cell is included first;
- ...

- 1> increment the *numberOfReportsSent* as defined within the *VarMeasReportList* for this *measId* by 1;
- 1> stop the periodical reporting timer, if running;
- 1> if the *numberOfReportsSent* as defined within the *VarMeasReportList* for this *measId* is less than the *reportAmount* as defined within the corresponding *reportConfig* for this *measId*:
 - 2> start the periodical reporting timer with the value of *reportInterval* as defined within the corresponding *reportConfig* for this *measId*;
- ...
- 1> else:
 - 2> submit the *MeasurementReport* message to lower layers for transmission, upon which the procedure ends.

8.1.3.2.3.3 Test description

8.1.3.2.3.3.1 Pre-test conditions

System Simulator:

- Cell 1 is the NR serving cell, E-UTRA Cell 1 is the inter-RAT neighbour cell.
- System information combination NR-6 as defined in TS 38.508-1 [4] clause 4.4.3.1.2, and message contents defined in clause 4.6.1 and clause 4.6.2 with QBASED condition is used in NR cells.

UE:

- None.

Preamble:

- The UE is in state 3N-A as defined in TS 38.508-1 [4], subclause 4.4A on NR Cell 1.

8.1.3.2.3.3.2 Test procedure sequence

Table 8.1.3.2.3.3.2-1 and 8.1.3.2.3.3.2-2 illustrate the downlink power levels to be applied for NR Cell 1 and E-UTRA Cell 1 at various time instants of the test execution for FR1 and FR2 respectively. Row marked "T0" denotes the conditions after the preamble, while rows marked "T1" and "T2" are to be applied subsequently. The exact instants on which these values shall be applied are described in the texts in this clause.

Table 8.1.3.2.3.3.2-1: Time instances of cell power level and parameter changes for FR1

	Parameter	Unit	NR Cell 1	E-UTRA Cell	Remark
T0	SS/PBCH SSS EPRE	dBm/SCS	-88	-	Power levels are such that entry condition for event B2 is not satisfied: $Mp + Hys \geq Thresh1$ or $Mn + Ofn + Ocn - Hys \leq Thresh2$
	SS-RSRQ	dB	-11.74	-	
	Cell-specific RS EPRE	dBm/15kHz	-	-94	
	RSRQ	dB	-	-11.46	
	Noc	dBm/SCS	-94	-	
	Noc	dBm/15kHz	-	-94	
T1	SS/PBCH SSS EPRE	dBm/SCS	-88	-	Power levels are such that entry condition for event B2 is satisfied: $Mp + Hys < Thresh1$ and $Mn + Ofn + Ocn - Hys > Thresh2$
	SS-RSRQ	dB	-11.74	-	
	Cell-specific RS EPRE	dBm/15kHz	-	-80	
	RSRQ	dB	-	-3.94	

Table 8.1.3.2.3.3.2-2: Time instances of cell power level and parameter changes for FR2

	Parameter	Unit	NR Cell 1	E-UTRA Cell 2	Remark
T0	SS/PBCH SSS EPRE	dBm/SCS	FFS	-	Power levels are such that entry condition for event B2 is not satisfied: $Mp + Hys \geq Thresh1$ or $Mn + Ofn + Ocn - Hys \leq Thresh2$
	SS-RSRQ	dB	FFS	-	
	Cell-specific RS EPRE	dBm/15kHz	-	FFS	
	RSRQ	dB	-	FFS	
	Noc	dBm/SCS	FFS	-	
	Noc	dBm/15kHz	-	FFS	
T1	SS/PBCH SSS EPRE	dBm/SCS	FFS	-	Power levels are such that entry condition for event B2 is satisfied: $Mp + Hys < Thresh1$ and $Mn + Ofn + Ocn - Hys > Thresh2$
	SS-RSRQ	dB	FFS	-	
	Cell-specific RS EPRE	dBm/15kHz	-	FFS	
	RSRQ	dB	-	FFS	

Table 8.1.3.2.3.3.2-3: Main behaviour

St	Procedure	Message Sequence		TP	Verdict
		U - S	Message		
1	The SS transmits an <i>RRCReconfiguration</i> message on NR Cell 1 including <i>MeasConfig</i> to setup inter-RAT measurement and reporting for event B2	<-	NR RRC: <i>RRCReconfiguration</i>	-	-
2	The UE transmits an <i>RRCReconfigurationComplete</i> message on NR Cell 1.	-->	NR RRC: <i>RRCReconfigurationComplete</i>	-	-
3	Check: Does the UE transmit a <i>MeasurementReport</i> message on NR Cell 1 within the next 10s?	-->	NR RRC: <i>MeasurementReport</i>	1	F
4	The SS re-adjusts the cell-specific reference signal level according to row "T1" in Table 8.1.3.2.3.3.2-1/2.	-	-	-	-
5	Check: Does the UE transmit a <i>MeasurementReport</i> message on Cell 1 to report event B2 with the measured RSRP and RSRQ values for E-UTRA Cell 1?	-->	NR RRC: <i>MeasurementReport</i>	2	P

8.1.3.2.3.3.3 Specific message contents

Table 8.1.3.2.3.3.3-1: *RRCReconfiguration* (step 1, Table 8.1.3.2.3.3.2-3)

Derivation Path: 38.508-1 [4] table 4.6.1-13 with condion NR_MEAS

Table 8.1.3.2.3.3.3-2: MeasConfig (step 1, Table 8.1.3.2.3.3.2-3)

Derivation path: 38.508-1 [4] table 4.6.3-69			
Information Element	Value/Remark	Comment	Condition
MeasConfig ::= SEQUENCE {			
measObjectToAddModList SEQUENCE (SIZE (1..maxNrofMeasId)) OF MeasObjectToAddMod {	2 entries		
MeasObjectToAddMod[1] SEQUENCE {		entry 1	
measObjectId	1		
measObject CHOICE {			
measObjectNR	MeasObjectNR-f1	Table 8.1.3.2.3.3.3-3	
}			
}			
MeasObjectToAddMod[2] SEQUENCE {		entry 2	
measObjectId	2		
measObject CHOICE {			
measObjectEUTRA	MeasObjectEUTRA-f2	Table 8.1.3.2.3.3.3-4	
}			
}			
}			
reportConfigToAddModList SEQUENCE(SIZE (1..maxReportConfigId)) OF ReportConfigToAddMod {	1 entry		
ReportConfigToAddMod[1] SEQUENCE {		entry 1	
reportConfigId	ReportConfigId		
reportConfig CHOICE {			
reportConfigInterRAT	ReportConfigInterRAT-B2	Table 8.1.3.2.3.3.3-5	
}			
}			
}			
measIdToAddModList SEQUENCE (SIZE (1..maxNrofMeasId)) OF MeasIdToAddMod {	1 entry		
MeasIdToAddMod[1] SEQUENCE {		entry 1	
measId	1		
measObjectId	2		
reportConfigId	ReportConfigId		
}			
}			
quantityConfig	QuantityConfig with condition INTER-RAT		
measGapConfig	MeasGapConfig	Table 8.1.3.2.3.3.3-6	
}			

Table 8.1.3.2.3.3.3-3: MeasObjectNR-f1 (Table 8.1.3.2.3.3.3-2)

Derivation Path: TS 38.508-1 [4], Table 4.6.3-76			
Information Element	Value/remark	Comment	Condition
MeasObjectNR ::= SEQUENCE {			
ssbFrequency	Downlink ARFCN of NR cell 1 SSB		
absThreshSS-BlocksConsolidation	Not present		
}			

Table 8.1.3.2.3.3.3-4: MeasObjectEUTRA-f2 (Table 8.1.3.2.3.3.3-2)

Derivation Path: TS 38.508-1 [4], Table 4.6.3-74			
Information Element	Value/remark	Comment	Condition
MeasObjectEUTRA ::= SEQUENCE {			
carrierFreq	Downlink ARFCN of E-UTRA Cell 1		
}			

Table 8.1.3.2.3.3.3-5: ReportConfigInterRAT-B2 (Table 8.1.3.2.3.3.3-2)

Derivation Path: TS 38.508-1 [4], Table 4.6.3-141 with condition EVENT_B2			
Information Element	Value/remark	Comment	Condition
ReportConfigInterRAT ::= SEQUENCE {			
reportType CHOICE {			
eventTriggered SEQUENCE {			
eventId CHOICE {			
eventB2 SEQUENCE {			
b2-Threshold1 CHOICE {			
rsrq	79	Actual value = -4dB	
}			
b2-Threshold2EUTRA CHOICE {			
rsrq	23	Actual value = -8dB	
}			
hysteresis	Hysteresis		
timeToTrigger	ms0		
}			
}			
reportInterval	ReportInterval		
}			

Table 8.1.3.2.3.3.3-6: MeasGapConfig (Table 8.1.3.2.3.3.3-2)

Derivation Path: TS 38.508-1 [4], Table 4.6.3-70			
Information Element	Value/remark	Comment	Condition
MeasGapConfig ::= SEQUENCE {			
gapUE CHOICE {			
setup SEQUENCE {			
gapOffset	0		
mgl	ms6		
mgrp	ms40		
mgta	ms0		
}			
}			

Table 8.1.3.2.3.3.3-7: MeasurementReport (steps 5, Table 8.1.3.2.3.3.3-2)

Derivation Path: TS 38.508-1 [4], table 4.6.1-5A			
Information Element	Value/remark	Comment	Condition
MeasurementReport ::= SEQUENCE {			
criticalExtensions CHOICE {			
measurementReport SEQUENCE {			
measResults SEQUENCE {			
measId	1	Step 5	
measResultServingMOList SEQUENCE (SIZE (1..maxNrofServingCells)) OF MeasResultServMO {			
MeasResultServMO[1] SEQUENCE {	1 entry	entry 1	
servCellId	ServCellIndex of NR serving cell		
measResultServingCell SEQUENCE {			
physCellId	PhysCellId of NR serving cell		
measResult SEQUENCE {			
cellResults SEQUENCE {			
resultsSSB-Cell SEQUENCE {			
rsrp	(0..127)		
rsrq	(0..127)		
sinr	Not present		
}			
}			
}			
}			
}			
}			
measResultNeighCells CHOICE {			
MeasResultListEUTRA SEQUENCE (SIZE (1..maxCellReport)) OF MeasResultEUTRA {	1 entry		
MeasResultEUTRA[1] SEQUENCE {		entry 1	
eutra-PhysCellId	PhysCellId of E-UTRA Cell 1	Step 5	
measResult SEQUENCE {			
rsrp	(0..97)		
rsrq	(0..34)		
sinr	Not present		
}			
cgi-Info	Not present		
}			
}			
}			

8.1.3.2.4 Measurement configuration control and reporting / Inter-RAT measurements / Event B2 / Measurement of E-UTRA cells / SINR based measurements

8.1.3.2.4.1 Test Purpose (TP)

(1)

```
with { UE is NR RRC_CONNECTED state and inter-RAT measurement event B2 to measure neighbor E-UTRA cell is configured and triggerQuantity set to sinr }
ensure that {
  when { Entering condition 1 and 2 for event B2 is not met }
  then { UE does not transmit any MeasurementReport }
}
```

(2)

```

with { UE is NR RRC_CONNECTED state and inter-RAT measurement event B2 to measure neighbor E-UTRA
cell is configured and triggerQuantity set to sinr }
ensure that {
  when { Entering condition 1 and 2 for event B2 is met }
  then { UE transmits a MeasurementReport }
}

```

8.1.3.2.4.2 Conformance requirements

References: The conformance requirements covered in the current TC are specified in: TS 38.331, clauses 5.3.5.3, 5.5.2.1, 5.5.2.9, 5.5.4.1, 5.5.4.9 and 5.5.5.1. Unless otherwise stated these are Rel-15 requirements.

[TS 38.331, clause 5.3.5.3]

The UE shall perform the following actions upon reception of the *RRCReconfiguration*:

...

1> if the *RRCReconfiguration* message includes the *measConfig*:

2> perform the measurement configuration procedure as specified in 5.5.2;

...

1> if the UE is configured with E-UTRA *nr-SecondaryCellGroupConfig* (MCG is E-UTRA):

...

1> else:

2> submit the *RRCReconfigurationComplete* message via SRB1 to lower layers for transmission using the new configuration;

...

[TS 38.331, clause 5.5.2.1]

...

The UE shall:

...

1> if the received *measConfig* includes the *measObjectToAddModList*:

2> perform the measurement object addition/modification procedure as specified in 5.5.2.5;

...

1> if the received *measConfig* includes the *reportConfigToAddModList*:

2> perform the reporting configuration addition/modification procedure as specified in 5.5.2.7;

...

1> if the received *measConfig* includes the *measIdToAddModList*:

2> perform the measurement identity addition/modification procedure as specified in 5.5.2.3;

...

1> if the received *measConfig* includes the *measGapConfig*:

2> perform the measurement gap configuration procedure as specified in 5.5.2.9;

...

[TS 38.331, clause 5.5.2.9]

The UE shall:

...

1> if *gapUE* is set to *setup*:

- 2> if a per UE measurement gap configuration is already setup, release the per UE measurement gap configuration;
- 2> setup the per UE measurement gap configuration indicated by the *measGapConfig* in accordance with the received *gapOffset*, i.e., the first subframe of each gap occurs at an SFN and subframe meeting the following condition:

$$\text{SFN mod } T = \text{FLOOR}(\text{gapOffset}/10);$$

$$\text{subframe} = \text{gapOffset mod } 10;$$

with $T = \text{MGRP}/10$ as defined in TS 38.133 [14];

- 2> if *mgta* is configured, apply the specified timing advance to the gap occurrences calculated above (i.e. the UE starts the measurement *mgta* ms before the gap subframe occurrences);

...

[TS 38.331, clause 5.5.4.1]

If AS security has been activated successfully, the UE shall:

1> for each *measId* included in the *measIdList* within *VarMeasConfig*:

- 2> if the corresponding *reportConfig* includes a *reportType* set to *eventTriggered* or *periodical*:

...

3> else if the corresponding *measObject* concerns E-UTRA:

- 4> consider any neighbouring cell detected on the associated frequency to be applicable when the concerned cell is not included in the *blackCellsToAddModListEUTRAN* defined within the *VarMeasConfig* for this *measId*;

...

- 2> if the *reportType* is set to *eventTriggered* and if the entry condition applicable for this event, i.e. the event corresponding with the *eventId* of the corresponding *reportConfig* within *VarMeasConfig*, is fulfilled for one or more applicable cells for all measurements after layer 3 filtering taken during *timeToTrigger* defined for this event within the *VarMeasConfig*, while the *VarMeasReportList* does not include a measurement reporting entry for this *measId* (a first cell triggers the event):

3> include a measurement reporting entry within the *VarMeasReportList* for this *measId*;

3> set the *numberOfReportsSent* defined within the *VarMeasReportList* for this *measId* to 0;

3> include the concerned cell(s) in the *cellsTriggeredList* defined within the *VarMeasReportList* for this *measId*;

3> initiate the measurement reporting procedure, as specified in 5.5.5;

- 2> else if the *reportType* is set to *eventTriggered* and if the entry condition applicable for this event, i.e. the event corresponding with the *eventId* of the corresponding *reportConfig* within *VarMeasConfig*, is fulfilled for one or more applicable cells not included in the *cellsTriggeredList* for all measurements after layer 3 filtering taken during *timeToTrigger* defined for this event within the *VarMeasConfig* (a subsequent cell triggers the event):

3> set the *numberOfReportsSent* defined within the *VarMeasReportList* for this *measId* to 0;

- 3> include the concerned cell(s) in the *cellsTriggeredList* defined within the *VarMeasReportList* for this *measId*;
- 3> initiate the measurement reporting procedure, as specified in 5.5.5;
- 2> else if the *reportType* is set to *eventTriggered* and if the leaving condition applicable for this event is fulfilled for one or more of the cells included in the *cellsTriggeredList* defined within the *VarMeasReportList* for this *measId* for all measurements after layer 3 filtering taken during *timeToTrigger* defined within the *VarMeasConfig* for this event:
 - 3> remove the concerned cell(s) in the *cellsTriggeredList* defined within the *VarMeasReportList* for this *measId*;
 - 3> if *reportOnLeave* is set to *true* for the corresponding reporting configuration:
 - 4> initiate the measurement reporting procedure, as specified in 5.5.5;
 - 3> if the *cellsTriggeredList* defined within the *VarMeasReportList* for this *measId* is empty:
 - 4> remove the measurement reporting entry within the *VarMeasReportList* for this *measId*;
 - 4> stop the periodical reporting timer for this *measId*, if running;
- ...
- 2> upon expiry of the periodical reporting timer for this *measId*:
 - 3> initiate the measurement reporting procedure, as specified in 5.5.5.
- ...

[TS 38.331, clause 5.5.4.9]

The UE shall:

- 1> consider the entering condition for this event to be satisfied when both condition B2-1 and condition B2-2, as specified below, are fulfilled;
- 1> consider the leaving condition for this event to be satisfied when condition B2-3 or condition B2-4, i.e. at least one of the two, as specified below, is fulfilled;

Inequality B2-1 (Entering condition 1)

$$Mp + Hys < Thresh1$$

Inequality B2-2 (Entering condition 2)

$$Mn + Ofn + Ocn - Hys > Thresh2$$

Inequality B2-3 (Leaving condition 1)

$$Mp - Hys > Thresh1$$

Inequality B2-4 (Leaving condition 2)

$$Mn + Ofn + Ocn + Hys < Thresh2$$

The variables in the formula are defined as follows:

Mp is the measurement result of the PCell, not taking into account any offsets.

Mn is the measurement result of the inter-RAT neighbour cell, not taking into account any offsets.

Ofn is the measurement object specific offset of the frequency of the inter-RAT neighbour cell (i.e. *eutra-Q-OffsetRange* as defined within the *measObjectEUTRA* corresponding to the frequency of the inter-RAT neighbour cell).

Ocn is the cell specific offset of the inter-RAT neighbour cell (i.e. *cellIndividualOffset* as defined within the *measObjectEUTRA* corresponding to the neighbour inter-RAT cell), and set to zero if not configured for the neighbour cell.

Hys is the hysteresis parameter for this event (i.e. *hysteresis* as defined within *reportConfigInterRAT* for this event).

Thresh1 is the threshold parameter for this event (i.e. *b2-Threshold1* as defined within *reportConfigInterRAT* for this event).

Thresh2 is the threshold parameter for this event (i.e. *b2-Threshold2EUTRA* as defined within *reportConfigInterRAT* for this event).

Mp is expressed in dBm in case of RSRP, or in dB in case of RSRQ and SINR.

Mn is expressed in dBm or dB, depending on the measurement quantity of the inter-RAT neighbour cell.

Ofn, Ocn, Hys are expressed in dB.

Thresh1 is expressed in the same unit as **Mp**.

Thresh2 is expressed in the same unit as **Mn**.

[TS 38.331, clause 5.5.5.1]



Figure 5.5.5.1-1: Measurement reporting

The purpose of this procedure is to transfer measurement results from the UE to the network. The UE shall initiate this procedure only after successful AS security activation.

For the *measId* for which the measurement reporting procedure was triggered, the UE shall set the *measResults* within the *MeasurementReport* message as follows:

- 1> set the *measId* to the measurement identity that triggered the measurement reporting;
- 1> set the *measResultServingCell* within *measResultServingMOList* to include, for each NR serving cell that is configured with *servingCellMO*, RSRP, RSRQ and the available SINR, derived based on the *rsType* if indicated in the associated *reportConfig*, otherwise based on SSB if available, otherwise based on CSI-RS;
- 1> set the *servCellId* within *measResultServingMOList* to include each NR serving cell that is configured with *servingCellMO*, if any;
- ...
- 1> if there is at least one applicable neighbouring cell to report:
 - 2> if the *reportType* is set to *eventTriggered* or *periodical*:
 - 3> set the *measResultNeighCells* to include the best neighbouring cells up to *maxReportCells* in accordance with the following:
 - 4> if the *reportType* is set to *eventTriggered*:
 - 5> include the cells included in the *cellsTriggeredList* as defined within the *VarMeasReportList* for this *measId*;
- ...

- 4> for each cell that is included in the *measResultNeighCells*, include the *physCellId*;
- 4> if the *reportType* is set to *eventTriggered* or *periodical*:
 - 5> for each included cell, include the layer 3 filtered measured results in accordance with the *reportConfig* for this *measId*, ordered as follows:
 - ...
 - 6> if the *measObject* associated with this *measId* concerns E-UTRA:
 - 7> set the *measResult* to include the quantity(ies) indicated in the *reportQuantity* within the concerned *reportConfigInterRAT* in decreasing order of the sorting quantity, determined as specified in 5.5.5.3, i.e. the best cell is included first;
 - ...
 - 1> increment the *numberOfReportsSent* as defined within the *VarMeasReportList* for this *measId* by 1;
 - 1> stop the periodical reporting timer, if running;
 - 1> if the *numberOfReportsSent* as defined within the *VarMeasReportList* for this *measId* is less than the *reportAmount* as defined within the corresponding *reportConfig* for this *measId*:
 - 2> start the periodical reporting timer with the value of *reportInterval* as defined within the corresponding *reportConfig* for this *measId*;
 - ...
 - 1> else:
 - 2> submit the *MeasurementReport* message to lower layers for transmission, upon which the procedure ends.

8.1.3.2.4.3 Test description

8.1.3.2.4.3.1 Pre-test conditions

System Simulator:

- NR Cell 1 is the serving cell, EUTRA Cell 1 is the inter-RAT neighbour cell of NR Cell 1.
- System information combination NR-7 as defined in TS 38.508-1 [4] clause 4.4.3.1.2, and message contents defined in clause 4.6.1 and clause 4.6.2 with QBASED condition is used in NR cells.

UE:

- None.

Preamble:

- The UE is in state 3N-A as defined in TS 38.508-1 [4], subclause 4.4A.

8.1.3.2.4.3.2 Test procedure sequence

Table 8.1.3.2.4.3.2-1 and 8.1.3.2.4.3.2-2 illustrates the downlink power levels to be applied for NR Cell 1 and EUTRA Cell 1 at various time instants of the test execution. Row marked "T0" denotes the conditions after the preamble, while the configuration marked "T1", is applied at the point indicated in the Main behaviour description in Table 8.1.3.2.4.3.2-3.

Table 8.1.3.2.4.3.2-1: Time instances of cell power level and parameter changes for NR Cell 1 and E-UTRA Cell 1 in FR1

	Parameter	Unit	NR Cell 1	E-UTRA Cell 1	Remark
T0	SS/PBCH SSS EPRE	dBm/SCS	-79	-	Power levels are such that entry conditions for event B2 are not satisfied: 1) $Mp + Hys \geq Thresh1$ and 2) $Mn + Ofn + Ocn - Hys \leq Thresh2$
	Cell-specific RS EPRE	dBm/15 kHz	-	-91	
	Noc	dBm/15 kHz	-	-82	
	Noc	dBm/SCS	-94	-	
	SINR	-	15	-9	
T1	SS/PBCH SSS EPRE	dBm/SCS	-91	-	Power levels are such that entry condition for event B2 are satisfied: 1) $Mp + Hys < Thresh1$ and $Mn + Ofn + Ocn - Hys > Thresh2$
	Cell-specific RS EPRE	dBm/15 kHz	-	-73	
	Noc	dBm/15 kHz	-	-82	
	Noc	dBm/SCS	-94	-	
	SINR	-	3	9	

Table 8.1.3.2.4.3.2-2: Time instances of cell power level and parameter changes for NR Cell 1 and E-UTRA Cell 1 in FR2

	Parameter	Unit	NR Cell 1	E-UTRA Cell 1	Remark
T0	SS/PBCH SSS EPRE	dBm/SCS	FFS	-	Power levels are such that entry conditions for event B2 are not satisfied: 1) $Mp + Hys \geq Thresh1$ and 2) $Mn + Ofn + Ocn - Hys \leq Thresh2$
	Cell-specific RS EPRE	dBm/15 kHz	-	FFS	
	Noc	dBm/15 kHz	-	FFS	
	Noc	dBm/SCS	FFS	-	
	SINR	-	FFS	FFS	
T1	SS/PBCH SSS EPRE	dBm/SCS	FFS	-	Power levels are such that entry condition for event B2 are satisfied: $Mp + Hys < Thresh1$ and $Mn + Ofn + Ocn - Hys > Thresh2$
	Cell-specific RS EPRE	dBm/15 kHz	-	FFS	
	Noc	dBm/15 kHz	-	FFS	
	Noc	dBm/SCS	FFS	-	
	SINR	-	FFS	FFS	

Table 8.1.3.2.4.3.2-3: Main behaviour

St	Procedure	Message Sequence		TP	Verdict
		U - S	Message		
1	The SS transmits an <i>RRCReconfiguration</i> message including <i>MeasConfig</i> to setup EUTRA measurement and reporting for inter-RAT event B2.	<--	NR RRC: <i>RRCReconfiguration</i>	-	-
2	The UE transmits an <i>RRCReconfigurationComplete</i> message.	-->	NR RRC: <i>RRCReconfigurationComplete</i>	-	-
3	Check: Does the UE transmit a <i>MeasurementReport</i> message with event B2 for EUTRA Cell 1 within the next 10s?	-	-	1	F
4	SS re-adjusts the cell-specific reference signal level according to row "T1" in table 8.1.3.2.4.3.2-1/2.	-	-	-	-
5	Check: Does the UE transmit a <i>MeasurementReport</i> message with event B2 for EUTRA Cell 1 within the next 10s?	-->	NR RRC: <i>MeasurementReport</i>	2	P

8.1.3.2.4.3.3 Specific message contents

Table 8.1.3.2.4.3.3-1: *RRCReconfiguration* (step 1, Table 8.1.3.2.4.3.2-3)

Derivation Path: 38.508-1 [4] Table 4.6.1-13 with condition NR_MEAS

Table 8.1.3.2.4.3.3-2: MeasConfig (Table 8.1.3.2.4.3.3-1)

Derivation Path: 38.508-1 [4] Table 4.6.3-69			
Information Element	Value/remark	Comment	Condition
MeasConfig ::= SEQUENCE {			
measObjectToAddModList SEQUENCE (SIZE (1..maxNrofMeasId)) OF MeasObjectToAddMod {	2 entries		
MeasObjectToAddMod[1] SEQUENCE {		entry 1	
measObjectId	1		
measObject CHOICE {			
measObjectNR	MeasObjectNR-f1	Table 8.1.3.2.4.3.3-3	
}			
}			
MeasObjectToAddMod[2] SEQUENCE {		entry 2	
measObjectId	2		
measObject CHOICE {			
measObjectEUTRA	MeasObjectEUTRA-f2	Table 8.1.3.2.4.3.3-4	
}			
}			
reportConfigToAddModList SEQUENCE(SIZE (1..maxReportConfigId)) OF ReportConfigToAddMod {	1 entry		
ReportConfigToAddMod[1] SEQUENCE {		entry 1	
reportConfigId	1		
reportConfig CHOICE {			
reportConfigInterRAT	ReportConfigInterRAT-EventB2	Table 8.1.3.2.4.3.3-5	
}			
}			
measIdToAddModList SEQUENCE (SIZE (1..maxNrofMeasId)) OF MeasIdToAddMod {	1 entry		
MeasIdToAddMod[1] SEQUENCE {		entry 1	
measId	1		
measObjectId	2		
reportConfigId	1		
}			
}			
quantityConfig	QuantityConfig with condition INTER-RAT		
measGapConfig	MeasGapConfig		
}			

Table 8.1.3.2.4.3.3-3: MeasObjectNR-f1 (Table 8.1.3.2.4.3.3-2)

Derivation Path: TS 38.508-1 [4], Table 4.6.3-76			
Information Element	Value/remark	Comment	Condition
MeasObjectNR ::= SEQUENCE {			
ssbFrequency	ARFCN-ValueNR for SSB of NR Cell 1		
absThreshSS-BlocksConsolidation	Not present		
nrofSS-BlocksToAverage	Not present		
}			

Table 8.1.3.2.4.3.3-4: MeasObjectEUTRA-f2 (Table 8.1.3.2.4.3.3-2)

Derivation Path: TS 38.508-1 [4], Table 4.6.3-74			
Information Element	Value/remark	Comment	Condition
MeasObjectEUTRA ::= SEQUENCE {			
carrierFreq	ARFCN-ValueEUTRA for CRS of E-UTRA Cell 1		
}			

Table 8.1.3.2.4.3.3-5: ReportConfigInterRAT-EventB2 (Table 8.1.3.2.4.3.3-2)

Derivation Path: 38.508-1 [4] Table 4.6.3-141 with condition EVENT_B2			
Information Element	Value/remark	Comment	Condition
ReportConfigInterRAT ::= SEQUENCE {			
reportType CHOICE {			
eventTriggered SEQUENCE {			
eventId CHOICE {			
eventB2 SEQUENCE {			
b2-Threshold1 CHOICE {			
sinr	64	Actual value = 9dB	FR1
	FFS		FR2
}			
b2-Threshold2EUTRA CHOICE {			
sinr	46	0 dB	
}			
hysteresis	4	2 dB	
}			
}			
reportAmount	r1		
reportQuantity SEQUENCE {			
rsrp	true		
rsrq	true		
sinr	true		
}			
}			
}			

(2)

```

with { UE in NR RRC_CONNECTED state }
ensure that {
  when { UE is commanded to report the global cell identity of the neighbour NR cell }
  then { UE determines the global cell identity of the cell included in the associated measurement
object by acquiring the relevant system information from the concerned cell and reports the global
cell identity in the MeasurementReport }
}

```

8.1.3.3.1.2 Conformance requirements

References: The conformance requirements covered in the current TC are specified in: TS 38.331, clauses 5.3.5.3, 5.5.2.3, 5.5.3.1, 5.5.4.8 and 5.5.5. Unless otherwise stated these are Rel-15 requirements.

[TS 38.331, clause 5.3.5.3]

The UE shall perform the following actions upon reception of the *RRCReconfiguration*:

...

1> if the *RRCReconfiguration* message includes the *measConfig*:

2> perform the measurement configuration procedure as specified in 5.5.2;

...

1> else (MCG *RRCReconfiguration*):

2> submit the *RRCReconfigurationComplete* message via SRB1 to lower layers for transmission using the new configuration;

...

[TS 38.331, clause 5.5.2.1]

...

The UE shall:

...

1> if the received *measConfig* includes the *measObjectToAddModList*:

2> perform the measurement object addition/modification procedure as specified in 5.5.2.5;

...

1> if the received *measConfig* includes the *reportConfigToAddModList*:

2> perform the reporting configuration addition/modification procedure as specified in 5.5.2.7;

...

1> if the received *measConfig* includes the *measIdToAddModList*:

2> perform the measurement identity addition/modification procedure as specified in 5.5.2.3;

...

[TS 38.331, clause 5.5.2.3]

...

The UE shall:

1> for each *measId* included in the received *measIdToAddModList*:

- 2> if an entry with the matching *measId* exists in the *measIdList* within the *VarMeasConfig*:
 - 3> replace the entry with the value received for this *measId*;
- 2> else:
 - 3> add a new entry for this *measId* within the *VarMeasConfig*;
- 2> remove the measurement reporting entry for this *measId* from the *VarMeasReportList*, if included;
- 2> stop the periodical reporting timer or timer T321, whichever one is running, and reset the associated information (e.g. *timeToTrigger*) for this *measId*;
- 2> if the *reportType* is set to *reportCGI* in the *reportConfig* associated with this *measId*:
 - ...
 - 3> if the *measObject* associated with this *measId* concerns NR:
 - 4> if the *measObject* associated with this *measId* concerns FR1:
 - 5> start timer T321 with the timer value set to 2 seconds for this *measId*;
 - 4> if the *measObject* associated with this *measId* concerns FR2:
 - 5> start timer T321 with the timer value set to 16 seconds for this *measId*.

[TS 38.331, clause 5.5.3.1]

The UE shall:

- 1> whenever the UE has a *measConfig*, perform RSRP and RSRQ measurements for each serving cell for which *servingCellMO* is configured as follows:
 - 2> if the *reportConfig* associated with at least one *measId* included in the *measIdList* within *VarMeasConfig* contains an *rsType* set to *ssb* and *ssb-ConfigMobility* is configured in the *measObject* indicated by the *servingCellMO*:
 - ...
 - 3> derive serving cell measurement results based on SS/PBCH block, as described in 5.5.3.3;
 - ...
- 1> for each *measId* included in the *measIdList* within *VarMeasConfig*:
 - 2> if the *reportType* for the associated *reportConfig* is set to *reportCGI* and timer T321 is running:
 - 3> perform the corresponding measurements on the frequency and RAT indicated in the associated *measObject* using available idle periods;
 - 3> if the cell indicated by *reportCGI* field for the associated *measObject* is an NR cell and that indicated cell is broadcasting *SIB1* (see TS 38.213 [13], clause 13):
 - 4> try to acquire *SIB1* in the concerned cell;
 - ...
 - 2> if the *reportType* for the associated *reportConfig* is *periodical* or *eventTriggered*:
 - ...
 - 3> if the UE does not require measurement gaps to perform the concerned measurements:
 - 4> if *s-MeasureConfig* is not configured
 - ...

- 5> if the *measObject* is associated to NR and the *rsType* is set to *ssb*:
 - 6> if *reportQuantityRS-Indexes* and *maxNrofRS-IndexesToReport* for the associated *reportConfig* are configured:
 - 7> derive layer 3 beam measurements only based on SS/PBCH block for each measurement quantity indicated in *reportQuantityRS-Indexes*, as described in 5.5.3.3a;
 - 6> derive cell measurement results based on SS/PBCH block for the trigger quantity and each measurement quantity indicated in *reportQuantityCell* using parameters from the associated *measObject*, as described in 5.5.3.3;
- ...
- 2> perform the evaluation of reporting criteria as specified in 5.5.4.

[TS 38.331, clause 5.5.4.1]

If AS security has been activated successfully, the UE shall:

- 1> for each *measId* included in the *measIdList* within *VarMeasConfig*:
 - 2> if the corresponding *reportConfig* includes a *reportType* set to *eventTriggered* or *periodical*:
 - 3> if the corresponding *measObject* concerns NR:
 - ...
 - 4> if the *eventA3* or *eventA5* is configured in the corresponding *reportConfig*:
 - 5> if a serving cell is associated with a *measObjectNR* and neighbours are associated with another *measObjectNR*, consider any serving cell associated with the other *measObjectNR* to be a neighbouring cell as well;
 - 4> if corresponding *reportConfig* includes *reportType* set to *periodical*; or
 - 4> for measurement events other than *eventA1* or *eventA2*:
 - ...
 - 5> else:
 - 6> consider any neighbouring cell detected based on parameters in the associated *measObjectNR* to be applicable when the concerned cell is not included in the *blackCellsToAddModList* defined within the *VarMeasConfig* for this *measId*;
 - ...
 - 2> else if the corresponding *reportConfig* includes a *reportType* set to *reportCGI*:
 - 3> consider the cell detected on the associated *measObject* which has a physical cell identity matching the value of the *cellForWhichToReportCGI* included in the corresponding *reportConfig* within the *VarMeasConfig* to be applicable;
 - ...
 - 2> if the *reportType* is set to *eventTriggered* and if the entry condition applicable for this event, i.e. the event corresponding with the *eventId* of the corresponding *reportConfig* within *VarMeasConfig*, is fulfilled for one or more applicable cells for all measurements after layer 3 filtering taken during *timeToTrigger* defined for this event within the *VarMeasConfig*, while the *VarMeasReportList* does not include a measurement reporting entry for this *measId* (a first cell triggers the event):
 - 3> include a measurement reporting entry within the *VarMeasReportList* for this *measId*;
 - 3> set the *numberOfReportsSent* defined within the *VarMeasReportList* for this *measId* to 0;

3> include the concerned cell(s) in the *cellsTriggeredList* defined within the *VarMeasReportList* for this *measId*;

3> initiate the measurement reporting procedure, as specified in 5.5.5;

...

2> upon expiry of the periodical reporting timer for this *measId*:

3> initiate the measurement reporting procedure, as specified in 5.5.5.

...

2> if *reportType* is set to *reportCGI*:

3> if the UE acquired the *SIB1* or *SystemInformationBlockType1* for the requested cell; or

3> if the UE detects that the requested NR cell is not transmitting *SIB1* (see TS 38.213 [13], clause 13):

4> stop timer T321;

4> include a measurement reporting entry within the *VarMeasReportList* for this *measId*;

4> set the *numberOfReportsSent* defined within the *VarMeasReportList* for this *measId* to 0;

4> initiate the measurement reporting procedure, as specified in 5.5.5;

2> upon the expiry of T321 for this *measId*:

3> include a measurement reporting entry within the *VarMeasReportList* for this *measId*;

3> set the *numberOfReportsSent* defined within the *VarMeasReportList* for this *measId* to 0;

3> initiate the measurement reporting procedure, as specified in 5.5.5.

[TS 38.331, clause 5.5.4.4]

The UE shall:

1> consider the entering condition for this event to be satisfied when condition A3-1, as specified below, is fulfilled;

1> consider the leaving condition for this event to be satisfied when condition A3-2, as specified below, is fulfilled;

1> use the SpCell for *Mp*, *Ofp* and *Ocp*.

NOTE The cell(s) that triggers the event has reference signals indicated in the *measObjectNR* associated to this event which may be different from the NR SpCell *measObjectNR*.

Inequality A3-1 (Entering condition)

$$Mn + Ofn + Ocn - Hys > Mp + Ofp + Ocp + Off$$

Inequality A3-2 (Leaving condition)

$$Mn + Ofn + Ocn + Hys < Mp + Ofp + Ocp + Off$$

The variables in the formula are defined as follows:

Mn is the measurement result of the neighbouring cell, not taking into account any offsets.

Ofn is the measurement object specific offset of the reference signal of the neighbour cell (i.e. *offsetMO* as defined within *measObjectNR* corresponding to the neighbour cell).

Ocn is the cell specific offset of the neighbour cell (i.e. *cellIndividualOffset* as defined within *measObjectNR* corresponding to the frequency of the neighbour cell), and set to zero if not configured for the neighbour cell.

Mp is the measurement result of the SpCell, not taking into account any offsets.

Ofp is the measurement object specific offset of the SpCell (i.e. *offsetMO* as defined within *measObjectNR* corresponding to the SpCell).

Ocp is the cell specific offset of the SpCell (i.e. *cellIndividualOffset* as defined within *measObjectNR* corresponding to the SpCell), and is set to zero if not configured for the SpCell.

Hys is the hysteresis parameter for this event (i.e. *hysteresis* as defined within *reportConfigNR* for this event).

Off is the offset parameter for this event (i.e. *a3-Offset* as defined within *reportConfigNR* for this event).

Mn, *Mp* are expressed in dBm in case of RSRP, or in dB in case of RSRQ and RS-SINR.

Ofn, *Ocn*, *Ofp*, *Ocp*, *Hys*, *Off* are expressed in dB.

[TS 38.331, clause 5.5.5]



Figure 5.5.5.1-1: Measurement reporting

The purpose of this procedure is to transfer measurement results from the UE to the network. The UE shall initiate this procedure only after successful AS security activation.

For the *measId* for which the measurement reporting procedure was triggered, the UE shall set the *measResults* within the *MeasurementReport* message as follows:

- 1> set the *measId* to the measurement identity that triggered the measurement reporting;
- 1> for each serving cell configured with *servingCellMO*:
 - 2> if the *reportConfig* associated with the *measId* that triggered the measurement reporting includes *rsType*:
 - 3> if the serving cell measurements based on the *rsType* included in the *reportConfig* that triggered the measurement report are available:
 - 4> set the *measResultServingCell* within *measResultServingMOList* to include RSRP, RSRQ and the available SINR of the serving cell, derived based on the *rsType* included in the *reportConfig* that triggered the measurement report;
 - 2> else:
 - 3> if SSB based serving cell measurements are available:
 - 4> set the *measResultServingCell* within *measResultServingMOList* to include RSRP, RSRQ and the available SINR of the serving cell, derived based on SSB;
 - 3> else if CSI-RS based serving cell measurements are available:
 - 4> set the *measResultServingCell* within *measResultServingMOList* to include RSRP, RSRQ and the available SINR of the serving cell, derived based on CSI-RS;
- 1> set the *servCellId* within *measResultServingMOList* to include each NR serving cell that is configured with *servingCellMO*, if any;
- ...
- 1> if there is at least one applicable neighbouring cell to report:
 - 2> if the *reportType* is set to *eventTriggered* or *periodical*:

3> set the *measResultNeighCells* to include the best neighbouring cells up to *maxReportCells* in accordance with the following:

4> if the *reportType* is set to *eventTriggered*:

5> include the cells included in the *cellsTriggeredList* as defined within the *VarMeasReportList* for this *measId*;

...

4> for each cell that is included in the *measResultNeighCells*, include the *physCellId*;

4> if the *reportType* is set to *eventTriggered* or *periodical*:

5> for each included cell, include the layer 3 filtered measured results in accordance with the *reportConfig* for this *measId*, ordered as follows:

6> if the *measObject* associated with this *measId* concerns NR:

7> if *rsType* in the associated *reportConfig* is set to *ssb*:

8> set *resultsSSB-Cell* within the *measResult* to include the SS/PBCH block based quantity(ies) indicated in the *reportQuantityCell* within the concerned *reportConfig*, in decreasing order of the sorting quantity, determined as specified in 5.5.5.3, i.e. the best cell is included first;

...

2> else:

3> if the cell indicated by *cellForWhichToReportCGI* is an NR cell:

4> if *plmn-IdentityInfoList* of the *cgi-Info* for the concerned cell has been obtained:

5> include the *plmn-IdentityInfoList* including *plmn-IdentityList*, *trackingAreaCode* (if available), *ranac* (if available) and *cellIdentity* for each entry of the *plmn-IdentityInfoList*;

5> include *frequencyBandList* if available;

4> else if *MIB* indicates the *SIB1* is not broadcast:

5> include the *noSIB1* including the *ssb-SubcarrierOffset* and *pdccch-ConfigSIB1* obtained from *MIB* of the concerned cell;

...

1> increment the *numberOfReportsSent* as defined within the *VarMeasReportList* for this *measId* by 1;

1> stop the periodical reporting timer, if running;

1> if the *numberOfReportsSent* as defined within the *VarMeasReportList* for this *measId* is less than the *reportAmount* as defined within the corresponding *reportConfig* for this *measId*:

2> start the periodical reporting timer with the value of *reportInterval* as defined within the corresponding *reportConfig* for this *measId*;

...

1> else:

2> submit the *MeasurementReport* message to lower layers for transmission, upon which the procedure ends.

8.1.3.3.1.3 Test description

8.1.3.3.1.3.1 Pre-test conditions

System Simulator:

- NR Cell 1 is the PCell, NR Cell 2 is the intra-frequency neighbour cell of NR Cell 1.
- System information combination NR-2 as defined in TS 38.508-1 [4] clause 4.4.3.1.2.

UE:

- None.

Preamble:

- The UE is in state 3N-A as defined in TS 38.508-1 [4], subclause 4.4A.

8.1.3.3.1.3.2 Test procedure sequence

Table 8.1.3.3.1.3.2-1 and 8.1.3.3.1.3.2-2 illustrates the downlink power levels to be applied for NR Cell 1, and NR Cell 2 at various time instants of the test execution. Row marked "T0" denotes the conditions after the preamble, while the configuration marked "T1" is applied at the point indicated in the Main behaviour description in Table 8.1.3.3.1.3.2-3.

Table 8.1.3.3.1.3.2-1: Time instances of cell power level and parameter changes for FR1

	Parameter	Unit	NR Cell 1	NR Cell 2	Remark
T0	SS/PBCH SSS EPRE	dBm/ SCS	-85	-91	Power levels are such that entry condition for event A3 is not satisfied: $Mn + Ofn + Ocn - Hys < Mp + Ofp + Ocp + Off$
T1	SS/PBCH SSS EPRE	dBm/ SCS	-85	-79	Power levels are such that entry condition for event A3 is satisfied: $Mn + Ofn + Ocn - Hys > Mp + Ofp + Ocp + Off$

Table 8.1.3.3.1.3.2-2: Time instances of cell power level and parameter changes for FR2

	Parameter	Unit	NR Cell 1	NR Cell 2	Remark
T0	SS/PBCH SSS EPRE	dBm/ SCS	FFS	FFS	Power levels are such that entry condition for event A3 is not satisfied: $Mn + Ofn + Ocn - Hys < Mp + Ofp + Ocp + Off$
T1	SS/PBCH SSS EPRE	dBm/ SCS	FFS	FFS	Power levels are such that entry condition for event A3 is satisfied: $Mn + Ofn + Ocn - Hys > Mp + Ofp + Ocp + Off$

Table 8.1.3.3.1.3.2-3: Main behaviour

St	Procedure	Message Sequence		TP	Verdict
		U - S	Message		
1	The SS transmits an <i>RRCReconfiguration</i> message including <i>MeasConfig</i> to setup intra-frequency measurement and reporting for event A3.	<--	NR RRC: <i>RRCReconfiguration</i>	-	-
2	The UE transmits an <i>RRCReconfigurationComplete</i> message.	-->	NR RRC: <i>RRCReconfigurationComplete</i>	-	-
3	SS re-adjusts the cell-specific reference signal level according to row "T1" in table 8.1.3.3.1.3.2-1/2.	-	-	-	-
4	Check: Does the UE transmit a <i>MeasurementReport</i> message to report event A3 with the measured RSRP value for NR Cell 2?	-->	NR RRC: <i>MeasurementReport</i>	1	P
5	The SS transmits an <i>RRCConnectionReconfiguration</i> message including <i>measConfig</i> including <i>reportCGI</i> for Cell 2 and sufficient idle periods for UE to acquire the relevant system information from Cell 2	<--	NR RRC: <i>RRCReconfiguration</i>	-	-
6	The UE transmits an <i>RRCConnectionReconfigurationComplete</i> message.	-->	NR RRC: <i>RRCReconfigurationComplete</i>	-	-
7	Check: Does the UE transmit a <i>MeasurementReport</i> message with CGI of Cell 2 within 2 sec if Cell 2 is in FR1 (or within 16 sec if Cell 2 is in FR2)?	-->	NR RRC: <i>MeasurementReport</i>	2	P

8.1.3.3.1.3.3 Specific message contents

Table 8.1.3.3.1.3.3-1: *RRCReconfiguration* (step 1, Table 8.1.3.3.1.3.2-3)

Derivation Path: 38.508-1 [4] Table 4.6.1-13 with condition NR_MEAS

Table 8.1.3.3.1.3.3-2: *CellGroupConfig-DRX* (Table 8.1.3.3.1.3.3-1)

Derivation Path: TS 508-1 [4], Table 4.6.3-19 with condition MEAS			
Information Element	Value/remark	Comment	Condition
CellGroupConfig ::= SEQUENCE {			
mac-CellGroupConfig	MAC-CellGroupConfig	Table 8.1.3.3.1.3.3-9	
}			

Table 8.1.3.3.1.3.3-3: MeasConfig-A3 (Table 8.1.3.3.1.3.3-1)

Derivation Path: 38.508-1 [4] Table 4.6.3-69			
Information Element	Value/remark	Comment	Condition
MeasConfig ::= SEQUENCE {			
measObjectToAddModList SEQUENCE (SIZE (1..maxNrofMeasId)) OF MeasObjectToAddMod {	1 entry		
MeasObjectToAddMod[1] SEQUENCE {		entry 1	
measObjectId	1		
measObject CHOICE {			
measObjectNR SEQUENCE {			
ssbFrequency	ssbFrequency IE equals the ARFCN for NR Cell 1		
absThreshSS-BlocksConsolidation	Not present		
}			
}			
}			
reportConfigToAddModList SEQUENCE(SIZE (1..maxReportConfigId)) OF ReportConfigToAddMod {	2 entries		
ReportConfigToAddMod[1] SEQUENCE {		entry 1	
reportConfigId	1		
reportConfig CHOICE {			
reportConfigNR	ReportConfigNR-A3	Table 8.1.3.3.1.3.3-4	
}			
}			
ReportConfigToAddMod[2] SEQUENCE {		entry 2	
reportConfigId	2		
reportConfig CHOICE {			
reportConfigNR	ReportConfigNR-CGI	Table 8.1.3.3.1.3.3-5	
}			
}			
measIdToAddModList SEQUENCE (SIZE (1..maxNrofMeasId)) OF MeasIdToAddMod {	1 entry		
MeasIdToAddMod[1] SEQUENCE {		entry 1	
measId	1		
measObjectId	1		
reportConfigId	1	reportConfigId for event A3	
}			
}			
}			

Table 8.1.3.3.1.3.3-4: ReportConfigNR-A3 (Table 8.1.3.3.1.3.3-2)

Derivation Path: TS 38.508-1 [4] Table 4.6.3-142 with Condition EVENT_A3			
Information Element	Value/remark	Comment	Condition
ReportConfigNR ::= SEQUENCE {			
reportType CHOICE {			
eventTriggered SEQUENCE {			
eventId CHOICE {			
eventA3 SEQUENCE {			
a3-Offset CHOICE {			
rsrp	2	1 dB (2*0.5 dB)	
}			
}			
}			
reportAmount	r1		
}			

Table 8.1.3.3.1.3.3-5: ReportConfigNR-CGI (Table 8.1.3.3.1.3.3-2)

Derivation Path: TS 38.508-1 [4] Table 4.6.3-142 with Condition CGI			
Information Element	Value/remark	Comment	Condition
ReportConfigNR ::= SEQUENCE {			
reportType CHOICE {			
reportCGI SEQUENCE {			
cellForWhichToReportCGI	PhysCellId of NR Cell 2		
}			
}			
}			

Table 8.1.3.3.1.3.3-6: RRCReconfiguration (step 5, Table 8.1.3.3.1.3.2-3)

Derivation Path: 38.508-1 [4] Table 4.6.1-13			
Information Element	Value/remark	Comment	Condition
RRCReconfiguration ::= SEQUENCE {			
criticalExtensions CHOICE {			
rrcReconfiguration SEQUENCE {			
measConfig	MeasConfig-CGI	Table 8.1.3.3.1.3.3-7	
nonCriticalExtension SEQUENCE {			
masterCellGroup	CellGroupConfig-DRX	Table 8.1.3.3.1.3.3-2	
}			
}			
}			
}			

Table 8.1.3.3.1.3.3-7: MeasConfig-CGI (Table 8.1.3.3.1.3.3-6)

Derivation Path: 38.508-1 [4] Table 4.6.3-69			
Information Element	Value/remark	Comment	Condition
MeasConfig ::= SEQUENCE {			
measObjectToAddModList	Not present		
reportConfigToAddModList	Not present		
measIdToAddModList SEQUENCE (SIZE (1..maxNrofMeasId)) OF MeasIdToAddMod {	1 entry		
MeasIdToAddMod[1] SEQUENCE {		entry 1	
measId	1		
measObjectId	1		
reportConfigId	2	reportConfigId for CGI measurement	
}			
}			
}			

Table 8.1.3.3.1.3.3-9: MAC-CellGroupConfig

Derivation Path: TS 38.508-1 [4], Table 4.6.3-68 with Condition DRX			
Information Element	Value/remark	Comment	Condition
MAC-CellGroupConfig ::= SEQUENCE {			
drx-Config CHOICE {			
setup SEQUENCE {			
drx-InactivityTimer	ms100		
drx-LongCycleStartOffset CHOICE {			
ms640	0		
}			
}			
}			

8.1.3.3.2 Measurement configuration control and reporting / CGI reporting of E-UTRA cell

8.1.3.3.2.1 Test Purpose (TP)

(1)

```
with { UE in NR RRC_CONNECTED state }
ensure that {
  when { UE detects that entering condition 1 and 2 for event B2 is met }
  then { UE transmits a MeasurementReport for event B2 }
}
```

(2)

```
with { UE in NR RRC_CONNECTED state }
ensure that {
  when { UE is commanded to report the global cell identity of the neighbour E-UTRA cell }
  then { UE determines the global cell identity of the cell included in the associated measurement
object by acquiring the relevant system information from the concerned cell and reports the global
cell identity in the MeasurementReport }
}
```

8.1.3.3.2.2 Conformance requirements

References: The conformance requirements covered in the current TC are specified in: TS 38.331, clauses 5.3.5.3, 5.5.2.3, 5.5.3.1, 5.5.4.8 and 5.5.5. Unless otherwise stated these are Rel-15 requirements.

[TS 38.331, clause 5.3.5.3]

The UE shall perform the following actions upon reception of the *RRCReconfiguration*:

...

1> if the *RRCReconfiguration* message includes the *measConfig*:

2> perform the measurement configuration procedure as specified in 5.5.2;

...

1> else (MCG *RRCReconfiguration*):

2> submit the *RRCReconfigurationComplete* message via SRB1 to lower layers for transmission using the new configuration;

...

[TS 38.331, clause 5.5.2.1]

...

The UE shall:

...

1> if the received *measConfig* includes the *measObjectToAddModList*:

2> perform the measurement object addition/modification procedure as specified in 5.5.2.5;

...

1> if the received *measConfig* includes the *reportConfigToAddModList*:

2> perform the reporting configuration addition/modification procedure as specified in 5.5.2.7;

...

1> if the received *measConfig* includes the *measIdToAddModList*:

2> perform the measurement identity addition/modification procedure as specified in 5.5.2.3;

1> if the received *measConfig* includes the *measGapConfig*:

2> perform the measurement gap configuration procedure as specified in 5.5.2.9;

...

[TS 38.331, clause 5.5.2.3]

...

The UE shall:

1> for each *measId* included in the received *measIdToAddModList*:

2> if an entry with the matching *measId* exists in the *measIdList* within the *VarMeasConfig*:

3> replace the entry with the value received for this *measId*;

2> else:

3> add a new entry for this *measId* within the *VarMeasConfig*;

2> remove the measurement reporting entry for this *measId* from the *VarMeasReportList*, if included;

2> stop the periodical reporting timer or timer T321, whichever one is running, and reset the associated information (e.g. *timeToTrigger*) for this *measId*;

2> if the *reportType* is set to *reportCGI* in the *reportConfig* associated with this *measId*:

3> if the *measObject* associated with this *measId* concerns E-UTRA:

4> start timer T321 with the timer value set to 1 second for this *measId*;

...

[TS 38.331, clause 5.5.2.9]

The UE shall:

...

1> if *gapUE* is set to *setup*:

2> if a per UE measurement gap configuration is already setup, release the per UE measurement gap configuration;

2> setup the per UE measurement gap configuration indicated by the *measGapConfig* in accordance with the received *gapOffset*, i.e., the first subframe of each gap occurs at an SFN and subframe meeting the following condition:

$\text{SFN mod } T = \text{FLOOR}(\text{gapOffset}/10)$;

subframe = $gapOffset \bmod 10$;

with $T = MGRP/10$ as defined in TS 38.133 [14];

2> apply the specified timing advance $mgta$ to the gap occurrences calculated above (i.e. the UE starts the measurement $mgta$ ms before the gap subframe occurrences);

1> else if $gapUE$ is set to *release*:

2> release the per UE measurement gap configuration.

[TS 38.331, clause 5.5.3.1]

The UE shall:

1> whenever the UE has a $measConfig$, perform RSRP and RSRQ measurements for each serving cell for which $servingCellMO$ is configured as follows:

2> if the $reportConfig$ associated with at least one $measId$ included in the $measIdList$ within $VarMeasConfig$ contains an $rsType$ set to *ssb* and $ssb-ConfigMobility$ is configured in the $measObject$ indicated by the $servingCellMO$:

...

3> derive serving cell measurement results based on SS/PBCH block, as described in 5.5.3.3;

...

1> for each $measId$ included in the $measIdList$ within $VarMeasConfig$:

2> if the $reportType$ for the associated $reportConfig$ is set to *reportCGI* and timer T321 is running:

3> perform the corresponding measurements on the frequency and RAT indicated in the associated $measObject$ using available idle periods;

...

3> if the cell indicated by $reportCGI$ field is an E-UTRA cell:

4> try to acquire $SystemInformationBlockType1$ in the concerned cell;

2> if the $reportType$ for the associated $reportConfig$ is *periodical* or *eventTriggered*:

3> if a measurement gap configuration is setup

...

4> if $s-MeasureConfig$ is not configured

...

5> if the $measObject$ is associated to E-UTRA:

6> perform the corresponding measurements associated to neighbouring cells on the frequencies indicated in the concerned $measObject$, as described in 5.5.3.2;

...

2> perform the evaluation of reporting criteria as specified in 5.5.4.

[TS 38.331, clause 5.5.4.1]

If AS security has been activated successfully, the UE shall:

1> for each $measId$ included in the $measIdList$ within $VarMeasConfig$:

2> if the corresponding $reportConfig$ includes a $reportType$ set to *eventTriggered* or *periodical*:

...

3> else if the corresponding *measObject* concerns E-UTRA:

4> if *eventB1* or *eventB2* is configured in the corresponding *reportConfig*:

5> consider a serving cell, if any, on the associated E-UTRA frequency as neighbour cell;

4> else:

5> consider any neighbouring cell detected on the associated frequency to be applicable when the concerned cell is not included in the *blackCellsToAddModListEUTRAN* defined within the *VarMeasConfig* for this *measId*;

...

2> else if the corresponding *reportConfig* includes a *reportType* set to *reportCGI*:

3> consider the cell detected on the associated *measObject* which has a physical cell identity matching the value of the *cellForWhichToReportCGI* included in the corresponding *reportConfig* within the *VarMeasConfig* to be applicable;

...

2> if the *reportType* is set to *eventTriggered* and if the entry condition applicable for this event, i.e. the event corresponding with the *eventId* of the corresponding *reportConfig* within *VarMeasConfig*, is fulfilled for one or more applicable cells for all measurements after layer 3 filtering taken during *timeToTrigger* defined for this event within the *VarMeasConfig*, while the *VarMeasReportList* does not include a measurement reporting entry for this *measId* (a first cell triggers the event):

3> include a measurement reporting entry within the *VarMeasReportList* for this *measId*;

3> set the *numberOfReportsSent* defined within the *VarMeasReportList* for this *measId* to 0;

3> include the concerned cell(s) in the *cellsTriggeredList* defined within the *VarMeasReportList* for this *measId*;

3> initiate the measurement reporting procedure, as specified in 5.5.5;

...

2> upon expiry of the periodical reporting timer for this *measId*:

3> initiate the measurement reporting procedure, as specified in 5.5.5.

...

2> if *reportType* is set to *reportCGI*:

3> if the UE acquired the *SIB1* or *SystemInformationBlockType1* for the requested cell

...

4> stop timer T321;

4> include a measurement reporting entry within the *VarMeasReportList* for this *measId*;

4> set the *numberOfReportsSent* defined within the *VarMeasReportList* for this *measId* to 0;

4> initiate the measurement reporting procedure, as specified in 5.5.5;

2> upon the expiry of T321 for this *measId*:

3> include a measurement reporting entry within the *VarMeasReportList* for this *measId*;

3> set the *numberOfReportsSent* defined within the *VarMeasReportList* for this *measId* to 0;

3> initiate the measurement reporting procedure, as specified in 5.5.5.

[TS 38.331, clause 5.5.4.9]

The UE shall:

- 1> consider the entering condition for this event to be satisfied when both condition B2-1 and condition B2-2, as specified below, are fulfilled;
- 1> consider the leaving condition for this event to be satisfied when condition B2-3 or condition B2-4, i.e. at least one of the two, as specified below, is fulfilled;

Inequality B2-1 (Entering condition 1)

$$M_p + H_{ys} < Thresh1$$

Inequality B2-2 (Entering condition 2)

$$M_n + O_{fn} + O_{cn} - H_{ys} > Thresh2$$

Inequality B2-3 (Leaving condition 1)

$$M_p - H_{ys} > Thresh1$$

Inequality B2-4 (Leaving condition 2)

$$M_n + O_{fn} + O_{cn} + H_{ys} < Thresh2$$

The variables in the formula are defined as follows:

M_p is the measurement result of the PCell, not taking into account any offsets.

M_n is the measurement result of the inter-RAT neighbour cell, not taking into account any offsets.

O_{fn} is the measurement object specific offset of the frequency of the inter-RAT neighbour cell (i.e. *eutra-Q-OffsetRange* as defined within the *measObjectEUTRA* corresponding to the frequency of the inter-RAT neighbour cell).

O_{cn} is the cell specific offset of the inter-RAT neighbour cell (i.e. *cellIndividualOffset* as defined within the *measObjectEUTRA* corresponding to the neighbour inter-RAT cell), and set to zero if not configured for the neighbour cell.

H_{ys} is the hysteresis parameter for this event (i.e. *hysteresis* as defined within *reportConfigInterRAT* for this event).

Thresh1 is the threshold parameter for this event (i.e. *b2-Threshold1* as defined within *reportConfigInterRAT* for this event).

Thresh2 is the threshold parameter for this event (i.e. *b2-Threshold2EUTRA* as defined within *reportConfigInterRAT* for this event).

M_p is expressed in dBm in case of RSRP, or in dB in case of RSRQ and SINR.

M_n is expressed in dBm or dB, depending on the measurement quantity of the inter-RAT neighbour cell.

O_{fn}, ***O_{cn}***, ***H_{ys}*** are expressed in dB.

Thresh1 is expressed in the same unit as ***M_p***.

Thresh2 is expressed in the same unit as ***M_n***.

[TS 38.331, clause 5.5.5]



Figure 5.5.5.1-1: Measurement reporting

The purpose of this procedure is to transfer measurement results from the UE to the network. The UE shall initiate this procedure only after successful AS security activation.

For the *measId* for which the measurement reporting procedure was triggered, the UE shall set the *measResults* within the *MeasurementReport* message as follows:

- 1> set the *measId* to the measurement identity that triggered the measurement reporting;
- 1> for each serving cell configured with *servingCellMO*:
 - 2> if the *reportConfig* associated with the *measId* that triggered the measurement reporting includes *rsType*:
 - 3> if the serving cell measurements based on the *rsType* included in the *reportConfig* that triggered the measurement report are available:
 - 4> set the *measResultServingCell* within *measResultServingMOList* to include RSRP, RSRQ and the available SINR of the serving cell, derived based on the *rsType* included in the *reportConfig* that triggered the measurement report;
 - ...
- 1> set the *servCellId* within *measResultServingMOList* to include each NR serving cell that is configured with *servingCellMO*, if any;
- ...
- 1> if there is at least one applicable neighbouring cell to report:
 - 2> if the *reportType* is set to *eventTriggered* or *periodical*:
 - 3> set the *measResultNeighCells* to include the best neighbouring cells up to *maxReportCells* in accordance with the following:
 - 4> if the *reportType* is set to *eventTriggered*:
 - 5> include the cells included in the *cellsTriggeredList* as defined within the *VarMeasReportList* for this *measId*;
 - ...
 - 4> for each cell that is included in the *measResultNeighCells*, include the *physCellId*;
 - 4> if the *reportType* is set to *eventTriggered* or *periodical*:
 - 5> for each included cell, include the layer 3 filtered measured results in accordance with the *reportConfig* for this *measId*, ordered as follows:
 - ...
 - 6> if the *measObject* associated with this *measId* concerns E-UTRA:
 - 7> set the *measResult* to include the quantity(ies) indicated in the *reportQuantity* within the concerned *reportConfigInterRAT* in decreasing order of the sorting quantity, determined as specified in 5.5.5.3, i.e. the best cell is included first;

2> else:

...

3> if the cell indicated by *cellForWhichToReportCGI* is an E-UTRA cell:

4> if all mandatory fields of the *cgi-Info-EPC* for the concerned cell have been obtained:

5> include in the *cgi-Info-EPC* the fields broadcasted in E-UTRA *SystemInformationBlockType1* associated to EPC;

4> if the UE is E-UTRA/5GC capable and all mandatory fields of the *cgi-Info-5GC* for the concerned cell have been obtained:

5> include in the *cgi-Info-5GC* the fields broadcasted in E-UTRA *SystemInformationBlockType1* associated to 5GC;

4> if the mandatory present fields of the *cgi-Info* for the cell indicated by the *cellForWhichToReportCGI* in the associated *measObject* have been obtained:

5> include the *freqBandIndicator*;

5> if the cell broadcasts the *multiBandInfoList*, include the *multiBandInfoList*;

5> if the cell broadcasts the *freqBandIndicatorPriority*, include the *freqBandIndicatorPriority*;

1> increment the *numberOfReportsSent* as defined within the *VarMeasReportList* for this *measId* by 1;

1> stop the periodical reporting timer, if running;

1> if the *numberOfReportsSent* as defined within the *VarMeasReportList* for this *measId* is less than the *reportAmount* as defined within the corresponding *reportConfig* for this *measId*:

2> start the periodical reporting timer with the value of *reportInterval* as defined within the corresponding *reportConfig* for this *measId*;

...

1> else:

2> submit the *MeasurementReport* message to lower layers for transmission, upon which the procedure ends.

8.1.3.3.2.3 Test description

8.1.3.3.2.3.1 Pre-test conditions

System Simulator:

- NR Cell 1 is the PCell, E-UTRA Cell 1 is the inter-RAT neighbour cell of NR Cell 1.
- System information combination NR-6 as defined in TS 38.508-1 [4] clause 4.4.3.1.2.

UE:

- None.

Preamble:

- The UE is in state 3N-A as defined in TS 38.508-1 [4], subclause 4.4A.

8.1.3.3.2.3.2 Test procedure sequence

Table 8.1.3.3.2.3.2-1 and 8.1.3.3.2.3.2-2 illustrates the downlink power levels to be applied for NR Cell 1, and NR Cell 2 at various time instants of the test execution. Row marked "T0" denotes the conditions after the preamble, while the configuration marked "T1" is applied at the point indicated in the Main behaviour description in Table 8.1.3.3.2.3.2-3.

Table 8.1.3.3.2.3.2-1: Time instances of cell power level and parameter changes for FR1

	Parameter	Unit	NR Cell 1	E-UTRA Cell 1 (DL only)	Remark
T0	SS/PBCH SSS EPRE	dBm/S CS	-85	-	Power levels are such that entry condition for event B2 is not satisfied: $Mp + Hys < Thresh1$ and $Mn + Ofn + Ocn - Hys < Thresh2$
	Cell-specific RS EPRE	dBm/15 kHz	-	-91	
T1	SS/PBCH SSS EPRE	dBm/S CS	-85	-	Power levels are such that entry condition for event B2 is satisfied: $Mp + Hys < Thresh1$ and $Mn + Ofn + Ocn - Hys > Thresh2$
	Cell-specific RS EPRE	dBm/15 kHz	-	-79	

Table 8.1.3.3.2.3.2-2: Time instances of cell power level and parameter changes for FR2

	Parameter	Unit	NR Cell 1	E-UTRA Cell 1 (DL only)	Remark
T0	SS/PBCH SSS EPRE	dBm/S CS	FFS	-	Power levels are such that entry condition for event B2 is not satisfied: $Mp + Hys < Thresh1$ and $Mn + Ofn + Ocn - Hys < Thresh2$
	Cell-specific RS EPRE	dBm/15 kHz	-	FFS	
T1	SS/PBCH SSS EPRE	dBm/S CS	FFS	-	Power levels are such that entry condition for event B2 is satisfied: $Mp + Hys < Thresh1$ and $Mn + Ofn + Ocn - Hys > Thresh2$
	Cell-specific RS EPRE	dBm/15 kHz	-	FFS	

Table 8.1.3.3.2.3.2-3: Main behaviour

St	Procedure	Message Sequence		TP	Verdict
		U - S	Message		
1	The SS transmits an <i>RRCReconfiguration</i> message including <i>MeasConfig</i> to setup inter-RAT measurement and reporting for event B2.	<-	NR RRC: <i>RRCReconfiguration</i>	-	-
2	The UE transmits an <i>RRCReconfigurationComplete</i> message.	-->	NR RRC: <i>RRCReconfigurationComplete</i>	-	-
3	SS re-adjusts the cell-specific reference signal level according to row "T1" in table 8.1.3.3.2.3.2-1/2.	-	-	-	-
4	Check: Does the UE transmit a <i>MeasurementReport</i> message to report event B2 with the measured RSRP value for E-UTRA Cell 1?	-->	NR RRC: <i>MeasurementReport</i>	1	P
5	The SS transmits an <i>RRCConnectionReconfiguration</i> message including <i>measConfig</i> including <i>reportCGI</i> for E-UTRA Cell 1 and sufficient idle periods for UE to acquire the relevant system information from E-UTRA Cell 1	<-	NR RRC: <i>RRCReconfiguration</i>	-	-
6	The UE transmits an <i>RRCConnectionReconfigurationComplete</i> message.	-->	NR RRC: <i>RRCReconfigurationComplete</i>	-	-
7	Check: Does the UE transmit a <i>MeasurementReport</i> message with CGI of E-UTRA Cell 1 within 1 sec?	-->	NR RRC: <i>MeasurementReport</i>	2	P

8.1.3.3.2.3.3 Specific message contents

Table 8.1.3.3.2.3.3-1: RRCReconfiguration (step 1, Table 8.1.3.3.2.3.2-3)

Derivation Path: 38.508-1 [4] Table 4.6.1-13 with condition NR_MEAS

Table 8.1.3.3.2.3.3-2: CellGroupConfig-DRX (Table 8.1.3.3.2.3.3-1)

Derivation Path: TS 508-1 [4], Table 4.6.3-19 with condition MEAS			
Information Element	Value/remark	Comment	Condition
CellGroupConfig ::= SEQUENCE {			
mac-CellGroupConfig	MAC-CellGroupConfig	Table 8.1.3.3.2.3.3-9	
}			

Table 8.1.3.3.2.3.3-3: *MeasConfig-B2* (Table 8.1.3.3.2.3.3-1)

Derivation Path: 38.508-1 [4] Table 4.6.3-69			
Information Element	Value/remark	Comment	Condition
MeasConfig ::= SEQUENCE {			
measObjectToAddModList SEQUENCE (SIZE (1..maxNrofMeasId)) OF MeasObjectToAddMod {	2 entries		
MeasObjectToAddMod[1] SEQUENCE {		entry 1	
measObjectId	1		
measObject CHOICE {			
measObjectNR SEQUENCE {			
ssbFrequency	ssbFrequency IE equals the ARFCN for NR Cell 1		
absThreshSS-BlocksConsolidation	Not present		
}			
}			
}			
MeasObjectToAddMod[2] SEQUENCE {		entry 2	
measObjectId	2		
measObject CHOICE {			
measObjectEUTRA	MeasObjectEUTRA	MO for E-UTRA Cell 1	
}			
}			
}			
reportConfigToAddModList SEQUENCE (SIZE (1..maxReportConfigId)) OF ReportConfigToAddMod {	2 entries		
ReportConfigToAddMod[1] SEQUENCE {		entry 1	
reportConfigId	1		
reportConfig CHOICE {			
reportConfigInterRAT	ReportConfigInterRAT-B2	Table 8.1.3.3.2.3.3-4	
}			
}			
ReportConfigToAddMod[2] SEQUENCE {		entry 2	
reportConfigId	2		
reportConfig CHOICE {			
reportConfigInterRAT	ReportConfigInterRAT-CGI	Table 8.1.3.3.2.3.3-5	
}			
}			
measIdToAddModList SEQUENCE (SIZE (1..maxNrofMeasId)) OF MeasIdToAddMod {	1 entry		
MeasIdToAddMod[1] SEQUENCE {		entry 1	
measId	1		
measObjectId	2		
reportConfigId	1	reportConfigId for event B2	
}			
}			
quantityConfig	QuantityConfig with Condition INTER-RAT		
measGapConfig	MeasGapConfig		
}			

Table 8.1.3.3.2.3.3-4: ReportConfigInterRAT-B2 (Table 8.1.3.3.2.3.3-2)

Derivation Path: TS 38.508-1 [4] Table 4.6.3-141 with Condition EVENT_B2			
Information Element	Value/remark	Comment	Condition
ReportConfigInterRAT ::= SEQUENCE {			
reportType CHOICE {			
eventTriggered SEQUENCE {			
eventId CHOICE {			
eventB2 SEQUENCE {			
b2-Threshold1 CHOICE {			
rsrp	77	-79 dBm	FR1
	FFS		FR2
}			
b2-Threshold2EUTRA CHOICE {			
rsrp	56	-85dBm	
}			
}			
}			
reportAmount	r1		
}			
}			

Table 8.1.3.3.2.3.3-5: ReportConfigInterRAT-CGI (Table 8.1.3.3.2.3.3-2)

Derivation Path: TS 38.508-1 [4] Table 4.6.3-141 with Condition CGI			
Information Element	Value/remark	Comment	Condition
ReportConfigInterRAT ::= SEQUENCE {			
reportType CHOICE {			
reportCGI SEQUENCE {			
cellForWhichToReportCGI	EUTRA-PhysCellId of E-UTRA Cell 1		
}			
}			
}			

Table 8.1.3.3.2.3.3-6: RRCReconfiguration (step 5, Table 8.1.3.3.2.3.2-3)

Derivation Path: 38.508-1 [4] Table 4.6.1-13			
Information Element	Value/remark	Comment	Condition
RRCReconfiguration ::= SEQUENCE {			
criticalExtensions CHOICE {			
rrcReconfiguration SEQUENCE {			
measConfig	MeasConfig-CGI	Table 8.1.3.3.2.3.3-7	
nonCriticalExtension SEQUENCE {			
masterCellGroup	CellGroupConfig-DRX	Table 8.1.3.3.2.3.3-2	
}			
}			
}			
}			

Table 8.1.3.3.2.3.3-7: *MeasConfig-CGI* (Table 8.1.3.3.2.3.3-6)

Derivation Path: 38.508-1 [4] Table 4.6.3-69			
Information Element	Value/remark	Comment	Condition
MeasConfig ::= SEQUENCE {			
measObjectToAddModList	Not present		
reportConfigToAddModList	Not present		
measIdToAddModList SEQUENCE (SIZE (1..maxNrofMeasId)) OF MeasIdToAddMod {	1 entry		
MeasIdToAddMod[1] SEQUENCE {		entry 1	
measId	1		
measObjectId	2		
reportConfigId	2	reportConfigId for CGI measurement	
}			
}			
}			

Table 8.1.3.3.2.3.3-8: *MeasurementReport* (step 4 and step 7, Table 8.1.3.3.2.3.2-3)

Derivation Path: 38.508-1 [4] Table 4.6.1-5A			
Information Element	Value/remark	Comment	Condition
MeasurementReport ::= SEQUENCE {			
criticalExtensions CHOICE {			
measurementReport SEQUENCE {			
measResults SEQUENCE {			
measId	1		
measResultServingMOList SEQUENCE (SIZE (1..maxNrofServingCells)) OF MeasResultServMO {	1 entry		
MeasResultServMO[1] SEQUENCE {		entry 1	
servCellId	ServCellIndex of NR Cell 1		
measResultServingCell SEQUENCE {			
physCellId	Physical layer cell identity of NR Cell 1		
measResult SEQUENCE {			
cellResults SEQUENCE {			
resultsSSB-Cell	Not Checked		Step 7
resultsSSB-Cell SEQUENCE {			Step 4
rsrp	(0..127)		
rsrq	(0..127)		
sinr	Not present		
}			
}			
}			
}			
}			
measResultNeighCells CHOICE {			
measResultListEUTRA SEQUENCE (SIZE (1..maxCellReport)) OF MeasResultEUTRA {			
MeasResultEUTRA[1] SEQUENCE {		entry 1	
eutra-PhysCellId[1]	PhysCellId of E-UTRA Cell 1		
measResult[1] SEQUENCE {			
rsrp	(0..97)		Step 4
rsrq	Not present		Step 7
sinr	(0..34)		Step 4
}	Not present		Step 7
}	Not present		
}	Not present		Step 4
}			Step 7
}			
}			
}			

Table 8.1.3.3.2.3.3-9: MAC-CellGroupConfig

Derivation Path: TS 38.508-1 [4], Table 4.6.3-68 with Condition DRX			
Information Element	Value/remark	Comment	Condition
MAC-CellGroupConfig ::= SEQUENCE {			
drx-Config CHOICE {			
setup SEQUENCE {			
drx-InactivityTimer	ms100		
drx-LongCycleStartOffset CHOICE {			
ms640	0		
}			
}			
}			

8.1.4 Handover

8.1.4.1 Intra NR handover

8.1.4.1.1 Void

8.1.4.1.2 Intra NR handover / Success / Inter-frequency

8.1.4.1.2.1 Test Purpose (TP)

(1)

```
with { UE in NR RRC_CONNECTED state and having performed the inter-frequency measurements for the
neighbour cell }
ensure that {
  when { UE receives an RRCReconfiguration message including a reconfigurationWithSync with rach-
ConfigDedicated }
    then { UE performs handover to the target cell and transmits an RRCReconfigurationComplete
message }
}
```

(2)

```
with { UE in NR RRC_CONNECTED state and having performed the inter-frequency measurements for the
neighbour cell }
ensure that {
  when { UE receives an RRCReconfiguration message including a reconfigurationWithSync without rach-
ConfigDedicated }
    then { UE performs handover to the target cell and transmits an RRCReconfigurationComplete
message }
}
```

(3)

```
with { UE in NR RRC_CONNECTED state}
ensure that {
  when { UE receives an RRCReconfiguration message including dedicatedSIB1-Delivery containing SIB1
information with a change of trackingAreaCode }
    then { UE reads the updated SIB1 information and sends an RRCReconfigurationComplete message
followed by registration on the new tracking area }
}
```

(4)

```
with { UE in NR RRC_CONNECTED state }
ensure that {
  when { UE receives an RRCReconfiguration message including a reconfigurationWithSync and
keySetChangeIndicator set to 'true' in MasterKeyUpdate for handover to the target cell }
    then { UE performs handover to the target cell with security key update and transmits an
RRCReconfigurationComplete message }
}
```

}

8.1.4.1.2.2 Conformance requirements

References: The conformance requirements covered in the current TC are specified in: TS 38.331, clauses 5.3.5.3, 5.3.5.5.1, 5.3.5.5.2, 5.5.4.4, 5.2.2.4.2 and 5.3.5.7. Unless otherwise stated these are Rel-15 requirements.

[TS 38.331, clause 5.3.5.3]

The UE shall perform the following actions upon reception of the *RRCReconfiguration*:

...

1> if the *RRCReconfiguration* includes the *masterCellGroup*:

2> perform the cell group configuration for the received *masterCellGroup* according to 5.3.5.5;

1> if the *RRCReconfiguration* includes the *masterKeyUpdate*:

2> perform security key update procedure as specified in 5.3.5.7;

...

1> if the *RRCReconfiguration* message includes the *radioBearerConfig*:

2> perform the radio bearer configuration according to 5.3.5.6;

...

1> if the *RRCReconfiguration* message includes the *dedicatedSIB1-Delivery*:

2> perform the action upon reception of *SIB1* as specified in 5.2.2.4.2;

...1> if the *RRCReconfiguration* message includes the *measConfig*:

2> perform the measurement configuration procedure as specified in 5.5.2;

...

1> if *reconfigurationWithSync* was included in *spCellConfig* of an MCG or SCG, and when MAC of an NR cell group successfully completes a random access procedure triggered above;

2> stop timer T304 for that cell group;

2> apply the parts of the CQI reporting configuration, the scheduling request configuration and the sounding RS configuration that do not require the UE to know the SFN of the respective target SpCell, if any;

2> apply the parts of the measurement and the radio resource configuration that require the UE to know the SFN of the respective target SpCell (e.g. measurement gaps, periodic CQI reporting, scheduling request configuration, sounding RS configuration), if any, upon acquiring the SFN of that target SpCell;

2> if the *reconfigurationWithSync* was included in *spCellConfig* of an MCG:

3> if T390 is running:

4> stop timer T390 for all access categories;

4> perform the actions as specified in 5.3.14.4.

3> if *RRCReconfiguration* does not include *dedicatedSIB1-Delivery* and

3> if the active downlink BWP, which is indicated by the *firstActiveDownlinkBWP-Id* for the target SpCell of the MCG, has a common search space configured by *searchSpaceSIB1*:

4> acquire the *SIB1*, which is scheduled as specified in TS 38.213 [13], of the target SpCell of the MCG;

4> upon acquiring *SIB1*, perform the actions specified in clause 5.2.2.4.2;

2> the procedure ends.

NOTE: The UE is only required to acquire broadcasted *SIB1* if the UE can acquire it without disrupting unicast data reception, i.e. the broadcast and unicast beams are quasi co-located.

[TS 38.331, clause 5.3.5.5.1]

The network configures the UE with Master Cell Group (MCG), and zero or one Secondary Cell Group (SCG). In (NG)EN-DC, the MCG is configured as specified in TS 36.331 [10], and for NE-DC, the SCG is configured as specified in TS 36.331 [10]. The network provides the configuration parameters for a cell group in the *CellGroupConfig* IE.

The UE performs the following actions based on a received *CellGroupConfig* IE:

- 1> if the *CellGroupConfig* contains the *spCellConfig* with *reconfigurationWithSync*:
 - 2> perform Reconfiguration with sync according to 5.3.5.5.2;
 - 2> resume all suspended radio bearers and resume SCG transmission for all radio bearers, if suspended;
- ...
- 1> if the *CellGroupConfig* contains the *mac-CellGroupConfig*:
 - 2> configure the MAC entity of this cell group as specified in 5.3.5.5.5;
- ...
- 1> if the *CellGroupConfig* contains the *spCellConfig*:
 - 2> configure the SpCell as specified in 5.3.5.5.7;

[TS 38.331, clause 5.3.5.5.2]

The UE shall perform the following actions to execute a reconfiguration with sync.

- 1> if the security is not activated, perform the actions upon going to RRC_IDLE as specified in 5.3.11 with the release cause 'other' upon which the procedure ends;
 - 1> stop timer T310 for the corresponding SpCell, if running;
 - 1> start timer T304 for the corresponding SpCell with the timer value set to *t304*, as included in the *reconfigurationWithSync*;
 - 1> if the *frequencyInfoDL* is included:
 - 2> consider the target SpCell to be one on the SSB frequency indicated by the *frequencyInfoDL* with a physical cell identity indicated by the *physCellId*;
 - 1> else:
 - 2> consider the target SpCell to be one on the SSB frequency of the source SpCell with a physical cell identity indicated by the *physCellId*;
 - 1> start synchronising to the DL of the target SpCell;
 - 1> apply the specified BCCH configuration defined in 9.1.1.1;
 - 1> acquire the *MIB*, which is scheduled as specified in TS 38.213 [13];
- NOTE 1: The UE should perform the reconfiguration with sync as soon as possible following the reception of the RRC message triggering the reconfiguration with sync, which could be before confirming successful reception (HARQ and ARQ) of this message.
- NOTE 2: The UE may omit reading the *MIB* if the UE already has the required timing information, or the timing information is not needed for random access.
- 1> reset the MAC entity of this cell group;

- 1> consider the SCell(s) of this cell group, if configured, to be in deactivated state;
- 1> apply the value of the *newUE-Identity* as the C-RNTI for this cell group;
- 1> configure lower layers in accordance with the received *spCellConfigCommon*;
- 1> configure lower layers in accordance with any additional fields, not covered in the previous, if included in the received *reconfigurationWithSync*.

[TS 38.331, clause 5.5.4.4]

The UE shall:

- 1> consider the entering condition for this event to be satisfied when condition A3-1, as specified below, is fulfilled;
- 1> consider the leaving condition for this event to be satisfied when condition A3-2, as specified below, is fulfilled;
- 1> use the SpCell for *Mp*, *Ofp* and *Ocp*.

NOTE The cell(s) that triggers the event has reference signals indicated in the *measObjectNR* associated to this event which may be different from the NR SpCell *measObjectNR*.

Inequality A3-1 (Entering condition)

$$Mn + Ofn + Ocn - Hys > Mp + Ofp + Ocp + Off$$

Inequality A3-2 (Leaving condition)

$$Mn + Ofn + Ocn + Hys < Mp + Ofp + Ocp + Off$$

The variables in the formula are defined as follows:

Mn is the measurement result of the neighbouring cell, not taking into account any offsets.

Ofn is the measurement object specific offset of the reference signal of the neighbour cell (i.e. *offsetMO* as defined within *measObjectNR* corresponding to the neighbour cell).

Ocn is the cell specific offset of the neighbour cell (i.e. *cellIndividualOffset* as defined within *measObjectNR* corresponding to the frequency of the neighbour cell), and set to zero if not configured for the neighbour cell.

Mp is the measurement result of the SpCell, not taking into account any offsets.

Ofp is the measurement object specific offset of the SpCell (i.e. *offsetMO* as defined within *measObjectNR* corresponding to the SpCell).

Ocp is the cell specific offset of the SpCell (i.e. *cellIndividualOffset* as defined within *measObjectNR* corresponding to the SpCell), and is set to zero if not configured for the SpCell.

Hys is the hysteresis parameter for this event (i.e. *hysteresis* as defined within *reportConfigNR* for this event).

Off is the offset parameter for this event (i.e. *a3-Offset* as defined within *reportConfigNR* for this event).

Mn*, *Mp are expressed in dBm in case of RSRP, or in dB in case of RSRQ and RS-SINR.

Ofn*, *Ocn*, *Ofp*, *Ocp*, *Hys*, *Off are expressed in dB.

[TS 38.331, clause 5.2.2.4.2]

Upon receiving the *SIB1* the UE shall:

- 1> store the acquired *SIB1*;
- 1> if the *cellAccessRelatedInfo* contains an entry with the *PLMN-Identity* of the selected PLMN:
 - 2> in the remainder of the procedures use *plmn-IdentityList*, *trackingAreaCode*, and *cellIdentity* for the cell as received in the corresponding *PLMN-IdentityInfo* containing the selected PLMN;
- 1> if in RRC_CONNECTED while T311 is not running:

- 2> disregard the *frequencyBandList*, if received, while in RRC_CONNECTED;
- 2> forward the *cellIdentity* to upper layers;
- 2> forward the *trackingAreaCode* to upper layers;
- 2> apply the configuration included in the *-servingCellConfigCommonSIB*;

[TS 38.331, clause 5.3.5.7]

The UE shall:

- 1> if UE is connected to E-UTRA/EPC:
 - 2> upon reception of *sk-Counter* as specified in TS 36.331 [10]:
 - 3> update the $S\text{-}K_{gNB}$ key based on the K_{eNB} key and using the received *sk-Counter* value, as specified in TS 33.401 [30];
 - 3> derive the K_{RRCEnc} and K_{UPenc} keys as specified in TS 33.401 [30];
 - 3> derive the K_{RRCint} and K_{UPint} keys as specified in TS 33.401 [30].
 - 1> else:
 - 2> if the *nas-Container* is included in the received *masterKeyUpdate*:
 - 3> forward the *nas-Container* to the upper layers;
 - 2> if the *keySetChangeIndicator* is set to true:
 - 3> derive or update the K_{gNB} key based on the K_{AMF} key, as specified in TS 33.501 [11];
 - 2> else:
 - 3> derive or update the K_{gNB} key based on the current K_{gNB} key or the NH, using the *nextHopChainingCount* value indicated in the received *masterKeyUpdate*, as specified in TS 33.501 [11];
 - 2> store the *nextHopChainingCount* value;
 - 2> derive the keys associated with the K_{gNB} key as follows:
 - 3> if the *securityAlgorithmConfig* is included in *SecurityConfig*:
 - 4> derive the K_{RRCEnc} and K_{UPenc} keys associated with the *cipheringAlgorithm* indicated in the *securityAlgorithmConfig*, as specified in TS 33.501 [11];
 - 4> derive the K_{RRCint} and K_{UPint} keys associated with the *integrityProtAlgorithm* indicated in the *securityAlgorithmConfig*, as specified in TS 33.501 [11];
 - 3> else:
 - 4> derive the K_{RRCEnc} and K_{UPenc} keys associated with the current *cipheringAlgorithm*, as specified in TS 33.501 [11];
 - 4> derive the K_{RRCint} and K_{UPint} keys associated with the current *integrityProtAlgorithm*, as specified in TS 33.501 [11].

NOTE: Ciphering and integrity protection are optional to configure for the DRBs.

8.1.4.1.2.3 Test description

8.1.4.1.2.3.1 Pre-test conditions

System Simulator:

- NR Cell 1 is the serving cell and NR Cell 3 is the inter-frequency neighbour cell of NR Cell 1.

- System information combination NR-4 as defined in TS 38.508-1 [4] clause 4.4.3.1.2 is used in NR cells.

UE:

- None.

Preamble:

- If `pc_IP_Ping` is set to TRUE then, the UE is in 5GS state 3N-A according to TS 38.508-1 [4], clause 4.4A.2 Table 4.4A.2-3.
- Else, the UE is in 5GS state 3N-A and Test Loop Function (*On*) with UE test loop mode B on NR Cell 1 according to 38.508-1[4], clause 4.4A.2 Table 4.4A.2-3.

8.1.4.1.2.3.2 Test procedure sequence

Tables 8.1.4.1.2.3.2-1 and 8.1.4.1.2.3.2-2 illustrate the downlink power levels to be applied for NR Cell 1 and NR Cell 3 at various time instants of the test execution. Row marked "T0" denotes the conditions after the preamble, while the configuration marked "T1", T2 and "T3", are applied at the point indicated in the Main behaviour description in Table 8.1.4.1.2.3.2-3.

Table 8.1.4.1.2.3.2-1: Power levels in FR1

	Parameter	Unit	NR Cell 1	NR Cell 3	Remark
T0	SS/PBCH SSS EPRE	dBm/ SCS	-85	-91	Power levels are such that entry condition for event A3 is not satisfied
T1	SS/PBCH SSS EPRE	dBm/ SCS	-85	-79	Power levels are such that entry condition for event A3 is satisfied for NR Cell 3
T2	SS/PBCH SSS EPRE	dBm/ SCS	-79	-85	Power levels are such that entry condition for event A3 is satisfied for NR Cell 1
T3	SS/PBCH SSS EPRE	dBm/ SCS	-88	-78	

Table 8.1.4.1.2.3.2-2: Power levels in FR2

	Parameter	Unit	NR Cell 1	NR Cell 3	Remark
T0	SS/PBCH SSS EPRE	dBm/ SCS	FFS	FFS	Power levels are such that entry condition for event A3 is not satisfied
T1	SS/PBCH SSS EPRE	dBm/ SCS	FFS	FFS	Power levels are such that entry condition for event A3 is satisfied for NR Cell 3
T2	SS/PBCH SSS EPRE	dBm/ SCS	FFS	FFS	Power levels are such that entry condition for event A3 is satisfied for NR Cell 1
T3	SS/PBCH SSS EPRE	dBm/ SCS	FFS	FFS	

Table 8.1.4.1.2.3.2-3: Main behaviour

St	Procedure	Message Sequence		TP	Verdict
		U - S	Message		
1	The SS transmits an <i>RRCReconfiguration</i> message including <i>MeasConfig</i> to setup intra NR measurement and reporting for inter-frequency event A3.	<--	NR RRC: <i>RRCReconfiguration</i>	-	-
2	The UE transmits an <i>RRCReconfigurationComplete</i> message.	-->	NR RRC: <i>RRCReconfigurationComplete</i>	-	-
3	SS adjusts the cell-specific reference signal level according to row "T1".	-	-	-	-
4	Check: Does the UE transmit a <i>MeasurementReport</i> message to report event A3 with the measured RSRP value for NR Cell 3?	-->	NR RRC: <i>MeasurementReport</i>	-	-
5	The SS transmits an <i>RRCReconfiguration</i> message including <i>reconfigurationWithSync</i> with <i>rach-ConfigDedicated</i> , <i>keySetChangeIndicator</i> set to <i>true</i> and including nas-Container IE to order the UE to perform inter-frequency handover to NR Cell 3	<--	NR RRC: <i>RRCReconfiguration</i>	-	-
6	Check: Does the UE transmit <i>RRCReconfigurationComplete</i> message in NR Cell 3?	-->	NR RRC: <i>RRCReconfigurationComplete</i>	1, 4	P
6A	Check: Does the test result of generic test procedure in TS 38.508-1 subclause 4.9.1 indicate that the UE is capable of exchanging IP data on DRB #n associated with the first PDU session on NR Cell 3?	-	-	1,4	-
7	The SS transmits an <i>RRCReconfiguration</i> message including <i>MeasConfig</i> to setup intra NR measurement and reporting for inter-frequency event A3.	<--	NR RRC: <i>RRCReconfiguration</i>	-	-
8	The UE transmits an <i>RRCReconfigurationComplete</i> message.	-->	NR RRC: <i>RRCReconfigurationComplete</i>	-	-
9	SS adjusts the cell-specific reference signal level according to row "T2".	-	-	-	-
10	Check: Does the UE transmit a <i>MeasurementReport</i> message to report event A3 with the measured RSRP value for NR Cell 1?	-->	NR RRC: <i>MeasurementReport</i>	-	-
11	The SS transmits an <i>RRCReconfiguration</i> message including <i>reconfigurationWithSync</i> without <i>rach-ConfigDedicated</i> , <i>keySetChangeIndicator</i> set to <i>true</i> and including nas-Container IE to order the UE to perform inter-frequency handover to NR Cell 1	<--	NR RRC: <i>RRCReconfiguration</i>	-	-
12	Check: Does the UE transmit <i>RRCReconfigurationComplete</i> message in NR Cell 1?	-->	NR RRC: <i>RRCReconfigurationComplete</i>	2, 4	P
12 A	Check: Does the test result of generic test procedure in TS 38.508-1 subclause 4.9.1 indicate that the UE is capable of exchanging IP data on DRB #n associated with the first PDU session on NR Cell 1?	-	-	2,4	-
13	SS adjusts the cell-specific reference signal level according to row "T3".	-	-	-	-
14	The SS transmits an <i>RRCReconfiguration</i> including <i>dedicatedSIB1-Delivery</i> containing SIB1 of NR Cell 3 to order the UE to perform handover to NR Cell 3.	<--	NR RRC: <i>RRCReconfiguration</i>	-	-
15	Check: Does the UE transmit an <i>RRCReconfigurationComplete</i> message on NR Cell 3?	-->	NR RRC: <i>RRCReconfigurationComplete</i>	3	P
16	Check: Does UE transmit a REGISTRATION REQUEST message to update the registration of the actual tracking area?	-->	NR RRC: <i>ULInformationTransfer</i> 5GMM: REGISTRATION REQUEST	3	P

17	SS responds with REGISTRATION ACCEPT message.	<-	NR RRC: <i>DLInformationTransfer</i> 5GMM: REGISTRATION ACCEPT	-	-
18	The UE send a REGISTRATION COMPLETE message.	-->	NR RRC: <i>ULInformationTransfer</i> 5GMM: REGISTRATION COMPLETE	-	-
19	Check: Does the test result of generic test procedure in TS 38.508-1 subclause 4.9.1 indicate that the UE is capable of exchanging IP data on DRB #n associated with the first PDU session on NR Cell 3?	-	-	3	-

8.1.4.1.2.3.3 Specific message contents

Table 8.1.4.1.2.3.3-1: RRCReconfiguration (step 1, Table 8.1.4.1.2.3.2-3)

Derivation Path: 38.508-1 [4] Table 4.6.1-13 with condition MEAS
--

Table 8.1.4.1.2.3.3-2: *MeasConfig* (Table 8.1.4.1.2.3.3-1)

Derivation Path: 38.508-1 [4] Table 4.6.3-69			
Information Element	Value/remark	Comment	Condition
MeasConfig ::= SEQUENCE {			
measObjectToAddModList SEQUENCE (SIZE (1..maxNrofMeasId)) OF MeasObjectToAddMod {	2 entries		
MeasObjectToAddMod[1] SEQUENCE {		entry 1	
measObjectId	1		
measObject CHOICE {			
measObjectNR SEQUENCE {			
ssbFrequency	ssbFrequency IE equals the ARFCN for NR Cell 3		
absThreshSS-BlocksConsolidation	Not present		
}			
}			
MeasObjectToAddMod[2] SEQUENCE {		entry 2	
measObjectId	2		
measObject CHOICE {			
measObjectNR SEQUENCE {			
ssbFrequency	ssbFrequency IE equals the ARFCN for NR Cell 1		
absThreshSS-BlocksConsolidation	Not present		
}			
}			
}			
reportConfigToAddModList SEQUENCE(SIZE (1..maxReportConfigId)) OF ReportConfigToAddMod {	1 entry		
ReportConfigToAddMod[1] SEQUENCE {		entry 1	
reportConfigId	1		
reportConfig CHOICE {			
reportConfigNR	ReportConfigNR-EventA3		
}			
}			
}			
measIdToAddModList SEQUENCE (SIZE (1..maxNrofMeasId)) OF MeasIdToAddMod {	1 entry		
MeasIdToAddMod[1] SEQUENCE {		entry 1	
measId	1		
measObjectId	1		
reportConfigId	1		
}			
}			
measGapConfig	MeasGapConfig		
}			

Table 8.1.4.1.2.3.3-3: ReportConfigNR-EventA3 (Table 8.1.4.1.2.3.3-2 and Table 8.1.4.1.2.3.3-8)

Derivation Path: 38.508-1 [4] Table 4.6.3-142 with condition EVENT_A3			
Information Element	Value/remark	Comment	Condition
ReportConfigNR ::= SEQUENCE {			
reportType CHOICE {			
eventTriggered SEQUENCE {			
eventId CHOICE {			
eventA3 SEQUENCE {			EVENT_A3
a3-Offset CHOICE {			
rsrp	6	3dB	FR1
	FFS		FR2
}			
hysteresis	0	0 dB	
timeToTrigger	ms640		
}			
}			
reportAmount	r1		
reportQuantityCell SEQUENCE {			
rsrp	true		
rsrq	false		
sinr	false		
}			
}			
}			
}			

Table 8.1.4.1.2.3.3-4: MeasurementReport (step 4, Table 8.1.4.1.2.3.2-3)

Derivation Path: 38.508-1 [4] Table 4.6.1-5A			
Information Element	Value/remark	Comment	Condition
MeasurementReport ::= SEQUENCE {			
criticalExtensions CHOICE {			
measurementReport SEQUENCE {			
measResults SEQUENCE {			
measId	1		
measResultServingMOList SEQUENCE (SIZE (1..maxNrofServingCells)) OF MeasResultServMO {	1 entry		
MeasResultServMO[1] SEQUENCE {		entry 1	
servCellId	Cell index corresponding to NR Cell 1		
measResultServingCell SEQUENCE {			
physCellId	Physical layer cell identity of NR Cell 1		
}			
}			
}			
measResultNeighCells CHOICE {			
measResultListNR SEQUENCE (SIZE (1..maxCellReport)) OF MeasResultNR {	1 entry		
MeasResultNR[1] SEQUENCE {		entry 1	
physCellId	Physical layer cell identity of NR Cell 3		
measResult SEQUENCE {			
cellResults SEQUENCE {			
resultsSSB-Cell SEQUENCE {			
rsrp	(0..127)		
}			
resultsCSI-RS-Cell	Not present		
}			
rsIndexResults	Not present		
}			
}			
}			
}			
}			
}			

Table 8.1.4.1.2.3.3-5: *RRCReconfiguration* (step 5, Table 8.1.4.1.2.3.2-3)

Derivation Path: 38.508-1 [4] Table 4.8.1-1A with condition RBCConfig_KeyChange			
Information Element	Value/remark	Comment	Condition
RRCReconfiguration ::= SEQUENCE {			
criticalExtensions CHOICE {			
rrcReconfiguration SEQUENCE {			
nonCriticalExtension SEQUENCE {			
measConfig SEQUENCE {			
measObjectToRemoveList SEQUENCE (SIZE (1..maxNrofObjectId)) OF MeasObjectId {	2 entries		
measObjectId[1]	1	entry 1	
measObjectId[2]	2	entry 2	
}			
measIdToRemoveList SEQUENCE (SIZE (1..maxNrofMeasId)) OF MeasId {	1 entry		
measId[1]	1	entry 1	
}			
}			
masterCellGroup	OCTET STRING (CONTAINING CellGroupConfig)		
masterKeyUpdate SEQUENCE {			
keySetChangeIndicator	True		
nextHopChainingCount	0		
nas-Container	NASContainer	Intra N1 mode NAS transparent container	
}			
}			
}			
}			
}			
}			

Table 8.1.4.1.2.3.3-6: *CellGroupConfig* (Table 8.1.4.1.2.3.3-5)

Derivation Path: 38.508-1 [4], Table 4.6.3-19 with condition PCell_change and CFRA			
Information Element	Value/remark	Comment	Condition
CellGroupConfig ::= SEQUENCE {			
spCellConfig SEQUENCE {			
reconfigurationWithSync SEQUENCE {			
spCellConfigCommon SEQUENCE {	Same as default ServingCellConfigCommon		
physCellId	Physical cell Id of NR Cell 3		
}			
rach-ConfigDedicated CHOICE {			
Uplink	RACH-ConfigDedicated		
}			
}			
}			
}			

Table 8.1.4.1.2.3.3-6A: NASContainer (Table 8.1.4.1.2.3.3-5, Table 8.1.4.1.2.3.3-10)

Derivation Path: TS 24.501, table 9.11.2.6			
Information Element	Value/Remark	Comment	Condition
Message authentication code	The calculated value of MAC-I for this message.	The value of MAC-I is calculated by SS using COUNT = 0xFFFFFFFF (as per TS 33.501[20], 6.9.2.3.3)	
Type of ciphering algorithm	Set according to PIXIT px_NAS_5GC_Ciphering Algorithm for default ciphering algorithm		
Type of integrity protection algorithm	Set according to PIXIT px_NAS_5GC_IntegrityAlgorithm for default integrity protection algorithm	This value should not be equal to the null integrity algorithm.	
KACF	'1'B	a new K _{AMF} has been calculated by the network	
TSC	'0'B	native security context (for KSI _{AMF})	
Key set identifier in 5G	KSI _{AMF} that was created when the UE last registered to 5GCN		
Sequence number	The internal counter of the SS	eight least significant bits of the downlink NAS COUNT	

Table 8.1.4.1.2.3.3-7: RRCReconfiguration (step 7, Table 8.1.4.1.2.3.2-3)

Derivation Path: 38.508-1 [4] Table 4.6.1-13 with condition MEAS			
--	--	--	--

Table 8.1.4.1.2.3.3-8: *MeasConfig* (Table 8.1.4.1.2.3.3-7)

Derivation Path: 38.508-1 [4] Table 4.6.3-69			
Information Element	Value/remark	Comment	Condition
MeasConfig ::= SEQUENCE {			
measObjectToAddModList SEQUENCE (SIZE (1..maxNrofMeasId)) OF MeasObjectToAddMod {	2 entries		
MeasObjectToAddMod[1] SEQUENCE {		entry 1	
measObjectId	1		
measObject CHOICE {			
measObjectNR SEQUENCE {			
ssbFrequency	ssbFrequency IE equals the ARFCN for NR Cell 1		
absThreshSS-BlocksConsolidation	Not present		
}			
}			
}			
MeasObjectToAddMod[2] SEQUENCE {		entry 2	
measObjectId	2		
measObject CHOICE {			
measObjectNR SEQUENCE {			
ssbFrequency	ssbFrequency IE equals the ARFCN for NR Cell 3		
absThreshSS-BlocksConsolidation	Not present		
}			
}			
}			
reportConfigToAddModList SEQUENCE(SIZE (1..maxReportConfigId)) OF ReportConfigToAddMod {	1 entry		
ReportConfigToAddMod[1] SEQUENCE {		entry 1	
reportConfigId	1		
reportConfig CHOICE {			
reportConfigNR	ReportConfigNR-EventA3		
}			
}			
measIdToAddModList SEQUENCE (SIZE (1..maxNrofMeasId)) OF MeasIdToAddMod {	1 entry		
MeasIdToAddMod[1] SEQUENCE {		entry 1	
measId	1		
measObjectId	1		
reportConfigId	1		
}			
}			
}			

Table 8.1.4.1.2.3.3-9: MeasurementReport (step 10, Table 8.1.4.1.2.3.2-3)

Derivation Path: 38.508-1 [4] Table 4.6.1-5A			
Information Element	Value/remark	Comment	Condition
MeasurementReport ::= SEQUENCE {			
criticalExtensions CHOICE {			
measurementReport SEQUENCE {			
measResults SEQUENCE {			
measId	1		
measResultServingMOList SEQUENCE (SIZE (1..maxNrofServingCells)) OF MeasResultServMO {	1 entry		
MeasResultServMO[1] SEQUENCE {		entry 1	
servCellId	Cell index corresponding to NR Cell 3		
measResultServingCell SEQUENCE {			
physCellId	Physical layer cell identity of NR Cell 3		
}			
}			
}			
measResultNeighCells CHOICE {			
measResultListNR SEQUENCE (SIZE (1..maxCellReport)) OF MeasResultNR {	1 entry		
MeasResultNR[1] SEQUENCE {		entry 1	
physCellId	Physical layer cell identity of NR Cell 1		
measResult SEQUENCE {			
cellResults SEQUENCE {			
resultsSSB-Cell SEQUENCE {			
Rsrp	(0..127)		
}			
resultsCSI-RS-Cell	Not present		
}			
rsIndexResults	Not present		
}			
}			
}			
}			
}			
}			

Table 8.1.4.1.2.3.3-10: RRCReconfiguration (step 11, Table 8.1.4.1.2.3.2-3)

Derivation Path: 38.508-1 [4] Table 4.8.1-1A with condition RBCConfig_KeyChange			
Information Element	Value/remark	Comment	Condition
RRCReconfiguration ::= SEQUENCE {			
criticalExtensions CHOICE {			
rrcReconfiguration SEQUENCE {			
nonCriticalExtension SEQUENCE {			
measConfig SEQUENCE {			
measObjectToRemoveList SEQUENCE (SIZE (1..maxNrofObjectld)) OF MeasObjectld {	2 entries		
measObjectld[1]	1	entry 1	
measObjectld[2]	2	entry 2	
}			
measldToRemoveList SEQUENCE (SIZE (1..maxNrofMeasld)) OF Measld {	1 entry		
measld[1]	1	entry 1	
}			
}			
masterCellGroup	OCTET STRING (CONTAINING CellGroupConfig)		
masterKeyUpdate SEQUENCE {			
keySetChangeIndicator	True		
nextHopChainingCount	0		
nas-Container	NASContainer	Intra N1 mode NAS transparent container	
}			
}			
}			
}			
}			

Table 8.1.4.1.2.3.3-11: CellGroupConfig (Table 8.1.4.1.2.3.3-10)

Derivation Path: 38.508-1 [4], Table 4.6.3-19 with condition PCell_change			
Information Element	Value/remark	Comment	Condition
CellGroupConfig ::= SEQUENCE {			
spCellConfig SEQUENCE {			
reconfigurationWithSync SEQUENCE {			
spCellConfigCommon SEQUENCE {	Same as default ServingCellConfigCommon		
physCellld	Physical cell Id of NR Cell 1		
}			
rach-ConfigDedicated	Not Present		
}			
}			
}			

Table 8.1.4.1.2.3.3-12: RRCReconfiguration (step 14 Table 8.1.4.1.2.3.2-3)

Derivation Path: 38.508-1 [4], Table 4.8.1-1A with condition RBConfig_NoKeyChange			
Information Element	Value/remark	Comment	Condition
RRCReconfiguration ::= SEQUENCE {			
criticalExtensions CHOICE {			
rrcReconfiguration SEQUENCE {			
nonCriticalExtension SEQUENCE {			
dedicatedSIB1-Delivery	SIB1	OCTET STRING (CONTAINING SIB1)	
}			
}			
}			
}			

Table 8.1.4.1.2.3.3-13: SIB1 (Table 8.1.4.1.2.3.3-12)

Derivation Path: 38.508-1 [4], Table 4.6.1-28			
Information Element	Value/remark	Comment	Condition
SIB1 ::= SEQUENCE {			
cellAccessRelatedInfo SEQUENCE {			
plmn-IdentityList SEQUENCE (SIZE (1..maxPLMN)) OF PLMN-Identity {	1 entry		
plmn-Identity[1]		entry 1	
trackingAreaCode	2		
}			
}			
}			
}			

8.1.4.1.3 Void

8.1.4.1.4 Void

8.1.4.1.5 Intra NR handover / Failure / Re-establishment successful

8.1.4.1.5.1 Test Purpose (TP)

(1)

```
with { UE in NR RRC_CONNECTED state and having received an RRCReconfiguration message including a
reconfigurationWithSync for handover to the target cell }
ensure that {
  when { UE detects handover failure and the initial cell is selectable }
  then { UE performs an RRCReestablishment procedure on the source cell }
}
```

(2)

```
with { UE detects handover failure and having transmitted an RRCReestablishmentRequest message }
ensure that {
  when { UE receives an RRCReestablishment message with a nextHopChainingCount which is different
from the NCC associated with the currently active KgNB }
  then { UE derives new KgNB from the nextHopChainingCount and completes RRCReestablishment
procedure on the source cell }
}
```

(3)

```
with { UE detects handover failure and having transmitted an RRCReestablishmentRequest message }
ensure that {
```

```

when { UE receives an RRCreestablishment message with a nextHopChainingCount which is same as the
NCC associated with the currently active KgNB }
  then { UE derives new KgNB from the currently active KgNB and completes RRCreestablishment
procedure on the source cell }
}

```

8.1.4.1.5.2 Conformance requirements

References: The conformance requirements covered in the present test case are specified in: TS 38.331, clauses 5.3.5.5.2, 5.3.5.7, 5.3.5.8.3 and 5.3.7.5. Unless otherwise stated these are Rel-15 requirements.

[TS 38.331, clause 5.3.5.5.2]

The UE shall perform the following actions to execute a reconfiguration with sync.

- 1> if the AS security is not activated, perform the actions upon going to RRC_IDLE as specified in 5.3.11 with the release cause 'other' upon which the procedure ends;
- 1> stop timer T310 for the corresponding SpCell, if running;
- 1> start timer T304 for the corresponding SpCell with the timer value set to *t304*, as included in the *reconfigurationWithSync*;
- 1> if the *frequencyInfoDL* is included:
 - 2> consider the target SpCell to be one on the SSB frequency indicated by the *frequencyInfoDL* with a physical cell identity indicated by the *physCellId*;
- 1> else:
 - 2> consider the target SpCell to be one on the SSB frequency of the source SpCell with a physical cell identity indicated by the *physCellId*;
- 1> start synchronising to the DL of the target SpCell;
- 1> apply the specified BCCH configuration defined in 9.1.1.1;
- 1> acquire the *MIB*, which is scheduled as specified in TS 38.213 [13];

NOTE 1: The UE should perform the reconfiguration with sync as soon as possible following the reception of the RRC message triggering the reconfiguration with sync, which could be before confirming successful reception (HARQ and ARQ) of this message.

NOTE 2: The UE may omit reading the *MIB* if the UE already has the required timing information, or the timing information is not needed for random access.

- 1> reset the MAC entity of this cell group;
- 1> consider the SCell(s) of this cell group, if configured, to be in deactivated state;
- 1> apply the value of the *newUE-Identity* as the C-RNTI for this cell group;
- 1> configure lower layers in accordance with the received *spCellConfigCommon*;
- 1> configure lower layers in accordance with any additional fields, not covered in the previous, if included in the received *reconfigurationWithSync*.

[TS 38.331, clause 5.3.5.7]

The UE shall:

...

- 1> else:
 - 2> if the *nas-Container* is included in the received *masterKeyUpdate*:
 - 3> forward the *nas-Container* to the upper layers;

- 2> if the *keySetChangeIndicator* is set to *true*:
 - 3> derive or update the K_{gNB} key based on the K_{AMF} key, as specified in TS 33.501 [11];
- 2> else:
 - 3> derive or update the K_{gNB} key based on the current K_{gNB} key or the NH, using the *nextHopChainingCount* value indicated in the received *masterKeyUpdate*, as specified in TS 33.501 [11];
- 2> store the *nextHopChainingCount* value;
- 2> derive the keys associated with the K_{gNB} key as follows:
 - 3> if the *securityAlgorithmConfig* is included in *SecurityConfig*:
 - 4> derive the K_{RRcenc} and K_{UPenc} keys associated with the *cipheringAlgorithm* indicated in the *securityAlgorithmConfig*, as specified in TS 33.501 [11];
 - 4> derive the K_{RRcint} and K_{UPint} keys associated with the *integrityProtAlgorithm* indicated in the *securityAlgorithmConfig*, as specified in TS 33.501 [11];
 - 3> else:
 - 4> derive the K_{RRcenc} and K_{UPenc} keys associated with the current *cipheringAlgorithm*, as specified in TS 33.501 [11];
 - 4> derive the K_{RRcint} and K_{UPint} keys associated with the current *integrityProtAlgorithm*, as specified in TS 33.501 [11].

NOTE: Ciphering and integrity protection are optional to configure for the DRBs.

[TS 38.331, clause 5.3.5.8.3]

The UE shall:

- 1> if T304 of the MCG expires:
 - 2> release dedicated preambles provided in *rach-ConfigDedicated* if configured;
 - 2> revert back to the UE configuration used in the source PCell;
 - 2> initiate the connection re-establishment procedure as specified in subclause 5.3.7.

NOTE 1: In the context above, "the UE configuration" includes state variables and parameters of each radio bearer.

- 1> else if T304 of a secondary cell group expires:
 - 2> release dedicated preambles provided in *rach-ConfigDedicated*, if configured;
 - 2> initiate the SCG failure information procedure as specified in subclause 5.7.3 to report SCG reconfiguration with sync failure, upon which the RRC reconfiguration procedure ends;
- 1> else if T304 expires when *RRCReconfiguration* is received via other RAT (HO to NR failure):
 - 2> reset MAC;
 - 2> perform the actions defined for this failure case as defined in the specifications applicable for the other RAT.

[TS 38.331, clause 5.3.7.5]

The UE shall:

- 1> stop timer T301;
- 1> consider the current cell to be the PCell;
- 1> store the *nextHopChainingCount* value indicated in the *RRCReestablishment* message;

- 1> update the K_{gNB} key based on the current K_{gNB} key or the NH, using the stored *nextHopChainingCount* value, as specified in TS 33.501 [11];
- 1> derive the K_{RRCEnc} and K_{UPenc} keys associated with the previously configured *cipheringAlgorithm*, as specified in TS 33.501 [11];
- 1> derive the K_{RRCint} and K_{UPint} keys associated with the previously configured *integrityProtAlgorithm*, as specified in TS 33.501 [11].
- 1> request lower layers to verify the integrity protection of the *RRCReestablishment* message, using the previously configured algorithm and the K_{RRCint} key;
- 1> if the integrity protection check of the *RRCReestablishment* message fails:
 - 2> perform the actions upon going to RRC_IDLE as specified in 5.3.11, with release cause 'RRC connection failure', upon which the procedure ends;
- 1> configure lower layers to resume integrity protection for SRB1 using the previously configured algorithm and the K_{RRCint} key immediately, i.e., integrity protection shall be applied to all subsequent messages received and sent by the UE, including the message used to indicate the successful completion of the procedure;
- 1> configure lower layers to resume ciphering for SRB1 using the previously configured algorithm and, the K_{RRCEnc} key immediately, i.e., ciphering shall be applied to all subsequent messages received and sent by the UE, including the message used to indicate the successful completion of the procedure;
- 1> release the measurement gap configuration indicated by the *measGapConfig*, if configured;
- 1> submit the *RRCReestablishmentComplete* message to lower layers for transmission;
- 1> the procedure ends.

8.1.4.1.5.3 Test Description

8.1.4.1.5.3.1 Pre-test conditions

System Simulator:

- NR Cell 1 is the Serving cell.
- NR Cell 2 is the Suitable neighbour intra-frequency cell.
- System information combination NR-2 as defined in TS 38.508-1 [4] clause 4.4.3.1.3 is used for both NR Cells.

UE:

- None.

Preamble:

- The UE is in state 3N-A as defined in TS 38.508-1 [4], subclause 4.4A on NR Cell 1.

8.1.4.1.5.3.2 Test procedure sequence

Table 8.1.4.1.5.3.2-1 and Table 8.1.4.1.5.3.2-2 illustrates the downlink power levels and other changing parameters to be applied for the cells at various time instants of the test execution. The exact instants on which these values shall be applied are described in the texts in this clause.

Table 8.1.4.1.5.3.2-1: Time instances of cell power level and parameter changes for FR1

	Parameter	Unit	NR Cell 1	NR Cell 2	Remark
T1	SS/PBCH SSS EPRE	dBm/SC S	-88	-88	
T2	SS/PBCH SSS EPRE	dBm/SC S	-88	"Off"	
T3	SS/PBCH SSS EPRE	dBm/SC S	"Off"	-88	

Table 8.1.4.1.5.3.2-2: Time instances of cell power level and parameter changes for FR2

	Parameter	Unit	NR Cell 1	NR Cell 2	Remark
T1	SS/PBCH SSS EPRE	dBm/SC S	FFS	FFS	
T2	SS/PBCH SSS EPRE	dBm/SC S	FFS	"Off"	
T3	SS/PBCH SSS EPRE	dBm/SC S	"Off"	FFS	

Table 8.1.4.1.5.3.2-3: Main behaviour

St	Procedure	Message Sequence		TP	Verdict
		U - S	Message		
1	The SS changes the power level setting according to the row "T1".	-	-	-	-
2	The SS transmits an RRCReconfiguration message on NR Cell 1 to order the UE to perform handover to NR Cell 2.	<--	NR RRC: <i>RRCReconfiguration</i>	-	-
-	EXCEPTION: In parallel to the events described in step 3 the steps specified in Table 8.1.4.1.5.3.2-4 should take place.	-	-	-	-
3	The SS changes the power level setting according to the row "T2".	-	-	-	-
4	Check: Does the UE transmit an RRCReestablishmentRequest message on NR Cell 1?	-->	NR RRC: <i>RRCReestablishmentRequest</i>	1	P
5	The SS transmits an RRCReestablishment message to resume SRB1 operation and re-activate security on NR Cell 1.	<--	NR RRC: <i>RRCReestablishment</i>	-	-
6	Does the UE transmit an RRCReestablishmentComplete message using the security key derived from the nextHopChainingCount on NR Cell 1?	-->	NR RRC: <i>RRCReestablishmentComplete</i>	2	P
6A	The SS transmits an RRCReconfiguration message to resume existing radio bearers on NR Cell 1.	<--	NR RRC: RRCReconfiguration	-	-
6B	The UE transmits an <i>RRCReconfigurationComplete</i> message on NR Cell 1.	-->	NR RRC: RRCReconfigurationComplete	-	-
7	The SS changes the power level setting according to the row "T1".	-	-	-	-
8	The SS transmits an RRCReconfiguration message on NR Cell 1 to order the UE to perform handover to NR Cell 2.	<--	NR RRC: <i>RRCReconfiguration</i>	-	-
-	EXCEPTION: In parallel to the events described in step 9 the steps specified in Table 8.1.4.1.5.3.2-4 should take place.	-	-	-	-
9	The SS changes the power level setting according to the row "T3".	-	-	-	-
10	Check: Does the UE transmit an RRCReestablishmentRequest message on NR Cell 2?	-->	NR RRC: <i>RRCReestablishmentRequest</i>	-	-
11	The SS transmits an RRCReestablishment message to resume SRB1 operation and re-activate security on NR Cell 2.	<--	NR RRC: <i>RRCReestablishment</i>	-	-
12	Does the UE transmit an RRCReestablishmentComplete message using the security key derived from the nextHopChainingCount on NR Cell 2?	-->	NR RRC: <i>RRCReestablishmentComplete</i>	3	P
12 A	The SS transmits an RRCReconfiguration message to resume existing radio bearers on NR Cell 2.	<--	NR RRC: RRCReconfiguration	-	-
12 B	The UE transmits an RRCReconfigurationComplete message on NR Cell 2.	-->	NR RRC: RRCReconfigurationComplete	-	-
13	The SS transmits an <i>RRCRelease</i> message on NR Cell 2.	<--	NR RRC: <i>RRCRelease</i>	-	-

Table 8.1.4.1.5.3.2-4: Parallel behaviour

St	Procedure	Message Sequence		TP	Verdict
		U - S	Message		
-	EXCEPTION: The steps 1 and 2 below are repeated for the duration of T304.	-	-	-	-
1	The UE attempts to perform the handover using MAC Random Access Preamble on NR Cell 2.	-	-	-	-
2	The SS does not respond.	-	-	-	-

8.1.4.1.5.3.3 Specific message contents

Table 8.1.4.1.5.3.3-1: SIB1 for NR Cell 1 and NR Cell 2 (preamble and all steps, Table 8.1.4.1.5.3.2-3)

Derivation Path: 38.508-1, Table 4.6.3-130			
Information Element	Value/remark	Comment	Condition
RACH-ConfigGeneric ::= SEQUENCE {			
preambleTransMax	n50		
}			

Table 8.1.4.1.5.3.3-2: RRCReconfiguration-HO (steps 2, 8, Table 8.1.4.1.5.3.2-3)

Derivation Path: 38.508-1 [4] Table 4.8.1-1A with condition RBConfig_KeyChange
--

Table 8.1.4.1.5.3.3-3: RRCReestablishmentRequest (step 4, Table 8.1.4.1.5.3.2-3)

Derivation Path: 38.508-1, Table 4.6.1-12			
Information Element	Value/remark	Comment	Condition
RRCReestablishmentRequest ::= SEQUENCE {			
ue-Identity SEQUENCE {			
c-RNTI	the value of the C-RNTI of the UE		
physCellId	PhysicalCellIdentity of NR Cell 1		
shortMAC-I	The same value as the 16 least significant bits of the MAC-I value calculated by SS.		
}			
reestablishmentCause	handoverFailure		
}			

Table 8.1.4.1.5.3.3-4: RRCReestablishment (step 5, Table 8.1.4.1.5.3.2-3)

Derivation Path: 38.508-1, Table 4.6.1-10			
Information Element	Value/remark	Comment	Condition
RRCReestablishment ::= SEQUENCE {			
criticalExtensions CHOICE {			
rrcReestablishment SEQUENCE {			
nextHopChainingCount	2		
}			
}			
}			

Table 8.1.4.1.5.3.3-5: RRCReestablishmentRequest (step 10, Table 8.1.4.1.5.3.2-3)

Derivation Path: 38.508-1, Table 4.6.1-12			
Information Element	Value/remark	Comment	Condition
RRCReestablishmentRequest ::= SEQUENCE {			
ue-Identity SEQUENCE {			
c-RNTI	the value of the C-RNTI of the UE		
physCellId	PhysicalCellIdentity of NR Cell 2		
shortMAC-I	The same value as the 16 least significant bits of the MAC-I value calculated by SS.		
}			
reestablishmentCause	handoverFailure		
}			

Table 8.1.4.1.5.3.3-6: RRCReestablishment (step 11, Table 8.1.4.1.5.3.2-3)

Derivation Path: 38.508-1, Table 4.6.1-10			
Information Element	Value/remark	Comment	Condition
RRCReestablishment ::= SEQUENCE {			
criticalExtensions CHOICE {			
rrcReestablishment SEQUENCE {			
nextHopChainingCount	0		
}			
}			
}			

Table 8.1.4.1.5.3.3-7: RRCReconfiguration (step 6A and 12A, Table 8.1.4.1.5.3.2-3)

Derivation Path: TS 38.508-1[4], table 4.6.1-13 with condition REEST
--

8.1.4.1.6 Intra NR handover / Failure / Re-establishment failure

8.1.4.1.6.1 Test Purpose (TP)

(1)

```
with { UE in NR RRC_CONNECTED state and having received an RRCReconfiguration message including a
reconfigurationWithSync for handover to the target cell }
ensure that {
  when { UE detects handover failure and fails an RRCReestablishment procedure }
  then { UE enters NR RRC_IDLE state }
}
```

8.1.4.1.6.2 Conformance requirements

References: The conformance requirements covered in the present test case are specified in: TS 38.331, clauses 5.3.5.5.2, 5.3.5.8.3 and 5.3.7.5 and TS 24.501, clause 5.5.1.3.2. Unless otherwise stated these are Rel-15 requirements.

[TS 38.331, clause 5.3.5.5.2]

The UE shall perform the following actions to execute a reconfiguration with sync.

- 1> if the AS security is not activated, perform the actions upon going to RRC_IDLE as specified in 5.3.11 with the release cause 'other' upon which the procedure ends;
- 1> stop timer T310 for the corresponding SpCell, if running;

- 1> start timer T304 for the corresponding SpCell with the timer value set to *t304*, as included in the *reconfigurationWithSync*;
- 1> if the *frequencyInfoDL* is included:
 - 2> consider the target SpCell to be one on the SSB frequency indicated by the *frequencyInfoDL* with a physical cell identity indicated by the *physCellId*;
- 1> else:
 - 2> consider the target SpCell to be one on the SSB frequency of the source SpCell with a physical cell identity indicated by the *physCellId*;
- 1> start synchronising to the DL of the target SpCell;
- 1> apply the specified BCCH configuration defined in 9.1.1.1;
- 1> acquire the *MIB*, which is scheduled as specified in TS 38.213 [13];

NOTE 1: The UE should perform the reconfiguration with sync as soon as possible following the reception of the RRC message triggering the reconfiguration with sync, which could be before confirming successful reception (HARQ and ARQ) of this message.

NOTE 2: The UE may omit reading the *MIB* if the UE already has the required timing information, or the timing information is not needed for random access.

- 1> reset the MAC entity of this cell group;
- 1> consider the SCell(s) of this cell group, if configured, to be in deactivated state;
- 1> apply the value of the *newUE-Identity* as the C-RNTI for this cell group;
- 1> configure lower layers in accordance with the received *spCellConfigCommon*;
- 1> configure lower layers in accordance with any additional fields, not covered in the previous, if included in the received *reconfigurationWithSync*.

[TS 38.331, clause 5.3.5.8.3]

The UE shall:

- 1> if T304 of the MCG expires:
 - 2> release dedicated preambles provided in *rach-ConfigDedicated* if configured;
 - 2> revert back to the UE configuration used in the source PCell;
 - 2> initiate the connection re-establishment procedure as specified in subclause 5.3.7.

NOTE 1: In the context above, "the UE configuration" includes state variables and parameters of each radio bearer.

- 1> else if T304 of a secondary cell group expires:
 - 2> release dedicated preambles provided in *rach-ConfigDedicated*, if configured;
 - 2> initiate the SCG failure information procedure as specified in subclause 5.7.3 to report SCG reconfiguration with sync failure, upon which the RRC reconfiguration procedure ends;
- 1> else if T304 expires when *RRCReconfiguration* is received via other RAT (HO to NR failure):
 - 2> reset MAC;
 - 2> perform the actions defined for this failure case as defined in the specifications applicable for the other RAT.

[TS 38.331, clause 5.3.7.5]

The UE shall:

- 1> stop timer T301;
- 1> consider the current cell to be the PCell;
- 1> store the *nextHopChainingCount* value indicated in the *RRCReestablishment* message;
- 1> update the K_{gNB} key based on the current K_{gNB} key or the NH, using the stored *nextHopChainingCount* value, as specified in TS 33.501 [11];
- 1> derive the $K_{RRCCenc}$ and K_{UPenc} keys associated with the previously configured *cipheringAlgorithm*, as specified in TS 33.501 [11];
- 1> derive the K_{RRCint} and K_{UPint} keys associated with the previously configured *integrityProtAlgorithm*, as specified in TS 33.501 [11].
- 1> request lower layers to verify the integrity protection of the *RRCReestablishment* message, using the previously configured algorithm and the K_{RRCint} key;
- 1> if the integrity protection check of the *RRCReestablishment* message fails:
 - 2> perform the actions upon going to RRC_IDLE as specified in 5.3.11, with release cause 'RRC connection failure', upon which the procedure ends;
- 1> configure lower layers to resume integrity protection for SRB1 using the previously configured algorithm and the K_{RRCint} key immediately, i.e., integrity protection shall be applied to all subsequent messages received and sent by the UE, including the message used to indicate the successful completion of the procedure;
- 1> configure lower layers to resume ciphering for SRB1 using the previously configured algorithm and, the $K_{RRCCenc}$ key immediately, i.e., ciphering shall be applied to all subsequent messages received and sent by the UE, including the message used to indicate the successful completion of the procedure;
- 1> release the measurement gap configuration indicated by the *measGapConfig*, if configured;
- 1> submit the *RRCReestablishmentComplete* message to lower layers for transmission;
- 1> the procedure ends.

[TS 24.501, clause 5.5.1.3.2]

The UE in state 5GMM-REGISTERED shall initiate the registration procedure for mobility and periodic registration update by sending a REGISTRATION REQUEST message to the AMF,

...

- f) when the UE receives an indication of "RRC Connection failure" from the lower layers and does not have signalling pending (i.e. when the lower layer requests NAS signalling connection recovery) except for the case specified in subclause 5.3.1.4;

8.1.4.1.6.3 Test Description

8.1.4.1.6.3.1 Pre-test conditions

System Simulator:

- NR Cell 1 is the Serving cell.
- NR Cell 2 is the Suitable neighbour intra-frequency cell.
- System information combination NR-2 as defined in TS 38.508-1 [4] clause 4.4.3.1.3 is used for both NR Cells.

UE:

- None.

Preamble:

- The UE is in state 3N-A as defined in TS 38.508-1 [4], subclause 4.4A on NR Cell 1.

8.1.4.1.6.3.2 Test procedure sequence

Table 8.1.4.1.6.3.2-1 and Table 8.1.4.1.6.3.2-2 illustrates the downlink power levels and other changing parameters to be applied for the cells at various time instants of the test execution. The exact instants on which these values shall be applied are described in the texts in this clause.

Table 8.1.4.1.6.3.2-1: Time instances of cell power level and parameter changes for FR1

	Parameter	Unit	NR Cell 1	NR Cell 2	Remark
T1	SS/PBCH SSS EPRE	dBm/SC S	-88	-88	
T2	SS/PBCH SSS EPRE	dBm/SC S	-88	"Off"	

Table 8.1.4.1.6.3.2-2: Time instances of cell power level and parameter changes for FR2

	Parameter	Unit	NR Cell 1	NR Cell 2	Remark
T1	SS/PBCH SSS EPRE	dBm/SC S	FFS	FFS	
T2	SS/PBCH SSS EPRE	dBm/SC S	FFS	"Off"	

Table 8.1.4.1.6.3.2-3: Main behaviour

St	Procedure	Message Sequence		TP	Verdict
		U - S	Message		
1	The SS changes the power level setting according to the row "T1".	-	-	-	-
2	The SS transmits an RRCReconfiguration message on NR Cell 1 to order the UE to perform handover to NR Cell 2.	<-	NR RRC: <i>RRCReconfiguration</i>	-	-
-	EXCEPTION: In parallel to the events described in step 3 the steps specified in Table 8.1.4.1.6.3.2-4 should take place.	-	-	-	-
3	The SS changes the power level setting according to the row "T2".	-	-	-	-
4	Check: Does the UE transmit an RRCReestablishmentRequest message on NR Cell 1?	-->	NR RRC: <i>RRCReestablishmentRequest</i>	1	P
5	The SS transmits an RRCReestablishment message to resume SRB1 operation and reactivate security on NR Cell 1. Note: RRCReestablishment includes a wrong nextHopChainingCount value causing an integrity check failure.	<-	NR RRC: <i>RRCReestablishment</i>	-	-
6	Check: Does the test result of test procedure in TS 38.508-1 [4] subclause 4.9.5 indicate that the UE has performed mobility registration on NR cell 1 started in NR RRC_IDLE?	-	-	1	-

Table 8.1.4.1.6.3.2-4: Parallel behaviour

St	Procedure	Message Sequence		TP	Verdict
		U - S	Message		
-	EXCEPTION: The steps 1 and 2 below are repeated for the duration of T304.	-	-	-	-
1	The UE attempts to perform the handover using MAC Random Access Preamble on NR Cell 2.	-	-	-	-
2	The SS does not respond.	-	-	-	-

8.1.4.1.6.3.3 Specific message contents

Table 8.1.4.1.6.3.3-1: SIB1 for NR Cell 1 and NR Cell 2 (preamble and all steps, Table 8.1.4.1.6.3.2-3)

Derivation Path: 38.508-1, Table 4.6.3-130			
Information Element	Value/remark	Comment	Condition
RACH-ConfigGeneric ::= SEQUENCE {			
preambleTransMax	n50		
}			

Table 8.1.4.1.6.3.3-2: *RRCReconfiguration-HO* (step 2, Table 8.1.4.1.6.3.2-3)

Derivation Path: 38.508-1 [4] Table 4.8.1-1A with condition RBConfig_KeyChange
--

Table 8.1.4.1.6.3.3-3: *RRCReestablishmentRequest* (step 4, Table 8.1.4.1.6.3.2-3)

Derivation Path: 38.508-1, Table 4.6.1-12			
Information Element	Value/remark	Comment	Condition
RRCReestablishmentRequest ::= SEQUENCE {			
ue-Identity SEQUENCE {			
c-RNTI	the value of the C-RNTI of the UE		
physCellId	PhysicalCellIdentity of NR Cell 1		
shortMAC-I	The same value as the 16 least significant bits of the MAC-I value calculated by SS.		
}			
reestablishmentCause	handoverFailure		
}			

Table 8.1.4.1.6.3.3-4: *RRCReestablishment* (step 5, Table 8.1.4.1.6.3.2-3)

Derivation Path: 38.508-1, Table 4.6.1-10			
Information Element	Value/remark	Comment	Condition
RRCReestablishment ::= SEQUENCE {			
criticalExtensions CHOICE {			
rrcReestablishment SEQUENCE {			
nextHopChainingCount	7		
}			
}			
}			

8.1.4.1.7 NR CA / Intra NR handover / Success / PCell Change and SCell addition / SCell release

8.1.4.1.7.1 NR CA / Intra NR handover / Success / PCell Change and SCell addition / SCell release / Intra-band Contiguous CA

8.1.4.1.7.1.1 Test Purpose (TP)

(1)

```
with { UE in NR RRC_CONNECTED state and configured an SCell }
ensure that {
  when { UE receives an RRCReconfiguration message including a reconfigurationWithSync for handover
to one of the SCell and sCellToAddModList for an SCell addition }
  then { UE transmits an RRCReconfigurationComplete message. }
}
```

(2)

```
with { UE in NR RRC_CONNECTED state }
ensure that {
  when { UE receives an RRCReconfiguration message including a reconfigurationWithSync for PCell
change and including sCellToReleaseList with an sCellIndex set to the configured SCell }
  then { UE sends an RRCReconfigurationComplete message. }
}
```

8.1.4.1.7.1.2 Conformance requirements

References: The conformance requirements covered in the current TC are specified in: TS 38.331 clauses 5.3.5.5.2, clauses 5.3.5.5.9 and clauses 5.3.5.5.8. Unless otherwise stated these are Rel-15 requirements.

[TS 38.331, clause 5.3.5.5.2]

The UE shall perform the following actions to execute a reconfiguration with sync.

- 1> if the AS security is not activated, perform the actions upon going to RRC_IDLE as specified in 5.3.11 with the release cause 'other' upon which the procedure ends;
- 1> stop timer T310 for the corresponding SpCell, if running;
- 1> start timer T304 for the corresponding SpCell with the timer value set to *t304*, as included in the *reconfigurationWithSync*;
- 1> if the *frequencyInfoDL* is included:
 - 2> consider the target SpCell to be one on the SSB frequency indicated by the *frequencyInfoDL* with a physical cell identity indicated by the *physCellId*;
- 1> else:
 - 2> consider the target SpCell to be one on the SSB frequency of the source SpCell with a physical cell identity indicated by the *physCellId*;
- 1> start synchronising to the DL of the target SpCell;
- 1> apply the specified BCCH configuration defined in 9.1.1.1;
- 1> acquire the *MIB*, which is scheduled as specified in TS 38.213 [13];

NOTE 1: The UE should perform the reconfiguration with sync as soon as possible following the reception of the RRC message triggering the reconfiguration with sync, which could be before confirming successful reception (HARQ and ARQ) of this message.

NOTE 2: The UE may omit reading the *MIB* if the UE already has the required timing information, or the timing information is not needed for random access.

- 1> reset the MAC entity of this cell group;
- 1> consider the SCell(s) of this cell group, if configured, to be in deactivated state;
- 1> apply the value of the *newUE-Identity* as the C-RNTI for this cell group;
- 1> configure lower layers in accordance with the received *spCellConfigCommon*;
- 1> configure lower layers in accordance with any additional fields, not covered in the previous, if included in the received *reconfigurationWithSync*.

[TS 38.331, clause 5.3.5.5.9]

The UE shall:

- 1> for each *sCellIndex* value included in the *sCellToAddModList* that is not part of the current UE configuration (SCell addition):
 - 2> add the SCell, corresponding to the *sCellIndex*, in accordance with the *sCellConfigCommon* and *sCellConfigDedicated*;
 - 2> configure lower layers to consider the SCell to be in deactivated state;
 - 2> for each *measId* included in the *measIdList* within *VarMeasConfig*:
 - 3> if SCells are not applicable for the associated measurement; and
 - 3> if the concerned SCell is included in *cellsTriggeredList* defined within the *VarMeasReportList* for this *measId*:
 - 4> remove the concerned SCell from *cellsTriggeredList* defined within the *VarMeasReportList* for this *measId*;
- 1> for each *sCellIndex* value included in the *sCellToAddModList* that is part of the current UE configuration (SCell modification):
 - 2> modify the SCell configuration in accordance with the *sCellConfigDedicated*.

[TS 38.331, clause 5.3.5.5.8]

The UE shall:

- 1> if the release is triggered by reception of the *sCellToReleaseList*:
 - 2> for each *sCellIndex* value included in the *sCellToReleaseList*:
 - 3> if the current UE configuration includes an SCell with value *sCellIndex*:
 - 4> release the SCell.

8.1.4.1.7.1.3 Test description

8.1.4.1.7.1.3.1 Pre-test conditions

System Simulator:

- NR Cell 1 is the PCell, NR Cell 3 is the configured SCell. NR Cell 2 is the target SCell. NR Cell 23 is the target intra-frequency Cell of NR Cell 3, and also the target PCell.
- NR Cell 1 and NR Cell 3 are Intra-band Contiguous. NR Cell 2 and NR Cell 23 are Intra-band Contiguous.
- NR Cell 3 is an Inactive SCell according to TS 38.508-1 [4] clause 6.3.1.
- NR Cell 23 belongs to the same PLMN and TAI with NR Cell 1.
- System information combination NR-4 as defined in TS 38.508-1 [4] clause 4.4.3.1.2 is used in NR cells.

UE:

- None.

Preamble:

- If `pc_IP_Ping` is set to TRUE then, the UE is in 5GS state 3N-A according to TS 38.508-1 [4], clause 4.4A.2 Table 4.4A.2-3.
- Else, the UE is in 5GS state 3N-A and Test Loop Function (*On*) with UE test loop mode B on NR Cell 1 according to 38.508-1[4], clause 4.4A.2 Table 4.4A.2-3.

8.1.4.1.7.1.3.2 Test procedure sequence

Table 8.1.4.1.7.1.3.2-1 and Table 8.1.4.1.7.1.3.2-2 illustrates the downlink power levels to be applied for NR Cell 1, NR Cell 3, NR Cell 2 and NR Cell 23 at various time instants of the test execution. Row marked “T0” denotes the conditions after the preamble, while rows marked “T1” are to be applied subsequently. The exact instants on which these values shall be applied are described in the texts in this clause.

Table 8.1.4.1.7.1.3.2-1: Time instances of cell power level and parameter changes for FR1

	Parameter	Unit	NR Cell 1	NR Cell 3	NR Cell 2	NR Cell 23	Remark
T0	SS/PBCH SSS EPRE	dBm/SCS	-88	-88	-88	“off”	NR Cell 1, NR Cell 2 and NR Cell 3 are available. NR Cell 23 are not available.
T1	SS/PBCH SSS EPRE	dBm/SCS	“off”	-88	-88	-88	NR Cell 3, NR Cell 2 and NR Cell 23 are available. NR Cell 1 are not available.

Table 8.1.4.1.7.1.3.2-2: Time instances of cell power level and parameter changes for FR2

	Parameter	Unit	NR Cell 1	NR Cell 3	NR Cell 2	NR Cell 23	Remark
T0	SS/PBCH SSS EPRE	dBm/SCS	FFS	FFS	FFS	“off”	NR Cell 1, NR Cell 2 and NR Cell 3 are available. NR Cell 23 are not available.
T1	SS/PBCH SSS EPRE	dBm/SCS	“off”	FFS	FFS	FFS	NR Cell 3, NR Cell 2 and NR Cell 23 are available. NR Cell 1 are not available.

Table 8.1.4.1.7.1.3.2-3: Main behaviour

St	Procedure	Message Sequence		TP	Verdict
		U - S	Message		
1	The SS changes Cell parameters according to the row "T0" in table 8.1.4.1.7.1.3.2-1/2.	-	-	-	-
2	The SS transmits an <i>RRCReconfiguration</i> message including a <i>sCellToAddModList</i> to add NR Cell 3 as a SCell.	<--	NR RRC: <i>RRCReconfiguration</i>	-	-
3	The UE transmits the <i>RRCReconfigurationComplete</i> message.	-->	NR RRC: <i>RRCReconfigurationComplete</i>	-	-
4	The SS transmits an <i>RRCReconfiguration</i> message including a <i>reconfigurationWithSync</i> for handover to NR Cell 3 and <i>sCellToAddModList</i> to add NR Cell 2 as a SCell.	<--	NR RRC: <i>RRCReconfiguration</i>	-	-
5	Check: Does UE transmit the <i>RRCReconfigurationComplete</i> message?	-->	NR RRC: <i>RRCReconfigurationComplete</i>	1	P
5A	Check: Does the test result of generic test procedure in TS 38.508-1 Table 4.9.1-1A indicate that the UE is capable of exchanging IP data on DRB #n associated with the first PDU session on Cell 2?	-	-	1	-
6	The SS changes Cell parameters according to the row "T1" in table 8.2.4.2.1.1.3.2-1/2.	-	-	-	-
7	The SS transmits an <i>RRCReconfiguration</i> message including a <i>reconfigurationWithSync</i> to change PCell to NR Cell 23 and including <i>sCellToReleaseList</i> with a <i>sCellIndex</i> of NR Cell 2.	<--	NR RRC: <i>RRCReconfiguration</i>	-	-
8	Check: Does the UE transmit the <i>RRCReconfigurationComplete</i> message?	-->	NR RRC: <i>RRCReconfigurationComplete</i>	2	P
9	Check: Does the test result of generic test procedure in TS 38.508-1 subclause 4.9.1 indicate that the UE is capable of exchanging IP data on DRB #n associated with the first PDU session on Cell 23?	-	-	2	-

8.1.4.1.7.1.3.3 Specific message contents

Table 8.1.4.1.7.1.3.3-1: *RRCReconfiguration* (step 2, Table 8.1.4.1.7.1.3.2-3)

Derivation Path: TS 38.508-1 [4], Table 4.6.1-13 with condition SCell_add			
Information Element	Value/remark	Comment	Condition
<i>RRCReconfiguration</i> ::= SEQUENCE {			
<i>criticalExtensions</i> CHOICE {			
<i>rrcReconfiguration</i> SEQUENCE {			
<i>nonCriticalExtension</i> SEQUENCE{			
<i>masterCellGroup</i>	CellGroupConfig	OCTET STRING (CONTAINING CellGroupConfig)	
}			
}			
}			
}			

Table 8.1.4.1.7.1.3.3-2: CellGroupConfig (Table 8.1.4.1.7.1.3.3-1)

Derivation Path: TS 38.508-1 [4], Table 4.6.3-19 with Condition SCell_Add			
Information Element	Value/remark	Comment	Condition
CellGroupConfig ::= SEQUENCE {			
sCellToAddModList SEQUENCE (SIZE (1..maxNrofSCells)) OF SCellConfig {	1 entry		
SCellConfig[1] SEQUENCE {		entry 1	
sCellConfigCommon SEQUENCE {			
physCellId	Physical Cell Identity of NR Cell 3		
}			
}			
}			

Table 8.1.4.1.7.1.3.3-3: RRCReconfiguration (step 4, Table 8.1.4.1.7.1.3.2-3)

Derivation Path: TS 38.508-1 [4] 4.8.1-1A with condition RBConfig_KeyChange			
Information Element	Value/remark	Comment	Condition
RRCReconfiguration ::= SEQUENCE {			
criticalExtensions CHOICE {			
rrcReconfiguration SEQUENCE {			
nonCriticalExtension SEQUENCE{			
masterCellGroup	CellGroupConfig	OCTET STRING (CONTAINING CellGroupConfig)	
}			
}			
}			
}			

Table 8.1.4.1.7.1.3.3-4: CellGroupConfig (Table 8.1.4.1.7.1.3.3-3)

Derivation Path: TS 38.508-1 [4], Table 4.6.3-19 with Condition PCell_change and SCell_Add			
Information Element	Value/remark	Comment	Condition
CellGroupConfig ::= SEQUENCE {			
spCellConfig SEQUENCE {			
reconfigurationWithSync SEQUENCE {			
spCellConfigCommon SEQUENCE {			
physCellId	Physical Cell Identity of NR Cell 3		
}			
}			
}			
sCellToAddModList SEQUENCE (SIZE (1..maxNrofSCells)) OF SCellConfig {	1 entry		
SCellConfig[1] SEQUENCE {		entry 1	
sCellConfigCommon[1] SEQUENCE {			
physCellId	Physical Cell Identity of NR Cell 2		
}			
}			
}			
}			

Table 8.1.4.1.7.1.3.3-5: RRCReconfiguration-HO (step 7, Table 8.1.4.1.7.1.3.2-3)

Derivation Path: TS 38.508-1 [4], Table 4.8.1-1A with condition RBConfig_KeyChange			
--	--	--	--

Table 8.1.4.1.7.1.3.3-6: CellGroupConfig (Table 8.1.4.1.7.1.3.3-5)

Derivation Path: 38.508-1 [4], Table 4.6.3-19 with conditions PCell_change			
Information Element	Value/remark	Comment	Condition
CellGroupConfig ::= SEQUENCE {			
spCellConfig SEQUENCE {			
reconfigurationWithSync SEQUENCE {			
spCellConfigCommon SEQUENCE {			
physCellId	Physical Cell Identity of NR Cell 23		
}			
}			
}			
sCellToReleaseList SEQUENCE (SIZE (1..maxNrofSCells)) OF SCellIndex {	1 entry		
SCellIndex[1]	1	entry 1 SCell release for NR Cell 2	
}			
}			

8.1.4.1.7.2 NR CA / Intra NR handover / Success / PCell Change and SCell addition / SCell release / Inter-band CA

8.1.4.1.7.2.1 Test Purpose (TP)

Same as TC 8.1.4.1.7.1 but applied to Inter-band CA case.

8.1.4.1.7.2.2 Conformance requirements

Same as TC 8.1.4.1.7.1 but applied to Inter-band CA case.

8.1.4.1.7.2.3 Test description

8.1.4.1.7.2.3.1 Pre-test conditions

Same as test case 8.1.4.1.7.1 with the following differences:

- CA configuration: Inter-band CA replaces Intra-band Contiguous CA.
- Cells configuration: NR Cell 10 replaces NR Cell 3, NR Cell 30 replaces NR Cell 23.
- NR Cell 30 belongs to the same PLMN and TAI with NR Cell 1.

8.1.4.1.7.2.3.2 Test procedure sequence

Same as TC 8.1.4.1.7.1 with the following differences:

- CA configuration: Inter-band CA replaces Intra-band Contiguous CA

8.1.4.1.7.2.3.3 Specific message contents

Same as TC 8.1.4.1.7.1 with the following differences:

- CA configuration: Inter-band CA replaces Intra-band Contiguous CA
- Cells configuration: NR Cell 10 replaces NR Cell 3, NR Cell 30 replaces NR Cell 23.

Table 8.1.4.1.7.2.3.3-1: SIB3 of NR Cell 10 (step 6, Table 8.1.4.1.7.1.3.2-3)

Derivation Path: TS 38.508-1 [4], Table 4.6.2-2			
Information Element	Value/remark	Comment	Condition
SIB3 ::= SEQUENCE {			
intraFreqNeighCellList SEQUENCE (SIZE (1..maxCellIntra)) OF IntraFreqNeighCellInfo {	1 entry		
IntraFreqNeighCellInfo [1] SEQUENCE {		entry 1	
physCellId	Physical Cell Identity of NR Cell 30		
}			
}			
}			

8.1.4.1.7.3 NR CA / Intra NR handover / Success / PCell Change and SCell addition / SCell release / Intra-band non-contiguous CA

8.1.4.1.7.3.1 Test Purpose (TP)

Same as TC 8.1.4.1.7.1 but applied to Intra-band non-Contiguous CA.

8.1.4.1.7.3.2 Conformance requirements

Same as TC 8.1.4.1.7.1 but applied to Intra-band non-Contiguous CA.

8.1.4.1.7.3.3 Test description

8.1.4.1.7.3.3.1 Pre-test conditions

Same as test case 8.1.4.1.7.1 with the following differences:

- CA configuration: Intra-band non-Contiguous CA replaces Intra-band Contiguous CA.

8.1.4.1.7.3.3.2 Test procedure sequence

Same as TC 8.1.4.1.7.1 with the following differences:

- CA configuration: Intra-band non-Contiguous CA replaces Intra-band Contiguous CA

8.1.4.1.7.3.3.3 Specific message contents

Same as TC 8.1.4.1.7.1 with the following differences:

- CA configuration: Intra-band non-Contiguous CA replaces Intra-band Contiguous CA

8.1.4.1.8 NR CA / Intra NR handover / Success / PCell Change / SCell no Change

8.1.4.1.8.1 NR CA / Intra NR handover / Success / PCell Change / SCell no Change / Intra-band Contiguous CA

8.1.4.1.8.1.1 Test Purpose (TP)

(1)

```
with { UE in NR RRC_CONNECTED state and configured an SCell }
ensure that {
  when { UE receives an RRCReconfiguration message including a reconfigurationWithSync for PCell
change and sCellToAddModList with an SCell same from configured SCell }
    then { UE transmits an RRCReconfigurationComplete message. }
}
```

8.1.4.1.8.1.2 Conformance requirements

References: The conformance requirements covered in the current TC are specified in: TS 38.331 clauses 5.3.5.5.2, clauses 5.3.5.5.9. Unless otherwise stated these are Rel-15 requirements.

[TS 38.331, clause 5.3.5.5.2]

The UE shall perform the following actions to execute a reconfiguration with sync.

- 1> if the AS security is not activated, perform the actions upon going to RRC_IDLE as specified in 5.3.11 with the release cause 'other' upon which the procedure ends;
- 1> stop timer T310 for the corresponding SpCell, if running;
- 1> start timer T304 for the corresponding SpCell with the timer value set to *t304*, as included in the *reconfigurationWithSync*;
- 1> if the *frequencyInfoDL* is included:
 - 2> consider the target SpCell to be one on the SSB frequency indicated by the *frequencyInfoDL* with a physical cell identity indicated by the *physCellId*;
- 1> else:
 - 2> consider the target SpCell to be one on the SSB frequency of the source SpCell with a physical cell identity indicated by the *physCellId*;
- 1> start synchronising to the DL of the target SpCell;
- 1> apply the specified BCCH configuration defined in 9.1.1.1;
- 1> acquire the *MIB*, which is scheduled as specified in TS 38.213 [13];

NOTE 1: The UE should perform the reconfiguration with sync as soon as possible following the reception of the RRC message triggering the reconfiguration with sync, which could be before confirming successful reception (HARQ and ARQ) of this message.

NOTE 2: The UE may omit reading the *MIB* if the UE already has the required timing information, or the timing information is not needed for random access.

- 1> reset the MAC entity of this cell group;
- 1> consider the SCell(s) of this cell group, if configured, to be in deactivated state;
- 1> apply the value of the *newUE-Identity* as the C-RNTI for this cell group;
- 1> configure lower layers in accordance with the received *spCellConfigCommon*;
- 1> configure lower layers in accordance with any additional fields, not covered in the previous, if included in the received *reconfigurationWithSync*.

[TS 38.331, clause 5.3.5.5.9]

The UE shall:

- 1> for each *sCellIndex* value included in the *sCellToAddModList* that is not part of the current UE configuration (SCell addition):
 - 2> add the SCell, corresponding to the *sCellIndex*, in accordance with the *sCellConfigCommon* and *sCellConfigDedicated*;
 - 2> configure lower layers to consider the SCell to be in deactivated state;
- 2> for each *measId* included in the *measIdList* within *VarMeasConfig*:
 - 3> if SCells are not applicable for the associated measurement; and

3> if the concerned SCell is included in *cellsTriggeredList* defined within the *VarMeasReportList* for this *measId*:

4> remove the concerned SCell from *cellsTriggeredList* defined within the *VarMeasReportList* for this *measId*;

1> for each *sCellIndex* value included in the *sCellToAddModList* that is part of the current UE configuration (SCell modification):

2> modify the SCell configuration in accordance with the *sCellConfigDedicated*.

8.1.4.1.8.1.3 Test description

8.1.4.1.8.1.3.1 Pre-test conditions

System Simulator:

- NR Cell 1 is the PCell, NR Cell 3 is the configured SCell. NR Cell 2 is the target intra-frequency Cell of NR Cell 1, and also the target PCell.
- NR Cell 1 and NR Cell 3 are Intra-band Contiguous.
- NR Cell 3 is an Inactive SCell according to TS 38.508-1 [4] clause 6.3.1.
- System information combination NR-4 as defined in TS 38.508-1 [4] clause 4.4.3.1.2 is used in NR cells.

UE:

- None.

Preamble:

- If *pc_IP_Ping* is set to TRUE then, the UE is in 5GS state 3N-A according to TS 38.508-1 [4], clause 4.4A.2 Table 4.4A.2-3.
- Else, the UE is in 5GS state 3N-A and Test Loop Function (*On*) with UE test loop mode B on NR Cell 1 according to 38.508-1[4], clause 4.4A.2 Table 4.4A.2-3.

8.1.4.1.8.1.3.2 Test procedure sequence

Table 8.1.4.1.8.1.3.2-1 and Table 8.1.4.1.8.1.3.2-2 illustrates the downlink power levels to be applied for NR Cell 1, NR Cell 1, NR Cell 3 and NR Cell 2 at various time instants of the test execution. Row marked "T0" denotes the conditions after the preamble, while rows marked "T1" are to be applied subsequently. The exact instants on which these values shall be applied are described in the texts in this clause.

Table 8.1.4.1.8.1.3.2-1: Time instances of cell power level and parameter changes for FR1

	Parameter	Unit	NR Cell 1	NR Cell 3	NR Cell 2	Remark
T0	SS/PBCH SSS EPRE	dBm/ SCS	-88	-99	"off"	NR Cell 1, NR Cell 3 are available. NR Cell 2 are not available.
T1	SS/PBCH SSS EPRE	dBm/ SCS	-88	-99	-88	NR Cell 1, NR Cell 3 and NR Cell 2 are available.

Table 8.1.4.1.8.1.3.2-2: Time instances of cell power level and parameter changes for FR2

	Parameter	Unit	NR Cell 1	NR Cell 3	NR Cell 2	Remark
T0	SS/PBCH SSS EPRE	dBm/ SCS	FFS	FFS	"off"	NR Cell 1, NR Cell 3 are available. NR Cell 2 are not available.
T1	SS/PBCH SSS EPRE	dBm/ SCS	FFS	FFS	FFS	NR Cell 1, NR Cell 3 and NR Cell 2 are available.

Table 8.1.4.1.8.1.3.2-3: Main behaviour

St	Procedure	Message Sequence		TP	Verdict
		U - S	Message		
1	The SS changes Cell parameters according to the row "T0" in table 8.1.4.1.8.1.3.2-1/2.	-	-	-	-
2	The SS transmits an <i>RRCReconfiguration</i> message including a <i>sCellToAddModList</i> to add NR Cell 3 as a SCell.	<--	NR RRC: <i>RRCReconfiguration</i>	-	-
3	The UE transmits the <i>RRCReconfigurationComplete</i> message?	-->	NR RRC: <i>RRCReconfigurationComplete</i>	-	-
3A	Check: Does the test result of generic test procedure in TS 38.508-1 Table 4.9.1-1A indicate that the UE is capable of exchanging IP data on DRB1 and NR Cell 3?	-	-	1	P
4	The SS changes Cell parameters according to the row "T1" in table 8.1.4.1.8.1.3.2-1/2.	-	-	-	-
5	The SS transmits an <i>RRCReconfiguration</i> message including a <i>reconfigurationWithSync</i> to change PCell to NR Cell 2 and <i>sCellToAddModList</i> to add NR Cell 3 as the SCell.	<--	NR RRC: <i>RRCReconfiguration</i>	-	-
6	Check: Does the UE transmit the <i>RRCReconfigurationComplete</i> message?	-->	NR RRC: <i>RRCReconfigurationComplete</i>	1	P
7	Check: Does the test result of generic test procedure in TS 38.508-1 Table 4.9.1-1A indicate that the UE is capable of exchanging IP data on DRB1 and NR Cell 3?	-	-	1	P

8.1.4.1.8.1.3.3 Specific message contents

Table 8.1.4.1.8.1.3.3-1: *RRCReconfiguration* (step 2, Table 8.1.4.1.8.1.3.2-3)

Derivation Path: 38.508-1 [4], Table 4.6.1-13 with condition SCell_add			
Information Element	Value/remark	Comment	Condition
<i>RRCReconfiguration</i> ::= SEQUENCE {			
<i>criticalExtensions</i> CHOICE {			
<i>rrcReconfiguration</i> SEQUENCE {			
<i>nonCriticalExtension</i> SEQUENCE{			
<i>masterCellGroup</i>	CellGroupConfig	OCTET STRING (CONTAINING CellGroupConfig)	
}			
}			
}			
}			

Table 8.1.4.1.8.1.3.3-2: CellGroupConfig (Table 8.1.4.1.8.1.3.3-1)

Derivation Path: 38.508-1 [4], Table 4.6.3-19 with condition SCell_add			
Information Element	Value/remark	Comment	Condition
CellGroupConfig ::= SEQUENCE {			
sCellToAddModList SEQUENCE (SIZE (1..maxNrofSCells)) OF SCellConfig {	1 entry		
SCellConfig[1] SEQUENCE {		entry 1	
sCellIndex	1		
sCellConfigCommon SEQUENCE {			
physCellId	Physical Cell Identity of NR Cell 3		
}			
}			
}			
}			

Table 8.1.4.1.8.1.3.3-3: RRCReconfiguration-HO (step 5, Table 8.1.4.1.8.1.3.2-3)

Derivation Path: 38.508-1 [4], Table 4.8.1-1A with condition RBConfig_KeyChange			
---	--	--	--

Table 8.1.4.1.8.1.3.3-4: CellGroupConfig (Table 8.1.4.1.8.1.3.3-3)

Derivation Path: 38.508-1 [4], Table 4.6.3-19 with condition PCell_change and SCell_add			
Information Element	Value/remark	Comment	Condition
CellGroupConfig ::= SEQUENCE {			
spCellConfig SEQUENCE {			
reconfigurationWithSync SEQUENCE {			
spCellConfigCommon SEQUENCE {			
physCellId	Physical Cell Identity of NR Cell 2		
}			
}			
sCellToAddModList SEQUENCE (SIZE (1..maxNrofSCells)) OF SCellConfig {	1 entry		
SCellConfig[1] SEQUENCE {		entry 1	
sCellIndex	1		
sCellConfigCommon SEQUENCE {			
physCellId	Physical Cell Identity of NR Cell 3		
}			
}			
}			
}			

8.1.4.1.8.2 NR CA / Intra NR handover / Success / PCell Change / SCell no Change / Inter-band CA

8.1.4.1.8.2.1 Test Purpose (TP)

Same as TC 8.1.4.1.8.1 but applied to Inter-band CA case.

8.1.4.1.8.2.2 Conformance requirements

Same as TC 8.1.4.1.8.1 but applied to Inter-band CA case.

8.1.4.1.8.2.3 Test description

8.1.4.1.8.2.3.1 Pre-test conditions

Same as test case 8.1.4.1.8.1 with the following differences:

- CA configuration: Inter-band CA replaces Intra-band Contiguous CA.
- Cells configuration: NR Cell 10 replaces NR Cell 3.

8.1.4.1.8.2.3.2 Test procedure sequence

Same as TC 8.1.4.1.8.1 with the following differences:

- CA configuration: Inter-band CA replaces Intra-band Contiguous CA

8.1.4.1.8.2.3.3 Specific message contents

Same as TC 8.1.4.1.8.1 with the following differences:

- CA configuration: Inter-band CA replaces Intra-band Contiguous CA
- Cells configuration: NR Cell 10 replaces NR Cell 3.

8.1.4.1.8.3 NR CA / Intra NR handover / Success / PCell Change / SCell no Change / Intra-band non-contiguous CA

8.1.4.1.8.3.1 Test Purpose (TP)

Same as TC 8.1.4.1.8.1 but applied to Intra-band non-Contiguous CA.

8.1.4.1.8.3.2 Conformance requirements

Same as TC 8.1.4.1.8.1 but applied to Intra-band non-Contiguous CA.

8.1.4.1.8.3.3 Test description

8.1.4.1.8.3.3.1 Pre-test conditions

Same as test case 8.1.4.1.8.1 with the following differences:

- CA configuration: Intra-band non-Contiguous CA replaces Intra-band Contiguous CA.

8.1.4.1.8.3.3.2 Test procedure sequence

Same as TC 8.1.4.1.8.1 with the following differences:

- CA configuration: Intra-band non-Contiguous CA replaces Intra-band Contiguous CA

8.1.4.1.8.3.3.3 Specific message contents

Same as TC 8.1.4.1.8.1 with the following differences:

- CA configuration: Intra-band non-Contiguous CA replaces Intra-band Contiguous CA

8.1.4.1.9 NR CA / Intra NR handover / Failure / Re-establishment successful

8.1.4.1.9.1 NR CA / Intra NR handover / Failure / Re-establishment successful / Intra-band Contiguous CA

8.1.4.1.9.1.1 Test Purpose (TP)

(1)

```
with { UE in NR RRC_CONNECTED state and having received an RRCReconfiguration message including a
reconfigurationWithSync for PCell change and including sCellToReleaseList with an sCellIndex set to
the configured SCell }
ensure that {
  when { UE detects handover failure and the source PCell is selectable}
  then { UE successfully performs an RRCReestablishment procedure on source Pcell}
}
```

(2)

```
with { UE in NR RRC_CONNECTED state and having received an RRCReconfiguration message including a
reconfigurationWithSync for PCell change and including sCellToReleaseList with an sCellIndex set to
the configured SCell }
ensure that {
  when { UE detects handover failure and the initial SCell is selectable}
  then { UE successfully performs an RRCReestablishment procedure on original SCell and the
original SCell becomes the PCell}
}
```

8.1.4.1.9.1.2 Conformance requirements

References: The conformance requirements covered in the present test case are specified in: TS 38.331, clause 5.3.5.5.2, 5.3.5.5.9, 5.3.5.5.8 and 5.3.7.5. Unless otherwise stated these are Rel-15 requirements.

[TS 38.331, clause 5.3.5.5.2]

The UE shall perform the following actions to execute a reconfiguration with sync.

- 1> if the AS security is not activated, perform the actions upon going to RRC_IDLE as specified in 5.3.11 with the release cause 'other' upon which the procedure ends;
- 1> stop timer T310 for the corresponding SpCell, if running;
- 1> start timer T304 for the corresponding SpCell with the timer value set to *t304*, as included in the *reconfigurationWithSync*;
- 1> if the *frequencyInfoDL* is included:
 - 2> consider the target SpCell to be one on the SSB frequency indicated by the *frequencyInfoDL* with a physical cell identity indicated by the *physCellId*;
- 1> else:
 - 2> consider the target SpCell to be one on the SSB frequency of the source SpCell with a physical cell identity indicated by the *physCellId*;
- 1> start synchronising to the DL of the target SpCell;
- 1> apply the specified BCCH configuration defined in 9.1.1.1;
- 1> acquire the *MIB*, which is scheduled as specified in TS 38.213 [13];

NOTE 1: The UE should perform the reconfiguration with sync as soon as possible following the reception of the RRC message triggering the reconfiguration with sync, which could be before confirming successful reception (HARQ and ARQ) of this message.

NOTE 2: The UE may omit reading the *MIB* if the UE already has the required timing information, or the timing information is not needed for random access.

- 1> reset the MAC entity of this cell group;

- 1> consider the SCell(s) of this cell group, if configured, to be in deactivated state;
- 1> apply the value of the *newUE-Identity* as the C-RNTI for this cell group;
- 1> configure lower layers in accordance with the received *spCellConfigCommon*;
- 1> configure lower layers in accordance with any additional fields, not covered in the previous, if included in the received *reconfigurationWithSync*.

[TS 38.331, clause 5.3.5.5.9]

The UE shall:

- 1> for each *sCellIndex* value included in the *sCellToAddModList* that is not part of the current UE configuration (SCell addition):
 - 2> add the SCell, corresponding to the *sCellIndex*, in accordance with the *sCellConfigCommon* and *sCellConfigDedicated*;
 - 2> configure lower layers to consider the SCell to be in deactivated state;
 - 2> for each *measId* included in the *measIdList* within *VarMeasConfig*:
 - 3> if SCells are not applicable for the associated measurement; and
 - 3> if the concerned SCell is included in *cellsTriggeredList* defined within the *VarMeasReportList* for this *measId*:
 - 4> remove the concerned SCell from *cellsTriggeredList* defined within the *VarMeasReportList* for this *measId*;
 - 1> for each *sCellIndex* value included in the *sCellToAddModList* that is part of the current UE configuration (SCell modification):
- 2> modify the SCell configuration in accordance with the *sCellConfigDedicated*.

[TS 38.331, clause 5.3.5.5.8]

The UE shall:

- 1> if the release is triggered by reception of the *sCellToReleaseList*:
 - 2> for each *sCellIndex* value included in the *sCellToReleaseList*:
 - 3> if the current UE configuration includes an SCell with value *sCellIndex*:
 - 4> release the SCell.

[TS 38.331, clause 5.3.7.5]

The UE shall:

- 1> stop timer T301;
- 1> consider the current cell to be the PCell;
- 1> store the *nextHopChainingCount* value indicated in the *RRCReestablishment* message;
- 1> update the K_{gNB} key based on the current K_{gNB} key or the NH, using the stored *nextHopChainingCount* value, as specified in TS 33.501 [11];
- 1> derive the $K_{RRCCenc}$ and K_{UPenc} keys associated with the previously configured *cipheringAlgorithm*, as specified in TS 33.501 [11];
- 1> derive the K_{RRCint} and K_{UPint} keys associated with the previously configured *integrityProtAlgorithm*, as specified in TS 33.501 [11].

- 1> request lower layers to verify the integrity protection of the *RRCReestablishment* message, using the previously configured algorithm and the K_{RRcInt} key;
- 1> if the integrity protection check of the *RRCReestablishment* message fails:
 - 2> perform the actions upon going to RRC_IDLE as specified in 5.3.11, with release cause 'RRC connection failure', upon which the procedure ends;
- 1> configure lower layers to resume integrity protection for SRB1 using the previously configured algorithm and the K_{RRcInt} key immediately, i.e., integrity protection shall be applied to all subsequent messages received and sent by the UE, including the message used to indicate the successful completion of the procedure;
- 1> configure lower layers to resume ciphering for SRB1 using the previously configured algorithm and, the K_{RRcEnc} key immediately, i.e., ciphering shall be applied to all subsequent messages received and sent by the UE, including the message used to indicate the successful completion of the procedure;
- 1> release the measurement gap configuration indicated by the *measGapConfig*, if configured;
- 1> submit the *RRCReestablishmentComplete* message to lower layers for transmission;
- 1> the procedure ends.

8.1.4.1.9.1.3 Test Description

8.1.4.1.9.1.3.1 Pre-test conditions

System Simulator:

- NR Cell 1 is the PCell and NR Cell 3 is the SCell
- System information combination NR-4 as defined in TS 38.508-1 [4] clause 4.4.3.1.3 is used in all NR cells.

UE:

- None.

Preamble:

- The UE is in 5GS state 3N-A as defined in TS 38.508-1 [4], clause 4.4A.2 Table 4.4A.2-3 on NR Cell 1.

8.1.4.1.9.1.3.2 Test procedure sequence

Table 8.1.4.1.9.1.3.2-1 and Table 8.1.4.1.9.1.3.2-1A illustrates the downlink power levels to be applied for NR Cell 1 and NR Cell 3 at various time instants of the test execution. Row marked "T0" denotes the conditions after the preamble, while rows marked "T1", "T2", "T3" and "T4" are to be applied subsequently. The exact instants on which these values shall be applied are described in the texts in this clause.

Table 8.1.4.1.9.1.3.2-1: Time instances of cell power level and parameter changes for FR1

	Parameter	Unit	NR Cell 1	NR Cell 3	Remark
T0	SS/PBCH SSS EPRE	dBm/SC S	-85	-91	Power levels are such that entry condition for event A3 is not satisfied $Mn + Ofn + Ocn - Hys < Mp + Ofp + Ocp + Off$
T1	SS/PBCH SSS EPRE	dBm/SC S	-85	-79	Power levels are such that entry condition for event A3 is satisfied $Mn + Ofn + Ocn - Hys > Mp + Ofp + Ocp + Off$
T2	SS/PBCH SSS EPRE	dBm/SC S	-85	"Off"	Power levels are assigned to satisfy $SrxLevCell3 < 0$ such that selecting Cell 1 is guaranteed
T3	SS/PBCH SSS EPRE	dBm/SC S	-85	-79	Power levels are such that entry condition for event A3 is satisfied $Mn + Ofn + Ocn - Hys > Mp + Ofp + Ocp + Off$
T4	SS/PBCH SSS EPRE	dBm/SC S	"Off"	-79	Power levels are assigned to satisfy $SrxLevCell1 < 0$ such that selecting Cell 3 is guaranteed

Table 8.1.4.1.9.1.3.2-1A: Time instances of cell power level and parameter changes for FR2

	Parameter	Unit	NR Cell 1	NR Cell 3	Remark
T0	SS/PBCH SSS EPRE	dBm/SC S	[FFS]	[FFS]	Power levels are such that entry condition for event A3 is not satisfied $Mn + Ofn + Ocn - Hys < Mp + Ofp + Ocp + Off$
T1	SS/PBCH SSS EPRE	dBm/SC S	[FFS]	[FFS]	Power levels are such that entry condition for event A3 is satisfied $Mn + Ofn + Ocn - Hys > Mp + Ofp + Ocp + Off$
T2	SS/PBCH SSS EPRE	dBm/SC S	[FFS]	"Off"	Power levels are assigned to satisfy $SrxLevCell3 < 0$ such that selecting Cell 1 is guaranteed
T3	SS/PBCH SSS EPRE	dBm/SC S	[FFS]	[FFS]	Power levels are such that entry condition for event A3 is satisfied $Mn + Ofn + Ocn - Hys > Mp + Ofp + Ocp + Off$
T4	SS/PBCH SSS EPRE	dBm/SC S	"Off"	[FFS]	Power levels are assigned to satisfy $SrxLevCell1 < 0$ such that selecting Cell 3 is guaranteed

Table 8.1.4.1.9.1.3.2-2: Main behaviour

St	Procedure	Message Sequence		TP	Verdict
		U - S	Message		
1	The SS transmits an RRCReconfiguration message on NR Cell 1 to configure NR Cell 3 as an SCell	<--	NR RRC: RRCReconfiguration	-	-
2	The UE transmits an RRCReconfigurationComplete message on NR Cell 1.	-->	NR RRC: RRCReconfigurationComplete	-	-
3	The SS transmits an RRCReconfiguration message on NR Cell 1 to setup event A3 reporting configuration.	<--	NR RRC: RRCReconfiguration	-	-
4	The UE transmits an RRCReconfigurationComplete message on NR Cell 1.	-->	NR RRC: RRCReconfigurationComplete	-	-
5	The SS changes NR Cell 1 and NR Cell 3 parameters according to the row "T1" in table 8.1.4.1.9.1.3.2-1/1A	-	-	-	-
6	The UE transmits a MeasurementReport message on NR Cell 1 to report event A3 with the measured RSRP, RSRQ value for NR Cell 3.	-->	NR RRC: MeasurementReport	-	-
7	The SS transmits an RRCReconfiguration message on NR Cell 1 to order the UE to perform inter frequency handover to NR Cell 3 and to release SCell NR Cell 3.	<--	NR RRC: RRCReconfiguration	-	-
-	EXCEPTION: In parallel to the events described in step 8 the steps specified in Table 8.1.4.1.9.1.3.2-3 should take place.	-	-	-	-
8	The SS changes NR Cell 1 and NR Cell 3 parameters according to the row "T2" in table 8.1.4.1.9.1.3.2-1/1A	-	-	-	-
9	Check: Does the UE transmit an RRCReestablishmentRequest message on NR Cell 1?	-->	NR RRC: RRCReestablishmentRequest	1	P
10	The SS transmits an RRCReestablishment message to resume SRB1 operation and re-activate security on NR Cell 1.	<--	NR RRC: RRCReestablishment	-	-
11	The UE transmits an RRCReestablishmentComplete message	-->	NR RRC: RRCReestablishmentComplete	-	-
12	The SS transmits an RRCReconfiguration message to resume existing radio bearer on NR Cell 1 and configure NR Cell 3 as an SCell	<--	NR RRC: RRCReconfiguration	-	-
13	The UE transmits an RRCConnectionReconfigurationComplete message on NR Cell 1	-->	NR RRC: RRCReconfigurationComplete	-	-
14	The SS transmits an RRCReconfiguration message on NR Cell 1 to setup event A3 reporting configuration.	<--	NR RRC: RRCReconfiguration	-	-
15	The UE transmits an RRCReconfigurationComplete message on NR Cell 1.	-->	NR RRC: RRCReconfigurationComplete	-	-
16	The SS changes NR Cell 1 and NR Cell 3 parameters according to the row "T3" in table 8.1.4.1.9.1.3.2-1/1A	-	-	-	-
17	The UE transmits a MeasurementReport message on NR Cell 1 to report event A3 with the measured RSRP, RSRQ value for NR Cell 3.	-->	NR RRC: MeasurementReport	-	-
18	The SS transmits an RRCReconfiguration message on NR Cell 1 to order the UE to perform handover to NR Cell 3 and to release SCell NR Cell3.	<--	NR RRC: RRCReconfiguration	-	-
-	EXCEPTION: In parallel to the events described in step 19 the steps specified in Table 8.1.4.1.9.1.3.2-3 should take place.	-	-	-	-

19	The SS changes NR Cell 1 and NR Cell 3 parameters according to the row "T4" in table 8.1.4.1.9.1.3.2-1/1A	-	-	-	-
20	Check: Does the UE transmit an <i>RRCReestablishmentRequest</i> message on NR Cell 3?	-->	NR RRC: <i>RRCReestablishmentRequest</i>	2	P
21	The SS transmits an <i>RRCReestablishment</i> message to resume SRB1 operation and re-activate security on NR Cell 3.	<--	NR RRC: <i>RRCReestablishment</i>	-	-
22	The UE transmits an <i>RRCReestablishmentComplete</i> message	-->	NR RRC: <i>RRCReestablishmentComplete</i>	-	-
23	The SS transmits an <i>RRCReconfiguration</i> message to resume existing radio bearer on NR Cell 3.	<--	NR RRC: <i>RRCReconfiguration</i>	-	-
24	The UE transmits an <i>RRCReconfigurationComplete</i> message on NR Cell 3.	-->	NR RRC: <i>RRCReconfigurationComplete</i>	-	-

Table 8.1.4.1.9.1.3.2-3: Parallel behaviour

St	Procedure	Message Sequence		TP	Verdict
		U - S	Message		
-	EXCEPTION: The steps 1 and 2 below are repeated for the duration of T304.	-	-	-	-
1	The UE attempts to perform the inter frequency handover using MAC Random Access Preamble on NR Cell 3.	-	-	-	-
2	The SS does not respond.	-	-	-	-

8.1.4.1.9.1.3.3 Specific message contents

Table 8.1.4.1.9.1.3.3-1: SIB1 for NR Cell 1 and NR Cell 3 (Preamble and all the steps in Table 8.1.4.1.9.1.3.2-2)

Derivation path: 38.508-1 [4] table 4.6.3-130			
Information Element	Value/Remark	Comment	Condition
SIB1 ::= SEQUENCE {			
servingCellConfigCommon SEQUENCE {			
ServingCellConfigCommonSIBSEQUENCE {			
UplinkConfigCommon{			
UplinkConfigCommonSIB SEQUENCE {			
initialUplinkBWP{			
BWP-UplinkCommon SEQUENCE {			
RACH-ConfigCommon SEQUENCE {			
RACH-ConfigGeneric SEQUENCE {			
preambleTransMax	n50		
}			
}			
}			
}			
}			
}			
}			
}			

Table 8.1.4.1.9.1.3.3-2: RRCReconfiguration (step 1 and 12, Table 8.1.4.1.9.1.3.2-2)

Derivation Path: TS 38.508-1[4], table 4.6.1-13			
Information Element	Value/Remark	Comment	Condition
RRCReconfiguration ::= SEQUENCE {			
criticalExtensions CHOICE {			
rrcReconfiguration SEQUENCE {			
masterCellGroup	CellGroupConfig		
}			
}			
}			
}			

Table 8.1.4.1.9.1.3.3-3: CellGroupConfig (Table 8.1.4.1.9.1.3.3-2)

Derivation path: 38.508-1 [4] table 4.6.1-19			
Information Element	Value/Remark	Comment	Condition
CellGroupConfig ::= SEQUENCE {			
sCellToAddModList SEQUENCE (SIZE (1..maxNrofSCells)) OF SCellConfig {	1 entry		
SCellConfig[1] SEQUENCE {		entry 1	
sCellIndex	1		
sCellConfigCommon	ServingCellConfigCommon		
sCellConfigDedicated	ServingCellConfig		
}			
}			
sCellToReleaseList	Not present		
}			

Table 8.1.4.1.9.1.3.3-4: ServingCellConfigCommon (Table 8.1.4.1.9.1.3.3-3)

Derivation Path: 38.508-1 [4] Table 4.6.3-168			
Information Element	Value/remark	Comment	Condition
ServingCellConfigCommon ::= SEQUENCE {			
physCellId	Physical layer cell identity of NR Cell 3		
}			

Table 8.1.4.1.9.1.3.3-5: RRCReconfiguration (step 3 and 14, Table 8.1.4.1.9.1.3.2-2)

Derivation Path: TS 38.508-1[4], table 4.6.1-13 and condition MEAS			

Table 8.1.4.1.9.1.3.3-6: MeasConfig (Table 8.1.4.1.9.1.3.3-5)

Derivation path: 38.508-1[4], table 4.6.3-69			
Information Element	Value/Remark	Comment	Condition
measConfig ::= SEQUENCE {			
measObjectToAddModList SEQUENCE (SIZE (1..maxNrofMeasId)) OF MeasObjectToAddMod {	2 entries		
MeasObjectToAddMod[1] SEQUENCE {		entry 1	
measObjectId	1		
measObject CHOICE {			
measObjectNR	MeasObjectNR-f1	NR Cell 1	
}			
}			
MeasObjectToAddMod[2] SEQUENCE {		entry 2	
measObjectId	2		
measObject CHOICE {			
measObjectNR	MeasObjectNR-f2	NR Cell 3	
}			
}			
} SEQUENCE(SIZE (1..maxReportConfigId)) OF ReportConfigToAddMod {	1 entry		
ReportConfigToAddMod[1] SEQUENCE {		entry 1	
reportConfigId[1]	1		
reportConfig[1] CHOICE {			
reportConfigNR	ReportConfigNR-A3		
}			
}			
} SEQUENCE (SIZE (1..maxNrofMeasId)) OF MeasIdToAddMod {	2 entries		
MeasIdToAddMod[1] SEQUENCE {		entry 1	
measId	1		
measObjectId	1		
reportConfigId	1		
}			
MeasIdToAddMod[2] SEQUENCE {		entry 2	
measId	2		
measObjectId	2		
reportConfigId	1		
}			
}			

Table 8.1.4.1.9.1.3.3-7: MeasObjectNR-f1 (Table 8.1.4.1.9.1.3.3-6)

Derivation Path: TS 38.331 [6], clause 6.3.2			
Information Element	Value/remark	Comment	Condition
MeasObjectNR ::= SEQUENCE {			
ssbFrequency	Downlink ARFCN of NR Cell 1 SSB		
}			

Table 8.1.4.1.9.1.3.3-8: MeasObjectNR-f2 (Table 8.1.4.1.9.1.3.3-6)

Derivation Path: TS 38.331 [6], clause 6.3.2			
Information Element	Value/remark	Comment	Condition
MeasObjectNR ::= SEQUENCE {			
ssbFrequency	Downlink ARFCN of NR Cell 3 SSB		
}			

Table 8.1.4.1.9.1.3.3-9: ReportConfigNR-A3 (Table 8.1.4.1.9.1.3.3-5)

Derivation Path: 38.508-1 [4], table 4.6.3-142 with condition EVENT_A3			
Information Element	Value/remark	Comment	Condition
ReportConfigNR ::= SEQUENCE {			
reportType CHOICE {			
eventTriggered SEQUENCE {			
eventId CHOICE {			
eventA3 SEQUENCE {			
a3-Offset CHOICE {			
rsrp	FFS		FR1
	FFS		FR2
}			
timeToTrigger	ms2560		
}			
}			
}			

Table 8.1.4.1.9.1.3.3-10: MeasurementReport (step 6 and 17, Table 8.1.4.1.9.1.3.2-2)

Derivation Path: TS 38.508-1 [4], table 4.6.1-5A			
Information Element	Value/remark	Comment	Condition
MeasurementReport ::= SEQUENCE {			
criticalExtensions CHOICE {			
measurementReport SEQUENCE {			
measResults SEQUENCE {			
measId	1		
measResultServingMOList SEQUENCE (SIZE (1..maxNrofServingCells)) OF MeasResultServMO {	1 entry		
MeasResultServMO[1] SEQUENCE {		entry 1	
servCellId	ServCellIndex of NR Cell 1		
measResultServingCell SEQUENCE {			
physCellId	PhysCellId of NR Cell 1		
measResult SEQUENCE {			
cellResults SEQUENCE {			
resultsSSB-Cell SEQUENCE {			
rsrp	(0..127)		
rsrq	(0..127)		
sinr	(0..127)		pc_ss_SINR_Meas
}	Not present		
}			
resultsCSI-RS-Cell	Not present		
}			
rsIndexResults	Not present		
}			
}			
measResultBestNeighCell	Not present		
}			
}			
measResultNeighCells CHOICE {	1 entry		
measResultListNR SEQUENCE (SIZE (1..maxCellReport)) OF MeasResultNR {			
MeasResultNR[1] SEQUENCE {		entry 1	
physCellId	PhysCellId of NR Cell 3		
measResult SEQUENCE {			
cellResults SEQUENCE {			
resultsSSB-Cell SEQUENCE {			
Rsrp	(0..127)		
Rsrq	(0..127)		
Sinr	(0..127)		
}			
}			
resultsCSI-RS-Cell	Not present		
}			
rsIndexResults	Not present		
}			
}			
}			
}			
}			
}			
}			
}			
}			
}			

Table 8.1.4.1.9.1.3.3-11: RRCReconfiguration (step 7 and 18, Table 8.1.4.1.9.1.3.2-2)

Derivation Path: TS 38.508-1[4], table 4.6.1-13 with condition NR			
Information Element	Value/Remark	Comment	Condition
RRCReconfiguration ::= SEQUENCE {			
criticalExtensions CHOICE {			
rrcReconfiguration SEQUENCE {			
nonCriticalExtension SEQUENCE {			
masterCellGroup	CellGroupConfig		
}			
}			
}			

Table 8.1.4.1.9.1.3.3-12: CellGroupConfig (Table 8.1.4.1.9.1.3.3-11)

Derivation path: 38.508-1 [4] table 4.6.3-19			
Information Element	Value/remark	Comment	Condition
CellGroupConfig ::= SEQUENCE {			
spCellConfig SEQUENCE {			
servCellIndex	ServCellIndex of NR Cell 3		
reconfigurationWithSync SEQUENCE {			
spCellConfigCommon SEQUENCE {			
physCellId	PhysCellId of NR Cell 3		
downlinkConfigCommon SEQUENCE {			
frequencyInfoDL SEQUENCE {			
absoluteFrequencySSB	Downlink ARFCN of NR Cell 3 SSB		
}			
}			
}			
t304	ms1000		
rach-ConfigDedicated CHOICE {			
RACH-ConfigDedicated SEQUENCE {			
CFRA-SSB-ResourceSEQUENCE {			
ra-PreambleIndex	63		
}			
}			
}			
sCellToReleaseList SEQUENCE (SIZE (1..maxNrofSCells)) OF SCellIndex {	1 entry		
SCellIndex[1] SEQUENCE {		entry 1	
sCellIndex	1		
}			
}			
}			

Table 8.1.4.1.9.1.3.3-13: RRCReestablishmentRequest (step 9 and 20, Table 8.1.4.1.9.1.3.2-2)

Derivation Path: TS 38.508-1 [4], table 4.6.1-12			
Information Element	Value/remark	Comment	Condition
RRCReestablishmentRequest ::= SEQUENCE {			
ue-Identity SEQUENCE {			
physCellId	PhysCellId of NR Cell 1		
}			
reestablishmentCause	handoverFailure		
}			

Table 8.1.4.1.9.1.3.3-14: RRCReestablishment (step 10 and 21, Table 8.1.4.1.9.1.3.2-2)

Derivation Path: TS 38.508-1 [4], table 4.6.1-10			
Information Element	Value/remark	Comment	Condition
RRCReestablishment ::= SEQUENCE {			
criticalExtensions CHOICE {			
rrcReestablishment SEQUENCE {			
nextHopChainingCount	0		
}			
}			
}			

Table 8.1.4.1.9.1.3.3-15: RRCReconfiguration (step 12, Table 8.1.4.1.9.1.3.2-2)

Derivation Path: TS 38.508-1 [4], table 4.6.1-13 with condition REEST			
Information Element	Value/remark	Comment	Condition
RRCReconfiguration ::= SEQUENCE {			
criticalExtensions CHOICE {			
rrcReconfiguration ::= SEQUENCE {			
nonCriticalExtension ::= SEQUENCE {			
masterCellGroup	CellGroupConfig with condition SCell_add and REEST		
}			
}			
}			

Table 8.1.4.1.9.1.3.3-16: RRCReconfiguration (step 23, Table 8.1.4.1.9.1.3.2-2)

Derivation Path: TS 38.508-1 [4], table 4.6.1-13 with condition REEST			

8.1.4.1.9.2 NR CA / Intra NR handover / Failure / Re-establishment successful / Inter-band CA

8.1.4.1.9.2.1 Test Purpose (TP)

Same as TC 8.1.4.1.9.1 but applied to Inter-band CA case

8.1.4.1.9.2.2 Conformance requirements

Same as TC 8.1.4.1.9.1 but applied to Inter-band CA case

8.1.4.1.9.2.3 Test Description

8.1.4.1.9.2.3.1 Pre-test conditions

Same as test case 8.1.4.1.9.1 with the following differences:

- CA configuration: Inter-band CA replaces Intra-band Contiguous CA.
- Cells configuration: NR Cell 10 replaces NR Cell 3.
- NR Cell 10 is an Inactive SCell according to TS 38.508-1 [4] clause 6.3.1.

8.1.4.1.9.2.3.2 Test procedure sequence

Same as test case 8.1.4.1.9.1 with the following differences:

- CA configuration: Inter-band CA replaces Intra-band Contiguous CA.

- Cells configuration: NR Cell 10 replaces NR Cell 3.

8.1.4.1.9.2.3.3 Specific message contents

Same as TC 8.1.4.1.9.1 but applied to Inter-band CA case

8.1.4.1.9.3 NR CA / Intra NR handover / Failure / Re-establishment successful / Intra-band non-contiguous CA

8.1.4.1.9.3.1 Test Purpose (TP)

Same as TC 8.1.4.1.9.1 but applied to Intra-band non-contiguous CA case

8.1.4.1.9.3.2 Conformance requirements

Same as TC 8.1.4.1.9.1 but applied to Intra-band non-contiguous CA case

8.1.4.1.9.3.3 Test Description

8.1.4.1.9.3.3.1 Pre-test conditions

Same as test case 8.1.4.1.9.1 with the following differences:

- CA configuration: Intra-band Contiguous CA replaces Intra-band non-contiguous CA.

8.1.4.1.9.3.3.2 Test procedure sequence

Same as test case 8.1.4.1.9.1 with the following differences:

- CA configuration: Inter-band CA replaces Intra-band Contiguous CA.

8.1.4.1.9.3.3.3 Specific message contents

Same as TC 8.1.4.1.9.1 but applied to Intra-band non-contiguous CA case

8.1.4.2 Inter-RAT handover

8.1.4.2.1 Inter-RAT handover from NR

8.1.4.2.1.1 Inter-RAT handover / From NR to E-UTRA / Success

8.1.4.2.1.1.1 Test Purpose (TP)

(1)

```
with { UE in NR RRC_CONNECTED state }
ensure that {
  when { UE receives a MobilityFromNRCommand message }
  then { UE transmits an RRCConnectionReconfigurationComplete message on the E-UTRA cell }
}
```

8.1.4.2.1.1.2 Conformance requirements

References: The conformance requirements covered in the present TC are specified in: TS 38.331, clause 5.4.3.2, clause 5.4.3.3 and clause 5.4.3.4 and TS 36.331, clause 5.4.2.2 and clause 5.4.2.3.

[TS.38.331, clause 5.4.3.2]

The network initiates the mobility from NR procedure to a UE in RRC_CONNECTED, possibly in response to a MeasurementReport message, by sending a MobilityFromNRCommand message. The network applies the procedure as follows:

- the procedure is initiated only when AS-security has been activated, and SRB2 with at least one DRB are setup and not suspended.

[TS 38.331, clause 5.4.3.3]

The UE shall:

- 1> if the targetRAT-Type is set to eutra:
 - 2> consider inter-RAT mobility as initiated towards E-UTRA;
 - 2> forward the nas-SecurityParamFromNR to the upper layers, if included;
- 1> access the target cell indicated in the inter-RAT message in accordance with the specifications of the target RAT.

[TS.38.331, clause 5.4.3.4]

Upon successfully completing the handover, at the source side the UE shall:

- 1> reset MAC;
- 1> stop all timers that are running;
- 1> release *ran-NotificationAreaInfo*, if stored;
- 1> release the AS security context including the K_{RRCEnc} key, the K_{RRCint} , the K_{UPint} key and the K_{UPenc} key, if stored;
- 1> release all radio resources, including release of the RLC entity and the MAC configuration;
- 1> release the associated PDCP entity and SDAP entity for all established RBs;

NOTE : PDCP and SDAP configured by the source RAT prior to the handover that are reconfigured and re-used by target RAT when delta signalling (i.e., during inter-RAT intra-system handover when *fullConfig* is not present) is used, are not released as part of this procedure.

- 1> indicate the release of the RRC connection to upper layers together with the release cause 'other'.

[TS 36.331, clause 5.4.2.2]

The RAN using another RAT or the E-UTRA connected to a different type of CN initiates the handover to E-UTRA procedure, in accordance with the specifications applicable for the other RAT or for the E-UTRA connected to a different type of CN, by sending the *RRCCConnectionReconfiguration* message via the radio access technology from which the inter-RAT handover is performed.

E-UTRAN applies the procedure as follows:

- to activate ciphering, possibly using NULL algorithm, if not yet activated in the other RAT or in the E-UTRA connected to a different type of CN;
- to establish SRB1, SRB2 and one or more DRBs, i.e. at least the DRB associated with the default EPS bearer is established if the target CN is EPC and at least one DRB is established if the target CN is 5GC.

[TS 36.331, clause 5.4.2.3]

If the UE is able to comply with the configuration included in the *RRCCConnectionReconfiguration* message, the UE shall:

- 1> if the *RRCCConnectionReconfiguration* message includes the *fullConfig* and the source RAT was E-UTRA(i.e., intra-RAT inter-system handover):
 - ...
- 1> apply the default physical channel configuration as specified in 9.2.4;

- 1> apply the default semi-persistent scheduling configuration as specified in 9.2.3;
- 1> apply the default MAC main configuration as specified in 9.2.2;
- 1> start timer T304 with the timer value set to t304, as included in the mobilityControlInfo;
- 1> consider the target PCell to be one on the frequency indicated by the carrierFreq with a physical cell identity indicated by the targetPhysCellId;
- 1> start synchronising to the DL of the target PCell;
- 1> set the C-RNTI to the value of the newUE-Identity;
- 1> for the target PCell, apply the downlink bandwidth indicated by the dl-Bandwidth;
- 1> for the target PCell, apply the uplink bandwidth indicated by (the absence or presence of) the ul-Bandwidth;
- 1> configure lower layers in accordance with the received radioResourceConfigCommon;
- 1> configure lower layers in accordance with any additional fields, not covered in the previous, if included in the received mobilityControlInfo;
- 1> perform the radio resource configuration procedure as specified in 5.3.10;
- 1> if the handoverType in securityConfigHO is set to fivegc-ToEPC:
 - 2> indicate to higher layer that the CN has changed from 5GC to EPC;
 - 2> derive the key KeNB based on the mapped KASME key as specified for interworking between EPS and 5GS in TS 33.501 [86];
 - 2> store the nextHopChainingCount-r15 value;
- 1> else if the handoverType in securityConfigHO is set to intra5GC:
 - ...
- 1> derive the KRRCint key associated with the integrityProtAlgorithm, as specified in TS 33.401 [32];
- 1> derive the KRRCenc key and the KUPenc key associated with the cipheringAlgorithm, as specified in TS 33.401 [32];
 - ...
- 1> if the handoverType in securityConfigHO is set to fivegc-ToEPC or if the handoverType-v1530 is not present:
 - 2> configure lower layers to apply the indicated integrity protection algorithm and the KRRCint key immediately, i.e. the indicated integrity protection configuration shall be applied to all subsequent messages received and sent by the UE, including the message used to indicate the successful completion of the procedure;
 - 2> configure lower layers to apply the indicated ciphering algorithm, the KRRCenc key and the KUPenc key immediately, i.e. the indicated ciphering configuration shall be applied to all subsequent messages received and sent by the UE, including the message used to indicate the successful completion of the procedure;
- 1> if the received RRCConnectionReconfiguration includes the sCellToAddModList:
 - ...
- 1> if the RRCConnectionReconfiguration message includes the measConfig:
 - 2> perform the measurement configuration procedure as specified in 5.5.2;
 - ...
- 1> submit the RRCConnectionReconfigurationComplete message to lower layers for transmission using the new configuration;

- 1> if the RRCConnectionReconfiguration message does not include rlf-TimersAndConstants set to setup:
 - 2> use the default values specified in 9.2.5 for timer T310, T311 and constant N310, N311;
- 1> if MAC successfully completes the random access procedure:
 - 2> stop timer T304;
 - 2> apply the parts of the CQI reporting configuration, the scheduling request configuration and the sounding RS configuration that do not require the UE to know the SFN of the target PCell, if any;
 - 2> apply the parts of the measurement and the radio resource configuration that require the UE to know the SFN of the target PCell (e.g. measurement gaps, periodic CQI reporting, scheduling request configuration, sounding RS configuration), if any, upon acquiring the SFN of the target PCell;

NOTE 1: Whenever the UE shall setup or reconfigure a configuration in accordance with a field that is received it applies the new configuration, except for the cases addressed by the above statements.

- 2> enter E-UTRA RRC_CONNECTED, upon which the procedure ends;

8.1.4.2.1.1.3 Test description

8.1.4.2.1.1.3.1 Pre-test conditions

System Simulator:

- NR Cell 1 and E-UTRA Cell 1.
- System information Combination NR-6 as defined in TS 38.508 [4] clause 4.4.3.1 is used in NR cells.

UE:

- None

Preamble:

- If pc_IP_Ping is set to TRUE then, the UE is in 5GS state 3N-A according to TS 38.508-1 [4], clause 4.4A.2 Table 4.4A.2-3.
- Else, the UE is in 5GS state 3N-A and Test Loop Function (*On*) with UE test loop mode B on NR Cell 1 according to 38.508-1[4], clause 4.4A.2 Table 4.4A.2-3.
 -

8.1.4.2.1.1.3.2 Test procedure sequence

Table 8.1.4.2.1.1.3.2-1: Main behaviour

St	Procedure	Message Sequence		TP	Verdict
		U - S	Message		
1	The SS transmits a MobilityFromNRCommand message on NR Cell 1.	<--	MobilityFromNRCommand	-	-
2	Check: Does the UE transmit an RRCConnectionReconfigurationComplete message on E-UTRA Cell 1 using the security key derived from the new KeNB?	-->	RRCConnectionReconfigurationComplete	1	P
3	The UE transmits an ULInformationTransfer message on the cell specified in the test case. This message includes a TRACKING AREA UPDATE REQUEST message.	-->	RRC: ULInformationTransfer NAS: TRACKING AREA UPDATE REQUEST	-	-
4	The SS transmits a DLInformationTransfer message on the cell specified in the test case. This message includes a TRACKING AREA UPDATE ACCEPT message.	<--	RRC: DLInformationTransfer NAS: TRACKING AREA UPDATE ACCEPT	-	-
5	The UE transmits an ULInformationTransfer message on the cell specified in the test case. This message includes a TRACKING AREA UPDATE COMPLETE message.	-->	RRC: ULInformationTransfer NAS: TRACKING AREA UPDATE COMPLETE	-	-
6	Check: Does the test result of generic test procedure in TS 38.508-1 subclause 4.9.1 indicate that the UE is capable of exchanging IP data on DRB#n associated with the first EPS bearer?	-	-	1	P

8.1.4.2.1.1.3.3 Specific message contents

Table 8.1.4.2.1.1.3.3-1: MobilityFromNRCommand (step 1, Table 8.1.4.2.1.1.3.2-1)

Derivation Path: TS 38.508-1 [4], Table 4.6.1-8			
Information Element	Value/remark	Comment	Condition
MobilityFromNRCommand ::= SEQUENCE {			
rrc-TransactionIdentifier	RRC-TransactionIdentifier		
criticalExtensions CHOICE {			
mobilityFromNRCommand SEQUENCE {			
targetRAT-Type	eutra		
targetRAT-MessageContainer	DL-DCCH message containing RRCConnectionReconfiguration		
nas-SecurityParamFromNR	8 LSB of the downlink NAS COUNT		
}			
}			
}			

Table 8.1.4.2.1.1.3.3-2: RRCConnectionReconfiguration (Table 8.1.4.2.1.1.3.3-1)

Derivation Path: 36.508-1, Table 4.6.1-8, condition HO-TO-EUTRA(1,0)
--

Table 8.1.4.2.1.1.3.3-3: MobilityControllInfo (Table 8.1.4.2.1.1.3.3-1)

Derivation Path: 36.508 [7], Table 4.6.5-1, condition HO-TO-EUTRA			
Information Element	Value/remark	Comment	Condition
MobilityControllInfo ::= SEQUENCE {			
targetPhysCellId	PhysicalCellIdentity of E-UTRA Cell 1		
carrierFreq SEQUENCE {			
dl-CarrierFreq	Same downlink EARFCN as used for E-UTRA Cell 1		
}			
carrierFreq	Not present		Band > 64
carrierBandwidth SEQUENCE {			
dl-Bandwidth	Downlink system bandwidth under test.		
ul-Bandwidth	Uplink Bandwidth under test.		FDD
ul-Bandwidth	Not present		TDD
}			
carrierFreq-v9e0 SEQUENCE {			Band > 64
dl-CarrierFreq-v9e0	Same downlink EARFCN as used for E-UTRA Cell 1		
}			
}			

Condition	Explanation
FDD	FDD cell environment
TDD	TDD cell environment
Band > 64	If band > 64 is selected

Table 8.1.4.2.1.1.3.3-4: SecurityConfigHO (Table 8.1.4.2.1.1.3.3-1)

Derivation Path: 36.508-1, Table 4.6.4-1			
Information Element	Value/remark	Comment	Condition
SecurityConfigHO-v1530 ::= SEQUENCE {			
handoverType-v1530 CHOICE {			
fivegc-ToEPC-r15 SEQUENCE {			
securityAlgorithmConfig-r15 SEQUENCE {			
cipherringAlgorithm	Set according to PIXIT parameter for default cipherring algorithm		
integrityProtAlgorithm	Set according to PIXIT parameter for default integrity protection algorithm		
}			
}			
nextHopChainingCount-r15	2		
}			
}			

Table 8.1.4.2.1.1.3.3-5: RadioResourceConfigDedicated-HO-TO-EUTRA (Table 8.1.4.2.1.1.3.3-1)

Derivation Path: 36.508-1, Table 4.6.3-18, condition HO-TO-EUTRA(1,0)

Table 8.1.4.2.1.1.3.3-6: TRACKING AREA UPDATE REQUEST (step 3, Table 8.1.4.2.1.1.3.2-1)

Derivation Path: 36.508-1 clause 4.7.2-27			
Information Element	Value/remark	Comment	Condition
EPS update type			
EPS update type Value	'000'B	TA updating	TA_only
	'001'B	Combined TA/LA updating	combined_TA_LA_without_IMSI
	'010'B	Combined TA/LA updating with IMSI attach	combined_TA_LA
NAS key set identifier			
NAS Key Set Identifier	The value of ngKSI assigned in preamble		
Type of security context flag	'1'B	Mapped security context	
Non-current native NAS key set identifier	Not present or any allowed value		
Old GUTI	Mapped 5G-GUTI		
GUTI type	Native		
Additional GUTI	Any value or not present		
UE status	UE is in 5GMM-REGISTERED state		

Condition	Explanation
TA_only	The UE is configured to initiate EPS attach
combined_TA_LA	The UE is configured to initiate combined EPS/IMSI attach
combined_TA_LA_without_IMSI	The UE is configured to initiate combined attach

Table 8.1.4.2.1.1.3.3-7: Void

8.1.4.2.1.2 Inter-RAT handover / From NR to EN-DC / Success

8.1.4.2.1.2.1 Test Purpose (TP)

(1)

```
with { UE in NR RRC_CONNECTED state }
ensure that {
  when { UE receives a MobilityFromNRCommand message }
  then { UE transmits an RRCConnectionReconfigurationComplete message on the EN-DC cell }
}
```

8.1.4.2.1.2.2 Conformance requirements

References: The conformance requirements covered in the present TC are specified in: TS 38.331, clause 5.4.3.2, clause 5.4.3.3 and clause 5.4.3.4 and TS 36.331, clause 5.4.2.2 and clause 5.4.2.3.

[TS.38.331, clause 5.4.3.2]

The network initiates the mobility from NR procedure to a UE in RRC_CONNECTED, possibly in response to a MeasurementReport message, by sending a MobilityFromNRCommand message. The network applies the procedure as follows:

- the procedure is initiated only when AS-security has been activated, and SRB2 with at least one DRB are setup and not suspended.

[TS 38.331, clause 5.4.3.3]

The UE shall:

- 1> if the targetRAT-Type is set to eutra:
 - 2> consider inter-RAT mobility as initiated towards E-UTRA;
 - 2> forward the nas-SecurityParamFromNR to the upper layers, if included;
- 1> access the target cell indicated in the inter-RAT message in accordance with the specifications of the target RAT.

[TS.38.331, clause 5.4.3.4]

Upon successfully completing the handover, at the source side the UE shall:

- 1> reset MAC;
- 1> stop all timers that are running;
- 1> release *ran-NotificationAreaInfo*, if stored;
- 1> release the AS security context including the K_{RRCEnc} key, the K_{RRCint} , the K_{UPint} key and the K_{UPenc} key, if stored;
- 1> release all radio resources, including release of the RLC entity and the MAC configuration;
- 1> release the associated PDCP entity and SDAP entity for all established RBs;

NOTE: PDCP and SDAP configured by the source RAT prior to the handover that are reconfigured and re-used by target RAT when delta signalling (i.e., during inter-RAT intra-system handover when *fullConfig* is not present) is used, are not released as part of this procedure.

- 1> indicate the release of the RRC connection to upper layers together with the release cause 'other'.

[TS 36.331, clause 5.4.2.2]

The RAN using another RAT or the E-UTRA connected to a different type of CN initiates the handover to E-UTRA procedure, in accordance with the specifications applicable for the other RAT or for the E-UTRA connected to a different type of CN, by sending the *RRCCConnectionReconfiguration* message via the radio access technology from which the inter-RAT handover is performed.

E-UTRAN applies the procedure as follows:

- to activate ciphering, possibly using NULL algorithm, if not yet activated in the other RAT or in the E-UTRA connected to a different type of CN;
- to establish SRB1, SRB2 and one or more DRBs, i.e. at least the DRB associated with the default EPS bearer is established if the target CN is EPC and at least one DRB is established if the target CN is 5GC.

[TS 36.331, clause 5.4.2.3]

If the UE is able to comply with the configuration included in the *RRCCConnectionReconfiguration* message, the UE shall:

- 1> if the *RRCCConnectionReconfiguration* message includes the *fullConfig* and the source RAT was E-UTRA (i.e., intra-RAT inter-system handover):
- ...
- 1> apply the default physical channel configuration as specified in 9.2.4;
- 1> apply the default semi-persistent scheduling configuration as specified in 9.2.3;
- 1> apply the default MAC main configuration as specified in 9.2.2;
- 1> start timer T304 with the timer value set to t_{304} , as included in the *mobilityControlInfo*;
- 1> consider the target PCell to be one on the frequency indicated by the *carrierFreq* with a physical cell identity indicated by the *targetPhysCellId*;
- 1> start synchronising to the DL of the target PCell;

- 1> set the C-RNTI to the value of the newUE-Identity;
- 1> for the target PCell, apply the downlink bandwidth indicated by the dl-Bandwidth;
- 1> for the target PCell, apply the uplink bandwidth indicated by (the absence or presence of) the ul-Bandwidth;
- 1> configure lower layers in accordance with the received radioResourceConfigCommon;
- 1> configure lower layers in accordance with any additional fields, not covered in the previous, if included in the received mobilityControlInfo;
- 1> perform the radio resource configuration procedure as specified in 5.3.10;
- 1> if the handoverType in securityConfigHO is set to fivegc-ToEPC:
 - 2> indicate to higher layer that the CN has changed from 5GC to EPC;
 - 2> derive the key KeNB based on the mapped KASME key as specified for interworking between EPS and 5GS in TS 33.501 [86];
 - 2> store the nextHopChainingCount-r15 value;
- 1> else if the handoverType in securityConfigHO is set to intra5GC:
 - ...
- 1> derive the KRRCint key associated with the integrityProtAlgorithm, as specified in TS 33.401 [32];
- 1> derive the KRRCenc key and the KUPenc key associated with the cipheringAlgorithm, as specified in TS 33.401 [32];
 - ...
- 1> if the handoverType in securityConfigHO is set to fivegc-ToEPC or if the handoverType-v1530 is not present:
 - 2> configure lower layers to apply the indicated integrity protection algorithm and the KRRCint key immediately, i.e. the indicated integrity protection configuration shall be applied to all subsequent messages received and sent by the UE, including the message used to indicate the successful completion of the procedure;
 - 2> configure lower layers to apply the indicated ciphering algorithm, the KRRCenc key and the KUPenc key immediately, i.e. the indicated ciphering configuration shall be applied to all subsequent messages received and sent by the UE, including the message used to indicate the successful completion of the procedure;
- 1> if the received RRCConnectionReconfiguration includes the sCellToAddModList:
 - ...
- 1> if the RRCConnectionReconfiguration message includes the measConfig:
 - 2> perform the measurement configuration procedure as specified in 5.5.2;
 - ...
- 1> submit the RRCConnectionReconfigurationComplete message to lower layers for transmission using the new configuration;
- 1> if the RRCConnectionReconfiguration message does not include rlf-TimersAndConstants set to setup:
 - 2> use the default values specified in 9.2.5 for timer T310, T311 and constant N310, N311;
- 1> if MAC successfully completes the random access procedure:
 - 2> stop timer T304;
 - 2> apply the parts of the CQI reporting configuration, the scheduling request configuration and the sounding RS configuration that do not require the UE to know the SFN of the target PCell, if any;

- 2> apply the parts of the measurement and the radio resource configuration that require the UE to know the SFN of the target PCell (e.g. measurement gaps, periodic CQI reporting, scheduling request configuration, sounding RS configuration), if any, upon acquiring the SFN of the target PCell;

NOTE 1: Whenever the UE shall setup or reconfigure a configuration in accordance with a field that is received it applies the new configuration, except for the cases addressed by the above statements.

- 2> enter E-UTRA RRC_CONNECTED, upon which the procedure ends;

[TS 36.331, clause 5.3.5.4]

If the *RRCCConnectionReconfiguration* message includes the *mobilityControlInfo* and the UE is able to comply with the configuration included in this message, the UE shall:

- 1> if the *RRCCConnectionReconfiguration* message includes the *fullConfig*:

...

- 1> if the received *RRCCConnectionReconfiguration* includes the *sk-Counter*:

- 2> perform key update procedure as specified in in TS 38.331 [82], clause 5.3.5.7;

- 1> if the received *RRCCConnectionReconfiguration* includes the *nr-SecondaryCellGroupConfig*:

- 2> perform NR RRC Reconfiguration as specified in TS 38.331 [82], clause 5.3.5.3.

...

- 1> set the content of *RRCCConnectionReconfigurationComplete* message as follows:

...

- 2> if the received *RRCCConnectionReconfiguration* message included *nr-SecondaryCellGroupConfig*:

- 3> include *scg-ConfigResponseNR* in accordance with TS 38.331 [82], clause 5.3.5.3;

- 1> submit the *RRCCConnectionReconfigurationComplete* message to lower layers for transmission;

8.1.4.2.1.2.3 Test description

8.1.4.2.1.2.3.1 Pre-test conditions

System Simulator:

- NR Cell 1 is the serving cell
- EUTRA Cell 1 is the PCell and NR Cell 3 is the PS Cell are the target cells

UE:

- None

Preamble:

- If *pc_IP_Ping* is set to TRUE then, the UE is in 5GS state 3N-A according to TS 38.508-1 [4], clause 4.4A.2 Table 4.4A.2-3.
- Else, the UE is in 5GS state 3N-A and Test Loop Function (*On*) with UE test loop mode B on NR Cell 1 according to 38.508-1[4], clause 4.4A.2 Table 4.4A.2-3.

8.1.4.2.1.2.3.2 Test procedure sequence

Table 8.1.4.2.1.2.3.2-1: Main behaviour

St	Procedure	Message Sequence		TP	Verdict
		U - S	Message		
1	The SS transmits a <i>MobilityFromNRCommand</i> message on NR Cell 1, and <i>RRCReconfiguration</i> message should contain <i>nr-SecondaryCellGroupConfig</i> with the configuration of NR cell 3	<--	<i>MobilityFromNRCommand</i>	-	-
2	Check: Does the UE transmit an <i>RRCConnectionReconfigurationComplete</i> containing NR <i>RRCReconfigurationComplete</i> message on E-UTRA Cell 1 using the security key derived from the new KeNB and sk-Counter?	-->	<i>RRCConnectionReconfigurationComplete</i> (<i>RRCReconfigurationComplete</i>)	1	P
3	The UE transmits an <i>ULInformationTransfer</i> message on the cell specified in the test case. This message includes a TRACKING AREA UPDATE REQUEST message.	-->	RRC: <i>ULInformationTransfer</i> NAS: TRACKING AREA UPDATE REQUEST	-	-
4	The SS transmits a <i>DLInformationTransfer</i> message on the cell specified in the test case. This message includes a TRACKING AREA UPDATE ACCEPT message.	<--	RRC: <i>DLInformationTransfer</i> NAS: TRACKING AREA UPDATE ACCEPT	-	-
5	The UE transmits an <i>ULInformationTransfer</i> message on the cell specified in the test case. This message includes a TRACKING AREA UPDATE COMPLETE message.	-->	RRC: <i>ULInformationTransfer</i> NAS: TRACKING AREA UPDATE COMPLETE	-	-
6	Check: Does the test result of generic test procedure in TS 38.508-1 subclause 4.9.1 indicate that the UE is capable of exchanging IP data on DRB#n associated with default PDN connection in EUTRA Cell 1 and DRB#m associated with PDU session in NR Cell 3	-	-	1	P

8.1.4.2.1.2.3.3 Specific message contents

Table 8.1.4.2.1.2.3.3-1: *MobilityFromNRCommand* (step 1, Table 8.1.4.2.1.2.3.2-1)

Derivation Path: TS 38.508-1 [4], Table 4.6.1-8			
Information Element	Value/remark	Comment	Condition
<i>MobilityFromNRCommand</i> ::= SEQUENCE {			
<i>rrc-TransactionIdentifier</i>	RRC-TransactionIdentifier		
criticalExtensions CHOICE {			
<i>mobilityFromNRCommand</i> SEQUENCE {			
<i>targetRAT-Type</i>	eutra		
<i>targetRAT-MessageContainer</i>	DL-DCCH message containing <i>RRCConnectionReconfiguration</i>		
<i>nas-SecurityParamFromNR</i>	8 LSB of the downlink NAS COUNT		
}			
}			
}			

Table 8.1.4.2.1.2.3.3-2: *RRCConnectionReconfiguration* (Table 8.1.4.2.1.2.3.3-1)

Derivation Path: 36.508-1, Table 4.6.1-8, condition HO-TO-EN-DC(1,0)
--

Table 8.1.4.2.1.2.3.3-3: MobilityControllInfo (Table 8.1.4.2.1.2.3.3-1)

Derivation Path: 36.508 [7], Table 4.6.5-1, condition HO-TO-EN-DC			
Information Element	Value/remark	Comment	Condition
MobilityControllInfo ::= SEQUENCE {			
targetPhysCellId	PhysicalCellIdentity of E-UTRA Cell 1		
carrierFreq SEQUENCE {			
dl-CarrierFreq	Same downlink EARFCN as used for E-UTRA Cell 1		
}			
carrierFreq	Not present		Band > 64
carrierBandwidth SEQUENCE {			
dl-Bandwidth	Downlink system bandwidth under test.		
ul-Bandwidth	Uplink Bandwidth under test.		FDD
ul-Bandwidth	Not present		TDD
}			
carrierFreq-v9e0 SEQUENCE {			Band > 64
dl-CarrierFreq-v9e0	Same downlink EARFCN as used for E-UTRA Cell 1		
}			
}			

Condition	Explanation
FDD	FDD cell environment
TDD	TDD cell environment
Band > 64	If band > 64 is selected

Table 8.1.4.2.1.2.3.3-4: SecurityConfigHO (Table 8.1.4.2.1.2.3.3-1)

Derivation Path: 36.508-1, Table 4.6.4-1			
Information Element	Value/remark	Comment	Condition
SecurityConfigHO-v1530 ::= SEQUENCE {			
handoverType-v1530 CHOICE {			
fivegc-ToEPC-r15 SEQUENCE {			
securityAlgorithmConfig-r15 SEQUENCE {			
cipheringAlgorithm	Set according to PIXIT parameter for default ciphering algorithm		
integrityProtAlgorithm	Set according to PIXIT parameter for default integrity protection algorithm		
}			
}			
nextHopChainingCount-r15	2		
}			
}			

Table 8.1.4.2.1.2.3.3-5: RadioResourceConfigDedicated-HO-TO-EUTRA (Table 8.1.4.2.1.2.3.3-1)

Derivation Path: 36.508-1, Table 4.6.3-18, condition HO-TO-EUTRA(1,0)

Table 8.1.4.2.1.2.3.3-6: RRCConnectionReconfigurationComplete (step 2, Table 8.1.4.2.1.2.3.2-1)

Derivation Path: 36.508-1, Table 4.6.1-9, condition HO-TO-EN-DC(1,0)

Table 8.1.4.2.1.2.3.3-7: TRACKING AREA UPDATE REQUEST (step 3, Table 8.1.4.2.1.2.3.2-1)

Derivation Path: 36.508-1 clause 4.7.2-27			
Information Element	Value/remark	Comment	Condition
EPS update type			
EPS update type Value	'000'B	TA updating	TA_only
	'001'B	Combined TA/LA updating	combined_TA_LA_without_IMSI
	'010'B	Combined TA/LA updating with IMSI attach	combined_TA_LA
NAS key set identifier			
NAS Key Set Identifier	The value of ngKSI assigned in preamble		
Type of security context flag	'1'B	Mapped security context	
Non-current native NAS key set identifier	Not present or any allowed value		
Old GUTI	Mapped 5G-GUTI		
GUTI type	Native		
Additional GUTI	Any value or not present		
UE status	UE is in 5GMM-REGISTERED state		

Condition	Explanation
TA_only	The UE is configured to initiate EPS attach
combined_TA_LA	The UE is configured to initiate combined EPS/IMSI attach
combined_TA_LA_without_IMSI	The UE is configured to initiate combined attach

8.1.4.2.2 Inter-RAT handover to NR

8.1.4.2.2.1 Inter-RAT handover / From E-UTRA to NR / Success

8.1.4.2.2.1.1 Test Purpose (TP)

(1)

```
with { UE in E-UTRA RRC_CONNECTED state }
ensure that {
  when { UE receives a MobilityFromEUTRACommand message }
  then { UE transmits a RRCReconfigurationComplete message on the NR cell }
}
```

8.1.4.2.2.1.2 Conformance requirements

References: The conformance requirements covered in the current TC are specified in: TS 38.331, clause 5.4.2.2, 5.4.2.3, TS 36.331, clause 5.4.3.2, 5.4.3.3, 5.4.3.4. Unless otherwise stated these are Rel-15 requirements.

[TS 38.331, clause 5.4.2.2]

The RAN using another RAT initiates the handover to NR procedure, in accordance with the specifications applicable for the other RAT, by sending the *RRCReconfiguration* message via the radio access technology from which the inter-RAT handover is performed.

The network applies the procedure as follows:

- to activate ciphering, possibly using NULL algorithm, if not yet activated in the other RAT;
- to re-establish SRBs and one or more DRBs;

[TS 38.331, clause 5.4.2.3]

The UE shall:

1> perform RRC reconfiguration procedure as specified in 5.3.5;

NOTE: If the UE is connected to 5GC of the source E-UTRA cell, the delta configuration for PDCP and SDAP can be used for intra-system inter-RAT handover.

[TS 36.331, clause 5.4.3.2]

E-UTRAN initiates the mobility from E-UTRA procedure to a UE in RRC_CONNECTED, possibly in response to a *MeasurementReport* message or in response to reception of CS fallback indication for the UE from MME, by sending a *MobilityFromEUTRACCommand* message. E-UTRAN applies the procedure as follows:

- the procedure is initiated only when AS-security has been activated, and SRB2 with at least one DRB are setup and not suspended;

[TS 36.331, clause 5.4.3.3]

The UE shall be able to receive a *MobilityFromEUTRACCommand* message and perform a cell change order to GERAN, even if no prior UE measurements have been performed on the target cell.

The UE shall:

- 1> stop timer T310, if running;
- 1> stop timer T312, if running;
- 1> if T309 is running:
 - 2> stop timer T309 for all access categories;
 - 2> perform the actions as specified in 5.3.16.4.
- 1> if the *MobilityFromEUTRACCommand* message includes the *purpose* set to *handover*:
 - ...
 - 2> else if the *targetRAT-Type* is set to *nr*:
 - 3> consider inter-RAT mobility as initiated towards NR;
 - 3> access the target cell indicated in the inter-RAT message in accordance with the specifications in TS 38.331 [82];

[TS 36.331, clause 5.4.3.4]

Upon successfully completing the handover, the cell change order or enhanced 1xRTT CS fallback, the UE shall:

- ...
- 1> else if the UE is connected to 5GC prior to the reception of the *MobilityFromEUTRACCommand* and the *targetRAT-Type* in the received *MobilityFromEUTRACCommand* is set to *nr*:
 - 2> reset MAC;
 - 2> stop all timers that are running;
 - 2> release *ran-NotificationAreaInfo*, if stored;
 - 2> release the AS security context including the K_{RRCEnc} key, the K_{RRCint} , the K_{UPint} key and the K_{UPenc} key, if stored;
 - 2> release all radio resources, including release of the RLC entity and the MAC configuration and the associated PDCP entity and SDAP entity for all established RBs;

NOTE 1: PDCP and SDAP configured by the source configurations RAT prior to the handover that are reconfigured and re-used by target RAT when delta signalling (i.e., during inter-RAT intra-system handover when *fullConfig* is not present) is used, are not released as part of this procedure.

1> else:

2> perform the actions upon leaving RRC_CONNECTED as specified in 5.3.12, with release cause 'other';

NOTE 2: If the UE performs enhanced 1xRTT CS fallback along with concurrent mobility to CDMA2000 HRPD and the connection to either CDMA2000 1xRTT or CDMA2000 HRPD succeeds, then the mobility from E-UTRA is considered successful.

8.1.4.2.2.1.3 Test description

8.1.4.2.2.1.3.1 Pre-test conditions

System Simulator:

- E-UTRA Cell 1 "Serving cell" and NR Cell 1 "Non-suitable "Off" cell".
- System information combination 31 as defined in TS 36.508 [7] clause 4.4.3.1 is used in the E-UTRA cell.
- System information combination NR-6 as defined in TS 38.508-1 [4] clause 4.4.3.1.2 is used in the NR cell.

UE:

- None.

Preamble:

- The UE is in state Generic RB Established (state 3) and Test Loop Function (*On*) with UE test loop mode B on E-UTRA Cell 1 according to 36.508 [7].

8.1.4.2.2.1.3.2 Test procedure sequence

Table 8.1.4.2.2.1.3.2-1: Main behaviour

St	Procedure	Message Sequence		TP	Verdict
		U - S	Message		
0	The SS configures NR Cell 1 as the "Serving cell" and wait 5s.	-	-	-	-
1	The SS transmits a <i>MobilityFromEUTRACommand</i> message on E-UTRA Cell 1.	<-	E-UTRA RRC: <i>MobilityFromEUTRACommand</i>	-	-
2	Check: Does the UE transmit a <i>RRCReconfigurationComplete</i> message on NR Cell 1?	-->	NR RRC: <i>RRCReconfigurationComplete</i>	1	P
3	The UE transmits a <i>ULInformationTransfer</i> message and a REGISTRATION REQUEST message indicating "mobility registration updating" is sent to update the registration of the actual tracking area.	-->	NR RRC: <i>ULInformationTransfer</i> 5GMM: REGISTRATION REQUEST	-	-
4	SS sends an <i>DLInformationTransfer</i> message and a REGISTRATION ACCEPT message containing a 5G-GUTI.	<-	NR RRC: <i>DLInformationTransfer</i> 5GMM: REGISTRATION ACCEPT	-	-
5	The UE transmits an <i>ULInformationTransfer</i> message and a REGISTRATION COMPLETE message.	-->	NR RRC: <i>ULInformationTransfer</i> 5GMM: REGISTRATION COMPLETE	-	-
-	EXCEPTION: In parallel to the events described in step 6 below, the steps specified in table 8.1.4.2.2.1.3.2-2 might take place.	-	-	-	-
6	The procedure in table 4.9.14.2.2-1 in TS 38.508-1 [4] is performed.	-	-	-	-
7	Void	-	-	-	-
8	The SS sends one IP Packet to the UE on the default DRB associated with the first PDU session.	-	-	-	-
9	The UE loop backs the IP packet received in step 8.	-	-	-	-

Table 8.1.4.2.2.1.3.2-2: Parallel behaviour

St	Procedure	Message Sequence		TP	Verdict
		U - S	Message		
-	EXCEPTION: Steps 1a1 to 1a2 describes behaviour that depends on the UE implementation; the "lower case letter" identifies a step sequence that take place depending on the UE implementation	-	-	-	-
1a1	IF the DNN of the established PDU session is IMS AND the UE initiates IMS re-registration on NR in the next 10s THEN perform step 1 defined in Appendix A.12 of TS 34.229-5 [41] . (NOTE 1)	-	-	-	-
1a2	Step 2 of Appendix A.12 of TS 34.229-5 [41].	-	-	-	-
NOTE 1: Whether a PDU session is for IMS is determined by the DNN/APN type of the entry in TS 38.508-1[7], Table 4.8.4-1 which itself has been determined by the DNN IE in the UL NAS TRANSPORT message which carried the corresponding PDU SESSION ESTABLISHMENT REQUEST or by pc_APN_Default_Configuration if the DNN IE was not present. In future versions of the present specification other types of DNNs may also initiate IMS registration - this will be determined by the entry IMS registration for the type of DNN specified in TS 38.508-1[7], Table 4.8.4-1.					

8.1.4.2.2.1.3.3 Specific message contents

Table 8.1.4.2.2.1.3.3-1: MobilityFromEUTRACommand (step 1, Table 8.1.4.2.2.1.3.2-1)

Derivation Path: 36.508 [7] table 4.6.1-6			
Information Element	Value/remark	Comment	Condition
MobilityFromEUTRACommand ::= SEQUENCE {			
criticalExtensions CHOICE {			
c1 CHOICE{			
mobilityFromEUTRACommand-r8 SEQUENCE {			
purpose CHOICE {			
handover SEQUENCE {			
targetRAT-Type	nr		
targetRAT-MessageContainer	RRCReconfiguration		
nas-SecurityParamFromEUTRA	Not present		
systemInformation	Not present		
}			
}			
}			
}			
}			

Table 8.1.4.2.2.1.3.3-2: RRCReconfiguration (Table 8.1.4.2.2.1.3.3-1)

Derivation Path: 38.508-1 [4] Table 4.6.1-13			
Information Element	Value/remark	Comment	Condition
RRCReconfiguration ::= SEQUENCE {			
criticalExtensions CHOICE {			
rrcReconfiguration SEQUENCE {			
radioBearerConfig	RadioBearerConfig as per table 4.6.3-132 in TS 38.508-1 [4] with conditions SRB1,SRB2 and DRB1		
nonCriticalExtension SEQUENCE {			
masterCellGroup	CellGroupConfig with conditions SRB1,SRB2 and DRB1	OCTET STRING (CONTAINING CellGroupConfig)	
fullConfig	true		
masterKeyUpdate	MasterKeyUpdate		
}			
}			
}			
}			

Table 8.1.4.2.2.1.3.3-3: Void**Table 8.1.4.2.2.1.3.3-4: CellGroupConfig (Table 8.1.4.2.2.1.3.3-2)**

Derivation Path: 38.508-1 [4] Table 4.6.3-19			
Information Element	Value/remark	Comment	Condition
CellGroupConfig ::= SEQUENCE {			
rlc-BearerToAddModList SEQUENCE (SIZE(1..maxLC-ID)) OF RLC-BearerConfig {	3 entries		
RLC-Bearer-Config[1]	RLC-Bearer-Config with condition SRB1	entry 1	
RLC-Bearer-Config[2]	RLC-Bearer-Config with condition SRB2	entry 2	
RLC-Bearer-Config[3]	RLC-Bearer-Config with condition DRB1	entry 3	
}			
mac-CellGroupConfig	MAC-CellGroupConfig		
physicalCellGroupConfig	PhysicalCellGroupConfig		
spCellConfig SEQUENCE {			
reconfigurationWithSync SEQUENCE {			
spCellConfigCommon	ServingCellConfigCommon		
newUE-Identity	RNTI-Value		
t304	ms1000		
rach-ConfigDedicated CHOICE {			
uplink	RACH-ConfigDedicated		
supplementaryUplink	Not present		
}			
}			
rlf-TimersAndConstants CHOICE {			
setup	RLF-TimersAndConstants		
}			
spCellConfigDedicated	ServingCellConfig		
}			
}			

Table 8.1.4.2.2.1.3.3-5: ServingCellConfigCommon (Table 8.1.4.2.2.1.3.3-4)

Derivation Path: 38.508-1 [4] Table 4.6.3-168			
Information Element	Value/remark	Comment	Condition
ServingCellConfigCommon ::= SEQUENCE {			
physCellId	Physical CellID of the NR Cell 1		
}			

Table 8.1.4.2.2.1.3.3-6: MasterKeyUpdate (Table 8.1.4.2.2.1.3.3-2)

Derivation Path: 38.508-1 [4] Table FFS			
Information Element	Value/remark	Comment	Condition
MasterKeyUpdate ::= SEQUENCE {			
keySetChangeIndicator	True		
nextHopChainingCount	NextHopChainingCount	38.508-1 [4] Table 4.6.3-83	
nas-Container	<p>Octets 1 to 4 are Message authentication code(MAC) IE.</p> <p>Bits 1 to 4 of octet 5 are set according to PIXIT parameter for default integrity protection algorithm.</p> <p>Bits 5 to 8 of octet 5 are set according to PIXIT parameter for default cipherring algorithm.</p> <p>Bits 1 to 3 of octet 6 contains the Key set identifier in 5G.</p> <p>Bit 4 of octet 6 contains the type of security context flag(TSC).</p> <p>Bits 5 to 7 of octet 6 contains the 3bit Next hop chaining counter.</p> <p>Bit 8 of octet 6 is Spare.</p> <p>Octets 7 and 8 are spare and shall be coded as zero.</p>	24.501 [22] 9.11.2.9 The value part of S1 mode to N1 mode NAS transparent container	
}			

8.1.4.3 DAPS handover

8.1.4.3.1 DAPS handover / Success

8.1.4.3.1.1 Test Purpose (TP)

(1)

```
with { UE in NR RRC_CONNECTED state and supporting DAPS handover }
ensure that {
  when { UE receives an RRCReconfiguration message including a reconfigurationWithSync for handover
and dapsConfig is configured for a DRB }
  then { UE performs DAPS handover to the target cell and keeps DL/UL reception/transmission with
the source gNB for the DRB configured with dapsConfig }
```

}

(2)

```

with { UE in NR RRC_CONNECTED state and supporting DAPS handover and having received an
RRCReconfiguration message including a reconfigurationWithSync for handover to the neighbour cell
and a dapsConfig configured for any DRB }
ensure that {
  when { UE has performed random access procedure to the target cell successfully }
  then { UE transmits an RRCReconfigurationComplete message and switches the uplink user data
transmission to the target gNB }
}

```

(3)

```

with { UE in NR RRC_CONNECTED state and supporting DAPS handover and having received an
RRCReconfiguration message including a reconfigurationWithSync for handover to the neighbour cell
and a dapsConfig configured for any DRB }
ensure that {
  when { UE receives an RRCReconfiguration message including a daps-SourceRelease }
  then { UE releases the radio link with the source cell }
}

```

8.1.4.3.1.2 Conformance requirements

References: The conformance requirements covered in the present TC are specified in: TS 38.300 9.2.3.1 and 9.2.3.2.1 and TS 38.331 clause 5.3.5.3 and 5.3.5.5.2. Unless otherwise stated these are Rel-16 requirements.

[TS 38.300, clause 9.2.3.1]

Network controlled mobility applies to UEs in RRC_CONNECTED and is categorized into two types of mobility: cell level mobility and beam level mobility.

Cell Level Mobility requires explicit RRC signalling to be triggered, i.e. handover. For inter-gNB handover, the signalling procedures consist of at least the following elemental components illustrated in Figure 9.2.3.1-1:

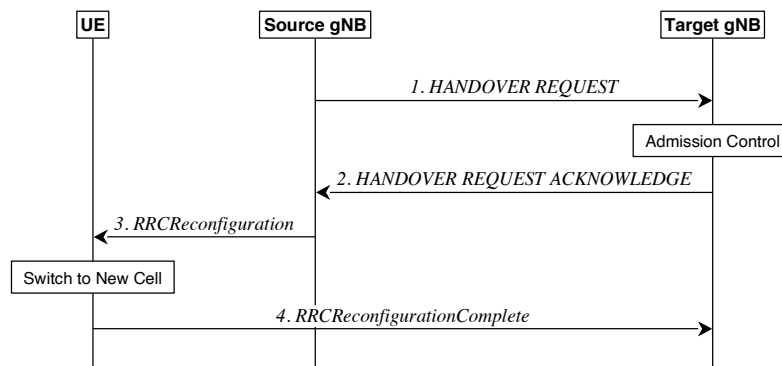

Figure 9.2.3.1-1: Inter-gNB handover procedures

1. The source gNB initiates handover and issues a HANDOVER REQUEST over the Xn interface.
2. The target gNB performs admission control and provides the new RRC configuration as part of the HANDOVER REQUEST ACKNOWLEDGE.
3. The source gNB provides the RRC configuration to the UE by forwarding the *RRCReconfiguration* message received in the HANDOVER REQUEST ACKNOWLEDGE. The *RRCReconfiguration* message includes at least cell ID and all information required to access the target cell so that the UE can access the target cell without reading system information. For some cases, the information required for contention-based and contention-free random access can be included in the *RRCReconfiguration* message. The access information to the target cell may include beam specific information, if any.

4. The UE moves the RRC connection to the target gNB and replies with the *RRCReconfigurationComplete*.

NOTE 1: User Data can also be sent in step 4 if the grant allows.

In case of DAPS handover, the UE continues the downlink user data reception from the source gNB until releasing the source cell and continues the uplink user data transmission to the source gNB until successful random access procedure to the target gNB.

The handover mechanism triggered by RRC requires the UE at least to reset the MAC entity and re-establish RLC, except for DAPS handover, where upon reception of the handover command, the UE:

- Creates a MAC entity for target;
- Establishes the RLC entity and an associated DTCH logical channel for target for each DRB configured with DAPS;
- For the DRB configured with DAPS, reconfigures the PDCP entity with separate security and ROHC functions for source and target and associates them with the RLC entities configured by source and target respectively;
- Retains the rest of the source configurations until release of the source.

NOTE 2: The handling on RLC and PDCP for DRBs without DAPS is same as in normal handover.

NOTE 3: Only PCell is kept during DAPS handover. All other serving cells are released by the network.

RRC managed handovers with and without PDCP entity re-establishment are both supported. For DRBs using RLC AM mode, PDCP can either be re-established together with a security key change or initiate a data recovery procedure without a key change. For DRBs using RLC UM mode and for SRBs, PDCP can either be re-established together with a security key change or remain as it is without a key change.

Data forwarding, in-sequence delivery and duplication avoidance at handover can be guaranteed when the target gNB uses the same DRB configuration as the source gNB.

Timer based handover failure procedure is supported in NR. RRC connection re-establishment procedure is used for recovering from handover failure except in certain CHO or DAPS scenarios:

- When DAPS HO fails, the UE falls back to source cell configuration, resumes the connection with source cell, and reports DAPS HO failure via the source without triggering RRC connection re-establishment if the source link has not been released.
- When initial CHO execution attempt fails or HO fails, the UE performs cell selection, and if the selected cell is a CHO candidate and if network configured the UE to try CHO after HO/CHO failure, then the UE attempts CHO execution once, otherwise re-establishment is performed.

DAPS handover for FR2 to FR2 case is not supported in this release of the specification.

[TS 38.300, clause 9.2.3.2.1]

The intra-NR RAN handover performs the preparation and execution phase of the handover procedure performed without involvement of the 5GC, i.e. preparation messages are directly exchanged between the gNBs. The release of the resources at the source gNB during the handover completion phase is triggered by the target gNB. The figure below depicts the basic handover scenario where neither the AMF nor the UPF changes:

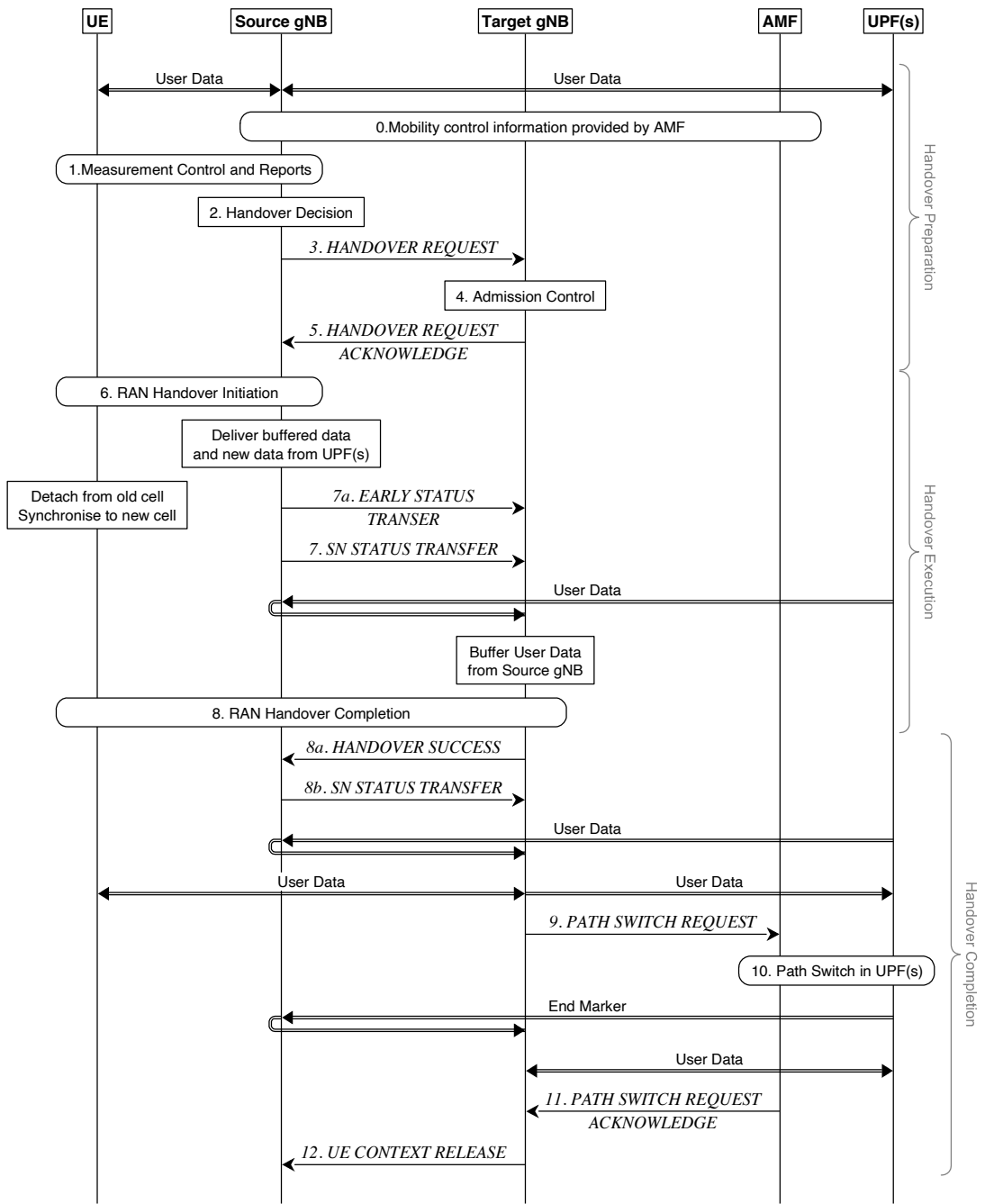

<http://msc-generator.sourceforge.net/v6.3.7>

Figure 9.2.3.2.1-1: Intra-AMF/UPF Handover

0. The UE context within the source gNB contains information regarding roaming and access restrictions which were provided either at connection establishment or at the last TA update.
1. The source gNB configures the UE measurement procedures and the UE reports according to the measurement configuration.
2. The source gNB decides to handover the UE, based on *MeasurementReport* and RRM information.

3. The source gNB issues a Handover Request message to the target gNB passing a transparent RRC container with necessary information to prepare the handover at the target side. The information includes at least the target cell ID, KgNB*, the C-RNTI of the UE in the source gNB, RRM-configuration including UE inactive time, basic AS-configuration including *antenna Info and DL Carrier Frequency*, the current QoS flow to DRB mapping rules applied to the UE, the SIB1 from source gNB, the UE capabilities for different RATs, PDU session related information, and can include the UE reported measurement information including beam-related information if available. The PDU session related information includes the slice information and QoS flow level QoS profile(s). The source gNB may also request a DAPS Handover for some DRBs.

NOTE 1: After issuing a Handover Request, the source gNB should not reconfigure the UE, including performing Reflective QoS flow to DRB mapping.

4. Admission Control may be performed by the target gNB. Slice-aware admission control shall be performed if the slice information is sent to the target gNB. If the PDU sessions are associated with non-supported slices the target gNB shall reject such PDU Sessions.
5. The target gNB prepares the handover with L1/L2 and sends the HANDOVER REQUEST ACKNOWLEDGE to the source gNB, which includes a transparent container to be sent to the UE as an RRC message to perform the handover. The target gNB also indicates if a DAPS Handover is accepted.

NOTE 2: As soon as the source gNB receives the HANDOVER REQUEST ACKNOWLEDGE, or as soon as the transmission of the handover command is initiated in the downlink, data forwarding may be initiated.

NOTE 3: For DRBs configured with DAPS, downlink PDCP SDUs are forwarded with SN assigned by the source gNB, until SN assignment is handed over to the target gNB in step 8b, for which the normal data forwarding follows as defined in 9.2.3.2.3.

6. The source gNB triggers the Uu handover by sending an *RRCReconfiguration* message to the UE, containing the information required to access the target cell: at least the target cell ID, the new C-RNTI, the target gNB security algorithm identifiers for the selected security algorithms. It can also include a set of dedicated RACH resources, the association between RACH resources and SSB(s), the association between RACH resources and UE-specific CSI-RS configuration(s), common RACH resources, and system information of the target cell, etc.

NOTE 4: For DRBs configured with DAPS, the source gNB does not stop transmitting downlink packets until it receives the HANDOVER SUCCESS message from the target gNB in step 8a.

NOTE 4a: CHO cannot be configured simultaneously with DAPS HO.

- 7a. For DRBs configured with DAPS, the source gNB sends the EARLY STATUS TRANSFER message. The DL COUNT value conveyed in the EARLY STATUS TRANSFER message indicates PDCP SN and HFN of the first PDCP SDU that the source gNB forwards to the target gNB. The source gNB does not stop assigning SNs to downlink PDCP SDUs until it sends the SN STATUS TRANSFER message to the target gNB in step 8b.
7. For DRBs not configured with DAPS, the source gNB sends the SN STATUS TRANSFER message to the target gNB to convey the uplink PDCP SN receiver status and the downlink PDCP SN transmitter status of DRBs for which PDCP status preservation applies (i.e. for RLC AM). The uplink PDCP SN receiver status includes at least the PDCP SN of the first missing UL PDCP SDU and may include a bit map of the receive status of the out of sequence UL PDCP SDUs that the UE needs to retransmit in the target cell, if any. The downlink PDCP SN transmitter status indicates the next PDCP SN that the target gNB shall assign to new PDCP SDUs, not having a PDCP SN yet.

NOTE 5: In case of DAPS Handover, the uplink PDCP SN receiver status and the downlink PDCP SN transmitter status for a DRB with RLC-AM and not configured with DAPS may be transferred by the SN STATUS TRANSFER message in step 8b instead of step 7.

NOTE 6: For DRBs configured with DAPS, the source gNB may additionally send the EARLY STATUS TRANSFER message(s) between step 7 and step 8b, to inform discarding of already forwarded PDCP SDUs. The target gNB does not transmit forwarded downlink PDCP SDUs to the UE, whose COUNT is less than the conveyed DL COUNT value and discards them if transmission has not been attempted already.

8. The UE synchronises to the target cell and completes the RRC handover procedure by sending *RRCReconfigurationComplete* message to target gNB. In case of DAPS HO, the UE does not detach from the source cell upon receiving the *RRCReconfiguration* message. The UE releases the source SRB resources,

security configuration of the source cell and stops DL/UL reception/transmission with the source upon receiving an explicit release from the target node.

NOTE 6a: From RAN point of view, the DAPS HO is considered to only be completed after the UE has released the source cell as explicitly requested from the target node. RRC suspend, a subsequent handover or inter-RAT handover cannot be initiated until the source cell has been released.

8a/b In case of DAPS Handover, the target gNB sends the HANDOVER SUCCESS message to the source gNB to inform that the UE has successfully accessed the target cell. In return, the source gNB sends the SN STATUS TRANSFER message for DRBs configured with DAPS for which the description in step 7 applies, and the normal data forwarding follows as defined in 9.2.3.2.3.

NOTE 7: The uplink PDCP SN receiver status and the downlink PDCP SN transmitter status are also conveyed for DRBs with RLC-UM in the SN STATUS TRANSFER message in step 8b, if configured with DAPS.

NOTE 8: For DRBs configured with DAPS for which duplication avoidance is required (i.e. RLC-AM), the source gNB does not stop delivering uplink QoS flows to the UPF until it sends the SN STATUS TRANSFER message in step 8b. The target gNB does not forward QoS flows of the uplink PDCP SDUs successfully received in-sequence to the UPF until it receives the SN STATUS TRANSFER message, in which UL HFN and the first missing SN in the uplink PDCP SN receiver status indicates the start of uplink PDCP SDUs to be delivered to the UPF. The target gNB does not deliver any uplink PDCP SDUs which has an UL COUNT lower than the provided.

NOTE 9: The source gNB may omit sending the SN STATUS TRANSFER message if none of DRBs is configured with DAPS or shall be treated with PDCP status preservation.

9. The target gNB sends a PATH SWITCH REQUEST message to AMF to trigger 5GC to switch the DL data path towards the target gNB and to establish an NG-C interface instance towards the target gNB.
10. 5GC switches the DL data path towards the target gNB. The UPF sends one or more "end marker" packets on the old path to the source gNB per PDU session/tunnel and then can release any U-plane/TNL resources towards the source gNB.
11. The AMF confirms the PATH SWITCH REQUEST message with the PATH SWITCH REQUEST ACKNOWLEDGE message.
12. Upon reception of the PATH SWITCH REQUEST ACKNOWLEDGE message from the AMF, the target gNB sends the UE CONTEXT RELEASE to inform the source gNB about the success of the handover. The source gNB can then release radio and C-plane related resources associated to the UE context. Any ongoing data forwarding may continue.

[TS 38.331, clause 5.3.5.3]

The UE shall perform the following actions upon reception of the *RRCReconfiguration*, or upon execution of the conditional reconfiguration (CHO or CPC):

- 1> if the *RRCReconfiguration* is applied due to a conditional reconfiguration execution upon cell selection while timer T311 is running, as defined in 5.3.7.3:
 - 2> remove all the entries within *VarConditionalReconfig*, if any;
- 1> if the *RRCReconfiguration* includes the *daps-SourceRelease*:
 - 2> release source SpCell configuration;
 - 2> reset the source MAC and release the source MAC configuration;
 - 2> for each DAPS bearer:
 - 3> release the RLC entity or entities as specified in TS 38.322 [4], clause 5.1.3, and the associated logical channel for the source SpCell;
 - 3> reconfigure the PDCP entity to release DAPS as specified in TS 38.323 [5];
 - 2> for each SRB:

- 3> release the PDCP entity for the source SpCell;
- 3> release the RLC entity as specified in TS 38.322 [4], clause 5.1.3, and the associated logical channel for the source SpCell;
- 2> release the physical channel configuration for the source SpCell;
- 2> discard the keys used in the source SpCell (the K_{gNB} key, the K_{RRCEnc} key, the K_{RRCint} key, the K_{UPint} key and the K_{UPenc} key), if any;
- ...
- 1> if *reconfigurationWithSync* was included in *spCellConfig* of an MCG or SCG, and when MAC of an NR cell group successfully completes a Random Access procedure triggered above:
 - 2> stop timer T304 for that cell group;
 - 2> stop timer T310 for source SpCell if running;
 - 2> apply the parts of the CSI reporting configuration, the scheduling request configuration and the sounding RS configuration that do not require the UE to know the SFN of the respective target SpCell, if any;
 - 2> apply the parts of the measurement and the radio resource configuration that require the UE to know the SFN of the respective target SpCell (e.g. measurement gaps, periodic CQI reporting, scheduling request configuration, sounding RS configuration), if any, upon acquiring the SFN of that target SpCell;
 - 2> for each DRB configured as DAPS bearer, request uplink data switching to the PDCP entity, as specified in TS 38.323 [5];
 - ...

NOTE 3: The UE is only required to acquire broadcasted *SIB1* if the UE can acquire it without disrupting unicast data reception, i.e. the broadcast and unicast beams are quasi co-located.

NOTE 4: The UE sets the content of *UEAssistanceInformation* according to latest configuration (i.e. the configuration after applying the *RRCReconfiguration* message) and latest UE preference. The UE may include more than the concerned UE assistance information within the *UEAssistanceInformation* according to 5.7.4.2. Therefore, the content of *UEAssistanceInformation* message may not be similar to the original one.

[TS 38.331, clause 5.3.5.5.2]

The UE shall perform the following actions to execute a reconfiguration with sync.

- 1> if the AS security is not activated, perform the actions upon going to RRC_IDLE as specified in 5.3.11 with the release cause 'other' upon which the procedure ends;
- 1> if no DAPS bearer is configured:
 - 2> stop timer T310 for the corresponding SpCell, if running;
- 1> if this procedure is executed for the MCG:
 - 2> if timer T316 is running:
 - 3> stop timer T316;
 - 3> clear the information included in *VarRLF-Report*, if any;
 - 2> resume MCG transmission, if suspended.
- 1> stop timer T312 for the corresponding SpCell, if running;
- 1> start timer T304 for the corresponding SpCell with the timer value set to *t304*, as included in the *reconfigurationWithSync*;
- 1> if the *frequencyInfoDL* is included:

2> consider the target SpCell to be one on the SSB frequency indicated by the *frequencyInfoDL* with a physical cell identity indicated by the *physCellId*;

1> else:

2> consider the target SpCell to be one on the SSB frequency of the source SpCell with a physical cell identity indicated by the *physCellId*;

1> start synchronising to the DL of the target SpCell;

1> apply the specified BCCH configuration defined in 9.1.1.1 for the target SpCell;

1> acquire the *MIB* of the target SpCell, which is scheduled as specified in TS 38.213 [13];

NOTE 1: The UE should perform the reconfiguration with sync as soon as possible following the reception of the RRC message triggering the reconfiguration with sync, which could be before confirming successful reception (HARQ and ARQ) of this message.

NOTE 2: The UE may omit reading the *MIB* if the UE already has the required timing information, or the timing information is not needed for random access.

NOTE 2a: A UE with DAPS bearer does not monitor for system information updates in the source PCell.

1> If any DAPS bearer is configured:

2> create a MAC entity for the target cell group with the same configuration as the MAC entity for the source cell group;

2> for each DAPS bearer:

3> establish an RLC entity or entities for the target cell group, with the same configurations as for the source cell group;

3> establish the logical channel for the target cell group, with the same configurations as for the source cell group;

NOTE 2b: In order to understand if a DAPS bearer is configured, the UE needs to check the presence of the field *daps-Config* within the *RadioBearerConfig* IE received in *radioBearerConfig* or *radioBearerConfig2*.

2> for each SRB:

3> establish an RLC entity for the target cell group, with the same configurations as for the source cell group;

3> establish the logical channel for the target cell group, with the same configurations as for the source cell group;

3> suspend SRBs for the source cell group;

NOTE 3: Void

2> apply the value of the *newUE-Identity* as the C-RNTI in the target cell group;

2> configure lower layers for the target SpCell in accordance with the received *spCellConfigCommon*;

2> configure lower layers for the target SpCell in accordance with any additional fields, not covered in the previous, if included in the received *reconfigurationWithSync*.

8.1.4.3.1.3 Test description

8.1.4.3.1.3.1 Pre-test conditions

System Simulator:

- NR Cell 1 is the Serving cell and the power level is configured to "Serving Cell" defined in TS 38.508-1 [4] Table 6.2.2.1-3.

- NR Cell 2 is the Suitable neighbour intra-frequency cell and the power level is configured to " Suitable neighbour intra-frequency cell" defined in TS 38.508-1 [4] Table 6.2.2.1-3
- System information combination NR-2 as defined in TS 38.508-1 [4] clause 4.4.3.1.3 is used for both NR Cells

UE:

- None.

Preamble:

- The UE is in 3N-A state configured with DRB#1 in RLC AM mode according to TS 38.508-1 [4], Table 4.4A.2-3 and Test Loop Function (On) with UE test loop mode B activated according to TS 38.508-1 [4], table 4.5.4.2-3.

8.1.4.3.1.3.2 Test procedure sequence

Table 8.1.4.3.1.3.2-1: Main behaviour

St	Procedure	Message Sequence		TP	Verdict
		U - S	Message		
1	The SS ignores scheduling requests and does not allocate any uplink grant in NR Cell 1.	-	-	-	-
2	The SS sends one IP Packet to the UE on the DRB#1.	<--		-	-
3	The SS transmits an <i>RRCReconfiguration</i> message containing <i>reconfigurationWithSync</i> to order UE to perform DAPS handover to NR Cell 2 with key change. DRB #1 is configured as DAPS bearer.	<--	NR RRC: <i>RRCReconfiguration</i>	-	-
-	EXCEPTION: In parallel with step 4, parallel behaviour defined in table 8.1.4.3.1.3.2-2 is executed.	-	-	-	-
4	The SS does not configure UL grant for the UE in NR Cell 2 and waits for the parallel program execution to be completed in the NR Cell 1. (Note 1)	-	-	-	-
5	The SS configures UL grant for the UE in NR Cell 2 and continues to respond to scheduling requests from UE.	<--	DCI format 0_0	-	-
-	EXCEPTION: Steps 6 and 7 can occur in any order.	-	-	-	-
6	Check: Does UE transmit an <i>RRCReconfigurationComplete</i> message in NR Cell 2?	-->	NR RRC: <i>RRCReconfigurationComplete</i>	1,2	P
7	Check: Does the UE loop back the IP packet received at step 3 of table 8.1.4.3.1.3.2-2 in the NR Cell 2?	-	-	2	P
8	The SS transmits an <i>RRCReconfiguration</i> message with condition <i>DAPS_HO_ReleaseSource</i> in NR Cell 2.	<--	NR RRC: <i>RRCReconfiguration</i>	-	-
9	Check: Does transmit an <i>RRCReconfigurationComplete</i> message in NR Cell 2?	-->	NR RRC: <i>RRCReconfigurationComplete</i>	3	P
10	the SS transmits one IP Packet to verify data path on DRB#1 on NR Cell 1.	-	-	-	-
11	Check: Does UE send the IP Packet on DRB#1 in the uplink on NR Cell 1?	-	-	3	F
12	the SS transmits one IP Packet to verify data path on DRB#1 on NR Cell 2.	-	-	-	-
13	Check: Does UE send the IP Packet on DRB#1 in the uplink on NR Cell 2?	-	-	1	P
Note 1: The waiting time shall not exceed the value of T304. The default value of T304 is set to 1000ms currently as specified in TS 38.508-1 [4] table 4.6.3-19.					

Table 8.1.4.3.1.3.2-2: Parallel behaviour

St	Procedure	Message Sequence		TP	Verdict
		U - S	Message		
1	The SS allocates uplink grant in NR Cell 1, allowing the UE to return the IP packet received at step 2.	-	(UL Grant (C-RNTI))	-	-
2	Check: Does the UE loop back the IP packet received at step 2 in the NR Cell 1?	-	-	1	P
3	The SS sends one IP Packet to the UE via DRB#1 in the NR Cell 1.	-	-	-	-

8.1.4.3.1.3.3 Specific message contents

Table 8.1.4.3.1.3.3-1: *RRCReconfiguration* (step 3, Table 8.1.4.3.1.3.2-1)

Derivation Path: TS 38.508-1 [4], Table 4.8.1-1A with Condition RBConfig_KeyChange			
Information Element	Value/remark	Comment	Condition
RRCReconfiguration ::= SEQUENCE {			
criticalExtensions CHOICE {			
rrcReconfiguration SEQUENCE {			
radioBearerConfig	RadioBearerConfig with conditions (SRB_NR_PDCP and Re-establish_PDCP) and DRB1 AND DAPS_PDCP		
nonCriticalExtension SEQUENCE{			
masterCellGroup	CellGroupConfig	OCTET STRING (CONTAINING CellGroupConfig)	
}			
}			
}			
}			

Table 8.1.4.1.7.1.3.3-2: CellGroupConfig (Table 8.1.4.3.1.3.3-1)

Derivation Path: TS 38.508-1 [4], Table 4.6.3-19 with condition DAPS_HO			
Information Element	Value/remark	Comment	Condition
CellGroupConfig ::= SEQUENCE {			
rlc-BearerToAddModList SEQUENCE (SIZE(1..maxLCH)) OF RLC-BearerConfig {	3 entries		
RLC-BearerConfig[1]	RLC-BearerConfig with conditions SRB1 and Re-establish_RLC	entry 1	
RLC-BearerConfig[2]	RLC-BearerConfig with conditions SRB2 and Re-establish_RLC	entry 2	
RLC-BearerConfig[3]	RLC-BearerConfig with conditions AM, DRB2 except <i>drb-Identity</i> of servedRadioBearer shall set to DRB-Identity with condition DRB1	Entry3	
}			
spCellConfig SEQUENCE {			
reconfigurationWithSync SEQUENCE {			
spCellConfigCommon SEQUENCE {			
physCellId	Physical Cell Identity of NR Cell 2		
}			
}			
}			
}			

8.1.5 RRC others

8.1.5.1 UE capability transfer

8.1.5.1.1 UE capability transfer / Success

8.1.5.1.1.1 Test Purpose (TP)

(1)

```
with { UE in NR RRC_CONNECTED state }
ensure that {
  when { UE receives an UECapabilityEnquiry message }
  then { UE transmits an UECapabilityInformation message including UE radio access capability
information corresponding to the ue-CapabilityRequest variable }
}
```

8.1.5.1.1.2 Conformance requirements

References: The conformance requirements covered in the present test case are specified in: TS 38.331, clauses 5.6.1.3 and 5.6.1.4. Unless otherwise stated these are Rel-15 requirements.

[TS 38.331, clause 5.6.1.3]

The UE shall set the contents of *UECapabilityInformation* message as follows:

- 1> if the *ue-CapabilityRAT-RequestList* contains a *UE-CapabilityRAT-Request* with *rat-Type* set to *nr*:
 - 2> include in the *ue-CapabilityRAT-ContainerList* a *UE-CapabilityRAT-Container* of the type *UE-NR-Capability* and with the *rat-Type* set to *nr*;
 - 2> include the *supportedBandCombinationList*, *featureSets* and *featureSetCombinations* as specified in clause 5.6.1.4;

...

1> submit the *UECapabilityInformation* message to lower layers for transmission, upon which the procedure ends.

[TS 38.331, clause 5.6.1.4]

The UE invokes the procedures in this clause if the NR or E-UTRA network requests UE capabilities for *nr*, *eutra-nr* or *eutra*. This procedure is invoked once per requested *rat-Type* (see clause 5.6.1.3 for capability enquiry by the NR network; see TS 36.331 [10], clause 5.6.3.3 for capability enquiry by the E-UTRA network). The UE shall ensure that the feature set IDs are consistent across feature sets, feature set combinations and band combinations in all three UE capability containers that the network queries with the same fields with the same values, i.e. *UE-CapabilityRequestFilterNR* and fields in *UECapabilityEnquiry* message (i.e. *requestedFreqBandsNR-MRDC*, *requestedCapabilityNR* and *eutra-nr-only* flag) as defined in TS 36.331, where applicable.

NOTE 1: Capability enquiry without *frequencyBandListFilter* is not supported.

8.1.5.1.1.3 Test Description

8.1.5.1.1.3.1 Pre-test conditions

System Simulator:

- NR Cell 1
- System information combination NR-1 as defined in TS 38.508-1 [4] clause 4.4.3.1.3 is used in NR cell.

UE:

- None.

Preamble:

- The UE is in 5GS state 3N-A according to TS 38.508-1 [4], clause 4.4A on NR Cell 1.

8.1.5.1.1.3.2 Test procedure sequence

Table 8.1.5.1.1.3.2-1: Main behaviour

St	Procedure	Message Sequence		TP	Verdict
		U - S	Message		
1	The SS transmits a <i>UECapabilityEnquiry</i> message including <i>RAT-Type nr</i> .	<-	<i>UECapabilityEnquiry</i>	-	-
2	Check: Does the UE transmit a <i>UECapabilityInformation</i> message including UE radio access capability information as per the <i>ue-CapabilityRequest</i> variable?	-->	<i>UECapabilityInformation</i>	1	P

8.1.5.1.1.3.3 Specific message contents

Table 8.1.5.1.1.3.3-1: UECapabilityEnquiry (step 1, Table 8.1.5.1.1.3.2-1)

Derivation Path: 38.508-1 [4], Table 4.6.1-31			
Information Element	Value/remark	Comment	Condition
UECapabilityEnquiry ::= SEQUENCE {			
rrc-TransactionIdentifier	RRC-TransactionIdentifier		
criticalExtensions CHOICE {			
ueCapabilityEnquiry SEQUENCE {			
ue-CapabilityRAT-RequestList SEQUENCE (SIZE (1..maxRAT-CapabilityContainers)) OF CapabilityRAT-Request {	-		
UE-CapabilityRAT-Request[1] SEQUENCE {		entry 1	
rat-Type	nr		
}			
}			
lateNonCriticalExtension	Not present		
nonCriticalExtension	Not present		
}			
criticalExtensionsFuture			
}			
}			

Table 8.1.5.1.1.3.3-2: UECapabilityInformation (step 2, Table 8.1.5.1.1.3.2-1)

Derivation Path: 38.508-1 [4], Table 4.6.1-32			
Information Element	Value/remark	Comment	Condition
UECapabilityInformation ::= SEQUENCE {			
rrc-TransactionIdentifier	RRC-TransactionIdentifier		
criticalExtensions CHOICE {			
ueCapabilityInformation SEQUENCE {			
ue-CapabilityRAT-ContainerList SEQUENCE (SIZE (0..maxRAT-CapabilityContainers)) OF CapabilityRAT-Request {			
UE-CapabilityRAT-Request[1] SEQUENCE {		entry 1	
rat-Type	nr		
ueCapabilityRAT-Container	UE-NR-Capability	Encoded as per TS 38.331 [12] clause 5.6.1	
}			
}			
lateNonCriticalExtension	Not checked		
nonCriticalExtension	Not checked		
}			
criticalExtensionsFuture	Not checked		
}			
}			

Table 8.1.5.1.1.3.3-3: UE-NR-Capability (Table 8.1.5.1.1.3.3-2)

Derivation Path: 38.331 [12], clause 6.3.3			
Information Element	Value/remark	Comment	Condition
UE-NR-Capability ::= SEQUENCE {			
accessStratumRelease	Checked	"rel-15" or higher	
pdcip-Parameters SEQUENCE {			
supportedROHC-Profiles SEQUENCE {			
profile0x0000	Not checked		
profile0x0001	Not checked		
profile0x0002	Not checked		
profile0x0003	Not checked		
profile0x0004	Not checked		
profile0x0006	Not checked		
profile0x0101	Not checked		
profile0x0102	Not checked		
profile0x0103	Not checked		
profile0x0104	Not checked		
}			
maxNumberROHC-ContextSessions	Not checked		
uplinkOnlyROHC-Profiles	Not checked		
continueROHC-Context	Not checked		
outOfOrderDelivery	Checked		pc_outOfOrderDelivery
shortSN	Checked		pc_shortSN
pdcip-DuplicationSRB	Not checked		
pdcip-DuplicationMCG-OrSCG-DRB	Not checked		
}			
rlc-Parameters SEQUENCE {			
am-WithShortSN	Checked		pc_am_WithShortSN
um-WithShortSN	Checked		pc_um_WithShortSN
um-WithLongSN	Checked		pc_um_WithLongSN
}			
mac-Parameters SEQUENCE {			
mac-ParametersCommon SEQUENCE {			
lcp-Restriction	Not checked		
dummy	Not checked		
lch-ToSCellRestriction	Not checked		
recommendedBitRate	Not checked		
recommendedBitRateQuery	Not checked		
}			
mac-ParametersXDD-Diff SEQUENCE {			
skipUplinkTxDynamic	Checked (NOTE 4)		pc_skipUplinkTxDynamic
logicalChannelSR-DelayTimer	Checked (NOTE 5)		pc_logicalChannelSR-DelayTimer
longDRX-Cycle	Checked (NOTE 6)		pc_longDRX-Cycle
shortDRX-Cycle	Checked (NOTE 7)		pc_shortDRX-Cycle
multipleSR-Configurations	Not checked		
multipleConfiguredGrants	Not checked		
}			
}			
phy-Parameters SEQUENCE {			
phy-ParametersCommon SEQUENCE {			
csi-RS-CFRA-ForHO	Checked		pc_csi_RS-CFRA-ForHO
dynamicPRB-BundlingDL	Not checked		
sp-CSI-ReportPUCCH	Not checked		
sp-CSI-ReportPUSCH	Not checked		

nzp-CSI-RS-IntefMgmt	Not checked		
type2-SP-CSI-Feedback-LongPUCCH	Not checked		
precoderGranularityCORESET	Not checked		
dynamicHARQ-ACK-Codebook	Not checked		
semiStaticHARQ-ACK-Codebook	Not checked		
spatialBundlingHARQ-ACK	Not checked		
dynamicBetaOffsetInd-HARQ-ACK-CSI	Not checked		
pucch-Repetition-F1-3-4	Not checked		
ra-Type0-PUSCH	Checked		pc_ra_Type0_PUSCH
dynamicSwitchRA-Type0-1-PDSCH	Not checked		
dynamicSwitchRA-Type0-1-PUSCH	Not checked		
pdsch-MappingTypeA	Checked		pc_pdsch_MappingTypeA
pdsch-MappingTypeB	Checked		pc_pdsch_MappingTypeB
interleavingVRB-ToPRB-PDSCH	Checked		pc_interleavingVRB_ToPRB_PDSCH
interSlotFreqHopping-PUSCH	Not checked		
type1-PUSCH-RepetitionMultiSlots	Not checked		
type2-PUSCH-RepetitionMultiSlots	Not checked		
pusch-RepetitionMultiSlots	Checked		pc_pusch_RepetitionMultiSlots
pdsch-RepetitionMultiSlots	Checked		pc_pdsch_RepetitionMultiSlots
downlinkSPS	Checked		pc_downlinkSPS
configuredUL-GrantType1	Checked		pc_configuredUL_GrantType1
configuredUL-GrantType2	Checked		pc_configuredUL_GrantType2
pre-EmptIndication-DL	Not checked		
cbg-TransIndication-DL	Not checked		
cbg-TransIndication-UL	Not checked		
cbg-FlushIndication-DL	Not checked		
dynamicHARQ-ACK-CodeB-CBG-Retx-DL	Not checked		
rateMatchingResrcSetSemi-Static	Not checked		
rateMatchingResrcSetDynamic	Not checked		
bwp-SwitchingDelay	Not checked		
dummy	Not checked		
maxNumberSearchSpaces	n10		
rateMatchingCtrlResrsSetDynamic	Not checked		
maxLayersMIMO-Indication	Not checked		
}			
phy-ParametersXDD-Diff SEQUENCE {			
dynamicSFI	Not checked		
twoPUCCH-F0-2-ConsecSymbols	Not checked		
twoDifferentTPC-Loop-PUSCH	Not checked		
twoDifferentTPC-Loop-PUCCH	Not checked		
dl-SchedulingOffset-PDSCH-TypeA	Not checked		
dl-SchedulingOffset-PDSCH-TypeB	Not checked		
ul-SchedulingOffset	Not checked		
}			
phy-ParametersFRX-Diff SEQUENCE {			
dynamicSFI	Not checked		
dummy1	Not checked		
twoFL-DMRS	Not checked		
dummy2	Not checked		
dummy3	Not checked		

supportedDMRS-TypeDL	Not checked		
supportedDMRS-TypeUL	Not checked		
semiOpenLoopCSI	Not checked		
csi-ReportWithoutPMI	Not checked		
csi-ReportWithoutCQI	Not checked		
onePortsPTRS	Not checked		
twoPUCCH-F0-2-ConsecSymbols	Not checked		
pucch-F2-WithFH	Not checked		
pucch-F3-WithFH	Not checked		
pucch-F4-WithFH	Not checked		
freqHoppingPUCCH-F0-2	Not checked		
freqHoppingPUCCH-F1-3-4	Not checked		
mux-SR-HARQ-ACK-CSI-PUCCH-MultiPerSlot	Not checked		
uci-CodeBlockSegmentation	Not checked		
onePUCCH-LongAndShortFormat	Not checked		
twoPUCCH-AnyOthersInSlot	Not checked		
intraSlotFreqHopping-PUSCH	Not checked		
pusch-LBRM	Not checked		
pdccch-BlindDetectionCA	Not checked		
tpc-PUSCH-RNTI	Not checked		
tpc-PUCCH-RNTI	Not checked		
tpc-SRS-RNTI	Not checked		
absoluteTPC-Command	Not checked		
twoDifferentTPC-Loop-PUSCH	Not checked		
twoDifferentTPC-Loop-PUCCH	Not checked		
pusch-HalfPi-BPSK	Not checked		
pucch-F3-4-HalfPi-BPSK	Not checked		
almostContiguousCP-OFDM-UL	Not checked		
sp-CSI-RS	Not checked		
sp-CSI-IM	Not checked		
tdd-MultiDL-UL-SwitchPerSlot	Not checked		
multipleCORESET	Not checked		
csi-RS-IM-ReceptionForFeedback	Not checked	CSI-RS-IM-ReceptionForFeedback	
csi-RS-ProcFrameworkForSRS	Not checked	CSI-RS-ProcFrameworkForSRS	
csi-ReportFramework	Not checked	CSI-ReportFramework	
mux-SR-HARQ-ACK-CSI-PUCCH-OncePerSlot SEQUENCE {			
sameSymbol	Not checked		
diffSymbol	Not checked		
}			
mux-SR-HARQ-ACK-PUCCH	Not checked		
mux-MultipleGroupCtrlCH-Overlap	Not checked		
dl-SchedulingOffset-PDSCH-TypeA	Not checked		
dl-SchedulingOffset-PDSCH-TypeB	Not checked		
ul-SchedulingOffset	Not checked		
dl-64QAM-MCS-TableAlt	Not checked		
ul-64QAM-MCS-TableAlt	Not checked		
cqi-TableAlt	Not checked		
oneFL-DMRS-TwoAdditionalDMRS-UL	Not checked		
twoFL-DMRS-TwoAdditionalDMRS-UL	Not checked		
oneFL-DMRS-ThreeAdditionalDMRS-UL	Not checked		
}			
phy-ParametersFR1 SEQUENCE {			
pdccchMonitoringSingleOccasion	Not checked		
scs-60kHz	Not checked		
pdsch-256QAM-FR1	Checked		pc_pdsch_2 56QAM_FR1
pdsch-RE-MappingFR1-PerSymbol	Not checked		
pdsch-RE-MappingFR1-PerSlot	Not checked		
}			
phy-ParametersFR2 SEQUENCE {			

dummy	Not checked		
pdsch-RE-MappingFR2-PerSymbol	Not checked		
pCell-FR2	Not checked		
pdsch-RE-MappingFR2-PerSlot	Not checked		
}			
}			
rf-Parameters SEQUENCE {			
supportedBandListNR SEQUENCE (SIZE (1..maxBands)) OF BandNR {	i entries		
BandNR[i] SEQUENCE {		entry i	
bandNR	Checked	Checked for 'maxBands' entries of FreqBandIndicator NR[i]	pc_nrBandx ('x' being the band number/type related PICS listed in TS 38.508-2)
modifiedMPR-Behaviour	Not checked		
mimo-ParametersPerBand	Not checked	MIMO-ParametersPerBand[i]	
extendedCP	Not checked		
multipleTCI	Not checked		
bwp-WithoutRestriction	Not checked		
bwp-SameNumerology	Not checked		
bwp-DiffNumerology	Not checked		
crossCarrierScheduling-SameSCS	Not checked		
pdsch-256QAM-FR2	Checked		pc_pdsch_256QAM_FR2
pusch-256QAM	Checked		pc_pusch_256QAM_FR1
ue-PowerClass	Not checked		
rateMatchingLTE-CRS	Not checked		
channelBWs-DL-v1530 CHOICE {			
fr1 SEQUENCE {			
scs-15kHz	Not checked		
scs-30kHz	Not checked		
scs-60kHz	Not checked		
}			
fr2 SEQUENCE {			
scs-60kHz	Not checked		
scs-120kHz	Not checked		
}			
}			
}			
channelBWs-UL-v1530[i] CHOICE {			
fr1 SEQUENCE {			
scs-15kHz	Not checked		
scs-30kHz	Not checked		
scs-60kHz	Not checked		
}			
fr2 SEQUENCE {			
scs-60kHz	Not checked		
scs-120kHz	Not checked		
}			
maxUplinkDutyCycle-PC2-FR1	Not checked		
pucch-SpatialRelInfoMAC-CE	Not checked		
powerBoosting-pi2BPSK	Not checked		
}			
}			
supportedBandCombinationList SEQUENCE (SIZE (1..maxBandComb)) OF BandCombination {	i entries		
BandCombination[i] SEQUENCE {		entry i	
bandList SEQUENCE (SIZE (1..maxSimultaneousBands)) OF BandParameters {	i entries		
BandParameters[i] CHOICE		entry i	

etra SEQUENCE {			
bandEUTRA	Not checked	FreqBandIndicator EUTRA	
ca-BandwidthClassDL-EUTRA	Not checked	CA- BandwidthClassE UTRA	
ca-BandwidthClassUL-EUTRA	Not checked	CA- BandwidthClassE UTRA	
}			
nr SEQUENCE {			
bandNR	Not checked	FreqBandIndicator NR	
ca-BandwidthClassDL-NR	Not checked	CA- BandwidthClassN R	
ca-BandwidthClassUL-NR	Not checked	CA- BandwidthClassN R	
}			
}			
}			
featureSetCombination	Not checked	FeatureSetCombi nationId	
ca-ParametersEUTRA	Not checked	CA- ParametersEUTR A	
ca-ParametersNR	Not checked	CA- ParametersNR	
mrdc-Parameters	Not checked	MRDC- Parameters	
supportedBandwidthCombinationSet	Not checked		
powerClass-v1530	Not checked		
}			
appliedFreqBandListFilter	Not checked	FreqBandList	
supportedBandCombinationList-v1540 SEQUENCE (SIZE (1..maxBandComb)) OF BandCombination-v1540 {	i entries		
BandCombination-v1540[i] SEQUENCE {		entry i	
bandList-v1540 SEQUENCE (SIZE (1..maxSimultaneousBands)) OF BandParameters- v1540 {	i entries Not checked	BandParameters- v1540	
BandParameters-v1540[i] SEQUENCE {		entry i	
srs-CarrierSwitch CHOICE {			
nr SEQUENCE [NR bands	
srs-SwitchingTimesListNR SEQUENCE (SIZE (1..maxSimultaneousBands)) OF SRS- SwitchingTimeNR	Not checked		
}			
etra SEQUENCE {		EUTRA bands	
srs-SwitchingTimesListEUTRA SEQUENCE (SIZE (1..maxSimultaneousBands)) OF SRS- SwitchingTimeEUTRA	Not checked		
}			
srs-TxSwitch-v1540 SEQUENCE {			
supportedSRS-TxPortSwitch	Not checked		
txSwitchImpactToRx	Not checked		
txSwitchWithAnotherBand	Not checked		
}			
}			
}			
ca-ParametersNR-v1540[i]	Not checked	CA- ParametersNR- v1540	

}			
}			
srs-SwitchingTimeRequested	Not checked		
}			
measAndMobParameters SEQUENCE {			
measAndMobParametersCommon SEQUENCE {			
supportedGapPattern	Not checked		
ssb-RLM	Not checked		
ssb-AndCSI-RS-RLM	Not checked		
eventB-MeasAndReport	Not checked		
handoverFDD-TDD	Not checked		
eutra-CGI-Reporting	Not checked		
nr-CGI-Reporting	Not checked		
independentGapConfig	Checked		pc_independentGapConfig
periodicEUTRA-MeasAndReport	Not checked		
handoverFR1-FR2	Not checked		
maxNumberCSI-RS-RRM-RS-SINR	Not checked		
}			
measAndMobParametersXDD-Diff SEQUENCE {			
intraAndInterF-MeasAndReport	Checked (NOTE 1)		pc_intraAndInterF-MeasAndReport
eventA-MeasAndReport	Checked (NOTE 2)		pc_eventA-MeasAndReport
handoverInterF	Not checked		
handoverLTE	Not checked		
handover-eLTE	Not checked		
}			
measAndMobParametersFRX-Diff SEQUENCE {			
ss-SINR-Meas	Not checked		
csi-RSRP-AndRSRQ-MeasWithSSB	Checked (NOTE 3)		pc_csi-RSRP-AndRSRQ-MeasWithSSB
csi-RSRP-AndRSRQ-MeasWithoutSSB	Not checked		
csi-SINR-Meas	Not checked		
csi-RS-RLM	Not checked		
handoverInterF	Not checked		
handoverLTE	Not checked		
handover-eLTE	Not checked		
maxNumberResource-CSI-RS-RLM	Not checked		
}			
}			
fdd-Add-UE-NR-Capabilities SEQUENCE {			
phy-ParametersXDD-Diff SEQUENCE {			
dynamicSFI	Not checked		
twoPUCCH-F0-2-ConsecSymbols	Not checked		
twoDifferentTPC-Loop-PUSCH	Not checked		
twoDifferentTPC-Loop-PUCCH	Not checked		
dl-SchedulingOffset-PDSCH-TypeA	Not checked		
dl-SchedulingOffset-PDSCH-TypeB	Not checked		
ul-SchedulingOffset	Not checked		
}			
mac-ParametersXDD-Diff SEQUENCE {			
skipUplinkTxDynamic	Checked (NOTE 4)		pc_skipUplinkTxDynamic
logicalChannelSR-DelayTimer	Checked (NOTE 5)		pc_logicalChannelSR-DelayTimer
longDRX-Cycle	Checked (NOTE 6)		pc_longDRX-Cycle

shortDRX-Cycle	Checked (NOTE 7)		pc_shortDRX_Cycle
multipleSR-Configurations	Not checked		
multipleConfiguredGrants	Not checked		
}			
measAndMobParametersXDD-Diff SEQUENCE {			
intraAndInterF-MeasAndReport	Checked (NOTE 1)		pc_intraAndInterF-MeasAndReport
eventA-MeasAndReport	Checked (NOTE 2)		pc_eventA-MeasAndReport
handoverInterF	Not checked		
handoverLTE	Not checked		
handover-eLTE	Not checked		
}			
}			
tdd-Add-UE-NR-Capabilities SEQUENCE {			
phy-ParametersXDD-Diff SEQUENCE {			
dynamicSFI	Not checked		
twoPUCCH-F0-2-ConsecSymbols	Not checked		
twoDifferentTPC-Loop-PUSCH	Not checked		
twoDifferentTPC-Loop-PUCCH	Not checked		
dl-SchedulingOffset-PDSCH-TypeA	Not checked		
dl-SchedulingOffset-PDSCH-TypeB	Not checked		
ul-SchedulingOffset	Not checked		
}			
mac-ParametersXDD-Diff SEQUENCE {			
skipUplinkTxDynamic	Checked (NOTE 4)		pc_skipUplinkTxDynamic
logicalChannelSR-DelayTimer	Checked (NOTE 5)		pc_logicalChannelSR-DelayTimer
longDRX-Cycle	Checked (NOTE 6)		pc_longDRX_Cycle
shortDRX-Cycle	Checked (NOTE 7)		pc_shortDRX_Cycle
multipleSR-Configurations	Not checked		
multipleConfiguredGrants	Not checked		
}			
measAndMobParametersXDD-Diff SEQUENCE {			
intraAndInterF-MeasAndReport	Checked (NOTE 1)		pc_intraAndInterF-MeasAndReport
eventA-MeasAndReport	Checked (NOTE 2)		pc_eventA-MeasAndReport
handoverInterF	Not checked		
handoverLTE	Not checked		
handover-eLTE	Not checked		
}			
}			
fr1-Add-UE-NR-Capabilities SEQUENCE {			
phy-ParametersFRX-Diff SEQUENCE {			
dynamicSFI	Not checked		
dummy1	Not checked		
twoFL-DMRS	Not checked		
dummy2	Not checked		
dummy3	Not checked		
supportedDMRS-TypeDL	Not checked		
supportedDMRS-TypeUL	Not checked		
semiOpenLoopCSI	Not checked		
csi-ReportWithoutPMI	Not checked		
csi-ReportWithoutCQI	Not checked		
onePortsPTRS	Not checked		

twoPUCCH-F0-2-ConsecSymbols	Not checked		
pucch-F2-WithFH	Not checked		
pucch-F3-WithFH	Not checked		
pucch-F4-WithFH	Not checked		
freqHoppingPUCCH-F0-2	Not checked		
freqHoppingPUCCH-F1-3-4	Not checked		
mux-SR-HARQ-ACK-CSI-PUCCH-MultiPerSlot	Not checked		
uci-CodeBlockSegmentation	Not checked		
onePUCCH-LongAndShortFormat	Not checked		
twoPUCCH-AnyOthersInSlot	Not checked		
intraSlotFreqHopping-PUSCH	Not checked		
pusch-LBRM	Not checked		
pdccch-BlindDetectionCA	Not checked		
tpc-PUSCH-RNTI	Not checked		
tpc-PUCCH-RNTI	Not checked		
tpc-SRS-RNTI	Not checked		
absoluteTPC-Command	Not checked		
twoDifferentTPC-Loop-PUSCH	Not checked		
twoDifferentTPC-Loop-PUCCH	Not checked		
pusch-HalfPi-BPSK	Not checked		
pucch-F3-4-HalfPi-BPSK	Not checked		
almostContiguousCP-OFDM-UL	Not checked		
sp-CSI-RS	Not checked		
sp-CSI-IM	Not checked		
tdd-MultiDL-UL-SwitchPerSlot	Not checked		
multipleCORESET	Not checked		
csi-RS-IM-ReceptionForFeedback	Not checked		
csi-RS-ProcFrameworkForSRS	Not checked		
csi-ReportFramework	Not checked		
mux-SR-HARQ-ACK-CSI-PUCCH-OncePerSlot			
SEQUENCE {			
sameSymbol	Not checked		
diffSymbol	Not checked		
}			
mux-SR-HARQ-ACK-PUCCH	Not checked		
mux-MultipleGroupCtrlCH-Overlap	Not checked		
dl-SchedulingOffset-PDSCH-TypeA	Not checked		
dl-SchedulingOffset-PDSCH-TypeB	Not checked		
ul-SchedulingOffset	Not checked		
dl-64QAM-MCS-TableAlt	Not checked		
ul-64QAM-MCS-TableAlt	Not checked		
cqi-TableAlt	Not checked		
oneFL-DMRS-TwoAdditionalDMRS-UL	Not checked		
twoFL-DMRS-TwoAdditionalDMRS-UL	Not checked		
oneFL-DMRS-ThreeAdditionalDMRS-UL	Not checked		
}			
measAndMobParametersFRX-Diff SEQUENCE {			
ss-SINR-Meas	Not checked		
csi-RSRP-AndRSRQ-MeasWithSSB	Checked (NOTE 3)		pc_csi-RSRP-AndRSRQ-MeasWithSSB
csi-RSRP-AndRSRQ-MeasWithoutSSB	Not checked		
csi-SINR-Meas	Not checked		
csi-RS-RLM	Not checked		
handoverInterF	Not checked		
handoverLTE	Not checked		
handover-eLTE	Not checked		
maxNumberResource-CSI-RS-RLM	Not checked		
}			
}			
fr2-Add-UE-NR-Capabilities SEQUENCE {			
phy-ParametersFRX-Diff SEQUENCE {	Not checked		
dynamicSFI	Not checked		
dummy1	Not checked		

twoFL-DMRS	Not checked		
dummy2	Not checked		
dummy3	Not checked		
supportedDMRS-TypeDL	Not checked		
supportedDMRS-TypeUL	Not checked		
semiOpenLoopCSI	Not checked		
csi-ReportWithoutPMI	Not checked		
csi-ReportWithoutCQI	Not checked		
onePortsPTRS	Not checked		
twoPUCCH-F0-2-ConsecSymbols	Not checked		
pucch-F2-WithFH	Not checked		
pucch-F3-WithFH	Not checked		
pucch-F4-WithFH	Not checked		
freqHoppingPUCCH-F0-2	Not checked		
freqHoppingPUCCH-F1-3-4	Not checked		
mux-SR-HARQ-ACK-CSI-PUCCH-MultiPerSlot	Not checked		
uci-CodeBlockSegmentation	Not checked		
onePUCCH-LongAndShortFormat	Not checked		
twoPUCCH-AnyOthersInSlot	Not checked		
intraSlotFreqHopping-PUSCH	Not checked		
pusch-LBRM	Not checked		
pdcc-BlindDetectionCA	Not checked		
tpc-PUSCH-RNTI	Not checked		
tpc-PUCCH-RNTI	Not checked		
tpc-SRS-RNTI	Not checked		
absoluteTPC-Command	Not checked		
twoDifferentTPC-Loop-PUSCH	Not checked		
twoDifferentTPC-Loop-PUCCH	Not checked		
pusch-HalfPi-BPSK	Not checked		
pucch-F3-4-HalfPi-BPSK	Not checked		
almostContiguousCP-OFDM-UL	Not checked		
sp-CSI-RS	Not checked		
sp-CSI-IM	Not checked		
tdd-MultiDL-UL-SwitchPerSlot	Not checked		
multipleCORESET	Not checked		
csi-RS-IM-ReceptionForFeedback	Not checked		
csi-RS-ProcFrameworkForSRS	Not checked		
csi-ReportFramework	Not checked		
mux-SR-HARQ-ACK-CSI-PUCCH-OncePerSlot			
SEQUENCE {			
sameSymbol	Not checked		
diffSymbol	Not checked		
}			
mux-SR-HARQ-ACK-PUCCH	Not checked		
mux-MultipleGroupCtrlCH-Overlap	Not checked		
dl-SchedulingOffset-PDSCH-TypeA	Not checked		
dl-SchedulingOffset-PDSCH-TypeB	Not checked		
ul-SchedulingOffset	Not checked		
dl-64QAM-MCS-TableAlt	Not checked		
ul-64QAM-MCS-TableAlt	Not checked		
cqi-TableAlt	Not checked		
oneFL-DMRS-TwoAdditionalDMRS-UL	Not checked		
twoFL-DMRS-TwoAdditionalDMRS-UL	Not checked		
oneFL-DMRS-ThreeAdditionalDMRS-UL	Not checked		
}			
measAndMobParametersFRX-Diff SEQUENCE {			
ss-SINR-Meas	Not checked		
csi-RSRP-AndRSRQ-MeasWithSSB	Checked (NOTE 3)		pc_csi-RSRP-AndRSRQ-MeasWithSSB
csi-RSRP-AndRSRQ-MeasWithoutSSB	Not checked		
csi-SINR-Meas	Not checked		
csi-RS-RLM	Not checked		
handoverInterF	Not checked		

handoverLTE	Not checked		
handover-eLTE	Not checked		
maxNumberResource-CSI-RS-RLM	Not checked		
}			
}			
featureSets SEQUENCE {			
featureSetsDownlink SEQUENCE (SIZE (1..maxDownlinkFeatureSets)) OF FeatureSetDownlink {	i entries		
FeatureSetDownlink[i] SEQUENCE {	Not checked	entry i	
featureSetListPerDownlinkCC	Not checked		
intraBandFreqSeparationDL	Not checked		
scalingFactor	Not checked		
crossCarrierScheduling-OtherSCS	Not checked		
scellWithoutSSB	Not checked		
csi-RS-MeasSCellWithoutSSB	Not checked		
dummy1	Not checked		
type1-3-CSS	Not checked		
pdcch-MonitoringAnyOccasions	Not checked		
dummy2	Not checked		
ue-SpecificUL-DL-Assignment	Not checked		
searchSpaceSharingCA-DL	Not checked		
timeDurationForQCL SEQUENCE {			
scs-60kHz	Not checked		
scs-120kHz	Not checked		
}			
pdsch-ProcessingType1-DifferentTB-PerSlot SEQUENCE {			
scs-15kHz	Not checked		
scs-30kHz	Not checked		
scs-60kHz	Not checked		
scs-120kHz	Not checked		
}			
dummy3	Not checked		
dummy4	Not checked		
dummy5	Not checked		
dummy6	Not checked		
dummy7	Not checked		
}			
}			
}			
featureSetsDownlinkPerCC SEQUENCE (SIZE (1..maxPerCC-FeatureSets)) OF FeatureSetDownlinkPerCC {	i entries		
FeatureSetDownlinkPerCC[i] SEQUENCE {		entry i	
supportedSubcarrierSpacingDL	Not checked	SubcarrierSpacing	
supportedBandwidthDL	Not checked	SupportedBandwidth	
channelBW-90mhz	Not checked		
maxNumberMIMO-LayersPDSCCH	Not checked	MIMO-LayersDL	
supportedModulationOrderDL	Not checked	ModulationOrder	
}			
}			
featureSetsUplink SEQUENCE (SIZE (1..maxUplinkFeatureSets)) OF FeatureSetUplink {	i entries		
FeatureSetUplink[i] SEQUENCE {		entry i	
featureSetListPerUplinkCC	Not checked		
scalingFactor	Not checked		
crossCarrierScheduling-OtherSCS	Not checked		
intraBandFreqSeparationUL	Not checked		
searchSpaceSharingCA-UL	Not checked		
dummy1	Not checked		
supportedSRS-Resources	Not checked	SRS-Resources	
twoPUCCH-Group	Not checked		
dynamicSwitchSUL	Not checked		
simultaneousTxSUL-NonSUL	Not checked		
pusch-ProcessingType1-DifferentTB-PerSlot			

SEQUENCE {			
scs-15kHz	Not checked		
scs-30kHz	Not checked		
scs-60kHz	Not checked		
scs-120kHz	Not checked		
}			
dummy2	Not checked		
}			
}			
featureSetsUplinkPerCC SEQUENCE (SIZE (1..maxPerCC-FeatureSets)) OF FeatureSetUplinkPerCC {	i entries		
FeatureSetUplinkPerCC[i] SEQUENCE {		entry i	
supportedSubcarrierSpacingUL	Not checked	SubcarrierSpacing	
supportedBandwidthUL	Not checked	SupportedBandwidth	
channelBW-90mHz	Not checked		
mimo-CB-PUSCH SEQUENCE {			
maxNumberMIMO-LayersCB-PUSCH	Checked	MIMO-LayersUL	pc_nrMIMO_CB_PUSCH
maxNumberSRS-ResourcePerSet	Not checked		
}			
maxNumberMIMO-LayersNonCB-PUSCH	Checked	MIMO-LayersUL	pc_nrMIMO_NonCB_PUSCH
supportedModulationOrderUL	Not checked	ModulationOrder	
}			
}			
featureSetsDownlink-v1540 SEQUENCE (SIZE (1..maxDownlinkFeatureSets)) OF FeatureSetDownlink-v1540 {	i entries		
FeatureSetDownlink-v1540[i] SEQUENCE {		entry i	
oneFL-DMRS-TwoAdditionalDMRS-DL	Not checked		
additionalDMRS-DL-Alt	Not checked		
twoFL-DMRS-TwoAdditionalDMRS-DL	Not checked		
oneFL-DMRS-ThreeAdditionalDMRS-DL	Not checked		
pdcc-MonitoringAnyOccasionsWithSpanGap SEQUENCE {			
scs-15kHz	Not checked		
scs-30kHz	Not checked		
scs-60kHz	Not checked		
scs-120kHz	Not checked		
}			
pdsch-SeparationWithGap	Not checked		
pdsch-ProcessingType2 SEQUENCE {			
scs-15kHz	Not checked		
scs-30kHz	Not checked		
scs-60kHz	Not checked		
}			
pdsch-ProcessingType2-Limited SEQUENCE {			
differentTB-PerSlot-SCS-30kHz	Not checked		
}			
dl-MCS-TableAlt-DynamicIndication	Not checked		
}			
}			
featureSetsUplink-v1540 SEQUENCE (SIZE (1..maxUplinkFeatureSets)) OF FeatureSetUplink-v1540 {	i entries		
FeatureSetUplink-v1540[i] SEQUENCE {		entry i	
zeroSlotOffsetAperiodicSRS	Not checked		
pa-PhaseDiscontinuityImpacts	Not checked		
pusch-SeparationWithGap	Not checked		
pusch-ProcessingType2 SEQUENCE {			
scs-15kHz	Not checked		
scs-30kHz	Not checked		
scs-60kHz	Not checked		
}			

}			
ul-MCS-TableAlt-DynamicIndication	Not checked		
}			
featureSetsUplinkPerCC-v1540 SEQUENCE (SIZE (1..maxPerCC-FeatureSets)) OF FeatureSetUplinkPerCC-v1540 {	i entries		
FeatureSetUplinkPerCC-v1540[i] SEQUENCE {		entry i	
mimo-NonCB-PUSCH SEQUENCE {			
maxNumberSRS-ResourcePerSet	Not checked		
maxNumberSimultaneousSRS-ResourceTx	Not checked		
}			
}			
}			
featureSetCombinations SEQUENCE (SIZE (1..maxFeatureSetCombinations)) OF FeatureSetCombination {	i entries		
FeatureSetCombination[i] SEQUENCE (SIZE (1..maxSimultaneousBands)) OF FeatureSetsPerBand {	ii entries	entry i	
FeatureSetsPerBand[i][j] SEQUENCE (SIZE (1..maxFeatureSetsPerBand)) OF FeatureSet {	iii entries	entry ii	
FeatureSet[i][j][k] CHOICE {		entry iii	
eutra SEQUENCE {			
downlinkSetEUTRA	Not checked	FeatureSetEUTRA-A-DownlinkId	
uplinkSetEUTRA	Not checked	FeatureSetEUTRA-A-UplinkId	
}			
nr SEQUENCE {			
downlinkSetNR	Not checked	FeatureSetDownlinkId	
uplinkSetNR	Not checked	FeatureSetUplinkId	
}			
}			
}			
}			
}			
lateNonCriticalExtension	Not checked		
nonCriticalExtension SEQUENCE {			
fdd-Add-UE-NR-Capabilities-v1530 SEQUENCE {			
eutra-ParametersXDD-Diff SEQUENCE {			
rsrqMeasWidebandEUTRA	Not checked		
}			
}			
tdd-Add-UE-NR-Capabilities-v1530 SEQUENCE {			
eutra-ParametersXDD-Diff SEQUENCE {			
rsrqMeasWidebandEUTRA	Not checked		
}			
}			
dummy	Not checked		
interRAT-Parameters SEQUENCE {			
eutra SEQUENCE {			
supportedBandListEUTRA SEQUENCE (SIZE (1..maxBandsEUTRA)) OF FreqBandIndicatorEUTRA	i entries		
eutra-ParametersCommon SEQUENCE {	Not checked		
mfb-EUTRA	Not checked		
modifiedMRP-BehaviorEUTRA	Not checked		
multiNS-Pmax-EUTRA	Not checked		
rs-SINR-MeasEUTRA	Not checked		
}			
}			
eutra-ParametersXDD-Diff SEQUENCE {			
rsrqMeasWidebandEUTRA	Not checked		
}			

}			
}			
inactiveState	Not checked		
delayBudgetReporting	Not checked		
nonCriticalExtension SEQUENCE {	Not checked		
sdap-Parameters SEQUENCE {			
as-ReflectiveQoS	Checked		pc_as_Refl ectiveQoS
}			
overheatingInd	Not checked		
ims-Parameters SEQUENCE {			
ims-ParametersCommon SEQUENCE {			
voiceOverEUTRA-5GC	Not checked		
}			
ims-ParametersFRX-Diff SEQUENCE {			
voiceOverNR	Not checked		
}			
}			
fr1-Add-UE-NR-Capabilities-v1540 SEQUENCE {			
ims-ParametersFRX-Diff SEQUENCE {			
voiceOverNR	Not checked		
}			
}			
fr2-Add-UE-NR-Capabilities-v1540 SEQUENCE {			
ims-ParametersFRX-Diff SEQUENCE {			
voiceOverNR	Not checked		
}			
}			
fr1-fr2-Add-UE-NR-Capabilities SEQUENCE {			
phy-ParametersFRX-Diff SEQUENCE {			
dynamicSFI	Not checked		
dummy1	Not checked		
twoFL-DMRS	Not checked		
dummy2	Not checked		
dummy3	Not checked		
supportedDMRS-TypeDL	Not checked		
supportedDMRS-TypeUL	Not checked		
semiOpenLoopCSI	Not checked		
csi-ReportWithoutPMI	Not checked		
csi-ReportWithoutCQI	Not checked		
onePortsPTRS	Not checked		
twoPUCCH-F0-2-ConsecSymbols	Not checked		
pucch-F2-WithFH	Not checked		
pucch-F3-WithFH	Not checked		
pucch-F4-WithFH	Not checked		
freqHoppingPUCCH-F0-2	Not checked		
freqHoppingPUCCH-F1-3-4	Not checked		
mux-SR-HARQ-ACK-CSI-PUCCH-MultiPerSlot	Not checked		
uci-CodeBlockSegmentation	Not checked		
onePUCCH-LongAndShortFormat	Not checked		
twoPUCCH-AnyOthersInSlot	Not checked		
intraSlotFreqHopping-PUSCH	Not checked		
pusch-LBRM	Not checked		
pdcc-BlindDetectionCA	Not checked		
tpc-PUSCH-RNTI	Not checked		
tpc-PUSCH-RNTI	Not checked		
tpc-SRS-RNTI	Not checked		
absoluteTPC-Command	Not checked		
twoDifferentTPC-Loop-PUSCH	Not checked		
twoDifferentTPC-Loop-PUCCH	Not checked		
pusch-HalfPi-BPSK	Not checked		
pucch-F3-4-HalfPi-BPSK	Not checked		
almostContiguousCP-OFDM-UL	Not checked		
sp-CSI-RS	Not checked		
sp-CSI-IM	Not checked		

tdd-MultiDL-UL-SwitchPerSlot	Not checked		
multipleCORESET	Not checked		
csi-RS-IM-ReceptionForFeedback	Not checked	CSI-RS-IM-ReceptionForFeedback	
csi-RS-ProcFrameworkForSRS	Not checked	CSI-RS-ProcFrameworkForSRS	
csi-ReportFramework	Not checked	CSI-ReportFramework	
mux-SR-HARQ-ACK-CSI-PUCCH-OncePerSlot SEQUENCE {			
sameSymbol	Not checked		
diffSymbol	Not checked		
}			
mux-SR-HARQ-ACK-PUCCH	Not checked		
mux-MultipleGroupCtrlCH-Overlap	Not checked		
dl-SchedulingOffset-PDSCH-TypeA	Not checked		
dl-SchedulingOffset-PDSCH-TypeB	Not checked		
ul-SchedulingOffset	Not checked		
dl-64QAM-MCS-TableAlt	Not checked		
ul-64QAM-MCS-TableAlt	Not checked		
cqi-TableAlt	Not checked		
oneFL-DMRS-TwoAdditionalDMRS-UL	Not checked		
twoFL-DMRS-TwoAdditionalDMRS-UL	Not checked		
oneFL-DMRS-ThreeAdditionalDMRS-UL	Not checked		
}			
measAndMobParametersFRX-Diff SEQUENCE {			
ss-SINR-Meas	Not checked		
csi-RSRP-AndRSRQ-MeasWithSSB	Checked (NOTE 3)		pc_csi-RSRP-AndRSRQ-MeasWithSSB
csi-RSRP-AndRSRQ-MeasWithoutSSB	Not checked		
csi-SINR-Meas	Not checked		
csi-RS-RLM	Not checked		
handoverInterF	Not checked		
handoverLTE	Not checked		
handover-eLTE	Not checked		
maxNumberResource-CSI-RS-RLM	Not checked		
}			
nonCriticalExtension SEQUENCE {}	Not checked		
}			
}			
<p>Note 1: If the UE is single mode (FDD or TDD), or the UE is dual mode (FDD and TDD) and <i>intraAndInterF-MeasAndReport</i> is supported in both modes, then support of <i>intraAndInterF-MeasAndReport</i> will be signaled in <i>measAndMobParameters/measAndMobParametersXDD-Diff</i>. If the UE is dual mode (FDD + TDD) and <i>intraAndInterF-MeasAndReport</i> is only supported in one mode, then support of <i>intraAndInterF-MeasAndReport</i> will be signaled in one of <i>fdd-Add-UE-NR-Capabilities/measAndMobParametersXDD-Diff</i> or <i>tdd-Add-UE-NR-Capabilities/measAndMobParametersXDD-Diff</i> as appropriate.)</p> <p>Note 2: If the UE is single mode (FDD or TDD), or the UE is dual mode (FDD and TDD) and <i>eventA-MeasAndReport</i> is supported in both modes, then support of <i>eventA-MeasAndReport</i> will be signaled in <i>measAndMobParameters/measAndMobParametersXDD-Diff</i>. If the UE is dual mode (FDD + TDD) and <i>eventA-MeasAndReport</i> is only supported in one mode, then support of <i>eventA-MeasAndReport</i> will be signaled in one of <i>fdd-Add-UE-NR-Capabilities/measAndMobParametersXDD-Diff</i> or <i>tdd-Add-UE-NR-Capabilities/measAndMobParametersXDD-Diff</i> as appropriate.</p> <p>Note 3: If the UE supports single frequency range (FR1 or FR2), or the UE supports both frequency ranges (FR1 and FR2) and <i>csi-RSRP-AndRSRQ-MeasWithSSB</i> is supported in both frequency ranges, then support of <i>csi-RSRP-AndRSRQ-MeasWithSSB</i> will be signaled in <i>measAndMobParameters/MeasAndMobParametersFRX-Diff</i>. If the UE supports both frequency ranges (FR1 + FR2) and <i>csi-RSRP-AndRSRQ-MeasWithSSB</i> is only supported in one frequency range, then support of <i>csi-RSRP-AndRSRQ-MeasWithSSB</i> will be signaled in</p>			

	one of fr1-Add-UE-NR-Capabilities/measAndMobParametersFRX-Diff or fr2-Add-UE-NR-Capabilities/measAndMobParametersFRX-Diff as appropriate.)
Note 4:	If the UE is single mode (FDD or TDD), or the UE is dual mode (FDD and TDD) and <i>skipUplinkTxDynamic</i> is supported in both modes, then support of <i>skipUplinkTxDynamic</i> will be signaled in mac-Parameters/mac-ParametersXDD-Diff. If the UE is dual mode (FDD + TDD) and <i>skipUplinkTxDynamic</i> is only supported in one mode, then <i>skipUplinkTxDynamic</i> will be signaled in one of fdd-Add-UE-NR-Capabilities/mac-ParametersXDD-Diff or tdd-Add-UE-NR-Capabilities/mac-ParametersXDD-Diff as appropriate.
Note 5:	If the UE is single mode (FDD or TDD), or the UE is dual mode (FDD and TDD) and <i>logicalChannelSR-DelayTimer</i> is supported in both modes, then support of <i>logicalChannelSR-DelayTimer</i> will be signaled in mac-Parameters/mac-ParametersXDD-Diff. If the UE is dual mode (FDD + TDD) and <i>logicalChannelSR-DelayTimer</i> is only supported in one mode, then support of <i>logicalChannelSR-DelayTimer</i> will be signaled in one of fdd-Add-UE-NR-Capabilities/mac-ParametersXDD-Diff or tdd-Add-UE-NR-Capabilities/mac-ParametersXDD-Diff as appropriate.
Note 6:	If the UE is single mode (FDD or TDD), or the UE is dual mode (FDD and TDD) and <i>pc_longDRX_Cycle</i> is supported in both modes, then support of <i>pc_longDRX_Cycle</i> will be signaled in mac-Parameters/mac-ParametersXDD-Diff. If the UE is dual mode (FDD + TDD) and <i>pc_longDRX_Cycle</i> is only supported in one mode, then support of <i>pc_longDRX_Cycle</i> will be signaled in one of fdd-Add-UE-NR-Capabilities/mac-ParametersXDD-Diff or tdd-Add-UE-NR-Capabilities/mac-ParametersXDD-Diff as appropriate.
Note 7:	If the UE is single mode (FDD or TDD), or the UE is dual mode (FDD and TDD) and <i>pc_shortDRX_Cycle</i> is supported in both modes, then support of <i>pc_shortDRX_Cycle</i> will be signaled in mac-Parameters/mac-ParametersXDD-Diff. If the UE is dual mode (FDD + TDD) and <i>pc_shortDRX_Cycle</i> is only supported in one mode, then support of <i>pc_shortDRX_Cycle</i> will be signaled in one of fdd-Add-UE-NR-Capabilities/mac-ParametersXDD-Diff or tdd-Add-UE-NR-Capabilities/mac-ParametersXDD-Diff as appropriate.

8.1.5.2 SI change / On-demand SIB

8.1.5.2.1 SI change / Notification of BCCH modification / Short message for SI update

8.1.5.2.1.1 Test Purpose (TP)

(1)

```
with { UE in NR RRC_INACTIVE state }
ensure that {
  when { UE receives a short message transmitted on PDCCH using P-RNTI indicating a
systemInfoModification }
    then { UE re-acquires and applies the new system information about the correct prach-
ConfigurationIndex in random access to resume RRC connection }
}
```

8.1.5.2.1.2 Conformance requirements

References: The conformance requirements covered in the present test case are specified in: TS 38.331, clause 5.2.2.2.2, 5.2.2.3.1 and 6.5.

[TS 38.331, clause 5.2.2.2.2]

A modification period is used, i.e. updated SI (other than for ETWS and CMAS) is broadcasted in the modification period following the one where SI change indication is transmitted. The modification period boundaries are defined by SFN values for which $\text{SFN mod } m = 0$, where m is the number of radio frames comprising the modification period. The modification period is configured by system information. The UE receives indications about SI modifications and/or PWS notifications using Short Message transmitted with P-RNTI over DCI (see clause 6.5). Repetitions of SI change indication may occur within preceding modification period.

UEs in RRC_IDLE or in RRC_INACTIVE shall monitor for SI change indication in its own paging occasion every DRX cycle. UEs in RRC_CONNECTED shall monitor for SI change indication in any paging occasion at least once per modification period if the UE is provided with common search space on the active BWP to monitor paging, as specified in TS 38.213 [13], clause 13.

...

If the UE receives a Short Message, the UE shall:

...

1> if the *systemInfoModification* bit of Short Message is set:

2> apply the SI acquisition procedure as defined in sub-clause 5.2.2.3 from the start of the next modification period.

[TS 38.331, clause 5.2.2.3.1]

The UE shall:

1> apply the specified BCCH configuration defined in 9.1.1.1;

1> if the UE is in RRC_IDLE or in RRC_INACTIVE:

2> acquire the *MIB*, which is scheduled as specified in TS 38.213 [13];

2> if the UE is unable to acquire the *MIB*;

3> perform the actions as specified in clause 5.2.2.5;

2> else:

3> perform the actions specified in clause 5.2.2.4.1.

...

1> if UE is in RRC_IDLE or in RRC_INACTIVE:

2> if *ssb-SubcarrierOffset* indicates *SIB1* is transmitted in the cell (TS 38.213 [13]) and if *SIB1* acquisition is required for the UE:

3> acquire the *SIB1*, which is scheduled as specified in TS 38.213 [13];

3> if the UE is unable to acquire the *SIB1*:

4> perform the actions as specified in clause 5.2.2.5;

3> else:

4> upon acquiring *SIB1*, perform the actions specified in clause 5.2.2.4.2.

...

[TS 38.331, clause 6.5]

Short Messages can be transmitted on PDCCH using P-RNTI with or without associated *Paging* message using Short Message field in DCI format 1_0 (see TS 38.212 [17], clause 7.3.1.2.1).

Table 6.5-1 defines Short Messages. Bit 1 is the most significant bit.

Table 6.5-1: Short Messages

Bit	Short Message
1	<i>systemInfoModification</i> If set to 1: indication of a BCCH modification other than <i>SIB6</i> , <i>SIB7</i> and <i>SIB8</i> .
2	<i>etwsAndCmasIndication</i> If set to 1: indication of an ETWS primary notification and/or an ETWS secondary notification and/or a CMAS notification.
3 – 8	Not used in this release of the specification, and shall be ignored by UE if received.

8.1.5.2.1.3 Test Description

8.1.5.2.1.3.1 Pre-test conditions

System Simulator:

- NR Cell 1
- System information combination NR-1 as defined in TS 38.508-1 [4] clause 4.4.3.1.3 is used in NR cell.

UE:

- None.

Preamble:

- The UE is in 5GS state 2N-A according to TS 38.508-1 [4], clause 4.4A.2 Table 4.4A.2-1.

8.1.5.2.1.3.2 Test procedure sequence

Table 8.1.5.2.1.3.2-1: Main behaviour

St	Procedure	Message Sequence		TP	Verdict
		U - S	Message		
1	The SS transmits a Short message on PDCCH using P-RNTI indicating a <i>systemInfoModification</i> .	-	PDCCH (DCI 1_0): Short Message	-	-
2	The SS changes the <i>prach-ConfigurationIndex</i> in the system information.	-	-	-	-
3	Wait for 2.1* modification period second for the UE to receive new system information. (Note 1)	-	-	-	-
4	The SS transmits a <i>Paging</i> message including a matched identity (<i>correct full-RNTI</i>).	-	NR RRC: <i>Paging</i>	-	-
5	Check: Does the UE transmit a random access using <i>prach-ConfigurationIndex</i> given in step 2?	-	-	2	P
6	The UE transmit an <i>RRCResumeRequest</i> message.	-->	<i>RRCResumeRequest</i>	-	-
7	The SS transmits an <i>RRCResume</i> message.	<--	<i>RRCResume</i>	-	-
8	The UE transmits an <i>RRCResumeComplete</i> message.	-->	<i>RRCResumeComplete</i>	-	-
Note 1: The modification period, expressed in number of radio frames = modificationPeriodCoeff * defaultPagingCycle.					

8.1.5.2.1.3.3 Specific message contents

Table 8.1.5.2.1.3.3-1: SIB1 (step 2, Table 8.1.5.2.1.3.2-1)

Derivation Path: 38.508-1 [4] Table 4.6.1-28			
Information Element	Value/remark	Comment	Condition
SIB1 ::= SEQUENCE {			
ServingCellConfigCommon	ServingCellConfigComm onSIB		
}			

Table 8.1.5.2.1.3.3-2: *ServingCellConfigCommonSIB* (Table 8.1.5.2.1.3.3-1)

Derivation Path: TS 38.508-1 [4], Table 4.6.3-169			
Information Element	Value/remark	Comment	Condition
ServingCellConfigCommonSIB ::= SEQUENCE {			
UplinkConfigCommonSIB SEQUENCE {			
initialUplinkBWP	BWP-UplinkCommon		
}			
}			

Table 8.1.5.2.1.3.3-3: *BWP-UplinkCommon* (Table 8.1.5.2.1.3.3-2)

Derivation Path: TS 38.508-1 [4], Table 4.6.3-14			
Information Element	Value/remark	Comment	Condition
BWP-UplinkCommon ::= SEQUENCE {			
rach-ConfigCommon CHOICE {			
setup	RACH-ConfigCommon		
}			
}			

Table 8.1.5.2.1.3.3-4: *RACH-ConfigCommon* (Table 8.1.5.2.1.3.3-3)

Derivation Path: TS 38.508-1 [4], Table 4.6.3-128			
Information Element	Value/remark	Comment	Condition
RACH-ConfigCommon ::= SEQUENCE {			
rach-ConfigGeneric	RACH-ConfigGeneric		
}			

Table 8.1.5.2.1.3.3-5: *RACH-ConfigGeneric* (Table 8.1.5.2.1.3.3-4)

Derivation Path: TS 38.508-1 [4], Table 4.6.3-130			
Information Element	Value/remark	Comment	Condition
RACH-ConfigGeneric ::= SEQUENCE {			
prach-ConfigurationIndex	157	Value to be used in Step 2.	FR1
	157	Value to be used in Step 2.	FR2
}			

Table 8.1.5.2.1.3.3-6: *Paging* (step 4, Table 8.1.5.2.1.3.2-1)

Derivation Path: 38.508-1, Table 4.6.1-9			
Information Element	Value/remark	Comment	Condition
Paging ::= SEQUENCE {			
pagingRecordList SEQUENCE (SIZE(1..maxNrofPageRec)) OF PagingRecord {	1 entry		
PagingRecord[1] SEQUENCE {		entry 1	
ue-Identity CHOICE {			
fullI-RNTI	Set to the value of the I-RNTI-Value of the UE		
}			
}			
}			
}			

8.1.5.2.2 SI change / Notification of BCCH modification / Short message for SI update in NR RRC_CONNECTED state

8.1.5.2.2.1 Test Purpose (TP)

(1)

```
with { UE in NR RRC_CONNECTED state }
ensure that {
  when { UE receives a short message transmitted on PDCCH using P-RNTI indicating a
systemInfoModification }
  then { UE re-acquires the SIB1 }
}
```

8.1.5.2.2.2 Conformance requirements

References: The conformance requirements covered in the present test case are specified in: TS 38.331, clause 5.2.2.2.2, 5.2.2.3.1, 5.2.2.4.2 and 6.5. Unless otherwise stated these are Rel-15 requirements.

[TS 38.331, clause 5.2.2.2.2]

A modification period is used, i.e. updated SI (other than for ETWS and CMAS) is broadcasted in the modification period following the one where SI change indication is transmitted. The modification period boundaries are defined by SFN values for which $\text{SFN mod } m = 0$, where m is the number of radio frames comprising the modification period. The modification period is configured by system information. The UE receives indications about SI modifications and/or PWS notifications using Short Message transmitted with P-RNTI over DCI (see clause 6.5). Repetitions of SI change indication may occur within preceding modification period.

UEs in RRC_IDLE or in RRC_INACTIVE shall monitor for SI change indication in its own paging occasion every DRX cycle. UEs in RRC_CONNECTED shall monitor for SI change indication in any paging occasion at least once per modification period if the UE is provided with common search space on the active BWP to monitor paging, as specified in TS 38.213 [13], clause 13.

...

If the UE receives a Short Message, the UE shall:

...

1> if the *systemInfoModification* bit of Short Message is set:

2> apply the SI acquisition procedure as defined in sub-clause 5.2.2.3 from the start of the next modification.

[TS 38.331, clause 5.2.2.3.1]

The UE shall:

1> apply the specified BCCH configuration defined in 9.1.1.1;

...

1> if the UE is in RRC_CONNECTED with an active BWP with common search space configured by *searchSpaceSIB1* and *pagingSearchSpace* and has received an indication about change of system information; or

...

NOTE: The UE in RRC_CONNECTED is only required to acquire broadcasted *SIB1* if the UE can acquire it without disrupting unicast data reception, i.e. the broadcast and unicast beams are quasi co-located.

[TS 38.331, clause 5.2.2.4.2]

Upon receiving the *SIB1* the UE shall:

...

- 3> if the UE has a stored valid version of a SIB, in accordance with sub-clause 5.2.2.2.1, that the UE requires to operate within the cell in accordance with sub-clause 5.2.2.1:
 - 4> use the stored version of the required SIB;
- 3> if the UE has not stored a valid version of a SIB, in accordance with sub-clause 5.2.2.2.1, of one or several required SIB(s), in accordance with sub-clause 5.2.2.1:
 - 4> for the SI message(s) that, according to the *si-SchedulingInfo*, contain at least one required SIB and for which *si-BroadcastStatus* is set to broadcasting:
 - 5> acquire the SI message(s) as defined in sub-clause 5.2.2.3.2;

[TS 38.331, clause 6.5]

Short messages can be transmitted on PDCCH using P-RNTI with or without associated *Paging* message using Short Message field in DCI format 1_0 (see TS 38.212 [17, 7.3.1.2.1]).

Table 6.5-1 defines Short Messages. Bit 1 is the most significant bit.

Table 6.5-1: Short messages

Bit	Short message
1	<i>systemInfoModification</i> If set to 1: indication of a BCCH modification other than SIB6, SIB7 and SIB8.
2	<i>etwsAndCmasIndication</i> If set to 1: indication of an ETWS primary notification and/or an ETWS secondary notification and/or a CMAS notification.
3 – [8]	Not used in this release of the specification, and shall be ignored by UE if received.

8.1.5.2.2.3 Test Description

8.1.5.2.2.3.1 Pre-test conditions

System Simulator:

- NR Cell 1
- System information combination NR-1 as defined in TS 38.508-1 [4] clause 4.4.3.1.3 is used in NR cell.

UE:

- None.

Preamble:

- The UE is in 5GS state 3N-A and Test Loop Function (ON) with UE test loop mode B established according to TS 38.508-1 [4], clause 4.4A.2 Table 4.4A.2-3.

8.1.5.2.2.3.2 Test procedure sequence

Table 8.1.5.2.2.3.2-1: Main behaviour

St	Procedure	Message Sequence		TP	Verdict
		U - S	Message		
1	The SS sends one IP Packet to the UE.	-	-	-	-
1A	The SS waits 0.5 second and then ignores scheduling requests and does not allocate any uplink grant.	-	-	-	-
2	The SS transmits a Short message on PDCCH using P-RNTI indicating a systemInfoModification.	-	PDCCH (DCI 1_0): Short Message	-	-
3	The SS changes the prach-ConfigurationIndex in the system information.	-	-	-	-
4	Void	-	-	-	-
5	Check: Does the UE initiate a random access using prach-ConfigurationIndex given in step 3 to send pending Uplink data?	-	-	1	P
6	The SS transmits Random Access Response with RAPID corresponding to preamble in step 5. (Note 1)	-	-	-	-
7	The UE loop backs the IP packets received in step 1	-	-	-	-
8	The SS starts the UL default grant transmissions.				
Note 1: The resource allocation for Msg3 shall be enough to accommodate all of the DRB data that UE will loop back at step 7. To be more specific, resource allocation shall be no less than: TB size = IP packet (64 bytes) + SDAP header (1 bytes) + PDCP header (3 bytes) + RLC header (3 bytes) + MAC header (2 bytes) + padding or BSR (2 bytes) + C-RNTI MAC CE (2 Bytes) = 77 bytes.					

8.1.5.2.2.3.3 Specific message contents

Table 8.1.5.2.2.3.3-1: CLOSE UE TEST LOOP (Preamble, Table 8.1.5.2.2.3.2-1)

Derivation path: 36.508-1 [7] table 4.7A-3 condition UE test loop mode B			
Information Element	Value/Remark	Comment	Condition
UE test loop mode B LB setup			
IP PDU delay	'0000 1111'B	15 seconds	

Table 8.1.5.2.2.3.3-2: SIB1 (step 3, Table 8.1.5.2.2.3.2-1)

Derivation path: 38.508-1 [4] table 4.6.1-28			
Information Element	Value/Remark	Comment	Condition
SIB1 ::= SEQUENCE {			
servingCellConfigCommon SEQUENCE {			
uplinkConfigCommon SEQUENCE {			
initialUplinkBWP SEQUENCE {			
RACH-ConfigCommon SEQUENCE {			
RACH-ConfigGeneric SEQUENCE {			
prach-ConfigurationIndex	119		FR1 FDD
	94		FR1 TDD
	6		FR2
}			
}			
}			
}			
}			
}			

8.1.5.3 PWS notification

8.1.5.3.1 PWS notification / PWS reception in NR RRC_IDLE state

8.1.5.3.1.1 Test Purpose (TP)

(1)

```
with { UE in NR RRC_IDLE state }
ensure that {
  when { an ETWS capable UE receives a short message transmitted on PDCCH using P-RNTI indicating an
etwsAndCmasIndication and the si-SchedulingInfo includes scheduling information for SIB6 }
  then { the UE is able to retrieve the PWS message from SIB6 and alert the user }
}
```

(2)

```
with { UE in NR RRC_IDLE state }
ensure that {
  when { an ETWS capable UE receives a short message transmitted on PDCCH using P-RNTI indicating an
etwsAndCmasIndication and the si-SchedulingInfo includes scheduling information for SIB7 }
  then { the UE is able to retrieve all the PWS message segments from SIB7, reassemble the message
and alert the user }
}
```

(3)

```
with { UE in NR RRC_IDLE state }
ensure that {
  when { a CMAS capable UE receives a short message transmitted on PDCCH using P-RNTI indicating an
etwsAndCmasIndication and the si-SchedulingInfo includes scheduling information for SIB8 }
  then { the UE is able to retrieve all the PWS message segments from SIB8, reassemble the message
and alert the user }
}
```

8.1.5.3.1.2 Conformance requirements

References: The conformance requirements covered in the current TC are specified in: TS 38.331 clause 5.2.2.2.2.

[TS 38.331 clause 5.2.2.2.2]

...

ETWS or CMAS capable UEs in RRC_IDLE or in RRC_INACTIVE shall monitor for indications about PWS notification in its own paging occasion every DRX cycle. ETWS or CMAS capable UEs in RRC_CONNECTED shall monitor for indication about PWS notification in any paging occasion at least once every *defaultPagingCycle* if the UE is provided with common search space on the active BWP to monitor paging.

For Short Message reception in a paging occasion, the UE monitors the PDCCH monitoring occasion(s) for paging as specified in TS 38.304 [20] and TS 38.213 [13].

If the UE receives a Short Message, the UE shall:

- 1> if the UE is ETWS capable or CMAS capable, the *etwsAndCmasIndication* bit of Short Message is set, and the UE is provided with *searchSpaceOtherSystemInformation* on the active BWP:
 - 2> immediately re-acquire the *SIB1*;
- 2> if the UE is ETWS capable and *si-SchedulingInfo* includes scheduling information for *SIB6*:
 - 3> acquire *SIB6*, as specified in sub-clause 5.2.2.3.2, immediately;
- 2> if the UE is ETWS capable and *si-SchedulingInfo* includes scheduling information for *SIB7*:
 - 3> acquire *SIB7*, as specified in sub-clause 5.2.2.3.2, immediately;
- 2> if the UE is CMAS capable and *si-SchedulingInfo* includes scheduling information for *SIB8*:

3> acquire *SIB8*, as specified in sub-clause 5.2.2.3.2, immediately;

1> if the *systemInfoModification* bit of Short Message is set:

2> apply the SI acquisition procedure as defined in sub-clause 5.2.2.3 from the start of the next modification period.

8.1.5.3.1.3 Test description

8.1.5.3.1.3.1 Pre-test conditions

System Simulator:

- NR Cell 1.

UE:

- None.

Preamble:

- The UE is in test state 1N-A according to TS 38.508-1 [4].

8.1.5.3.1.3.2 Test procedure sequence

Table 8.1.5.3.1.3.2-1: Main behaviour

St	Procedure	Message Sequence		TP	Verdict
		U - S	Message		
-	If pc_ETWS_NR is true, step1-8 will be executed.	-	-	-	-
1	The SS indicates an etwsAndCmasIndication by Short Message field in DCI format 1_0 and transmitted on PDCCH using P-RNTI. The SS starts transmitting SIB1 with the si-SchedulingInfo including scheduling information for SIB6 on NR Cell 1.	<--	PDCCH (DCI 1_0): Short Message	-	-
2	The SS includes an ETWS message with new <i>messageIdentifier</i> and <i>serialNumber</i> in SIB6. (Note 1)	-	-	-	-
3	Check: Does the UE alert or activate alerting the user (NOTE 2)?	-	-	1	P
4	The SS waits for 10s.	-	-	-	-
5	The SS indicates an etwsAndCmasIndication by Short Message field in DCI format 1_0 and transmitted on PDCCH using P-RNTI. The SS starts transmitting SIB1 with the si-SchedulingInfo including scheduling information for SIB7 on NR Cell 1.	<--	PDCCH (DCI 1_0): Short Message	-	-
6	The SS includes an ETWS message with new <i>messageIdentifier</i> and <i>serialNumber</i> in SIB7. (NOTE 3).	-	-	-	-
7	Check: Does the UE indicate the contents of the "warning message" to the user, and alert or activate alerting the user (NOTE 2)?	-	-	2	P
8	The SS waits for 10s.	-	-	-	-
-	If pc_CMAS_NR is true, step9-11 will be executed.	-	-	-	-
9	The SS indicates an etwsAndCmasIndication by Short Message field in DCI format 1_0 and transmitted on PDCCH using P-RNTI. The SS starts transmitting SIB1 with the si-SchedulingInfo including scheduling information for SIB8 on NR Cell 1.	<--	PDCCH (DCI 1_0): Short Message	-	-
10	The SS includes a CMAS message with new <i>messageIdentifier</i> and <i>serialNumber</i> in SIB8. (NOTE 4).	-	-	-	-
11	Check: Does the UE indicate the contents of the "warning message" to the user, and alert or activate alerting the user (NOTE 2)?	-	-	3	P
NOTE 1: The NR-10 in Table 4.4.3.1.2-1 Combinations of system information blocks of TS 38.508-1 [4] is used.					
NOTE 2: The data indication and user alerting are the UE implementation issues.					
NOTE 3: The NR-11 in Table 4.4.3.1.2-1 Combinations of system information blocks of TS 38.508-1 [4] is used.					
NOTE 4: The NR-9 in Table 4.4.3.1.2-1 Combinations of system information blocks of TS 38.508-1 [4] is used.					

8.1.5.3.1.3.3 Specific message contents

None

8.1.5.3.2 PWS notification / PWS reception in NR RRC_INACTIVE state

8.1.5.3.2.1 Test Purpose (TP)

(1)

```
with { UE in NR RRC_INACTIVE state }
ensure that {
```



```

when { an ETWS capable UE receives a short message transmitted on PDCCH using P-RNTI indicating an
etwsAndCmasIndication and the si-SchedulingInfo includes scheduling information for SIB6 }
  then { the UE is able to retrieve the PWS message from SIB6 and alert the user }
}

```

(2)

```

with { UE in NR RRC_INACTIVE state }
ensure that {
  when { an ETWS capable UE receives a short message transmitted on PDCCH using P-RNTI indicating an
etwsAndCmasIndication and the si-SchedulingInfo includes scheduling information for SIB7 }
    then { the UE is able to retrieve all the PWS message segments from SIB7, reassemble the message
and alert the user }
}

```

(3)

```

with { UE in NR RRC_INACTIVE state }
ensure that {
  when { a CMAS capable UE receives a short message transmitted on PDCCH using P-RNTI indicating an
etwsAndCmasIndication and the si-SchedulingInfo includes scheduling information for SIB8 }
    then { the UE is able to retrieve all the PWS message segments from SIB8, reassemble the message
and alert the user }
}

```

8.1.5.3.2.2 Conformance requirements

Same as test case 8.1.5.3.1.

8.1.5.3.2.3 Test description

8.1.5.3.2.3.1 Pre-test conditions

System Simulator:

- NR Cell 1.

UE:

None.

Preamble:

- The UE is in state Registered, Inactive mode (state 2N-A) according to TS 38.508-1 [4].

8.1.5.3.2.3.2 Test procedure sequence

Same as test case 8.1.5.3.1

8.1.5.3.2.3.3 Specific message contents

Same as test case 8.1.5.3.1.

8.1.5.3.3 PWS notification / PWS reception in NR RRC_CONNECTED state

8.1.5.3.3.1 Test Purpose (TP)

(1)

```

with { UE in NR RRC_CONNECTED state }
ensure that {
  when { an ETWS capable UE receives a short message transmitted on PDCCH using P-RNTI indicating an
etwsAndCmasIndication and the si-SchedulingInfo includes scheduling information for SIB6 }
    then { the UE is able to retrieve all the PWS message segments from SIB6, reassemble the message
and alert the user }
}

```

```
    }
```

(2)

```
with { UE in NR RRC_CONNECTED state }
ensure that {
  when { an ETWS capable UE receives a short message transmitted on PDCCH using P-RNTI indicating an
etwsAndCmasIndication and the si-SchedulingInfo includes scheduling information for SIB7 }
  then { the UE is able to retrieve all the PWS message segments from SIB7, reassemble the message
and alert the user }
}
```

(3)

```
with { UE in NR RRC_CONNECTED state }
ensure that {
  when { a CMAS capable UE receives a short message transmitted on PDCCH using P-RNTI indicating an
etwsAndCmasIndication and the si-SchedulingInfo includes scheduling information for SIB8 }
  then { the UE is able to retrieve all the PWS message segments from SIB8, reassemble the message
and alert the user }
}
```

8.1.5.3.3.2 Conformance requirements

Same as test case 8.1.5.3.1.

8.1.5.3.3.3 Test description

8.1.5.3.3.3.1 Pre-test conditions

System Simulator:

- NR Cell 1.

UE:

None.

Preamble:

- The UE is in test state 3N-A according to TS 38.508-1 [4].

8.1.5.3.3.3.2 Test procedure sequence

Same as test case 8.1.5.3.1 except PDCCH (DCI 1_0): Short Message is sent on active BWP.

8.1.5.3.3.3.3 Specific message contents

Same as test case 8.1.5.3.1.

8.1.5.3.4 PWS notification / PWS reception using dedicatedSystemInformationDelivery

8.1.5.3.4.1 Test Purpose (TP)

(1)

```
with { UE in NR RRC_CONNECTED state }
ensure that {
  when { UE receives an RRCReconfiguration message including dedicatedSystemInformationDelivery
containing SIB6 }
  then { UE reads the SIB6 to alert the user and sends an RRCReconfigurationComplete message }
}
```

(2)

```

with { UE in NR RRC_CONNECTED state }
ensure that {
  when { UE receives an RRCReconfiguration message including dedicatedSystemInformationDelivery
containing SIB7 }
    then { UE reads the SIB7 to alert the user and sends an RRCReconfigurationComplete message }
}

```

(3)

```

with { UE in NR RRC_CONNECTED state }
ensure that {
  when { UE receives an RRCReconfiguration message including dedicatedSystemInformationDelivery
containing SIB8 }
    then { UE reads the SIB8 to alert the user and sends an RRCReconfigurationComplete message }
}

```

8.1.5.3.4.2 Conformance requirements

References: The conformance requirements covered in the present TC are specified in: TS 38.331, clauses 5.2.2.4.7, 5.2.2.4.8, 5.2.2.4.9, 5.3.5.3. Unless otherwise stated these are Rel-15 requirements.

[TS 38.331, clause 5.3.5.3]

The UE shall perform the following actions upon reception of the *RRCReconfiguration*:

- 1> if the *RRCReconfiguration* message includes the *dedicatedSIB1-Delivery*:
 - 2> perform the action upon reception of *SIB1* as specified in 5.2.2.4.2;
- 1> if the *RRCReconfiguration* message includes the *dedicatedSystemInformationDelivery*:
 - 2> perform the action upon reception of System Information as specified in 5.2.2.4;

[TS 38.331, clause 5.2.2.4.7]

Upon receiving the *SIB6* the UE shall:

- 1> forward the received *warningType*, *messageIdentifier* and *serialNumber* to upper layers;

[TS 38.331, clause 5.2.2.4.8]

Upon receiving the *SIB7* the UE shall:

- 1> if there is no current value for *messageIdentifier* and *serialNumber* for *SIB7*; or
- 1> if either the received value of *messageIdentifier* or of *serialNumber* or of both are different from the current values of *messageIdentifier* and *serialNumber* for *SIB7*:
 - 2> use the received values of *messageIdentifier* and *serialNumber* for *SIB7* as the current values of *messageIdentifier* and *serialNumber* for *SIB7*;
 - 2> discard any previously buffered *warningMessageSegment*;
 - 2> if all segments of a warning message have been received:
 - 3> assemble the warning message from the received *warningMessageSegment*;
 - 3> forward the received warning message, *messageIdentifier*, *serialNumber* and *dataCodingScheme* to upper layers;
 - 3> stop reception of *SIB7*;
 - 3> discard the current values of *messageIdentifier* and *serialNumber* for *SIB7*;
- 2> else:
 - 3> store the received *warningMessageSegment*;

- 3> continue reception of *SIB7*;
- 1> else if all segments of a warning message have been received:
 - 2> assemble the warning message from the received *warningMessageSegment*;
 - 2> forward the received complete warning message, *messageIdentifier*, *serialNumber* and *dataCodingScheme* to upper layers;
 - 2> stop reception of *SIB7*;
 - 2> discard the current values of *messageIdentifier* and *serialNumber* for *SIB7*;
- 1> else:
 - 2> store the received *warningMessageSegment*;
 - 2> continue reception of *SIB7*;

The UE should discard any stored *warningMessageSegment* and the current value of *messageIdentifier* and *serialNumber* for *SIB7* if the complete warning message has not been assembled within a period of 3 hours.

[TS 38.331, clause 5.2.2.4.9]

Upon receiving the *SIB8* the UE shall:

- 1> if the *SIB8* contains a complete warning message and the complete geographical area coordinates (if any):
 - 2> forward the received warning message, *messageIdentifier*, *serialNumber*, *dataCodingScheme* and the geographical area coordinates (if any) to upper layers;
 - 2> continue reception of *SIB8*;
- 1> else:
 - 2> if the received values of *messageIdentifier* and *serialNumber* are the same (each value is the same) as a pair for which a warning message and the geographical area coordinates (if any) are currently being assembled:
 - 3> store the received *warningMessageSegment*;
 - 3> store the received *warningAreaCoordinatesSegment* (if any);
 - 3> if all segments of a warning message and geographical area coordinates (if any) have been received:
 - 4> assemble the warning message from the received *warningMessageSegment*;
 - 4> assemble the geographical area coordinates from the received *warningAreaCoordinatesSegment* (if any);
 - 4> forward the received warning message, *messageIdentifier*, *serialNumber*, *dataCodingScheme* and geographical area coordinates (if any) to upper layers;
 - 4> stop assembling a warning message and geographical area coordinates (if any) for this *messageIdentifier* and *serialNumber* and delete all stored information held for it;
 - 3> continue reception of *SIB8*;
- 2> else if the received values of *messageIdentifier* and/or *serialNumber* are not the same as any of the pairs for which a warning message is currently being assembled:
 - 3> start assembling a warning message for this *messageIdentifier* and *serialNumber* pair;
 - 3> start assembling the geographical area coordinates (if any) for this *messageIdentifier* and *serialNumber* pair;
 - 3> store the received *warningMessageSegment*;
 - 3> store the received *warningAreaCoordinatesSegment* (if any);

3> continue reception of *SIB8*;

The UE should discard *warningMessageSegment* and *warningAreaCoordinatesSegment* (if any) and the associated values of *messageIdentifier* and *serialNumber* for *SIB8* if the complete warning message and the geographical area coordinates (if any) have not been assembled within a period of 3 hours.

NOTE: The number of warning messages that a UE can re-assemble simultaneously is a function of UE implementation.

8.1.5.3.4.3 Test description

8.1.5.3.4.3.1 Pre-test conditions

System Simulator:

- NR Cell 1.

UE:

- None

Preamble:

- The UE is in 5GS state 3N-A according to TS 38.508-1 [4], clause 4.4A.2 Table 4.4A.2-1

8.1.5.3.4.3.2 Test procedure sequence

Table 8.1.5.3.4.3.2-1: Main behaviour

St	Procedure	Message Sequence		TP	Verdict
		U - S	Message		
-	If <i>pc_ETWS_NR</i> is true, steps 1-6 will be excuted.	-	-	-	-
1	The SS transmits an <i>RRCReconfiguration</i> message containing <i>dedicatedSystemInformationDelivery</i> containing <i>SIB6</i> .	<--	NR RRC: <i>RRCReconfiguration</i>	-	-
2	Check: Does the UE transmit an <i>RRCReconfigurationComplete</i> message?	-->	NR RRC: <i>RRCReconfigurationComplete</i>	-	-
3	Check: Does the UE alert or activate alerting the user (NOTE 1)?	-	-	1	P
4	The SS transmits an <i>RRCReconfiguration</i> message containing <i>dedicatedSystemInformationDelivery</i> containing <i>SIB7</i> .	<--	NR RRC: <i>RRCReconfiguration</i>	-	-
5	Check: Does the UE transmit an <i>RRCReconfigurationComplete</i> message?	-->	NR RRC: <i>RRCReconfigurationComplete</i>	-	-
6	Check: Does the UE indicate the "warning message" to the user, and alert or activate alerting the user (NOTE 1)?	-	-	2	P
-	If <i>pc_CMAS_NR</i> is true, steps 7-9 will be excuted.	-	-	-	-
7	The SS transmits an <i>RRCReconfiguration</i> message containing <i>dedicatedSystemInformationDelivery</i> containing <i>SIB8</i> .	<--	NR RRC: <i>RRCReconfiguration</i>	-	-
8	Check: Does the UE transmit an <i>RRCReconfigurationComplete</i> message?	-->	NR RRC: <i>RRCReconfigurationComplete</i>	-	-
9	Check: Does the UE alert or activate alerting the user (NOTE 1)?	-	-	3	P

NOTE 1: The data indication and user alerting are the UE implementation issues.

8.1.5.3.4.3.3 Specific message contents

Table 8.1.5.3.4.3.3-1: RRCReconfiguration (Steps 1, 4 and 7 Table 8.1.5.3.4.3.2-1)

Derivation Path: 38.508-1 [4], Table 4.6.1-13			
Information Element	Value/remark	Comment	Condition
RRCReconfiguration ::= SEQUENCE {			
criticalExtensions CHOICE {			
rrcReconfiguration SEQUENCE {			
nonCriticalExtension SEQUENCE {			
masterCellGroup	Not present		
dedicatedNAS-MessageList	Not present		
dedicatedSystemInformationDelivery	SystemInformation	OCTET STRING (CONTAINING SystemInformatio n)	
}			
}			
}			
}			

Table 8.1.5.3.4.3.3-2: SystemInformation (Steps 1, 4 and 7 Table 8.1.5.3.4.3.2-1)

Derivation Path: 38.508-1 [4], Table 4.6.1-29			
Information Element	Value/remark	Comment	Condition
SystemInformation ::= SEQUENCE {			
criticalExtensions CHOICE {			
systemInformation-r15 SEQUENCE {			
sib-TypeAndInfo SEQUENCE (SIZE (1..maxSIB))	1 entry		
OF CHOICE {			
sib6	SIB6	Acc to 38.508-1 [4] Table 4.6.2-5: SIB6	Step 1
sib7	SIB7		Step 4
sib8	SIB8		Step 7
}			
lateNonCriticalExtension	Not present		
nonCriticalExtension SEQUENCE {}	Not present		
}			
}			
}			

Table 8.1.5.3.4.3.3-3: *SIB7* (Step 4 in Table 8.1.5.3.4.3.2-1)

Derivation Path: TS 38.331 [6], clause 6.3.1			
Information Element	Value/remark	Comment	Condition
SIB7 ::= SEQUENCE {			
messageIdentifier	'0001 0001 0000 0010'B	ETWS message identifier for earthquake and tsunami message (see TS 23.041 [25])	
serialNumber	'0011 0000 0000 0000'B	Note 1.	
warningMessageSegmentType	lastSegment		
warningMessageSegmentNumber	0		
warningMessageSegment	Octetstring of N	Containing the complete ETWS message	
dataCodingScheme	Bitstring (8) ID of the alphabet/coding and the applied language	see TS 23.041 [25].	
lateNonCriticalExtension	Not present		
}			
Note 1: Geographical Scope (Octet 1 bit 7 ~ 6) set to 'Cell wide', Emergency User Alert (Octet 1 bit 5) set to 'Activate emergency user alert', Popup (Octet 1 bit 4) set to 'Activate popup', Update Number (Octet 2 bits 3~0) for each update, incremented by one, See TS 23.041 [25].			

Table 8.1.5.3.4.3.3-4: *SIB8* (Step 7 in Table 8.1.5.3.4.3.2-1)

Derivation Path: TS 38.331 [6], clause 6.3.1			
Information Element	Value/remark	Comment	Condition
SIB8 ::= SEQUENCE {			
messageIdentifier	'0001 0001 0001 0010'B	CMAS CBS Message Identifier for CMAS Presidential Level Alerts (see TS 23.041 [25])	
serialNumber	'0011 0000 0000 0000'B	Note 1	
warningMessageSegmentType	lastSegment		
warningMessageSegmentNumber	0		
warningMessageSegment	Octetstring of N		
dataCodingScheme	Bitstring (8) ID of the alphabet/coding and the applied language	Containing the complete CMAS message	
warningAreaCoordinatesSegment	Not present		
lateNonCriticalExtension	Not present		
}			
Note 1: Geographical Scope (Octet 1 bit 7 ~ 6) set to 'Cell wide', Emergency User Alert (Octet 1 bit 5) set to 'Activate emergency user alert', Popup (Octet 1 bit 4) set to 'Activate popup', Update Number (Octet 2 bits 3~0) for each update, incremented by one, See TS 23.041 [25].			

8.1.5.4 Counter check

8.1.5.4.1 Counter check / Reception of CounterCheck message by the UE

8.1.5.4.1.1 Test Purpose (TP)

(1)

```
with { UE in NR RRC_CONNECTED state with two DRBs established and having received 10 data packets on
each DRB }
ensure that {
  when { UE receives CounterCheck message with drb-CountMSB-InfoList included for DRB3(not
established) and DRB1 (with the most significant bits of the count different from the actual COUNT) }
  then { UE sends CounterCheckResponse message by including the drb-Identity, the count-Uplink and
the count-Downlink set to the value of TX_NEXT - 1 and RX_NEXT - 1 in drb-CountInfoList IE for each
DRB established, and by including the drb-Identity, the count-Uplink and the count-Downlink with the
most significant bits set identical to the corresponding values in the drb-CountMSB-InfoList and the
least significant bits set to zero for the DRB that is not established }
}
```

8.1.5.4.1.2 Conformance requirements

References: The conformance requirements covered in the current TC are specified in: TS 38.331, clause 5.3.6.3.

Unless otherwise stated these are Rel-15 requirements.

[TS 38.331, clause 5.3.6.3]

Upon receiving the *CounterCheck* message, the UE shall:

- 1> for each DRB that is established:
 - 2> if no COUNT exists for a given direction (uplink or downlink) because it is a uni-directional bearer configured only for the other direction:
 - 3> assume the COUNT value to be 0 for the unused direction;
 - 2> if the *drb-Identity* is not included in the *drb-CountMSB-InfoList*:
 - 3> include the DRB in the *drb-CountInfoList* in the *CounterCheckResponse* message by including the *drb-Identity*, the *count-Uplink* and the *count-Downlink* set to the value of TX_NEXT - 1 and RX_NEXT - 1 (specified in TS 38.323 [5]), respectively;
 - 2> else if, for at least one direction, the most significant bits of the COUNT are different from the value indicated in the *drb-CountMSB-InfoList*:
 - 3> include the DRB in the *drb-CountInfoList* in the *CounterCheckResponse* message by including the *drb-Identity*, the *count-Uplink* and the *count-Downlink* set to the value of TX_NEXT - 1 and RX_NEXT - 1 (specified in TS 38.323 [5]), respectively;
- 1> for each DRB that is included in the *drb-CountMSB-InfoList* in the *CounterCheck* message that is not established:
 - 2> include the DRB in the *drb-CountInfoList* in the *CounterCheckResponse* message by including the *drb-Identity*, the *count-Uplink* and the *count-Downlink* with the most significant bits set identical to the corresponding values in the *drb-CountMSB-InfoList* and the least significant bits set to zero;
- 1> submit the *CounterCheckResponse* message to lower layers for transmission upon which the procedure ends.

8.1.5.4.1.3 Test description

8.1.5.4.1.3.1 Pre-test conditions

System Simulator:

- NR Cell 1.

- System information combination NR-1 as defined in TS 38.508-1 [4] clause 4.4.3.1.3 is used in the NR cell.

UE:

- None.

Preamble:

- The UE is in 5GS state 3N-A on NR Cell 1 with at least one PDU session active according to TS 38.508-1 [4], clause 4.4A.3 Table 4.4A.3-1 and Test Loop Function (On) with UE test loop mode B is established. 2 DRBs are configured where DRB1 is defined as default DRB.

8.1.5.4.1.3.2 Test procedure sequence

Table 8.1.5.4.1.3.2-1: Main behaviour

St	Procedure	Message Sequence		TP	Verdict
		U - S	Message		
1	The SS transmits 10 IP packets on each DRB (using QFI2 for DRB1 and QFI5 for DRB2)	-	-	-	-
2	The UE loops back the IP packets received in step 1	-	-	-	-
3	The SS transmits CounterCheck message with drb-Identity not included in the drb-CountMSB-InfoList	<-	NR RRC: <i>CounterCheck</i>	-	-
4	Check: Does the UE send CounterCheckResponse message by including the drb-Identity, the count-Uplink and the count-Downlink set to the value of TX_NEXT – 1 and RX_NEXT – 1 in drb-CountInfoList IE for each DRB established?	-->	NR RRC: <i>CounterCheckResponse</i>	1	P

8.1.5.4.1.3.3 Specific message contents

Table 8.1.5.4.1.3.3-1: RRCReconfiguration (Preamble, Table 8.1.5.4.1.3.2-1)

Derivation Path: TS 38.508-1 [4], table 4.6.1-13 with condition NR			
Information Element	Value/remark	Comment	Condition
RRCReconfiguration ::= SEQUENCE {			
criticalExtensions CHOICE {			
rrcReconfiguration SEQUENCE {			
radioBearerConfig	RadioBearerConfig-2DRBs		
nonCriticalExtension SEQUENCE {			
masterCellGroup	CellGroupConfig-2DRBs	OCTET STRING (CONTAINING CellGroupConfig)	
}			
}			
}			
}			

Table 8.1.5.4.1.3.3-2: RadioBearerConfig-2DRBs (Preamble, Table 8.1.5.4.1.3.3-1)

Derivation Path: TS 38.508-1 [4], table 4.6.3-132 and condition SRB2 and DRB1			
Information Element	Value/remark	Comment	Condition
RadioBearerConfig ::= SEQUENCE {			
drb-ToAddModList SEQUENCE (SIZE (1..maxDRB)) OF DRB-ToAddMod {	2 entries		
DRB-ToAddMod[1] SEQUENCE {		entry 1	
cnAssociation CHOICE {			
sdap-Config ::= SEQUENCE {			
pdu-Session	PDU session ID	Same as the PDU session ID in PDU SESSION ESTABLISHMENT REQUEST	
defaultDRB	true		
mappedQoS-FlowsToAdd SEQUENCE {			
QFI	2		
}			
}			
drb-Identity	DRB-Identity with Condition DRB1		
}			
}			
DRB-ToAddMod[2] SEQUENCE		entry 2	
cnAssociation CHOICE {			
sdap-Config SEQUENCE {			
pdu-Session	PDU session ID	Same as the PDU session ID in PDU SESSION ESTABLISHMENT REQUEST	
defaultDRB	false		
mappedQoS-FlowsToAdd SEQUENCE {			
QFI	5		
}			
}			
drb-Identity	DRB-Identity with Condition DRB2		
}			
}			
}			
}			

Table 8.1.5.4.1.3.3-3: CellGroupConfig-2DRBs (Preamble, Table 8.1.5.4.1.3.3-1)

Derivation Path: TS 38.508-1 [4], table 4.6.3-19 and condition SRB2_DRB1			
Information Element	Value/remark	Comment	Condition
CellGroupConfig ::= SEQUENCE {			
rlc-BearerToAddModList SEQUENCE (SIZE(1..maxLC-ID)) OF RLC-BearerConfig {	3 entries		
RLC-BearerConfig[1]	RLC-BearerConfig with condition SRB2	entry 1	
RLC-BearerConfig[2]	RLC-BearerConfig with conditions AM and DRB1	entry 2	
RLC-BearerConfig[3]	RLC-BearerConfig with conditions AM and DRB2	entry 3	
}			
}			

Table 8.1.5.4.1.3.3-4: PDU SESSION ESTABLISHMENT ACCEPT (Preamble) (Table 8.1.5.4.1.3.2-1)

Derivation Path: TS 38.508-1, table 4.7.2-2			
Information Element	Value/remark	Comment	Condition
PDU session ID	The same as the PDU session ID in PDU SESSION ESTABLISHMENT REQUEST		
Authorized QoS rules	3 entries		
QoS rule [1]	Reference QoS rule #1 as defined in Table 4.8.2.1-1.	QFI=1	
QoS rule [2]	Reference QoS rule #4 as defined in Table 4.8.2.1-4 except DQR bit set to '0'B.	QFI=2	
QoS rule [3]	Reference QoS rule #5 as defined in Table 4.8.2.1-5.	QFI=5	
Authorized QoS flow descriptions	3 entries		
QoS flow [1]	Reference QoS flow #1 as defined in Table 4.8.2.3-1.	QFI=1	
QoS flow [2]	Reference QoS flow #2 as defined in Table 4.8.2.3-2.	QFI=2	
QoS flow [3]	Reference QoS flow #3 as defined in Table 4.8.2.3-3.	QFI=5	

Table 8.1.5.4.1.3.3-5: CounterCheck (step 3, Table 8.1.5.4.1.3.2-1)

Derivation path: 38.508-1 [4] table 4.6.1-1			
Information Element	Value/Remark	Comment	Condition
CounterCheck ::= SEQUENCE {			
criticalExtensions CHOICE {			
counterCheck SEQUENCE {			
drb-CountMSB-InfoList SEQUENCE (SIZE (1..maxDRB)) OF DRB-CountMSB-Info {	2 entries		
DRB-CountMSB-Info[1] SEQUENCE {		entry 1	
drb-Identity	DRB-Identity with Condition DRB1	DRB established	
countMSB-Uplink	1		
countMSB-Downlink	1		
}			
DRB-CountMSB-Info[2] SEQUENCE {		entry 2	
drb-Identity	DRB-Identity with Condition DRB3	DRB not established	
countMSB-Uplink	3		
countMSB-Downlink	3		
}			
}			
}			
}			

Table 8.1.5.4.1.3.3-6: CounterCheckResponse (step 4, Table 8.1.5.4.1.3.2-1)

Derivation path: 38.508-1 [4] table 4.6.1-2			
Information Element	Value/Remark	Comment	Condition
CounterCheckResponse ::= SEQUENCE {			
criticalExtensions CHOICE {			
counterCheckResponse SEQUENCE {			
drb-CountInfoList SEQUENCE (SIZE (0..maxDRB)) OF DRB-CountInfo {	3 entries		
DRB-CountInfo[1] SEQUENCE {		entry 1	
drb-Identity	DRB-Identity with Condition DRB1	DRB established	
count-Uplink	9		
count-Downlink	9		
}			
DRB-CountInfo[2] SEQUENCE {		entry 2	
drb-Identity	DRB-Identity with Condition DRB2	DRB established but not requested	
count-Uplink	9		
count-Downlink	9		
}			
DRB-CountInfo[3] SEQUENCE {		entry 3	
drb-Identity	DRB-Identity with Condition DRB3	DRB not established	
count-Uplink	384	MSB 3 and LSB 0	
count-Downlink	384	MSB 3 and LSB 0	
}			
}			
}			
}			
}			

8.1.5.5 Redirection to NR

8.1.5.5.1 Redirection to NR / From E-UTRA / Success

8.1.5.5.1.1 Test Purpose (TP)

(1)

```
with { UE in E-UTRA RRC_CONNECTED state }
ensure that {
  when { UE receives an RRCConnectionRelease message including a redirectedCarrierInfo for
redirection to an NR cell }
  then { UE enters E-UTRA RRC_IDLE state and performs redirection to NR cell }
}
```

8.1.5.5.1.2 Conformance requirements

References: The conformance requirements covered in the current TC is specified in: TS 36.331 clause 5.3.8.3. Unless otherwise stated these are Rel-15 requirements.

[TS 36.331, clause 5.3.8.3]

The UE shall:

- 1> except for NB-IoT, BL UEs or UEs in CE, delay the following actions defined in this sub-clause 60 ms from the moment the *RRCCConnectionRelease* message was received or optionally when lower layers indicate that the receipt of the *RRCCConnectionRelease* message has been successfully acknowledged, whichever is earlier;
- 1> for BL UEs or UEs in CE, delay the following actions defined in this sub-clause 1.25 seconds from the moment the *RRCCConnectionRelease* message was received or optionally when lower layers indicate that the receipt of the *RRCCConnectionRelease* message has been successfully acknowledged, whichever is earlier;

1> for NB-IoT, delay the following actions defined in this sub-clause 10 seconds from the moment the *RRCCConnectionRelease* message was received or optionally when lower layers indicate that the receipt of the *RRCCConnectionRelease* message has been successfully acknowledged, whichever is earlier.

NOTE: For BL UEs, UEs in CE and NB-IoT, when STATUS reporting, as defined in TS 36.322 [7], has not been triggered and the UE has sent positive HARQ feedback (ACK), as defined in TS 36.321 [6], the lower layers can be considered to have indicated that the receipt of the *RRCCConnectionRelease* message has been successfully acknowledged.

1> stop T380, if running;

1> if T309 is running:

2> stop timer T309 for all access categories;

2> perform the actions as specified in 5.3.16.4.

1> if the *RRCCConnectionRelease* message is received in response to an *RRCCConnectionResumeRequest* for EDT:

2> indicate to upper layers that the suspended RRC connection has been resumed;

2> discard the stored UE AS context and *resumeIdentity*;

2> stop timer T300;

2> stop timer T302, if running;

2> stop timer T303, if running;

2> stop timer T305, if running;

2> stop timer T306, if running;

2> stop timer T308, if running;

2> perform the actions as specified in 5.3.3.7;

2> stop timer T320, if running;

2> stop timer T322, if running;

1> if the security is not activated and if UE is connected to 5GC:

2> perform the actions upon leaving RRC_CONNECTED or RRC_INACTIVE as specified in 5.3.12 with the release cause 'other' upon which the procedure ends;

1> if the *RRCCConnectionRelease* message includes *redirectedCarrierInfo* indicating redirection to *geran*; or

1> if the *RRCCConnectionRelease* message includes *idleModeMobilityControlInfo* including *freqPriorityListGERAN*:

2> if AS security has not been activated; and

2> if upper layers indicate that redirect to GERAN without AS security is not allowed:

3> ignore the content of the *RRCCConnectionRelease*;

3> perform the actions upon leaving RRC_CONNECTED or RRC_INACTIVE as specified in 5.3.12, with release cause 'other', upon which the procedure ends;

1> if AS security has not been activated:

2> ignore the content of *redirectedCarrierInfo*, if included and indicating redirection to *nr*;

2> ignore the content of *idleModeMobilityControlInfo*, if included and including *freqPriorityListNR*;

2> if the UE ignores the content of *redirectedCarrierInfo* or of *idleModeMobilityControlInfo*:

3> perform the actions upon leaving RRC_CONNECTED as specified in 5.3.12, with release cause 'other', upon which the procedure ends;

1> if the *RRCCConnectionRelease* message includes *redirectedCarrierInfo* indicating redirection to *eutra* and if UE is connected to 5GC:

2> if *cn-Type* is included:

3> after the cell selection, indicate the available CN Type(s) and the received *cn-Type* to upper layers;

NOTE 1: Handling the case if the E-UTRA cell selected after the redirection does not support the core network type specified by the *cn-Type*, is up to UE implementation.

1> if the *RRCCConnectionRelease* message includes the *idleModeMobilityControlInfo*:

2> store the cell reselection priority information provided by the *idleModeMobilityControlInfo*;

2> if the *t320* is included:

3> start timer T320, with the timer value set according to the value of *t320*;

1> else:

2> apply the cell reselection priority information broadcast in the system information;

1> if the *RRCCConnectionRelease* message includes the *measIdleConfig*:

2> clear *VarMeasIdleConfig* and *VarMeasIdleReport*;

2> store the received *measIdleDuration* in *VarMeasIdleConfig*;

2> start T331 with the value of *measIdleDuration*;

2> if the *measIdleConfig* contains *measIdleCarrierListEUTRA*:

3> store the received *measIdleCarrierListEUTRA* in *VarMeasIdleConfig*;

3> start performing idle mode measurements as specified in 5.6.20;

NOTE 2: If the *measIdleConfig* does not contain *measIdleCarrierListEUTRA*, UE may receive *measIdleCarrierListEUTRA* as specified in 5.2.2.12.

1> for NB-IoT, if the *RRCCConnectionRelease* message includes the *redirectedCarrierInfo*:

2> if the *redirectedCarrierOffsetDedicated* is included in the *redirectedCarrierInfo*:

3> store the dedicated offset for the frequency in *redirectedCarrierInfo*;

3> start timer T322, with the timer value set according to the value of *T322* in *redirectedCarrierInfo*;

1> if the *releaseCause* received in the *RRCCConnectionRelease* message indicates *loadBalancingTAURequired*:

2> perform the actions upon leaving RRC_CONNECTED as specified in 5.3.12, with release cause 'load balancing TAU required';

1> else if the *releaseCause* received in the *RRCCConnectionRelease* message indicates *cs-FallbackHighPriority*:

2> perform the actions upon leaving RRC_CONNECTED as specified in 5.3.12, with release cause 'CS Fallback High Priority';

1> else:

2> if the *waitTime* is present:

3> start timer T302, with the timer value set according to the *waitTime*;

3> inform the upper layer that access barring is applicable for all access categories except categories '0' and '2';

- 2> if the *extendedWaitTime* is present; and
- 2> if the UE supports delay tolerant access or the UE is a NB-IoT UE:
 - 3> forward the *extendedWaitTime* to upper layers;
- 2> if the *extendedWaitTime-CPdata* is present and the NB-IoT UE only supports the Control Plane CIoT EPS optimisation:
 - 3> forward the *extendedWaitTime-CPdata* to upper layers;
- 2> if the *releaseCause* received in the *RRCCONNECTIONRELEASE* message indicates *rrc-Suspend*:
 - 3> perform the actions upon leaving RRC_CONNECTED as specified in 5.3.12, with release cause 'RRC suspension';
- 2> else if *rrc-InactiveConfig* is included:
 - 3> perform the actions upon entering RRC_INACTIVE as specified in 5.3.8.7;
- 2> else:
 - 3> perform the actions upon leaving RRC_CONNECTED or RRC_INACTIVE as specified in 5.3.12, with release cause 'other';

8.1.5.5.1.3 Test Description

8.1.5.5.1.3.1 Pre-test conditions

System Simulator:

- E-UTRA Cell 1 is the serving cell and NR Cell 1 is the suitable neighbour cell.
- System information combination 31 as defined in TS 36.508 [7] clause 4.4.3.1 is used in the E-UTRA cell.
- System information combination NR-6 as defined in TS 38.508-1 [4] clause 4.4.3.1.2 is used in the NR cell.

UE:

- E-UTRA RRC_CONNECTED state.

Preamble:

- With NR Cell 1 "Serving cell" and E-UTRA Cell 1 "Non-suitable "Off" cell", the UE is brought to state 1N-A, RRC_IDLE Connectivity (NR), in accordance with the procedure described in TS 38.508-1 [4], Table 4.5.2.2-2. 5G-GUTI and ngKSI are assigned and security context established.
- the UE is switched-off
- With E-UTRA Cell 1 and NR Cell 1 power levels set according to T0, the UE is brought to state Generic RB Established (state 3) according to TS 36.508 [7] clause 4.5.3. 4G GUTI and eKSI are assigned and security context established

8.1.5.5.1.3.2 Test procedure sequence

Tables 8.1.5.5.1.3.2-0/ 8.1.5.5.1.3.2-0A illustrates the downlink power levels to be applied for NR Cell 1, E-UTRA Cell 1 for the test execution.

Table 8.1.5.5.1.3.2-0: Time instances of cell power level and parameter changes for FR1

	Parameter	Unit	NR Cell 1	E-UTRA Cell 1	Remark
T0	Cell-specific RS EPRE	dBm/15 kHz		-85	The power levels are such that reselection to NR Cell 1 does not happen.
	SS/PBCH SSS EPRE	dBm/S CS	-91	-	

Table 8.1.5.5.1.3.2-0A: Time instances of cell power level and parameter changes for FR2

	Parameter	Unit	NR Cell 1	E-UTRA Cell 1	Remark
T0	Cell-specific RS EPRE	dBm/15 kHz		-85	The power levels are such that reselection to NR Cell 1 does not happen.
	SS/PBCH SSS EPRE	dBm/S CS	-94	-	

Table 8.1.5.5.1.3.2-1: Main behaviour

St	Procedure	Message Sequence		TP	Verdict
		U - S	Message		
1	The SS transmits an <i>RRCConectionRelease</i> message indicating redirection to NR Cell 1.	-	E-UTRA RRC: <i>RRCConectionRelease</i>	-	-
2-14a1	Check: Does the test result of generic test procedure in TS 38.508-1 subclause 4.9.9 indicate that the UE has performed mobility registration updating when it camps on NR Cell 1?	-	-	1	P

8.1.5.5.1.3.3 Specific message contents

Table 8.1.5.5.1.3.3-1: RRCConectionRelease (step 1, Table 8.1.5.5.1.3.2-1)

Derivation Path: 36.508 table 4.6.1-15			
Information Element	Value/remark	Comment	Condition
RRCConectionRelease ::= SEQUENCE {			
criticalExtensions CHOICE {			
c1 CHOICE {			
rrcCoNECTIONRelease-r8 SEQUENCE {			
redirectedCarrierInfo CHOICE {			
nr-r15 SEQUENCE {			
carrierFreq-r15	ARFCN of NR Cell 1		
}			
}			
}			
}			
}			
}			

8.1.5.6 Radio link failure

8.1.5.6.1 Radio link failure / RRC connection re-establishment success

8.1.5.6.1.1 Test Purpose (TP)

(1)

```
with { UE in NR RRC_CONNECTED state }
ensure that {
  when { UE detecting physical layer recovery while T310 was running }
  then { UE resumes the RRC connection without explicit signalling }
}
```

(2)

```
with { UE in NR RRC_CONNECTED state }
ensure that {
  when { UE detecting physical layer problems }
  then { UE shall start timer T310 and UE does not initiate any RRC connection re-establishment
procedure before expiring of timer T310 }
}
```

(3)

```
with { UE in NR RRC_CONNECTED state }
ensure that {
  when { UE detecting radio link failure on expiring of timer T310 }
  then { UE starts timer T311 and UE initiates the RRC connection re-establishment procedure }
}
```

(4)

```
with { UE having initiated RRC connection re-establishment procedure and timer T311 running }
ensure that {
  when { UE successfully completes the RRC connection re-establishment procedure }
  then { UE is in NR RRC_CONNECTED state }
}
```

(5)

```
with { UE in NR RRC_CONNECTED state and upon detecting radio link failure UE sends
RRCReestablishmentRequest message }
ensure that {
  when { UE receives a RRCSetup message }
  then { UE completes RRC setup procedure by sending RRCSetupComplete message }
}
```

8.1.5.6.1.2 Conformance requirements

References: The conformance requirements covered in the current TC are specified in: TS 38.331 clauses 5.3.3.4, 5.3.7.2, 5.3.7.8, 5.3.10.1, 5.3.10.2 and 5.3.10.3.

[TS 38.331 clause 5.3.3.4]

The UE shall perform the following actions upon reception of the *RRCSetup*:

- 1> if the *RRCSetup* is received in response to an *RRCReestablishmentRequest*; or
- 1> if the *RRCSetup* is received in response to an *RRCResumeRequest* or *RRCResumeRequest1*:
 - 2> discard any stored UE Inactive AS context and *suspendConfig*;
 - 2> discard any current AS security context including the $K_{RRCCenc}$ key, the K_{RRCint} key, the K_{UPint} key and the K_{UPenc} key;
 - 2> release radio resources for all established RBs except SRB0, including release of the RLC entities, of the associated PDCP entities and of SDAP;

- 2> release the RRC configuration except for the default L1 parameter values, default MAC Cell Group configuration and CCCH configuration;
- 2> indicate to upper layers fallback of the RRC connection;
- 2> stop timer T380, if running;
- 1> perform the cell group configuration procedure in accordance with the received *masterCellGroup* and as specified in 5.3.5.5;
- 1> perform the radio bearer configuration procedure in accordance with the received *radioBearerConfig* and as specified in 5.3.5.6;
- 1> if stored, discard the cell reselection priority information provided by the *cellReselectionPriorities* or inherited from another RAT;
- 1> stop timer T300, T301 or T319 if running;
- 1> if T390 is running:
 - 2> stop timer T390 for all access categories;
 - 2> perform the actions as specified in 5.3.14.4;
- 1> if T302 is running:
 - 2> stop timer T302;
 - 2> perform the actions as specified in 5.3.14.4;
- 1> stop timer T320, if running;
- 1> if the *RRCSetup* is received in response to an *RRCResumeRequest*, *RRCResumeRequest1* or *RRCSetupRequest*:
 - 2> enter RRC_CONNECTED;
 - 2> stop the cell re-selection procedure;
- 1> consider the current cell to be the PCell;
- 1> set the content of *RRCSetupComplete* message as follows:
 - 2> if upper layers provide a 5G-S-TMSI:
 - 3> if the *RRCSetup* is received in response to an *RRCSetupRequest*:
 - 4> set the *ng-5G-S-TMSI-Value* to *ng-5G-S-TMSI-Part2*;
 - 3> else:
 - 4> set the *ng-5G-S-TMSI-Value* to *ng-5G-S-TMSI*;
 - 2> set the *selectedPLMN-Identity* to the PLMN selected by upper layers (TS 24.501 [23]) from the PLMN(s) included in the *plmn-IdentityList* in *SIB1*;
 - 2> if upper layers provide the 'Registered AMF':
 - 3> include and set the *registeredAMF* as follows:
 - 4> if the PLMN identity of the 'Registered AMF' is different from the PLMN selected by the upper layers:
 - 5> include the *plmnIdentity* in the *registeredAMF* and set it to the value of the PLMN identity in the 'Registered AMF' received from upper layers;
 - 4> set the *amf-Identifier* to the value received from upper layers;
 - 3> include and set the *guami-Type* to the value provided by the upper layers;

2> if upper layers provide one or more S-NSSAI (see TS 23.003 [21]):

3> include the *s-NSSAI-List* and set the content to the values provided by the upper layers;

2> set the *dedicatedNAS-Message* to include the information received from upper layers;

1> submit the *RRCSetupComplete* message to lower layers for transmission, upon which the procedure ends

[TS 38.331 clause 5.3.7.2]

The UE initiates the procedure when one of the following conditions is met:

1> upon detecting radio link failure of the MCG, in accordance with 5.3.10; or

1> upon re-configuration with sync failure of the MCG, in accordance with sub-clause 5.3.5.8.3; or

1> upon mobility from NR failure, in accordance with sub-clause 5.4.3.5; or

1> upon integrity check failure indication from lower layers concerning SRB1 or SRB2, except if the integrity check failure is detected on the *RRCReestablishment* message; or

1> upon an RRC connection reconfiguration failure, in accordance with sub-clause 5.3.5.8.2.

Upon initiation of the procedure, the UE shall:

1> stop timer T310, if running;

1> stop timer T304, if running;

1> start timer T311;

1> suspend all RBs, except SRB0;

1> reset MAC;

1> release the MCG SCell(s), if configured;

1> release *spCellConfig*;

1> release *delayBudgetReportingConfig*, if configured, and stop timer T342, if running;

1> release *overheatingAssistanceConfig*, if configured, and stop timer T345, if running;

1> perform cell selection in accordance with the cell selection process as specified in TS 38.304 [20], clause 5.2.6.

[TS 38.331 clause 5.3.7.8]

The UE shall:

1> perform the RRC connection establishment procedure as specified in 5.3.3.4.

[TS 38.331 clause 5.3.10.1]

The UE shall:

1> upon receiving N310 consecutive "out-of-sync" indications for the SpCell from lower layers while neither T300, T301, T304, T311 nor T319 are running:

2> start timer T310 for the corresponding SpCell.

[TS 38.331 clause 5.3.10.2]

Upon receiving N311 consecutive "in-sync" indications for the SpCell from lower layers while T310 is running, the UE shall:

1> stop timer T310 for the corresponding SpCell.

NOTE 1: In this case, the UE maintains the RRC connection without explicit signalling, i.e. the UE maintains the entire radio resource configuration.

NOTE 2: Periods in time where neither "in-sync" nor "out-of-sync" is reported by L1 do not affect the evaluation of the number of consecutive "in-sync" or "out-of-sync" indications.

[TS 38.331 clause 5.3.10.3]

The UE shall:

- 1> upon T310 expiry in PCell; or
- 1> upon random access problem indication from MCG MAC while neither T300, T301, T304, T311 nor T319 are running; or
- 1> upon indication from MCG RLC that the maximum number of retransmissions has been reached:
 - 2> if the indication is from MCG RLC and CA duplication is configured and activated, and for the corresponding logical channel *allowedServingCells* only includes SCell(s):
 - 3> initiate the failure information procedure as specified in 5.7.5 to report RLC failure.
 - 2> else:
 - 3> consider radio link failure to be detected for the MCG i.e. RLF;
 - 3> if AS security has not been activated:
 - 4> perform the actions upon going to RRC_IDLE as specified in 5.3.11, with release cause 'other';-
 - 3> else if AS security has been activated but SRB2 and at least one DRB have not been setup:
 - 4> perform the actions upon going to RRC_IDLE as specified in 5.3.11, with release cause 'RRC connection failure';
 - 3> else:
 - 4> initiate the connection re-establishment procedure as specified in 5.3.7.

8.1.5.6.1.3 Test description

8.1.5.6.1.3.1 Pre-test conditions

System Simulator:

- 3 NR Cells. NR Cell 1 is the serving cell, NR Cell 2 and NR Cell 4 are the intra-frequency neighbour cell.

None.

Preamble:

- The UE is in state 3N-A as defined in TS 38.508-1 [4], subclause 4.4A on NR Cell 1.

8.1.5.6.1.3.2 Test procedure sequence

Table 8.1.5.6.1.3.2-1: Time instances of cell power level and parameter changes for FR1

	Parameter	Unit	NR Cell 1	NR Cell 2	NR Cell 4
T0	SS/PBCH SSS EPRE	dBm/SCS	"Off"	"Off"	"Off"
T0 A	SS/PBCH SSS EPRE	dBm/SCS	-88	"Off"	"Off"
T1	SS/PBCH SSS EPRE	dBm/SCS	"Off"	-88	-94
T2	SS/PBCH SSS EPRE	dBm/SCS	"Off"	"Off"	-88
Power level "Off" is defined in TS 38.508-1 [4] Table 6.2.2.1-3.					

Table 8.1.5.6.1.3.2-2: Time instances of cell power level and parameter changes for FR2

	Parameter	Unit	NR Cell 1	NR Cell 2	NR Cell 4
T0	SS/PBCH SSS EPRE	dBm/SCS	"Off"	"Off"	"Off"
T0 A	SS/PBCH SSS EPRE	dBm/SCS	-82	"Off"	"Off"
T1	SS/PBCH SSS EPRE	dBm/SCS	"Off"	-82	-91
T2	SS/PBCH SSS EPRE	dBm/SCS	"Off"	"Off"	-82
Power level "Off" is defined in TS 38.508-1 [4] Table 6.2.2.2-2.					

Table 8.1.5.6.1.3.2-3: Main behaviour

St	Procedure	Message Sequence		TP	Verdict
		U - S	Message		
0A	The SS changes NR Cell 1 parameters according to the row "T0" in table Table 8.1.5.6.1.3.2-1/2 to set NR Cell 1 to Non-suitable "Off"	-	-	-	-
0B	The SS wait for 1,5 s (T310 (2s) is transmitted in SIB1).	-	-	-	-
0C	The SS changes NR Cell 1 parameters according to the row "T0A" in table 8.1.5.6.1.3.2-1/2 making NR Cell 1 serving cell.	-	-	-	-
0D	Check: For the next 5 s does the UE transmit any signalling message?	-	-	1	F
0E	Check: Does the test result of generic test procedure in TS 38.508-1 [4] subclause 4.9.10 indicate that the UE is in NR RRC_CONNECTED state on NR Cell 1?	-	-	1	P
1	The SS changes NR Cell 1, NR Cell 2 and NR Cell 4 parameters according to the row "T1" in table 8.1.5.6.1.3.2-1/2 in order that the radio link quality of NR Cell 1 is degraded, and NR Cell 2 is suitable for camping.	-	-	-	-
2	Check: Does the UE initiate an RRC connection re-establishment procedure on Cell 1 or Cell 2. This is checked during the time T=T310?	-	-	2	F
3	Check: Does the UE send <i>RRCReestablishmentRequest</i> message on NR Cell 2?	-->	NR RRC: <i>RRCReestablishmentRequest</i>	3	P
4	The SS transmits <i>RRCReestablishmentmessage</i> .	<--	NR RRC: <i>RRCReestablishment</i>	-	-
5	The UE transmits <i>RRCReestablishmentCompletemessage</i> .	-->	NR RRC: <i>RRCReestablishmentComplete</i>	-	-
6	The SS transmits an <i>RRCReconfigurationmessage</i> to resume existing radio bearer.	<--	NR RRC: <i>RRCReconfiguration</i>	-	-
7	Check: Does the UE transmit an <i>RRCConnectionReconfigurationComplete</i> message?	-->	NR RRC: <i>RRCReconfigurationComplete</i>	4	P
8	The SS changes NR Cell 2 and NR Cell 4 parameters according to the row "T2" in table 8.1.5.6.1.3.2-1/2 in order that the radio link quality of NR Cell 2 is degraded and cell 4 is suitable for camping.	-	-	-	-
9	Check: Does the UE send <i>RRCReestablishmentRequest</i> message on NR Cell 4?	-->	NR RRC: <i>RRCReestablishmentRequest</i>	-	-
10	The SS transmits <i>RRCSetupmessage</i> .	<--	NR RRC: <i>RRCSetup</i>	-	-
11	Check: Does the UE transmit a <i>RRCSetupComplete</i> message and a REGISTRATION REQUEST message indicating "mobility registration updating"?	-->	NR RRC: <i>RRCSetupComplete</i> 5GMM: REGISTRATION REQUEST	5	P
11A	The SS transmits a <i>DLInformationTransfer</i> message and an AUTHENTICATION REQUEST message.	<--	RRC: <i>DLInformationTransfer</i> NAS: AUTHENTICATION REQUEST	-	-
11B	The UE transmits an <i>ULInformationTransfer</i> message and an AUTHENTICATION RESPONSE message.	-->	RRC: <i>ULInformationTransfer</i> NAS: AUTHENTICATION RESPONSE	-	-
11C	The SS transmits a NAS SECURITY MODE COMMAND message to activate NAS security.	<--	RRC: <i>DLInformationTransfer</i> NAS: SECURITY MODE COMMAND	-	-
11D	The UE transmits a NAS SECURITY MODE COMPLETE message and establishes the	-->	RRC: <i>ULInformationTransfer</i> NAS: SECURITY MODE	-	-

	initial security configuration.		COMPLETE		
12	The SS transmits a <i>SecurityModeCommand</i> message.	<--	NR RRC: <i>SecurityModeCommand</i>	-	-
13	The UE transmits a <i>SecurityModeComplete</i> message.	-->	NR RRC: <i>SecurityModeComplete</i>	-	-
14	The SS transmits an <i>RRCReconfiguration</i> message to establish SRB2 and DRB and a REGISTRATION ACCEPT message.	<--	NR RRC: <i>RRCReconfiguration</i> 5GMM: REGISTRATION ACCEPT	-	-
15	The UE transmits an <i>RRCReconfigurationComplete</i> message.	-->	NR RRC: <i>RRCReconfigurationComplete</i>	-	-
16	The UE send a REGISTRATION COMPLETE	-->	NR RRC: <i>ULInformationTransfer</i> 5GMM: REGISTRATION COMPLETE	-	-

8.1.5.6.1.3.3 Specific message contents

Table 8.1.5.6.1.3.3-0: *SIB1* for Cell 1 (all steps)

Derivation path: 38.508-1 [4] table 4.6.1-28			
Information Element	Value/Remark	Comment	Condition
SIB1 ::= SEQUENCE {			
ue-TimersAndConstants SEQUENCE {			
t310	ms2000		
}			
}			

Table 8.1.5.6.1.3.3-0A: *RLF-TimersAndConstants*(preamble)

Derivation Path: 38.508-1 [4] Table 4.6.1-150			
Information Element	Value/remark	Comment	Condition
RLF-TimersAndConstants ::= SEQUENCE {			
t310	ms2000		
}			

Table 8.1.5.6.1.3.3-1: *RRCReestablishmentRequest* (step 3, Table 8.1.5.6.1.3.2-3)

Derivation path: 38.508-1 [4] table 4.6.1-12			
Information Element	Value/remark	Comment	Condition
RRCReestablishmentRequest ::= SEQUENCE {			
ue-Identity SEQUENCE {			
c-RNTI	the value of the C-RNTI of the UE		
physCellId	PhysicalCellId of NR Cell 1		
shortMAC-I	The same value as the 16 least significant bits of the XMAC-I value calculated by SS		
}			
reestablishmentCause	otherFailure		
}			

Table 8.1.5.6.1.3.3-1A: *RRCReconfiguration* (step 6, Table 8.1.5.6.1.3.2-3)

Derivation Path: TS 38.508-1[4], table 4.6.1-13 with condition REEST
--

Table 8.1.5.6.1.3.3-2: RRCReestablishmentRequest (step 9, Table 8.1.5.6.1.3.2-3)

Derivation path: 38.508-1 [4] table 4.6.1-12			
Information Element	Value/remark	Comment	Condition
RRCReestablishmentRequest ::= SEQUENCE {			
ue-Identity SEQUENCE {			
c-RNTI	the value of the C-RNTI of the UE		
physCellId	PhysicalCellIdentity of NR Cell 2		
shortMAC-I	The same value as the 16 least significant bits of the XMAC-I value calculated by SS		
}			
reestablishmentCause	otherFailure		
}			

Table 8.1.5.6.1.3.3-3: RRCReconfiguration (step 14, Table 8.1.5.6.1.3.2-3)

Derivation Path: TS 38.508-1[4], table 4.6.1-13 with condition NR

8.1.5.6.2 Void

8.1.5.6.3 Radio link failure / T311 expiry

8.1.5.6.3.1 Test Purpose (TP)

(1)

```
with { UE in NR RRC_CONNECTED state and radio link failure was detected and UE attempts to select a
suitable NR cell to re-establish the RRC connection }
ensure that {
  when { UE cannot find a suitable NR cell within T311 }
  then { UE does not try to re-establish the RRC connection and goes to NR RRC_IDLE state after
T311 expired }
}
```

8.1.5.6.3.2 Conformance requirements

References: The conformance requirements covered in the current TC are specified in: TS 38.331 clauses 5.3.7.2, 5.3.7.6, 5.3.7.8, 5.3.10.1, 5.3.10.3 and 5.3.5.5.7.

[TS 38.331 clause 5.3.7.2]

The UE initiates the procedure when one of the following conditions is met:

- 1> upon detecting radio link failure of the MCG, in accordance with 5.3.10; or
- 1> upon re-configuration with sync failure of the MCG, in accordance with sub-clause 5.3.5.8.3; or
- 1> upon mobility from NR failure, in accordance with sub-clause 5.4.3.5; or
- 1> upon integrity check failure indication from lower layers concerning SRB1 or SRB2, except if the integrity check failure is detected on the *RRCReestablishment* message; or
- 1> upon an RRC connection reconfiguration failure, in accordance with sub-clause 5.3.5.8.2.

Upon initiation of the procedure, the UE shall:

- 1> stop timer T310, if running;

- 1> stop timer T304, if running;
- 1> start timer T311;
- 1> suspend all RBs, except SRB0;
- 1> reset MAC;
- 1> release the MCG SCell(s), if configured;
- 1> release *spCellConfig*;
- 1> release *delayBudgetReportingConfig*, if configured, and stop timer T342, if running;
- 1> release *overheatingAssistanceConfig*, if configured, and stop timer T345, if running;
- 1> perform cell selection in accordance with the cell selection process as specified in TS 38.304 [20], clause 5.2.6.

[TS 38.331 clause 5.3.7.7]

Upon T311 expiry, the UE shall:

- 1> perform the actions upon going to RRC_IDLE as specified in 5.3.11, with release cause 'RRC connection failure'.

[TS 38.331 clause 5.3.7.8]

The UE shall:

- 1> perform the RRC connection establishment procedure as specified in 5.3.3.4.

[TS 38.331 clause 5.3.10.1]

The UE shall:

- 1> upon receiving N310 consecutive "out-of-sync" indications for the SpCell from lower layers while neither T300, T301, T304, T311 nor T319 are running:
 - 2> start timer T310 for the corresponding SpCell.

[TS 38.331 clause 5.3.10.3]

The UE shall:

- 1> upon T310 expiry in PCell; or
- 1> upon random access problem indication from MCG MAC while neither T300, T301, T304, T311 nor T319 are running; or
- 1> upon indication from MCG RLC that the maximum number of retransmissions has been reached:
 - 2> if the indication is from MCG RLC and CA duplication is configured and activated, and for the corresponding logical channel *allowedServingCells* only includes SCell(s):
 - 3> initiate the failure information procedure as specified in 5.7.5 to report RLC failure.
 - 2> else:
 - 3> consider radio link failure to be detected for the MCG i.e. RLF;
 - 3> if AS security has not been activated:
 - 4> perform the actions upon going to RRC_IDLE as specified in 5.3.11, with release cause 'other';-
 - 3> else if AS security has been activated but SRB2 and at least one DRB have not been setup:
 - 4> perform the actions upon going to RRC_IDLE as specified in 5.3.11, with release cause 'RRC connection failure';

3> else:

4> initiate the connection re-establishment procedure as specified in 5.3.7.

[TS 38.331, 5.3.5.5.7]

The UE shall:

1> if the *SpCellConfig* contains the *rlf-TimersAndConstants*:

2> configure the RLF timers and constants for this cell group as specified in 5.3.5.5.6;

1> else if *rlf-TimersAndConstants* is not configured for this cell group:

2> use values for timers T301, T310, T311 and constants N310, N311, as included in *ue-TimersAndConstants* received in *SIB1*;

8.1.5.6.3.3 Test description

8.1.5.6.3.3.1 Pre-test conditions

System Simulator:

- NR Cell 1

None.

Preamble:

- The UE is in state 3N-A as defined in TS 38.508-1 [4], subclause 4.4A on NR Cell 1.

8.1.5.6.3.3.2 Test procedure sequence

Table 8.1.5.6.3.3.2-1: Time instances of cell power level and parameter changes for FR1

	Parameter	Unit	NR Cell 1
T1	SS/PBCH SSS EPRE	dBm/SCS	"Off"
T2	SS/PBCH SSS EPRE	dBm/SCS	-88
Power level "Off" is defined in TS 38.508-1 [4] Table 6.2.2.1-3.			

Table 8.1.5.6.3.3.2-2: Time instances of cell power level and parameter changes for FR2

	Parameter	Unit	NR Cell 1
T1	SS/PBCH SSS EPRE	dBm/SCS	"Off"
T2	SS/PBCH SSS EPRE	dBm/SCS	-82
Power level "Off" is defined in TS 38.508-1 [4] Table 6.2.2.2-2.			

Table 8.1.5.6.3.3.2-3: Main behaviour

St	Procedure	Message Sequence		TP	Verdict
		U - S	Message		
1	The SS changes NR Cell 1 parameters according to the row "T1" in table 8.1.5.6.3.3.2-1 in order that the radio link quality of NR Cell 1 is degraded.	-	-	-	-
2	Wait for 12s (T311 (10s) is transmitted in RRCSetup).	-	-	-	-
3	The SS changes NR Cell 1 parameters according to the row "T2" in table 8.1.5.6.3.3.2-1 making NR Cell 1 is suitable for camping.	-	-	-	-
4	Check: Does the test result of generic test procedure in TS 38.508-1 [4] subclause 4.9.5 indicate that the UE is camped on NR Cell 1?	-	-	1	P

8.1.5.6.3.3.3 Specific message contents

Table 8.1.5.6.3.3.3-1: *RRCSetup(Preamble)*

Derivation path: 38.508-1 [4] table 4.6.1-21			
Information Element	Value/remark	Comment	Condition
RRCSetup ::= SEQUENCE {			
criticalExtensions CHOICE {			
rrcSetup SEQUENCE {			
masterCellGroup	CellGroupConfig with condition SRB1	OCTET STRING (CONTAINING CellGroupConfig)	
}			
}			
}			

Table 8.1.5.6.3.3.3-2: *CellGroupConfig* (Table 8.1.5.6.3.3.3-1)

Derivation Path: 38.508-1 [4], Table 4.6.3-19			
Information Element	Value/remark	Comment	Condition
CellGroupConfig ::= SEQUENCE {			
rlf-TimersAndConstants SEQUENCE {			
t311-v1530	ms10000		
}			
spCellConfigDedicated	ServingCellConfig		
}			

Table 8.1.5.6.3.3.3-3: *ServingCellConfig* (Table 8.1.5.6.3.3.3-2: *CellGroupConfig*)

Derivation Path: TS 38.508-1 [4], Table 4.6.3-167			
Information Element	Value/remark	Comment	Condition
ServingCellConfig ::= SEQUENCE {			
initialDownlinkBWP	BWP-DownlinkDedicated		
}			

Table 8.1.5.6.3.3.3-4: *BWP-DownlinkDedicated* (Table 8.1.5.6.3.3.3-3: *ServingCellConfig*)

Derivation Path: TS 38.508-1 [4], Table 4.6.3-11			
Information Element	Value/remark	Comment	Condition
BWP-DownlinkDedicated ::= SEQUENCE {			
radioLinkMonitoringConfig	RadioLinkMonitoringConfig		
}			

8.1.5.6.4 Void

8.1.5.6.5 NR CA / No Radio Link Failure on SCell / RRC Connection Continues on Pcell

8.1.5.6.5.1 NR CA / No Radio Link Failure on SCell / RRC Connection Continues on PCell / Intra-band Contiguous CA

8.1.5.6.5.1.1 Test Purpose (TP)

(1)

```
with { UE in NR RRC_CONNECTED, security activated and SCell configured }
ensure that {
  when { UE drops of out service on SCell }
  then { UE does not consider radio link failure to be detected and stay in NR RRC_CONNECTED state
}
}
```

8.1.5.6.5.1.2 Conformance requirements

References: The conformance requirements covered in the present TC are specified in: TS 38.331, clauses 5.3.5.5.6, 5.3.10.1 and 5.3.10.3.

[TS 38.331, clause 5.3.5.5.6]

The UE shall:

- 1> if the received *rlf-TimersAndConstants* is set to release:
 - 2> if *dapsConfig* is configured for any DRB:
 - 3> use values for target's timers T301, T310, T311 and target's constants N310, N311, as included in *ue-TimersAndConstants* received in *SIB1*;
 - 2> else:
 - 3> use values for timers T301, T310, T311 and constants N310, N311, as included in *ue-TimersAndConstants* received in *SIB1*;
 - 3> consider fast MCG link recovery is not available;
- 1> else:
 - 2> if *dapsConfig* is configured for any DRB:
 - 3> configure the value of target's timers and target's constants in accordance with received *rlf-TimersAndConstants*;
 - 2> else:
 - 3> (re-)configure the value of timers and constants in accordance with received *rlf-TimersAndConstants*;
 - 3> stop timer T310 for this cell group, if running;
 - 3> stop timer T312 for this cell group, if running;
 - 3> reset the counters N310 and N311.
 - 3> if the *t316* is included and set to *setup*:
 - 4> consider fast MCG link recovery is available;
 - 3> else if the *t316* is included and set to *release*:
 - 4> consider fast MCG link recovery is not available.

[TS 38.331, clause 5.3.10.1]

The UE shall:

- 1> if *dapsConfig* is configured for any DRB, upon receiving N310 consecutive "out-of-sync" indications for the source from lower layers while T304 is running:
 - 2> start timer T310 for the source.
- 1> upon receiving N310 consecutive "out-of-sync" indications for the SpCell from lower layers while neither T300, T301, T304, T311 nor T319 are running:
 - 2> start timer T310 for the corresponding SpCell.

Editor's note: TBC on how/whether to capture stop RLM in source after RACH successful to target PCell.

Editor's note: FFS, check whether "source" is suitable for all DAPS related changes, or "source SpCell" should be used in some places, e.g. the timer T310.

[TS 38.331, clause 5.3.10.3]

The UE shall:

- 1> if *dapsConfig* is configured for any DRB:
 - 2> upon T310 expiry in source; or
 - 2> upon random access problem indication from source MCG MAC; or
 - 2> upon indication from source MCG RLC that the maximum number of retransmissions has been reached:
 - 3> consider radio link failure to be detected for the source MCG i.e. source RLF;
 - 4> suspend all DRBs in the source;
 - 4> release the source connection.
- 1> else:
 - 2> upon T310 expiry in PCell; or
 - 2> upon T312 expiry in PCell; or
 - 2> upon random access problem indication from MCG MAC while neither T300, T301, T304, T311 nor T319 are running; or
 - 2> upon indication from MCG RLC that the maximum number of retransmissions has been reached; or
 - 2> if connected as an IAB-node, upon BH RLF indication received on BAP entity from the MCG; or
 - 2> upon indication of consistent uplink LBT failures from MCG MAC:
 - 3> if the indication is from MCG RLC and CA duplication is configured and activated, and for the corresponding logical channel *allowedServingCells* only includes SCell(s):
 - 4> initiate the failure information procedure as specified in 5.7.5 to report RLC failure.
 - 3> else:
 - 4> consider radio link failure to be detected for the MCG i.e. RLF;
 - ...
 - 4> if AS security has not been activated:
 - 5> perform the actions upon going to RRC_IDLE as specified in 5.3.11, with release cause 'other';-
 - 4> else if AS security has been activated but SRB2 and at least one DRB have not been setup:

5> perform the actions upon going to RRC_IDLE as specified in 5.3.11, with release cause 'RRC connection failure';

Editor's note: FFS if the check for SRB2 activation and the setup of one DRB is applicable to IAB nodes.

4> else:

5> if T316 is configured; and

5> if SCG transmission is not suspended; and

5> if PSCell change is not ongoing (i.e. timer T304 for the NR PSCell is not running in case of NR-DC or timer T307 of the E-UTRA PSCell is not running as specified in TS 36.331 [10], clause 5.3.10.10, in NE-DC):

6> initiate the MCG failure information procedure as specified in 5.7.3b to report MCG radio link failure.

5> else:

6> initiate the connection re-establishment procedure as specified in 5.3.7.

The UE may discard the radio link failure information, i.e. release the UE variable *VarRLF-Report*, 48 hours after the radio link failure is detected.

The UE shall:

1> upon T310 expiry in PSCell; or

1> upon T312 expiry in PSCell; or

1> upon random access problem indication from SCG MAC; or

1> upon indication from SCG RLC that the maximum number of retransmissions has been reached; or

1> if connected as an IAB-node, upon BH RLF failure indication received on BAP entity from the SCG;

1> upon indication of consistent uplink LBT failures from SCG MAC:

2> if the indication is from SCG RLC and CA duplication is configured and activated; and for the corresponding logical channel *allowedServingCells* only includes SCell(s):

3> initiate the failure information procedure as specified in 5.7.5 to report RLC failure.

2> else if MCG transmission is not suspended:

3> consider radio link failure to be detected for the SCG, i.e. SCG RLF;

3> initiate the SCG failure information procedure as specified in 5.7.3 to report SCG radio link failure.

2> else:

3> if the UE is in NR-DC:

4> initiate the connection re-establishment procedure as specified in 5.3.7;

3> else (the UE is in (NG)EN-DC):

4> initiate the connection re-establishment procedure as specified in TS 36.331 [10], clause 5.3.7;

8.1.5.6.5.1.3 Test description

8.1.5.6.5.1.3.1 Pre-test conditions

System Simulator:

- NR Cell 1, and NR Cell 3
- NR Cell 1 is PCell
- NR Cell 3 is SCell
- NR Cell 3 is an Inactive SCell according to TS 38.508-1 [4] clause 6.3.1
- System information combination NR-4 as defined in TS 38.508-1 [4] clause 4.4.3.1.2 is used in NR cells.

UE:

None.

Preamble:

- The UE is in 5GS state 3N-A according to TS 38.508-1 [4], clause 4.4A.2 Table 4.4A.2-3.

8.1.5.6.5.1.3.2 Test procedure sequence

Table 8.5.1.7.1.3.2-1 illustrates the downlink power levels and other changing parameters to be applied for the cells at various time instants of the test execution. Row marked "T0" denotes the initial conditions after preamble, while columns marked "T1" is to be applied subsequently. The exact instants on which these values shall be applied are described in the texts in this clause.

Table 8.1.5.6.5.1.3.2-1: Time instances of cell power level and parameter changes for FR1

	Parameter	Unit	NR Cell 1	NR Cell 3	Remark
T0	SS/PBCH SSS EPRE	dBm/SCS	-88	-88	NR Cell1 and NR Cell 3 are available
T1	SS/PBCH SSS EPRE	dBm/SCS	-88	"Off"	Only NR Cell 1 is available.

Table 8.1.5.6.5.1.3.2-1A: Time instances of cell power level and parameter changes for FR2

	Parameter	Unit	NR Cell 1	NR Cell 3	Remark
T0	SS/PBCH SSS EPRE	dBm/SCS	-95	-95	NR Cell1 and NR Cell 3 are available
T1	SS/PBCH SSS EPRE	dBm/SCS	-95	"Off"	Only NR Cell 1 is available.

Table 8.1.5.6.5.1.3.2-2: Main behaviour

St	Procedure	Message Sequence		TP	Verdict
		U - S	Message		
1	The SS transmits an <i>RRCReconfiguration</i> message on NR Cell 1 to configure SCell.	<--	<i>RRCReconfiguration</i>	-	-
2	The UE transmits an <i>RRCReconfigurationComplete</i> message on NR Cell 1.	-->	<i>RRCReconfigurationComplete</i>	-	-
3	Wait for 1s.	-	-	-	-
4	The SS changes power levels according to row "T1" in Table 8.1.5.6.5.1.3.2-1.	-	-	-	-
5	Wait for 1s.	-	-	-	-
6	Check: Does the UE transmit an <i>RRCReestablishmentRequest</i> message on NR Cell 1 with in next 2 seconds?	-->	<i>RRCReestablishmentRequest</i>	1	F
7	The SS sends <i>UECapabilityEnquiry</i> message to the UE.	<--	<i>UECapabilityEnquiry</i>	-	-
8	Check: Does the UE send a <i>UECapabilityInformation</i> message?	-->	<i>UECapabilityInformation</i>	1	P

8.1.5.6.5.1.3.3 Specific message contents

Table 8.1.5.6.5.1.3.3-1: *RRCReconfiguration* (step 1, Table 8.1.5.6.5.1.3.2-2)

Derivation Path: 38.508-1 [4] Table 4.6.1-13 with condition SCell_add

Table 8.1.5.6.5.1.3.3-2: Void**Table 8.1.5.6.5.1.3.3-3: Void**

8.1.5.6.5.2 NR CA / No Radio Link Failure on SCell / RRC Connection Continues on PCell / Inter-band CA

8.1.5.6.5.2.1 Test Purpose (TP)

Same as TC 8.1.5.6.5.1 but applied to Inter-band CA Test Case.

8.1.5.6.5.2.2 Conformance Requirements

Same as TC 8.1.5.6.5.1 but applied to Inter-band CA Test Case.

8.1.5.6.5.2.3 Test Description

8.1.5.6.5.2.3.1 Pre-test conditions

Same as TC 8.1.5.6.5.1 but with the following differences:

- CA configuration: Inter-band CA replaces Intra-band Contiguous CA.
- Cells configuration: Cell 10 replaces Cell 3.
- Cell 10 is an Inactive SCell according to TS 38.508-1 [4] clause 6.3.1.

8.1.5.6.5.2.3.2 Test procedure sequence

Same as TC 8.1.5.6.5.1 with the following differences:

- CA configuration: Inter-band CA replaces Intra-band Contiguous CA.
- Cells configuration: Cell 10 replaces Cell 3.

8.1.5.6.5.2.3.3 Specific message contents

Same as TC 8.1.5.6.5.1 but applied to Inter-band CA Test Case.

8.1.5.6.5.3 NR CA / No Radio Link Failure on SCell / RRC Connection Continues on PCell / Intra-band non-Contiguous CA

8.1.5.6.5.3.1 Test Purpose (TP)

Same as TC 8.1.5.6.5.1 but applied to Intra-band non-Contiguous CA Test Case.

8.1.5.6.5.3.2 Conformance Requirements

Same as TC 8.1.5.6.5.1 but applied to Intra-band non-Contiguous CA Test Case.

8.1.5.6.5.3.3 Test Description

8.1.5.6.5.3.3.1 Pre-test conditions

Same as TC 8.1.5.6.5.1 but with the following differences:

- CA configuration: Intra-band non-Contiguous CA replaces Intra-band Contiguous CA.

8.1.5.6.5.3.3.2 Test procedure sequence

Same as TC 8.1.5.6.5.1 with the following differences:

- CA configuration: Intra-band non-Contiguous CA replaces Intra-band Contiguous CA.

8.1.5.6.5.3.3.3 Specific message contents

Same as TC 8.1.5.6.5.1 but applied to Intra-band non-Contiguous CA Test Case.

8.1.5.7 Failure information

8.1.5.7.1 Failure information / RLC failure / MCG

8.1.5.7.1.1 Failure information / RLC failure / MCG / Intra-band Contiguous CA

8.1.5.7.1.1.1 Test Purpose (TP)

(1)

```
with { UE in NR RRC_CONNECTED state }
ensure that {
  when { an indication from MCG RLC that the maximum number of retransmissions has been reached and
when CA duplication is configured and activated and for the corresponding logical channel
allowedServingCells only includes SCell(s) }
  then { UE initiates the failure information procedure to report RLC failure via SRB1 }
}
```

8.1.5.7.1.1.2 Conformance requirements

References: The conformance requirements covered in the current TC are specified in: TS 38.331, clauses 5.7.5.2 and 5.7.5.3. Unless otherwise stated these are Rel-15 requirements.

[TS 38.331, clause 5.3.10.3]

The UE shall:

...

- 1> upon indication from MCG RLC that the maximum number of retransmissions has been reached:

2> if the indication is from MCG RLC and CA duplication is configured and activated, and for the corresponding logical channel *allowedServingCells* only includes SCell(s);

3> initiate the failure information procedure as specified in 5.7.5 to report RLC failure.

...

[TS 38.331, clause 5.7.5.2]

A UE initiates the procedure when there is a need inform the network about a failure detected by the UE. In particular, the UE initiates the procedure when the following condition is met:

1> upon detecting failure for an RLC bearer, in accordance with 5.3.10.3;

Upon initiating the procedure, the UE shall:

1> initiate transmission of the *FailureInformation* message as specified in 5.7.5.3;

[TS 38.331, clause 5.7.5.3]

The UE shall:

1> if initiated to provide RLC failure information, set *FailureInfoRLC-Bearer* as follows:

2> set *logicalChannelIdentity* to the logical channel identity of the failing RLC bearer;

2> set *cellGroupId* to the cell group identity of the failing RLC bearer;

2> set the *failureType* as *rlc-failure*;

1> if used to inform the network about a failure for an MCG RLC bearer:

2> submit the *FailureInformation* message to lower layers for transmission via SRB1;

...

8.1.5.7.1.1.3 Test description

8.1.5.7.1.1.3.1 Pre-test conditions

System Simulator:

- NR Cell 1 is the PCell, NR Cell 3 is the SCell.

UE:

- None.

Preamble:

- The UE is in state 3N-A, and with *UE test loop mode A prepared*, as defined in TS 38.508-1 [4], subclause 4.4A.

8.1.5.7.1.1.3.2 Test procedure sequence

Table 8.1.5.7.1.1.3.2-1: Main behaviour

St	Procedure	Message Sequence		TP	Verdict
		U - S	Message		
1	The SS transmits an <i>RRCReconfiguration</i> message to add SCell (NR Cell 3) for the UE.	<--	NR RRC: <i>RRCReconfiguration</i>	-	-
2	The UE transmits an <i>RRCReconfigurationComplete</i> message	-->	NR RRC: <i>RRCReconfigurationComplete</i>	-	-
2A	The SS transmits a SCell Activation/Deactivation MAC-CE to activate SCell (NR Cell 3).	<--	MAC PDU (SCell Activation/Deactivation MAC CE of one octet (C ₁ =1))	-	-
3	The SS transmits an <i>RRCReconfiguration</i> message to establish DRB #j for the UE	<--	NR RRC: <i>RRCReconfiguration</i>	-	-
4	The UE transmits an <i>RRCReconfigurationComplete</i> message	-->	NR RRC: <i>RRCReconfigurationComplete</i>	-	-
5	The SS transmits a CLOSE UE TEST LOOP message	<--	CLOSE UE TEST LOOP	-	-
6	The UE transmits a CLOSE UE TEST LOOP COMPLETE message.	-->	CLOSE UE TEST LOOP COMPLETE	-	-
7	The SS stops sending MCG RLC acknowledgments for the next RLC PDU on PCell (NR Cell 1) and SCell (NR Cell 3)	-	-	-	-
8	The SS transmits one PDCP PDU to the UE on DRB #j.	<--	PDCP PDU	-	-
-	EXCEPTION: Steps 9-9A occur in any sequence.	-	-	-	-
9	The UE loops back the PDCP PDU on PCell (NR Cell 1) on DRB #j	-->	PDCP PDU	-	-
9A	The UE loops back the PDCP PDU on SCell (NR Cell 3) on DRB #j	-->	PDCP PDU	-	-
10	Check: Does the UE transmit a FailureInformation message with failureType set to 'rlc-failure'?	-->	NR RRC: <i>FailureInformation</i>	1	P

8.1.5.7.1.1.3.3 Specific message contents

Table 8.1.5.7.1.1.3.3-1: RRCReconfiguration (Step 1, Table 8.1.5.7.1.1.3.2-1)

Derivation Path: TS 38.508-1 [4], Table 4.6.1-13 with condition SCell_add			
Information Element	Value/remark	Comment	Condition
RRCReconfiguration ::= SEQUENCE {			
criticalExtensions CHOICE {			
rrcReconfiguration SEQUENCE {			
nonCriticalExtension SEQUENCE {			
masterCellGroup SEQUENCE {			
sCellToAddModList SEQUENCE (SIZE (1..maxNrofSCells)) OF SCellConfig {	1 entry		
SCellConfig[1] SEQUENCE {		entry 1	
sCellIndex	SCellIndex for NR Cell 3		
sCellConfigCommon	ServingCellConfigCommon as per TS 38.508-1 [4] Table 4.6.3-168		
sCellConfigDedicated	ServingCellConfig as per TS 38.508-1 [4] Table 4.6.3-167		
}			
}			
}			
}			
}			
}			
}			

Table 8.1.5.7.1.1.3.3-2: RRCReconfiguration (Step 3, Table 8.1.5.7.1.1.3.2-1)

Derivation Path: TS 38.508-1[4], Table 4.6.1-13 with condition NR			
Information Element	Value/remark	Comment	Condition
RRCReconfiguration ::= SEQUENCE {			
criticalExtensions CHOICE {			
rrcReconfiguration SEQUENCE {			
radioBearerConfig	RadioBearerConfig-DRB	Table 8.1.5.7.1.1.3.3-3	
nonCriticalExtension SEQUENCE {			
masterCellGroup	CellGroupConfig-DRB	Table 8.1.5.7.1.1.3.3-4	
}			
}			
}			
}			

Table 8.1.5.7.1.1.3.3-3: RadioBearerConfig-DRB (Table 8.1.5.7.1.1.3.3-2)

Derivation Path: TS 508-1 [4], Table 4.6.3-132 with condition DRB2			
Information Element	Value/remark	Comment	Condition
RadioBearerConfig ::= SEQUENCE {			
drb-ToAddModList SEQUENCE (SIZE (1..maxDRB))	1 entry		
OF DRB-ToAddMod {			
DRB-ToAddMod[1] SEQUENCE {		entry 1	
drb-Identity	DRB-Identity with condition DRB j	j is the ID of the DRB added in Table 8.1.5.7.1.1.3.3-2, which is allocated according to internal TTCN mapping	
pdcp-Config	PDCCP-Config		
}			
}			
}			

Table 8.1.5.7.1.1.3.3-4: PDCCP-Config (Table 8.1.5.7.1.1.3.3-3)

Derivation Path: TS 38.508-1 [4], Table 4.6.3-99 with condition Split			
Information Element	Value/remark	Comment	Condition
PDCCP-Config ::= SEQUENCE {			
moreThanOneRLC SEQUENCE {			
primaryPath SEQUENCE {			
logicalChannel	LogicalChannelIdentity with Condition DRB j		
}			
pdcp-Duplication	True		
}			
}			

Table 8.1.5.7.1.1.3.3-5: CellGroupConfig-DRB

Derivation Path: TS 38.508-1 [4], Table 4.6.3-19 with Condition DRB j			
Information Element	Value/remark	Comment	Condition
CellGroupConfig ::= SEQUENCE {			
rlc-BearerToAddModList SEQUENCE (SIZE(1..maxLC-ID)) OF RLC-BearerConfig {	2 entries		
RLC-BearerConfig[1]	RLC-BearerConfig-1	entry 1 Table 8.1.5.7.1.1.3.3-6 Primary RLC	
RLC-BearerConfig[2]	RLC-BearerConfig-2	entry 1 Table 8.1.5.7.1.1.3.3-7 Secondary RLC	
}			
spCellConfig	Not present		
}			

Table 8.1.5.7.1.1.3.3-6: RLC-BearerConfig-1 (Table 8.1.5.7.1.1.3.3-5)

Derivation Path: TS 38.508-1 [4], Table 4.6.3-148 with Condition AM			
Information Element	Value/remark	Comment	Condition
RLC-BearerConfig ::= SEQUENCE {			
logicalChannelIdentity	LogicalChannelIdentity with condition DRB j	ID of primary logical channel	
servedRadioBearer CHOICE {			
drb-Identity	DRB-Identity with condition DRB j		
}			
rlc-Config CHOICE {			
am SEQUENCE {			
ul-AM-RLC SEQUENCE {			
maxRetxThreshold	t32	To ensure RLC failure happens before RLF	
}			
}			
}			
mac-LogicalChannelConfig SEQUENCE {			
ul-SpecificParameters SEQUENCE {			
allowedServingCells SEQUENCE (SIZE (1..maxNrofServingCells-1)) OF ServCellIndex {	1 entry		
ServCellIndex[1]	ServCellIndex of NR Cell 1	entry 1	
}			
}			
}			
}			

Table 8.1.5.7.1.1.3.3-7: RLC-BearerConfig-2 (Table 8.1.5.7.1.1.3.3-5)

Derivation Path: TS 38.508-1 [4], Table 4.6.3-148 with Condition AM			
Information Element	Value/remark	Comment	Condition
RLC-BearerConfig ::= SEQUENCE {			
logicalChannelIdentity	LogicalChannelIdentity with condition DRB j+1	To ensure ID of secondary logical channel ID is different with existing logical channel and the primary logical channel defined in Table 8.1.5.7.1.1.3.3-6	
servedRadioBearer CHOICE {			
drb-Identity	DRB-Identity with condition DRB j		
}			
rlc-Config CHOICE {			
am SEQUENCE {			
ul-AM-RLC SEQUENCE {			
maxRetxThreshold	t1	To ensure RLC failure happens before RLF	
}			
}			
}			
mac-LogicalChannelConfig SEQUENCE {			
ul-SpecificParameters SEQUENCE {			
allowedServingCells SEQUENCE (SIZE (1..maxNrofServingCells-1)) OF ServCellIndex {	1 entry		
ServCellIndex[1]	ServCellIndex of NR Cell 3	entry 1	
}			
}			
}			
}			

Table 8.1.5.7.1.1.3.3-8: FailureInformation (Step 10, Table 8.1.5.7.1.1.3.2-3)

Derivation Path: TS 38.508-1 [4], Table 4.6.1-4			
Information Element	Value/remark	Comment	Condition
FailureInformation ::= SEQUENCE {			
criticalExtensions CHOICE {			
failureInformation SEQUENCE {			
failureInfoRLC-Bearer SEQUENCE {			
cellGroupld	CellGroupld as per TS 38.508-1 [4] Table 4.6.3-20		
failureType	rlc-failure		
}			
}			
}			
}			

8.1.5.7.1.2 Failure information / RLC failure / MCG / Inter-band CA

8.1.5.7.1.2.1 Test Purpose (TP)

Same as TC 8.1.5.7.1.1 but applied to Inter-band CA case.

8.1.5.7.1.2.2 Conformance requirements

Same as TC 8.1.5.7.1.1 but applied to Inter-band CA case.

8.1.5.7.1.2.3 Test description

8.1.5.7.1.2.3.1 Pre-test conditions

Same as test case 8.1.5.7.1.1 with the following differences:

- CA configuration: Inter-band CA replaces Intra-band Contiguous CA.
- Cells configuration: NR Cell 10 replaces NR Cell 3.

8.1.5.7.1.2.3.2 Test procedure sequence

Same as test case 8.1.5.7.1.1 with the following differences:

- CA configuration: Inter-band CA replaces Intra-band Contiguous CA.
- Cells configuration: NR Cell 10 replaces NR Cell 3.

8.1.5.7.1.2.3.3 Specific message contents

Same as test case 8.1.5.7.1.1 with the following differences.

- CA configuration: Inter-band CA replaces Intra-band Contiguous CA.
- Cells configuration: NR Cell 10 replaces NR Cell 3.

8.1.5.7.1.3 Failure information / RLC failure / MCG / Intra-band non Contiguous CA

8.1.5.7.1.3.1 Test Purpose (TP)

Same as TC 8.1.5.7.1.1 but applied to Intra-band non Contiguous CA case.

8.1.5.7.1.3.2 Conformance requirements

Same as TC 8.1.5.7.1.1 but applied to Intra-band non Contiguous CA case.

8.1.5.7.1.3.3 Test description

8.1.5.7.1.3.3.1 Pre-test conditions

Same as test case 8.1.5.7.1.1 with the following differences:

- CA configuration: Intra-band non Contiguous CA replaces Intra-band Contiguous CA.

8.1.5.7.1.3.3.2 Test procedure sequence

Same as test case 8.1.5.7.1.1 with the following differences:

- CA configuration: Intra-band non Contiguous CA replaces Intra-band Contiguous CA.

8.1.5.7.1.3.3.3 Specific message contents

Same as test case 8.1.5.7.1.1 but applied to Intra-band non Contiguous CA case.

8.1.5.8 Processing delay

8.1.5.8.1 Processing delay / RRC_Idle to RRC_Connected / RRC_Inactive to RRC_Connected / Success / Latency check

8.1.5.8.1.1 Test Purpose (TP)

(1)

```
with { UE in NR RRC_IDLE state and has sent an RRCSetupRequest message }
ensure that {
  when { UE receives RRCSetup message and after 10ms receives an UL grant }
  then { UE successfully transmits RRCSetupComplete message }
}
```

(2)

```
with { UE in NR RRC_CONNECTED state }
ensure that {
  when { UE receive a SecurityModeCommand message and after 5ms receives an UL grant }
  then { UE successfully transmits SecurityModeComplete }
}
```

(3)

```
with { UE in NR RRC_CONNECTED state }
ensure that {
  when { UE receive a RRCReconfiguration message to establish DRB that is not part of the current UE
configuration and after 10ms receives an UL grant }
  then { UE successfully transmits RRCReconfigurationComplete message }
}
```

(4)

```
with { UE in NR RRC_CONNECTED state }
ensure that {
  when { UE receives an UECapabilityEnquiry message and after 80ms receives an UL grant }
  then { UE successfully transmits an UECapabilityInformation message }
}
```

(5)

```
with { UE in NR RRC_INACTIVE state and has sent an RRCResumeRequest message }
ensure that {
  when { UE receives RRCResume message and after 10ms receives an UL grant }
  then { UE successfully transmits RRCResumeComplete message }
}
```

(6)

```
with { UE in NR RRC_CONNECTED state }
ensure that {
  when { UE receives an RRCReconfiguration message containing sCellToAddModList with a SCell
addition and after 16ms receives an UL grant }
  then { UE successfully transmits RRCReconfigurationComplete message }
}
```

(7)

```
with { UE in NR RRC_CONNECTED state and and has sent an RRCReestablishmentRequest message after
detecting radio link failure on expiring of timer T310 }
ensure that {
  when { UE receives RRCReestablishment message and after 10ms receives an UL grant }
  then { UE successfully transmits RRCReestablishmentComplete message }
}
```

(8)

```

with { UE in NR RRC_INACTIVE state and has sent an RRCResumeRequest message }
ensure that {
  when { UE receives RRCResume message containing sCellToAddModList with a SCell addition and after
16ms receives an UL grant }
  then { UE successfully transmits RRCResumeComplete message }
}

```

(9)

```

with { UE in NR RRC_CONNECTED state }
ensure that {
  when { UE receives CounterCheck message and after 5ms receives an UL grant }
  then { UE successfully transmits an CounterCheckResponse message }
}

```

8.1.5.8.1.2 Conformance requirements

References: The conformance requirements covered in the present TC are specified in: TS 38.331, clauses 5.3.3.4, 5.3.4.3, 5.3.5.3, 5.3.6.3, 5.3.7.4, 5.3.13.4, 5.6.1.3 and 12. Unless otherwise stated these are Rel-15 requirements.

[TS 38.331, clause 5.3.3.4]

The UE shall perform the following actions upon reception of the *RRCSetup*:

...

- 1> submit the *RRCSetupComplete* message to lower layers for transmission, upon which the procedure ends.

[TS 38.331, clause 5.3.4.3]

The UE shall:

...

- 1> if the *SecurityModeCommand* message passes the integrity protection check:

...

- 2> submit the *SecurityModeComplete* message to lower layers for transmission, upon which the procedure ends;

[TS 38.331, clause 5.3.5.3]

The UE shall perform the following actions upon reception of the *RRCReconfiguration*:

...

- 1> if the *RRCReconfiguration* includes the *masterCellGroup*:

- 2> perform the cell group configuration for the received *masterCellGroup* according to 5.3.5.5;

...

- 1> if the *RRCReconfiguration* message includes the *radioBearerConfig*:

- 2> perform the radio bearer configuration according to 5.3.5.6;

...

- 1> else (*RRCReconfiguration* was received via SRB1):

- 2> submit the *RRCReconfigurationComplete* message via SRB1 to lower layers for transmission using the new configuration;

...

[38.331, clause 5.3.6.3]

Upon receiving the *CounterCheck* message, the UE shall:

...

- 1> submit the *CounterCheckResponse* message to lower layers for transmission upon which the procedure ends.

[38.331, clause 5.3.7.4]

The UE shall set the contents of *RRCReestablishmentRequest* message as follows:

...

- 1> submit the *RRCReestablishmentRequest* message to lower layers for transmission.

[38.331, clause 5.3.13.4]

The UE shall:

...

- 1> if the *RRCResume* includes the *masterCellGroup*:
 - 2> perform the cell group configuration for the received *masterCellGroup* according to 5.3.5.5;

...

- 1> submit the *RRCResumeComplete* message to lower layers for transmission;

...

[38.331, clause 5.6.1.3]

The UE shall set the contents of *UECapabilityInformation* message as follows:

- 1> if the *ue-CapabilityRAT-RequestList* contains a *UE-CapabilityRAT-Request* with *rat-Type* set to *nr*:
 - 2> include in the *ue-CapabilityRAT-ContainerList* a *UE-CapabilityRAT-Container* of the type *UE-NR-Capability* and with the *rat-Type* set to *nr*;
 - 2> include the *supportedBandCombinationList*, *featureSets* and *featureSetCombinations* as specified in clause 5.6.1.4;

...

- 1> submit the *UECapabilityInformation* message to lower layers for transmission, upon which the procedure ends.

[TS 38.331, clause 12]

The UE performance requirements for RRC procedures are specified in the following tables. The performance requirement is expressed as the time in [ms] from the end of reception of the network -> UE message on the UE physical layer up to when the UE shall be ready for the reception of uplink grant for the UE -> network response message with no access delay other than the TTI-alignment (e.g. excluding delays caused by scheduling, the random access procedure or physical layer synchronisation). In case the RRC procedure triggers BWP switching, the RRC procedure delay is the value defined in the following table plus the BWP switching delay defined in TS 38.133 [14], clause 8.6.3.

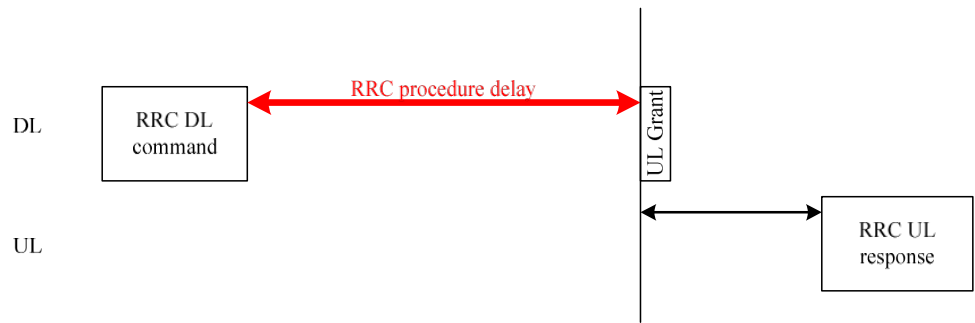

Figure 12.1-1: Illustration of RRC procedure delay

Table 12.1-1: UE performance requirements for RRC procedures for UEs

Procedure title:	Network -> UE	UE -> Network	Value [ms]	Notes
RRC Connection Control Procedures				
RRC reconfiguration	<i>RRCReconfiguration</i>	<i>RRCReconfigurationComplete</i>	10	
RRC reconfiguration (scell addition/release)	<i>RRCReconfiguration</i>	<i>RRCReconfigurationComplete</i>	16	
RRC setup	<i>RRCSetup</i>	<i>RRCSetupComplete</i>	10	
RRC re-establishment	<i>RRCReestablishment</i>	<i>RRCReestablishmentComplete</i>	10	
RRC resume	<i>RRCResume</i>	<i>RRCResumeComplete</i>	6 or 10	Value=6 applies for a UE supporting reduced CP latency for the case of RRCResume message only including MAC and PHY configuration, and no DRX, SPS, configured grant, CA or MIMO re-configuration will be triggered by this message. Further, the UL grant for transmission of <i>RRCResumeComplete</i> and the data is transmitted over common search space with DCI format 0_0. In this scenario, the RRC procedure delay [ms] can extend beyond the reception of the UL grant, up to 7 ms. For other cases, Value = 10 applies.
RRC resume (scell addition)	<i>RRCResume</i>	<i>RRCResumeComplete</i>	16	
Initial AS security activation	<i>SecurityModeCommand</i>	<i>SecurityModeComplete/SecurityModeFailure</i>	5	
Other procedures				
UE capability transfer	<i>UECapabilityEnquiry</i>	<i>UECapabilityInformation</i>	80	
Counter check	<i>CounterCheck</i>	<i>CounterCheckResponse</i>	5	

8.1.5.8.1.3 Test description

8.1.5.8.1.3.1 Pre-test conditions

System Simulator:

- NR Cell 1 and NR Cell 3.
- System information combination NR-4 as defined in TS 38.508-1 [4] clause 4.4.3.1.3 is used in NR cells.

UE:

- None.

Preamble:

- The UE is in state RRC_IDLE using generic procedure parameter Connectivity (NR) and Test Loop Function (On) with UE test loop mode B according to TS 38.508-1 [4], clause 4.5.4.

8.1.5.8.1.3.2 Test procedure sequence

Table 8.1.5.8.1.3.2-1/2 illustrates the downlink power levels and other changing parameters to be applied for the cells at various time instants of the test execution. Row marked "T0" denotes the initial conditions after preamble, while columns marked "T1" and "T2", are to be applied subsequently. The exact instants on which these values shall be applied are described in the texts in this clause.

Table 8.1.5.8.1.3.2-1: Time instances of cell power level and parameter changes in FR1

	Parameter	Unit	NR Cell 1	NR Cell 3
T0	SS/PBCH SSS EPRE	dBm/SCS	-88	"Off"
T1	SS/PBCH SSS EPRE	dBm/SCS	-88	-88
T2	SS/PBCH SSS EPRE	dBm/SCS	"Off"	-88

Table 8.1.5.8.1.3.2-2: Time instances of cell power level and parameter changes in FR2

	Parameter	Unit	NR Cell 1	NR Cell 3
T0	SS/PBCH SSS EPRE	dBm/SCS	FFS	"Off"
T1	SS/PBCH SSS EPRE	dBm/SCS	FFS	FFS
T2	SS/PBCH SSS EPRE	dBm/SCS	"Off"	FFS

Table 8.1.5.8.1.3.2-3: Main behaviour

St	Procedure	Message Sequence		TP	Verdict
		U - S	Message		
1	The SS transmits a <i>Paging</i> message including a matched ng-5G-S-TMSI.	<--	NR RRC: <i>Paging</i>	-	-
2	The UE transmits an <i>RRCSetupRequest</i> message.	-->	NR RRC: <i>RRCSetupRequest</i>	-	-
3	The SS transmits an <i>RRCSetup</i> message.	<--	NR RRC: <i>RRCSetup</i>	-	-
4	Check: Does the UE transmit an <i>RRCSetupComplete</i> message within 15 (FDD)/18 (TDD) subframes after successful completion of step 3? (Note 1)	-->	NR RRC: <i>RRCSetupComplete</i>	1	P
5	The SS transmits a <i>SecurityModeCommand</i> message.	<--	NR RRC: <i>SecurityModeCommand</i>	-	-
6	Check: Does the UE transmit a <i>SecurityModeComplete</i> message within 10 (FDD)/13 (TDD) subframes after successful completion of step 5? (Note 1)	-->	NR RRC: <i>SecurityModeComplete</i>	2	P
7	The SS transmits a <i>UECapabilityEnquiry</i> message.	<--	NR RRC: <i>UECapabilityEnquiry</i>	-	-
8	Check: Does the UE transmit a <i>UECapabilityInformation</i> message within 85 (FDD)/88 (TDD) subframes after successful completion of step 7? (Note 1)	-->	NR RRC: <i>UECapabilityInformation</i>	4	P
9	The SS transmits an <i>RRCReconfiguration</i> message to establish SRB2 and DRB #n for the UE	<--	NR RRC: <i>RRCReconfiguration</i>	-	-
10	Check: Does the UE transmit an <i>RRCReconfigurationComplete</i> message within 15 (FDD)/18 (TDD) subframes after successful completion of step 9? (Note 1)	-->	NR RRC: <i>RRCReconfigurationComplete</i>	3	P
11	The SS transmits a <i>CounterCheck</i> message.	<--	NR RRC: <i>CounterCheck</i>	-	-
12	Check: Does the UE transmit a <i>CounterCheckResponse</i> message within 10 (FDD)/13 (TDD) subframes after successful completion of step 11? (Note 1)	-->	NR RRC: <i>CounterCheckResponse</i>	9	P
13	The SS re-adjusts the SS levels according to row "T1" in table 8.1.5.8.1.3.2-1/2	-	-	-	-
14	The SS transmits an <i>RRCRelease</i> message with <i>suspendConfig</i> .	<--	NR RRC: <i>RRCRelease</i>	-	-
15	Wait 1s to let UE enter RRC_INACTIVE state.	-	-	-	-
16	The SS transmits a <i>Paging</i> message including a matched ng-5G-S-TMSI.	<--	NR RRC: <i>Paging</i>	-	-
17	The UE transmits an <i>RRCResumeRequest</i> message.	-->	NR RRC: <i>RRCResumeRequest</i>	-	-
18	The SS transmits an <i>RRCResume</i> message with with <i>sCellToAddModList</i> to add SCell(Cell 3) for the UE	<--	NR RRC: <i>RRCResume</i>	-	-
19	Check: Does the UE transmit an <i>RRCResumeComplete</i> message within 18 (FDD)/24 (TDD) subframes after successful completion of step 18? (Note 1)	-->	NR RRC: <i>RRCResumeComplete</i>	8	P
20	The SS transmits an <i>RRCReconfiguration</i> message to release SCell(Cell 3) for the UE	<--	NR RRC: <i>RRCReconfiguration</i>	-	-
21	UE transmits an <i>RRCReconfigurationComplete</i> message	-->	NR RRC: <i>RRCReconfigurationComplete</i>	-	-
22	The SS re-adjusts the SS levels according to row "T2" in table 8.1.5.8.1.3.2-1/2 in order that the radio link quality of NR Cell 1 is degraded, and NR Cell 3 is suitable for camping	-	-	-	-
23	Wait 1s to let T310 expire	-	-	-	-
24	The UE transmits an <i>RRCReestablishmentRequest</i> message on Cell 3	-->	NR RRC: <i>RRCReestablishmentRequest</i>	-	-
25	The SS transmits an <i>RRCReestablishment</i> message	<--	NR RRC: <i>RRCReestablishment</i>	-	-

26	Check: Does the UE transmit an <i>RRCReestablishmentComplete</i> message within 15 (FDD)/18 (TDD) subframes after successful completion of step 26? (Note 1)	-->	NR RRC: <i>RRCReestablishmentComplete</i>	7	P
27	The SS re-adjusts the SS levels according to row "T1" in table 8.1.5.8.1.3.2-1/2.	-	-	-	-
28	The SS transmits an <i>RRCReconfiguration</i> message with <i>sCellToAddModList</i> to add <i>SCell</i> (Cell 1) for the UE	<--	NR RRC: <i>RRCReconfiguration</i>	-	-
29	Check: Does the UE transmit an <i>RRCReconfigurationComplete</i> message within 21 (FDD)/24 (TDD) subframes after successful completion of step 28? (Note 1)	-->	NR RRC: <i>RRCReconfigurationComplete</i>	6	P
30	The SS transmits an <i>RRCRelease</i> message with <i>suspendConfig</i> .	<--	NR RRC: <i>RRCRelease</i>	-	-
31	Wait 1s to let UE enter RRC INACTIVE state.	-	-	-	-
32	The SS transmits a <i>Paging</i> message including a matched ng-5G-S-TMSI.	<--	NR RRC: <i>Paging</i>	-	-
33	The UE transmits an <i>RRCResumeRequest</i> message.	-->	NR RRC: <i>RRCResumeRequest</i>	-	-
34	The SS transmits an <i>RRCResume</i> message	<--	NR RRC: <i>RRCResume</i>	-	-
35	Check: Does the UE transmit an <i>RRCResumeComplete</i> message within 15 (FDD)/18 (TDD) subframes after successful completion of step 35? (Note 1)	-->	NR RRC: <i>RRCResumeComplete</i>	5	P
Note 1: 5 (FDD) / 8 (TDD) subframes is added on top of RRC processing delay requirement, because UL grant is allocated for the next subframe after RRC procedure delay and because of transmission delay after UL grant. For TDD, consider the max 7 TTI transmission delay after UL grant.					

8.1.5.8.1.3.3 Specific message contents

Table 8.1.5.8.1.3.3-1: *RRCConnectionReconfiguration* (Step 9, Table 8.1.5.8.1.3.2-3)

Derivation Path: TS 38.508-1[4], table 4.6.1-13 with condition NR			
Information Element	Value/remark	Comment	Condition
<i>RRCReconfiguration</i> ::= SEQUENCE {			
<i>criticalExtensions</i> CHOICE {			
c1 CHOICE {			
<i>rrcReconfiguration</i> SEQUENCE {			
<i>radioBearerConfig</i>	RadioBearerConfig-SRB2-DRB(1,0)	TS 38.508-1 [4] Table 4.8.1-4	
}			
<i>nonCriticalExtension</i> SEQUENCE {			
<i>masterCellGroup</i>	CellGroupConfig-SRB2-DRB(1,0)	TS 38.508-1 [4] Table 4.8.1-2B	
}			
}			
}			
}			

Table 8.1.5.8.1.3.3-2: CounterCheck (Step 11, Table 8.1.5.8.1.3.2-3)

Derivation Path: TS 38.508-1[4], Table 4.6.1-1			
Information Element	Value/remark	Comment	Condition
CounterCheck ::= SEQUENCE {			
criticalExtensions CHOICE {			
counterCheck SEQUENCE {			
drb-CountMSB-InfoList SEQUENCE (SIZE (1..maxDRB)) OF DRB-CountMSB-Info {	1 entry		
drb-Identity[1]	DRB-Identity with Condition DRBn	entry 1 n is the index of the DRB established in step 9 of Table 8.1.5.8.1.3.2-3, which is allocated according to internal TTCN mapping	
}			
}			
}			
}			

Table 8.1.5.8.1.3.3-3: CounterCheckResponse (Step 12, Table 8.1.5.8.1.3.2-3)

Derivation Path: TS 38.508-1[4], Table 4.6.1-2			
Information Element	Value/remark	Comment	Condition
CounterCheckResponse ::= SEQUENCE {			
criticalExtensions CHOICE {			
counterCheckResponse SEQUENCE {			
drb-CountInfoList SEQUENCE (SIZE (0..maxDRB)) OF DRB-CountInfo {	1 entry		
drb-Identity[1]	DRB-Identity with Condition DRBn	entry 1 n is the index of the DRB established in step 9 of Table 8.1.5.8.1.3.2-3, which is allocated according to internal TTCN mapping	
}			
}			
}			
}			

Table 8.1.5.8.1.3.3-4: RRCRelease (Step 14 and 30, Table 8.1.5.8.1.3.2-3)

Derivation Path: TS 38.508-1 [4], Table 4.6.1-16 with Condition NR_RRC_INACTIVE

Table 8.1.5.8.1.3.3-5: RRCResume (Step 18, Table 8.1.5.8.1.3.2-3)

Derivation Path: TS 38.508-1[4], Table 4.6.1-17			
Information Element	Value/remark	Comment	Condition
RRCResume ::= SEQUENCE {			
criticalExtensions CHOICE {			
rrcResume SEQUENCE {			
radioBearerConfig	RadioBearerConfig	Table 8.1.5.8.1.3.3-6	
masterCellGroup	CellGroupConfig	Table 8.1.5.8.1.3.3-7	
}			
}			
}			

Table 8.1.5.8.1.3.3-6: RadioBearerConfig (Table 8.1.5.8.1.3.3-5, Table 8.1.5.8.1.3.3-9 and Table 8.1.5.8.1.3.3-10)

Derivation Path: TS 38.508-1 [4], Table 4.6.3-132 with Condition SRB2 and DRB1			
Information Element	Value/remark	Comment	Condition
RadioBearerConfig ::= SEQUENCE {			
srb-ToAddModList SEQUENCE (SIZE (1..2)) OF SRB-ToAddMod {	1 entry		
SRB-ToAddMod[1] SEQUENCE {		entry 1	
reestablishPDCP	True		
}			
}			
drb-ToAddModList SEQUENCE (SIZE (1..maxDRB)) OF DRB-ToAddMod {	1 entry		
DRB-ToAddMod[1] SEQUENCE {		entry 1	
drb-Identity	DRB-Identity using condition DRBn	n is the index of the DRB established in step 9 of Table 8.1.5.8.1.3.2-3, which is allocated according to internal TTCN mapping	
reestablishPDCP	true		
}			
}			

Table 8.1.5.8.1.3.3-7: CellGroupConfig (Table 8.1.5.8.1.3.3-5 and Table 8.1.5.8.1.3.3-9)

Derivation Path: TS 38.508-1 [4], Table 4.6.3-19 with Condition SCell_Add			
Information Element	Value/remark	Comment	Condition
CellGroupConfig ::= SEQUENCE {			
rlc-BearerToAddModList SEQUENCE (SIZE (1..maxLC-ID)) OF RLC-BearerConfig {	2 entries		
RLC-BearerConfig[1]	RLC-BearerConfig with Condition SRB2 and Re-establish_RLC	entry 1	
RLC-BearerConfig[2]	RLC-BearerConfig with Condition DRBn and Re-establish_RLC	entry 2 n is the index of the DRB established in step 9 of Table 8.1.5.8.1.3.2-3, which is allocated according to internal TTCN mapping	
}			
sCellToAddModList SEQUENCE (SIZE (1..maxNrofSCells)) OF SCellConfig {	1 entry		
SCellConfig[1] SEQUENCE {		entry 1	
sCellConfigCommon SEQUENCE {			
physCellId	physCellId of Cell 3 physCellId of Cell 1		Step 20 Step 28
}			
}			
}			
}			

Table 8.1.5.8.1.3.3-8: RRCReconfiguration (Step 20, Table 8.1.5.8.1.3.2-3)

Derivation Path: TS 38.508-1 [4], Table 4.6.1-13 with Condition SCell_Add			
Information Element	Value/remark	Comment	Condition
RRCReconfiguration ::= SEQUENCE {			
criticalExtensions CHOICE {			
rrcReconfiguration SEQUENCE {			
nonCriticalExtension SEQUENCE {			
masterCellGroup SEQUENCE {			
sCellToAddModList	Not present		
sCellToReleaseList SEQUENCE (SIZE (1..maxNrofSCells)) OF SCellIndex {	1 entry		
SCellIndex[1]	SCellIndex of Cell 3	entry 1	
}			
}			
}			
}			
}			
}			

Table 8.1.5.8.1.3.3-9: RRCReconfiguration (Step 28, Table 8.1.5.8.1.3.2-3)

Derivation Path: TS 38.508-1 [4], Table 4.6.1-13 with Condition SCell_Add			
Information Element	Value/remark	Comment	Condition
RRCReconfiguration ::= SEQUENCE {			
criticalExtensions CHOICE {			
rrcReconfiguration SEQUENCE {			
radioBearerConfig	RadioBearerConfig	Table 8.1.5.8.1.3.3-6	
nonCriticalExtension SEQUENCE {			
masterCellGroup	CellGroupConfig	Table 8.1.5.8.1.3.3-8	
}			
}			
}			
}			

Table 8.1.5.8.1.3.3-10: RRCResume (Step 34, Table 8.1.5.8.1.3.2-3)

Derivation Path: TS 38.508-1[4],Table 4.6.1-17			
Information Element	Value/remark	Comment	Condition
RRCResume ::= SEQUENCE {			
criticalExtensions CHOICE {			
rrcResume SEQUENCE {			
radioBearerConfig	RadioBearerConfig	Table 8.1.5.8.1.3.3-6	
}			
}			
}			

8.2 MR-DC RRC

Editor's note: Editorial updates to test purposes and Preamble of all RRC test cases shall be updated to reflect as per generic procedure parameter for Bearers in TS 38.508-1 Table 4.5.1-1 for handling multi-PDN scenarios.

8.2.1 UE Capability

8.2.1.1 UE capability transfer / Success

8.2.1.1.1 UE capability transfer / Success / EN-DC

8.2.1.1.1.1 Test Purpose (TP)

(1)

```
with { UE in RRC_CONNECTED state with EN-DC, and, MCG(s) (E-UTRA PDCP) only }
ensure that {
  when { UE receives an UECapabilityEnquiry message that includes eutra }
  then { UE transmits an UECapabilityInformationRequest message including UE radio access capability
information corresponding to the ue-CapabilityRequest variable }
}
```

(2)

```
with { UE in RRC_CONNECTED state with EN-DC, and, MCG(s) (E-UTRA PDCP) only }
ensure that {
  when { UE receives an UECapabilityEnquiry message that includes eutra-nr and nr }
  then { UE transmits an UECapabilityInformationRequest message including UE radio access capability
information corresponding to the ue-CapabilityRequest variable }
}
```

8.2.1.1.1.2 Conformance requirements

References: The conformance requirements covered in the present TC are specified in: TS 36.331, clause 5.6.3.3. Unless otherwise stated these are Rel-15 requirements.

[TS 36.331, clause 5.6.3.3]

The UE shall:

- 1> for NB-IoT, set the contents of *UECapabilityInformation* message as follows:
 - 2> include the UE Radio Access Capability Parameters within the *ue-Capability-Container*;
 - 2> include *ue-RadioPagingInfo*;
 - 2> submit the *UECapabilityInformation* message to lower layers for transmission, upon which the procedure ends;
- 1> else, set the contents of *UECapabilityInformation* message as follows:
 - 2> if the *ue-CapabilityRequest* includes *eutra*:
 - 3> include the *UE-EUTRA-Capability* within a *ue-CapabilityRAT-Container* and with the *rat-Type* set to *eutra*;
 - 3> if the UE supports FDD and TDD:
 - 4> set all fields of *UECapabilityInformation*, except field *fdd-Add-UE-EUTRA-Capabilities* and *tdd-Add-UE-EUTRA-Capabilities* (including their sub-fields), to include the values applicable for both FDD and TDD (i.e. functionality supported by both modes);
 - 4> if (some of) the UE capability fields have a different value for FDD and TDD:
 - 5> if for FDD, the UE supports additional functionality compared to what is indicated by the previous fields of *UECapabilityInformation*:
 - 6> include field *fdd-Add-UE-EUTRA-Capabilities* and set it to include fields reflecting the additional functionality applicable for FDD;
 - 5> if for TDD, the UE supports additional functionality compared to what is indicated by the previous fields of *UECapabilityInformation*:
 - 6> include field *tdd-Add-UE-EUTRA-Capabilities* and set it to include fields reflecting the additional functionality applicable for TDD;

NOTE 1: The UE includes fields of *XDD-Add-UE-EUTRA-Capabilities* in accordance with the following:

- The field is included only if one or more of its sub-fields (or bits in the feature group indicators string) has a value that is different compared to the value signalled elsewhere within *UE-EUTRA-Capability*;
(this value signalled elsewhere is also referred to as the *Common value* that is supported for both XDD modes)
- For the fields that are included in *XDD-Add-UE-EUTRA-Capabilities*, the UE sets:
 - the sub-fields (or bits in the feature group indicators string) that are not allowed to be different to the same value as the *Common value*;
 - the sub-fields (or bits in the feature group indicators string) that are allowed to be different to a value indicating at least the same functionality as indicated by the *Common value*;
- 3> else (UE supports single xDD mode):
 - 4> set all fields of *UECapabilityInformation*, except field *fdd-Add-UE-EUTRA-Capabilities* and *tdd-Add-UE-EUTRA-Capabilities* (including their sub-fields), to include the values applicable for the xDD mode supported by the UE;

- 3> compile a list of band combinations, candidate for inclusion in the *UECapabilityInformation* message, comprising of band combinations supported by the UE according to the following priority order (i.e. listed in order of decreasing priority):
- 4> include all non-CA bands, regardless of whether UE supports carrier aggregation, only:
- if the UE includes *ue-Category-v1020* (i.e. indicating category 6 to 8); or
 - if for at least one of the non-CA bands, the UE supports more MIMO layers with TM9 and TM10 than implied by the UE category; or
 - if the UE supports TM10 with one or more CSI processes;
 - if the UE supports 1024QAM in DL;
- 4> if the *UECapabilityEnquiry* message includes *requestedFrequencyBands* and UE supports *requestedFrequencyBands*:
- 5> include all 2DL+1UL CA band combinations, only consisting of bands included in *requestedFrequencyBands*;
- 5> include all other CA band combinations, only consisting of bands included in *requestedFrequencyBands*, and prioritized in the order of *requestedFrequencyBands*, (i.e. first include remaining band combinations containing the first-listed band, then include remaining band combinations containing the second-listed band, and so on);
- 4> else (no requested frequency bands):
- 5> include all 2DL+1UL CA band combinations;
- 5> include all other CA band combinations;
- 4> if UE supports *maximumCCsRetrieval* and if the *UECapabilityEnquiry* message includes the *requestedMaxCCsDL* and the *requestedMaxCCsUL* (i.e. both UL and DL maximums are given):
- 5> remove from the list of candidates the band combinations for which the number of CCs in DL exceeds the value indicated in the *requestedMaxCCsDL* or for which the number of CCs in UL exceeds the value indicated in the *requestedMaxCCsUL*;
- 5> indicate in *requestedCCsUL* the same value as received in *requestedMaxCCsUL*;
- 5> indicate in *requestedCCsDL* the same value as received in *requestedMaxCCsDL*;
- 4> else if UE supports *maximumCCsRetrieval* and if the *UECapabilityEnquiry* message includes the *requestedMaxCCsDL* (i.e. only DL maximum limit is given):
- 5> remove from the list of candidates the band combinations for which the number of CCs in DL exceeds the value indicated in the *requestedMaxCCsDL*;
- 5> indicate value in *requestedCCsDL* the same value as received in *requestedMaxCCsDL*;
- 4> else if UE supports *maximumCCsRetrieval* and if the *UECapabilityEnquiry* message includes the *requestedMaxCCsUL* (i.e. only UL maximum limit is given):
- 5> remove from the list of candidates the band combinations for which the number of CCs in UL exceeds the value indicated in the *requestedMaxCCsUL*;
- 5> indicate in *requestedCCsUL* the same value as received in *requestedMaxCCsUL*;
- 4> if the UE supports *reducedIntNonContComb* and the *UECapabilityEnquiry* message includes *requestReducedIntNonContComb*:
- 5> set *reducedIntNonContCombRequested* to true;
- 5> remove from the list of candidates the intra-band non-contiguous CA band combinations which support is implied by another intra-band non-contiguous CA band combination included in the list of candidates as specified in TS 36.306 [5, 4.3.5.21];

- 4> if the UE supports *requestReducedFormat* and UE supports *skipFallbackCombinations* and *UECapabilityEnquiry* message includes *requestSkipFallbackComb*:
 - 5> set *skipFallbackCombRequested* to true;
 - 5> for each band combination included in the list of candidates (including 2DL+1UL CA band combinations), starting with the ones with the lowest number of DL and UL carriers, that concerns a fallback band combination of another band combination included in the list of candidates as specified in TS 36.306 [5]:
 - 6> remove the band combination from the list of candidates;
 - 6> include *differentFallbackSupported* in the band combination included in the list of candidates whose fallback concerns the removed band combination, if its capabilities differ from the removed band combination;
- 4> if the UE supports *requestReducedFormat* and *diffFallbackCombReport*, and *UECapabilityEnquiry* message includes *requestDiffFallbackCombList*:
 - 5> if the UE does not support *skipFallbackCombinations* or *UECapabilityEnquiry* message does not include *requestSkipFallbackComb*:
 - 6> remove all band combination from the list of candidates;
 - 5> for each CA band combination indicated in *requestDiffFallbackCombList*:
 - 6> include the CA band combination, if not already in the list of candidates;
 - 6> include the fallback combinations for which the supported UE capabilities are different from the capability of the CA band combination;
 - 5> include CA band combinations indicated in *requestDiffFallbackCombList* into *requestedDiffFallbackCombList*;
- 3> if the *UECapabilityEnquiry* message includes *requestReducedFormat* and UE supports *requestReducedFormat*:
 - 4> include in *supportedBandCombinationReduced* as many as possible of the band combinations included in the list of candidates, including the non-CA combinations, determined according to the rules and priority order defined above;
- 3> else
 - 4> if the *UECapabilityEnquiry* message includes *requestedFrequencyBands* and UE supports *requestedFrequencyBands*:
 - 5> include in *supportedBandCombination* as many as possible of the band combinations included in the list of candidates, including the non-CA combinations and up to 5DL+5UL CA band combinations, determined according to the rules and priority order defined above;
 - 5> include in *supportedBandCombinationAdd* as many as possible of the remaining band combinations included in the list of candidates, (i.e. the candidates not included in *supportedBandCombination*), up to 5DL+5UL CA band combinations, determined according to the rules and priority order defined above;
 - 4> else
 - 5> include in *supportedBandCombination* as many as possible of the band combinations included in the list of candidates, including the non-CA combinations and up to 5DL+5UL CA band combinations, determined according to the rules defined above;
 - 5> if it is not possible to include in *supportedBandCombination* all the band combinations to be included according to the above, selection of the subset of band combinations to be included is left up to UE implementation;

- 3> indicate in *requestedBands* the same bands and in the same order as included in *requestedFrequencyBands*, if received;
- 3> if the UE is a category 0, M1 or M2 UE, or supports any UE capability information in *ue-RadioPagingInfo*, according to TS 36.306 [5]:
 - 4> include *ue-RadioPagingInfo* and set the fields according to TS 36.306 [5];
- 3> if the UE supports EN-DC and if *requestedFreqBandsNR-MRDC* is included in the request:
 - 4> include into *featureSetsEUTRA* the feature sets that are applicable for the received *requestedFreqBandsNR-MRDC* as specified in TS 38.331 [82], clause 5.6.1.4.

NOTE: Even if the network requests (only) capabilities for *eutra*, it may include NR band numbers in the *requestedFreqBandsNR-MRDC* in order to ensure that the UE includes all necessary feature sets (i.e. E-UTRA and NR) needed for subsequently requested *eutra-nr* capabilities.

- 3> if the *UECapabilityEnquiry* message includes *request-sTTI-sPT-Capability* and if the UE supports short TTI and/or SPT:
 - 4> for each band combination the UE included in a field of the *UECapabilityInformation* message in accordance with the previous:
 - 4> if the UE supports short TTI, include the short TTI capabilities for each of the band combinations using the *sTTI-SPT-BandCombinationParameters*;
 - 4> if the UE supports SPT, include the SPT capabilities for each of the band combinations using the *sTTI-SPT-BandCombinationParameters*;

NOTE: The UE may have to add/repeat the band combinations to the list of band combinations included earlier, to include short TTI capabilities and/or SPT capabilities.

- 2> if the UE supports short TTI and/or SPT:
 - 3> include in the UE radio access capabilities the IE *sTTI-SPT-Supported* and set to *supported*;
- 2> if the *ue-CapabilityRequest* includes *geran-cs* and if the UE supports GERAN CS domain:
 - 3> include the UE radio access capabilities for GERAN CS within a *ue-CapabilityRAT-Container* and with the *rat-Type* set to *geran-cs*;
- 2> if the *ue-CapabilityRequest* includes *geran-ps* and if the UE supports GERAN PS domain:
 - 3> include the UE radio access capabilities for GERAN PS within a *ue-CapabilityRAT-Container* and with the *rat-Type* set to *geran-ps*;
- 2> if the *ue-CapabilityRequest* includes *utra* and if the UE supports UTRA:
 - 3> include the UE radio access capabilities for UTRA within a *ue-CapabilityRAT-Container* and with the *rat-Type* set to *utra*;
- 2> if the *ue-CapabilityRequest* includes *cdma2000-1XRTT* and if the UE supports CDMA2000 1xRTT:
 - 3> include the UE radio access capabilities for CDMA2000 within a *ue-CapabilityRAT-Container* and with the *rat-Type* set to *cdma2000-1XRTT*;
- 2> if the *ue-CapabilityRequest* includes *nr* and if the UE supports NR:
 - 3> include the UE radio access capabilities for NR within a *ue-CapabilityRAT-Container*, with the *rat-Type* set to *nr*;
 - 3> include band combinations and feature sets as specified in TS 38.331 [82], clause 5.6.1.4, considering the *FreqBandList* included in *requestedFreqBandsNR-MRDC* and the *eutra-nr*-only flag (if present);
- 2> if the *ue-CapabilityRequest* includes *eutra-nr* and if the UE supports EN-DC:

3> include the UE radio access capabilities for EUTRA-NR within a *ue-CapabilityRAT-Container*, with the *rat-Type* set to *eutra-nr*

3> include band combinations and feature sets as specified in TS 38.331 [82], clause 5.6.1.4, considering the *FreqBandList* included in *requestedFreqBandsNR-MRDC*;

1> submit the *UECapabilityInformation* message to lower layers for transmission, upon which the procedure ends;

8.2.1.1.1.3 Test description

8.2.1.1.1.3.1 Pre-test conditions

System Simulator:

- EUTRA Cell 1 is the PCell and NR Cell 1 is the PS Cell.

UE:

- None

Preamble:

- The UE is in state RRC_CONNECTED in EN-DC mode according to TS 38.508-1 [4] clause 4.5.4.2 with MCG(s) and SCG.

8.2.1.1.1.3.2 Test procedure sequence

Table 8.2.1.1.1.3.2-1: Main behaviour

St	Procedure	Message Sequence		TP	Verdict
		U - S	Message		
1	The SS transmits a <i>UECapabilityEnquiry</i> message including <i>eutra</i> .	<-	<i>UECapabilityEnquiry</i>	-	-
2	Check: Does the UE transmit a <i>UECapabilityInformation</i> message including UE radio access capability information as per the <i>ue-CapabilityRequest</i> variable?	-->	<i>UECapabilityInformation</i>	1	P
3	The SS transmits a <i>UECapabilityEnquiry</i> message including <i>eutra-nr</i> and <i>nr</i> .	<-	<i>UECapabilityEnquiry</i>	-	-
4	Check: Does the UE transmit a <i>UECapabilityInformation</i> message including UE radio access capability information as per the <i>ue-CapabilityRequest</i> variable?	-->	<i>UECapabilityInformation</i>	2	P

Table 8.2.1.1.1.3.3-2: UECapabilityInformation (step 2, Table 8.2.1.1.1.3.2-1)

Derivation Path: 36.508 [7], Table 4.6.1-23			
Information Element	Value/remark	Comment	Condition
UECapabilityInformation ::= SEQUENCE {			
criticalExtensions CHOICE {			
c1 CHOICE {			
ueCapabilityInformation-r8 SEQUENCE {			
ue-CapabilityRAT-ContainerList SEQUENCE (SIZE (1..maxRAT-Capabilities)) OF UE-CapabilityRAT-Container {	1 entry		
UE-CapabilityRAT-Container[1] SEQUENCE {		entry 1	
rat-Type	eutra		pc_EUTRA
ueCapabilityRAT-Container	UE-EUTRA-Capability	Encoded as per TS 36.331 [11] clause 6.3.6	pc_EUTRA
}			
}			
nonCriticalExtension	Not present		
}			
}			

BasedNetwPerfMeasParameters-v1530			
rlc-Parameters-v1530	Not checked		
sl-Parameters-v1530	Not checked		
extendedNumberOfDRBs-r15	Not checked		
reducedCP-Latency-r15	Not checked		
laa-Parameters-v1530	Not checked		
ue-CategoryUL-v1530	Not checked		
fdd-Add-UE-EUTRA-Capabilities-v1530 SEQUENCE {		Checked if any of the sub-IEs is present	
neighCellSI-AcquisitionParameters-v1530	Not checked		
reducedCP-Latency-r15	Not checked		
}			
tdd-Add-UE-EUTRA-Capabilities-v1530 SEQUENCE {		Checked if any of the sub-IEs is present	
neighCellSI-AcquisitionParameters-v1530	Not checked		
reducedCP-Latency-r15	Not checked		
}			
nonCriticalExtension SEQUENCE {		Checked if any of the sub-IEs is present	
phyLayerParameters-v1540	Not checked		
otherParameters-v1540	Not checked		
fdd-Add-UE-EUTRA-Capabilities-v1540 SEQUENCE {		Checked if any of the sub-IEs is present	
eutra-5GC-Parameters-r15	EUTRA-5GC-Parameters-r15		
irat-ParametersNR-v1540	IRAT-ParameterNR-v1540		
}			
tdd-Add-UE-EUTRA-Capabilities-v1540 SEQUENCE {		Checked if any of the sub-IEs is present	
eutra-5GC-Parameters-r15	EUTRA-5GC-Parameters-r15		
irat-ParametersNR-v1540	IRAT-ParameterNR-v1540		
}			
sl-Parameters-v1540	Not checked		
irat-ParametersNR-v1540	IRAT-ParameterNR-v1540		
SEQUENCE {			
nonCriticalExtension			
SEQUENCE {			
nonCriticalExtension			
SEQUENCE {			
nonCriticalExtension			
SEQUENCE {			
nonCriticalExtension			
v1610	highSpeedEnhParameters-	Not checked	>=Rel16
neighCellSI-AcquisitionParameters-v1610	Not checked		>=Rel16
mbms-Parameters-v1610	Not checked		>=Rel16
pdcp-Parameters-v1610	Not checked		>=Rel16
mac-Parameters-v1610	Not checked		>=Rel16
phyLayerParameters-v1610	Not checked		>=Rel16
measParameters-v1610	Not checked		>=Rel16
pur-Parameters-r16	Not checked		>=Rel16
eutra-5GC-Parameters-v1610	EUTRA-5GC-		>=Rel16

	Parameters-v1610		
	otherParameters-v1610	Not checked	>=Rel16
	dl-	Not checked	>=Rel16
DedicatedMessageSegmentation-r16	mmtel-Parameters-v1610	Not checked	>=Rel16
SEQUENCE	irat-ParametersNR-v1610		
	{		
	nr-HO-ToEN-DC-r16	Checked	pc_interRAT _NR_ToEND C
FDD-FR1-r16	ce-EUTRA-5GC-HO-ToNR-	Not checked	>=Rel16
TDD-FR1-r16	ce-EUTRA-5GC-HO-ToNR-	Not checked	>=Rel16
FDD-FR2-r16	ce-EUTRA-5GC-HO-ToNR-	Not checked	>=Rel16
TDD-FR2-r16	ce-EUTRA-5GC-HO-ToNR-	Not checked	>=Rel16
	}		>=Rel16
	rf-Parameters-v1610	Not checked	>=Rel16
	mobilityParameters-v1610	Not checked	>=Rel16
	ue-	Not checked	>=Rel16
BasedNetwPerfMeasParameters-v1610	sl-Parameters-v1610	Not checked	>=Rel16
Capabilities-v1610	fdd-Add-UE-EUTRA-		Checked if any of the sub-IEs is present
SEQUENCE	{		
	phyLayerParameters-v1610	Not checked	
	pur-Parameters-r16	Not checked	
	measParameters-v1610	Not checked	
	eutra-5GC-Parameters-v1610	EUTRA-5GC- Parameters-v1610	>=Rel16
SEQUENCE	irat-ParametersNR-v1610		>=Rel16
	{		
	nr-HO-ToEN-DC-r16	Checked	pc_interRAT _NR_ToEND C
FDD-FR1-r16	ce-EUTRA-5GC-HO-ToNR-	Not checked	>=Rel16
TDD-FR1-r16	ce-EUTRA-5GC-HO-ToNR-	Not checked	>=Rel16
FDD-FR2-r16	ce-EUTRA-5GC-HO-ToNR-	Not checked	>=Rel16
TDD-FR2-r16	ce-EUTRA-5GC-HO-ToNR-	Not checked	>=Rel16
	}		
AcquisitionParameters-v1610	neighCellSI-	Not checked	>=Rel16
	mobilityParameters-v1610	Not checked	>=Rel16
	}		
Capabilities-v1610	tdd-Add-UE-EUTRA-		Checked if any of the sub-IEs is present
SEQUENCE	{		
	phyLayerParameters-v1610	Not checked	>=Rel16
	pur-Parameters-r16	Not checked	>=Rel16
	measParameters-v1610	Not checked	>=Rel16
v1610	eutra-5GC-Parameters-	EUTRA-5GC- Parameters-v1610	>=Rel16
SEQUENCE	irat-ParametersNR-v1610		>=Rel16
	{		
	nr-HO-ToEN-DC-r16	Checked	pc_interRAT _NR_ToEND C
FDD-FR1-r16	ce-EUTRA-5GC-HO-ToNR-	Not checked	>=Rel16
TDD-FR1-r16	ce-EUTRA-5GC-HO-ToNR-	Not checked	>=Rel16

Table 8.2.1.1.1.3.3-3C: EUTRA-5GC-Parameters-r15 (Table 8.2.1.1.1.3.3-3)

Derivation Path: 36.331 [11], clause 6.3.6			
Information Element	Value/remark	Comment	Condition
EUTRA-5GC-Parameters-r15 SEQUENCE {			
eutra-5GC-r15	Not checked		
eutra-EPC-HO-EUTRA-5GC-r15	Not checked		
ho-EUTRA-5GC-FDD-TDD-r15	Not checked		
ho-InterfreqEUTRA-5GC-r15	Not checked		
ims-VoiceOverMCG-BearerEUTRA-5GC-r15	Not checked		
inactiveState-r15	Not checked		
reflectiveQoS-r15	Not checked		
}			

Table 8.2.1.1.1.3.3-3D: IRAT-ParameterNR-v1540 (Table 8.2.1.1.1.3.3-3)

Derivation Path: 36.331 [11], clause 6.3.6			
Information Element	Value/remark	Comment	Condition
IRAT-ParametersNR-v1540 SEQUENCE {			
eutra-5GC-HO-ToNR-FDD-FR1-r15	Not checked		
eutra-5GC-HO-ToNR-TDD-FR1-r15	Not checked		
eutra-5GC-HO-ToNR-FDD-FR2-r15	Not checked		
eutra-5GC-HO-ToNR-TDD-FR2-r15	Not checked		
eutra-EPC-HO-ToNR-FDD-FR1-r15	Not checked		
eutra-EPC-HO-ToNR-TDD-FR1-r15	Not checked		
eutra-EPC-HO-ToNR-FDD-FR2-r15	Not checked		
eutra-EPC-HO-ToNR-TDD-FR2-r15	Not checked		
ims-VoiceOverNR-FR1-r15	Not checked		
ims-VoiceOverNR-FR2-r15	Not checked		
sa-NR-r15	Not checked		
supportedBandListNR-SA-r15	SupportedBandListNR-r15		
}			

Table 8.2.1.1.1.3.3-3E: SupportedBandListNR-r15 (Table 8.2.1.1.1.3.3-3A and Table 8.2.1.1.1.3.3-3D)

Derivation Path: 36.331 [11], clause 6.3.6			
Information Element	Value/remark	Comment	Condition
SupportedBandListNR-r15 SEQUENCE (SIZE (1..maxBandsNR-r15)) OF SupportedBandNR-r15 {	"i" entries		
SupportedBandNR-r15[j] SEQUENCE {		entry "i"	
bandNR-r15	Not checked		
}			
}			

Table 8.2.1.1.1.3.3-4: *UECapabilityEnquiry* (step 3, Table 8.2.1.1.1.3.2-1)

Derivation Path: 36.508 [7], Table 4.6.1-22			
Information Element	Value/remark	Comment	Condition
UECapabilityEnquiry ::= SEQUENCE {			
criticalExtensions CHOICE {			
c1 CHOICE{			
ueCapabilityEnquiry-r8 SEQUENCE {			
ue-CapabilityRequest SEQUENCE (SIZE (1..maxRAT-Capabilities)) OF RAT-Type {	2 entries		
RAT-Type[1]	nr	entry 1	
RAT-Type[2]	eutra-nr	entry 2	
}			
nonCriticalExtension SEQUENCE {			
nonCriticalExtension SEQUENCE {			
nonCriticalExtension SEQUENCE {			
nonCriticalExtension SEQUENCE {			
nonCriticalExtension SEQUENCE {			
requestedFreqBandsNR-MRDC-r15	OCTET STRING including the FreqBandList IE according to TS 38.508-1 [4] table [4.6.4-21]		
}			
}			
}			
}			
}			
}			
}			
}			
}			
}			
}			

Table 8.2.1.1.1.3.3-5: *UECapabilityInformation* (step 4, Table 8.2.1.1.1.3.2-1)

Derivation Path: 36.508 [7], Table 4.6.1-23			
Information Element	Value/remark	Comment	Condition
UECapabilityInformation ::= SEQUENCE {			
criticalExtensions CHOICE {			
c1 CHOICE{			
ueCapabilityInformation-r8 SEQUENCE {			
ue-CapabilityRAT-ContainerList SEQUENCE (SIZE (1..maxRAT-Capabilities)) OF UE-CapabilityRAT-Container {	2 entries		
UE-CapabilityRAT-Container[1] SEQUENCE {		entry 1	
rat-Type	nr		pc_NR_FDD or pc_NR_TDD
ueCapabilityRAT-Container	UE-NR-Capability	Encoded as per TS 38.331 [12] clause 5.6.1	pc_NR_FDD or pc_NR_TDD
}			
UE-CapabilityRAT-Container[2] SEQUENCE {		entry 2	
rat-Type	eutra-nr		pc_EN_DC
ueCapabilityRAT-Container	UE-MRDC-Capability	Encoded as per TS 38.331 [12] clause 5.6.1	pc_EN_DC
}			
}			
nonCriticalExtension	Not present		
}			
}			
}			
}			

Table 8.2.1.1.1.3.3-6: UE-NR-Capability (Table 8.2.1.1.1.3.3-5)

Derivation Path: 38.331 [12], clause 6.3.3			
Information Element	Value/remark	Comment	Condition
UE-NR-Capability ::= SEQUENCE {			
accessStratumRelease	Checked	"rel-15" or higher	
pdcip-Parameters SEQUENCE {			
supportedROHC-Profiles SEQUENCE {			
profile0x0000	Not checked		
profile0x0001	Not checked		
profile0x0002	Not checked		
profile0x0003	Not checked		
profile0x0004	Not checked		
profile0x0006	Not checked		
profile0x0101	Not checked		
profile0x0102	Not checked		
profile0x0103	Not checked		
profile0x0104	Not checked		
}			
maxNumberROHC-ContextSessions	Not checked		
uplinkOnlyROHC-Profiles	Not checked		
continueROHC-Context	Not checked		
outOfOrderDelivery	Checked		pc_outOfOrderDelivery
shortSN	Checked		pc_shortSN
pdcip-DuplicationSRB	Not checked		
pdcip-DuplicationMCG-OrSCG-DRB	Not checked		
}			
rlc-Parameters SEQUENCE {			
am-WithShortSN	Checked		pc_am_WithShortSN
um-WithShortSN	Checked		pc_um_WithShortSN
um-WithLongSN	Checked		pc_um_WithLongSN
}			
mac-Parameters SEQUENCE {			
mac-ParametersCommon SEQUENCE {			
lcp-Restriction	Not checked		
dummy	Not checked		
lch-ToSCellRestriction	Not checked		
recommendedBitRate	Not checked		
recommendedBitRateQuery	Not checked		
}			
mac-ParametersXDD-Diff SEQUENCE {			
skipUplinkTxDynamic	Checked (NOTE 4)		pc_skipUplinkTxDynamic
logicalChannelSR-DelayTimer	Checked (NOTE 5)		pc_logicalChannelSR-DelayTimer
longDRX-Cycle	Checked (NOTE 6)		pc_longDRX-Cycle
shortDRX-Cycle	Checked (NOTE 7)		pc_shortDRX-Cycle
multipleSR-Configurations	Not checked		
multipleConfiguredGrants	Not checked		
}			
}			
phy-Parameters SEQUENCE {			
phy-ParametersCommon SEQUENCE {			
csi-RS-CFRA-ForHO	Checked		pc_csi_RS-CFRA-ForHO
dynamicPRB-BundlingDL	Not checked		
sp-CSI-ReportPUCCH	Not checked		
sp-CSI-ReportPUSCH	Not checked		

nzp-CSI-RS-IntefMgmt	Not checked		
type2-SP-CSI-Feedback-LongPUCCH	Not checked		
precoderGranularityCORESET	Not checked		
dynamicHARQ-ACK-Codebook	Not checked		
semiStaticHARQ-ACK-Codebook	Not checked		
spatialBundlingHARQ-ACK	Not checked		
dynamicBetaOffsetInd-HARQ-ACK-CSI	Not checked		
pucch-Repetition-F1-3-4	Not checked		
ra-Type0-PUSCH	Checked		pc_ra_Type0_PUSCH
dynamicSwitchRA-Type0-1-PDSCH	Not checked		
dynamicSwitchRA-Type0-1-PUSCH	Not checked		
pdsch-MappingTypeA	Checked		pc_pdsch_MappingTypeA
pdsch-MappingTypeB	Checked		pc_pdsch_MappingTypeB
interleavingVRB-ToPRB-PDSCH	Checked		pc_interleavingVRB_ToPRB_PDSCH
interSlotFreqHopping-PUSCH	Not checked		
type1-PUSCH-RepetitionMultiSlots	Not checked		
type2-PUSCH-RepetitionMultiSlots	Not checked		
pusch-RepetitionMultiSlots	Checked		pc_pusch_RepetitionMultiSlots
pdsch-RepetitionMultiSlots	Checked		pc_pdsch_RepetitionMultiSlots
downlinkSPS	Checked		pc_downlinkSPS
configuredUL-GrantType1	Checked		pc_configuredUL_GrantType1
configuredUL-GrantType2	Checked		pc_configuredUL_GrantType2
pre-EmptIndication-DL	Not checked		
cbg-TransIndication-DL	Not checked		
cbg-TransIndication-UL	Not checked		
cbg-FlushIndication-DL	Not checked		
dynamicHARQ-ACK-CodeB-CBG-Retx-DL	Not checked		
rateMatchingResrcSetSemi-Static	Not checked		
rateMatchingResrcSetDynamic	Not checked		
bwp-SwitchingDelay	Not checked		
dummy	Not checked		
maxNumberSearchSpaces	Checked		pc_maxNumberSearchSpaces
rateMatchingCtrlResrsSetDynamic	Not checked		
maxLayersMIMO-Indication	Not checked		
}			
phy-ParametersXDD-Diff SEQUENCE {			
dynamicSFI	Not checked		
twoPUCCH-F0-2-ConsecSymbols	Not checked		
twoDifferentTPC-Loop-PUSCH	Not checked		
twoDifferentTPC-Loop-PUCCH	Not checked		
dl-SchedulingOffset-PDSCH-TypeA	Not checked		
dl-SchedulingOffset-PDSCH-TypeB	Not checked		
ul-SchedulingOffset	Not checked		
}			
phy-ParametersFRX-Diff SEQUENCE {			
dynamicSFI	Not checked		
dummy1	Not checked		
twoFL-DMRS	Not checked		

dummy2	Not checked		
dummy3	Not checked		
supportedDMRS-TypeDL	Not checked		
supportedDMRS-TypeUL	Not checked		
semiOpenLoopCSI	Not checked		
csi-ReportWithoutPMI	Not checked		
csi-ReportWithoutCQI	Not checked		
onePortsPTRS	Not checked		
twoPUCCH-F0-2-ConsecSymbols	Not checked		
pucch-F2-WithFH	Not checked		
pucch-F3-WithFH	Not checked		
pucch-F4-WithFH	Not checked		
freqHoppingPUCCH-F0-2	Not checked		
freqHoppingPUCCH-F1-3-4	Not checked		
mux-SR-HARQ-ACK-CSI-PUCCH-MultiPerSlot	Not checked		
uci-CodeBlockSegmentation	Not checked		
onePUCCH-LongAndShortFormat	Not checked		
twoPUCCH-AnyOthersInSlot	Not checked		
intraSlotFreqHopping-PUSCH	Not checked		
pusch-LBRM	Not checked		
pdccch-BlindDetectionCA	Not checked		
tpc-PUSCH-RNTI	Not checked		
tpc-PUCCH-RNTI	Not checked		
tpc-SRS-RNTI	Not checked		
absoluteTPC-Command	Not checked		
twoDifferentTPC-Loop-PUSCH	Not checked		
twoDifferentTPC-Loop-PUCCH	Not checked		
pusch-HalfPi-BPSK	Not checked		
pucch-F3-4-HalfPi-BPSK	Not checked		
almostContiguousCP-OFDM-UL	Not checked		
sp-CSI-RS	Not checked		
sp-CSI-IM	Not checked		
tdt-MultiDL-UL-SwitchPerSlot	Not checked		
multipleCORESET	Not checked		
csi-RS-IM-ReceptionForFeedback	Not checked	CSI-RS-IM-ReceptionForFeedback	
csi-RS-ProcFrameworkForSRS	Not checked	CSI-RS-ProcFrameworkForSRS	
csi-ReportFramework	Not checked	CSI-ReportFramework	
mux-SR-HARQ-ACK-CSI-PUCCH-OncePerSlot SEQUENCE {			
sameSymbol	Not checked		
diffSymbol	Not checked		
}			
mux-SR-HARQ-ACK-PUCCH	Not checked		
mux-MultipleGroupCtrlCH-Overlap	Not checked		
dl-SchedulingOffset-PDSCH-TypeA	Not checked		
dl-SchedulingOffset-PDSCH-TypeB	Not checked		
ul-SchedulingOffset	Not checked		
dl-64QAM-MCS-TableAlt	Not checked		
ul-64QAM-MCS-TableAlt	Not checked		
cqi-TableAlt	Not checked		
oneFL-DMRS-TwoAdditionalDMRS-UL	Not checked		
twoFL-DMRS-TwoAdditionalDMRS-UL	Not checked		
oneFL-DMRS-ThreeAdditionalDMRS-UL	Not checked		
}			
phy-ParametersFR1 SEQUENCE {			
pdccchMonitoringSingleOccasion	Not checked		
scs-60kHz	Not checked		
pdsch-256QAM-FR1	Checked		pc_pdsch_256QAM_FR1
pdsch-RE-MappingFR1-PerSymbol	Not checked		
pdsch-RE-MappingFR1-PerSlot	Not checked		

}			
phy-ParametersFR2 SEQUENCE {			
dummy	Not checked		
pdsch-RE-MappingFR2-PerSymbol	Not checked		
pCell-FR2	Not checked		
pdsch-RE-MappingFR2-PerSlot	Not checked		
}			
}			
rf-Parameters SEQUENCE {			
supportedBandListNR SEQUENCE (SIZE (1..maxBands)) OF BandNR {	i entries		
BandNR[i] SEQUENCE {		entry i	
bandNR	Checked	Checked for 'maxBands' entries of FreqBandIndicator NR[i]	pc_nrBandx ('x' being the band number/type related PICS listed in TS 38.508-2)
modifiedMPR-Behaviour	Not checked		
mimo-ParametersPerBand	Not checked	MIMO-ParametersPerBand[j]	
extendedCP	Not checked		
multipleTCI	Not checked		
bwp-WithoutRestriction	Not checked		
bwp-SameNumerology	Not checked		
bwp-DiffNumerology	Not checked		
crossCarrierScheduling-SameSCS	Not checked		
pdsch-256QAM-FR2	Checked	Note 8	pc_pdsch_256QAM_FR2
pusch-256QAM	Checked	Note 9	pc_pusch_256QAM_FR1 OR pc_pusch_256QAM_FR2
ue-PowerClass	Not checked		
rateMatchingLTE-CRS	Not checked		
channelBWs-DL-v1530 CHOICE {			
fr1 SEQUENCE {			
scs-15kHz	Not checked		
scs-30kHz	Not checked		
scs-60kHz	Not checked		
}			
fr2 SEQUENCE {			
scs-60kHz	Not checked		
scs-120kHz	Not checked		
}			
}			
channelBWs-UL-v1530 CHOICE {			
fr1 SEQUENCE {			
scs-15kHz	Not checked		
scs-30kHz	Not checked		
scs-60kHz	Not checked		
}			
fr2 SEQUENCE {			
scs-60kHz	Not checked		
scs-120kHz	Not checked		
}			
maxUplinkDutyCycle-PC2-FR1	Not checked		
pucch-SpatialRelInfoMAC-CE	Not checked		
powerBoosting-pi2BPSK	Not checked		
}			
}			
}			
supportedBandCombinationList SEQUENCE (SIZE	i entries		

}			
}			
}			
ca-ParametersNR-v1540	Not checked	CA-ParametersNR-v1540	
}			
}			
srs-SwitchingTimeRequested	Not checked		
}			
measAndMobParameters SEQUENCE {			
measAndMobParametersCommon SEQUENCE {			
supportedGapPattern	Not checked		
ssb-RLM	Not checked		
ssb-AndCSI-RS-RLM	Not checked		
eventB-MeasAndReport	Not checked		
handoverFDD-TDD	Not checked		
eutra-CGI-Reporting	Not checked		
nr-CGI-Reporting	Not checked		
independentGapConfig	Checked		pc_independentGapConfig
periodicEUTRA-MeasAndReport	Not checked		
handoverFR1-FR2	Not checked		
maxNumberCSI-RS-RRM-RS-SINR	Not checked		
}			
measAndMobParametersXDD-Diff SEQUENCE {			
intraAndInterF-MeasAndReport	Checked (NOTE 1)		pc_intraAndInterF-MeasAndReport
eventA-MeasAndReport	Checked (NOTE 2)		pc_eventA-MeasAndReport
handoverInterF	Not checked		
handoverLTE	Not checked		
handover-eLTE	Not checked		
}			
measAndMobParametersFRX-Diff SEQUENCE {			
ss-SINR-Meas	Not checked		
csi-RSRP-AndRSRQ-MeasWithSSB	Checked (NOTE 3)		pc_csi-RSRP-AndRSRQ-MeasWithSSB
csi-RSRP-AndRSRQ-MeasWithoutSSB	Not checked		
csi-SINR-Meas	Not checked		
csi-RS-RLM	Not checked		
handoverInterF	Not checked		
handoverLTE	Not checked		
handover-eLTE	Not checked		
maxNumberResource-CSI-RS-RLM	Not checked		
}			
}			
fdd-Add-UE-NR-Capabilities SEQUENCE {			
phy-ParametersXDD-Diff SEQUENCE {			
dynamicSFI	Not checked		
twoPUCCH-F0-2-ConsecSymbols	Not checked		
twoDifferentTPC-Loop-PUSCH	Not checked		
twoDifferentTPC-Loop-PUCCH	Not checked		
dl-SchedulingOffset-PDSCH-TypeA	Not checked		
dl-SchedulingOffset-PDSCH-TypeB	Not checked		
ul-SchedulingOffset	Not checked		
}			
mac-ParametersXDD-Diff SEQUENCE {			
skipUplinkTxDynamic	Checked (NOTE 4)		pc_skipUplinkTxDynamic

			kTxDynamic
logicalChannelSR-DelayTimer	Checked (NOTE 5)		pc_logicalChannelSR_DelayTimer
longDRX-Cycle	Checked (NOTE 6)		pc_longDRX_Cycle
shortDRX-Cycle	Checked (NOTE 7)		pc_shortDRX_Cycle
multipleSR-Configurations	Not checked		
multipleConfiguredGrants	Not checked		
}			
measAndMobParametersXDD-Diff SEQUENCE {			
intraAndInterF-MeasAndReport	Checked (NOTE 1)		pc_intraAndInterF-MeasAndReport
eventA-MeasAndReport	Checked (NOTE 2)		pc_eventA-MeasAndReport
handoverInterF	Not checked		
handoverLTE	Not checked		
handover-eLTE	Not checked		
}			
tdd-Add-UE-NR-Capabilities SEQUENCE {			
phy-ParametersXDD-Diff SEQUENCE {			
dynamicSFI	Not checked		
twoPUCCH-F0-2-ConsecSymbols	Not checked		
twoDifferentTPC-Loop-PUSCH	Not checked		
twoDifferentTPC-Loop-PUCCH	Not checked		
dl-SchedulingOffset-PDSCH-TypeA	Not checked		
dl-SchedulingOffset-PDSCH-TypeB	Not checked		
ul-SchedulingOffset	Not checked		
}			
mac-ParametersXDD-Diff SEQUENCE {			
skipUplinkTxDynamic	Checked (NOTE 4)		pc_skipUplinkTxDynamic
logicalChannelSR-DelayTimer	Checked (NOTE 5)		pc_logicalChannelSR_DelayTimer
longDRX-Cycle	Checked (NOTE 6)		pc_longDRX_Cycle
shortDRX-Cycle	Checked (NOTE 7)		pc_shortDRX_Cycle
multipleSR-Configurations	Not checked		
multipleConfiguredGrants	Not checked		
}			
measAndMobParametersXDD-Diff SEQUENCE {			
intraAndInterF-MeasAndReport	Checked (NOTE 1)		pc_intraAndInterF-MeasAndReport
eventA-MeasAndReport	Checked (NOTE 2)		pc_eventA-MeasAndReport
handoverInterF	Not checked		
handoverLTE	Not checked		
handover-eLTE	Not checked		
}			
fr1-Add-UE-NR-Capabilities SEQUENCE {			
phy-ParametersFRX-Diff SEQUENCE {			
dynamicSFI	Not checked		
dummy1	Not checked		
twoFL-DMRS	Not checked		
dummy2	Not checked		
dummy3	Not checked		

supportedDMRS-TypeDL	Not checked		
supportedDMRS-TypeUL	Not checked		
semiOpenLoopCSI	Not checked		
csi-ReportWithoutPMI	Not checked		
csi-ReportWithoutCQI	Not checked		
onePortsPTRS	Not checked		
twoPUCCH-F0-2-ConsecSymbols	Not checked		
pucch-F2-WithFH	Not checked		
pucch-F3-WithFH	Not checked		
pucch-F4-WithFH	Not checked		
freqHoppingPUCCH-F0-2	Not checked		
freqHoppingPUCCH-F1-3-4	Not checked		
mux-SR-HARQ-ACK-CSI-PUCCH-MultiPerSlot	Not checked		
uci-CodeBlockSegmentation	Not checked		
onePUCCH-LongAndShortFormat	Not checked		
twoPUCCH-AnyOthersInSlot	Not checked		
intraSlotFreqHopping-PUSCH	Not checked		
pusch-LBRM	Not checked		
pdccch-BlindDetectionCA	Not checked		
tpc-PUSCH-RNTI	Not checked		
tpc-PUCCH-RNTI	Not checked		
tpc-SRS-RNTI	Not checked		
absoluteTPC-Command	Not checked		
twoDifferentTPC-Loop-PUSCH	Not checked		
twoDifferentTPC-Loop-PUCCH	Not checked		
pusch-HalfPi-BPSK	Not checked		
pucch-F3-4-HalfPi-BPSK	Not checked		
almostContiguousCP-OFDM-UL	Not checked		
sp-CSI-RS	Not checked		
sp-CSI-IM	Not checked		
tdd-MultiDL-UL-SwitchPerSlot	Not checked		
multipleCORESET	Not checked		
csi-RS-IM-ReceptionForFeedback	Not checked		
csi-RS-ProcFrameworkForSRS	Not checked		
csi-ReportFramework	Not checked		
mux-SR-HARQ-ACK-CSI-PUCCH-OncePerSlot			
SEQUENCE {			
sameSymbol	Not checked		
diffSymbol	Not checked		
}			
mux-SR-HARQ-ACK-PUCCH	Not checked		
mux-MultipleGroupCtrlCH-Overlap	Not checked		
dl-SchedulingOffset-PDSCH-TypeA	Not checked		
dl-SchedulingOffset-PDSCH-TypeB	Not checked		
ul-SchedulingOffset	Not checked		
dl-64QAM-MCS-TableAlt	Not checked		
ul-64QAM-MCS-TableAlt	Not checked		
cqi-TableAlt	Not checked		
oneFL-DMRS-TwoAdditionalDMRS-UL	Not checked		
twoFL-DMRS-TwoAdditionalDMRS-UL	Not checked		
oneFL-DMRS-ThreeAdditionalDMRS-UL	Not checked		
}			
measAndMobParametersFRX-Diff SEQUENCE {			
ss-SINR-Meas	Not checked		
csi-RSRP-AndRSRQ-MeasWithSSB	Checked (NOTE 3)		pc_csi- RSRP- AndRSRQ- MeasWithSS B
csi-RSRP-AndRSRQ-MeasWithoutSSB	Not checked		
csi-SINR-Meas	Not checked		
csi-RS-RLM	Not checked		
handoverInterF	Not checked		
handoverLTE	Not checked		
handover-eLTE	Not checked		
maxNumberResource-CSI-RS-RLM	Not checked		

}			
}			
fr2-Add-UE-NR-Capabilities SEQUENCE {			
phy-ParametersFRX-Diff SEQUENCE {	Not checked		
dynamicSFI	Not checked		
dummy1	Not checked		
twoFL-DMRS	Not checked		
dummy2	Not checked		
dummy3	Not checked		
supportedDMRS-TypeDL	Not checked		
supportedDMRS-TypeUL	Not checked		
semiOpenLoopCSI	Not checked		
csi-ReportWithoutPMI	Not checked		
csi-ReportWithoutCQI	Not checked		
onePortsPTRS	Not checked		
twoPUCCH-F0-2-ConsecSymbols	Not checked		
pucch-F2-WithFH	Not checked		
pucch-F3-WithFH	Not checked		
pucch-F4-WithFH	Not checked		
freqHoppingPUCCH-F0-2	Not checked		
freqHoppingPUCCH-F1-3-4	Not checked		
mux-SR-HARQ-ACK-CSI-PUCCH-MultiPerSlot	Not checked		
uci-CodeBlockSegmentation	Not checked		
onePUCCH-LongAndShortFormat	Not checked		
twoPUCCH-AnyOthersInSlot	Not checked		
intraSlotFreqHopping-PUSCH	Not checked		
pusch-LBRM	Not checked		
pdccch-BlindDetectionCA	Not checked		
tpc-PUSCH-RNTI	Not checked		
tpc-PUCCH-RNTI	Not checked		
tpc-SRS-RNTI	Not checked		
absoluteTPC-Command	Not checked		
twoDifferentTPC-Loop-PUSCH	Not checked		
twoDifferentTPC-Loop-PUCCH	Not checked		
pusch-HalfPi-BPSK	Not checked		
pucch-F3-4-HalfPi-BPSK	Not checked		
almostContiguousCP-OFDM-UL	Not checked		
sp-CSI-RS	Not checked		
sp-CSI-IM	Not checked		
tdd-MultiDL-UL-SwitchPerSlot	Not checked		
multipleCORESET	Not checked		
csi-RS-IM-ReceptionForFeedback	Not checked		
csi-RS-ProcFrameworkForSRS	Not checked		
csi-ReportFramework	Not checked		
mux-SR-HARQ-ACK-CSI-PUCCH-OncePerSlot			
SEQUENCE {			
sameSymbol	Not checked		
diffSymbol	Not checked		
}			
mux-SR-HARQ-ACK-PUCCH	Not checked		
mux-MultipleGroupCtrlCH-Overlap	Not checked		
dl-SchedulingOffset-PDSCH-TypeA	Not checked		
dl-SchedulingOffset-PDSCH-TypeB	Not checked		
ul-SchedulingOffset	Not checked		
dl-64QAM-MCS-TableAlt	Not checked		
ul-64QAM-MCS-TableAlt	Not checked		
cqi-TableAlt	Not checked		
oneFL-DMRS-TwoAdditionalDMRS-UL	Not checked		
twoFL-DMRS-TwoAdditionalDMRS-UL	Not checked		
oneFL-DMRS-ThreeAdditionalDMRS-UL	Not checked		
}			
measAndMobParametersFRX-Diff SEQUENCE {			
ss-SINR-Meas	Not checked		
csi-RSRP-AndRSRQ-MeasWithSSB	Checked (NOTE 3)		pc_csi- RSRP-

			AndRSRQ- MeasWithSS B
csi-RSRP-AndRSRQ-MeasWithoutSSB	Not checked		
csi-SINR-Meas	Not checked		
csi-RS-RLM	Not checked		
handoverInterF	Not checked		
handoverLTE	Not checked		
handover-eLTE	Not checked		
maxNumberResource-CSI-RS-RLM	Not checked		
}			
}			
featureSets SEQUENCE {			
featureSetsDownlink SEQUENCE (SIZE (1..maxDownlinkFeatureSets)) OF FeatureSetDownlink {	i entries		
FeatureSetDownlink[i] SEQUENCE {	Not checked	entry i	
featureSetListPerDownlinkCC[i]	Not checked		
intraBandFreqSeparationDL	Not checked		
scalingFactor	Not checked		
crossCarrierScheduling-OtherSCS	Not checked		
scellWithoutSSB	Not checked		
csi-RS-MeasSCellWithoutSSB	Not checked		
dummy1	Not checked		
type1-3-CSS	Not checked		
pdccch-MonitoringAnyOccasions	Not checked		
dummy2	Not checked		
ue-SpecificUL-DL-Assignment	Not checked		
searchSpaceSharingCA-DL	Not checked		
timeDurationForQCL SEQUENCE {			
scs-60kHz	Not checked		
scs-120kHz	Not checked		
}			
pdsch-ProcessingType1-DifferentTB-PerSlot SEQUENCE {			
scs-15kHz	Not checked		
scs-30kHz	Not checked		
scs-60kHz	Not checked		
scs-120kHz	Not checked		
}			
dummy3	Not checked		
dummy4	Not checked		
dummy5	Not checked		
dummy6	Not checked		
dummy7	Not checked		
}			
}			
}			
featureSetsDownlinkPerCC SEQUENCE (SIZE (1..maxPerCC-FeatureSets)) OF FeatureSetDownlinkPerCC {	i entries		
FeatureSetDownlinkPerCC[i] SEQUENCE {		entry i	
supportedSubcarrierSpacingDL	Not checked	SubcarrierSpacing	
supportedBandwidthDL	Not checked	SupportedBandwidth	
channelBW-90mhz	Not checked		
maxNumberMIMO-LayersPDSCCH	Not checked	MIMO-LayersDL	
supportedModulationOrderDL	Not checked	ModulationOrder	
}			
}			
featureSetsUplink SEQUENCE (SIZE (1..maxUplinkFeatureSets)) OF FeatureSetUplink {	i entries		
FeatureSetUplink[i] SEQUENCE {		entry i	
featureSetListPerUplinkCC	Not checked		
scalingFactor	Not checked		
crossCarrierScheduling-OtherSCS	Not checked		
intraBandFreqSeparationUL	Not checked		

searchSpaceSharingCA-UL	Not checked		
dummy1	Not checked		
supportedSRS-Resources	Not checked	SRS-Resources	
twoPUCCH-Group	Not checked		
dynamicSwitchSUL	Not checked		
simultaneousTxSUL-NonSUL	Not checked		
pusch-ProcessingType1-DifferentTB-PerSlot			
SEQUENCE {			
scs-15kHz	Not checked		
scs-30kHz	Not checked		
scs-60kHz	Not checked		
scs-120kHz	Not checked		
}			
dummy2	Not checked		
}			
}			
featureSetsUplinkPerCC SEQUENCE (SIZE (1..maxPerCC-FeatureSets)) OF FeatureSetUplinkPerCC {	i entries		
FeatureSetUplinkPerCC[i] SEQUENCE {		entry i	
supportedSubcarrierSpacingUL	Not checked	SubcarrierSpacing	
supportedBandwidthUL	Not checked	SupportedBandwidth	
channelBW-90mHz	Not checked		
mimo-CB-PUSCH SEQUENCE {			
maxNumberMIMO-LayersCB-PUSCH	Checked	MIMO-LayersUL	pc_nrMIMO_CB_PUSCH
maxNumberSRS-ResourcePerSet	Not checked		
}			
maxNumberMIMO-LayersNonCB-PUSCH	Checked	MIMO-LayersUL	pc_nrMIMO_NonCB_PUSCH
supportedModulationOrderUL	Not checked	ModulationOrder	
}			
}			
}			
featureSetsDownlink-v1540 SEQUENCE (SIZE (1..maxDownlinkFeatureSets)) OF FeatureSetDownlink-v1540 {	i entries		
FeatureSetDownlink-v1540[i] SEQUENCE {		entry i	
oneFL-DMRS-TwoAdditionalDMRS-DL	Not checked		
additionalDMRS-DL-Alt	Not checked		
twoFL-DMRS-TwoAdditionalDMRS-DL	Not checked		
oneFL-DMRS-ThreeAdditionalDMRS-DL	Not checked		
pdcc-MonitoringAnyOccasionsWithSpanGap			
SEQUENCE {			
scs-15kHz	Not checked		
scs-30kHz	Not checked		
scs-60kHz	Not checked		
scs-120kHz	Not checked		
}			
pdsch-SeparationWithGap	Not checked		
pdsch-ProcessingType2 SEQUENCE {			
scs-15kHz	Not checked		
scs-30kHz	Not checked		
scs-60kHz	Not checked		
}			
pdsch-ProcessingType2-Limited SEQUENCE {			
differentTB-PerSlot-SCS-30kHz	Not checked		
}			
dl-MCS-TableAlt-DynamicIndication	Not checked		
}			
}			
featureSetsUplink-v1540 SEQUENCE (SIZE (1..maxUplinkFeatureSets)) OF FeatureSetUplink-v1540 {	i entries		
FeatureSetUplink-v1540[i] SEQUENCE {		entry i	

zeroSlotOffsetAperiodicSRS	Not checked		
pa-PhaseDiscontinuityImpacts	Not checked		
pusch-SeparationWithGap	Not checked		
pusch-ProcessingType2 SEQUENCE {			
scs-15kHz	Not checked		
scs-30kHz	Not checked		
scs-60kHz	Not checked		
}			
ul-MCS-TableAlt-DynamicIndication	Not checked		
}			
featureSetsUplinkPerCC-v1540 SEQUENCE (SIZE (1..maxPerCC-FeatureSets)) OF FeatureSetUplinkPerCC-v1540 {	i entries		
FeatureSetUplinkPerCC-v1540[i] SEQUENCE {		entry i	
mimo-NonCB-PUSCH SEQUENCE {			
maxNumberSRS-ResourcePerSet	Not checked		
maxNumberSimultaneousSRS-ResourceTx	Not checked		
}			
}			
}			
featureSetCombinations SEQUENCE (SIZE (1..maxFeatureSetCombinations)) OF FeatureSetCombination {	i entries		
FeatureSetCombination[i] SEQUENCE (SIZE (1..maxSimultaneousBands)) OF FeatureSetsPerBand {	ii entries	entry i	
FeatureSetsPerBand[i][j] SEQUENCE (SIZE (1..maxFeatureSetsPerBand)) OF FeatureSet {	iii entries	entry ii	
FeatureSet[i][j] CHOICE {		entry iii	
eutra SEQUENCE {			
downlinkSetEUTRA	Not checked	FeatureSetEUTRA-DownlinkId	
uplinkSetEUTRA	Not checked	FeatureSetEUTRA-UplinkId	
}			
nr SEQUENCE {			
downlinkSetNR	Not checked	FeatureSetDownlinkId	
uplinkSetNR	Not checked	FeatureSetUplinkId	
}			
}			
}			
}			
}			
lateNonCriticalExtension	Not checked		
nonCriticalExtension SEQUENCE {			
fdd-Add-UE-NR-Capabilities-v1530 SEQUENCE {			
eutra-ParametersXDD-Diff SEQUENCE {			
rsrqMeasWidebandEUTRA	Not checked		
}			
}			
tdd-Add-UE-NR-Capabilities-v1530 SEQUENCE {			
eutra-ParametersXDD-Diff SEQUENCE {			
rsrqMeasWidebandEUTRA	Not checked		
}			
}			
}			
dummy	Not checked		
interRAT-Parameters SEQUENCE {			
eutra SEQUENCE {			
supportedBandListEUTRA SEQUENCE (SIZE (1..maxBandsEUTRA)) OF FreqBandIndicatorEUTRA	Not checked		
eutra-ParametersCommon SEQUENCE {			
mfb-EUTRA	Not checked		

modifiedMRP-BehaviorEUTRA	Not checked		
multiNS-Pmax-EUTRA	Not checked		
rs-SINR-MeasEUTRA	Not checked		
}			
eutra-ParametersXDD-Diff SEQUENCE {			
rsrqMeasWidebandEUTRA	Not checked		
}			
}			
inactiveState	Not checked		
delayBudgetReporting	Not checked		
nonCriticalExtension SEQUENCE {	Not checked		
sdap-Parameters SEQUENCE {			
as-ReflectiveQoS	Checked		pc_as_ReflectiveQoS
}			
overheatingInd	Not checked		
ims-Parameters SEQUENCE {			
ims-ParametersCommon SEQUENCE {			
voiceOverEUTRA-5GC	Not checked		
}			
ims-ParametersFRX-Diff SEQUENCE {			
voiceOverNR	Not checked		
}			
}			
fr1-Add-UE-NR-Capabilities-v1540 SEQUENCE {			
ims-ParametersFRX-Diff SEQUENCE {			
voiceOverNR	Not checked		
}			
}			
fr2-Add-UE-NR-Capabilities-v1540 SEQUENCE {			
ims-ParametersFRX-Diff SEQUENCE {			
voiceOverNR	Not checked		
}			
}			
fr1-fr2-Add-UE-NR-Capabilities SEQUENCE {			
phy-ParametersFRX-Diff SEQUENCE {			
dynamicSFI	Not checked		
dummy1	Not checked		
twoFL-DMRS	Not checked		
dummy2	Not checked		
dummy3	Not checked		
supportedDMRS-TypeDL	Not checked		
supportedDMRS-TypeUL	Not checked		
semiOpenLoopCSI	Not checked		
csi-ReportWithoutPMI	Not checked		
csi-ReportWithoutCQI	Not checked		
onePortsPTRS	Not checked		
twoPUCCH-F0-2-ConsecSymbols	Not checked		
pucch-F2-WithFH	Not checked		
pucch-F3-WithFH	Not checked		
pucch-F4-WithFH	Not checked		
freqHoppingPUCCH-F0-2	Not checked		
freqHoppingPUCCH-F1-3-4	Not checked		
mux-SR-HARQ-ACK-CSI-PUCCH-MultiPerSlot	Not checked		
uci-CodeBlockSegmentation	Not checked		
onePUCCH-LongAndShortFormat	Not checked		
twoPUCCH-AnyOthersInSlot	Not checked		
intraSlotFreqHopping-PUSCH	Not checked		
pusch-LBRM	Not checked		
pdccch-BlindDetectionCA	Not checked		
tpc-PUSCH-RNTI	Not checked		
tpc-PUCCH-RNTI	Not checked		
tpc-SRS-RNTI	Not checked		
absoluteTPC-Command	Not checked		

twoDifferentTPC-Loop-PUSCH	Not checked		
twoDifferentTPC-Loop-PUCCH	Not checked		
pusch-HalfPi-BPSK	Not checked		
pucch-F3-4-HalfPi-BPSK	Not checked		
almostContiguousCP-OFDM-UL	Not checked		
sp-CSI-RS	Not checked		
sp-CSI-IM	Not checked		
tdd-MultiDL-UL-SwitchPerSlot	Not checked		
multipleCORESET	Not checked		
csi-RS-IM-ReceptionForFeedback	Not checked	CSI-RS-IM- eceptionForFeedb ack	
csi-RS-ProcFrameworkForSRS	Not checked	CSI-RS- ProcFrameworkFo rSRS	
csi-ReportFramework	Not checked	CSI- ReportFramework	
mux-SR-HARQ-ACK-CSI-PUCCH-OncePerSlot SEQUENCE {			
sameSymbol	Not checked		
diffSymbol	Not checked		
}			
mux-SR-HARQ-ACK-PUCCH	Not checked		
mux-MultipleGroupCtrlICH-Overlap	Not checked		
dl-SchedulingOffset-PDSCH-TypeA	Not checked		
dl-SchedulingOffset-PDSCH-TypeB	Not checked		
ul-SchedulingOffset	Not checked		
dl-64QAM-MCS-TableAlt	Not checked		
ul-64QAM-MCS-TableAlt	Not checked		
cqi-TableAlt	Not checked		
oneFL-DMRS-TwoAdditionalDMRS-UL	Not checked		
twoFL-DMRS-TwoAdditionalDMRS-UL	Not checked		
oneFL-DMRS-ThreeAdditionalDMRS-UL	Not checked		
}			
measAndMobParametersFRX-Diff SEQUENCE {			
ss-SINR-Meas	Not checked		
csi-RSRP-AndRSRQ-MeasWithSSB	Checked (NOTE 3)		pc_csi- RSRP- AndRSRQ- MeasWithSS B
csi-RSRP-AndRSRQ-MeasWithoutSSB	Not checked		
csi-SINR-Meas	Not checked		
csi-RS-RLM	Not checked		
handoverInterF	Not checked		
handoverLTE	Not checked		
handover-eLTE	Not checked		
maxNumberResource-CSI-RS-RLM	Not checked		
}			
}			
nonCriticalExtension SEQUENCE {}	Not checked		
}			
<p>Note 1: If the UE is single mode (FDD or TDD), or the UE is dual mode (FDD and TDD) and <i>intraAndInterF-MeasAndReport</i> is supported in both modes, then support of <i>intraAndInterF-MeasAndReport</i> will be signaled in <i>measAndMobParameters/measAndMobParametersXDD-Diff</i>. If the UE is dual mode (FDD + TDD) and <i>intraAndInterF-MeasAndReport</i> is only supported in one mode, then support of <i>intraAndInterF-MeasAndReport</i> will be signaled in one of <i>fdd-Add-UE-NR-Capabilities/measAndMobParametersXDD-Diff</i> or <i>tdd-Add-UE-NR-Capabilities/measAndMobParametersXDD-Diff</i> as appropriate.)</p> <p>Note 2: If the UE is single mode (FDD or TDD), or the UE is dual mode (FDD and TDD) and <i>eventA-MeasAndReport</i> is supported in both modes, then support of <i>eventA-MeasAndReport</i> will be signaled in <i>measAndMobParameters/measAndMobParametersXDD-Diff</i>. If the UE is dual mode (FDD + TDD) and <i>eventA-MeasAndReport</i> is only supported in one mode, then support of <i>eventA-MeasAndReport</i> will be signaled in one of <i>fdd-Add-UE-NR-Capabilities/measAndMobParametersXDD-Diff</i> or <i>tdd-Add-UE-NR-</i></p>			

- Capabilities/measAndMobParametersXDD-Diff as appropriate.
- Note 3: If the UE supports single frequency range (FR1 or FR2), or the UE supports both frequency ranges (FR1 and FR2) and *csi-RSRP-AndRSRQ-MeasWithSSB* is supported in both frequency ranges, then support of *csi-RSRP-AndRSRQ-MeasWithSSB* will be signaled in *measAndMobParameters/MeasAndMobParametersFRX-Diff*.
If the UE supports both frequency ranges (FR1 + FR2) and *csi-RSRP-AndRSRQ-MeasWithSSB* is only supported in one frequency range, then support of *csi-RSRP-AndRSRQ-MeasWithSSB* will be signaled in one of *fr1-Add-UE-NR-Capabilities/measAndMobParametersFRX-Diff* or *fr2-Add-UE-NR-Capabilities/measAndMobParametersFRX-Diff* as appropriate.)
- Note 4: If the UE is single mode (FDD or TDD), or the UE is dual mode (FDD and TDD) and *skipUplinkTxDynamic* is supported in both modes, then support of *skipUplinkTxDynamic* will be signaled in *mac-Parameters/mac-ParametersXDD-Diff*.
If the UE is dual mode (FDD + TDD) and *skipUplinkTxDynamic* is only supported in one mode, then *skipUplinkTxDynamic* will be signaled in one of *fdd-Add-UE-NR-Capabilities/mac-ParametersXDD-Diff* or *tdd-Add-UE-NR-Capabilities/mac-ParametersXDD-Diff* as appropriate.
- Note 5: If the UE is single mode (FDD or TDD), or the UE is dual mode (FDD and TDD) and *logicalChannelSR-DelayTimer* is supported in both modes, then support of *logicalChannelSR-DelayTimer* will be signaled in *mac-Parameters/mac-ParametersXDD-Diff*.
If the UE is dual mode (FDD + TDD) and *logicalChannelSR-DelayTimer* is only supported in one mode, then support of *logicalChannelSR-DelayTimer* will be signaled in one of *fdd-Add-UE-NR-Capabilities/mac-ParametersXDD-Diff* or *tdd-Add-UE-NR-Capabilities/mac-ParametersXDD-Diff* as appropriate.
- Note 6: If the UE is single mode (FDD or TDD), or the UE is dual mode (FDD and TDD) and *pc_longDRX_Cycle* is supported in both modes, then support of *pc_longDRX_Cycle* will be signaled in *mac-Parameters/mac-ParametersXDD-Diff*.
If the UE is dual mode (FDD + TDD) and *pc_longDRX_Cycle* is only supported in one mode, then support of *pc_longDRX_Cycle* will be signaled in one of *fdd-Add-UE-NR-Capabilities/mac-ParametersXDD-Diff* or *tdd-Add-UE-NR-Capabilities/mac-ParametersXDD-Diff* as appropriate.
- Note 7: If the UE is single mode (FDD or TDD), or the UE is dual mode (FDD and TDD) and *pc_shortDRX_Cycle* is supported in both modes, then support of *pc_shortDRX_Cycle* will be signaled in *mac-Parameters/mac-ParametersXDD-Diff*.
If the UE is dual mode (FDD + TDD) and *pc_shortDRX_Cycle* is only supported in one mode, then support of *pc_shortDRX_Cycle* will be signaled in one of *fdd-Add-UE-NR-Capabilities/mac-ParametersXDD-Diff* or *tdd-Add-UE-NR-Capabilities/mac-ParametersXDD-Diff* as appropriate.
- Note 8: If the UE supports FR2 and *pc_pdsch_256QAM_FR2* is supported, then support of *pdsch_256QAM_FR2* will be signaled in at least one entry of *supportedBandListNR* as appropriate.
- Note 9: If *pc_pusch_256QAM_FR1* or *pc_pusch_256QAM_FR2* is supported, then support of *pusch-256QAM* will be signaled in at least one entry of *supportedBandListNR* as appropriate.

Table 8.2.1.1.1.3.3-7: UE-MRDC-Capability (Table 8.2.1.1.1.3.3-5)

Derivation Path: TS 38.508-1 [4], Table 4.6.4-48			
Information Element	Value/remark	Comment	Condition
UE-MRDC-Capability ::= SEQUENCE {			
measAndMobParametersMRDC SEQUENCE {			
measAndMobParametersMRDC-Common			
SEQUENCE {			
independentGapConfig	Checked		pc_independ entGapConfi g
}			
measAndMobParametersMRDC-XDD-Diff			
SEQUENCE {			
sftd-MeasPSCell	Not checked		
sftd-MeasNR-Cell	Not checked		
}			
measAndMobParametersMRDC-FRX-Diff			
SEQUENCE {			
simultaneousRxDataSSB-DiffNumerology	Not checked		
}			
}			
phy-ParametersMRDC-v1530 SEQUENCE {			
naics-Capability-List SEQUENCE (SIZE	i entries		
(1..maxNrofNAICS-Entries)) OF NAICS-Capability-	Not checked		
Entry {			
NAICS-Capability-Entry[i] SEQUENCE {		entry i	
numberOfNAICS-CapableCC	Not checked		
numberOfAggregatedPRB	Not checked		
}			
}			
rf-ParametersMRDC SEQUENCE {			
supportedBandCombinationList SEQUENCE {	i entries		
(SIZE (1..maxBandComb)) OF BandCombination {			
BandCombination[i] SEQUENCE {		entry i	
bandList SEQUENCE (SIZE	i entries		
(1..maxSimultaneousBands)) OF BandParameters {	Not checked		
BandParameters[j] CHOICE		entry i	
eutra SEQUENCE {		EUTRA bands	
bandEUTRA	Not checked	FreqBandIndicator EUTRA	
ca-BandwidthClassDL-EUTRA	Not checked	CA- BandwidthClassE UTRA	
ca-BandwidthClassUL-EUTRA	Not checked	CA- BandwidthClassE UTRA	
}			
nr SEQUENCE {		NR bands	
bandNR	Not checked	FreqBandIndicator NR	
ca-BandwidthClassDL-NR	Not checked	CA- BandwidthClassN R	
ca-BandwidthClassUL-NR	Not checked	CA- BandwidthClassN R	
}			
}			
}			
featureSetCombination	Not checked	FeatureSetCombi nationId	
ca-ParametersEUTRA	Not checked	CA- ParametersEUTR A	
ca-ParametersNR	Not checked	CA-	

			_Path
splitDRB-withUL-Both-MCG-SCG	Checked (NOTE 2)		pc_splitDRB _withUL_Bo h_MCG_SC G
srb3	Checked (NOTE 1)		pc_srb3
v2x-EUTRA	Not checked		
}			
fdd-Add-UE-MRDC-Capabilities SEQUENCE {			
measAndMobParametersMRDC-XDD-Diff			
SEQUENCE {			
sftd-MeasPSCell	Not checked		
sftd-MeasNR-Cell	Not checked		
}			
generalParametersMRDC-XDD-Diff SEQUENCE {			
splitSRB-WithOneUL-Path	Checked (NOTE 1)		pc_splitSRB _WithOneUL _Path
splitDRB-withUL-Both-MCG-SCG	Checked (NOTE 2)		pc_splitDRB _withUL_Bo h_MCG_SC G
srb3	Checked (NOTE 3)		pc_srb3
v2x-EUTRA-v1530	Not checked		
}			
}			
tdd-Add-UE-MRDC-Capabilities SEQUENCE {			
measAndMobParametersMRDC-XDD-Diff			
SEQUENCE {			
sftd-MeasPSCell	Not checked		
sftd-MeasNR-Cell	Not checked		
}			
generalParametersMRDC-XDD-Diff SEQUENCE {			
splitSRB-WithOneUL-Path	Checked (NOTE 1)		pc_splitSRB _WithOneUL _Path
splitDRB-withUL-Both-MCG-SCG	Checked (NOTE 2)		pc_splitDRB _withUL_Bo h_MCG_SC G
srb3	Checked (NOTE 3)		pc_srb3
v2x-EUTRA-v1530	Not checked		
}			
}			
fr1-Add-UE-MRDC-Capabilities SEQUENCE {			
measAndMobParametersMRDC-FRX-Diff			
SEQUENCE {			
simultaneousRxDataSSB-DiffNumerology	Not checked		
}			
}			
fr2-Add-UE-MRDC-Capabilities SEQUENCE {			
measAndMobParametersMRDC-FRX-Diff			
SEQUENCE {			
simultaneousRxDataSSB-DiffNumerology	Not checked		
}			
}			
featureSetCombinations SEQUENCE (SIZE (1..maxFeatureSetCombinations)) OF FeatureSetCombination {	i entries Not checked	FeatureSetCombination	
FeatureSetCombination[i] SEQUENCE (SIZE (1..maxSimultaneousBands)) OF FeatureSetsPerBand {	ii entries	entry i	
FeatureSetsPerBand[iii] SEQUENCE (SIZE (1..maxFeatureSetsPerBand)) OF FeatureSet {	iii entries	entry ii	
FeatureSet[iiii] CHOICE {		entry iii	
eutra SEQUENCE {		EUTRA bands	

downlinkSetEUTRA	Not checked		
uplinkSetEUTRA	Not checked		
}			
nr SEQUENCE {		NR bands	
downlinkSetNR	Not checked		
uplinkSetNR	Not checked		
}			
}			
}			
}			
}			
pdcp-ParametersMRDC-v1530 SEQUENCE {			
pdcp-DuplicationSplitSRB	Not checked		
pdcp-DuplicationSplitDRB	Not checked		
}			
lateNonCriticalExtension	Not checked		
nonCriticalExtension SEQUENCE { }	Not checked		
}			
Note 1:	If the UE is single mode (FDD or TDD), or the UE is dual mode (FDD and TDD) and <i>splitSRB-WithOneUL-Path</i> is supported in both modes, then support of <i>splitSRB-WithOneUL-Path</i> will be signaled in generalParametersMRDC/generalParametersMRDC-XDD-Diff. If the UE is dual mode (FDD + TDD) and <i>splitSRB-WithOneUL-Path</i> is only supported in one mode, then support of <i>splitSRB-WithOneUL-Path</i> will be signaled in one of fdd-Add-UE-MRDC-Capabilities/generalParametersMRDC-XDD-Diff or tdd-Add-UE-MRDC-Capabilities/generalParametersMRDC-XDD-Diff as appropriate.		
Note 2:	If the UE is single mode (FDD or TDD), or the UE is dual mode (FDD and TDD) and <i>splitDRB-withUL-Both-MCG-SCG</i> is supported in both modes, then support of <i>splitDRB-withUL-Both-MCG-SCG</i> will be signaled in generalParametersMRDC/generalParametersMRDC-XDD-Diff. If the UE is dual mode (FDD + TDD) and <i>splitDRB-withUL-Both-MCG-SCG</i> is only supported in one mode, then support of <i>splitDRB-withUL-Both-MCG-SCG</i> will be signaled in one of fdd-Add-UE-MRDC-Capabilities/generalParametersMRDC-XDD-Diff or tdd-Add-UE-MRDC-Capabilities/generalParametersMRDC-XDD-Diff as appropriate.		
Note 3:	If the UE is single mode (FDD or TDD), or the UE is dual mode (FDD and TDD) and <i>srb3</i> is supported in both modes, then support of <i>srb3</i> will be signaled in generalParametersMRDC/generalParametersMRDC-XDD-Diff. If the UE is dual mode (FDD + TDD) and <i>srb3</i> is only supported in one mode, then support of <i>srb3</i> will be signaled in one of fdd-Add-UE-MRDC-Capabilities/generalParametersMRDC-XDD-Diff or tdd-Add-UE-MRDC-Capabilities/generalParametersMRDC-XDD-Diff as appropriate.		
Note 4:	If <i>pc_dynamicPowerSharing</i> is supported, then support of <i>dynamicPowerSharing</i> will be signaled in at least one entry of supportedBandCombinationList as appropriate.		

8.2.1.2 Void

8.2.2 Radio Bearer Addition, Modification and Release

8.2.2.1 Radio Bearer Addition, Modification and Release / SRB

8.2.2.1.1 SRB3 Establishment, Reconfiguration and Release / NR addition, modification and release / EN-DC

8.2.2.1.1.1 Test Purpose (TP)

(1)

```
with { UE in RRC_CONNECTED state with EN-DC, and, MCG(s) (E-UTRA PDCP) and SCG }
ensure that {
  when { UE receives an RRCConnectionReconfiguration message to add SRB3 }
  then { UE establishes SRB3 and sends an RRCConnectionReconfigurationComplete message on SRB1 }
}
```

(2)

```

with { UE in RRC_CONNECTED state with EN-DC, and, MCG(s) (E-UTRA PDCP) and SCG and SRB3 configured }
ensure that {
  when { UE receives an RRCReconfiguration message on SRB3 including secondaryCellGroup to
reconfigure NR MAC }
  then { UE sends RRCReconfigurationComplete message on SRB3 }
}

```

(3)

```

with { UE in RRC_CONNECTED state with EN-DC, and, MCG(s) (E-UTRA PDCP) and SCG and SRB3 configured }
ensure that {
  when { UE receives an RRCReconfiguration message on SRB3 including radioBearerConfig to
reconfigure NR PDCP }
  then { UE sends RRCReconfigurationComplete message on SRB3 }
}

```

(4)

```

with { UE in RRC_CONNECTED state with EN-DC, and, MCG(s) (E-UTRA PDCP) and SCG }
ensure that {
  when { UE receives an RRCConnectionReconfiguration message to release SRB3 }
  then { UE releases SRB3 and sends an RRCConnectionReconfigurationComplete message on SRB1 }
}

```

8.2.2.1.1.2 Conformance requirements

References: The conformance requirements covered in the present test case are specified in: TS 36.331, clause 5.3.5.3, TS 38.331, clauses 5.3.5.1, 5.3.5.3, 5.3.5.5.1, 5.3.5.5.3, 5.3.5.5.4, 5.3.5.5.8, 5.3.5.5.9, 5.3.5.6.1, 5.3.5.6.2 and 5.3.5.6.3. Unless otherwise stated these are Rel-15 requirements.

[TS 36.331, 5.3.5.3]

- 1> if the received RRCConnectionReconfiguration includes the *nr-Config* and it is set to *release*: or
- 1> if the received RRCConnectionReconfiguration includes *endc-ReleaseAndAdd*:
 - 2> perform ENDC release as specified in TS38.331 [82], clause 5.3.5.10;
 - ...
- 1> if the received RRCConnectionReconfiguration includes the *nr-SecondaryCellGroupConfig*:
 - 2> perform NR RRC Reconfiguration as specified in TS 38.331 [82], clause 5.3.5.3;
- 1> if the received RRCConnectionReconfiguration includes the *nr-RadioBearerConfig1*:
 - 2> perform radio bearer configuration as specified in TS 38.331 [82], clause 5.3.5.6;
- 1> if the received RRCConnectionReconfiguration includes the *nr-RadioBearerConfig2*:
 - 2> perform radio bearer configuration as specified in TS 38.331 [82], clause 5.3.5.6;
 - ...
- 1> set the content of *RRCCConnectionReconfigurationComplete* message as follows:
 - 2> if the received *RRCCConnectionReconfiguration* message included *nr-SecondaryCellGroupConfig*:
 - 3> include *scg-ConfigResponseNR* in accordance with TS 38.331 [82], clause 5.3.5.3;
- 1> submit the *RRCCConnectionReconfigurationComplete* message to lower layers for transmission using the new configuration, upon which the procedure ends;

[TS 38.331, 5.3.5.1]

In (NG)EN-DC and NR-DC, SRB3 can be used for measurement configuration and reporting, to (re-)configure MAC, RLC, physical layer and RLF timers and constants of the SCG configuration, and to reconfigure PDCP

for DRBs associated with the S-K_{gNB} or SRB3, and to reconfigure SDAP for DRBs associated with S-K_{gNB} in (NG)EN-DC and NR-DC, provided that the (re-)configuration does not require any MN involvement. In EN-DC, only *measConfig*, *radioBearerConfig* and/or *secondaryCellGroup* are included in *RRCReconfiguration* received via SRB3.

[TS 38.331, 5.3.5.3]

The UE shall perform the following actions upon reception of the *RRCReconfiguration*:

- 1> if the *RRCReconfiguration* includes the *secondaryCellGroup*:
 - 2> perform the cell group configuration for the SCG according to 5.3.5.5;
 - ...
- 1> if the UE is configured with E-UTRA *nr-SecondaryCellGroupConfig* (MCG is E-UTRA):
 - 2> if *RRCReconfiguration* was received via SRB1:
 - 3> construct *RRCReconfigurationComplete* message and submit it via the EUTRA MCG embedded in E-UTRA RRC message *RRCCConnectionReconfigurationComplete* as specified in TS 36.331 [10];
 - ...
 - 2> else (*RRCReconfiguration* was received via SRB3):
 - 3> submit the *RRCReconfigurationComplete* message via SRB3 to lower layers for transmission using the new configuration;

NOTE: In the case of SRB1, the random access is triggered by RRC layer itself as there is not necessarily other UL transmission. In the case of SRB3, the random access is triggered by the MAC layer due to arrival of *RRCReconfigurationComplete*.

[TS 38.331, 5.3.5.5.1]

The UE performs the following actions based on a received *CellGroupConfig* IE:

- ...
- 1> if the *CellGroupConfig* contains the *rlc-BearerToReleaseList*:
 - 2> perform RLC bearer release as specified in 5.3.5.5.3;
- 1> if the *CellGroupConfig* contains the *rlc-BearerToAddModList*:
 - 2> perform the RLC bearer addition/modification as specified in 5.3.5.5.4;
- 1> if the *CellGroupConfig* contains the *mac-CellGroupConfig*:
 - 2> configure the MAC entity of this cell group as specified in 5.3.5.5.5;
- 1> if the *CellGroupConfig* contains the *sCellToReleaseList*:
 - 2> perform SCell release as specified in 5.3.5.5.8;
 - ...
- 1> if the *CellGroupConfig* contains the *sCellToAddModList*:
 - 2> perform SCell addition/modification as specified in 5.3.5.5.9.

[TS 38.331, 5.3.5.5.3]

- 1> for each *logicalChannelIdentity* value included in the *rlc-BearerToReleaseList* that is part of the current UE configuration (LCH release); or
- 1> for each *logicalChannelIdentity* value that is to be released as the result of an SCG release according to 5.3.5.4:

- 2> release the RLC entity or entities as specified in TS 38.322 [4, clause 5.1.3];
- 2> release the corresponding logical channel.

[TS 38.331, 5.3.5.5.4]

For each *RLC-Bearer-Config* received in the *rlc-BearerToAddModList* IE the UE shall:

- 1> if the UE's current configuration contains a RLC bearer with the received *logicalChannelIdentity*:
 - ...
 - 2> reconfigure the RLC entity or entities in accordance with the received *rlc-Config*;

[TS 38.331, 5.3.5.5.8]

The UE shall:

- 1> if the release is triggered by reception of the *sCellToReleaseList*:
 - 2> for each *sCellIndex* value included in the *sCellToReleaseList*:
 - 3> if the current UE configuration includes an SCell with value *sCellIndex*:
 - 4> release the SCell.

[TS 38.331, 5.3.5.5.9]

The UE shall:

- 1> for each *sCellIndex* value included in the *sCellToAddModList* that is not part of the current UE configuration (SCell addition):
 - 2> add the SCell, corresponding to the *sCellIndex*, in accordance with the *sCellConfigCommon* and *sCellConfigDedicated*;
 - 2> configure lower layers to consider the SCell to be in deactivated state;
 - ...
- 1> for each *sCellIndex* value included in the *sCellToAddModList* that is part of the current UE configuration (SCell modification):
 - 2> modify the SCell configuration in accordance with the *sCellConfigDedicated*.

[TS 38.331, 5.3.5.6.1]

The UE shall perform the following actions based on a received *RadioBearerConfig* IE:

- 1> if the *RadioBearerConfig* includes the *srb3-ToRelease* and set to true:
 - 2> perform the SRB release as specified in 5.3.5.6.2;
- 1> if the *RadioBearerConfig* includes the *srb-ToAddModList*:
 - 2> perform the SRB addition or reconfiguration as specified in 5.3.5.6.3;

[TS 38.331, 5.3.5.6.2]

The UE shall:

- 1> release the PDCP entity of the SRB3.

[TS 38.331, 5.3.5.6.3]

The UE shall:

- 1> for each *srb-Identity* value included in the *srb-ToAddModList* that is not part of the current UE configuration (SRB establishment or reconfiguration from E-UTRA PDCP to NR PDCP):

2> establish a PDCP entity and configure it with the security algorithms according to *securityConfig* and apply the keys (K_{RRCenc} and K_{RRCint}) associated with the master key ($K_{\text{eNB}}/ K_{\text{gNB}}$) or secondary key ($S\text{-}K_{\text{gNB}}$) as indicated in *keyToUse*, if applicable;

...

2> if the *pdcp-Config* is included:

3> configure the PDCP entity in accordance with the received *pdcp-Config*;

8.2.2.1.1.3 Test description

8.2.2.1.1.3.1 Pre-test conditions

System Simulator:

- E-UTRA Cell 1 is the PCell and NR Cell 1 is the PSCell
- System Information combination as defined in TS 38.508-1 [4] clause 4.4.3.1.1 is used in E-UTRA Cell 1 and NR Cell 1.

UE:

- None.

Preamble:

- The UE is in state RRC_CONNECTED using generic procedure parameter Connectivity (*EN-DC*) and DC bearers (*MCG(s) and SCG*) according to TS 38.508-1 [4], Table 4.5.1-1.

8.2.2.1.1.3.2 Test procedure sequence

Table 8.2.2.1.1.3.2-1: Main behaviour

St	Procedure	Message Sequence		TP	Verdict
		U - S	Message		
1	The SS transmits an <i>RRCConnectionReconfiguration</i> message containing NR <i>RRCReconfiguration</i> message to add SRB3 sent on SRB1/E-UTRA Cell 1.	<--	<i>RRCConnectionReconfiguration</i> (<i>RRCReconfiguration</i>)	-	-
2	Check: Does the UE transmit an <i>RRCConnectionReconfigurationComplete</i> message containing NR <i>RRCReconfigurationComplete</i> message on SRB1/E-UTRA Cell 1?	-->	<i>RRCConnectionReconfigurationComplete</i> (<i>RRCReconfigurationComplete</i>)	1	P
3	The SS transmits an <i>RRCReconfiguration</i> message to reconfigure NR MAC sent on SRB3/NR Cell 1.	<--	<i>RRCReconfiguration</i>	-	-
4	Check: Does the UE transmit an <i>RRCReconfigurationComplete</i> message on SRB3/NR Cell 1?	-->	<i>RRCReconfigurationComplete</i>	2	P
5	The SS transmits an <i>RRCReconfiguration</i> message to reconfigure NR PDCP sent on SRB3/NR Cell 1.	<--	<i>RRCReconfiguration</i>	-	-
6	Check: Does the UE transmit an <i>RRCReconfigurationComplete</i> message on SRB3/NR Cell 1?	-->	<i>RRCReconfigurationComplete</i>	3	P
7	The SS transmits an <i>RRCConnectionReconfiguration</i> message to release SRB3 sent on SRB1/E-UTRA Cell 1.	<--	<i>RRCConnectionReconfiguration</i>	-	-
8	Check: Does the UE transmit an <i>RRCConnectionReconfigurationComplete</i> message on SRB1/E-UTRA Cell 1?	-->	<i>RRCConnectionReconfigurationComplete</i>	4	P
9	The SS releases the RRC connection.	-	-	-	-

8.2.2.1.1.3.3 Specific message contents

Table 8.2.2.1.1.3.3-1: RRCConnectionReconfiguration (step 1, Table 8.2.2.1.1.3.2-1)

Derivation Path: 36.508 [7], Table 4.6.1-8 with condition EN-DC_EmbedNR_RRCRecon and EN-DC_Embed_RBConfig			
Information Element	Value/remark	Comment	Condition
RRCConnectionReconfiguration ::= SEQUENCE {			
criticalExtensions CHOICE {			
c1 CHOICE {			
rrcConnectionReconfiguration-r8 SEQUENCE {			
nonCriticalExtension SEQUENCE {			
nonCriticalExtension SEQUENCE {			
nonCriticalExtension SEQUENCE {			
nonCriticalExtension SEQUENCE {			
nonCriticalExtension SEQUENCE {			
nonCriticalExtension SEQUENCE {			
nonCriticalExtension SEQUENCE {			
nr-Config-r15	OCTET STRING including the RRCReconfiguration message according to table 8.2.2.1.1.3.3-1A.		
nr-RadioBearerConfig1-r15	RadioBearerConfig according to 38.508-1 [4] Table 4.6.3-132 with condition SRB3		
}			
}			
}			
}			
}			
}			
}			
}			
}			
}			
}			

Table 8.2.2.1.1.3.3-1A: RRCReconfiguration (Table 8.2.2.1.1.3.3-1)

Derivation Path: 38.508-1 [4], Table 4.6.1-13			
Information Element	Value/remark	Comment	Condition
RRCReconfiguration ::= SEQUENCE {			
criticalExtensions CHOICE {			
rrcReconfiguration SEQUENCE {			
secondaryCellGroup	OCTET STRING containing CellGroupConfig according to Table 8.2.2.1.1.3.3-1B.		
}			
}			
}			

Table 8.2.2.1.1.3.3-1B: CellGroupConfig (Table 8.2.2.1.1.3.3-1A)

Derivation Path: 38.508-1 [4], Table 4.6.3-19			
Information Element	Value/remark	Comment	Condition
CellGroupConfig ::= SEQUENCE {			
cellGroupId	1		
rlc-BearerToAddModList SEQUENCE (SIZE(1..maxLC-ID)) OF RLC-BearerConfig {	1 entry		
RLC-Bearer-Config[1] SEQUENCE {		entry 1	
logicalChannelIdentity	3		
servedRadioBearer CHOICE {			
srb-Identity	3		
}			
}			
mac-CellGroupConfig	Not Present		
physicalCellGroupConfig	Not Present		
spCellConfig	Not Present		
}			

Table 8.2.2.1.1.3.3-2: RRCReconfiguration (step 3, Table 8.2.2.1.1.3.2-1)

Derivation Path: 38.508-1 [4], Table 4.6.1-13			
Information Element	Value/remark	Comment	Condition
RRCReconfiguration ::= SEQUENCE {			
criticalExtensions CHOICE {			
rrcReconfiguration SEQUENCE {			
secondaryCellGroup	OCTET STRING containing CellGroupConfig according to Table 8.2.2.1.1.3.3-3.		
}			
}			
}			

Table 8.2.2.1.1.3.3-3: CellGroupConfig (Table 8.2.2.1.1.3.3-2)

Derivation Path: 38.508-1 [4], Table 4.6.3-19			
Information Element	Value/remark	Comment	Condition
CellGroupConfig ::= SEQUENCE {			
cellGroupId	1		
rlc-BearerToAddModList	Not present		
rlc-BearerToReleaseList	Not present		
mac-CellGroupConfig	MAC-CellGroupConfig according to table 8.2.2.1.1.3.3-3a		
physicalCellGroupConfig	Not present		
spCellConfig	Not present		
}			

Table 8.2.2.1.1.3.3-3a: MAC-CellGroupConfig (Table 8.2.2.1.1.3.3-3)

Derivation Path: TS 38.508-1 [4], Table 4.6.3-68			
Information Element	Value/remark	Comment	Condition
MAC-CellGroupConfig ::= SEQUENCE {			
drx-config	Not present.		
schedulingRequestConfig	Not present.		
bsr-Config SEQUENCE {			
periodicBSR-Timer	sf5		
retxBSR-Timer	sf40		
}			
tag-Config	Not present.		
phr-Config	Not present.		
skipUplinkTxDynamic	Not present.		
}			

Table 8.2.2.1.1.3.3-4: RRCReconfiguration (step 5, Table 8.2.2.1.1.3.2-1)

Derivation Path: 38.508-1 [4], Table: 4.6.1-13			
Information Element	Value/remark	Comment	Condition
RRCReconfiguration ::= SEQUENCE {			
criticalExtensions CHOICE {			
rrcReconfiguration SEQUENCE {			
radioBearerConfig	RadioBearerConfig	Table 8.2.2.1.1.3.3-4B	
}			
}			
}			

Table 8.2.2.1.1.3.3-4A: PDCP-Config (Table 8.2.2.1.1.3.3-4B)

Derivation Path: 38.508-1 [4], Table: 4.6.3-99 with condition SRB			
Information Element	Value/remark	Comment	Condition
PDCP-Config ::= SEQUENCE {			
t-Reordering	ms20		
}			

Table 8.2.2.1.1.3.3-4B: RadioBearerConfig (Table 8.2.2.1.1.3.3-4)

Derivation Path: TS 38.508-1 [4], Table 4.6.3-132 with condition SRB3			
Information Element	Value/remark	Comment	Condition
RadioBearerConfig ::= SEQUENCE {			
srb-ToAddModList SEQUENCE (SIZE (1..2)) OF SRB-ToAddMod {	1 entry		
SRB-ToAddMod[1] SEQUENCE {			
pdcP-Config SEQUENCE {	PDCP-Config		
}			
}			
securityConfig	Not present		
}			

Table 8.2.2.1.1.3.3-5: Void

Table 8.2.2.1.1.3.3-6: RRCConnectionReconfiguration (step 7, Table 8.2.2.1.1.3.2-1)

Derivation Path: 36.508 [7], Table 4.6.1-8 with condition EN-DC_EmbedNR_RRCRecon and EN-DC_Embed_RBConfig			
Information Element	Value/remark	Comment	Condition
RRCConnectionReconfiguration ::= SEQUENCE {			
criticalExtensions CHOICE {			
c1 CHOICE{			
rrcConnectionReconfiguration-r8 SEQUENCE {			
nonCriticalExtension SEQUENCE {			
nonCriticalExtension SEQUENCE {			
nonCriticalExtension SEQUENCE {			
nonCriticalExtension SEQUENCE {			
nonCriticalExtension SEQUENCE {			
nonCriticalExtension SEQUENCE {			
nonCriticalExtension SEQUENCE {			
nonCriticalExtension SEQUENCE {			
nr-Config-r15 CHOICE {}	OCTET STRING including the RRCReconfiguration message according to table 8.2.2.1.1.3.3-8.		
nr-RadioBearerConfig1-r15	RadioBearerConfig according to Table 8.2.2.1.1.3.3-7		
}			
}			
}			
}			
}			
}			
}			
}			
}			
}			
}			

Table 8.2.2.1.1.3.3-7: RadioBearerConfig (Table 8.2.2.1.1.3.3-6)

Derivation Path: 38.508-1 [4], Table 4.6.3-132			
Information Element	Value/remark	Comment	Condition
RadioBearerConfig ::= SEQUENCE {			
srb3-ToRelease	true		
securityConfig	Not present		
}			

Table 8.2.2.1.1.3.3-8: RRCReconfiguration (Table 8.2.2.1.1.3.3-6)

Derivation Path: 38.508-1 [4], Table 4.6.1-13			
Information Element	Value/remark	Comment	Condition
RRCReconfiguration ::= SEQUENCE {			
criticalExtensions CHOICE {			
rrcReconfiguration SEQUENCE {			
secondaryCellGroup	OCTET STRING containing CellGroupConfig according to Table 8.2.2.1.1.3.3-9.		
}			
}			

Table 8.2.2.1.1.3.3-9: *CellGroupConfig* (Table 8.2.2.1.1.3.3-8)

Derivation Path: 38.508-1 [4], Table 4.6.3-19			
Information Element	Value/remark	Comment	Condition
CellGroupConfig ::= SEQUENCE {			
cellGroupId	1		
rlc-BearerToAddModList	Not Present		
rlc-BearerToReleaseList SEQUENCE (SIZE(1..maxLC-ID)) OF LogicalChannelIdentity {	1 entry		
logicalChannelIdentity[1]	3	entry 1	
}			
mac-CellGroupConfig SEQUENCE {	Not Present		
tag-Config	Not Present		
phr-Config	Not Present		
}			
physicalCellGroupConfig	Not Present		
rlf-TimersAndConstants	Not Present		
}			

8.2.2.1.2 SRB3 Establishment, Reconfiguration and Release / NR addition, modification and release / NR-DC

8.2.2.1.2.1 Test Purpose (TP)

(1)

```
with { UE in NR RRC_CONNECTED state with NR-DC }
ensure that {
  when { UE receives an RRCReconfiguration message to establish SRB3 }
  then { UE establishes SRB3 and sends an RRCReconfigurationComplete message on SRB1 }
}
```

(2)

```
with { UE in NR RRC_CONNECTED state with NR-DC and SRB3 configured }
ensure that {
  when { UE receives an RRCReconfiguration message on SRB3 to reconfigure NR MAC of the SCG }
  then { UE reconfigures NR MAC and sends RRCReconfigurationComplete message on SRB3 }
}
```

(3)

```
with { UE in NR RRC_CONNECTED state with NR-DC and SRB3 configured }
ensure that {
  when { UE receives an RRCReconfiguration message on SRB3 to reestablish NR PDCP of the SCG }
  then { UE reestablishes NR PDCP and sends RRCReconfigurationComplete message on SRB3 }
}
```

(4)

```
with { UE in NR RRC_CONNECTED state with NR-DC and SRB3 configured }
ensure that {
  when { UE receives an RRCReconfiguration message to release SRB3 }
  then { UE releases SRB3 and sends an RRCReconfigurationComplete message on SRB1 }
}
```

8.2.2.1.2.2 Conformance requirements

References: The conformance requirements covered in the present test case are specified in: TS 38.331, clauses 5.3.5.3, 5.3.5.5.1, 5.3.5.5.3, 5.3.5.5.4, 5.3.5.5.8, 5.3.5.5.9, 5.3.5.6.1, 5.3.5.6.2 and 5.3.5.6.3. Unless otherwise stated these are Rel-15 requirements.

[TS 38.331, 5.3.5.3]

The UE shall perform the following actions upon reception of the *RRCReconfiguration*:

...

1> if the *RRCReconfiguration* includes the *secondaryCellGroup*:

2> perform the cell group configuration for the SCG according to 5.3.5.5;

1> if the *RRCReconfiguration* includes the *mrdc-SecondaryCellGroupConfig*:

2> if the *mrdc-SecondaryCellGroupConfig* is set to *setup*:

3> if the *mrdc-SecondaryCellGroupConfig* includes *mrdc-ReleaseAndAdd*:

4> perform MR-DC release as specified in clause 5.3.5.10;

3> if the received *mrdc-SecondaryCellGroup* is set to *nr-SCG*:

4> perform the RRC reconfiguration according to 5.3.5.3 for the *RRCReconfiguration* message included in *nr-SCG*;

...

1> if the *RRCReconfiguration* message includes the *radioBearerConfig*:

2> perform the radio bearer configuration according to 5.3.5.6;

...

1> set the content of the *RRCReconfigurationComplete* message as follows:

...

2> if the *RRCReconfiguration* message includes the *mrdc-SecondaryCellGroupConfig* with *mrdc-SecondaryCellGroup* set to *nr-SCG*:

3> include in the *nr-SCG-Response* the *RRCReconfigurationComplete* message;

...

1> else if the *RRCReconfiguration* message was received within the *nr-SCG* within *mrdc-SecondaryCellGroup* (UE in NR-DC, *mrdc-SecondaryCellGroup* was received in *RRCReconfiguration* via SRB1):

2> if *reconfigurationWithSync* was included in *spCellConfig* in *nr-SCG*:

3> initiate the Random Access procedure on the PSCell, as specified in TS 38.321 [3];

2> else

3> the procedure ends;

NOTE 2a: The order in which the UE sends the *RRCReconfigurationComplete* message and performs the Random Access procedure towards the SCG is left to UE implementation.

1> else if the *RRCReconfiguration* message was received via SRB3 (UE in NR-DC):

2> submit the *RRCReconfigurationComplete* message via SRB3 to lower layers for transmission using the new configuration;

1> else (*RRCReconfiguration* was received via SRB1):

2> submit the *RRCReconfigurationComplete* message via SRB1 to lower layers for transmission using the new configuration;

...

1> if *reconfigurationWithSync* was included in *spCellConfig* of an MCG or SCG, and when MAC of an NR cell group successfully completes a Random Access procedure triggered above;

2> stop timer T304 for that cell group;

- 2> apply the parts of the CSI reporting configuration, the scheduling request configuration and the sounding RS configuration that do not require the UE to know the SFN of the respective target SpCell, if any;
- 2> apply the parts of the measurement and the radio resource configuration that require the UE to know the SFN of the respective target SpCell (e.g. measurement gaps, periodic CQI reporting, scheduling request configuration, sounding RS configuration), if any, upon acquiring the SFN of that target SpCell;

...

[TS 38.331, 5.3.5.1]

In (NG)EN-DC and NR-DC, SRB3 can be used for measurement configuration and reporting, to (re-)configure MAC, RLC, physical layer and RLF timers and constants of the SCG configuration, and to reconfigure PDCP for DRBs associated with the $S-K_{\text{gNB}}$ or SRB3, and to reconfigure SDAP for DRBs associated with $S-K_{\text{gNB}}$ in (NG)EN-DC and NR-DC, provided that the (re-)configuration does not require any MN involvement. In EN-DC, only *measConfig*, *radioBearerConfig* and/or *secondaryCellGroup* are included in *RRCReconfiguration* received via SRB3.

[TS 38.331, 5.3.5.5.1]

The UE performs the following actions based on a received *CellGroupConfig* IE:

...

- 1> if the *CellGroupConfig* contains the *rlc-BearerToReleaseList*:
 - 2> perform RLC bearer release as specified in 5.3.5.5.3;
- 1> if the *CellGroupConfig* contains the *rlc-BearerToAddModList*:
 - 2> perform the RLC bearer addition/modification as specified in 5.3.5.5.4;
- 1> if the *CellGroupConfig* contains the *mac-CellGroupConfig*:
 - 2> configure the MAC entity of this cell group as specified in 5.3.5.5.5;
- 1> if the *CellGroupConfig* contains the *sCellToReleaseList*:
 - 2> perform SCell release as specified in 5.3.5.5.8;

...

- 1> if the *CellGroupConfig* contains the *sCellToAddModList*:
 - 2> perform SCell addition/modification as specified in 5.3.5.5.9.

[TS 38.331, 5.3.5.5.3]

- 1> for each *logicalChannelIdentity* value included in the *rlc-BearerToReleaseList* that is part of the current UE configuration (LCH release); or
- 1> for each *logicalChannelIdentity* value that is to be released as the result of an SCG release according to 5.3.5.4:
 - 2> release the RLC entity or entities as specified in TS 38.322 [4, clause 5.1.3];
 - 2> release the corresponding logical channel.

[TS 38.331, 5.3.5.5.4]

For each *RLC-Bearer-Config* received in the *rlc-BearerToAddModList* IE the UE shall:

- 1> if the UE's current configuration contains a RLC bearer with the received *logicalChannelIdentity*:
 - ...
 - 2> reconfigure the RLC entity or entities in accordance with the received *rlc-Config*;

[TS 38.331, 5.3.5.5.8]

The UE shall:

- 1> if the release is triggered by reception of the *sCellToReleaseList*:
 - 2> for each *sCellIndex* value included in the *sCellToReleaseList*:
 - 3> if the current UE configuration includes an SCell with value *sCellIndex*:
 - 4> release the SCell.

[TS 38.331, 5.3.5.5.9]

The UE shall:

- 1> for each *sCellIndex* value included in the *sCellToAddModList* that is not part of the current UE configuration (SCell addition):
 - 2> add the SCell, corresponding to the *sCellIndex*, in accordance with the *sCellConfigCommon* and *sCellConfigDedicated*;
 - 2> configure lower layers to consider the SCell to be in deactivated state;
 - ...
- 1> for each *sCellIndex* value included in the *sCellToAddModList* that is part of the current UE configuration (SCell modification):
 - 2> modify the SCell configuration in accordance with the *sCellConfigDedicated*.

[TS 38.331, 5.3.5.6.1]

The UE shall perform the following actions based on a received *RadioBearerConfig* IE:

- 1> if the *RadioBearerConfig* includes the *srb3-ToRelease* and set to true:
 - 2> perform the SRB release as specified in 5.3.5.6.2;
- 1> if the *RadioBearerConfig* includes the *srb-ToAddModList*:
 - 2> perform the SRB addition or reconfiguration as specified in 5.3.5.6.3;

[TS 38.331, 5.3.5.6.2]

The UE shall:

- 1> release the PDCP entity of the SRB3.

[TS 38.331, 5.3.5.6.3]

The UE shall:

- 1> for each *srb-Identity* value included in the *srb-ToAddModList* that is not part of the current UE configuration (SRB establishment or reconfiguration from E-UTRA PDCP to NR PDCP):
 - 2> establish a PDCP entity and configure it with the security algorithms according to *securityConfig* and apply the keys (K_{RRCEnc} and K_{RRCint}) associated with the master key (K_{eNB}/ K_{gNB}) or secondary key ($S-K_{gNB}$) as indicated in *keyToUse*, if applicable;
 - ...
- 2> if the *pdc-Config* is included:
 - 3> configure the PDCP entity in accordance with the received *pdc-Config*;

8.2.2.1.2.3 Test description

8.2.2.1.2.3.1 Pre-test conditions

System Simulator:

- NR Cell 1 is the PCell and NR Cell 10 is the PSCell
- System information combination NR-4 as defined in TS 38.508-1 [4] clause 4.4.3.1.2 is used in NR cells.

UE:

- None.

Preamble:

- The UE is in state RRC_CONNECTED using generic procedure parameter Connectivity (*NR-DC*) and NR-DC bearers (*MCG(s) and SCG*) according to TS 38.508-1 [4], Table 4.5.1-1.

8.2.2.1.2.3.2 Test procedure sequence

Table 8.2.2.1.2.3.2-1: Main behaviour

St	Procedure	Message Sequence		TP	Verdict
		U - S	Message		
1	The SS transmits an <i>RRCReconfiguration</i> message via SRB1 to establish SRB3.	<--	NR RRC: <i>RRCReconfiguration</i>	-	-
2	Check: Does the UE transmit an <i>RRCReconfigurationComplete</i> message via SRB1?	-->	NR RRC: <i>RRCReconfigurationComplete</i>	1	P
3	The SS transmits an <i>RRCReconfiguration</i> message via SRB3 to reconfigure NR MAC.	<--	NR RRC: <i>RRCReconfiguration</i>	-	-
4	Check: Does the UE transmit an <i>RRCReconfigurationComplete</i> message via SRB3?	-->	NR RRC: <i>RRCReconfigurationComplete</i>	2	P
5	The SS transmits an <i>RRCReconfiguration</i> message via SRB3 to reconfigure PDCP.	<--	NR RRC: <i>RRCReconfiguration</i>	-	-
6	Check: Does the UE transmit an <i>RRCReconfigurationComplete</i> message via SRB3?	-->	NR RRC: <i>RRCReconfigurationComplete</i>	3	P
7	The SS transmits an <i>RRCReconfiguration</i> message via SRB1 to release SRB3.	<--	NR RRC: <i>RRCReconfiguration</i>	-	-
8	Check: Does the UE transmit an <i>RRCReconfigurationComplete</i> message via SRB1?	-->	NR RRC: <i>RRCConnectionReconfigurationComplete</i>	4	P

8.2.2.1.2.3.3 Specific message contents

Table 8.2.2.1.2.3.3-1: RRCReconfiguration (step 1, Table 8.2.2.1.2.3.2-1)

Derivation Path: TS 38.508-1 [4], Table 4.6.1-13 with condition NR-DC			
Information Element	Value/remark	Comment	Condition
RRCReconfiguration ::= SEQUENCE {			
criticalExtensions CHOICE {			
rrcReconfiguration SEQUENCE {			
radioBearerConfig	Not present		
nonCriticalExtension SEQUENCE {			
masterCellGroup	Not present		
nonCriticalExtension SEQUENCE {			
nonCriticalExtension SEQUENCE {			
mrdc-SecondaryCellGroupConfig CHOICE {			
setup SEQUENCE {			
mrdc-SecondaryCellGroup CHOICE {			
nr-SCG	RRCReconfiguration-SCG	Table 8.2.2.1.2.3.3-2	
}			
}			
}			
}			
radioBearerConfig2	RadioBearerConfig as per TS 38.508-1[4] Table 4.6.3-132 with condition SRB3		
}			
}			
}			

Table 8.2.2.1.2.3.3-2: RRCReconfiguration-SCG (Table 8.2.2.1.2.3.3-1)

Derivation Path: TS 38.508-1 [4], Table 4.6.1-13 with condition NR-DC_SCG			
Information Element	Value/remark	Comment	Condition
RRCReconfiguration ::= SEQUENCE {			
criticalExtensions CHOICE {			
rrcReconfiguration SEQUENCE {			
radioBearerConfig	Not present		
secondaryCellGroup	CellGroupConfig	Table 8.2.2.1.2.3.3-3	
}			
}			

Table 8.2.2.1.2.3.3-3: CellGroupConfig (Table 8.2.2.1.2.3.3-2)

Derivation Path: 38.508-1 [4], Table 4.6.3-19			
Information Element	Value/remark	Comment	Condition
CellGroupConfig ::= SEQUENCE {			
cellGroupId	CellGroupId as per TS 38.508-1[4] Table 4.6.3-20 with condition NR-DC_SCG		
rlc-BearerToAddModList SEQUENCE (SIZE(1..maxLC-ID)) OF BearerConfig {	1 entry		
RLC-Bearer-Config[1]	RLC-BearerConfig as per TS 38.508-1[4] Table 4.6.3-148 with condition SRB3	entry 1	
}			
mac-CellGroupConfig	Not Present		
physicalCellGroupConfig	Not Present		
spCellConfig	Not Present		
}			

Table 8.2.2.1.2.3.3-3A: RRCReconfigurationComplete (Steps 2/8, Table 4.5.4.2-5)

Derivation Path: TS 38.508-1, table 4.6.1-14 with condition NR-SCG

Table 8.2.2.1.2.3.3-4: RRCReconfiguration (step 3, Table 8.2.2.1.2.3.2-1)

Derivation Path: TS 38.508-1 [4], Table 4.6.1-13 with condition NR-DC_SCG			
Information Element	Value/remark	Comment	Condition
RRCReconfiguration ::= SEQUENCE {			
criticalExtensions CHOICE {			
rrcReconfiguration SEQUENCE {			
secondaryCellGroup	CellGroupConfig	Table 8.2.2.1.2.3.3-5	
}			
}			
}			

Table 8.2.2.1.2.3.3-5: CellGroupConfig (Table 8.2.2.1.2.3.3-2)

Derivation Path: 38.508-1 [4], Table 4.6.3-19			
Information Element	Value/remark	Comment	Condition
CellGroupConfig ::= SEQUENCE {			
cellGroupId	CellGroupId as per TS 38.508-1[4] Table 4.6.3-20 with condition NR-DC_SCG		
rlc-BearerToAddModList	Not present		
rlc-BearerToReleaseList	Not present		
mac-CellGroupConfig	MAC-CellGroupConfig as per TS 38.508-1[4] Table 4.6.3-68 with condition DRX		
physicalCellGroupConfig	Not present		
spCellConfig	Not present		
}			

Table 8.2.2.1.2.3.3-6: RRCReconfiguration (step 5, Table 8.2.2.1.2.3.2-1)

Derivation Path: 38.508-1 [4], Table 4.6.1-13			
Information Element	Value/remark	Comment	Condition
RRCReconfiguration ::= SEQUENCE {			
criticalExtensions CHOICE {			
rrcReconfiguration ::= SEQUENCE {			
radioBearerConfig	RadioBearerConfig	Table 8.2.2.1.2.3.3-7	
}			
}			
}			

Table 8.2.2.1.2.3.3-7: RadioBearerConfig (Table 8.2.2.1.2.3.3-6)

Derivation Path: TS 38.508-1 [4], Table 4.6.3-132 with condition SRB3			
Information Element	Value/remark	Comment	Condition
RadioBearerConfig ::= SEQUENCE {			
srb-ToAddModList SEQUENCE (SIZE (1..2)) OF SRB-ToAddMod {	1 entry		
SRB-ToAddMod[1] SEQUENCE {			
reestablishPDCP	true		
}			
}			
securityConfig	Not present		
}			

Table 8.2.2.1.2.3.3-8: Void**Table 8.2.2.1.2.3.3-9: RRCReconfiguration (step 7, Table 8.2.2.1.2.3.2-1)**

Derivation Path: 38.508-1 [4], Table 4.6.1-13 with condition NR-DC			
Information Element	Value/remark	Comment	Condition
RRCReconfiguration ::= SEQUENCE {			
criticalExtensions CHOICE {			
rrcReconfiguration SEQUENCE {			
radioBearerConfig	Not present		
nonCriticalExtension SEQUENCE {			
masterCellGroup	Not present		
nonCriticalExtension SEQUENCE {			
nonCriticalExtension SEQUENCE {			
mrdc-SecondaryCellGroupConfig CHOICE {			
setup SEQUENCE {			
mrdc-ReleaseAndAdd	true		
mrdc-SecondaryCellGroup CHOICE {			
nr-SCG	RRCReconfiguration- SCG	Table 8.2.2.1.2.3.3-10	
}			
}			
}			
radioBearerConfig2	RadioBearerConfig	Table 8.2.2.1.2.3.3-11	
}			
}			
}			
}			
}			

Table 8.2.2.1.2.3.3-10: RRCReconfiguration-SCG (Table 8.2.2.1.2.3.3-9)

Derivation Path: TS 38.508-1 [4], Table 4.6.1-13 with condition NR-DC_SCG			
Information Element	Value/remark	Comment	Condition
RRCReconfiguration ::= SEQUENCE {			
criticalExtensions CHOICE {			
rrcReconfiguration SEQUENCE {			
radioBearerConfig	Not present		
secondaryCellGroup	CellGroupConfig	Table 8.2.2.1.2.3.3-12	
}			
}			
}			

Table 8.2.2.1.2.3.3-11: RadioBearerConfig (Table 8.2.2.1.2.3.3-10)

Derivation Path: 38.508-1 [4], Table 4.6.3-132			
Information Element	Value/remark	Comment	Condition
RadioBearerConfig ::= SEQUENCE {			
srb3-ToRelease	true		
securityConfig	Not present		
}			

Table 8.2.2.1.2.3.3-12: CellGroupConfig (Table 8.2.2.1.2.3.3-10)

Derivation Path: 38.508-1 [4], Table 4.6.3-19 with condition NR-DC_SCG			
Information Element	Value/remark	Comment	Condition
CellGroupConfig ::= SEQUENCE {			
rlc-BearerToAddModList	Not Present		
rlc-BearerToReleaseList SEQUENCE (SIZE(1..maxLC-ID)) OF LogicalChannelIdentity {	1 entry		
logicalChannelIdentity[1]	LogicalChannelIdentity as per TS 38.508-1[4] Table 4.6.3-67 with condition SRB3	entry 1	
}			
}			

8.2.2.2 Split SRB Establishment and Release

8.2.2.2.1 Split SRB Establishment and Release / EN-DC

8.2.2.2.1.1 Test Purpose (TP)

(1)

```
with { UE in RRC_CONNECTED state with EN-DC, and, MCG(s) (E-UTRA PDCP) and SCG }
ensure that {
  when { UE receives an RRCConnectionReconfiguration message on SRB1 to configure split SRB1 and
split SRB2 with PDCP duplication activated }
  then { UE configures the split SRBs and sends an RRCConnectionReconfigurationComplete message on
split SRB1 with the PDCP PDU duplicated on the MCG and SCG path }
}
```

(2)

```
with { UE in RRC_CONNECTED state with EN-DC, and, MCG(s) (E-UTRA PDCP) and SCG and split SRB
configured }
ensure that {
  when { UE receives an RRCConnectionReconfiguration message on split SRB1 over the SCG path to
release split SRB1 and split SRB2 }
}
```

```

    then { UE releases split SRB1 and split SRB2 and sends an RRCCConnectionReconfigurationComplete
message on SRB1 over the MCG path}
    }

```

(3)

```

with { UE in RRC_CONNECTED state in EN-DC mode with split SRB1 and split SRB2 configured with PDCP
duplication }
ensure that {
    when { UE receives a UECapabilityEnquiry on split SRB1 over the SCG path }
    then { UE replies with UECapabilityInformation on split SRB1 duplicated on the MCG and SCG path}
}

```

(4)

```

with { UE in RRC_CONNECTED state in EN-DC mode with split SRB1 and split SRB2 configured with PDCP
duplication }
ensure that {
    when { UE receives a IDENTITY REQUEST on split SRB2 over the SCG path }
    then { UE replies with IDENTITY RESPONSE on split SRB2 duplicated on the MCG and SCG path}
}

```

8.2.2.2.1.2 Conformance requirements

References: The conformance requirements covered in the present TC are specified in: TS 36.331, clause 5.3.5.3 and TS 38.331: clauses 5.3.5.3, 5.3.5.5.3, 5.3.5.6.1 and 5.3.5.6.3. Unless and otherwise stated these are Rel-15 requirements

[TS 36.331, clause 5.3.5.3]

If the *RRCCConnectionReconfiguration* message does not include the *mobilityControlInfo* and the UE is able to comply with the configuration included in this message, the UE shall:

...

1> if the received *RRCCConnectionReconfiguration* includes the *nr-SecondaryCellGroupConfig*:

2> perform NR RRC Reconfiguration as specified in TS 38.331 [82], clause 5.3.5.3;

1> if the received *RRCCConnectionReconfiguration* includes the *nr-RadioBearerConfig1*:

2> perform radio bearer configuration as specified in TS 38.331 [82], clause 5.3.5.6;

1> if the received *RRCCConnectionReconfiguration* includes the *nr-RadioBearerConfig2*:

2> perform radio bearer configuration as specified in TS 38.331 [82], clause 5.3.5.6;

...

1> set the content of *RRCCConnectionReconfigurationComplete* message as follows:

...

2> if the received *RRCCConnectionReconfiguration* message included *nr-SecondaryCellGroupConfig*:

3> include *scg-ConfigResponseNR* in accordance with TS 38.331 [82], clause 5.3.5.3;

1> submit the *RRCCConnectionReconfigurationComplete* message to lower layers for transmission using the new configuration, upon which the procedure ends;

[TS 38.331, clause 5.3.5.3]

The UE shall perform the following actions upon reception of the *RRCCReconfiguration*:

1> if the *RRCCReconfiguration* includes the *secondaryCellGroup*:

2> perform the cell group configuration for the SCG according to 5.3.5.5;

1> if the *RRCCReconfiguration* message contains the *radioBearerConfig*:

2> perform the radio bearer configuration according to 5.3.5.6;

...

1> if the UE is configured with E-UTRA *nr-SecondaryCellGroupConfig* (MCG is E-UTRA):

2> if *RRCReconfiguration* was received via SRB1:

3> submit the *RRCReconfigurationComplete* via the E-UTRA MCG embedded in E-UTRA RRC message *RRCConnectionReconfigurationComplete* as specified in TS 36.331 [10];

[TS 38.331, clause 5.3.5.5.3]

The UE shall:

1> for each *logicalChannelIdentity* value included in the *rlc-BearerToReleaseList* that is part of the current UE configuration (LCH release); or

1> for each *logicalChannelIdentity* value that is to be released as the result of an SCG release according to 5.3.5.4:

2> release the RLC entity or entities as specified in TS 38.322 [4], clause 5.1.3;

2> release the corresponding logical channel

[TS 38.331, clause 5.3.5.6.1]

The UE shall perform the following actions based on a received *RadioBearerConfig* IE:

...

1> if the *RadioBearerConfig* includes the *srb-ToAddModList*:

2> perform the SRB addition or reconfiguration as specified in 5.3.5.6.3;

[TS 38.331, clause 5.3.5.6.3]

The UE shall:

1> for each *srb-Identity* value included in the *srb-ToAddModList* that is not part of the current UE configuration (SRB establishment or reconfiguration from E-UTRA PDCP to NR PDCP):

2> establish a PDCP entity;

2> if AS security has been activated:

3> if target RAT of handover is E-UTRA/5GC, or;

3> if the UE is only connected to E-UTRA/5GC:

4> configure the PDCP entity with the security algorithms and keys (K_{RRCEnc} and K_{RRCint}) configured/derived as specified in TS 36.331 [10];

3> else:

4> configure the PDCP entity with the security algorithms according to *securityConfig* and apply the keys (K_{RRCEnc} and K_{RRCint}) associated with the master key (K_{eNB}/K_{gNB}) or secondary key ($S-K_{gNB}$) as indicated in *keyToUse*, if applicable;

2> if the current UE configuration as configured by E-UTRA in TS 36.331 [10] includes an SRB identified with the same *srb-Identity* value:

3> associate the E-UTRA RLC entity and DCCH of this SRB with the NR PDCP entity;

3> release the E-UTRA PDCP entity of this SRB;

2> if the *pdcp-Config* is included:

3> configure the PDCP entity in accordance with the received *pdcp-Config*;

2> else:

3> configure the PDCP entity in accordance with the default configuration defined in 9.2.1 for the corresponding SRB;

8.2.2.2.1.3 Test description

8.2.2.2.1.3.1 Pre-test conditions

System Simulator:

- E-UTRA Cell 1 is the PCell and NR Cell 1 is the PSCell.

UE:

- None.

Preamble:

- The UE is in state RRC_CONNECTED using generic procedure parameter Connectivity (*EN-DC*), Bearers (MCG(*s*) and SCG) established according to TS 38.508-1 [4], clause 4.5.4.

8.2.2.2.1.3.2 Test procedure sequence

Table 8.2.2.2.1.3.2-1: Main behaviour

St	Procedure	Message Sequence		TP	Verdict
		U - S	Message		
0	The SS is configured not to send RLC ACK on split SRB1.	-	-	-	-
1	SS transmits <i>RRCCONNECTIONRECONFIGURATION</i> message containing NR <i>RRCCONNECTIONRECONFIGURATION</i> message to configure split SRB1 and split SRB2.	<--	<i>RRCCONNECTIONRECONFIGURATION</i> (<i>RRCCONNECTIONRECONFIGURATION</i>)	-	-
-	EXCEPTION: In parallel to the event described in step 2 the steps specified in Table 8.2.2.2.1.3.2-2 is taking place.	-	-	-	-
2	Check: Does the UE send a <i>RRCCONNECTIONRECONFIGURATIONCOMPLETE</i> message containing NR <i>RRCCONNECTIONRECONFIGURATIONCOMPLETE</i> message on split SRB1 duplicated over the SCG path? Note: The UE RLC might re-transmit this message several times (no more than <i>maxRetxThreshold</i>) until RLC ACK is sent by the SS.	-->	<i>RRCCONNECTIONRECONFIGURATIONCOMPLETE</i> (<i>RRCCONNECTIONRECONFIGURATIONCOMPLETE</i>)	1	P
2A	After steps in table 8.2.2.2.1.3.2-2 are completed the SS is configured to send RLC ACK on split SRB1 and the last message received in step 2 is acknowledged.	-	-	-	-
2B	The SS is configured not to send RLC ACK on split SRB1.	-	-	-	-
3	SS transmits <i>UECAPABILITYENQUIRY</i> message for NR capabilities on split SRB1 over the SCG path.	<--	<i>UECAPABILITYENQUIRY</i>	-	-
-	EXCEPTION: In parallel to the event described in step 4 the steps specified in Table 8.2.2.2.1.3.2-3 is taking place.	-	-	-	-
4	Check: Does the UE send <i>UECAPABILITYINFORMATION</i> message including UE radio access capability information for NR on split SRB1 duplicated over the SCG path? Note: The UE RLC might re-transmit this message several times (no more than <i>maxRetxThreshold</i>) until RLC ACK is sent by the SS.	-->	<i>UECAPABILITYINFORMATION</i>	3	P
4A	After steps in table 8.2.2.2.1.3.2-3 are completed the SS is configured to send RLC ACK on split SRB1 and the last message received in step 4 is acknowledged.	-	-	-	-
4B	The SS is configured not to send RLC ACK on split SRB2.	-	-	-	-
4C	The SS sends <i>DLINFORMATIONTRANSFER</i> message (carrying <i>IDENTITY REQUEST</i> message) on split SRB2 over the SCG path.	<--	<i>DLINFORMATIONTRANSFER</i> (<i>IDENTITY REQUEST</i>)	-	-
-	EXCEPTION: In parallel to the event described in step 4B the steps specified in Table 8.2.2.2.1.3.2-4 is taking place.	-	-	-	-
4D	Check: Does the UE send the <i>ULINFORMATIONMESSAGE</i> (carrying <i>IDENTITY RESPONSE</i> message) on split SRB2 duplicated over the SCG path? Note: The UE RLC might re-transmit this message several times (no more than <i>maxRetxThreshold</i>) until RLC ACK is sent by the SS.	-->	<i>DLINFORMATIONTRANSFER</i> (<i>IDENTITY RESPONSE</i>)	4	P

4E	After steps in table 8.2.2.2.1.3.2-4 are completed the SS is configured to send RLC ACK on split SRB2 and the last message received in step 4D is acknowledged.	-	-	-	-
5	SS transmits <i>RRCCONNECTIONRECONFIGURATION</i> message containing NR <i>RRCRECONFIGURATION</i> message on split SRB1 to release split SRB1 and split SRB2 over the SCG path.	<--	<i>RRCCONNECTIONRECONFIGURATION (RRCRECONFIGURATION)</i>	-	-
6	Check: Does the UE send <i>RRCCONNECTIONRECONFIGURATIONCOMPLETE</i> containing NR <i>RRCRECONFIGURATIONCOMPLETE</i> message on SRB1 over the MCG path? Note: The SS makes sure that the UE does not send any message on the SCG path. The SS sends the RLC ACK for this message.	-->	<i>RRCCONNECTIONRECONFIGURATIONCOMPLETE (RRCRECONFIGURATIONCOMPLETE)</i>	2	P

Table 8.2.2.2.1.3.2-2: Parallel behaviour

St	Procedure	Message Sequence		TP	Verdict
		U - S	Message		
1	The UE transmits an <i>RRCCONNECTIONRECONFIGURATIONCOMPLETE</i> message on SRB1 over the MCG path/E-UTRA Cell 1 Note: The UE RLC might re-transmit this message several times (no more than maxRetxThreshold) until RLC ACK is sent by the SS.	-->	<i>RRCCONNECTIONRECONFIGURATIONCOMPLETE (RRCRECONFIGURATIONCOMPLETE)</i>	-	-

Table 8.2.2.2.1.3.2-3: Parallel behaviour

St	Procedure	Message Sequence		TP	Verdict
		U - S	Message		
1	The UE transmits an <i>UECAPABILITYINFORMATION</i> message on SRB1 over the MCG path/E-UTRA Cell 1 Note: The UE RLC might re-transmit this message several times (no more than maxRetxThreshold) until RLC ACK is sent by the SS.	-->	<i>UECAPABILITYINFORMATION</i>	-	-

Table 8.2.2.2.1.3.2-3: Parallel behaviour

St	Procedure	Message Sequence		TP	Verdict
		U - S	Message		
1	The UE transmits an <i>DLINFORMATIONTRANSFER</i> (IDENTITY RESPONSE) message on SRB2 over the MCG path/E-UTRA Cell 1 Note: The UE RLC might re-transmit this message several times (no more than maxRetxThreshold) until RLC ACK is sent by the SS.	-->	<i>DLINFORMATIONTRANSFER (IDENTITY RESPONSE)</i>	-	-

8.2.2.2.1.3.3 Specific message contents

Table 8.2.2.2.1.3.3-1: RRCConnectionReconfiguration (step 1 Table 8.2.2.2.1.3.2-2)

Derivation Path: 36.508 [7], Table 4.6.1-8 with condition MCG_and_SCG and condition HO			
Information Element	Value/remark	Comment	Condition
RRCConnectionReconfiguration ::= SEQUENCE {			
criticalExtensions CHOICE {			
c1 CHOICE{			
rrcConnectionReconfiguration-r8 SEQUENCE {			
mobilityControlInfo	MobilityControlInfo-HO-SameCell	As per Table 8.2.2.2.1.3.3-1a	
nonCriticalExtension SEQUENCE {			
nonCriticalExtension SEQUENCE {			
nonCriticalExtension SEQUENCE {			
nonCriticalExtension SEQUENCE {			
nonCriticalExtension SEQUENCE {			
nonCriticalExtension SEQUENCE {			
nonCriticalExtension SEQUENCE {			
nr-Config-r15 CHOICE {			
setup SEQUENCE {			
nr-SecondaryCellGroupConfig-r15	OCTET STRING containing RRCReconfiguration-SplitSRB	As per Table 8.2.2.2.1.3.3-1	
}			
nr-RadioBearerConfig1-r15	OCTET STRING containing RadioBearerConfig-SplitSRB	As per Table 8.2.2.2.1.3.3-4	
}			
}			
}			
}			
}			
}			
}			
}			
}			
}			
}			
}			
}			
}			
}			
}			

Table 8.2.2.2.1.3.3-1a: MobilityControlInfo-HO-SameCell (Table 8.2.2.2.1.3.3-1)

Derivation Path: 36.508 [7], Table 4.6.5-1			
Information Element	Value/remark	Comment	Condition
MobilityControlInfo-HO ::= SEQUENCE {			
targetPhysCellId	PhysicalCellIdentity of E-UTRA Cell 1		
carrierFreq	Not present		
}			

Table 8.2.2.2.1.3.3-2: RRCReconfiguration-SplitSRB (Table 8.2.2.2.1.3.3-1)

Derivation Path: 38.508-1 [4], Table 4.6.1-13 with condition EN-DC			
Information Element	Value/remark	Comment	Condition
RRCReconfiguration ::= SEQUENCE {			
criticalExtensions CHOICE {			
rrcReconfiguration SEQUENCE {			
secondaryCellGroup	CellGroupConfig-SplitSRB		
}			
}			
}			

Table 8.2.2.2.1.3.3-3: CellGroupConfig-SplitSRB (Table 8.2.2.2.1.3.3-2)

Derivation Path: 38.508-1 [4], Table 4.6.3-8			
Information Element	Value/remark	Comment	Condition
CellGroupConfig ::= SEQUENCE {			
cellGroupId	1		
rlc-BearerToAddModList SEQUENCE (SIZE(1..maxLC-ID)) OF RLC-BearerConfig {	2 entries		
RLC-BearerConfig[1] SEQUENCE {		entry 1	
logicalChannelIdentity	1		
servedRadioBearer CHOICE {			
srb-Identity	1		
}			
reestablishRLC	Not present		
RLC-Config	Not present.		
mac-LogicalChannelConfig	Not present		
}			
RLC-BearerConfig[2] SEQUENCE {		entry 2	
logicalChannelIdentity	2		
servedRadioBearer CHOICE {			
srb-Identity	2		
}			
reestablishRLC	Not present		
RLC-Config	Not present		
mac-LogicalChannelConfig	Not present		
}			
}			
}			

Table 8.2.2.2.1.3.3-4: RadioBearerConfig-SplitSRB (step 1, Table 8.2.2.2.1.3.3-1)

Derivation Path: 38.508-1 [4], Table 4.6.3-132			
Information Element	Value/remark	Comment	Condition
RadioBearerConfig ::= SEQUENCE {			
srb-ToAddModList SEQUENCE (SIZE (1..2)) OF SRB-ToAddMod {	2 entries		
SRB-ToAddMod[1] SEQUENCE {		entry 1	
srb-Identity	1		
pdcp-Config	PDCCP-Config-SRB with condition SRB1		
}			
SRB-ToAddMod[2] SEQUENCE {		entry 2	
srb-Identity	2		
pdcp-Config	PDCCP-Config-SRB with condition SRB2		
}			
}			
}			

Table 8.2.2.2.1.3.3-5: PDCP-Config-SRB (Table 8.2.2.2.1.3.3-4)

Derivation Path: 38.508-1 [4], Table 4.6.3-99 with condition Split_SRB			
Information Element	Value/remark	Comment	Condition
PDCP-Config ::= SEQUENCE {			
moreThanOneRLC SEQUENCE {			
primaryPath SEQUENCE {			
logicalChannel	1		SRB1
logicalChannel	2		SRB2
}			
pdcp-Duplication	TRUE		
}			
}			

Table 8.2.2.2.1.3.3-6: Void**Table 8.2.2.2.1.3.3-7: RRCConnectionReconfigurationComplete (steps 2, 6, Table 8.2.2.2.1.3.2-2)**

Derivation Path: 36.508 [7], Table 4.6.1-9			
Information Element	Value/remark	Comment	Condition
RRCConnectionReconfigurationComplete ::= SEQUENCE {			
criticalExtensions CHOICE {			
rrcConnectionReconfigurationComplete-r8 SEQUENCE {			
nonCriticalExtension SEQUENCE {			
nonCriticalExtension SEQUENCE {			
nonCriticalExtension SEQUENCE {			
nonCriticalExtension SEQUENCE {			
nonCriticalExtension SEQUENCE {			
scg-ConfigResponseNR-r15	Present		
}			
}			
}			
}			
}			
}			

Table 8.2.2.2.1.3.3-8: UECapabilityEnquiry (step 3, Table 8.2.2.2.1.3.2-2)

Derivation Path: 36.508 [7], Table 4.6.1-22			
Information Element	Value/remark	Comment	Condition
UECapabilityEnquiry ::= SEQUENCE {			
ue-CapabilityRequest SEQUENCE (SIZE (1..maxRAT-Capabilities)) OF RAT-Type {	1 entry		
RAT-Type[1]	nr	entry 1	
}			
}			

Table 8.2.2.2.1.3.3-9: UECapabilityInformation (step 4, Table 8.2.2.2.1.3.2-2)

Derivation Path: 36.508 [7], Table 4.6.1-23			
Information Element	Value/remark	Comment	Condition
UECapabilityInformation ::= SEQUENCE {			
rrc-TransactionIdentifier	RRC-TransactionIdentifier-UL		
criticalExtensions CHOICE {			
c1 CHOICE{			
ueCapabilityInformation-r8 SEQUENCE {			
ue-CapabilityRAT-ContainerList SEQUENCE (SIZE (1..maxRAT-Capabilities)) OF CapabilityRAT-Container {	1 entry		
UE-CapabilityRAT-Container[1] SEQUENCE {		entry 1	
rat-Type	nr		
ueCapabilityRAT-Container	Not checked		
}			
}			
}			
}			
}			
}			

Table 8.2.2.2.1.3.3-10: RRCConnectionReconfiguration (step 5, Table 8.2.2.2.1.3.2-2)

Derivation Path: 36.508 [7], Table 4.6.1-8 condition MCG_and_split			
Information Element	Value/remark	Comment	Condition
RRCConnectionReconfiguration ::= SEQUENCE {			
criticalExtensions CHOICE {			
c1 CHOICE{			
rrcConnectionReconfiguration-r8 SEQUENCE {			
nonCriticalExtension SEQUENCE {			
nonCriticalExtension SEQUENCE {			
nonCriticalExtension SEQUENCE {			
nonCriticalExtension SEQUENCE {			
nonCriticalExtension SEQUENCE {			
nonCriticalExtension SEQUENCE {			
nr-Config-r15 CHOICE {			
setup SEQUENCE {			
nr-SecondaryCellGroupConfig-r15	<i>RRCReconfiguration-SplitSRBRelease</i>		
}			
}			
}			
}			
}			
}			
}			
}			
}			
}			

Table 8.2.2.2.1.3.3-11: RRCReconfiguration-SplitSRBRelease (Table 8.2.2.2.1.3.3-10)

Derivation Path: 38.508-1 [4], Table 4.6.1-13			
Information Element	Value/remark	Comment	Condition
RRCReconfiguration ::= SEQUENCE {			
criticalExtensions CHOICE {			
c1 CHOICE{			
rrcReconfiguration SEQUENCE {			
radioBearerConfig	Not present		
secondaryCellGroup	CellGroupConfig-SplitSRB-Release		
measConfig	Not Present		
}			
}			
}			
}			

Table 8.2.2.2.1.3.3-12: CellGroupConfig-SplitSRB-Release (Table 8.2.2.2.1.3.3-11)

Derivation Path: 38.508-1 [4], Table 4.6.3-8			
Information Element	Value/remark	Comment	Condition
CellGroupConfig ::= SEQUENCE {			
cellGroupId	1		
rlc-BearerToReleaseList SEQUENCE (SIZE(1..maxLC-ID)) OF LogicalChannelIdentity {	2 entries		
logicalChannelIdentity[1]	1	entry 1	
logicalChannelIdentity[2]	2	entry 2	
}			
}			

8.2.2.3 Simultaneous SRB3 and Split SRB / Sequential message flow on SRB3 and Split SRB

8.2.2.3.1 Simultaneous SRB3 and Split SRB / Sequential message flow on SRB3 and Split SRB with one UL path / EN-DC

8.2.2.3.1.1 Test Purpose (TP)

(1)

```
with { UE in E-UTRA RRC_CONNECTED state in EN-DC mode with SRB3 and split SRB1 configured with no PDCP duplication }
ensure that {
  when { UE receives RRCReconfiguration message on SRB3 to modify SCG DRB }
  then { UE sends RRCReconfigurationComplete message on SRB3 over the SCG path }
}
```

(2)

```
with { UE in RRC_CONNECTED state in EN-DC mode with SRB3 and split SRB1 configured with no PDCP duplication }
ensure that {
  when { UE receives an RRCConnectionReconfiguration message on split SRB1 on the SCG path to release SRB3 }
  then { UE releases SRB3 and sends an RRCConnectionReconfigurationComplete message on split SRB1 over the MCG path }
}
```

(3)

```
with { UE in RRC_CONNECTED state in EN-DC mode with split SRB1 configured with no PDCP duplication }
ensure that {
  when { UE receives an RRCConnectionReconfiguration message to release split SRB1 on SCG path }
}
```

```

    then { UE releases split SRB1 and sends an RRCConnectionReconfigurationComplete message on SRB1
over the MCG path }
}

```

8.2.2.3.1.2 Conformance requirements

References: The conformance requirements covered in the present TC are specified in: TS 37.340, clause 7.6, TS 36.331, clauses 5.3.5.3 and TS 38.331:5.3.5.3, 5.3.5.5, 5.3.5.5.3, 5.3.5.6, 5.3.5.6.2 and 5.3.5.6.3. Unless and otherwise stated these are Rel-15 requirements.

[TS 37.340, clause 7.6]

Split SRB is supported for both SRB1 and SRB2 (split SRB is not supported for SRB0 and SRB3) in all MR-DC cases. RRC PDUs on split SRB are ciphered and integrity protected using NR PDCP.

Split SRB can be configured by the MN in Secondary Node Addition and/or Modification procedure, with SN configuration part provided by the SN. A UE can be configured with both split SRB and SRB3 simultaneously. SRB3 and the SCG leg of split SRB can be independently configured.

For the split SRB, the selection of transmission path in downlink depends on network implementation. For uplink, the UE is configured via MN RRC signalling whether to use MCG path or duplicate the transmission on both MCG and SCG.

[TS 36.331, clause 5.3.5.3]

If the *RRCConnectionReconfiguration* message does not include the *mobilityControlInfo* and the UE is able to comply with the configuration included in this message, the UE shall:

...

1> if the received *RRCConnectionReconfiguration* includes the *nr-SecondaryCellGroupConfig*:

2> perform NR RRC Reconfiguration as specified in TS 38.331 [82], clause 5.3.5.3;

1> if the received *RRCConnectionReconfiguration* includes the *nr-RadioBearerConfig1*:

2> perform radio bearer configuration as specified in TS 38.331 [82], clause 5.3.5.6;

1> if the received *RRCConnectionReconfiguration* includes the *nr-RadioBearerConfig2*:

2> perform radio bearer configuration as specified in TS 38.331 [82], clause 5.3.5.6;

...

1> set the content of *RRCConnectionReconfigurationComplete* message as follows:

...

2> if the received *RRCConnectionReconfiguration* message included *nr-SecondaryCellGroupConfig*:

3> include *scg-ConfigResponseNR* in accordance with TS 38.331 [82], clause 5.3.5.3;

1> submit the *RRCConnectionReconfigurationComplete* message to lower layers for transmission using the new configuration, upon which the procedure ends;

[TS 38.331, clause 5.3.5.3]

The UE shall perform the following actions upon reception of the *RRCReconfiguration*:

...

1> if the *RRCReconfiguration* includes the *secondaryCellGroup*:

2> perform the cell group configuration for the SCG according to 5.3.5.5;

1> if the *RRCReconfiguration* message contains the *radioBearerConfig*:

2> perform the radio bearer configuration according to 5.3.5.6;

...

- 1> if the UE is configured with E-UTRA *nr-SecondaryCellGroupConfig* (MCG is E-UTRA):
 - 2> if *RRCReconfiguration* was received via SRB1:
 - 3> submit the *RRCReconfigurationComplete* via the EUTRA MCG embedded in E-UTRA RRC message *RRCConnectionReconfigurationComplete* as specified in TS 36.331 [10].

[TS 38.331, clause 5.3.5.5.3]

The UE shall:

- 1> for each *logicalChannelIdentity* value included in the *rlc-BearerToReleaseList* that is part of the current UE configuration (LCH release); or
- 1> for each *logicalChannelIdentity* value that is to be released as the result of an SCG release according to 5.3.5.4:
 - 2> release the RLC entity or entities as specified in TS 38.322 [4] clause 5.1.3;
 - 2> release the corresponding logical channel.

[TS 38.331, clause 5.3.5.6.1]

The UE shall perform the following actions based on a received *RadioBearerConfig* IE:

...

- 1> if the *RadioBearerConfig* includes the *srb-ToAddModList*:
 - 2> perform the SRB addition or reconfiguration as specified in 5.3.5.6.3;

[TS 38.331, clause 5.3.5.6.3]

The UE shall:

- 1> for each *srb-Identity* value included in the *srb-ToAddModList* that is not part of the current UE configuration (SRB establishment or reconfiguration from E-UTRA PDCP to NR PDCP):
 - 2> establish a PDCP entity and configure it with the security algorithms according to *securityConfig* and apply the keys (K_{RRCenc} and K_{RRCint}) associated with the master key (K_{eNB} / K_{gNB}) or secondary key ($S\text{-}K_{\text{gNB}}$) as indicated in *keyToUse*, if applicable;
 - 2> if the current UE configuration as configured by E-UTRA in TS 36.331 includes an SRB identified with the same *srb-Identity* value:
 - 3> associate the E-UTRA RLC entity and DCCH of this SRB with the NR PDCP entity;
 - 3> release the E-UTRA PDCP entity of this SRB;
 - 2> if the *pdcp-Config* is included:
 - 3> configure the PDCP entity in accordance with the received *pdcp-Config*;
 - 2> else:
 - 3> configure the PDCP entity in accordance with the default configuration defined in 9.2.1 for the corresponding SRB;

8.2.2.3.1.3 Test description

8.2.2.3.1.3.1 Pre-test conditions

System Simulator:

- E-UTRA Cell 1 is the PCell and NR Cell 1 is the PSCell.

- System Information combination as defined in TS 38.508-1 [4] clause 4.4.3.1.1 is used in E-UTRA Cell 1 and NR Cell 1.

UE:

- None.

Preamble:

- The UE is in state RRC_CONNECTED using generic procedure parameter Connectivity (*EN-DC*), bearers (MCG(*s*) and SCG) established according to TS 38.508-1 [4], clause 4.5.4.

8.2.2.3.1.3.2 Test procedure sequence

Table 8.2.2.3.1.3.2-1: Main behaviour

St	Procedure	Message Sequence		TP	Verdict
		U - S	Message		
1	The SS transmits on SRB1 over MCG path/E-UTRA Cell 1 an <i>RRCConnectionReconfiguration</i> message to configure SRB3, to reconfigure SRB1 to split SRB1 without PDCP duplication and to reconfigure SRB2 to change the PDCP type from EUTRA PDCP to NR PDCP.	<--	<i>RRCConnectionReconfiguration</i> (<i>RRCReconfiguration</i>)	-	-
2	UE transmits an <i>RRCConnectionReconfigurationComplete</i> message on split SRB1 over the MCG path/EUTRA Cell 1.	-->	<i>RRCConnectionReconfigurationComplete</i> (<i>RRCReconfigurationComplete</i>)	-	-
3	The SS transmits on SRB3/SCG an NR <i>RRCReconfiguration</i> message to reconfigure SCG DRB.	<--	<i>RRCReconfiguration</i>	-	-
4	Check: Does the UE transmit an NR <i>RRCReconfigurationComplete</i> message on SRB3/NR Cell 1?	-->	<i>RRCReconfigurationComplete</i>	1	P
5	The SS transmits over split SRB1 SCG path/NR Cell 1 an <i>RRCConnectionReconfiguration</i> message to release SRB3.	<--	<i>RRCConnectionReconfiguration</i> (<i>RRCReconfiguration</i>)	-	-
-	Void	-	-	-	-
6	Check: Does the UE transmits an <i>RRCConnectionReconfigurationComplete</i> message on split SRB1 over the MCG path/EUTRA Cell 1?	-->	<i>RRCConnectionReconfigurationComplete</i> (<i>RRCReconfigurationComplete</i>)	2	P
7	The SS transmits an <i>RRCConnectionReconfiguration</i> message to release SRB1 over SCG path/NR Cell 1.	<--	<i>RRCConnectionReconfiguration</i> (<i>RRCReconfiguration</i>)	-	-
8	Check: Does the UE transmits an <i>RRCConnectionReconfigurationComplete</i> message on SRB1 over the MCG path/E-UTRA Cell 1?	-->	<i>RRCConnectionReconfigurationComplete</i> (<i>RRCReconfigurationComplete</i>)	3	P

Table 8.2.2.3.1.3.2-2: Void

8.2.2.3.1.3.3 Specific message contents

Table 8.2.2.3.1.3.3-1: RRCConnectionReconfiguration (step 1, Table 8.2.2.3.1.3.2-1)

Derivation Path: 36.508 [7], Table 4.6.1-8			
Information Element	Value/remark	Comment	Condition
RRCConnectionReconfiguration ::= SEQUENCE {			
criticalExtensions CHOICE {			
c1 CHOICE{			
rrcConnectionReconfiguration-r8 SEQUENCE {			
mobilityControlInfo	MobilityControlInfo-HO-SameCell	As per Table 8.2.2.3.1.3.3-1E	
nonCriticalExtension SEQUENCE {			
nonCriticalExtension SEQUENCE {			
nonCriticalExtension SEQUENCE {			
nonCriticalExtension SEQUENCE {			
nonCriticalExtension SEQUENCE {			
nonCriticalExtension SEQUENCE {			
nonCriticalExtension SEQUENCE {			
nr-Config-r15 CHOICE {			
setup SEQUENCE {			
nr-SecondaryCellGroupConfig-r15	OCTET STRING including the RRCReconfiguration message and the IE secondaryCellGroup according table 8.2.2.3.1.3.3-1A		
}			
}			
sk-Counter-r15	Increment the value by 1 from the previous value		
nr-RadioBearerConfig1-r15	OCTET STRING including RadioBearerConfig according TS 38.508-1 [4], Table 4.6.3-132 with conditions EN-DC_DRB and Re-establish_PDCP and SRB3		
nr-RadioBearerConfig2-r15	RadioBearerConfig according to Table 8.2.2.3.1.3.3-1C		
}			
}			
}			
}			
}			
}			
}			
}			
}			
}			
}			
}			
}			
}			

Table 8.2.2.3.1.3.3-1A: RRCReconfiguration (Table 8.2.2.3.1.3.3-1)

Derivation Path: 38.508-1 [4], Table 4.6.1-13			
Information Element	Value/remark	Comment	Condition
RRCReconfiguration ::= SEQUENCE {			
criticalExtensions CHOICE {			
rrcReconfiguration SEQUENCE {			
secondaryCellGroup	OCTET STRING containing CellGroupConfig according to Table 8.2.2.3.1.3.3-1B.		
}			
}			
}			

Table 8.2.2.3.1.3.3-1B: CellGroupConfig (Table 8.2.2.3.1.3.3-1A)

Derivation Path: 38.508-1 [4], Table 4.6.3-19 with condition EN-DC and PSCell_change			
Information Element	Value/remark	Comment	Condition
CellGroupConfig ::= SEQUENCE {			
cellGroupId	1		
rlc-BearerToAddModList SEQUENCE (SIZE(1..maxLC-ID)) OF RLC-BearerConfig {	4 entries		
RLC-BearerConfig[1]	RLC-BearerConfig according to 38.508-1 [4], Table 4.6.3-148 with condition SRB1 and Re-establish_RLC	entry 1	
RLC-BearerConfig[2]	RLC-BearerConfig according to 38.508-1 [4], Table 4.6.3-148 with condition SRB2 and Re-establish_RLC	entry 2	
RLC-BearerConfig[3]	RLC-BearerConfig according to 38.508-1 [4], Table 4.6.3-148 with condition SRB3	entry 3	
RLC-BearerConfig[4]	RLC-BearerConfig according to 38.508-1 [4], Table 4.6.3-148 with conditions AM and DRB2 and Re-establish_RLC	entry 4	
}			
mac-LogicalChannelConfig	LogicalChannelConfig according to 38.508-1 [4], table 4.6.3-66		
}			

Table 8.2.2.3.1.3.3-1C: RadioBearerConfig (Table 8.2.2.3.1.3.3-1)

Derivation Path: TS 38.508-1[4] table 4.6.3-132			
Information Element	Value/remark	Comment	Condition
RadioBearerConfig ::= SEQUENCE {			
srb-ToAddModList SEQUENCE (SIZE (1..2)) OF SRB-ToAddMod {			
SRB-ToAddMod[1] SEQUENCE {		entry 1	
srb-Identity	LogicalChannelIdentity with condition SRB1		
reestablishPDCP	true		
discardOnPDCP	Not present		
pdcpc-Config	PDCP-Config according to table 8.2.2.3.1.3.3-1D		
srb-Identity[2]	LogicalChannelIdentity with condition SRB2		
reestablishPDCP[2]	true		
discardOnPDCP[2]	Not present		
pdcpc-Config[2]	Not present		
}			
}			
}			

Table 8.2.2.3.1.3.3-1D: PDCP-Config (Table 8.2.2.3.1.3.3-1C)

Derivation Path: 38.508-1[4] table 4.6.3-99 with condition Split_SRB

Table 8.2.2.3.1.3.3-1E: MobilityControlInfo-HO-SameCell (Table 8.2.2.3.1.3.3-1)

Derivation Path: 36.508 [7], Table 4.6.5-1			
Information Element	Value/remark	Comment	Condition
MobilityControlInfo-HO ::= SEQUENCE {			
targetPhysCellId	PhysicalCellIdentity of E-UTRA Cell 1		
carrierFreq	Not present		
}			

Table 8.2.2.3.1.3.3-2: Void

Table 8.2.2.3.1.3.3-3: Void

Table 8.2.2.3.1.3.3-4: RRCReconfiguration (step 3, Table 8.2.2.3.1.3.2-1)

Derivation Path: 38.508-1 [4], Table 4.6.1-13			
Information Element	Value/remark	Comment	Condition
RRCReconfiguration ::= SEQUENCE {			
criticalExtensions CHOICE {			
rrcReconfiguration SEQUENCE {			
secondaryCellGroup	OCTET STRING containing CellGroupConfig according to table 8.2.2.3.1.3.3-5.		
}			
}			
}			

Table 8.2.2.3.1.3.3-5: *CellGroupConfig* (Table 8.2.2.3.1.3.3-4)

Derivation Path: 38.508-1 [4], Table 4.6.3-19			
Information Element	Value/remark	Comment	Condition
CellGroupConfig ::= SEQUENCE {			
cellGroupId	1		
mac-CellGroupConfig	MAC-CellGroupConfig according to table 8.2.2.3.1.3.3-5a		
}			

Table 8.2.2.3.1.3.3-5A: *MAC-CellGroupConfig* (Table 8.2.2.3.1.3.3-5)

Derivation Path: TS 38.508-1 [4], Table 4.6.3-68			
Information Element	Value/remark	Comment	Condition
MAC-CellGroupConfig ::= SEQUENCE {			
bsr-Config SEQUENCE {			
periodicBSR-Timer	sf5		
retxBSR-Timer	sf40		
}			
}			

Table 8.2.2.3.1.3.3-6: *RRCConnectionReconfiguration* (step 5, Table 8.2.2.3.1.3.2-1)

Derivation Path: 36.508 [7], Table 4.6.1-8			
Information Element	Value/remark	Comment	Condition
RRCConnectionReconfiguration ::= SEQUENCE {			
criticalExtensions CHOICE {			
c1 CHOICE{			
rrcConnectionReconfiguration-r8 SEQUENCE {			
nonCriticalExtension SEQUENCE {			
nonCriticalExtension SEQUENCE {			
nonCriticalExtension SEQUENCE {			
nonCriticalExtension SEQUENCE {			
nonCriticalExtension SEQUENCE {			
nonCriticalExtension SEQUENCE {			
nr-Config-r15 CHOICE {			
setup SEQUENCE {			
nr-SecondaryCellGroupConfig-r15	OCTET STRING containing <i>RRCReconfiguration</i> according to Table 8.2.2.3.1.3.3-8.		
}			
}			
}			
}			
}			
}			
nr-RadioBearerConfig1-r15	RadioBearerConfig according to Table 8.2.2.3.1.3.3-7.		
}			
}			
}			

Table 8.2.2.3.1.3.3-7: RadioBearerConfig (Table 8.2.2.3.1.3.3-6)

Derivation Path: 38.508-1 [4], Table 4.6.3-132			
Information Element	Value/remark	Comment	Condition
RadioBearerConfig ::= SEQUENCE {			
srb-ToAddModList	Not present		
srb3-ToRelease	true		
drb-ToAddModList	Not present		
drb-ToReleaseList	Not present		
securityConfig	Not present		
}			

Table 8.2.2.3.1.3.3-8: RRCReconfiguration (Table 8.2.2.3.1.3.3-6)

Derivation Path: 38.508-1 [4], Table 4.6.1-13			
Information Element	Value/remark	Comment	Condition
RRCReconfiguration ::= SEQUENCE {			
criticalExtensions CHOICE {			
rrcReconfiguration SEQUENCE {			
secondaryCellGroup	OCTET STRING containing <i>CellGroupConfig</i> according to table 8.2.2.1.1.3.3-9.		
}			
}			
}			

Table 8.2.2.3.1.3.3-9: CellGroupConfig (Table 8.2.2.3.1.3.3-8)

Derivation Path: 38.508-1 [4], Table 4.6.3-19			
Information Element	Value/remark	Comment	Condition
CellGroupConfig ::= SEQUENCE {			
cellGroupId	1		
rlc-BearerToAddModList	Not present		
rlc-BearerToReleaseList SEQUENCE (SIZE (1.. maxLC-ID)) OF LogicalChannelIdentity {	1 entry		
LogicalChannelIdentity[1]	3	entry 1	
}			
mac-CellGroupConfig	Not present		
physicalCellGroupConfig	Not present		
sCellToAddModList	Not present		
sCellToReleaseList SEQUENCE (SIZE (1..maxNrofSCells)) OF SCellIndex {	1 entry		
SCellIndex[1]	SCellIndex	entry 1 NR Cell 1	
}			
}			

Table 8.2.2.3.1.3.3-10: RRCConnectionReconfiguration (step 7, Table 8.2.2.3.1.3.2-1)

Derivation Path: 36.508 [7], Table 4.6.1-8 with condition HO-TO-EUTRA			
Information Element	Value/remark	Comment	Condition
RRCConnectionReconfiguration ::= SEQUENCE {			
criticalExtensions CHOICE {			
c1 CHOICE{			
rrcConnectionReconfiguration-r8 SEQUENCE {			
mobilityControlInfo	MobilityControlInfo-HO-SameCell	As per Table 8.2.2.3.1.3.3-1E	
radioResourceConfigDedicated SEQUENCE {			
srb-ToAddModList SEQUENCE (SIZE (1..2)) OF SRB-ToAddMod {	1 entry		
SRB-ToAddMod[1]	SRB-ToAddMod-DEFAULT using condition SRB1	entry 1 See TS 36.508 [7] subclause 4.8.2	
}			
}			
nonCriticalExtension SEQUENCE {			
nonCriticalExtension SEQUENCE {			
nonCriticalExtension SEQUENCE {			
nonCriticalExtension SEQUENCE {			
nonCriticalExtension SEQUENCE {			
nonCriticalExtension SEQUENCE {			
nonCriticalExtension SEQUENCE {			
nr-Config-r15 CHOICE {			
setup SEQUENCE {			
nr-SecondaryCellGroupConfig-r15	OCTET STRING containing RRCReconfiguration according to Table 8.2.2.3.1.3.3-11		
}			
}			
nr-RadioBearerConfig1-r15	Not present		
}			
}			
}			
}			
}			
}			
}			
}			
}			
}			
}			
}			
}			
}			
}			
}			
}			

Table 8.2.2.3.1.3.3-11: RRCReconfiguration (Table 8.2.2.3.1.3.2-10)

Derivation Path: 38.508-1 [4], Table 4.6.1-13			
Information Element	Value/remark	Comment	Condition
RRCReconfiguration ::= SEQUENCE {			
criticalExtensions CHOICE {			
rrcReconfiguration SEQUENCE {			
secondaryCellGroup	OCTET STRING containing CellGroupConfig according to Table 8.2.2.3.1.3.3-12.		
}			
}			
}			

Table 8.2.2.3.1.3.3-12: *CellGroupConfig* (Table 8.2.2.3.1.3.3-11)

Derivation Path: 38.508-1 [4], Table 4.6.3-19			
Information Element	Value/remark	Comment	Condition
CellGroupConfig ::= SEQUENCE {			
cellGroupId	1		
rlc-BearerToReleaseList SEQUENCE (SIZE (1..maxLC-ID)) OF LogicalChannelIdentity {	1 entry		
LogicalChannelIdentity[1]	1	entry 1	
}			
}			

8.2.2.4 PSCell addition, modification and release / SCG DRB

8.2.2.4.1 PSCell addition, modification and release / SCG DRB / EN-DC

8.2.2.4.1.1 Test Purpose (TP)

(1)

```
with { UE in RRC_CONNECTED state with EN-DC, and, MCG(s) (E-UTRA PDCP) only }
ensure that {
  when { UE receives an RRCConnectionReconfiguration message to add PSCell with SCG DRB }
  then { UE configures the PSCell with SCG DRB and sends an RRCConnectionReconfigurationComplete message }
}
```

(2)

```
with { UE in RRC_CONNECTED state with EN-DC, and, MCG(s) (E-UTRA PDCP) and SCG }
ensure that {
  when { UE receives an RRCConnectionReconfiguration message to modify SCG DRB }
  then { UE reconfigures the SCG DRB and sends an RRCConnectionReconfigurationComplete message }
}
```

(3)

```
with { UE in RRC_CONNECTED state with EN-DC, and, MCG(s) (E-UTRA PDCP) and SCG }
ensure that {
  when { UE receives an RRCConnectionReconfiguration message to release PSCell with SCG DRB }
  then { UE releases the PSCell and SCG DRB and sends an RRCConnectionReconfigurationComplete message }
}
```

8.2.2.4.1.2 Conformance requirements

References: The conformance requirements covered in the present test case are specified in: TS 36.331, clause 5.3.5.3, TS 38.331, clauses 5.3.5.3, 5.3.5.5.7, 5.3.5.6.4 and 5.3.5.6.5. Unless otherwise stated these are Rel-15 requirements.

[TS 36.331, clause 5.3.5.3]

If the *RRCConnectionReconfiguration* message does not include the *mobilityControlInfo* and the UE is able to comply with the configuration included in this message, the UE shall:

...

- 1> if the received *RRCConnectionReconfiguration* includes the *nr-Config* and it is set to release: or
- 1> if the received *RRCConnectionReconfiguration* includes *endc-ReleaseAndAdd* and it is set to *TRUE*:
 - 2> perform ENDC release as specified in TS38.331 [82], clause 5.3.5.10;
- 1> if the received *RRCConnectionReconfiguration* includes the *sk-Counter*:
 - 2> perform key update procedure as specified in TS 38.331 [82], clause 5.3.5.7;

- 1> if the received *RRCConnectionReconfiguration* includes the *nr-SecondaryCellGroupConfig*:
 - 2> perform NR RRC Reconfiguration as specified in TS 38.331 [82], clause 5.3.5.3;
- 1> if the received *RRCConnectionReconfiguration* includes the *nr-RadioBearerConfig1*:
 - 2> perform radio bearer configuration as specified in TS 38.331 [82], clause 5.3.5.6;
- 1> if the received *RRCConnectionReconfiguration* includes the *nr-RadioBearerConfig2*:
 - 2> perform radio bearer configuration as specified in TS 38.331 [82], clause 5.3.5.6;
- ...
- 1> set the content of *RRCConnectionReconfigurationComplete* message as follows:
 - 2> if the *RRCConnectionReconfiguration* message includes *perCC-GapIndicationRequest*:
 - 3> include *perCC-GapIndicationList* and *numFreqEffective*;
 - 2> if the frequencies are configured for reduced measurement performance:
 - 3> include *numFreqEffectiveReduced*;
 - 2> if the received *RRCConnectionReconfiguration* message included *nr-SecondaryCellGroupConfig*:
 - 3> include *scg-ConfigResponseNR* in accordance with TS 38.331 [82], clause 5.3.5.3;
- 1> submit the *RRCConnectionReconfigurationComplete* message to lower layers for transmission using the new configuration, upon which the procedure ends;

[TS 38.331, clause 5.3.5.3]

The UE shall perform the following actions upon reception of the *RRCReconfiguration*:

- ...
- 1> if the *RRCReconfiguration* includes the *secondaryCellGroup*:
 - 2> perform the cell group configuration for the SCG according to 5.3.5.5;
- 1> if the *RRCReconfiguration* message contains the *radioBearerConfig*:
 - 2> perform the radio bearer configuration according to 5.3.5.6;
- 1> if the *RRCReconfiguration* message includes the *measConfig*:
 - 2> perform the measurement configuration procedure as specified in 5.5.2;
- ...
- 1> set the content of *RRCReconfigurationComplete* message as follows:
 - 2> if the *RRCReconfiguration* includes the *masterCellGroup* containing the *reportUplinkTxDirectCurrent*, or;
 - 2> if the *RRCReconfiguration* includes the *secondaryCellGroup* containing the *reportUplinkTxDirectCurrent*:
 - 3> include the *uplinkTxDirectCurrentList*;
- 1> if the UE is configured with E-UTRA *nr-SecondaryCellGroupConfig* (MCG is E-UTRA):
 - 2> if *RRCReconfiguration* was received via SRB1:
 - 3> construct *RRCReconfigurationComplete* message and submit it via the EUTRA MCG embedded in E-UTRA RRC message *RRCConnectionReconfigurationComplete* as specified in TS 36.331 [10].
 - 3> if *reconfigurationWithSync* was included in *spCellConfig* of an SCG:
 - 4> initiate the random access procedure on the SpCell, as specified in TS 38.321 [3];

3> else:

4> the procedure ends;

NOTE: The order the UE sends the *RRCConnectionReconfigurationComplete* message and performs the Random Access procedure towards the SCG is left to UE implementation.

2> else (*RRCReconfiguration* was received via SRB3):

3> submit the *RRCReconfigurationComplete* message via SRB3 to lower layers for transmission using the new configuration.

NOTE: For EN-DC, in the case *RRCReconfiguration* is received via SRB1, the random access is triggered by RRC layer itself as there is not necessarily other UL transmission. In the case *RRCReconfiguration* is received via SRB3, the random access is triggered by the MAC layer due to arrival of *RRCReconfigurationComplete*.

1 > else:

2> submit the *RRCReconfigurationComplete* message via SRB1 to lower layers for transmission using the new configuration;

2> if this is the first *RRCReconfiguration* message after successful completion of the RRC re-establishment procedure:

3> resume SRB2 and DRBs that are suspended;

1> if *reconfigurationWithSync* was included in *spCellConfig* of an MCG or SCG, and when MAC of an NR cell group successfully completes a random access procedure triggered above;

2> stop timer T304 for that cell group;

2> apply the parts of the CQI reporting configuration, the scheduling request configuration and the sounding RS configuration that do not require the UE to know the SFN of the respective target SpCell, if any;

2> apply the parts of the measurement and the radio resource configuration that require the UE to know the SFN of the respective target SpCell (e.g. measurement gaps, periodic CQI reporting, scheduling request configuration, sounding RS configuration), if any, upon acquiring the SFN of that target SpCell;

2> if the *reconfigurationWithSync* was included in *spCellConfig* of an MCG::

3> if T390 is running:

4> stop timer T390 for all access categories;

4> perform the actions as specified in 5.3.14.4.

3> if *RRCReconfiguration* does not include *dedicatedSIB1-Delivery* and

3> if the active downlink BWP, which is indicated by the *firstActiveDownlinkBWP-Id* for the target SpCell of the MCG, has a common search space configured by *searchSpaceSIB1*:

4> acquire the *SIB1*, which is scheduled as specified in TS 38.213 [13], of the target SpCell of the MCG;

4> upon acquiring *SIB1*, perform the actions specified in clause 5.2.2.4.2;

2> the procedure ends;

NOTE: The UE is only required to acquire broadcasted *SIB1* if the UE can acquire it without disrupting unicast data reception, i.e. the broadcast and unicast beams are quasi co-located.

[TS 38.331, clause 5.3.5.5.7]

The UE shall:

...

- 1> if the *SpCellConfig* contains *spCellConfigDedicated*:
 - 2> configure the SpCell in accordance with the *spCellConfigDedicated*;
 - 2> consider the bandwidth part indicated in *firstActiveUplinkBWP-Id* if configured to be the active uplink bandwidth part;
 - 2> consider the bandwidth part indicated in *firstActiveDownlinkBWP-Id* if configured to be the active downlink bandwidth part;
 - 2> if the any of the reference signal(s) that are used for radio link monitoring are reconfigured by the received *spCellConfigDedicated*:
 - 3> stop timer T310 for the corresponding SpCell, if running;
 - 3> reset the counters N310 and N311.

[TS 38.331, clause 5.3.5.6.4]

Editor's Note: FFS / TODO: Add handling for the new QoS concept (mapping of flows; configuration of QFI-to-DRB mapping; reflective QoS...) but keep also EPS-Bearer handling for the EN-DC case

The UE shall:

- 1> for each *drb-Identity* value included in the *drb-ToReleaseList* that is part of the current UE configuration; or;
- 1> for each *drb-Identity* value that is to be released as the result of full configuration according to 5.3.5.11:
 - 2> release the PDCP entity and the *drb-Identity*;
 - 2> if SDAP entity associated with this DRB is configured:
 - 3> indicate the release of the DRB to SDAP entity associated with this DRB (TS 37.324 24[] clause 5.3.3);
 - 2> if the UE is operating in EN-DC:
 - 3> if a new bearer is not added either with NR or E-UTRA with same *eps-BearerIdentity*;
 - 4> indicate the release of the DRB and the *eps-BearerIdentity* of the released DRB to upper layers.

NOTE: The UE does not consider the message as erroneous if the *drb-ToReleaseList* includes any *drb-Identity* value that is not part of the current UE configuration.

NOTE: Whether or not the RLC and MAC entities associated with this PDCP entity are reset or released is determined by the *CellGroupConfig*.

[TS 38.331, clause 5.3.5.6.5]

The UE shall:

- 1> for each *drb-Identity* value included in the *drb-ToAddModList* that is not part of the current UE configuration (DRB establishment including the case when full configuration option is used):
 - 2> establish a PDCP entity and configure it in accordance with the received *pdcp-Config*;
 - 2> if the PDCP entity of this DRB is not configured with *cipheringDisabled*::
 - 3> if target RAT of handover is E-UTRA/5GC, or;
 - 3> if the UE is only connected to E-UTRA/5GC:

- 4> configure the PDCP entity with the ciphering algorithm and K_{UPenc} key configured/derived as specified in TS 36.331 [10];
- 3> else:
- 4> configure the PDCP entity with the ciphering algorithms according to *securityConfig* and apply the K_{UPenc} key associated with the master key (K_{eNB}/K_{gNB}) or the secondary key ($S-K_{gNB}$) as indicated in *keyToUse*;
- 2> if the PDCP entity of this DRB is configured with *integrityProtection*:
 - 3> configure the PDCP entity with the integrity algorithms according to *securityConfig* and apply the K_{UPint} key associated with the master (K_{eNB}/K_{gNB}) or the secondary key ($S-K_{gNB}$) as indicated in *keyToUse*;
- ...
- 2> if the UE is operating in EN-DC:
 - 3> if the DRB was configured with the same *eps-BearerIdentity* either by NR or E-UTRA prior to receiving this reconfiguration:
 - 4> associate the established DRB with the corresponding *eps-BearerIdentity*;
 - 3> else:
 - 4> indicate the establishment of the DRB(s) and the *eps-BearerIdentity* of the established DRB(s) to upper layers;
- 1> for each *drb-Identity* value included in the *drb-ToAddModList* that is part of the current UE configuration:
 - 2> if the *reestablishPDCP* is set:
 - 3> if target RAT is E-UTRA/5GC:, or;
 - 3> if the UE is only connected to E-UTRA/5GC:
 - 4> if the PDCP entity of this DRB is not configured with *cipheringDisabled*:
 - 5> configure the PDCP entity with the ciphering algorithm and K_{UPenc} key configured/derived as specified in TS 36.331 [10], clause 5.4.2.3, i.e. the ciphering configuration shall be applied to all subsequent PDCP PDUs received and sent by the UE;
 - 3> else:
 - 4> if the PDCP entity of this DRB is not configured with *cipheringDisabled*::
 - 5> configure the PDCP entity with the ciphering algorithm and K_{UPenc} key associated with the master key (K_{eNB}/K_{gNB}) or the secondary key ($S-K_{gNB}$), as indicated in *keyToUse*, i.e. the ciphering configuration shall be applied to all subsequent PDCP PDUs received and sent by the UE;
 - 4> if the PDCP entity of this DRB is configured with *integrityProtection*:
 - 5> configure the PDCP entity with the integrity algorithms according to *securityConfig* and apply the K_{UPint} key associated with the master (K_{eNB}/K_{gNB}) or the secondary key ($S-K_{gNB}$) as indicated in *keyToUse*;
 - 3> re-establish the PDCP entity of this DRB as specified in 38.323 [5], clause 5.1.2;
 - 2> else, if the *recoverPDCP* is set:
 - 3> trigger the PDCP entity of this DRB to perform data recovery as specified in 38.323[5];
 - 2> if the *pdcp-Config* is included:
 - 3> reconfigure the PDCP entity in accordance with the received *pdcp-Config*.
- ...

NOTE 1: Void

- NOTE 2: When determining whether a *drb-Identity* value is part of the current UE configuration, the UE does not distinguish which *RadioBearerConfig* and *DRB-ToAddModList* that DRB was originally configured in. To re-associate a DRB with a different key (KeNB to S-KeNB or vice versa), the network provides the *drb-Identity* value in the (target) *drb-ToAddModList* and sets the *reestablishPDCP* flag. The network does not list the *drb-Identity* in the (source) *drb-ToReleaseList*.
- NOTE 3: When setting the *reestablishPDCP* flag for a radio bearer, the network ensures that the RLC receiver entities do not deliver old PDCP PDUs to the re-established PDCP entity. It does that e.g. by triggering a reconfiguration with sync of the cell group hosting the old RLC entity or by releasing the old RLC entity.
- NOTE 4: In this specification, UE configuration refers to the parameters configured by NR RRC unless otherwise stated.
- NOTE 5: Ciphering and integrity protection can be enabled or disabled for a DRB. The enabling/disabling of ciphering or integrity protection can be changed only by releasing and adding the DRB.

8.2.2.4.1.3 Test description

8.2.2.4.1.3.1 Pre-test conditions

System Simulator:

- E-UTRA Cell 1 is the PCell and NR Cell 1 is the PSCell.

UE:

- None.

Preamble:

- If *pc_IP_Ping* is set to TRUE then, the UE is in state RRC_CONNECTED using generic procedure parameter Connectivity (*EN-DC*), Bearers (*MCG(s) only*) established according to TS 38.508-1 [4], clause 4.5.4.
- Else, the UE is in state RRC_CONNECTED using generic procedure parameter Connectivity (*EN-DC*), Bearers (*MCG(s) only*) established and Test Mode (*On*) associated with UE test loop mode B configured on E-UTRA Cell 1 according to TS 38.508-1 [4], clause 4.5.4.

8.2.2.4.1.3.2 Test procedure sequence

Table 8.2.2.4.1.3.2-1: Main behaviour

St	Procedure	Message Sequence		TP	Verdict
		U - S	Message		
1	The SS transmits an <i>RRCCONNECTIONRECONFIGURATION</i> message containing NR <i>RRCCONNECTIONRECONFIGURATION</i> message to add NR <i>PSCell</i> with SCG DRB. <i>RRCCONNECTIONRECONFIGURATION</i> message contains the ACTIVATE DEDICATED EPS BEARER CONTEXT REQUEST message.	<--	<i>RRCCONNECTIONRECONFIGURATION (RRCCONNECTIONRECONFIGURATION)</i>	-	-
2	Check: Does the UE transmit an <i>RRCCONNECTIONRECONFIGURATIONCOMPLETE</i> message containing NR <i>RRCCONNECTIONRECONFIGURATIONCOMPLETE</i> message?	-->	<i>RRCCONNECTIONRECONFIGURATIONCOMPLETE (RRCCONNECTIONRECONFIGURATIONCOMPLETE)</i>	1	P
3	The UE transmits an <i>ULINFORMATIONTRANSFER</i> message containing the ACTIVATE DEDICATED EPS BEARER CONTEXT ACCEPT message.	-->	<i>ULINFORMATIONTRANSFER</i>	-	-
-	EXCEPTION: Steps 4a1 to 4a2 describe behaviour that depends on the UE implementation; the "lower case letter" identifies a step sequence that take place depending on the UE implementation.	-	-	-	-
4a1	IF <i>pc_IP_Ping</i> = FALSE, then, the SS transmits a CLOSE UE TEST LOOP message.	<--	CLOSE UE TEST LOOP	-	-
4a2	The UE transmits a CLOSE UE TEST LOOP COMPLETE message.	-->	CLOSE UE TEST LOOP COMPLETE	-	-
5	Check: Does the test result of generic test procedure in TS 38.508-1 subclause 4.9.1 indicate that the UE is capable of exchanging IP data on SCG DRB#2?	-	-	1	P
6	SS transmits <i>RRCCONNECTIONRECONFIGURATION</i> message containing NR <i>RadioBearerConfig</i> to modify <i>PDCP discardTimer</i> value of SCG DRB.	<--	<i>RRCCONNECTIONRECONFIGURATION</i>	-	-
7	Check: Does the UE transmit an <i>RRCCONNECTIONRECONFIGURATIONCOMPLETE</i> message?	-->	<i>RRCCONNECTIONRECONFIGURATIONCOMPLETE</i>	2	P
8	Check: Does the test result of generic test procedure in TS 38.508-1 subclause 4.9.1 indicate that the UE is capable of exchanging IP data on SCG DRB#2?	-	-	2	P
9	SS transmits <i>RRCCONNECTIONRECONFIGURATION</i> message containing <i>nr-Config-r15</i> and NR <i>RadioBearerConfig</i> to release <i>PSCell</i> and SCG DRB. <i>RRCCONNECTIONRECONFIGURATION</i> message contains the DEACTIVATE EPS BEARER CONTEXT REQUEST message.	<--	<i>RRCCONNECTIONRECONFIGURATION</i>	-	-
10	Check: Does the UE transmit an <i>RRCCONNECTIONRECONFIGURATIONCOMPLETE</i> message?	-->	<i>RRCCONNECTIONRECONFIGURATIONCOMPLETE</i>	3	P
11	The UE transmits an <i>ULINFORMATIONTRANSFER</i> message containing the DEACTIVATE EPS BEARER CONTEXT ACCEPT message.	-->	<i>ULINFORMATIONTRANSFER</i>	-	-

Table 8.2.2.4.1.3.3-3: CellGroupConfig (Table 8.2.2.4.1.3.3-2)

Derivation Path: 38.508-1 [4], Table 4.6.3-19			
Information Element	Value/remark	Comment	Condition
CellGroupConfig ::= SEQUENCE {			
rlc-BearerToAddModList SEQUENCE (SIZE(1..maxLC-ID)) OF RLC-BearerConfig {	1 entry		
RLC-BearerConfig[1] SEQUENCE {		entry 1	
servedRadioBearer CHOICE {			
drb-Identity	2	SCG DRB Id	
}			
}			
}			
}			

Table 8.2.2.4.1.3.3-4: RadioBearerConfig (Table 8.2.2.4.1.3.3-1)

Derivation Path: 38.508-1 [4], Table 4.6.3-132			
Information Element	Value/remark	Comment	Condition
RadioBearerConfig ::= SEQUENCE {			
drb-ToAddModList SEQUENCE (SIZE (1..maxDRB)) OF DRB-ToAddMod {	1 entry		
DRB-ToAddMod[1] SEQUENCE {		entry 1	
cnAssociation CHOICE {			
eps-BearerIdentity	6	Dedicated EPS bearer Id of SCG DRB	
}			
drb-Identity	2	SCG DRB Id	
}			
}			
securityConfig SEQUENCE {			
keyToUse	secondary		
}			
}			

(3)

```

with { UE in NR RRC_CONNECTED state with NR-DC }
ensure that {
  when { UE receives an RRCReconfiguration message to release PSCell with SCG DRB }
  then { UE releases the PSCell and SCG DRB and sends an RRCReconfigurationComplete message }
}

```

8.2.2.4.2.2 Conformance requirements

References: The conformance requirements covered in the present test case are specified in: TS 38.331, clauses 5.3.5.3, 5.3.5.5.1, 5.3.5.5.7, 5.3.5.6.4 and 5.3.5.6.5. Unless otherwise stated these are Rel-15 requirements.

[TS 38.331, clause 5.3.5.3]

The UE shall perform the following actions upon reception of the *RRCReconfiguration*:

...

1> if the *RRCReconfiguration* includes the *secondaryCellGroup*:

2> perform the cell group configuration for the SCG according to 5.3.5.5;

1> if the *RRCReconfiguration* message contains the *radioBearerConfig*:

2> perform the radio bearer configuration according to 5.3.5.6;

1> if the *RRCReconfiguration* message includes the *measConfig*:

2> perform the measurement configuration procedure as specified in 5.5.2;

...

1> set the content of the *RRCReconfigurationComplete* message as follows:

2> if the *RRCReconfiguration* message includes the *mrdc-SecondaryCellGroupConfig* with *mrdc-SecondaryCellGroup* set to *nr-SCG*:

3> include in the *nr-SCG-Response* the *RRCReconfigurationComplete* message;

1> else if the *RRCReconfiguration* message was received via SRB1 within the *nr-SCG* within *mrdc-SecondaryCellGroup* (UE in NR-DC, *mrdc-SecondaryCellGroup* was received in *RRCReconfiguration* via SRB1):

2> if *reconfigurationWithSync* was included in *spCellConfig* in *nr-SCG*:

3> initiate the Random Access procedure on the PSCell, as specified in TS 38.321 [3];

2> else

3> the procedure ends;

NOTE 2a: The order in which the UE sends the *RRCReconfigurationComplete* message and performs the Random Access procedure towards the SCG is left to UE implementation.

[TS 38.331, clause 5.3.5.5.1]

...

1> if the *CellGroupConfig* contains the *spCellConfig*:

2> configure the SpCell as specified in 5.3.5.5.7;

[TS 38.331, clause 5.3.5.5.7]

The UE shall:

...

- 1> if the *SpCellConfig* contains *spCellConfigDedicated*:
 - 2> configure the SpCell in accordance with the *spCellConfigDedicated*;
 - 2> consider the bandwidth part indicated in *firstActiveUplinkBWP-Id* if configured to be the active uplink bandwidth part;
 - 2> consider the bandwidth part indicated in *firstActiveDownlinkBWP-Id* if configured to be the active downlink bandwidth part;
 - 2> if any of the reference signal(s) that are used for radio link monitoring are reconfigured by the received *spCellConfigDedicated*:
 - 3> stop timer T310 for the corresponding SpCell, if running;
 - 3> stop timer T312 for the corresponding SpCell, if running;
 - 3> reset the counters N310 and N311.

[TS 38.331, clause 5.3.5.6.4]

- 1> for each *drb-Identity* value included in the *drb-ToReleaseList* that is part of the current UE configuration; or
- 1> for each *drb-Identity* value that is to be released as the result of full configuration according to 5.3.5.11:
 - 2> release the PDCP entity and the *drb-Identity*;
 - 2> if SDAP entity associated with this DRB is configured:
 - 3> indicate the release of the DRB to SDAP entity associated with this DRB (TS 37.324 [24], clause 5.3.3);
 - 2> if the DRB is associated with an *eps-BearerIdentity*:
 - 3> if a new bearer is not added either with NR or E-UTRA with same *eps-BearerIdentity*:
 - 4> indicate the release of the DRB and the *eps-BearerIdentity* of the released DRB to upper layers.

NOTE 1: The UE does not consider the message as erroneous if the *drb-ToReleaseList* includes any *drb-Identity* value that is not part of the current UE configuration.

NOTE 2: Whether or not the RLC and MAC entities associated with this PDCP entity are reset or released is determined by the *CellGroupConfig*.

[TS 38.331, clause 5.3.5.6.5]

The UE shall:

- 1> for each *drb-Identity* value included in the *drb-ToAddModList* that is not part of the current UE configuration (DRB establishment including the case when full configuration option is used):
 - 2> establish a PDCP entity and configure it in accordance with the received *pdcp-Config*;
 - 2> if the PDCP entity of this DRB is not configured with *cipheringDisabled*:
 - 3> if target RAT of handover is E-UTRA/5GC; or
 - 3> if the UE is connected to E-UTRA/5GC:
 - 4> if the UE is capable of E-UTRA/5GC but not capable of NGEN-DC:
 - 5> configure the PDCP entity with the ciphering algorithm and K_{UPenc} key configured/derived as specified in TS 36.331 [10];
 - 4> else (i.e., a UE capable of NGEN-DC):
 - 5> configure the PDCP entity with the ciphering algorithms according to *securityConfig* and apply the key (K_{UPenc}) associated with the master key (K_{eNB}) or secondary key ($S-K_{eNB}$) as indicated in *keyToUse*, if applicable;

...

- 2> if the PDCP entity of this DRB is configured with *integrityProtection*:
 - 3> configure the PDCP entity with the integrity protection algorithms according to *securityConfig* and apply the K_{UPint} key associated with the master (K_{gNB}) or the secondary key ($S-K_{gNB}$) as indicated in *keyToUse*;
- 2> if an *sdap-Config* is included:
 - 3> if an SDAP entity with the received *pdu-Session* does not exist:
 - 4> establish an SDAP entity as specified in TS 37.324 [24] clause 5.1.1;
 - 4> if an SDAP entity with the received *pdu-Session* did not exist prior to receiving this reconfiguration:
 - 5> indicate the establishment of the user plane resources for the *pdu-Session* to upper layers;
 - 3> configure the SDAP entity in accordance with the received *sdap-Config* as specified in TS 37.324 [24] and associate the DRB with the SDAP entity;

...

- 1> for each *drb-Identity* value included in the *drb-ToAddModList* that is part of the current UE configuration and not configured with *dapsConfig*:
 - 2> if the *reestablishPDCP* is set:
 - 3> if target RAT is E-UTRA/5GC:, or;
 - 3> if the UE is only connected to E-UTRA/5GC:
 - 4> if the UE is capable of E-UTRA/5GC but not capable of NGEN-DC:
 - 5> if the PDCP entity of this DRB is not configured with *cipheringDisabled*:
 - 6> configure the PDCP entity with the ciphering algorithm and K_{UPenc} key configured/derived as specified in TS 36.331 [10], clause 5.4.2.3, i.e. the ciphering configuration shall be applied to all subsequent PDCP PDUs received and sent by the UE;
 - 4> else (i.e., a UE capable of NGEN-DC):
 - 5> if the PDCP entity of this DRB is not configured with *cipheringDisabled*:
 - 6> configure the PDCP entity with the ciphering algorithm and K_{UPenc} key associated with the master key (K_{eNB}) or the secondary key ($S-K_{gNB}$), as indicated in *keyToUse*, i.e. the ciphering configuration shall be applied to all subsequent PDCP PDUs received and sent by the UE;

...

- 2> else, if the *recoverPDCP* is set:
 - 3> trigger the PDCP entity of this DRB to perform data recovery as specified in TS 38.323 [5];
- 2> if the *pdcp-Config* is included:
 - 3> reconfigure the PDCP entity in accordance with the received *pdcp-Config*.
- 2> if the *sdap-Config* is included:
 - 3> reconfigure the SDAP entity in accordance with the received *sdap-Config* as specified in TS37.324 [24];
 - 3> for each QFI value added in *mappedQoS-FlowsToAdd*, if the QFI value is previously configured, the QFI value is released from the old DRB;

NOTE 1: Void.

- NOTE 2: When determining whether a *drb-Identity* value is part of the current UE configuration, the UE does not distinguish which *RadioBearerConfig* and *DRB-ToAddModList* that DRB was originally configured in. To re-associate a DRB with a different key (K_{eNB} to $S-K_{gNB}$, K_{gNB} to $S-K_{eNB}$, K_{gNB} to $S-K_{gNB}$, or vice versa), the network provides the *drb-Identity* value in the (target) *drb-ToAddModList* and sets the *reestablishPDCP* flag. The network does not list the *drb-Identity* in the (source) *drb-ToReleaseList*.
- NOTE 3: When setting the *reestablishPDCP* flag for a radio bearer, the network ensures that the RLC receiver entities do not deliver old PDCP PDUs to the re-established PDCP entity. It does that e.g. by triggering a reconfiguration with sync of the cell group hosting the old RLC entity or by releasing the old RLC entity.
- NOTE 4: In this specification, UE configuration refers to the parameters configured by NR RRC unless otherwise stated.
- NOTE 5: Ciphering and integrity protection can be enabled or disabled for a DRB. The enabling/disabling of ciphering or integrity protection can be changed only by releasing and adding the DRB.

8.2.2.4.2.3 Test description

8.2.2.4.2.3.1 Pre-test conditions

System Simulator:

- NR Cell 1 is the PCell and NR Cell 10 is the PSCell.

UE:

- None.

Preamble:

- If *pc_IP_Ping* is set to TRUE then, the UE is in state NR RRC_CONNECTED using generic procedure parameter Connectivity (*NR*), according to TS 38.508-1 [4], clause 4.5.4.
- Else, the UE is in state NR RRC_CONNECTED using generic procedure parameter Connectivity (*NR*), Test Mode (*On*) associated with UE test loop mode B configured on NR Cell 1 according to TS 38.508-1 [4], clause 4.5.4.

8.2.2.4.2.3.2 Test procedure sequence

Table 8.2.2.4.2.3.2-1: Main behaviour

St	Procedure	Message Sequence		TP	Verdict
		U - S	Message		
1	The SS transmits an <i>RRCReconfiguration</i> message and a PDU SESSION MODIFICATION COMMAND to add <i>NR PSCell</i> with SCG DRB.	<--	NR RRC: <i>RRCReconfiguration</i> 5GMM: DL NAS TRANSPORT 5GSM: PDU SESSION MODIFICATION COMMAND	-	-
2	Check: Does the UE transmit an <i>RRCReconfigurationComplete</i> message including <i>nr-SCG-Response</i> ?	-->	<i>RRCReconfigurationComplete</i>	1	P
2A	The UE transmits a <i>ULInformationTransfer</i> message and an PDU SESSION MODIFICATION COMPLETE message.	-->	NR RRC: <i>ULInformationTransfer</i> 5GMM: UL NAS TRANSPORT 5GSM: PDU SESSION MODIFICATION COMPLETE	-	-
3	Check: Does the test result of generic test procedure in TS 38.508-1 subclause 4.9.1 indicate that the UE is capable of exchanging IP data on SCG DRB?	-	-	1	P
4	SS transmits <i>RRCReconfiguration</i> message containing NR <i>RadioBearerConfig</i> to modify PDCP <i>discardTimer</i> value of SCG DRB.	<--	<i>RRCReconfiguration</i>	-	-
5	Check: Does the UE transmit an <i>RRCReconfigurationComplete</i> message including <i>nr-SCG-Response</i> ?	-->	<i>RRCReconfigurationComplete</i>	2	P
6	Check: Does the test result of generic test procedure in TS 38.508-1 subclause 4.9.1 indicate that the UE is capable of exchanging IP data on SCG DRB?	-	-	2	P
7	SS transmits <i>RRCReconfiguration</i> message to release NR <i>PSCell</i> and SCG DRB.	<--	<i>RRCReconfiguration</i>	-	-
8	Check: Does the UE transmit an <i>RRCReconfigurationComplete</i> message?	-->	<i>RRCReconfigurationComplete</i>	3	P

8.2.2.4.2.3.3 Specific message contents

Table 8.2.2.4.2.3.3-1: *RRCReconfiguration* (step 1, Table 8.2.2.4.2.3.2-1)

Derivation Path: 38.508-1 [4], Table 4.6.1-13 with condition NR-DC
--

Table 8.2.2.4.2.3.3-1A: PDU SESSION MODIFICATION COMMAND (step 1, Table 8.2.2.4.2.3.2-1)

Derivation Path: TS 38.508-1 [4], Table 4.7.2-9.			
Information Element	Value/remark	Comment	Condition
PDU session ID	The same as the PDU session ID in PDU SESSION ESTABLISHMENT REQUEST associated with the Internet PDU session if available or with the first PDU session		
Authorized QoS rules	One entry		
QoS rule [1]	Reference QoS rule #5 as defined in TS 38.508-1 [4], Table 4.8.2.1-5.	QFI=5	
Authorized QoS flow descriptions	One entry		
QoS flow [1]	Reference QoS flow #5 as defined in TS 38.508-1 [4], Table 4.8.2.3-5.	QFI=5	

Table 8.2.2.4.2.3.3-2: Void

Table 8.2.2.4.2.3.3-3: *RRCCReconfiguration* (step 4, Table 8.2.2.4.2.3.2-1)

Derivation Path: 38.508-1 [4], Table 4.6.1-13			
Information Element	Value/remark	Comment	Condition
RRCCReconfiguration ::= SEQUENCE {			
criticalExtensions CHOICE {			
rrcReconfiguration SEQUENCE {			
nonCriticalExtension SEQUENCE {			
nonCriticalExtension SEQUENCE {			
radioBearerConfig2	OCTET STRING (CONTAINING RadioBearerConfig_SCG -Mod)		
}			
}			
}			
}			
}			

Table 8.2.2.4.2.3.3-4: *RadioBearerConfig_SCG-Mod* (Table 8.2.2.4.2.3.3-3)

Derivation Path: 38.508-1 [4], Table 4.6.1-132			
Information Element	Value/remark	Comment	Condition
RadioBearerConfig ::= SEQUENCE {			
drb-ToAddModList SEQUENCE (SIZE (1..maxDRB))	1 entry		
OF DRB-ToAddMod {			
DRB-ToAddMod[1] SEQUENCE {		entry 1	
drb-Identity	DRBn	n set to the same DRB ID as in Table 8.2.2.4.2.3.3-1	
pdcp-Config	PDCP-Config		
}			
}			
}			

Table 8.2.2.4.2.3.3-5: *PDCP-Config* (Table 8.2.2.4.2.3.3-4)

Derivation Path: 38.508-1 [4], Table 4.6.3-99			
Information Element	Value/remark	Comment	Condition
PDCP-Config ::= SEQUENCE {			
drb SEQUENCE {			
discardTimer	ms500	Other than default value.	
}			
}			

Table 8.2.2.4.2.3.3-6: RRCReconfiguration (step 7, Table 8.2.2.4.2.3.2-1)

Derivation Path: 38.508 [4], Table 4.6.1-13			
Information Element	Value/remark	Comment	Condition
RRCReconfiguration ::= SEQUENCE {			
criticalExtensions CHOICE {			
rrcReconfiguration SEQUENCE {			
nonCriticalExtension SEQUENCE {			
nonCriticalExtension SEQUENCE {			
mrdc-SecondaryCellGroupConfig CHOICE {			
setup SEQUENCE {			
mrdc-ReleaseAndAdd	true		
}			
}			
radioBearerConfig2	OCTET STRING (CONTAINING RadioBearerConfig_SCG -Rel)		
}			
}			
}			
}			

Table 8.2.2.4.2.3.3-7: RadioBearerConfig_SCG-Rel (Table 8.2.2.4.2.3.3-6)

Derivation Path: 38.508-1 [4], Table 4.6.3-132			
Information Element	Value/remark	Comment	Condition
RadioBearerConfig ::= SEQUENCE {			
drb-ToReleaseList	DRBn	n set to the same DRB ID as in Table 8.2.2.4.2.3.3-2	
}			

Table 8.2.2.4.2.3.3-8: RRCReconfigurationComplete (step 2 and 5, Table 8.2.2.4.2.3.2-1)

Derivation Path: 38.508 [4], Table 4.6.1-14 with condition NR-DC			
--	--	--	--

8.2.2.5 PSCell addition, modification and release / Split DRB

8.2.2.5.1 PSCell addition, modification and release / Split DRB / EN-DC

8.2.2.5.1.1 Test Purpose (TP)

(1)

```
with { UE in RRC_CONNECTED state with EN-DC, and, MCG(s) (E-UTRA PDCP) only }
ensure that {
  when { UE receives an RRCConnectionReconfiguration message to add PSCell with Split DRB }
  then { UE configures the PSCell and sends an RRCConnectionReconfigurationComplete message }
}
```

(2)

```
with { UE in RRC_CONNECTED state with EN-DC, and, MCG(s) (E-UTRA PDCP) and Split }
ensure that {
  when { UE receives an RRCConnectionReconfiguration message to modify Split DRB }
  then { UE reconfigures the Split DRB and sends an RRCConnectionReconfigurationComplete message }
}
```

(3)

```

with { UE in RRC_CONNECTED state with EN-DC, and, MCG(s) (E-UTRA PDCP) and Split }
ensure that {
  when { UE receives an RRCConnectionReconfiguration message to release PSCell with Split DRB }
  then { UE releases the PSCell and Split DRB and sends an RRCConnectionReconfigurationComplete
message }
}

```

8.2.2.5.1.2 Conformance requirements

References: The conformance requirements covered in the present TC are specified in: TS 36.331, clause 5.3.5.3, TS 38.331, clauses 5.3.5.3, 5.3.5.5.7, 5.3.5.6.4 and 5.3.5.6.5. Unless otherwise stated these are Rel-15 requirements.

[TS 36.331, clause 5.3.5.3]

If the *RRCCConnectionReconfiguration* message does not include the *mobilityControlInfo* and the UE is able to comply with the configuration included in this message, the UE shall:

...

- 1> if the received *RRCCConnectionReconfiguration* includes the *nr-Config* and it is set to *release*: or
- 1> if the received *RRCCConnectionReconfiguration* includes *endc-ReleaseAndAdd* and it is set to *TRUE*:
 - 2> perform EN-DC release as specified in TS 38.331 [82], clause 5.3.5.10;
- 1> if the received *RRCCConnectionReconfiguration* includes the *sk-Counter*:
 - 2> perform key update procedure as specified in TS 38.331 [82], clause 5.3.5.7;
- 1> if the received *RRCCConnectionReconfiguration* includes the *nr-SecondaryCellGroupConfig*:
 - 2> perform NR RRC Reconfiguration as specified in TS 38.331 [82], clause 5.3.5.3;
- 1> if the received *RRCCConnectionReconfiguration* includes the *nr-RadioBearerConfig1*:
 - 2> perform radio bearer configuration as specified in TS 38.331 [82], clause 5.3.5.6;
- 1> if the received *RRCCConnectionReconfiguration* includes the *nr-RadioBearerConfig2*:
 - 2> perform radio bearer configuration as specified in TS 38.331 [82], clause 5.3.5.6;

...

- 1> set the content of *RRCCConnectionReconfigurationComplete* message as follows:
 - 2> if the *RRCCConnectionReconfiguration* message includes *perCC-GapIndicationRequest*:
 - 3> include *perCC-GapIndicationList* and *numFreqEffective*;
 - 2> if the frequencies are configured for reduced measurement performance:
 - 3> include *numFreqEffectiveReduced*;
 - 2> if the received *RRCCConnectionReconfiguration* message included *nr-SecondaryCellGroupConfig*:
 - 3> include *scg-ConfigResponseNR* in accordance with TS 38.331 [82, 5.3.5.3];
- 1> submit the *RRCCConnectionReconfigurationComplete* message to lower layers for transmission using the new configuration, upon which the procedure ends;

[TS 38.331, clause 5.3.5.3]

The UE shall perform the following actions upon reception of the *RRCReconfiguration*:

- 1> if the *RRCReconfiguration* includes the *fullConfig*:
 - 2> perform the radio configuration procedure as specified in 5.3.5.11;

- 1> if the *RRCReconfiguration* includes the *masterCellGroup*:
 - 2> perform the cell group configuration for the received *masterCellGroup* according to 5.3.5.5;
- 1> if the *RRCReconfiguration* includes the *masterKeyUpdate*:
 - 2> perform security key update procedure as specified in 5.3.5.7;
- 1> if the *RRCReconfiguration* includes the *secondaryCellGroup*:
 - 2> perform the cell group configuration for the SCG according to 5.3.5.5;
- 1> if the *RRCReconfiguration* message contains the *radioBearerConfig*:
 - 2> perform the radio bearer configuration according to 5.3.5.6;
- 1> if the *RRCReconfiguration* message includes the *measConfig*:
 - 2> perform the measurement configuration procedure as specified in 5.5.2;
- 1> if the *RRCReconfiguration* message includes the *dedicatedSIB1-Delivery*:
 - 2> perform the action upon reception of *SIB1* as specified in 5.2.2.4.2;
- 1> if the *RRCReconfiguration* message includes the *dedicatedSystemInformationDelivery*:
 - 2> perform the action upon reception of System Information as specified in 5.2.2.4;
- 1> set the content of *RRCReconfigurationComplete* message as follows:
 - 2> if the *RRCReconfiguration* includes the *masterCellGroup* containing the *reportUplinkTxDirectCurrent*, or;
 - 2> if the *RRCReconfiguration* includes the *secondaryCellGroup* containing the *reportUplinkTxDirectCurrent*:
 - 3> include the *uplinkTxDirectCurrentList*;
- 1> if the UE is configured with E-UTRA *nr-SecondaryCellGroupConfig* (MCG is E-UTRA):
 - 2> if *RRCReconfiguration* was received via SRB1:
 - 3> submit the *RRCReconfigurationComplete* via the EUTRA MCG embedded in E-UTRA RRC message *RRCCConnectionReconfigurationComplete* as specified in TS 36.331 [10];
 - 3> if *reconfigurationWithSync* was included in *spCellConfig* of an SCG:
 - 4> initiate the random access procedure on the SpCell, as specified in TS 38.321 [3];
 - 3> else:
 - 4> the procedure ends;

NOTE: The order the UE sends the *RRCCConnectionReconfigurationComplete* message and performs the Random Access procedure towards the SCG is left to UE implementation.

- 2> else (*RRCReconfiguration* was received via SRB3):

- 3> submit the *RRCReconfigurationComplete* message via SRB3 to lower layers for transmission using the new configuration;

NOTE: For EN-DC, in the case of SRB1, the random access is triggered by RRC layer itself as there is not necessarily other UL transmission. In the case of SRB3, the random access is triggered by the MAC layer due to arrival of *RRCReconfigurationComplete*.

- 1 > else:

- 2> submit the *RRCReconfigurationComplete* message via SRB1 to lower layers for transmission using the new configuration;

- 1> if *reconfigurationWithSync* was included in *spCellConfig* of an MCG or SCG, and when MAC of an NR cell group successfully completes a random access procedure triggered above;
 - 2> stop timer T304 for that cell group;
 - 2> apply the parts of the CQI reporting configuration, the scheduling request configuration and the sounding RS configuration that do not require the UE to know the SFN of the respective target SpCell, if any;
 - 2> apply the parts of the measurement and the radio resource configuration that require the UE to know the SFN of the respective target SpCell (e.g. measurement gaps, periodic CQI reporting, scheduling request configuration, sounding RS configuration), if any, upon acquiring the SFN of that target SpCell;
 - 2> if the *reconfigurationWithSync* was included in *spCellConfig* of an MCG:
 - 3> if the active downlink BWP, which is indicated by the *firstActiveDownlinkBWP-Id* for the target SpCell of the MCG, has a common search space configured:
 - 4> acquire the *SIB1* of the target SpCell of the MCG, as specified in 5.2.2.3.1;
 - 2> the procedure ends.

NOTE: The UE is only required to acquire broadcasted *SIB1* if the UE can acquire it without disrupting unicast data reception, i.e. the broadcast and unicast beams are quasi co-located.

[TS 38.331, clause 5.3.5.5.7]

The UE shall:

- 1> if the *SpCellConfig* contains the *rlf-TimersAndConstants*:
 - 2> configure the RLF timers and constants for this cell group as specified in 5.3.5.5.6.
- 1> else if *rlf-TimersAndConstants* is not configured for this cell group:
 - 2> use values for timers T301, T310, T311 and constants N310, N311, as included in *ue-TimersAndConstants* received in *SIB1*;
- 1> if the *SpCellConfig* contains *spCellConfigDedicated*:
 - 2> configure the SpCell in accordance with the *spCellConfigDedicated*;
 - 2> consider the bandwidth part indicated in *firstActiveUplinkBWP-Id* if configured to be the active uplink bandwidth part;
 - 2> consider the bandwidth part indicated in *firstActiveDownlinkBWP-Id* if configured to be the active downlink bandwidth part;
 - 2> if the any of the reference signal(s) that are used for radio link monitoring are reconfigured by the received *spCellConfigDedicated*:
 - 3> stop timer T310 for the corresponding SpCell, if running;
 - 3> reset the counters N310 and N311.

[TS 38.331, clause 5.3.5.6.4]

Editor's Note: FFS / TODO: Add handling for the new QoS concept (mapping of flows; configuration of QFI-to-DRB mapping; reflective QoS...) but keep also EPS-Bearer handling for the EN-DC case

The UE shall:

- 1> for each *drb-Identity* value included in the *drb-ToReleaseList* that is part of the current UE configuration (DRB release):
 - 2> release the PDCP entity;
- 2> if SDAP entity associated with this DRB is configured:

3> indicate the release of the DRB to SDAP entity associated with this DRB (TS 37.324 [xx] section 5.3.3);

2> if the UE is operating in EN-DC:

3> if a new bearer is not added either with NR or E-UTRA with same *eps-BearerIdentity*:

4> indicate the release of the DRB and the *eps-BearerIdentity* of the released DRB to upper layers.

NOTE: The UE does not consider the message as erroneous if the *drb-ToReleaseList* includes any *drb-Identity* value that is not part of the current UE configuration.

NOTE: Whether or not the RLC and MAC entities associated with this PDCP entity are reset or released is determined by the *CellGroupConfig*.

[TS 38.331, clause 5.3.5.6.5]

The UE shall:

1> for each *drb-Identity* value included in the *drb-ToAddModList* that is not part of the current UE configuration (DRB establishment including the case when full configuration option is used):

2> if an *sdap-Config* is included:

3> if an SDAP entity with the received *pdu-Session* does not exist:

4> establish an SDAP entity as specified in TS 37.324 [xx] section 5.1.1;

3> configure the SDAP entity in accordance with the received *sdap-Config* as specified in TS 37.324 [xx] and associate the DRB with the SDAP entity;

2> establish a PDCP entity and configure it in accordance with the received *pdcp-Config*;

2> if the PDCP entity of this DRB is not configured with *cipheringDisabled*:

3> configure the PDCP entity with the ciphering algorithms according to *securityConfig* and apply the K_{UPenc} key associated with the master key (K_{eNB}/K_{gNB}) or the secondary key ($S-K_{gNB}$) as indicated in *keyToUse*;

2> if the PDCP entity of this DRB is configured with *integrityProtection*:

3> configure the PDCP entity with the integrity algorithms according to *securityConfig* and apply the K_{UPint} key associated with the master (K_{eNB}/K_{gNB}) or the secondary key ($S-K_{gNB}$) as indicated in *keyToUse*;

2> if the UE is operating in EN-DC:

3> if the DRB was configured with the same *eps-BearerIdentity* either by NR or E-UTRA prior to receiving this reconfiguration:

4> associate the established DRB with the corresponding *eps-BearerIdentity*;

3> else:

4> indicate the establishment of the DRB(s) and the *eps-BearerIdentity* of the established DRB(s) to upper layers;

1> for each *drb-Identity* value included in the *drb-ToAddModList* that is part of the current UE configuration:

2> if an *sdap-Config* is included, reconfigure the SDAP entity in accordance with the received *sdap-Config* as specified in TS 37.324 [xx];

2> if the *reestablishPDCP* is set:

3> if target RAT is E-UTRA/5GC:

4> if the PDCP entity of this DRB is not configured with *cipheringDisabled*:

5> configure the PDCP entity with the ciphering algorithm and K_{UPenc} key configured/derived as specified in TS 36.331 [10, 5.4.2.3], i.e. the ciphering configuration shall be applied to all subsequent PDCP PDUs received and sent by the UE;

3> else:

4> if the PDCP entity of this DRB is not configured with *cipheringDisabled*:

5> configure the PDCP entity with the ciphering algorithm and K_{UPenc} key associated with the master or secondary key ($K_{eNB}/S-K_{gNB}/K_{gNB}$) as indicated in *keyToUse*, i.e. the ciphering configuration shall be applied to all subsequent PDCP PDUs received and sent by the UE;

3> if the PDCP entity of this DRB is configured with *integrityProtection*:

4> configure the PDCP entity with the integrity algorithms according to *securityConfig* and apply the K_{UPint} key associated with the master (K_{eNB}/K_{gNB}) or the secondary key ($S-K_{gNB}$) as indicated in *keyToUse*;

3> re-establish the PDCP entity of this DRB as specified in 38.323 [5], section 5.1.2;

2> else, if the *recoverPDCP* is set:

3> trigger the PDCP entity of this DRB to perform data recovery as specified in 38.323;

2> if the *pdcp-Config* is included:

3> reconfigure the PDCP entity in accordance with the received *pdcp-Config*.

NOTE 1: Removal and addition of the same *drb-Identity* in a single *radioResourceConfig* is not supported. In case *drb-Identity* is removed and added due to reconfiguration with sync or re-establishment with the full configuration option, the network can use the same value of *drb-Identity*.

NOTE 2: When determining whether a *drb-Identity* value is part of the current UE configuration, the UE does not distinguish which *RadioBearerConfig* and *DRB-ToAddModList* that DRB was originally configured in. To re-associate a DRB with a different key (K_{eNB} to $S-K_{eNB}$ or vice versa), the network provides the *drb-Identity* value in the (target) *drb-ToAddModList* and sets the *reestablishPDCP* flag. The network does not list the *drb-Identity* in the (source) *drb-ToReleaseList*.

NOTE 3: When setting the *reestablishPDCP* flag for a radio bearer, the network ensures that the RLC receiver entities do not deliver old PDCP PDUs to the re-established PDCP entity. It does that e.g. by triggering a reconfiguration with sync of the cell group hosting the old RLC entity or by releasing the old RLC entity.

NOTE 4: In this specification, UE configuration refers to the parameters configured by NR RRC unless otherwise stated.

NOTE 5: Ciphering and integrity protection can be enabled or disabled for a DRB. The enabling/disabling of ciphering or integrity protection can be changed only by releasing and adding the DRB.

8.2.2.5.1.3 Test description

8.2.2.5.1.3.1 Pre-test conditions

System Simulator:

- E-UTRA Cell 1 is the PCell and NR Cell 1 is the PSCell.

UE:

- None.

Preamble:

- If *pc_IP_Ping* is set to TRUE then, the UE is in state RRC_CONNECTED using generic procedure parameter Connectivity (*EN-DC*), Bearers (*MCG(s) only*) established according to TS 38.508-1 [4], clause 4.5.4.

- Else, the UE is in state RRC_CONNECTED using generic procedure parameter Connectivity (*EN-DC*), Bearers (*MCG(s) only*) established and Test Mode (*On*) associated with UE test loop mode B configured on E-UTRA Cell 1 according to TS 38.508-1 [4], clause 4.5.4.

8.2.2.5.1.3.2 Test procedure sequence

Table 8.2.2.5.1.3.2-1: Main behaviour

St	Procedure	Message Sequence		TP	Verdict
		U - S	Message		
1	The SS transmits an <i>RRCCONNECTIONRECONFIGURATION</i> message containing NR <i>RRCRECONFIGURATION</i> message to add NR <i>PSCell</i> with Split DRB. <i>RRCCONNECTIONRECONFIGURATION</i> message contains the ACTIVATE DEDICATED EPS BEARER CONTEXT REQUEST message.	<--	<i>RRCCONNECTIONRECONFIGURATION (RRCRECONFIGURATION)</i>	-	-
2	Check: Does the UE transmit an <i>RRCCONNECTIONRECONFIGURATIONCOMPLETE</i> message containing NR <i>RRCRECONFIGURATIONCOMPLETE</i> message?	-->	<i>RRCCONNECTIONRECONFIGURATIONCOMPLETE (RRCRECONFIGURATIONCOMPLETE)</i>	1	P
3	The UE transmits an <i>ULINFORMATIONTRANSFER</i> message containing the ACTIVATE DEDICATED EPS BEARER CONTEXT ACCEPT message.	-->	<i>ULINFORMATIONTRANSFER</i>	-	-
-	EXCEPTION: Steps 4a1 to 4a2 describe behaviour that depends on the UE implementation; the "lower case letter" identifies a step sequence that take place depending on the UE implementation.	-	-	-	-
4a1	IF <i>pc_IP_Ping</i> = FALSE, then the SS transmits a CLOSE UE TEST LOOP message.	<--	CLOSE UE TEST LOOP	-	-
4a2	The UE transmits a CLOSE UE TEST LOOP COMPLETE message.	-->	CLOSE UE TEST LOOP COMPLETE	-	-
5	Check: Does the test result of generic test procedure in TS 38.508-1 subclause 4.9.1 indicate that the UE is capable of exchanging IP data on Split DRB#2 using NR radio path?	-	-	1	P
6	SS transmits <i>RRCCONNECTIONRECONFIGURATION</i> message containing NR <i>RADIOBEARERCONFIG</i> to modify PDCP discardTimer value of Split DRB.	<--	<i>RRCCONNECTIONRECONFIGURATION</i>	-	-
7	Check: Does the UE transmit an <i>RRCCONNECTIONRECONFIGURATIONCOMPLETE</i> message?	-->	<i>RRCCONNECTIONRECONFIGURATIONCOMPLETE</i>	2	P
8	Check: Does the test result of generic test procedure in TS 38.508-1 subclause 4.9.1 indicate that the UE is capable of exchanging IP data on the Split DRB#2 using NR radio path?	-	-	2	P
9	SS transmits <i>RRCCONNECTIONRECONFIGURATION</i> message containing <i>nr-Config-r15</i> and NR <i>RADIOBEARERCONFIG</i> to release <i>PSCell</i> and Split DRB. <i>RRCCONNECTIONRECONFIGURATION</i> message contains the DEACTIVATE EPS BEARER CONTEXT REQUEST message.	<--	<i>RRCCONNECTIONRECONFIGURATION</i>	-	-
10	Check: Does the UE transmit an <i>RRCCONNECTIONRECONFIGURATIONCOMPLETE</i> message?	-->	<i>RRCCONNECTIONRECONFIGURATIONCOMPLETE</i>	3	P
11	The UE transmits an <i>ULINFORMATIONTRANSFER</i> message containing the DEACTIVATE EPS BEARER CONTEXT ACCEPT message.	-->	<i>ULINFORMATIONTRANSFER</i>	-	-

Table 8.2.2.5.1.3.3-5: RRCConnectionReconfiguration (step 6, Table 8.2.2.5.1.3.2-1)

Derivation Path: 36.508 [7], Table 4.6.1-8			
Information Element	Value/remark	Comment	Condition
RRCConnectionReconfiguration ::= SEQUENCE {			
criticalExtensions CHOICE {			
c1 CHOICE{			
rrcConnectionReconfiguration-r8 SEQUENCE {			
nonCriticalExtension SEQUENCE {			
nonCriticalExtension SEQUENCE {			
nonCriticalExtension SEQUENCE {			
nonCriticalExtension SEQUENCE {			
nonCriticalExtension SEQUENCE {			
nonCriticalExtension SEQUENCE {			
nonCriticalExtension SEQUENCE {			
nr-RadioBearerConfig1-r15	OCTET STRING including RadioBearerConfig.		
}			
}			
}			
}			
}			
}			
}			
}			
}			
}			
}			
}			
}			
}			

Table 8.2.2.5.1.3.3-6: RadioBearerConfig (Table 8.2.2.5.1.3.3-5)

Derivation Path: 38.508-1 [4], Table 4.6.3-132, condition EN-DC			

Table 8.2.2.5.1.3.3-7: PDCP-Config (Table 8.2.2.5.1.3.3-6)

Derivation Path: 38.508-1 [4], Table 4.6.3-99			
Information Element	Value/remark	Comment	Condition
PDCP-Config ::= SEQUENCE {			
drb SEQUENCE {			
discardTimer	ms500	Other than default value.	
}			
}			

(3)

```

with { UE in NR RRC_CONNECTED state with NR-DC }
ensure that {
  when { UE receives an RRCReconfiguration message to release PSCell with Split DRB }
  then { UE releases the PSCell and Split DRB and sends an RRCReconfigurationComplete message }
}

```

8.2.2.5.2.2 Conformance requirements

References: The conformance requirements covered in the present test case are specified in: TS 38.331, clauses 5.3.5.3, 5.3.5.5.1, 5.3.5.5.7, 5.3.5.6.4 and 5.3.5.6.5. Unless otherwise stated these are Rel-15 requirements.

[TS 38.331, clause 5.3.5.3]

The UE shall perform the following actions upon reception of the *RRCReconfiguration*:

...

1> if the *RRCReconfiguration* includes the *secondaryCellGroup*:

2> perform the cell group configuration for the SCG according to 5.3.5.5;

1> if the *RRCReconfiguration* message contains the *radioBearerConfig*:

2> perform the radio bearer configuration according to 5.3.5.6;

1> if the *RRCReconfiguration* message includes the *measConfig*:

2> perform the measurement configuration procedure as specified in 5.5.2;

...

1> set the content of the *RRCReconfigurationComplete* message as follows:

2> if the *RRCReconfiguration* message includes the *mrdc-SecondaryCellGroupConfig* with *mrdc-SecondaryCellGroup* set to *nr-SCG*:

3> include in the *nr-SCG-Response* the *RRCReconfigurationComplete* message;

1> else if the *RRCReconfiguration* message was received via SRB1 within the *nr-SCG* within *mrdc-SecondaryCellGroup* (UE in NR-DC, *mrdc-SecondaryCellGroup* was received in *RRCReconfiguration* via SRB1):

2> if *reconfigurationWithSync* was included in *spCellConfig* in *nr-SCG*:

3> initiate the Random Access procedure on the PSCell, as specified in TS 38.321 [3];

2> else

3> the procedure ends;

NOTE 2a: The order in which the UE sends the *RRCReconfigurationComplete* message and performs the Random Access procedure towards the SCG is left to UE implementation.

[TS 38.331, clause 5.3.5.5.1]

...

1> if the *CellGroupConfig* contains the *spCellConfig*:

2> configure the SpCell as specified in 5.3.5.5.7;

[TS 38.331, clause 5.3.5.5.7]

The UE shall:

...

- 1> if the *SpCellConfig* contains *spCellConfigDedicated*:
 - 2> configure the SpCell in accordance with the *spCellConfigDedicated*;
 - 2> consider the bandwidth part indicated in *firstActiveUplinkBWP-Id* if configured to be the active uplink bandwidth part;
 - 2> consider the bandwidth part indicated in *firstActiveDownlinkBWP-Id* if configured to be the active downlink bandwidth part;
 - 2> if any of the reference signal(s) that are used for radio link monitoring are reconfigured by the received *spCellConfigDedicated*:
 - 3> stop timer T310 for the corresponding SpCell, if running;
 - 3> stop timer T312 for the corresponding SpCell, if running;
 - 3> reset the counters N310 and N311.

[TS 38.331, clause 5.3.5.6.4]

- 1> for each *drb-Identity* value included in the *drb-ToReleaseList* that is part of the current UE configuration; or
- 1> for each *drb-Identity* value that is to be released as the result of full configuration according to 5.3.5.11:
 - 2> release the PDCP entity and the *drb-Identity*;
 - 2> if SDAP entity associated with this DRB is configured:
 - 3> indicate the release of the DRB to SDAP entity associated with this DRB (TS 37.324 [24], clause 5.3.3);
 - 2> if the DRB is associated with an *eps-BearerIdentity*:
 - 3> if a new bearer is not added either with NR or E-UTRA with same *eps-BearerIdentity*:
 - 4> indicate the release of the DRB and the *eps-BearerIdentity* of the released DRB to upper layers.

NOTE 1: The UE does not consider the message as erroneous if the *drb-ToReleaseList* includes any *drb-Identity* value that is not part of the current UE configuration.

NOTE 2: Whether or not the RLC and MAC entities associated with this PDCP entity are reset or released is determined by the *CellGroupConfig*.

[TS 38.331, clause 5.3.5.6.5]

The UE shall:

- 1> for each *drb-Identity* value included in the *drb-ToAddModList* that is not part of the current UE configuration (DRB establishment including the case when full configuration option is used):
 - 2> establish a PDCP entity and configure it in accordance with the received *pdcp-Config*;
 - 2> if the PDCP entity of this DRB is not configured with *cipheringDisabled*:
 - 3> if target RAT of handover is E-UTRA/5GC; or
 - 3> if the UE is connected to E-UTRA/5GC:
 - 4> if the UE is capable of E-UTRA/5GC but not capable of NGEN-DC:
 - 5> configure the PDCP entity with the ciphering algorithm and K_{UPenc} key configured/derived as specified in TS 36.331 [10];
 - 4> else (i.e., a UE capable of NGEN-DC):
 - 5> configure the PDCP entity with the ciphering algorithms according to *securityConfig* and apply the key (K_{UPenc}) associated with the master key (K_{eNB}) or secondary key ($S-K_{eNB}$) as indicated in *keyToUse*, if applicable;

...

- 2> if the PDCP entity of this DRB is configured with *integrityProtection*:
 - 3> configure the PDCP entity with the integrity protection algorithms according to *securityConfig* and apply the K_{UPint} key associated with the master (K_{gNB}) or the secondary key ($S-K_{gNB}$) as indicated in *keyToUse*;
- 2> if an *sdap-Config* is included:
 - 3> if an SDAP entity with the received *pdu-Session* does not exist:
 - 4> establish an SDAP entity as specified in TS 37.324 [24] clause 5.1.1;
 - 4> if an SDAP entity with the received *pdu-Session* did not exist prior to receiving this reconfiguration:
 - 5> indicate the establishment of the user plane resources for the *pdu-Session* to upper layers;
 - 3> configure the SDAP entity in accordance with the received *sdap-Config* as specified in TS 37.324 [24] and associate the DRB with the SDAP entity;

...

- 1> for each *drb-Identity* value included in the *drb-ToAddModList* that is part of the current UE configuration and not configured with *dapsConfig*:
 - 2> if the *reestablishPDCP* is set:
 - 3> if target RAT is E-UTRA/5GC:, or;
 - 3> if the UE is only connected to E-UTRA/5GC:
 - 4> if the UE is capable of E-UTRA/5GC but not capable of NGEN-DC:
 - 5> if the PDCP entity of this DRB is not configured with *cipheringDisabled*:
 - 6> configure the PDCP entity with the ciphering algorithm and K_{UPenc} key configured/derived as specified in TS 36.331 [10], clause 5.4.2.3, i.e. the ciphering configuration shall be applied to all subsequent PDCP PDUs received and sent by the UE;
 - 4> else (i.e., a UE capable of NGEN-DC):
 - 5> if the PDCP entity of this DRB is not configured with *cipheringDisabled*:
 - 6> configure the PDCP entity with the ciphering algorithm and K_{UPenc} key associated with the master key (K_{eNB}) or the secondary key ($S-K_{gNB}$), as indicated in *keyToUse*, i.e. the ciphering configuration shall be applied to all subsequent PDCP PDUs received and sent by the UE;

...

- 2> else, if the *recoverPDCP* is set:
 - 3> trigger the PDCP entity of this DRB to perform data recovery as specified in TS 38.323 [5];
- 2> if the *pdcp-Config* is included:
 - 3> reconfigure the PDCP entity in accordance with the received *pdcp-Config*.
- 2> if the *sdap-Config* is included:
 - 3> reconfigure the SDAP entity in accordance with the received *sdap-Config* as specified in TS37.324 [24];
 - 3> for each QFI value added in *mappedQoS-FlowsToAdd*, if the QFI value is previously configured, the QFI value is released from the old DRB;

NOTE 1: Void.

- NOTE 2: When determining whether a *drb-Identity* value is part of the current UE configuration, the UE does not distinguish which *RadioBearerConfig* and *DRB-ToAddModList* that DRB was originally configured in. To re-associate a DRB with a different key (K_{eNB} to $S-K_{gNB}$, K_{gNB} to $S-K_{eNB}$, K_{gNB} to $S-K_{gNB}$, or vice versa), the network provides the *drb-Identity* value in the (target) *drb-ToAddModList* and sets the *reestablishPDCP* flag. The network does not list the *drb-Identity* in the (source) *drb-ToReleaseList*.
- NOTE 3: When setting the *reestablishPDCP* flag for a radio bearer, the network ensures that the RLC receiver entities do not deliver old PDCP PDUs to the re-established PDCP entity. It does that e.g. by triggering a reconfiguration with sync of the cell group hosting the old RLC entity or by releasing the old RLC entity.
- NOTE 4: In this specification, UE configuration refers to the parameters configured by NR RRC unless otherwise stated.
- NOTE 5: Ciphering and integrity protection can be enabled or disabled for a DRB. The enabling/disabling of ciphering or integrity protection can be changed only by releasing and adding the DRB.

8.2.2.5.2.3 Test description

8.2.2.5.2.3.1 Pre-test conditions

System Simulator:

- NR Cell 1 is the PCell and NR Cell 10 is the PSCell.

UE:

- None.

Preamble:

- If *pc_IP_Ping* is set to TRUE then, the UE is in state NR RRC_CONNECTED using generic procedure parameter Connectivity (*NR*), according to TS 38.508-1 [4], clause 4.5.4.
- Else, the UE is in state NR RRC_CONNECTED using generic procedure parameter Connectivity (*NR*), Test Mode (*On*) associated with UE test loop mode B configured on NR Cell 1 according to TS 38.508-1 [4], clause 4.5.4.

8.2.2.5.2.3.2 Test procedure sequence

Table 8.2.2.5.2.3.2-1: Main behaviour

St	Procedure	Message Sequence		TP	Verdict
		U - S	Message		
1	The SS transmits an <i>RRCReconfiguration</i> containing <i>RRCReconfiguration-SCG</i> message and a PDU SESSION MODIFICATION COMMAND to add <i>NR PSCell</i> with Split DRB.	<--	NR RRC: <i>RRCReconfiguration</i> 5GMM: DL NAS TRANSPORT 5GSM: PDU SESSION MODIFICATION COMMAND	-	-
2	Check: Does the UE transmit an <i>RRCReconfigurationComplete</i> message including <i>nr-SCG-Response</i> ?	-->	<i>RRCReconfigurationComplete</i>	1	P
2A	The UE transmits a <i>ULInformationTransfer</i> message and an PDU SESSION MODIFICATION COMPLETE message.	-->	NR RRC: <i>ULInformationTransfer</i> 5GMM: UL NAS TRANSPORT 5GSM: PDU SESSION MODIFICATION COMPLETE	-	-
3	Check: Does the test result of generic test procedure in TS 38.508-1 subclause 4.9.1 indicate that the UE is capable of exchanging IP data on Split DRB over the SCG path?	-	-	1	P
4	SS transmits <i>RRCReconfiguration</i> message containing NR <i>RadioBearerConfig</i> to modify PDCP discardTimer value of Split DRB.	<--	<i>RRCReconfiguration</i>	-	-
5	Check: Does the UE transmit an <i>RRCReconfigurationComplete</i> message including <i>nr-SCG-Response</i> ?	-->	<i>RRCReconfigurationComplete</i>	2	P
6	Check: Does the test result of generic test procedure in TS 38.508-1 subclause 4.9.1 indicate that the UE is capable of exchanging IP data on Split DRB over the SCG path?	-	-	2	P
7	SS transmits <i>RRCReconfiguration</i> message containing NR <i>RadioBearerConfig</i> to release PSCell and Split DRB.	<--	<i>RRCReconfiguration</i>	-	-
8	Check: Does the UE transmit an <i>RRCReconfigurationComplete</i> message?	-->	<i>RRCReconfigurationComplete</i>	3	P

8.2.2.5.2.3.3 Specific message contents

Table 8.2.2.5.2.3.3-1: RRCReconfiguration (step 1, Table 8.2.2.5.2.3.2-1)

Derivation Path: 38.508-1 [4], Table 4.6.1-13			
Information Element	Value/remark	Comment	Condition
RRCReconfiguration ::= SEQUENCE {			
criticalExtensions CHOICE {			
rrcReconfiguration SEQUENCE {			
nonCriticalExtension SEQUENCE {			
masterCellGroup	CellGroupConfig as defined in TS 38.508-1 [4], Table 4.6.1-19 with condition DRBn	SCG DRBn added in master cell group	
nonCriticalExtension SEQUENCE {			
mrdc-SecondaryCellGroupConfig CHOICE {			
setup SEQUENCE {			
mrdc-SecondaryCellGroup CHOICE {			
nr-SCG	OCTET STRING (CONTAINING RRCReconfiguration) as defined in TS 38.508-1 [4], Table 4.6.1-13 with condition NR-DC_SCG		
}			
}			
}			
radioBearerConfig2	OCTET STRING (CONTAINING RadioBearerConfig) as defined in TS 38.508-1 [4], with condition DRBn, Split and SecondaryKeys		
}			
}			
}			
}			
}			

Table 8.2.2.4.5.3.3-1A: PDU SESSION MODIFICATION COMMAND (step 1, Table 8.2.2.5.2.3.2-1)

Derivation Path: TS 38.508-1 [4], Table 4.7.2-9.			
Information Element	Value/remark	Comment	Condition
PDU session ID	The same as the PDU session ID in PDU SESSION ESTABLISHMENT REQUEST associated with the Internet PDU session if available or with the first PDU session		
Authorized QoS rules	One entry		
QoS rule [1]	Reference QoS rule #5 as defined in TS 38.508-1 [4], Table 4.8.2.1-5.	QFI=5	
Authorized QoS flow descriptions	One entry		
QoS flow [1]	Reference QoS flow #5 as defined in TS 38.508-1 [4], Table 4.8.2.3-5.	QFI=5	

Table 8.2.2.5.2.3.3-2: Void

Table 8.2.2.5.2.3.3-3: *Void*Table 8.2.2.5.2.3.3-4: *RRCReconfiguration* (step 4, Table 8.2.2.5.2.3.2-1)

Derivation Path: 38.508-1 [4], Table 4.6.1-13			
Information Element	Value/remark	Comment	Condition
RRCReconfiguration ::= SEQUENCE {			
criticalExtensions CHOICE {			
rrcReconfiguration SEQUENCE {			
nonCriticalExtension SEQUENCE {			
nonCriticalExtension SEQUENCE {			
radioBearerConfig2	OCTET STRING (CONTAINING RadioBearerConfig_SCG -Mod)		
}			
}			
}			
}			

Table 8.2.2.5.2.3.3-5: *RadioBearerConfig_SCG-Mod* (Table 8.2.2.5.2.3.3-4)

Derivation Path: 38.508-1 [4], Table 4.6.3-132			
Information Element	Value/remark	Comment	Condition
RadioBearerConfig ::= SEQUENCE {			
drb-ToAddModList SEQUENCE (SIZE (1..maxDRB)) OF DRB-ToAddMod {	1 entry		
DRB-ToAddMod[1] SEQUENCE {		entry 1	
drb-Identity	DRBn	n set to the same DRB ID as in Table 8.2.2.5.2.3.3-2	
pdcp-Config	PDCP-Config		
}			
}			
}			

Table 8.2.2.5.2.3.3-6: *PDCP-Config* (Table 8.2.2.5.2.3.3-5)

Derivation Path: 38.508-1 [4], Table 4.6.3-99			
Information Element	Value/remark	Comment	Condition
PDCP-Config ::= SEQUENCE {			
drb SEQUENCE {			
discardTimer	ms500	Other than default value.	
}			
}			

Table 8.2.2.5.2.3.3-7: RRCReconfiguration (step 7, Table 8.2.2.5.2.3.2-1)

Derivation Path: 38.508 [4], Table 4.6.1-13			
Information Element	Value/remark	Comment	Condition
RRCReconfiguration ::= SEQUENCE {			
criticalExtensions CHOICE {			
rrcReconfiguration SEQUENCE {			
nonCriticalExtension SEQUENCE {			
masterCellGroup	CellGroupConfig_Split_R LC-Rel		
nonCriticalExtension SEQUENCE {			
mrdc-SecondaryCellGroupConfig CHOICE {			
setup SEQUENCE {			
mrdc-ReleaseAndAdd	true		
}			
}			
radioBearerConfig2	OCTET STRING (CONTAINING RadioBearerConfig_SCG -Rel)		
}			
}			
}			
}			
}			

Table 8.2.2.5.2.3.3-8: RadioBearerConfig_SCG-Rel (Table 8.2.2.5.2.3.3-7)

Derivation Path: 38.508-1 [4], Table 4.6.3-132			
Information Element	Value/remark	Comment	Condition
RadioBearerConfig ::= SEQUENCE {			
drb-ToReleaseList	DRBn	n set to the same DRB ID as in Table 8.2.2.5.2.3.3-2	
}			

Table 8.2.2.5.2.3.3-9: CellGroupConfig_Split_RLC-Rel (Table 8.2.2.5.2.3.3-7)

Derivation Path: 38.508-1 [4], Table 4.6.3-19			
Information Element	Value/remark	Comment	Condition
CellGroupConfig ::= SEQUENCE {			
rlc-BearerToReleaseList SEQUENCE {	1 entry		
logicalChannelIdentity	LogicalChannelIdentity with condition DRBn	n is set to the same DRB ID as in Table 8.2.2.5.2.3.3-2	
}			
}			

Table 8.2.2.5.2.3.3-10: RRCReconfigurationComplete (step 2 and 5, Table 8.2.2.5.2.3.2-1)

Derivation Path: 38.508 [4], Table 4.6.1-14 with condition NR-DC			

8.2.2.6 Bearer Modification / MCG DRB

8.2.2.6.1 Bearer Modification / MCG DRB / SRB / PDCP version change / EN-DC

8.2.2.6.1.1 Test Purpose (TP)

(1)

```
with { UE in RRC_CONNECTED state with EN-DC, and, MCG(s) (E-UTRA PDCP) only }
ensure that {
  when { UE receives an RRCConnectionReconfiguration with mobility message to change PDCP version of
the SRB1 and SRB2 from E-UTRA PDCP to NR PDCP }
  then { UE performs PDCP version change and sends an RRCConnectionReconfigurationComplete message
}
}
```

(2)

```
with { UE in RRC_CONNECTED state with EN-DC, and, MCG(s) (E-UTRA PDCP) only with SRB1 and SRB2 using
NR PDCP }
ensure that {
  when { UE receives an RRCConnectionReconfiguration with mobility message to change PDCP version of
the MCG DRB from E-UTRA PDCP to NR PDCP }
  then { UE performs PDCP version change and sends an RRCConnectionReconfigurationComplete message
}
}
```

(3)

```
with { UE in RRC_CONNECTED state with EN-DC, and, MCG(s) (NR PDCP) only with SRB1 and SRB2 using NR
PDCP }
ensure that {
  when { UE receives an RRCConnectionReconfiguration with mobility message to change PDCP version of
the MCG DRB from NR PDCP to E-UTRA PDCP }
  then { UE performs PDCP version change and sends an RRCConnectionReconfigurationComplete message
}
}
```

(4)

```
with { UE in RRC_CONNECTED state with EN-DC, and, MCG(s) (E-UTRA PDCP) only with SRB1 and SRB2 using
NR PDCP }
ensure that {
  when { UE receives an RRCConnectionReconfiguration with mobility message to change PDCP version of
the SRB1 and SRB2 from NR PDCP to E-UTRA PDCP }
  then { UE performs PDCP version change and sends an RRCConnectionReconfigurationComplete message
}
}
```

8.2.2.6.1.2 Conformance requirements

References: The conformance requirements covered in the present TC are specified in: TS 36.331, clause 5.3.1.1, 5.3.5.4 and 5.3.10.3, TS 38.331, clauses 5.3.5.3, 5.3.5.5, 5.3.5.5.7, 5.3.5.6, 5.3.5.6.3 and 5.3.5.6.5. Unless otherwise stated these are Rel-15 requirements.

[TS 36.331, clause 5.3.1.1]

Change to NR PDCP or vice versa, for both SRBs and DRBs, can be performed using an *RRCConnectionReconfiguration* message including the *mobilityControlInfo* (handover) by release and addition of the concerned RB (for DRBs) or of the concerned PDCP entity (for SRBs). The same *RRCConnectionReconfiguration* message may be used to make changes regarding the CG(s) used for transmission. For SRBs, change from E-UTRA PDCP to NR PDCP type may, before initial security activation, also be performed using an *RRCConnectionReconfiguration* message not including the *mobilityControlInfo*.

[TS 36.331, clause 5.3.5.4]

If the *RRCConnectionReconfiguration* message includes the *mobilityControlInfo* and the UE is able to comply with the configuration included in this message, the UE shall:

- 1> stop timer T310, if running;
- 1> stop timer T312, if running;
- 1> start timer T304 with the timer value set to *t304*, as included in the *mobilityControlInfo*;
- 1> stop timer T370, if running;
- 1> if the *carrierFreq* is included:
 - 2> consider the target PCell to be one on the frequency indicated by the *carrierFreq* with a physical cell identity indicated by the *targetPhysCellId*;
- 1> else:
 - 2> consider the target PCell to be one on the frequency of the source PCell with a physical cell identity indicated by the *targetPhysCellId*;
- 1> start synchronising to the DL of the target PCell;

NOTE 1: The UE should perform the handover as soon as possible following the reception of the RRC message triggering the handover, which could be before confirming successful reception (HARQ and ARQ) of this message.

- 1> reset MCG MAC and SCG MAC, if configured;
- 1> re-establish PDCP for all RBs configured with *pdcp-config* that are established;

NOTE 2: The handling of the radio bearers after the successful completion of the PDCP re-establishment, e.g. the re-transmission of unacknowledged PDCP SDUs (as well as the associated status reporting), the handling of the SN and the HFN, is specified in TS 36.323 [8].

- 1> re-establish MCG RLC and SCG RLC, if configured, for all RBs that are established;
- 1> apply the value of the *newUE-Identity* as the C-RNTI;
- 1> configure lower layers in accordance with the received *radioResourceConfigCommon*;
- 1> configure lower layers in accordance with any additional fields, not covered in the previous, if included in the received *mobilityControlInfo*;
- 1> if the *RRCCONNECTIONRECONFIGURATION* message includes the *radioResourceConfigDedicated*:
 - 2> perform the radio resource configuration procedure as specified in 5.3.10;
- 2> store the *nextHopChainingCount* value;
- 2> else:
 - 3> derive the K_{RRCint} key associated with the current integrity algorithm, as specified in TS 33.401 [32];
 - 3> if connected as an RN:
 - 4> derive the K_{UPint} key associated with the current integrity algorithm, as specified in TS 33.401 [32];
 - 3> derive the K_{RRCenc} key and the K_{UPenc} key associated with the current ciphering algorithm, as specified in TS 33.401 [32];
- 1> configure lower layers to apply the integrity protection algorithm and the K_{RRCint} key, i.e. the integrity protection configuration shall be applied to all subsequent messages received and sent by the UE, including the message used to indicate the successful completion of the procedure;
- 1> configure lower layers to apply the ciphering algorithm, the K_{RRCenc} key and the K_{UPenc} key, i.e. the ciphering configuration shall be applied to all subsequent messages received and sent by the UE, including the message used to indicate the successful completion of the procedure;
- 1> if the received *RRCCONNECTIONRECONFIGURATION* includes the *nr-RadioBearerConfig1*:

- 2> perform radio bearer configuration as specified in TS 38.331 [82, 5.3.5.6];
 - 1> set the content of *RRCCConnectionReconfigurationComplete* message as follows:
 - 2> else if the UE has logged measurements available for E-UTRA and if the RPLMN is included in *plmn-IdentityList* stored in *VarLogMeasReport*:
 - 3> include the *logMeasAvailable*;
 - 2> if the UE has connection establishment failure information available in *VarConnEstFailReport* and if the RPLMN is equal to *plmn-Identity* stored in *VarConnEstFailReport*:
 - 3> include *connEstFailInfoAvailable*;
 - 2> if the *RRCCConnectionReconfiguration* message includes *perCC-GapIndicationRequest*:
 - 3> include *perCC-GapIndicationList* and *numFreqEffective*;
 - 2> if the frequencies are configured for reduced measurement performance:
 - 3> include *numFreqEffectiveReduced*;
 - 2> if the received *RRCCConnectionReconfiguration* message included *nr-SecondaryCellGroupConfig*:
 - 3> include *scg-ConfigResponseNR* in accordance with TS 38.331 [82, 5.3.5.3];
 - 1> submit the *RRCCConnectionReconfigurationComplete* message to lower layers for transmission;
 - 1> if MAC successfully completes the random access procedure; or
- [TS 36.331, clause 5.3.10.3]

The UE shall:

- 1> for each *drb-Identity* value included in the *drb-ToAddModList* that is part of the current UE configuration (DRB reconfiguration):
 - 2> if *drb-ToAddModListSCG* is not received or does not include the *drb-Identity* value:
 - 3> if the DRB indicated by *drb-Identity* is an MCG DRB or configured with MCG RLC bearer in EN-DC (reconfigure MCG RLC bearer for EN-DC or reconfigure MCG DRB):
 - 4> if the *pdcp-Config* is included:
 - 5> reconfigure the PDCP entity in accordance with the received *pdcp-Config*;
 - 4> if the *rlc-Config* is included:
 - 5> if *reestablishRLC* is received, re-establish the RLC entity of this DRB;
 - 5> reconfigure the RLC entity or entities in accordance with the received *rlc-Config*;
 - 4> if the *logicalChannelConfig* is included:
 - 5> reconfigure the DTCH logical channel in accordance with the received *logicalChannelConfig*;

NOTE: Removal and addition of the same *drb-Identity* in a single *radioResourceConfigDedicated* is not supported. In case *drb-Identity* is removed and added due to handover or re-establishment with the full configuration option, the eNB can use the same value of *drb-Identity*.

[TS 38.331, clause 5.3.5.3]

The UE shall perform the following actions upon reception of the *RRCCReconfiguration*:

- 1> if the *RRCCReconfiguration* message contains the *radioBearerConfig*:
 - 2> perform the radio bearer configuration according to 5.3.5.6;

- 1> if the *RRCReconfiguration* message includes the *measConfig*:
 - 2> perform the measurement configuration procedure as specified in 5.5.2;
- 1> if the UE is configured with E-UTRA *nr-SecondaryCellGroupConfig* (MCG is E-UTRA):
 - 2> if *RRCReconfiguration* was received via SRB1:
 - 3> construct *RRCReconfigurationComplete* message and submit it via the EUTRA MCG embedded in E-UTRA RRC message *RRCConnectionReconfigurationComplete* as specified in TS 36.331 [10];
 - 3> if *reconfigurationWithSync* was included in *spCellConfig* of an SCG:
 - 4> initiate the random access procedure on the SpCell, as specified in TS 38.321 [3];
 - 2> else (*RRCReconfiguration* was received via SRB3):
 - 3> submit the *RRCReconfigurationComplete* message via SRB3 to lower layers for transmission using the new configuration;

NOTE: In the case of SRB1, the random access is triggered by RRC layer itself as there is not necessarily other UL transmission. In the case of SRB3, the random access is triggered by the MAC layer due to arrival of *RRCReconfigurationComplete*.

- 1> if MAC of an NR cell group successfully completes a random access procedure triggered above:
 - 2> stop timer T304 for that cell group;
 - 2> apply the parts of the CQI reporting configuration, the scheduling request configuration and the sounding RS configuration that do not require the UE to know the SFN of the respective target SpCell, if any;
 - 2> apply the parts of the measurement and the radio resource configuration that require the UE to know the SFN of the respective target SpCell (e.g. measurement gaps, periodic CQI reporting, scheduling request configuration, sounding RS configuration), if any, upon acquiring the SFN of that target SpCell;
 - 2> the procedure ends.

[TS 38.331, clause 5.3.5.6.3]

The UE shall:

- 1> for each *srb-Identity* value included in the *srb-ToAddModList* that is not part of the current UE configuration (SRB establishment or reconfiguration from E-UTRA PDCP to NR PDCP):
 - 2> establish a PDCP entity and configure it with the security algorithms according to *securityConfig* and apply the keys (K_{RRCenc} and K_{RRCint}) associated with the master key (K_{eNB}/ K_{gNB}) or secondary key ($S-K_{gNB}$) as indicated in *keyToUse*, if applicable;
 - 2> if the current UE configuration as configured by E-UTRA in TS 36.331 includes an SRB identified with the same *srb-Identity* value:
 - 3> associate the E-UTRA RLC entity and DCCH of this SRB with the NR PDCP entity;
 - 3> release the E-UTRA PDCP entity of this SRB;
 - 2> if the *pdcp-Config* is included:
 - 3> configure the PDCP entity in accordance with the received *pdcp-Config*;
 - 2> else:
 - 3> configure the PDCP entity in accordance with the default configuration defined in 9.2.1 for the corresponding SRB;
- 1> for each *srb-Identity* value included in the *srb-ToAddModList* that is part of the current UE configuration:
 - 2> if the *reestablishPDCP* is set:

- 3> configure the PDCP entity to apply the integrity protection algorithm and K_{RRCint} key associated with the K_{eNB/S-KgNB} as indicated in *keyToUse*, i.e. the integrity protection configuration shall be applied to all subsequent messages received and sent by the UE, including the message used to indicate the successful completion of the procedure;
- 3> configure the PDCP entity to apply the ciphering algorithm and K_{RRCenc} key associated with the K_{eNB/S-KgNB} as indicated in *keyToUse*, i.e. the ciphering configuration shall be applied to all subsequent messages received and sent by the UE, including the message used to indicate the successful completion of the procedure;
- 3> re-establish the PDCP entity of this SRB as specified in 38.323 [5];
- 2> else, if the *discardOnPDCP* is set:
 - 3> trigger the PDCP entity to perform SDU discard as specified in TS 38.323 [5];
- 2> if the *pdcp-Config* is included:
 - 3> reconfigure the PDCP entity in accordance with the received *pdcp-Config*.

[TS 38.331, clause 5.3.5.6.5]

The UE shall:

- 1> for each *drb-Identity* value included in the *drb-ToAddModList* that is not part of the current UE configuration (DRB establishment including the case when full configuration option is used):
 - 2> establish a PDCP entity and configure it in accordance with the received *pdcp-Config*;
 - 2> configure the PDCP entity with the ciphering algorithms according to *securityConfig* and apply the K_{UPenc} key associated with the master key (K_{eNB/KgNB}) or the secondary key (S-K_{gNB}) as indicated in *keyToUse*;
 - 2> if the DRB was configured with the same *eps-BearerIdentity* either by NR or E-UTRA prior to receiving this reconfiguration:
 - 3> associate the established DRB with the corresponding *eps-BearerIdentity*;
 - 2> else:
 - 3> indicate the establishment of the DRB(s) and the *eps-BearerIdentity* of the established DRB(s) to upper layers;
- 1> for each *drb-Identity* value included in the *drb-ToAddModList* that is part of the current UE configuration:
 - 2> if the *reestablishPDCP* is set:
 - 3> configure the PDCP entity with the ciphering algorithm and K_{UPenc} key associated with the master or secondary key (K_{eNB/S-KgNB/KgNB}) as indicated in *keyToUse*, i.e. the ciphering configuration shall be applied to all subsequent PDCP PDUs received and sent by the UE;
 - 3> re-establish the PDCP entity of this DRB as specified in 38.323 [5], section 5.1.2;
 - 2> else, if the *recoverPDCP* is set:
 - 3> trigger the PDCP entity of this DRB to perform data recovery as specified in 38.323;
 - 2> if the *pdcp-Config* is included:
 - 3> reconfigure the PDCP entity in accordance with the received *pdcp-Config*.

NOTE 1: Removal and addition of the same *drb-Identity* in a single *radioResourceConfig* is not supported. In case *drb-Identity* is removed and added due to reconfiguration with sync or re-establishment with the full configuration option, the network can use the same value of *drb-Identity*.

NOTE 2: When determining whether a *drb-Identity* value is part of the current UE configuration, the UE does not distinguish which *RadioBearerConfig* and *DRB-ToAddModList* that DRB was originally configured in. To re-associate a DRB with a different key (KeNB to S-KeNB or vice versa), the network provides the *drb-Identity* value in the (target) *drb-ToAddModList* and sets the *reestablishPDCP* flag. The network does not list the *drb-Identity* in the (source) *drb-ToReleaseList*.

NOTE 3: When setting the *reestablishPDCP* flag for a radio bearer, the network ensures that the RLC receiver entities do not deliver old PDCP PDUs to the re-established PDCP entity. It does that e.g. by triggering a reconfiguration with sync of the cell group hosting the old RLC entity or by releasing the old RLC entity.

NOTE 4: In this specification, UE configuration refers to the parameters configured by NR RRC unless otherwise stated.

8.2.2.6.1.3 Test description

8.2.2.6.1.3.1 Pre-test conditions

System Simulator:

- EUTRA Cell 1 is the PCell and NR Cell 1 is the PS Cell.

UE:

- None

Preamble:

- If *pc_IP_Ping* is set to TRUE then, the UE is in state RRC_CONNECTED using generic procedure parameter Connectivity (EN-DC), Bearers (MCG(s) only) established according to TS 38.508-1 [4], clause 4.5.4.
- Else, the UE is in state RRC_CONNECTED using generic procedure parameter Connectivity (EN-DC), Bearers (MCG(s) only) and Test Mode (On) associated with UE test loop mode B configured on E-UTRA Cell 1 according to TS 38.508-1 [4], clause 4.5.4.

8.2.2.6.1.3.2 Test procedure sequence

Table 8.2.2.6.1.3.2-1: Main behaviour

St	Procedure	Message Sequence		TP	Verdict
		U - S	Message		
1	The SS transmits an <i>RRCCONNECTIONRECONFIGURATION</i> message including <i>MOBILITYCONTROLLINFO</i> IE on E-UTRA Cell 1 to reconfigure SRB1 and SRB2 from E-UTRA PDCP to NR PDCP	<--	<i>RRCCONNECTIONRECONFIGURATION</i>	-	-
2	Check: Does the UE transmit an <i>RRCCONNECTIONRECONFIGURATIONCOMPLETE</i> message?	-->	<i>RRCCONNECTIONRECONFIGURATIONCOMPLETE</i>	1	P
-	EXCEPTION: Steps 3a1 to 3a2 describe behaviour that depends on the UE implementation; the "lower case letter" identifies a step sequence that take place depending on the UE implementation.	-	-	-	-
3a1	IF <i>pc_IP_Ping</i> = FALSE, then, the SS transmits a CLOSE UE TEST LOOP message.	<--	CLOSE UE TEST LOOP	-	-
3a2	The UE transmits a CLOSE UE TEST LOOP COMPLETE message.	-->	CLOSE UE TEST LOOP COMPLETE		
4	The SS transmits an <i>RRCCONNECTIONRECONFIGURATION</i> message including <i>MOBILITYCONTROLLINFO</i> IE on E-UTRA Cell 1 to reconfigure MCG DRB from E-UTRA PDCP to NR PDCP?	<--	<i>RRCCONNECTIONRECONFIGURATION</i>	-	-
5	Check: Does the UE transmit an <i>RRCCONNECTIONRECONFIGURATIONCOMPLETE</i> message? NOTE: <i>RRCCONNECTIONRECONFIGURATION</i> is transmitted using SRB1. This implicitly verifies SRB1 PDCP version change.	-->	<i>RRCCONNECTIONRECONFIGURATIONCOMPLETE</i>	1, 2	P
6	Check: Does the test result of generic test procedure in TS 38.508-1 subclause 4.9.1 indicate that the UE is capable of exchanging IP data on MCG DRB using NR radio path?	-	-	2	P
7	The SS transmits an <i>RRCCONNECTIONRECONFIGURATION</i> message including <i>MOBILITYCONTROLLINFO</i> IE on E-UTRA Cell 1 to reconfigure MCG DRB from NR PDCP to E-UTRA PDCP?	<--	<i>RRCCONNECTIONRECONFIGURATION</i>	-	-
8	Check: Does the UE transmit an <i>RRCCONNECTIONRECONFIGURATIONCOMPLETE</i> message?	-->	<i>RRCCONNECTIONRECONFIGURATIONCOMPLETE</i>	3	P
9	Check: Does the test result of generic test procedure in TS 38.508-1 subclause 4.9.1 indicate that the UE is capable of exchanging IP data on MCG DRB using EUTRA radio path?	-	-	3	P
10	The SS transmits an <i>RRCCONNECTIONRECONFIGURATION</i> message including <i>MOBILITYCONTROLLINFO</i> IE on E-UTRA Cell 1 to reconfigure SRB1 and SRB2 from NR PDCP to E-UTRA PDCP.	<--	<i>RRCCONNECTIONRECONFIGURATION</i>	-	-
11	Check: Does the UE transmit an <i>RRCCONNECTIONRECONFIGURATIONCOMPLETE</i> message?	-->	<i>RRCCONNECTIONRECONFIGURATIONCOMPLETE</i>	4	P

8.2.2.6.1.3.3 Specific message contents

Table 8.2.2.6.1.3.3-1: RRCConnectionReconfiguration (step 1, Table 8.2.2.6.1.3.2-1)

Derivation Path: 36.508 [7], Table 4.6.1-8 with condition HO			
Information Element	Value/remark	Comment	Condition
RRCConnectionReconfiguration ::= SEQUENCE {			
criticalExtensions CHOICE {			
c1 CHOICE{			
rrcConnectionReconfiguration-r8 SEQUENCE {			
mobilityControlInfo	MobilityControlInfo-HO-SameCell	As per Table 8.2.2.6.1.3.3-2	
nonCriticalExtension SEQUENCE {			
nonCriticalExtension SEQUENCE {			
nonCriticalExtension SEQUENCE {			
nonCriticalExtension SEQUENCE {			
nonCriticalExtension SEQUENCE {			
nonCriticalExtension SEQUENCE {			
nonCriticalExtension SEQUENCE {			
nr-Config-r15	Not present		
nr-RadioBearerConfig1-r15	OCTET STRING containing RadioBearerConfig-MCG-SRB	As per Table 8.2.2.6.1.3.3-3	
}			
}			
}			
}			
}			
}			
}			
}			
}			
}			
}			
}			
}			
}			
}			
}			
}			

Table 8.2.2.6.1.3.3-2: MobilityControlInfo-HO-SameCell (Table 8.2.2.6.1.3.3-1)

Derivation Path: 36.508 [7], Table 4.6.5-1			
Information Element	Value/remark	Comment	Condition
MobilityControlInfo-HO ::= SEQUENCE {			
targetPhysCellId	PhysicalCellIdentity of E-UTRA Cell 1		
carrierFreq	Not present		
}			

Table 8.2.2.6.1.3.3-3: RadioBearerConfig-MCG-SRB (Table 8.2.2.6.1.3.3-1)

Derivation Path: 38.508-1 [4], Table 4.6.3-132 with condition SRB_NR_PDCP			

Table 8.2.2.6.1.3.3-5: RadioResourceConfigDedicated-MCG-DRB-NR-PDCP (Table 8.2.2.6.1.3.3-4)

Derivation Path: 36.508 [7], Table 4.6.3-19			
Information Element	Value/remark	Comment	Condition
RadioResourceConfigDedicated-MCG-DRB-NR-PDCP ::= SEQUENCE {			
drb-ToAddModList SEQUENCE (SIZE (1..maxDRB))	1 entry		
OF DRB-ToAddMod {			
DRB-ToAddMod[1]	DRB-ToAddMod-MCG-DRB-NR-PDCP	entry 1 As per Table 8.2.2.6.1.3.3-6	
}			
drb-ToReleaseList SEQUENCE (SIZE (1..maxDRB))	1 entry		
OF DRB-Identity {			
DRB-Identity[1]	Same as the DRB identity associated with the default EPS bearer	entry 1	
}			
physicalConfigDedicated	PhysicalConfigDedicated -DEFAULT with condition RBC-HO		
}			

Table 8.2.2.6.1.3.3-6: DRB-ToAddMod-MCG-DRB-NR-PDCP (Table 8.2.2.6.1.3.3-5)

Derivation Path: 36.508 [7], Table 4.8.2.1.7-1			
Information Element	Value/remark	Comment	Condition
DRB-ToAddMod ::= SEQUENCE {			
eps-BearerIdentity	Same as the default EPS bearer Identity		
drb-Identity	Same as the DRB identity associated with the default EPS bearer		
pdcp-Config	Not present		
}			

Table 8.2.2.6.1.3.3-7: Void

Table 8.2.2.6.1.3.3-8: RRCConnectionReconfiguration (step 7, Table 8.2.2.6.1.3.2-1)

Derivation Path: 36.508 [4], Table 4.6.1-8 with condition HO			
Information Element	Value/remark	Comment	Condition
RRCConnectionReconfiguration ::= SEQUENCE {			
criticalExtensions CHOICE {			
c1 CHOICE {			
rrcConnectionReconfiguration-r8 SEQUENCE {			
mobilityControlInfo	MobilityControlInfo-HO-SameCell	As per Table 8.2.2.6.1.3.3-2	
radioResourceConfigDedicated	RadioResourceConfigDedicated-DRB-AddMod	As per Table 8.2.2.6.1.3.3-9	
nonCriticalExtension SEQUENCE {			
nonCriticalExtension SEQUENCE {			
nonCriticalExtension SEQUENCE {			
nonCriticalExtension SEQUENCE {			
nonCriticalExtension SEQUENCE {			
nonCriticalExtension SEQUENCE {			
nonCriticalExtension SEQUENCE {			
nr-Config-r15	Not present		
nr-RadioBearerConfig1-r15	OCTET STRING containing RadioBearerConfig-MCG-DRB-RELEASE	As per Table 8.2.2.6.1.3.3-10	
}			
}			
}			
}			
}			
}			
}			
}			
}			
}			
}			
}			
}			
}			

Table 8.2.2.6.1.3.3-9: RadioResourceConfigDedicated-DRB-AddMod (Table 8.2.2.6.1.3.3-8)

Derivation Path: 36.508 [7], Table 4.6.3-17 using DRB configuration from Table 4.8.2.1.7-1 with condition AM			
Information Element	Value/remark	Comment	Condition
RadioResourceConfigDedicated-DRB ::= SEQUENCE {			
drb-ToAddModList SEQUENCE (SIZE (1..maxDRB)) OF DRB-ToAddMod {	1 entry		
DRB-ToAddMod[1] SEQUENCE {		entry 1	
drb-Identity	Same as the DRB associated with the default EPS bearer		
}			
}			
physicalConfigDedicated	PhysicalConfigDedicated-DEFAULT using condition RBC-HO		
}			

Table 8.2.2.6.1.3.3-10 RadioBearerConfig-MCG-DRB-RELEASE (Table 8.2.2.6.1.3.3-8)

Derivation Path: 38.508-1 [4], Table 4.6.3-132 with condition SRB_NR_PDCP AND Re-establish_PDCP			
Information Element	Value/remark	Comment	Condition
RadioBearerConfig ::= SEQUENCE {			
drb-ToReleaseList SEQUENCE (SIZE (1.. maxDRB)) OF DRB-Identity {	1 entry		
DRB-Identity[1]	Same as the DRB associated with the default EPS bearer	entry 1	
}			
}			

Table 8.2.2.6.1.3.3-11: RRCConnectionReconfiguration (step 10, Table 8.2.2.6.1.3.2-1)

Derivation Path: 36.508 [7], Table 4.6.1-8 with Condition HO			
Information Element	Value/remark	Comment	Condition
RRCConnectionReconfiguration ::= SEQUENCE {			
criticalExtensions CHOICE {			
c1 CHOICE {			
rrcConnectionReconfiguration-r8 SEQUENCE {			
mobilityControlInfo	MobilityControlInfo-HO-SameCell	As per Table 8.2.2.6.1.3.3-2	
radioResourceConfigDedicated	RadioResourceConfigDedicated-SRB-AddMod	As per Table 8.2.2.6.1.3.3-12	
}			
}			
}			
}			

Table 8.2.2.6.1.3.3-12 RadioResourceConfigDedicated-SRB-AddMod (Table 8.2.2.6.1.3.3-11)

Derivation Path: 36.508 [7], Table 4.6.3-19			
Information Element	Value/remark	Comment	Condition
RadioResourceConfigDedicated-SRB-AddMod ::= SEQUENCE {	2 entries		
srb-ToAddModList SEQUENCE (SIZE (1..2)) OF SRB-ToAddMod {			
SRB-ToAddMod[1] SEQUENCE {		entry 1	
srb-Identity	Same as the SRB associated with SRB1		
pdcp-verChange-r15	True		
}			
SRB-ToAddMod[2] SEQUENCE {		entry 2	
srb-Identity	Same as the SRB associated with SRB2		
pdcp-verChange-r15	True		
}			
}			
}			

8.2.2.7 Bearer Modification / Handling for bearer type change without security key change

8.2.2.7.1 Bearer Modification / Handling for bearer type change without security key change / EN-DC

8.2.2.7.1.1 Test Purpose (TP)

(1)

```
with { UE in RRC_CONNECTED state with EN-DC, and, MCG(s) (E-UTRA PDCP) and SCG }
ensure that {
  when { UE receives an RRCConnectionReconfiguration message to modify SCG DRB to Split DRB }
  then { UE reconfigures the DRB and sends an RRCConnectionReconfigurationComplete message }
}
```

(2)

```
with { UE in RRC_CONNECTED state with EN-DC, and, MCG(s) (E-UTRA PDCP) and Split }
ensure that {
  when { UE receives an RRCConnectionReconfiguration message to modify Split DRB to MCG DRB (NR PDCP) }
  then { UE reconfigures the DRB and sends an RRCConnectionReconfigurationComplete message }
}
```

(3)

```
with { UE in RRC_CONNECTED state with EN-DC, and, MCG(s) (E-UTRA PDCP) and MCG (NR PDCP) }
ensure that {
  when { UE receives an RRCConnectionReconfiguration message to modify MCG DRB (NR PDCP) to Split DRB }
  then { UE reconfigures the DRB and sends an RRCConnectionReconfigurationComplete message }
}
```

(4)

```
with { UE in RRC_CONNECTED state with EN-DC, and, MCG(s) (E-UTRA PDCP) and Split }
ensure that {
  when { UE receives an RRCConnectionReconfiguration message to modify Split DRB to SCG DRB }
  then { UE reconfigures the DRB and sends an RRCConnectionReconfigurationComplete message }
}
```

(5)

```
with { UE in RRC_CONNECTED state with EN-DC, and, MCG(s) (E-UTRA PDCP) and SCG }
ensure that {
  when { UE receives an RRCConnectionReconfiguration message to modify SCG DRB to MCG DRB (NR PDCP) }
  then { UE reconfigures the DRB and sends an RRCConnectionReconfigurationComplete message }
}
```

(6)

```
with { UE in RRC_CONNECTED state with EN-DC, and, MCG(s) (E-UTRA PDCP) and MCG (NR PDCP) }
ensure that {
  when { UE receives an RRCConnectionReconfiguration message to modify MCG DRB (NR PDCP) to SCG DRB }
  then { UE reconfigures the DRB and sends an RRCConnectionReconfigurationComplete message }
}
```

8.2.2.7.1.2 Conformance requirements

References: The conformance requirements covered in the present TC are specified in TS 36.331, clauses 5.3.5.3 and TS 38.331: 5.3.5.3, 5.3.5.5.1, 5.3.5.6.1 and 5.3.5.6.5. Unless and otherwise stated these are Rel-15 requirements

[TS 36.331, clause 5.3.5.3]

If the *RRCCONNECTIONRECONFIGURATION* message does not include the *mobilityControlInfo* and the UE is able to comply with the configuration included in this message, the UE shall:

- 1> if this is the first *RRCCONNECTIONRECONFIGURATION* message after successful completion of the RRC connection re-establishment procedure:

...

- 1> else:

- 2> if the *RRCCONNECTIONRECONFIGURATION* message includes the *radioResourceConfigDedicated*:

- 3> perform the radio resource configuration procedure as specified in 5.3.10;

NOTE 3: If the *RRCCONNECTIONRECONFIGURATION* message includes the establishment of radio bearers other than SRB1, the UE may start using these radio bearers immediately, i.e. there is no need to wait for an outstanding acknowledgment of the *SecurityModeComplete* message.

...

- 1> if the received *RRCCONNECTIONRECONFIGURATION* includes the *nr-SecondaryCellGroupConfig*:

- 2> perform NR RRC Reconfiguration as specified in TS 38.331 [82, 5.3.5.3];

- 1> if the received *RRCCONNECTIONRECONFIGURATION* includes the *nr-RadioBearerConfig1*:

- 2> perform radio bearer configuration as specified in TS 38.331 [82, 5.3.5.6];

- 1> if the received *RRCCONNECTIONRECONFIGURATION* includes the *nr-RadioBearerConfig2*:

- 2> perform radio bearer configuration as specified in TS 38.331 [82, 5.3.5.6];

...

- 1> set the content of *RRCCONNECTIONRECONFIGURATIONCOMPLETE* message as follows:

...

- 2> if the received *RRCCONNECTIONRECONFIGURATION* message included *nr-SecondaryCellGroupConfig*:

- 3> include *scg-ConfigResponseNR* in accordance with TS 38.331 [82, 5.3.5.3];

- 1> submit the *RRCCONNECTIONRECONFIGURATIONCOMPLETE* message to lower layers for transmission using the new configuration, upon which the procedure ends;

[TS 38.331, clause 5.3.5.3]

The UE shall perform the following actions upon reception of the *RRCRECONFIGURATION*:

...

- 1> if the *RRCRECONFIGURATION* message contains the *radioBearerConfig*:

- 2> perform the radio bearer configuration according to 5.3.5.6;

...

- 1> if the UE is configured with E-UTRA *nr-SecondaryCellGroupConfig* (MCG is E-UTRA):

- 2> if *RRCRECONFIGURATION* was received via SRB1:

- 3> submit the *RRCRECONFIGURATIONCOMPLETE* via the EUTRA MCG embedded in E-UTRA RRC message *RRCCONNECTIONRECONFIGURATIONCOMPLETE* as specified in TS 36.331 [10];

[TS 38.331, clause 5.3.5.5.1]

The network configures the UE with one Secondary Cell Group (SCG). For EN-DC, the MCG is configured as specified in TS 36.331 [10]. The network provides the configuration parameters for a cell group in the *CellGroupConfig* IE.

The UE performs the following actions based on a received *CellGroupConfig* IE:

- 1> if the *CellGroupConfig* contains the *spCellConfig* with *reconfigurationWithSync*:
 - 2> perform Reconfiguration with sync according to 5.3.5.5.2;
 - 2> resume all suspended radio bearers and resume SCG transmission for all radio bearers, if suspended;
- 1> if the *CellGroupConfig* contains the *rlc-BearerToReleaseList*:
 - 2> perform RLC bearer release as specified in 5.3.5.5.3;
- 1> if the *CellGroupConfig* contains the *rlc-BearerToAddModList*:
 - 2> perform the RLC bearer addition/modification as specified in 5.3.5.5.4;
- 1> if the *CellGroupConfig* contains the *mac-CellGroupConfig*:
 - 2> configure the MAC entity of this cell group as specified in 5.3.5.5.5;
- 1> if the *CellGroupConfig* contains the *sCellToReleaseList*:
 - 2> perform SCell release as specified in 5.3.5.5.8;
- 1> if the *CellGroupConfig* contains the *spCellConfig*:
 - 2> configure the SpCell as specified in 5.3.5.5.7;
- 1> if the *CellGroupConfig* contains the *sCellToAddModList*:
 - 2> perform SCell addition/modification as specified in 5.3.5.5.9

[TS 38.331, clause 5.3.5.6.1]

The UE shall perform the following actions based on a received *RadioBearerConfig* IE:

...

- 1> if the *RadioBearerConfig* includes the *drb-ToReleaseList*:
 - 2> perform DRB release as specified in 5.3.5.6.4;
- 1> if the *RadioBearerConfig* includes the *drb-ToAddModList*:
 - 2> perform DRB addition or reconfiguration as specified in 5.3.5.6.5.

[TS 38.331, clause 5.3.5.6.5]

The UE shall:

- 1> for each *drb-Identity* value included in the *drb-ToAddModList* that is not part of the current UE configuration (DRB establishment including the case when full configuration option is used):
 - 2> establish a PDCP entity and configure it in accordance with the received *pdcp-Config*;
 - 2> configure the PDCP entity with the security algorithms according to *securityConfig* and apply the keys (K_{UPenc}) associated with the $K_{eNB}/S-K_{eNB}$ as indicated in *keyToUse*;
 - 2> if the DRB was configured with the same *eps-BearerIdentity* either by NR or E-UTRA prior to receiving this reconfiguration:
 - 3> associate the established DRB with the corresponding *eps-BearerIdentity*;
 - 2> else:

3> indicate the establishment of the DRB(s) and the *eps-BearerIdentity* of the established DRB(s) to upper layers;

1> for each *drb-Identity* value included in the *drb-ToAddModList* that is part of the current UE configuration:

2> if *reestablishPDCP* is set:

3> configure the PDCP entity of this *RadioBearerConfig* to apply the ciphering algorithm and K_{UPenc} key associated with the $K_{eNB/S-K_{gNB}}$ as indicated in *keyToUse*, i.e. the ciphering configuration shall be applied to all subsequent PDCP PDUs received and sent by the UE;

3> re-establish the PDCP entity of this DRB as specified in 38.323 [5], section 5.1.2;

2> else, if *recoverPDCP* is set:

3> trigger the PDCP entity of this DRB to perform data recovery as specified in 38.323;

2> if the *pdcp-Config* is included:

3> reconfigure the PDCP entity in accordance with the received *pdcp-Config*.

8.2.2.7.1.3 Test description

8.2.2.7.1.3.1 Pre-test conditions

System Simulator:

- E-UTRA Cell 1 is the PCell and NR Cell 1 is the PSCell.

UE:

None.

Preamble:

- If *pc_IP_Ping* is set to TRUE then, the UE is in state RRC_CONNECTED using generic procedure parameter Connectivity (EN-DC), Bearers (MCG(s) and SCG) established according to TS 38.508-1 [4], clause 4.5.4.
- Else, the UE is in state RRC_CONNECTED using generic procedure parameter Connectivity (EN-DC), Bearers (MCG(s) and SCG) established and Test Loop Function (On) with UE test loop mode B according to TS 38.508-1 [4], clause 4.5.4.

8.2.2.7.1.3.2 Test procedure sequence

Table 8.2.2.7.1.2-1: Main behaviour

St	Procedure	Message Sequence		TP	Verdict
		U - S	Message		
1	The SS transmits an <i>RRCCONNECTIONRECONFIGURATION</i> message containing NR RadioBearerConfig to modify SCG DRB to Split DRB.	<--	<i>RRCCONNECTIONRECONFIGURATION</i>	-	-
2	Check: Does the UE transmit an <i>RRCCONNECTIONRECONFIGURATIONCOMPLETE</i> message?	-->	<i>RRCCONNECTIONRECONFIGURATIONCOMPLETE</i>	1	P
3	Check: Does the test result of generic test procedure in TS 38.508-1 subclause 4.9.1 indicate that the UE is capable of exchanging IP data on split DRB using NR radio path?	-	-	1	P
4	The SS transmits <i>RRCCONNECTIONRECONFIGURATION</i> message to modify Split DRB to MCG DRB using NR PDCP.	<--	<i>RRCCONNECTIONRECONFIGURATION</i>	-	-
5	Check: Does the UE transmit an <i>RRCCONNECTIONRECONFIGURATIONCOMPLETE</i> message containing NR <i>RRCRECONFIGURATIONCOMPLETE</i> message?	-->	<i>RRCCONNECTIONRECONFIGURATIONCOMPLETE (RRCRECONFIGURATIONCOMPLETE)</i>	2	P
6	Check: Does the test result of generic test procedure in TS 38.508-1 subclause 4.9.1 indicate that the UE is capable of exchanging IP data on MCG DRB?	-	-	2	P
7	The SS transmits an <i>RRCCONNECTIONRECONFIGURATION</i> message containing NR <i>RRCRECONFIGURATION</i> message to modify MCG DRB to Split DRB.	<--	<i>RRCCONNECTIONRECONFIGURATION (RRCRECONFIGURATION)</i>	-	-
8	Check: Does the UE transmit an <i>RRCCONNECTIONRECONFIGURATIONCOMPLETE</i> message containing NR <i>RRCRECONFIGURATIONCOMPLETE</i> message?	-->	<i>RRCCONNECTIONRECONFIGURATIONCOMPLETE (RRCRECONFIGURATIONCOMPLETE)</i>	3	P
9	Check: Does the test result of generic test procedure in TS 38.508-1 subclause 4.9.1 indicate that the UE is capable of exchanging IP data on split DRB using NR radio path?	-	-	3	P
10	SS transmits <i>RRCCONNECTIONRECONFIGURATION</i> message containing NR RadioBearerConfig to modify Split DRB to SCG DRB.	<--	<i>RRCCONNECTIONRECONFIGURATION (RRCRECONFIGURATION)</i>	-	-
11	Check: Does the UE transmit an <i>RRCCONNECTIONRECONFIGURATIONCOMPLETE</i> message?	-->	<i>RRCCONNECTIONRECONFIGURATIONCOMPLETE</i>	4	P
12	Check: Does the test result of generic test procedure in TS 38.508-1 subclause 4.9.1 indicate that the UE is capable of exchanging IP data on SCG DRB?	-	-	4	P
13	SS transmits <i>RRCCONNECTIONRECONFIGURATION</i> message containing NR <i>RRCRECONFIGURATION</i> message to modify SCG DRB to MCG DRB.	<--	<i>RRCCONNECTIONRECONFIGURATION (RRCRECONFIGURATION)</i>	-	-
14	Check: Does the UE transmit an <i>RRCCONNECTIONRECONFIGURATIONCOMPLETE</i> message containing NR <i>RRCRECONFIGURATIONCOMPLETE</i> message?	-->	<i>RRCCONNECTIONRECONFIGURATIONCOMPLETE (RRCRECONFIGURATIONCOMPLETE)</i>	5	P
15	Check: Does the test result of generic test procedure in TS 38.508-1 subclause 4.9.1 indicate that the UE is capable of exchanging IP data on MCG DRB?	-	-	5	P
16	SS transmits <i>RRCCONNECTIONRECONFIGURATION</i> message containing NR <i>RRCRECONFIGURATION</i> message to modify MCG DRB to SCG DRB.	<--	<i>RRCCONNECTIONRECONFIGURATION (RRCRECONFIGURATION)</i>	-	-
17	Check: Does the UE transmit an <i>RRCCONNECTIONRECONFIGURATIONCOMPLETE</i>	-->	<i>RRCCONNECTIONRECONFIGURATIONCOMPLETE</i>	6	P

	message containing NR RRCReconfigurationComplete message?		(RRCReconfigurationComplete)		
18	Check: Does the test result of generic test procedure in TS 38.508-1 subclause 4.9.1 indicate that the UE is capable of exchanging IP data on SCG DRB?	-	-	6	P

8.2.2.7.1.3.3 Specific message contents

Table 8.2.2.7.1.3.3-1: RRCConnectionReconfiguration (step 1, Table 8.2.2.7.1.3.2-1)

Derivation Path: 36.508 [7], Table 4.6.1-8			
Information Element	Value/remark	Comment	Condition
RRCConnectionReconfiguration ::= SEQUENCE {			
criticalExtensions CHOICE {			
c1 CHOICE{			
rrcConnectionReconfiguration-r8 SEQUENCE {			
radioResourceConfigDedicated	RadioResourceConfigDe dicated-SCG-to-Split		
nonCriticalExtension SEQUENCE {			
nonCriticalExtension SEQUENCE {			
nonCriticalExtension SEQUENCE {			
nonCriticalExtension SEQUENCE {			
nonCriticalExtension SEQUENCE {			
nonCriticalExtension SEQUENCE {			
nonCriticalExtension SEQUENCE {			
nr-RadioBearerConfig1-r15	OCTET STRING including RadioBearerConfig-SCG- to-Split.		
}			
}			
}			
}			
}			
}			
}			
}			
}			
}			
}			
}			
}			
}			
}			

Table 8.2.2.7.1.3.3-2: RadioResourceConfigDedicated-SCG-to-Split (step 1, Table 8.2.2.7.1.3.2-1)

Derivation Path: 36.508 [7], Table 4.6.3-27			
Information Element	Value/remark	Comment	Condition
RadioResourceConfigDedicated-DRB ::= SEQUENCE {			
drb-ToAddModList	DRB-ToAddModList- SCG-to-Split		
}			

Table 8.2.2.7.1.3.3-3: DRB-ToAddModList-SCG-to-Split (step 1, Table 8.2.2.7.1.3.2-1)

Derivation Path: 36.508 [7], Table 4.6.3-2A			
Information Element	Value/remark	Comment	Condition
DRB-ToAddModList ::= SEQUENCE (SIZE (1..maxDRB)) OF DRB-ToAddMod {	1 Entry		
DRB-ToAddMod[1] SEQUENCE {		entry 1	
eps-BearerIdentity	6	Dedicated EPS bearer Id of SCG DRB	
drb-Identity	2	SCG DRB Id	
}			
}			

Table 8.2.2.7.1.3.3-4: RadioBearerConfig-SCG-to-Split (step 1, Table 8.2.2.7.1.3.2-1)

Derivation Path: 38.508-1 [4], Table 4.6.3-132 with condition EN-DC_DRB

Table 8.2.2.7.1.3.3-5: PDCP-Config (step 1, Table 8.2.2.7.1.3.2-1)

Derivation Path: 38.508-1 [4], Table 4.6.3-99 with condition Split
--

Table 8.2.2.7.1.3.3-6: RRCConnectionReconfiguration (step 4, Table 8.2.2.7.1.3.2-1)

Derivation Path: 36.508 [7], Table 4.6.1-8			
Information Element	Value/remark	Comment	Condition
RRCConnectionReconfiguration ::= SEQUENCE {			
criticalExtensions CHOICE {			
c1 CHOICE{			
rrcConnectionReconfiguration-r8 SEQUENCE {			
radioResourceConfigDedicated	Not Present		
nonCriticalExtension SEQUENCE {			
nonCriticalExtension SEQUENCE {			
nonCriticalExtension SEQUENCE {			
nonCriticalExtension SEQUENCE {			
nonCriticalExtension SEQUENCE {			
nonCriticalExtension SEQUENCE {			
nonCriticalExtension SEQUENCE {			
nr-Config-r15 CHOICE {			
release			
}			
nr-RadioBearerConfig1-r15	OCTET STRING containing RadioBearerConfig-Split-to-MCG		
}			
}			
}			
}			
}			
}			
}			
}			
}			
}			
}			
}			
}			
}			
}			

Table 8.2.2.7.1.3.3-7: *Void*Table 8.2.2.7.1.3.3-8: *Void*Table 8.2.2.7.1.3.3-9: *RadioBearerConfig-Split-to-MCG* (step 4, Table 8.2.2.7.1.3.2-1)

Derivation Path: 38.508-1 [4], Table 4.6.3-132			
Information Element	Value/remark	Comment	Condition
RadioBearerConfig ::= SEQUENCE {			
drb-ToAddModList SEQUENCE (SIZE (1..maxDRB))	1 entry		
OF DRB-ToAddMod {			
DRB-ToAddMod[1] SEQUENCE {		entry 1	
cnAssociation CHOICE {			
eps-BearerIdentity	6		
}			
drb-Identity	2		
recoverPDCP	true		
pdcpc-Config SEQUENCE {			
Drb	Omit		
moreThanOneRLC	Omit		
t-Reordering	Omit		
cipheringDisabled	Omit		
}			
}			
}			

Table 8.2.2.7.1.3.3-9a: *Void*

Table 8.2.2.7.1.3.3-10: *RRCConnectionReconfiguration* (step 7, Table 8.2.2.7.1.3.2-1)

Derivation Path: 36.508 [7], Table 4.6.1-8			
Information Element	Value/remark	Comment	Condition
RRCConnectionReconfiguration ::= SEQUENCE {			
criticalExtensions CHOICE {			
c1 CHOICE{			
rrcConnectionReconfiguration-r8 SEQUENCE {			
radioResourceConfigDedicated	Not Present		
nonCriticalExtension SEQUENCE {			
nonCriticalExtension SEQUENCE {			
nonCriticalExtension SEQUENCE {			
nonCriticalExtension SEQUENCE {			
nonCriticalExtension SEQUENCE {			
nonCriticalExtension SEQUENCE {			
nonCriticalExtension SEQUENCE {			
nr-Config-r15 CHOICE {			
setup SEQUENCE {			
nr-SecondaryCellGroupConfig-r15	OCTET STRING containing <i>RRCReconfiguration-MCG-to-Split</i>		
}			
}			
nr-RadioBearerConfig1-r15	OCTET STRING including <i>RadioBearerConfig-MCG-to-Split</i> .		
}			
}			
}			
}			
}			
}			
}			
}			
}			
}			
}			
}			
}			
}			

Table 8.2.2.7.1.3.3-11: *RRCReconfiguration-MCG-to-Split* (step7, Table 8.2.2.7.1.3.2-1)

Derivation Path: 38.508-1 [4], Table 4.6.1-13, condition EN-DC
--

Table 8.2.2.7.1.3.3-12: *Void*

Table 8.2.2.7.1.3.3-13: RadioBearerConfig-MCG-to-Split (step 7, Table 8.2.2.7.1.3.2-1)

Derivation Path: 38.508-1 [4], Table 4.6.3-132			
Information Element	Value/remark	Comment	Condition
RadioBearerConfig ::= SEQUENCE {			
drb-ToAddModList SEQUENCE (SIZE (1..maxDRB))	1 entry		
OF DRB-ToAddMod {			
DRB-ToAddMod[1] SEQUENCE {		entry 1	
cnAssociation CHOICE {			
eps-BearerIdentity	6		
}			
drb-Identity	2		
pdcp-Config	PDCP-Config		
}			
}			

Table 8.2.2.7.1.3.3-14: PDCP-Config (step 7, Table 8.2.2.7.1.3.2-1)

Derivation Path: 38.508-1 [4], Table 4.6.3-99			
Information Element	Value/remark	Comment	Condition
PDCP-Config ::= SEQUENCE {			
moreThanOneRLC SEQUENCE {			
primaryPath SEQUENCE {			
cellGroup	1		
}			
ul-DataSplitThreshold	infinity		
}			
}			

Table 8.2.2.7.1.3.3-17: RadioBearerConfig-Split-to-SCG (step 10, Table 8.2.2.7.1.3.2-1)

Derivation Path: 38.508-1 [4], Table 4.6.3-132			
Information Element	Value/remark	Comment	Condition
RadioBearerConfig ::= SEQUENCE {			
drb-ToAddModList SEQUENCE (SIZE (1..maxDRB))	1 entry		
OF DRB-ToAddMod {			
DRB-ToAddMod[1] SEQUENCE {		entry 1	
cnAssociation CHOICE {			
eps-BearerIdentity	6		
}			
drb-Identity	2		
recoverPDCP	true		
pdcpc-Config ::= SEQUENCE {			
Drb	Omit		
moreThanOneRLC	Omit		
t-Reordering	Omit		
cipheringDisabled	Omit		
}			
}			
}			
}			

Table 8.2.2.7.1.3.3-18: RRCConnectionReconfiguration (step 13, Table 8.2.2.7.1.3.2-1)

Derivation Path: 36.508 [7], Table 4.6.1-8			
Information Element	Value/remark	Comment	Condition
RRCConnectionReconfiguration ::= SEQUENCE {			
criticalExtensions CHOICE {			
c1 CHOICE{			
rrcConnectionReconfiguration-r8 SEQUENCE {			
radioResourceConfigDedicated	<i>RadioResourceConfigDedicated-SCG-to-MCG</i>		
nonCriticalExtension SEQUENCE {			
nonCriticalExtension SEQUENCE {			
nonCriticalExtension SEQUENCE {			
nonCriticalExtension SEQUENCE {			
nonCriticalExtension SEQUENCE {			
nonCriticalExtension SEQUENCE {			
nonCriticalExtension SEQUENCE {			
nr-Config-r15 CHOICE {			
release			
}			
nr-RadioBearerConfig1-r15	OCTET STRING including <i>RadioBearerConfig-SCG-to-MCG</i> .		
}			
}			
}			
}			
}			
}			
}			
}			
}			
}			
}			
}			
}			

Table 8.2.2.7.1.3.3-19: RadioResourceConfigDedicated-SCG-to-MCG (step 13, Table 8.2.2.7.1.3.2-1)

Derivation Path: 36.508 [7], Table 4.6.3-27			
Information Element	Value/remark	Comment	Condition
RadioResourceConfigDedicated-DRB ::= SEQUENCE {			
drb-ToAddModList	DRB-ToAddModList-SCG-to-MCG		
}			

Table 8.2.2.7.1.3.3-20: DRB-ToAddModList-SCG-to-MCG (step 13, Table 8.2.2.7.1.3.2-1)

Derivation Path: 36.508 [7], Table 4.6.3-2A			
Information Element	Value/remark	Comment	Condition
DRB-ToAddModList ::= SEQUENCE (SIZE (1..maxDRB)) OF DRB-ToAddMod {	1 Entry		
DRB-ToAddMod[1] SEQUENCE {		entry 1	
eps-BearerIdentity	6		
drb-Identity	2		
}			
}			

Table 8.2.2.2.4.3.3-21: Void**Table 8.2.2.7.1.3.3-22: Void****Table 8.2.2.7.1.3.3-23: RadioBearerConfig-SCG-to-MCG (step 13, Table 8.2.2.7.1.3.2-1)**

Derivation Path: 38.508-1 [4], Table 4.6.3-132 with condition EN-DC_DRB AND Recover_PDCP			
--	--	--	--

Table 8.2.2.7.1.3.3-28: RadioBearerConfig-MCG-to-SCG (step 16, Table 8.2.2.7.1.3.2-1)

Derivation Path: 38.508-1 [4], Table 4.6.3-132			
Information Element	Value/remark	Comment	Condition
RadioBearerConfig ::= SEQUENCE {			
drb-ToAddModList SEQUENCE (SIZE (1..maxDRB))	1 entry		
OF DRB-ToAddMod {			
DRB-ToAddMod[1] SEQUENCE {		entry 1	
cnAssociation CHOICE {			
eps-BearerIdentity	6		
}			
drb-Identity	2		
recoverPDCP	true		
}			
}			
}			

Table 8.2.2.7.1.3.3-29: RRCConnectionReconfigurationComplete (steps 2, 5, 8, 11, 14, 17 Table 8.2.2.7.1.3.2-1)

Derivation Path: 36.508 [7] Table 4.6.1-9			
Information Element	Value/remark	Comment	Condition
RRCConnectionReconfigurationComplete ::= SEQUENCE {			
criticalExtensions CHOICE {			
rrcConnectionReconfigurationComplete-r8			
SEQUENCE {			
nonCriticalExtension SEQUENCE {			
nonCriticalExtension SEQUENCE {			
nonCriticalExtension SEQUENCE {			
nonCriticalExtension SEQUENCE {			
nonCriticalExtension SEQUENCE {			
nonCriticalExtension SEQUENCE {			
scg-ConfigResponseNR-r15	Present		
}			
}			
}			
}			
}			
}			
}			
}			
}			

8.2.2.7.2 Bearer Modification / Handling for bearer type change without security key change / NR-DC

8.2.2.7.2.1 Test Purpose (TP)

(1)

```
with { UE in NR RRC_CONNECTED state with NR-DC with SCG }
ensure that {
  when { UE receives an RRCReconfiguration message to modify SCG DRB to Split DRB }
  then { UE reconfigures the DRB and sends an RRCReconfigurationComplete message }
}
```

(2)

```
with { UE in NR RRC_CONNECTED state with NR-DC with Split DRB }
ensure that {
  when { UE receives an RRCReconfiguration message to modify Split DRB to MCG DRB }
  then { UE reconfigures the DRB and sends an RRCReconfigurationComplete message }
}
```

```

    }

```

(3)

```

with { UE in NR RRC_CONNECTED state with NR-DC and MCG DRB }
ensure that {
  when { UE receives an RRCReconfiguration message to modify MCG DRB to Split DRB }
  then { UE reconfigures the DRB and sends an RRCReconfigurationComplete message }
}

```

(4)

```

with { UE in NR RRC_CONNECTED state with NR-DC with Split DRB }
ensure that {
  when { UE receives an RRCReconfiguration message to modify Split DRB to SCG DRB }
  then { UE reconfigures the DRB and sends an RRCReconfigurationComplete message }
}

```

(5)

```

with { UE in NR RRC_CONNECTED state with NR-DC with SCG }
ensure that {
  when { UE receives an RRCReconfiguration message to modify SCG DRB to MCG DRB }
  then { UE reconfigures the DRB and sends an RRCReconfigurationComplete message }
}

```

(6)

```

with { UE in NR RRC_CONNECTED state with NR-DC and MCG DRB }
ensure that {
  when { UE receives an RRCReconfiguration message to modify MCG DRB to SCG DRB }
  then { UE reconfigures the DRB and sends an RRCReconfigurationComplete message }
}

```

8.2.2.7.2.2 Conformance requirements

References: The conformance requirements covered in the present TC are specified in TS 38.331: 5.3.5.3, 5.3.5.5.7 and 5.3.5.6.5. Unless and otherwise stated these are Rel-15 requirements

[TS 38.331, clause 5.3.5.3]

The UE shall perform the following actions upon reception of the *RRCReconfiguration*:

...

1> if the *RRCReconfiguration* message contains the *radioBearerConfig*:

2> perform the radio bearer configuration according to 5.3.5.6;

...

1> if the UE is configured with E-UTRA *nr-SecondaryCellGroupConfig* (MCG is E-UTRA):

2> if *RRCReconfiguration* was received via SRB1:

3> submit the *RRCReconfigurationComplete* via the EUTRA MCG embedded in E-UTRA RRC message *RRCConnectionReconfigurationComplete* as specified in TS 36.331 [10];

[TS 38.331, clause 5.3.5.5.7]

The UE shall:

1> if the *SpCellConfig* contains the *rlf-TimersAndConstants*:

2> configure the RLF timers and constants for this cell group as specified in 5.3.5.5.6;

1> else if *rlf-TimersAndConstants* is not configured for this cell group:

2> if any DAPS bearer is configured:

- 3> use values for timers T301, T310, T311 and constants N310, N311 for the target cell group, as included in *ue-TimersAndConstants* received in *SIB1*;
- 2> else
 - 3> use values for timers T301, T310, T311 and constants N310, N311, as included in *ue-TimersAndConstants* received in *SIB1*;
- 1> if the *SpCellConfig* contains *spCellConfigDedicated*:
 - 2> configure the SpCell in accordance with the *spCellConfigDedicated*;
 - 2> consider the bandwidth part indicated in *firstActiveUplinkBWP-Id* if configured to be the active uplink bandwidth part;
 - 2> consider the bandwidth part indicated in *firstActiveDownlinkBWP-Id* if configured to be the active downlink bandwidth part;
 - 2> if any of the reference signal(s) that are used for radio link monitoring are reconfigured by the received *spCellConfigDedicated*:
 - 3> stop timer T310 for the corresponding SpCell, if running;
 - 3> stop timer T312 for the corresponding SpCell, if running;
 - 3> reset the counters N310 and N311.

[TS 38.331, clause 5.3.5.6.5]

The UE shall:

- 1> for each *drb-Identity* value included in the *drb-ToAddModList* that is not part of the current UE configuration (DRB establishment including the case when full configuration option is used):
 - 2> establish a PDCP entity and configure it in accordance with the received *pdcp-Config*;
 - 2> configure the PDCP entity with the security algorithms according to *securityConfig* and apply the keys (K_{UPenc}) associated with the $K_{eNB}/S-K_{gNB}$ as indicated in *keyToUse*;
 - 2> if the DRB was configured with the same *eps-BearerIdentity* either by NR or E-UTRA prior to receiving this reconfiguration:
 - 3> associate the established DRB with the corresponding *eps-BearerIdentity*;
 - 2> else:
 - 3> indicate the establishment of the DRB(s) and the *eps-BearerIdentity* of the established DRB(s) to upper layers;
- 1> for each *drb-Identity* value included in the *drb-ToAddModList* that is part of the current UE configuration:
 - 2> if *reestablishPDCP* is set:
 - 3> configure the PDCP entity of this *RadioBearerConfig* to apply the ciphering algorithm and K_{UPenc} key associated with the $K_{eNB}/S-K_{gNB}$ as indicated in *keyToUse*, i.e. the ciphering configuration shall be applied to all subsequent PDCP PDUs received and sent by the UE;
 - 3> re-establish the PDCP entity of this DRB as specified in 38.323 [5], section 5.1.2;
 - 2> else, if *recoverPDCP* is set:
 - 3> trigger the PDCP entity of this DRB to perform data recovery as specified in 38.323;
 - 2> if the *pdcp-Config* is included:
 - 3> reconfigure the PDCP entity in accordance with the received *pdcp-Config*.

8.2.2.7.2.3 Test description

8.2.2.7.2.3.1 Pre-test conditions

System Simulator:

- NR Cell 1 is the PCell and NR Cell 10 is the PSCell.

UE:

None.

Preamble:

- If `pc_IP_Ping` is set to TRUE then, the UE is in state NR RRC_CONNECTED using generic procedure parameter Connectivity (*NR-DC*), Bearers (*MCG(s) and SCG*) established according to TS 38.508-1 [4], clause 4.5.4.
- Else, the UE is in state NR RRC_CONNECTED using generic procedure parameter Connectivity (*NR-DC*), Bearers (*MCG(s) and SCG*) established and Test Loop Function (*On*) with UE test loop mode B according to TS 38.508-1 [4], clause 4.5.4.

8.2.2.7.2.3.2- Test procedure sequence

Table 8.2.2.7.2.3.2-1: Main behaviour

St	Procedure	Message Sequence		TP	Verdict
		U – S	Message		
1	The SS transmits an <i>RRCReconfiguration</i> message containing NR RadioBearerConfig to modify SCG DRB to Split DRB.	<--	<i>RRCReconfiguration</i>	-	-
2	Check: Does the UE transmit an <i>RRCReconfigurationComplete</i> message?	-->	<i>RRCReconfigurationComplete</i>	1	P
3	Check: Does the test result of generic test procedure in TS 38.508-1 subclause 4.9.1 indicate that the UE is capable of exchanging IP data on split DRB on PSCell?	-	-	1	P
4	The SS transmits <i>RRCReconfiguration</i> message to modify Split DRB to MCG DRB.	<--	<i>RRCReconfiguration</i>	-	-
5	Check: Does the UE transmit an <i>RRCReconfigurationComplete</i> message?	-->	<i>RRCReconfigurationComplete</i>	2	P
6	Check: Does the test result of generic test procedure in TS 38.508-1 subclause 4.9.1 indicate that the UE is capable of exchanging IP data on MCG DRB?	-	-	2	P
7	The SS transmits an <i>RRCReconfiguration</i> message to modify MCG DRB to Split DRB.	<--	<i>RRCReconfiguration</i>	-	-
8	Check: Does the UE transmit an <i>RRCReconfigurationComplete</i> message?	-->	<i>RRCReconfigurationComplete</i>	3	P
9	Check: Does the test result of generic test procedure in TS 38.508-1 subclause 4.9.1 indicate that the UE is capable of exchanging IP data on split DRB on PCell?	-	-	3	P
10	SS transmits <i>RRCReconfiguration</i> message containing NR RadioBearerConfig to modify Split DRB to SCG DRB.	<--	<i>RRCReconfiguration</i>	-	-
11	Check: Does the UE transmit an <i>RRCReconfigurationComplete</i> message?	-->	<i>RRCReconfigurationComplete</i>	4	P
12	Check: Does the test result of generic test procedure in TS 38.508-1 subclause 4.9.1 indicate that the UE is capable of exchanging IP data on SCG DRB?	-	-	4	P
13	SS transmits <i>RRCReconfiguration</i> message to modify SCG DRB to MCG DRB.	<--	<i>RRCReconfiguration</i>	-	-
14	Check: Does the UE transmit an <i>RRCReconfigurationComplete</i> message?	-->	<i>RRCReconfigurationComplete</i>	5	P
15	Check: Does the test result of generic test procedure in TS 38.508-1 subclause 4.9.1 indicate that the UE is capable of exchanging IP data on MCG DRB?	-	-	5	P
16	SS transmits <i>RRCReconfiguration</i> message to modify MCG DRB to SCG DRB.	<--	<i>RRCReconfiguration</i>	-	-
17	Check: Does the UE transmit an <i>RRCReconfigurationComplete</i> message?	-->	<i>RRCReconfigurationComplete</i>	6	P
18	Check: Does the test result of generic test procedure in TS 38.508-1 subclause 4.9.1 indicate that the UE is capable of exchanging IP data on SCG DRB?	-	-	6	P

8.2.2.7.2.3.3 Specific message contents

Table 8.2.2.7.2.3.3-1: RRCReconfiguration (step 1, Table 8.2.2.7.2.3.2-1)

Derivation Path: 38.508-1 [4], Table 4.6.1-13			
Information Element	Value/remark	Comment	Condition
RRCReconfiguration ::= SEQUENCE {			
criticalExtensions CHOICE {			
rrcReconfiguration SEQUENCE {			
nonCriticalExtension SEQUENCE {			
nonCriticalExtension SEQUENCE {			
masterCellGroup	CellGroupConfig	See Table 8.2.2.7.2.3.3-2	
nonCriticalExtension SEQUENCE {			
mrdc-SecondaryCellGroupConfig CHOICE {			
setup SEQUENCE {			
mrdc-SecondaryCellGroup CHOICE {			
nr-SCG	OCTET STRING (CONTAINING RRCReconfiguration)	See Table 8.2.2.7.2.3.3-3	
}			
}			
}			
radioBearerConfig2	RadioBearerConfig	See Table 8.2.2.7.2.3.3-5	
}			
}			
}			
}			
}			
}			
}			

Table 8.2.2.7.2.3.3-2: CellGroupConfig (Table 8.2.2.7.2.3.3-1)

Derivation Path: TS 38.508-1, Table 4.6.3-19			
Information Element	Value/remark	Comment	Condition
CellGroupConfig ::= SEQUENCE {			
rlc-BearerToAddModList SEQUENCE (SIZE(1..maxLC-ID)) OF RLC-BearerConfig {	1 entry		
RLC-BearerConfig[1]	RLC-BearerConfig as per TS 38.508-1[4] Table 4.6.3-148: RLC-BearerConfig with conditions AM and DRBm and Re-establish_RLC	entry 1 DRBm is allocated for SCG according to internal TTCN mapping	
}			
}			

Table 8.2.2.7.2.3.3-3: RRCReconfiguration (Table 8.2.2.7.2.3.3-1)

Derivation Path: 38.508-1 [4], Table 4.6.1-13			
Information Element	Value/remark	Comment	Condition
RRCReconfiguration ::= SEQUENCE {			
secondaryCellGroup	CellGroupConfig	See Table 8.2.2.7.2.3.3-4	
}			

Table 8.2.2.7.2.3.3-4: CellGroupConfig (Table 8.2.2.7.2.3.3-3)

Derivation Path: TS 38.508-1, Table 4.6.3-19			
Information Element	Value/remark	Comment	Condition
CellGroupConfig ::= SEQUENCE {			
rlc-BearerToAddModList SEQUENCE (SIZE(1..maxLC-ID)) OF RLC-BearerConfig {	1 entry		
RLC-BearerConfig[1]	RLC-BearerConfig as per TS 38.508-1[4] Table 4.6.3-148: <i>RLC-BearerConfig</i> with conditions AM and DRBm and Re-establish_RLC	entry 1 DRBm is allocated for SCG according to internal TTCN mapping	
}			
}			

Table 8.2.2.7.2.3.3-5: RadioBearerConfig (Table 8.2.2.7.2.3.3-1)

Derivation Path: TS 38.508-1 [4], Table 4.6.3-132 with condition DRBm			
Information Element	Value/remark	Comment	Condition
RadioBearerConfig ::= SEQUENCE {			
drb-ToAddModList SEQUENCE (SIZE (1..maxDRB)) OF {	1 entry		
DRB-ToAddMod[1] SEQUENCE {		entry 1	
drb-Identity	DRB-Identity using condition DRBm	DRBm is allocated for SCG according to internal TTCN mapping	
recoverPDCP	Not present		
pdcp-Config	PDCP-Config	See Table 8.2.2.7.2.3.3-6	
}			
}			
securityConfig	Not present		
}			

Table 8.2.2.7.2.3.3-6: PDCP-Config (Table 8.2.2.7.2.3.3-5)

Derivation Path: 38.508-1 [4], Table 4.6.3-99 with condition Split			
Information Element	Value/remark	Comment	Condition
PDCP-Config ::= SEQUENCE {			
moreThanOneRLC SEQUENCE {			
primaryPath SEQUENCE {			
cellGroup	1		
}			
}			
}			

Table 8.2.2.7.2.3.3-7: RRCReconfiguration (step 4, Table 8.2.2.7.2.3.2-1)

Derivation Path: 38.508-1 [4], Table 4.6.1-13			
Information Element	Value/remark	Comment	Condition
RRCReconfiguration ::= SEQUENCE {			
criticalExtensions CHOICE {			
rrcReconfiguration SEQUENCE {			
nonCriticalExtension SEQUENCE {			
nonCriticalExtension SEQUENCE {			
nonCriticalExtension SEQUENCE {			
mrdc-SecondaryCellGroupConfig CHOICE {			
Release			
}			
radioBearerConfig2	RadioBearerConfig	See Table 8.2.2.7.2.3.3-8	
}			
}			
}			
}			
}			
}			

Table 8.2.2.7.2.3.3-8: RadioBearerConfig (Table 8.2.2.7.2.3.3-7)

Derivation Path: TS 38.508-1 [4], Table 4.6.3-132 with condition DRBm			
Information Element	Value/remark	Comment	Condition
RadioBearerConfig ::= SEQUENCE {			
drb-ToAddModList SEQUENCE (SIZE (1..maxDRB))	1 entry		
OF {			
DRB-ToAddMod[1] SEQUENCE {		entry 1	
drb-Identity	DRB-Identity using condition DRBm	DRBm is allocated for SCG according to internal TTCN mapping	
recoverPDCP	true		
}			
}			
securityConfig	Not present		
}			

Table 8.2.2.7.2.3.3-9: RRCReconfiguration (step 7, Table 8.2.2.7.2.3.2-1)

Derivation Path: 38.508-1 [4], Table 4.6.1-13			
Information Element	Value/remark	Comment	Condition
RRCReconfiguration ::= SEQUENCE {			
criticalExtensions CHOICE {			
rrcReconfiguration SEQUENCE {			
nonCriticalExtension SEQUENCE {			
nonCriticalExtension SEQUENCE {			
nonCriticalExtension SEQUENCE {			
mrdc-SecondaryCellGroupConfig CHOICE {			
nr-SCG	OCTET STRING (CONTAINING RRCReconfiguration)	See Table 8.2.2.7.2.3.3-10	
}			
radioBearerConfig2	RadioBearerConfig	See Table 8.2.2.7.2.3.3-12	
}			
}			
}			
}			
}			
}			

Table 8.2.2.7.2.3.3-10: RRCReconfiguration (Table 8.2.2.7.2.3.3-9)

Derivation Path: 38.508-1 [4], Table 4.6.1-13			
Information Element	Value/remark	Comment	Condition
RRCReconfiguration ::= SEQUENCE {			
secondaryCellGroup	CellGroupConfig	See Table 8.2.2.7.2.3.3-11	
}			

Table 8.2.2.7.2.3.3-11: CellGroupConfig (Table 8.2.2.7.2.3.3-10)

Derivation Path: TS 38.508-1, Table 4.6.3-19 with condition NR-DC_SCG			
Information Element	Value/remark	Comment	Condition
CellGroupConfig ::= SEQUENCE {			
rlc-BearerToAddModList SEQUENCE (SIZE(1..maxLC-ID)) OF RLC-BearerConfig {	1 entry		
RLC-BearerConfig[1]	RLC-BearerConfig as per TS 38.508-1[4] Table 4.6.3-148: <i>RLC- BearerConfig</i> with conditions AM and DRBm	entry 1 DRBm is allocated according to internal TTCN mapping	
}			
}			

Table 8.2.2.7.2.3.3-15: RadioBearerConfig (Table 8.2.2.7.2.3.3-13)

Derivation Path: TS 38.508-1 [4], Table 4.6.3-132 with condition DRBm			
Information Element	Value/remark	Comment	Condition
RadioBearerConfig ::= SEQUENCE {			
drb-ToAddModList SEQUENCE (SIZE (1..maxDRB))	1 entry		
OF {			
DRB-ToAddMod[1] SEQUENCE {		entry 1	
drb-Identity	DRB-Identity using condition DRBm	DRBm is allocated for SCG according to internal TTCN mapping	
recoverPDCP	True		
}			
}			
securityConfig	Not present		
}			

Table 8.2.2.7.2.3.3-16: RRCReconfiguration (step 13, Table 8.2.2.7.2.3.2-1)

Derivation Path: 38.508-1 [4], Table 4.6.1-13			
Information Element	Value/remark	Comment	Condition
RRCReconfiguration ::= SEQUENCE {			
criticalExtensions CHOICE {			
rrcReconfiguration SEQUENCE {			
nonCriticalExtension SEQUENCE {			
masterCellGroup	CellGroupConfig	See Table 8.2.2.7.2.3.3-17	
nonCriticalExtension SEQUENCE {			
nonCriticalExtension SEQUENCE {			
mrdc-SecondaryCellGroupConfig CHOICE {			
Release			
}			
radioBearerConfig2	RadioBearerConfig	See Table 8.2.2.7.2.3.3-18	
}			
}			
}			
}			
}			
}			
}			

Table 8.2.2.7.2.3.3-17: CellGroupConfig (Table 8.2.2.7.2.3.3-16)

Derivation Path: TS 38.508-1, table 4.6.3-19			
Information Element	Value/remark	Comment	Condition
CellGroupConfig ::= SEQUENCE {			
rlc-BearerToAddModList SEQUENCE (SIZE(1..maxLC-ID)) OF RLC-BearerConfig {	1 entry		
RLC-BearerConfig[1]	RLC-BearerConfig as per TS 38.508-1[4] Table 4.6.3-148: <i>RLC-BearerConfig</i> with conditions DRBn	DRBn is allocated according to internal TTCN mapping	
}			
}			

Table 8.2.2.7.2.3.3-18: RadioBearerConfig (Table 8.2.2.7.2.3.3-16)

Derivation Path: TS 38.508-1 [4], Table 4.6.3-132 with condition DRBm			
Information Element	Value/remark	Comment	Condition
RadioBearerConfig ::= SEQUENCE {			
drb-ToAddModList SEQUENCE (SIZE (1..maxDRB))	1 entry		
OF {			
DRB-ToAddMod[1] SEQUENCE {		entry 1	
drb-Identity	DRB-Identity using condition DRBm	DRBm is allocated for SCG according to internal TTCN mapping	
recoverPDCP	True		
}			
}			
securityConfig	Not present		
}			

Table 8.2.2.7.2.3.3-19: RRCReconfiguration (step 16, Table 8.2.2.7.2.3.2-1)

Derivation Path: 38.508-1 [4], Table 4.6.1-13			
Information Element	Value/remark	Comment	Condition
RRCReconfiguration ::= SEQUENCE {			
criticalExtensions CHOICE {			
rrcReconfiguration SEQUENCE {			
nonCriticalExtension SEQUENCE {			
masterCellGroup	CellGroupConfig	See Table 8.2.2.7.2.3.3-20	
nonCriticalExtension SEQUENCE {			
nonCriticalExtension SEQUENCE {			
nrdc-SecondaryCellGroupConfig CHOICE {			
nr-SCG	OCTET STRING (CONTAINING RRCReconfiguration)	See Table 8.2.2.7.2.3.3-21	
}			
radioBearerConfig2	RadioBearerConfig	See Table 8.2.2.7.2.3.3-23	
}			
}			
}			
}			
}			
}			
}			

Table 8.2.2.7.2.3.3-20: CellGroupConfig (Table 8.2.2.7.2.3.3-19)

Derivation Path: TS 38.508-1, table 4.6.3-19			
Information Element	Value/remark	Comment	Condition
CellGroupConfig ::= SEQUENCE {			
rlc-BearerToReleaseList SEQUENCE (SIZE(1..maxLC-ID)) OF LogicalChannelIdentity {			
LogicalChannelIdentity[1]	Logical ChannelID of DRBm		
}			
}			

Table 8.2.2.7.2.3.3-21: RRCReconfiguration (Table 8.2.2.7.2.3.3-19)

Derivation Path: 38.508-1 [4], Table 4.6.1-13			
Information Element	Value/remark	Comment	Condition
RRCReconfiguration ::= SEQUENCE {			
secondaryCellGroup	CellGroupConfig	See Table 8.2.2.7.2.3.3-22	
}			

Table 8.2.2.7.2.3.3-22: CellGroupConfig (Table 8.2.2.7.2.3.3-21)

Derivation Path: TS 38.508-1, table 4.6.3-19 with condition NR-DC_SCG			
Information Element	Value/remark	Comment	Condition
CellGroupConfig ::= SEQUENCE {			
rlc-BearerToAddModList SEQUENCE (SIZE(1..maxLC-ID)) OF RLC-BearerConfig {			
RLC-BearerConfig[1]	RLC-BearerConfig as per TS 38.508-1[4] Table 4.6.3-148: <i>RLC-BearerConfig</i> with conditions AM and DRBm	entry 1 DRBn is allocated according to internal TTCN mapping	
}			
}			

Table 8.2.2.7.2.3.3-23: RadioBearerConfig (Table 8.2.2.7.2.3.3-19)

Derivation Path: TS 38.508-1 [4], Table 4.6.3-132 with condition DRBm			
Information Element	Value/remark	Comment	Condition
RadioBearerConfig ::= SEQUENCE {			
drb-ToAddModList SEQUENCE (SIZE(1..maxDRB)) OF {	1 entry		
DRB-ToAddMod[1] SEQUENCE {		entry 1	
drb-Identity	DRB-Identity using condition DRBm	DRBm is allocated for SCG according to internal TTCN mapping	
recoverPDCP	True		
}			
securityConfig	Not present		
}			

8.2.2.8 Bearer Modification / Handling for bearer type change with security key change

8.2.2.8.1 Bearer Modification / Handling for bearer type change with security key change / EN-DC

8.2.2.8.1.1 Test Purpose (TP)

(1)

```

with { UE in RRC_CONNECTED state with EN-DC, and, MCG(s) (E-UTRA PDCP) and SCG }
ensure that {
  when { UE receives an RRCConnectionReconfiguration message to modify the SN terminated SCG DRB to
MN terminated SCG DRB with security key change to keNB }
  then { UE reconfigures the DRB and sends an RRCConnectionReconfigurationComplete message }
}

```

(2)

```
with { UE in RRC_CONNECTED state with EN-DC, and, MCG(s) (E-UTRA PDCP) and MN terminated SCG DRB
established with security key keNB }
ensure that {
  when { UE receives an RRCConnectionReconfiguration message to modify the MN terminated SCG DRB to
SN terminated Split DRB with security key change to s-KgNB }
    then { UE reconfigures the DRB and sends an RRCConnectionReconfigurationComplete message }
}
```

(3)

```
with { UE in RRC_CONNECTED state with EN-DC, and, MCG(s) (E-UTRA PDCP) and SN terminated Split DRB
established with security key s-KgNB }
ensure that {
  when { UE receives an RRCConnectionReconfiguration message to modify the SN terminated Split DRB
to MN terminated Split DRB with security key change to keNB }
    then { UE reconfigures the DRB and sends an RRCConnectionReconfigurationComplete message }
}
```

(4)

```
with { UE in RRC_CONNECTED state with EN-DC, and, MCG(s) (E-UTRA PDCP) and MN terminated Split DRB
established with security key keNB }
ensure that {
  when { UE receives an RRCConnectionReconfiguration message to modify the MN terminated Split DRB
to SN terminated MCG DRB (NR PDCP) with security key change to s-KgNB }
    then { UE reconfigures the DRB and sends an RRCConnectionReconfigurationComplete message }
}
```

(5)

```
with { UE in RRC_CONNECTED state with EN-DC, and, MCG(s) (E-UTRA PDCP) and SN terminated MCG DRB (NR
PDCP) established with security key s-KgNB }
ensure that {
  when { UE receives an RRCConnectionReconfiguration message to modify the SN terminated MCG DRB (NR
PDCP) to MN terminated MCG DRB (NR PDCP) with security key change to keNB }
    then { UE reconfigures the DRB and sends an RRCConnectionReconfigurationComplete message }
}
```

(6)

```
with { UE in RRC_CONNECTED state with EN-DC, and, MCG(s) (E-UTRA PDCP) and MN terminated MCG DRB (NR
PDCP) established with security key keNB }
ensure that {
  when { UE receives an RRCConnectionReconfiguration message to modify the MN terminated MCG DRB (NR
PDCP) to SN terminated Split DRB with security key change to s-KgNB }
    then { UE reconfigures the DRB and sends an RRCConnectionReconfigurationComplete message }
}
```

(7)

```
with { UE in RRC_CONNECTED state with EN-DC, and, MCG(s) (E-UTRA PDCP) and SN terminated Split DRB
established with security key s-KgNB }
ensure that {
  when { UE receives an RRCConnectionReconfiguration message to modify the SN terminated Split DRB
to MN terminated SCG DRB with security key change to keNB }
    then { UE reconfigures the DRB and sends an RRCConnectionReconfigurationComplete message }
}
```

(8)

```
with { UE in RRC_CONNECTED state with EN-DC, and, MCG(s) (E-UTRA PDCP) and MN terminated SCG DRB
established with security key keNB }
ensure that {
  when { UE receives an RRCConnectionReconfiguration message to modify the MN terminated SCG DRB to
SN terminated MCG DRB (NR PDCP) with security key change to s-KgNB }
    then { UE reconfigures the DRB and sends an RRCConnectionReconfigurationComplete message }
}
```

(9)

```

with { UE in RRC_CONNECTED state with EN-DC, and, MCG(s) (E-UTRA PDCP) and SN terminated MCG DRB (NR
PDCP) established with security key s-KgNB }
ensure that {
  when { UE receives an RRCConnectionReconfiguration message to modify the SN terminated MCG DRB (NR
PDCP) to MN terminated SCG DRB with security key change to keNB }
    then { UE reconfigures the DRB and sends an RRCConnectionReconfigurationComplete message }
}

```

8.2.2.8.1.2 Conformance requirements

References: The conformance requirements covered in the present test case are specified in: TS 36.331, clause 5.3.5.3, TS 38.331, clauses 5.3.5.3, 5.3.5.6.1 and 5.3.5.6.5, TS 37.340, clause Annex A: Table A-1: L2 handling for bearer type change with and without security key change. Unless otherwise stated these are Rel-15 requirements.

[TS 36.331, clause 5.3.5.3]

If the *RRCCConnectionReconfiguration* message does not include the *mobilityControlInfo* and the UE is able to comply with the configuration included in this message, the UE shall:

...

- 1> if the received *RRCCConnectionReconfiguration* includes the *nr-Config* and it is set to *release*: or
- 1> if the received *RRCCConnectionReconfiguration* includes *endc-ReleaseAndAdd* and it is set to *TRUE*:
 - 2> perform ENDC release as specified in TS38.331 [82], clause 5.3.5.10;
- 1> if the received *RRCCConnectionReconfiguration* includes the *sk-Counter*:
 - 2> perform key update procedure as specified in TS 38.331 [82], clause 5.3.5.7;
- 1> if the received *RRCCConnectionReconfiguration* includes the *nr-SecondaryCellGroupConfig*:
 - 2> perform NR RRC Reconfiguration as specified in TS 38.331 [82], clause 5.3.5.3;
- 1> if the received *RRCCConnectionReconfiguration* includes the *nr-RadioBearerConfig1*:
 - 2> perform radio bearer configuration as specified in TS 38.331 [82], clause 5.3.5.6;
- 1> if the received *RRCCConnectionReconfiguration* includes the *nr-RadioBearerConfig2*:
 - 2> perform radio bearer configuration as specified in TS 38.331 [82], clause 5.3.5.6;
- 1> if this is the first *RRCCConnectionReconfiguration* message after successful completion of the RRC connection re-establishment procedure:
 - 2> resume SRB2 and all DRBs that are suspended, if any, including RBs configured with NR PDCP;

NOTE 4: The handling of the radio bearers after the successful completion of the PDCP re-establishment, e.g. the re-transmission of unacknowledged PDCP SDUs (as well as the associated status reporting), the handling of the SN and the HFN, is specified in TS 36.323 [8].

NOTE 5: The UE may discard SRB2 messages and data that it receives prior to completing the reconfiguration used to resume these bearers.

...

- 1> set the content of *RRCCConnectionReconfigurationComplete* message as follows:
 - 2> if the *RRCCConnectionReconfiguration* message includes *perCC-GapIndicationRequest*:
 - 3> include *perCC-GapIndicationList* and *numFreqEffective*;
 - 2> if the frequencies are configured for reduced measurement performance:
 - 3> include *numFreqEffectiveReduced*;

2> if the received *RRCCONNECTIONRECONFIGURATION* message included *nr-SecondaryCellGroupConfig*:

3> include *scg-ConfigResponseNR* in accordance with TS 38.331 [82], clause 5.3.5.3;

1> submit the *RRCCONNECTIONRECONFIGURATIONCOMPLETE* message to lower layers for transmission using the new configuration, upon which the procedure ends;

[TS 38.331, clause 5.3.5.3]

The UE shall perform the following actions upon reception of the *RRCRECONFIGURATION*:

...

1> if the *RRCRECONFIGURATION* includes the *secondaryCellGroup*:

2> perform the cell group configuration for the SCG according to 5.3.5.5;

1> if the *RRCRECONFIGURATION* message contains the *radioBearerConfig*:

2> perform the radio bearer configuration according to 5.3.5.6;

1> if the *RRCRECONFIGURATION* message includes the *measConfig*:

2> perform the measurement configuration procedure as specified in 5.5.2;

...

1> set the content of *RRCRECONFIGURATIONCOMPLETE* message as follows:

2> if the *RRCRECONFIGURATION* includes the *masterCellGroup* containing the *reportUplinkTxDirectCurrent*, or;

2> if the *RRCRECONFIGURATION* includes the *secondaryCellGroup* containing the *reportUplinkTxDirectCurrent*:

3> include the *uplinkTxDirectCurrentList*;

1> if the UE is configured with E-UTRA *nr-SecondaryCellGroupConfig* (MCG is E-UTRA):

2> if *RRCRECONFIGURATION* was received via SRB1:

3> construct *RRCRECONFIGURATIONCOMPLETE* message and submit it via the EUTRA MCG embedded in E-UTRA RRC message *RRCCONNECTIONRECONFIGURATIONCOMPLETE* as specified in TS 36.331 [10];

3> if *reconfigurationWithSync* was included in *spCellConfig* of an SCG:

4> initiate the random access procedure on the SpCell, as specified in TS 38.321 [3];

3> else:

4> the procedure ends;

NOTE: The order the UE sends the *RRCCONNECTIONRECONFIGURATIONCOMPLETE* message and performs the Random Access procedure towards the SCG is left to UE implementation.

2> else (*RRCRECONFIGURATION* was received via SRB3):

3> submit the *RRCRECONFIGURATIONCOMPLETE* message via SRB3 to lower layers for transmission using the new configuration .

NOTE: For EN-DC, in the case *RRCRECONFIGURATION* is received via SRB1, the random access is triggered by RRC layer itself as there is not necessarily other UL transmission. In the case *RRCRECONFIGURATION* is received via SRB3, the random access is triggered by the MAC layer due to arrival of *RRCRECONFIGURATIONCOMPLETE*.

1> else:

- 2> submit the *RRCReconfigurationComplete* message via SRB1 to lower layers for transmission using the new configuration;
- 2> if this is the first *RRCReconfiguration* message after successful completion of the RRC re-establishment procedure:
 - 3> resume SRB2 and DRBs that are suspended;
- 1> if *reconfigurationWithSync* was included in *spCellConfig* of an MCG or SCG, and when MAC of an NR cell group successfully completes a random access procedure triggered above;
 - 2> stop timer T304 for that cell group;
 - 2> apply the parts of the CQI reporting configuration, the scheduling request configuration and the sounding RS configuration that do not require the UE to know the SFN of the respective target SpCell, if any;
 - 2> apply the parts of the measurement and the radio resource configuration that require the UE to know the SFN of the respective target SpCell (e.g. measurement gaps, periodic CQI reporting, scheduling request configuration, sounding RS configuration), if any, upon acquiring the SFN of that target SpCell;
 - 2> if the *reconfigurationWithSync* was included in *spCellConfig* of an MCG:
 - 3> if T390 is running:
 - 4> stop timer T390 for all access categories;
 - 4> perform the actions as specified in 5.3.14.4.
 - 3> if *RRCReconfiguration* does not include *dedicatedSIB1-Delivery* and
 - 3> if the active downlink BWP, which is indicated by the *firstActiveDownlinkBWP-Id* for the target SpCell of the MCG, has a common search space configured by *searchSpaceSIB1*:
 - 4> acquire the *SIB1*, which is scheduled as specified in TS 38.213 [13], of the target SpCell of the MCG;
 - 4> upon acquiring *SIB1*, perform the actions specified in clause 5.2.2.4.2;
 - 2> the procedure ends.

NOTE: The UE is only required to acquire broadcasted *SIB1* if the UE can acquire it without disrupting unicast data reception, i.e. the broadcast and unicast beams are quasi co-located.

[TS 38.331, clause 5.3.5.6.1]

The UE shall perform the following actions based on a received *RadioBearerConfig* IE:

...

- 1> if the *RadioBearerConfig* includes the *drb-ToAddModList*:
 - 2> perform DRB addition or reconfiguration as specified in 5.3.5.6.5.

[TS 38.331, clause 5.3.5.6.5]

The UE shall:

- 1> for each *drb-Identity* value included in the *drb-ToAddModList* that is not part of the current UE configuration (DRB establishment including the case when full configuration option is used):
 - 2> establish a PDCP entity and configure it in accordance with the received *pdcp-Config*;
 - 2> if the PDCP entity of this DRB is not configured with *cipheringDisabled*:
 - 3> if target RAT of handover is E-UTRA/5GC, or;
 - 3> if the UE is only connected to E-UTRA/5GC:

- 4> configure the PDCP entity with the ciphering algorithm and K_{UPenc} key configured/derived as specified in TS 36.331 [10];
- 3> else:
 - 4> configure the PDCP entity with the ciphering algorithms according to *securityConfig* and apply the K_{UPenc} key associated with the master key (K_{eNB}/K_{gNB}) or the secondary key ($S-K_{gNB}$) as indicated in *keyToUse*;
- 2> if the PDCP entity of this DRB is configured with *integrityProtection*:
 - 3> configure the PDCP entity with the integrity algorithms according to *securityConfig* and apply the K_{UPint} key associated with the master (K_{eNB}/K_{gNB}) or the secondary key ($S-K_{gNB}$) as indicated in *keyToUse*;
- ...
- 2> if the UE is operating in EN-DC:
 - 3> if the DRB was configured with the same *eps-BearerIdentity* either by NR or E-UTRA prior to receiving this reconfiguration:
 - 4> associate the established DRB with the corresponding *eps-BearerIdentity*;
 - 3> else:
 - 4> indicate the establishment of the DRB(s) and the *eps-BearerIdentity* of the established DRB(s) to upper layers;
- 1> for each *drb-Identity* value included in the *drb-ToAddModList* that is part of the current UE configuration:
 - 2> if the *reestablishPDCP* is set:
 - 3> if target RAT is E-UTRA/5GC, or:
 - 3> if the UE is only connected to E-UTRA/5GC:
 - 4> if the PDCP entity of this DRB is not configured with *cipheringDisabled*:
 - 5> configure the PDCP entity with the ciphering algorithm and K_{UPenc} key configured/derived as specified in TS 36.331 [10, 5.4.2.3], i.e. the ciphering configuration shall be applied to all subsequent PDCP PDUs received and sent by the UE;
 - 3> else:
 - 4> if the PDCP entity of this DRB is not configured with *cipheringDisabled*:
 - 5> configure the PDCP entity with the ciphering algorithm and K_{UPenc} key associated with the master key (K_{eNB}/K_{gNB}) or the secondary key ($S-K_{gNB}$), as indicated in *keyToUse*, i.e. the ciphering configuration shall be applied to all subsequent PDCP PDUs received and sent by the UE;
 - 4> if the PDCP entity of this DRB is configured with *integrityProtection*:
 - 5> configure the PDCP entity with the integrity algorithms according to *securityConfig* and apply the K_{UPint} key associated with the master (K_{eNB}/K_{gNB}) or the secondary key ($S-K_{gNB}$) as indicated in *keyToUse*;
 - 3> re-establish the PDCP entity of this DRB as specified in 38.323 [5], clause 5.1.2;
 - 2> else, if the *recoverPDCP* is set:
 - 3> trigger the PDCP entity of this DRB to perform data recovery as specified in 38.323 [5];
 - 2> if the *pdc-Config* is included:
 - 3> reconfigure the PDCP entity in accordance with the received *pdc-Config*.
 - ...

NOTE 1: Void.

NOTE 2: When determining whether a drb-Identity value is part of the current UE configuration, the UE does not distinguish which *RadioBearerConfig* and *DRB-ToAddModList* that DRB was originally configured in. To re-associate a DRB with a different key (K_{eNB} to $S-K_{gNB}$ or vice versa), the network provides the *drb-Identity* value in the (target) *drb-ToAddModList* and sets the *reestablishPDCP* flag. The network does not list the *drb-Identity* in the (source) *drb-ToReleaseList*.

NOTE 3: When setting the *reestablishPDCP* flag for a radio bearer, the network ensures that the RLC receiver entities do not deliver old PDCP PDUs to the re-established PDCP entity. It does that e.g. by triggering a reconfiguration with sync of the cell group hosting the old RLC entity or by releasing the old RLC entity.

NOTE 4: In this specification, UE configuration refers to the parameters configured by NR RRC unless otherwise stated.

NOTE 5: Ciphering and integrity protection can be enabled or disabled for a DRB. The enabling/disabling of ciphering or integrity protection can be changed only by releasing and adding the DRB.

[TS 37.340, Annex A]

This subclause provides for information an overview on L2 handling for bearer type change in EN-DC, with and without security key change (from K_{eNB} to $S-K_{gNB}$ and from $S-K_{gNB}$ to K_{eNB}), i.e. with and without a change of the termination point.

Table A-1: L2 handling for bearer type change with and without security key change

Bearer type change from row to col	MCG		Split		SCG	
	no key change	with key change ($K_{eNB} \leftrightarrow S-K_{gNB}$)	no key change	with key change ($K_{eNB} \leftrightarrow S-K_{gNB}$)	no key change	with key change ($K_{eNB} \leftrightarrow S-K_{gNB}$)
MCG	N/A	PDCP: Re-establish MCG RLC: See Note 1 MCG MAC: See Note 1 SCG RLC: No action SCG MAC: No action	PDCP: Reconfigure MCG RLC: No action MCG MAC: No action SCG RLC: Establish SCG MAC: Reconfigure	PDCP: Re-establish MCG RLC: See Note 1 MCG MAC: See Note 1 SCG RLC: Establish SCG MAC: Reconfigure	PDCP: Recovery MCG RLC: See Note 3 MCG MAC: Reconfigure SCG RLC: Establish SCG MAC: Reconfigure	PDCP: Re-establish MCG RLC: See Note 3 MCG MAC: Reconfigure SCG RLC: Establish SCG MAC: Reconfigure
Split	PDCP: Recovery MCG RLC: No action MCG MAC: No action SCG RLC: See Note 4 SCG MAC: Reconfigure	PDCP: Re-establish MCG RLC: See Note 1 MCG MAC: See Note 1 SCG RLC: See Note 4 SCG MAC: Reconfigure	N/A	PDCP: Re-establish MCG RLC: See Note 1 MCG MAC: See Note 1 SCG RLC: See Note 1 SCG MAC: See Note 1	PDCP: Recovery MCG RLC: See Note 3 MCG MAC: Reconfigure SCG RLC: No action SCG MAC: No action	PDCP: Re-establish MCG RLC: See Note 3 MCG MAC: Reconfigure SCG RLC: See Note 1 SCG MAC: See Note 1
SCG	PDCP: Recovery MCG RLC: Establish MCG MAC: Reconfigure SCG RLC: See Note 4 SCG MAC: Reconfigure	PDCP: Re-establish MCG RLC: Establish MCG MAC: Reconfigure SCG RLC: See Note 4 SCG MAC: Reconfigure	PDCP: Reconfigure MCG RLC: Establish MCG MAC: Reconfigure SCG RLC: No action SCG MAC: No action	PDCP: Re-establish MCG RLC: Establish MCG MAC: Reconfigure SCG RLC: See Note 1 SCG MAC: See Note 1	N/A	PDCP: Re-establish MCG RLC: No action MCG MAC: No action SCG RLC: See Note 1 SCG MAC: See note 1

NOTE 1: For EN-DC and NGEN-DC MCG, NE-DC SCG: the MAC/RLC behaviour depends on the solution selected by the network. It can be PCell handover (for EN-DC and NGEN-DC) or PSCell change (for NE-DC), which triggers MAC reset and RLC re-establishment. Alternatively, the logical channel identity can be changed, either via RLC bearer release and add for the same DRB (including RLC re-establishment), or via reconfiguration of the RLC bearer with RLC-re-establishment.

For EN-DC and NGEN-DC SCG, NE-DC MCG, NR-DC MCG and SCG: the MAC/RLC behaviour depends on the solution selected by the network. It can be reconfiguration with sync, with MAC reset and RLC re-establishment. Alternatively, the logical channel identity can be changed via RLC bearer release and add.

NOTE 2: Void

NOTE 3: For EN-DC and NGEN-DC: Re-establishment and release. For NE-DC and NR-DC: Release.

NOTE 4: For NE-DC: Re-establishment and release. For EN-DC, NGEN-DC and NR-DC: Release.

8.2.2.8.1.3 Test description

8.2.2.8.1.3.1 Pre-test conditions

System Simulator:

- E-UTRA Cell 1 is the PCell and NR Cell 1 is the PSCell.

UE:

- None.

Preamble:

- If `pc_IP_Ping` is set to TRUE then, the UE is in state `RRC_CONNECTED` using generic procedure parameter Connectivity (*EN-DC*), Bearers (*MCG(s) and SCG*) established according to TS 38.508-1 [4], clause 4.5.4.
- Else, the UE is in state `RRC_CONNECTED` using generic procedure parameter Connectivity (*EN-DC*), Bearers (*MCG(s) and SCG*) established and Test Loop Function (On) with UE test loop mode B according to TS 38.508-1 [4], clause 4.5.4.

8.2.2.8.1.3.2 Test procedure sequence

Table 8.2.2.8.1.3.2-1: Main behaviour

St	Procedure	Message Sequence		TP	Verdict
		U - S	Message		
1	The SS transmits an <i>RRCCONNECTIONRECONFIGURATION</i> message containing NR <i>RRCRECONFIGURATION</i> message to modify SN terminated SCG DRB with security key s-KgNB to MN terminated SCG DRB with security key change to keNB.	<--	<i>RRCCONNECTIONRECONFIGURATION (RRCRECONFIGURATION)</i>	-	-
2	Check: Does the UE transmit an <i>RRCCONNECTIONRECONFIGURATIONCOMPLETE</i> message containing NR <i>RRCRECONFIGURATIONCOMPLETE</i> message?	-->	<i>RRCCONNECTIONRECONFIGURATIONCOMPLETE (RRCRECONFIGURATIONCOMPLETE)</i>	1	P
3	Check: Does the test result of generic test procedure in TS 38.508-1 subclause 4.9.1 indicate that the UE is capable of exchanging IP data on SCG DRB#2?	-	-	1	P
4	The SS transmits an <i>RRCCONNECTIONRECONFIGURATION</i> message containing NR <i>RRCRECONFIGURATION</i> message to modify MN terminated SCG DRB with security key keNB to SN terminated Split DRB with security key change to s-KgNB.	<--	<i>RRCCONNECTIONRECONFIGURATION (RRCRECONFIGURATION)</i>	-	-
5	Check: Does the UE transmit an <i>RRCCONNECTIONRECONFIGURATIONCOMPLETE</i> message containing NR <i>RRCRECONFIGURATIONCOMPLETE</i> message?	-->	<i>RRCCONNECTIONRECONFIGURATIONCOMPLETE (RRCRECONFIGURATIONCOMPLETE)</i>	2	P
6	Check: Does the test result of generic test procedure in TS 38.508-1 subclause 4.9.1 indicate that the UE is capable of exchanging IP data on Split DRB#2 using NR radio path?	-	-	2	P
7	The SS transmits an <i>RRCCONNECTIONRECONFIGURATION</i> message containing NR <i>RRCRECONFIGURATION</i> message to modify SN terminated Split DRB with security key s-KgNB to MN terminated Split DRB with security key change to keNB.	<--	<i>RRCCONNECTIONRECONFIGURATION (RRCRECONFIGURATION)</i>	-	-
8	Check: Does the UE transmit an <i>RRCCONNECTIONRECONFIGURATIONCOMPLETE</i> message containing NR <i>RRCRECONFIGURATIONCOMPLETE</i> message?	-->	<i>RRCCONNECTIONRECONFIGURATIONCOMPLETE (RRCRECONFIGURATIONCOMPLETE)</i>	3	P
9	Check: Does the test result of generic test procedure in TS 38.508-1 subclause 4.9.1 indicate that the UE is capable of exchanging IP data on Split DRB#2 using NR radio path?	-	-	3	P
10	The SS transmits an <i>RRCCONNECTIONRECONFIGURATION</i> message containing NR <i>RADIOBEARERCONFIG</i> and <i>NR-CONFIG</i> set to release to modify MN terminated Split DRB with security key keNB to SN terminated MCG DRB with security key change to s-KgNB.	<--	<i>RRCCONNECTIONRECONFIGURATION</i>	-	-
11	Check: Does the UE transmit an <i>RRCCONNECTIONRECONFIGURATIONCOMPLETE</i> message?	-->	<i>RRCCONNECTIONRECONFIGURATIONCOMPLETE</i>	4	P
12	Check: Does the test result of generic test procedure in TS 38.508-1 subclause 4.9.1 indicate that the UE is capable of exchanging IP data on MCG DRB#2?	-	-	4	P
13	The SS transmits an <i>RRCCONNECTIONRECONFIGURATION</i> message containing NR <i>RADIOBEARERCONFIG</i> to modify SN terminated MCG DRB with security key s-KgNB to MN terminated MCG DRB with security key change to keNB.	<--	<i>RRCCONNECTIONRECONFIGURATION</i>	-	-

14	Check: Does the UE transmit an <i>RRCCONNECTIONRECONFIGURATIONCOMPLETE</i> message?	-->	<i>RRCCONNECTIONRECONFIGURATIONCOMPLETE</i>	5	P
15	Check: Does the test result of generic test procedure in TS 38.508-1 subclause 4.9.1 indicate that the UE is capable of exchanging IP data on MCG DRB#2?	-	-	5	P
16	The SS transmits an <i>RRCCONNECTIONRECONFIGURATION</i> message containing NR <i>RRCRECONFIGURATION</i> message to modify MN terminated MCG DRB with security key keNB to SN terminated Split DRB with security key change to s-KgNB.	<--	<i>RRCCONNECTIONRECONFIGURATION (RRCRECONFIGURATION)</i>	-	-
17	Check: Does the UE transmit an <i>RRCCONNECTIONRECONFIGURATIONCOMPLETE</i> message containing NR <i>RRCRECONFIGURATIONCOMPLETE</i> message?	-->	<i>RRCCONNECTIONRECONFIGURATIONCOMPLETE (RRCRECONFIGURATIONCOMPLETE)</i>	6	P
18	Check: Does the test result of generic test procedure in TS 38.508-1 subclause 4.9.1 indicate that the UE is capable of exchanging IP data on Split DRB#2 using NR radio path?	-	-	6	P
19	The SS transmits an <i>RRCCONNECTIONRECONFIGURATION</i> message containing NR <i>RRCRECONFIGURATION</i> message to modify SN terminated Split DRB with security key s-KgNB to MN terminated SCG DRB with security key change to keNB.	<--	<i>RRCCONNECTIONRECONFIGURATION (RRCRECONFIGURATION)</i>	-	-
20	Check: Does the UE transmit an <i>RRCCONNECTIONRECONFIGURATIONCOMPLETE</i> message containing NR <i>RRCRECONFIGURATIONCOMPLETE</i> message?	-->	<i>RRCCONNECTIONRECONFIGURATIONCOMPLETE (RRCRECONFIGURATIONCOMPLETE)</i>	7	P
21	Check: Does the test result of generic test procedure in TS 38.508-1 subclause 4.9.1 indicate that the UE is capable of exchanging IP data on SCG DRB#2?	-	-	7	P
22	The SS transmits an <i>RRCCONNECTIONRECONFIGURATION</i> message containing NR <i>RRCRECONFIGURATION</i> message to modify MN terminated SCG DRB with security key keNB to SN terminated MCG DRB with security key change to s-KgNB.	<--	<i>RRCCONNECTIONRECONFIGURATION (RRCRECONFIGURATION)</i>	-	-
23	Check: Does the UE transmit an <i>RRCCONNECTIONRECONFIGURATIONCOMPLETE</i> message containing NR <i>RRCRECONFIGURATIONCOMPLETE</i> message?	-->	<i>RRCCONNECTIONRECONFIGURATIONCOMPLETE (RRCRECONFIGURATIONCOMPLETE)</i>	8	P
24	Check: Does the test result of generic test procedure in TS 38.508-1 subclause 4.9.1 indicate that the UE is capable of exchanging IP data on MCG DRB#2?	-	-	8	P
25	The SS transmits an <i>RRCCONNECTIONRECONFIGURATION</i> message containing NR <i>RRCRECONFIGURATION</i> message to modify SN terminated MCG DRB with security key s-KgNB to MN terminated SCG DRB with security key change to keNB.	<--	<i>RRCCONNECTIONRECONFIGURATION (RRCRECONFIGURATION)</i>	-	-
26	Check: Does the UE transmit an <i>RRCCONNECTIONRECONFIGURATIONCOMPLETE</i> message containing NR <i>RRCRECONFIGURATIONCOMPLETE</i> message?	-->	<i>RRCCONNECTIONRECONFIGURATIONCOMPLETE (RRCRECONFIGURATIONCOMPLETE)</i>	9	P
27	Check: Does the test result of generic test procedure in TS 38.508-1 subclause 4.9.1 indicate that the UE is capable of exchanging IP data on SCG DRB#2?	-	-	9	P

Table 8.2.2.8.1.3.3-5: RRCConnectionReconfiguration (step 4, Table 8.2.2.8.1.3.2-1)

Derivation Path: 36.508 [7], Table 4.6.1-8			
Information Element	Value/remark	Comment	Condition
RRCConnectionReconfiguration ::= SEQUENCE {			
criticalExtensions CHOICE {			
c1 CHOICE{			
rrcConnectionReconfiguration-r8 SEQUENCE {			
radioResourceConfigDedicated	RadioResourceConfigDe dicated-MN_SCG-to- SN_Split		
nonCriticalExtension SEQUENCE {			
nonCriticalExtension SEQUENCE {			
nonCriticalExtension SEQUENCE {			
nonCriticalExtension SEQUENCE {			
nonCriticalExtension SEQUENCE {			
nonCriticalExtension SEQUENCE {			
nonCriticalExtension SEQUENCE {			
nonCriticalExtension SEQUENCE {			
nr-Config-r15 CHOICE {			
setup SEQUENCE {			
nr-SecondaryCellGroupConfig-r15	OCTET STRING including the <i>RRCReconfiguration</i> message and the IE secondaryCellGroup according TS 38.508-1 [4], table 4.6.1-13 with condition EN-DC_HO.		
}			
}			
nr-RadioBearerConfig1-r15	OCTET STRING including RadioBearerConfig.		
}			
}			
}			
}			
}			
}			
}			
}			
}			
}			
}			
}			
}			

Table 8.2.2.8.1.3.3-6: RadioResourceConfigDedicated-MN_SCG-to-SN_Split (Table 8.2.2.8.1.3.3-5)

Derivation Path: 36.508 [7], Table 4.6.3-19AAAAAB			
Information Element	Value/remark	Comment	Condition
RadioResourceConfigDedicated-EN-DC-Split ::= SEQUENCE {			
srb-ToAddModList	Not present		
drb-ToAddModList SEQUENCE (SIZE (1..maxDRB))	1 entry		
OF DRB-ToAddMod {			
DRB-ToAddMod[1]	DRB-ToAddMod-EN-DC- Split	entry 1	
}			
}			

Table 8.2.2.8.1.3.3-7: Void

Table 8.2.2.8.1.3.3-8: Void

Table 8.2.2.8.1.3.3-9: *RadioBearerConfig* (Table 8.2.2.8.1.3.3-5)

Derivation Path: 38.508-1 [4], Table 4.6.3-132 with condition EN-DC_DRB AND Re-establish_PDCP			
Information Element	Value/remark	Comment	Condition
RadioBearerConfig ::= SEQUENCE {			
drb-ToAddModList SEQUENCE (SIZE (1..maxDRB))	1 entry		
OF DRB-ToAddMod {			
DRB-ToAddMod[1] SEQUENCE {		entry 1	
pdcp-Config	PDCP-Config		
}			
}			
securityConfig SEQUENCE {			
keyToUse	secondary		
}			
}			

Table 8.2.2.8.1.3.3-10: *PDCP-Config* (Table 8.2.2.8.1.3.3-9)

Derivation Path: 38.508-1 [4], Table 4.6.3-99			
Information Element	Value/remark	Comment	Condition
PDCP-Config ::= SEQUENCE {			
moreThanOneRLC SEQUENCE {			
primaryPath SEQUENCE {			
cellGroup	1		
}			
ul-DataSplitThreshold	infinity		
}			
}			

Table 8.2.2.8.1.3.3-11: RRCConnectionReconfiguration (step 7, Table 8.2.2.8.1.3.2-1)

Derivation Path: 36.508 [7], Table 4.6.1-8			
Information Element	Value/remark	Comment	Condition
RRCConnectionReconfiguration ::= SEQUENCE {			
criticalExtensions CHOICE {			
c1 CHOICE{			
rrcConnectionReconfiguration-r8 SEQUENCE {			
mobilityControlInfo	MobilityControlInfo-HO-SameCell	As per Table 7.1.3.2.1.3.3-1A	
radioResourceConfigDedicated	RadioResourceConfigDedicated-SN_Split-to-MN_Split		
securityConfigHO	SecurityConfigHO-DEFAULT		HO, HO-TO-EUTRA
nonCriticalExtension SEQUENCE {			
nonCriticalExtension SEQUENCE {			
nonCriticalExtension SEQUENCE {			
nonCriticalExtension SEQUENCE {			
nonCriticalExtension SEQUENCE {			
nonCriticalExtension SEQUENCE {			
nonCriticalExtension SEQUENCE {			
nonCriticalExtension SEQUENCE {			
nr-Config-r15 CHOICE {			
setup SEQUENCE {			
nr-SecondaryCellGroupConfig-r15	OCTET STRING including the RRCReconfiguration message and the IE secondaryCellGroup according TS 38.508-1 [4], table 4.6.1-13 with condition EN-DC_HO.		
}			
}			
nr-RadioBearerConfig1-r15	OCTET STRING including RadioBearerConfig.		
}			
}			
}			
}			
}			
}			
}			
}			
}			
}			
}			
}			
}			
}			
}			

Table 8.2.2.8.1.3.3-12: RadioResourceConfigDedicated-SN_Split-to-MN_Split (Table 8.2.2.8.1.3.3-11)

Derivation Path: 36.508 [7], Table 4.6.3-18			
Information Element	Value/remark	Comment	Condition
RadioResourceConfigDedicated-HO-TO-EUTRA(1, 0) ::= SEQUENCE {			
drb-ToAddModList	DRB-ToAddModList-SN_Split-to-MN_Split		
}			

Table 8.2.2.8.1.3.3-13: DRB-ToAddModList-SN_Split-to-MN_Split (Table 8.2.2.8.1.3.3-12)

Derivation Path: 36.508 [7], Table 4.6.3-2A			
Information Element	Value/remark	Comment	Condition
DRB-ToAddModList ::= SEQUENCE (SIZE (1..maxDRB)) OF DRB-ToAddMod {	1 Entry		
DRB-ToAddMod[1] SEQUENCE {		entry 1	
eps-BearerIdentity	6	Dedicated EPS bearer Id of Split DRB	
drb-Identity	2	Split DRB Id	
rlc-Config-v1510 SEQUENCE {			
reestablishRLC-r15	true		
}			
}			
}			

Table 8.2.2.8.1.3.3-14: Void

Table 8.2.2.8.1.3.3-15: Void

Table 8.2.2.8.1.3.3-16: RadioBearerConfig (Table 8.2.2.8.1.3.3-11)

Derivation Path: 38.508-1 [4], Table 4.6.3-132 with condition EN-DC_DRB AND Re-establish_PDCP			
Information Element	Value/remark	Comment	Condition
RadioBearerConfig ::= SEQUENCE {			
securityConfig SEQUENCE {			
keyToUse	master		
}			
}			

Table 8.2.2.8.1.3.3-19: DRB-ToAddModList-MN_Split-to-SN_MCG (Table 8.2.2.8.1.3.3-18)

Derivation Path: 36.508 [7], Table 4.6.3-2A			
Information Element	Value/remark	Comment	Condition
DRB-ToAddModList ::= SEQUENCE (SIZE (1..maxDRB)) OF DRB-ToAddMod {	1 Entry		
DRB-ToAddMod[1] SEQUENCE {		entry 1	
eps-BearerIdentity	6	Dedicated EPS bearer Id of Split DRB	
drb-Identity	2	Split DRB Id	
rlc-Config-v1510 SEQUENCE {			
reestablishRLC-r15	true		
}			
}			
}			

Table 8.2.2.8.1.3.3-20: Void

Table 8.2.2.8.1.3.3-21: Void

Table 8.2.2.8.1.3.3-22: RadioBearerConfig (Table 8.2.2.8.1.3.3-17)

Derivation Path: 38.508-1 [4], Table 4.6.3-132 with condition EN-DC and Re-establish_PDCP

Table 8.2.2.8.1.3.3-25: DRB-ToAddModList-SN_MCG-to-MN_MCG (Table 8.2.2.8.1.3.3-24)

Derivation Path: 36.508 [7], Table 4.6.3-2A			
Information Element	Value/remark	Comment	Condition
DRB-ToAddModList ::= SEQUENCE (SIZE (1..maxDRB)) OF DRB-ToAddMod {	1 Entry		
DRB-ToAddMod[1] SEQUENCE {		entry 1	
eps-BearerIdentity	6	Dedicated EPS bearer Id of MCG DRB	
drb-Identity	2	MCG DRB Id	
rlc-Config-v1510 SEQUENCE {			
reestablishRLC-r15	true		
}			
}			
}			

Table 8.2.2.8.1.3.3-25a: Void**Table 8.2.2.8.1.3.3-25b: Void****Table 8.2.2.8.1.3.3-26: RadioBearerConfig (Table 8.2.2.8.1.3.3-23)**

Derivation Path: 38.508-1 [4], Table 4.6.3-132 with condition EN-DC_DRB AND Re-establish_PDCP			
Information Element	Value/remark	Comment	Condition
RadioBearerConfig ::= SEQUENCE {			
securityConfig SEQUENCE {			
keyToUse	master		
}			
}			

Table 8.2.2.8.1.3.3-27: RRCConnectionReconfiguration (step 16, Table 8.2.2.8.1.3.2-1)

Derivation Path: 36.508 [7], Table 4.6.1-8			
Information Element	Value/remark	Comment	Condition
RRCConnectionReconfiguration ::= SEQUENCE {			
criticalExtensions CHOICE {			
c1 CHOICE{			
rrcConnectionReconfiguration-r8 SEQUENCE {			
mobilityControlInfo	MobilityControlInfo-HO-SameCell	As per Table 7.1.3.2.1.3.3-1A	
radioResourceConfigDedicated	RadioResourceConfigDedicated-MN_MCG-to-SN_Split		
securityConfigHO	SecurityConfigHO-DEFAULT		HO, HO-TO-EUTRA
nonCriticalExtension SEQUENCE {			
nonCriticalExtension SEQUENCE {			
nonCriticalExtension SEQUENCE {			
nonCriticalExtension SEQUENCE {			
nonCriticalExtension SEQUENCE {			
nonCriticalExtension SEQUENCE {			
nonCriticalExtension SEQUENCE {			
nonCriticalExtension SEQUENCE {			
nr-Config-r15 CHOICE {			
setup SEQUENCE {			
nr-SecondaryCellGroupConfig-r15	OCTET STRING including the RRCReconfiguration message and the IE secondaryCellGroup according TS 38.508-1 [4], table 4.6.1-13 with condition EN-DC..		
}			
}			
nr-RadioBearerConfig1-r15	OCTET STRING including RadioBearerConfig.		
}			
}			
}			
}			
}			
}			
}			
}			
}			
}			
}			
}			
}			
}			

Table 8.2.2.8.1.3.3-28: RadioResourceConfigDedicated-MN_MCG-to-SN_Split (Table 8.2.2.8.1.3.3-27)

Derivation Path: 36.508 [7], Table 4.6.3-18			
Information Element	Value/remark	Comment	Condition
RadioResourceConfigDedicated-HO-TO-EUTRA(1, 0) ::= SEQUENCE {			
drb-ToAddModList	DRB-ToAddModList-MN_MCG-to-SN_Split		
}			

Table 8.2.2.8.1.3.3-29: DRB-ToAddModList-MN_MCG-to-SN_Split (Table 8.2.2.8.1.3.3-30)

Derivation Path: 36.508 [7], Table 4.6.3-2A			
Information Element	Value/remark	Comment	Condition
DRB-ToAddModList ::= SEQUENCE (SIZE (1..maxDRB)) OF DRB-ToAddMod {	1 Entry		
DRB-ToAddMod[1] SEQUENCE {		entry 1	
eps-BearerIdentity[1]	6	Dedicated EPS bearer Id of MCG DRB	
drb-Identity[1]	2	MCG DRB Id	
rlc-Config-v1510[1] SEQUENCE {			
reestablishRLC-r15	true		
}			
}			
}			

Table 8.2.2.8.1.3.3-30: Void

Table 8.2.2.8.1.3.3-31: Void

Table 8.2.2.8.1.3.3-32: RadioBearerConfig (Table 8.2.2.8.1.3.3-27)

Derivation Path: 38.508-1 [4], Table 4.6.3-132 with condition EN-DC_DRB AND Re-establish_PDCP			
Information Element	Value/remark	Comment	Condition
RadioBearerConfig ::= SEQUENCE {			
drb-ToAddModList SEQUENCE (SIZE (1..maxDRB)) OF DRB-ToAddMod {	1 entry		
DRB-ToAddMod[1] SEQUENCE {		entry 1	
pdcpc-Config	PDCP-Config		
}			
securityConfig SEQUENCE {			
keyToUse	secondary		
}			
}			

Table 8.2.2.8.1.3.3-33: PDCP-Config (Table 8.2.2.8.1.3.3-32)

Derivation Path: 38.508-1 [4], Table 4.6.3-99			
Information Element	Value/remark	Comment	Condition
PDCP-Config ::= SEQUENCE {			
moreThanOneRLC SEQUENCE {			
primaryPath SEQUENCE {			
cellGroup	1		
}			
ul-DataSplitThreshold	infinity		
}			

Table 8.2.2.8.1.3.3-34: RRCConnectionReconfiguration (step 19, Table 8.2.2.8.1.3.2-1)

Derivation Path: 36.508 [7], Table 4.6.1-8			
Information Element	Value/remark	Comment	Condition
RRCConnectionReconfiguration ::= SEQUENCE {			
criticalExtensions CHOICE {			
c1 CHOICE{			
rrcConnectionReconfiguration-r8 SEQUENCE {			
radioResourceConfigDedicated	RadioResourceConfigDe dicated-DRB-REL(2)		
nonCriticalExtension SEQUENCE {			
nonCriticalExtension SEQUENCE {			
nonCriticalExtension SEQUENCE {			
nonCriticalExtension SEQUENCE {			
nonCriticalExtension SEQUENCE {			
nonCriticalExtension SEQUENCE {			
nonCriticalExtension SEQUENCE {			
nonCriticalExtension SEQUENCE {			
nr-Config-r15 CHOICE {			
setup SEQUENCE {			
nr-SecondaryCellGroupConfig-r15	OCTET STRING including the <i>RRCReconfiguration</i> message and the IE secondaryCellGroup according TS 38.508-1 [4], table 4.6.1-13 with condition EN-DC_HO.		
}			
}			
nr-RadioBearerConfig1-r15	OCTET STRING including RadioBearerConfig.		
}			
}			
}			
}			
}			
}			
}			
}			
}			
}			
}			
}			
}			
}			
}			
}			

Table 8.2.2.8.1.3.3-35: Void

Table 8.2.2.8.1.3.3-36: Void

Table 8.2.2.8.1.3.3-37: RadioBearerConfig (Table 8.2.2.8.1.3.3-34)

Derivation Path: 38.508-1 [4], Table 4.6.3-132 with condition EN-DC AND Re-establish_PDCP			
Information Element	Value/remark	Comment	Condition
RadioBearerConfig ::= SEQUENCE {			
securityConfig SEQUENCE {			
keyToUse	master		
}			
}			

Table 8.2.2.8.1.3.3-41: Void

Table 8.2.2.8.1.3.3-42: Void

Table 8.2.2.8.1.3.3-43: *RadioBearerConfig* (Table 8.2.2.8.1.3.3-38)

Derivation Path: 38.508-1 [4], Table 4.6.3-132 with condition EN-DC and Re-establish_PDCP			
Information Element	Value/remark	Comment	Condition
RadioBearerConfig ::= SEQUENCE {			
securityConfig SEQUENCE {			
keyToUse	secondary		
}			
}			

Table 8.2.2.8.1.3.3-44: *RRConnectionReconfiguration* (step 25, Table 8.2.2.8.1.3.2-1)

Derivation Path: 36.508 [7], Table 4.6.1-8			
Information Element	Value/remark	Comment	Condition
RRConnectionReconfiguration ::= SEQUENCE {			
criticalExtensions CHOICE {			
c1 CHOICE{			
rrcConnectionReconfiguration-r8 SEQUENCE {			
radioResourceConfigDedicated	RadioResourceConfigDe dicated-DRB-REL(2)		
nonCriticalExtension SEQUENCE {			
nonCriticalExtension SEQUENCE {			
nonCriticalExtension SEQUENCE {			
nonCriticalExtension SEQUENCE {			
nonCriticalExtension SEQUENCE {			
nonCriticalExtension SEQUENCE {			
nonCriticalExtension SEQUENCE {			
nr-Config-r15 CHOICE {			
setup SEQUENCE {			
nr-SecondaryCellGroupConfig-r15	OCTET STRING including the <i>RRReconfiguration</i> message and the IE secondaryCellGroup according TS 38.508-1 [4], table 4.6.1-13 with condition EN-DC_HO.		
}			
}			
}			
nr-RadioBearerConfig1-r15	OCTET STRING including RadioBearerConfig.		
}			
}			
}			

Table 8.2.2.8.1.3.3-45: Void

Table 8.2.2.8.1.3.3-46: Void

Table 8.2.2.8.1.3.3-47: *RadioBearerConfig* (Table 8.2.2.8.1.3.3-44)

Derivation Path: 38.508-1 [4], Table 4.6.3-132 with condition EN-DC and Re-establish_PDCP			
Information Element	Value/remark	Comment	Condition
RadioBearerConfig ::= SEQUENCE {			
securityConfig SEQUENCE {			
keyToUse	master		
}			
}			

Table 8.2.2.8.1.3.3-48: *RRCConnectionReconfigurationComplete* (steps 2, 5, 8, 17, 20, 23, 26, Table 8.2.2.8.1.3.2-1)

Derivation Path: 36.508 [7] Table 4.6.1-9			
Information Element	Value/remark	Comment	Condition
RRCConnectionReconfigurationComplete ::= SEQUENCE {			
criticalExtensions CHOICE {			
rrcConnectionReconfigurationComplete-r8 SEQUENCE {			
nonCriticalExtension SEQUENCE {			
nonCriticalExtension SEQUENCE {			
nonCriticalExtension SEQUENCE {			
nonCriticalExtension SEQUENCE {			
nonCriticalExtension SEQUENCE {			
scg-ConfigResponseNR-r15	Present		
}			
}			
}			
}			
}			
}			
}			
}			

8.2.2.8.2 Bearer Modification / Handling for bearer type change with security key change / NR-DC

8.2.2.8.2.1 Test Purpose (TP)

(1)

```

with { UE in NR RRC_CONNECTED state with NR-DC }
ensure that {
  when { UE receives an RRCReconfiguration message to modify the SN terminated SCG DRB to MN
          terminated SCG DRB with security key change to KgNB }
    then { UE reconfigures the DRB and sends an RRCReconfigurationComplete message }
}

```

(2)

```

with { UE in NR RRC_CONNECTED state with NR-DC and MN terminated SCG DRB established with security
key KgNB }
ensure that {

```

```

when { UE receives an RRCReconfiguration message to modify the MN terminated SCG DRB to SN
terminated Split DRB with security key change to s-KgNB }
  then { UE reconfigures the DRB and sends an RRCReconfigurationComplete message }
}

```

(3)

```

with { UE in RRC_CONNECTED state with NR-DC and SN terminated Split DRB established with security
key s-KgNB }
ensure that {
  when { UE receives an RRCReconfiguration message to modify the SN terminated Split DRB to MN
terminated Split DRB with security key change to KgNB }
    then { UE reconfigures the DRB and sends an RRCReconfigurationComplete message }
}

```

(4)

```

with { UE in RRC_CONNECTED state with NR-DC and MN terminated Split DRB established with security
key KgNB }
ensure that {
  when { UE receives an RRCReconfiguration message to modify the MN terminated Split DRB to SN
terminated MCG DRB with security key change to s-KgNB }
    then { UE reconfigures the DRB and sends an RRCReconfigurationComplete message }
}

```

(5)

```

with { UE in RRC_CONNECTED state with NR-DC and SN terminated MCG DRB established with security key
s-KgNB }
ensure that {
  when { UE receives an RRCReconfiguration message to modify the SN terminated MCG DRB to MN
terminated MCG DRB with security key change to KgNB }
    then { UE reconfigures the DRB and sends an RRCReconfigurationComplete message }
}

```

(6)

```

with { UE in RRC_CONNECTED state with NR-DC and MN terminated MCG DRB established with security key
KgNB }
ensure that {
  when { UE receives an RRCReconfiguration message to modify the MN terminated MCG DRB to SN
terminated Split DRB with security key change to s-KgNB }
    then { UE reconfigures the DRB and sends an RRCReconfigurationComplete message }
}

```

(7)

```

with { UE in RRC_CONNECTED state with NR-DC and SN terminated Split DRB established with security
key s-KgNB }
ensure that {
  when { UE receives an RRCReconfiguration message to modify the SN terminated Split DRB to MN
terminated SCG DRB with security key change to KgNB }
    then { UE reconfigures the DRB and sends an RRCReconfigurationComplete message }
}

```

(8)

```

with { UE in RRC_CONNECTED state with NR-DC and MN terminated SCG DRB established with security key
KgNB }
ensure that {
  when { UE receives an RRCReconfiguration message to modify the MN terminated SCG DRB to SN
terminated MCG DRB with security key change to s-KgNB }
    then { UE reconfigures the DRB and sends an RRCReconfigurationComplete message }
}

```

(9)

```

with { UE in RRC_CONNECTED state with NR-DC and SN terminated MCG DRB established with security key
s-KgNB }
ensure that {
  when { UE receives an RRCReconfiguration message to modify the SN terminated MCG DRB to MN
terminated SCG DRB with security key change to KgNB }
}

```

```

then { UE reconfigures the DRB and sends an RRCReconfigurationComplete message }
}

```

8.2.2.8.2.2 Conformance requirements

References: The conformance requirements covered in the present test case are specified in: TS 38.331, clauses 5.3.5.3, 5.3.5.6.1 and 5.3.5.6.5, TS 37.340, clause Annex A: Table A-1: L2 handling for bearer type change with and without security key change. Unless otherwise stated these are Rel-15 requirements.

[TS 38.331, clause 5.3.5.3]

The UE shall perform the following actions upon reception of the *RRCReconfiguration*:

...

1> if the *RRCReconfiguration* includes the *secondaryCellGroup*:

2> perform the cell group configuration for the SCG according to 5.3.5.5;

1> if the *RRCReconfiguration* message contains the *radioBearerConfig*:

2> perform the radio bearer configuration according to 5.3.5.6;

1> if the *RRCReconfiguration* message includes the *measConfig*:

2> perform the measurement configuration procedure as specified in 5.5.2;

...

1> set the content of *RRCReconfigurationComplete* message as follows:

2> if the *RRCReconfiguration* includes the *masterCellGroup* containing the *reportUplinkTxDirectCurrent*, or;

2> if the *RRCReconfiguration* includes the *secondaryCellGroup* containing the *reportUplinkTxDirectCurrent*:

3> include the *uplinkTxDirectCurrentList*;

1> if the UE is configured with E-UTRA *nr-SecondaryCellGroupConfig* (MCG is E-UTRA):

2> if *RRCReconfiguration* was received via SRB1:

3> construct *RRCReconfigurationComplete* message and submit it via the EUTRA MCG embedded in E-UTRA RRC message *RRCConnectionReconfigurationComplete* as specified in TS 36.331 [10];

3> if *reconfigurationWithSync* was included in *spCellConfig* of an SCG:

4> initiate the random access procedure on the SpCell, as specified in TS 38.321 [3];

3> else:

4> the procedure ends;

NOTE: The order the UE sends the *RRCConnectionReconfigurationComplete* message and performs the Random Access procedure towards the SCG is left to UE implementation.

2> else (*RRCReconfiguration* was received via SRB3):

3> submit the *RRCReconfigurationComplete* message via SRB3 to lower layers for transmission using the new configuration .

NOTE: For EN-DC, in the case *RRCReconfiguration* is received via SRB1, the random access is triggered by RRC layer itself as there is not necessarily other UL transmission. In the case *RRCReconfiguration* is received via SRB3, the random access is triggered by the MAC layer due to arrival of *RRCReconfigurationComplete*.

1> else:

- 2> submit the *RRCReconfigurationComplete* message via SRB1 to lower layers for transmission using the new configuration;
- 2> if this is the first *RRCReconfiguration* message after successful completion of the RRC re-establishment procedure:
 - 3> resume SRB2 and DRBs that are suspended;
- 1> if *reconfigurationWithSync* was included in *spCellConfig* of an MCG or SCG, and when MAC of an NR cell group successfully completes a random access procedure triggered above;
 - 2> stop timer T304 for that cell group;
 - 2> apply the parts of the CQI reporting configuration, the scheduling request configuration and the sounding RS configuration that do not require the UE to know the SFN of the respective target SpCell, if any;
 - 2> apply the parts of the measurement and the radio resource configuration that require the UE to know the SFN of the respective target SpCell (e.g. measurement gaps, periodic CQI reporting, scheduling request configuration, sounding RS configuration), if any, upon acquiring the SFN of that target SpCell;
 - 2> if the *reconfigurationWithSync* was included in *spCellConfig* of an MCG:
 - 3> if T390 is running:
 - 4> stop timer T390 for all access categories;
 - 4> perform the actions as specified in 5.3.14.4.
 - 3> if *RRCReconfiguration* does not include *dedicatedSIB1-Delivery* and
 - 3> if the active downlink BWP, which is indicated by the *firstActiveDownlinkBWP-Id* for the target SpCell of the MCG, has a common search space configured by *searchSpaceSIB1*:
 - 4> acquire the *SIB1*, which is scheduled as specified in TS 38.213 [13], of the target SpCell of the MCG;
 - 4> upon acquiring *SIB1*, perform the actions specified in clause 5.2.2.4.2;
 - 2> the procedure ends.

NOTE: The UE is only required to acquire broadcasted *SIB1* if the UE can acquire it without disrupting unicast data reception, i.e. the broadcast and unicast beams are quasi co-located.

[TS 38.331, clause 5.3.5.6.1]

The UE shall perform the following actions based on a received *RadioBearerConfig* IE:

...

- 1> if the *RadioBearerConfig* includes the *drb-ToAddModList*:
 - 2> perform DRB addition or reconfiguration as specified in 5.3.5.6.5.

[TS 38.331, clause 5.3.5.6.5]

The UE shall:

- 1> for each *drb-Identity* value included in the *drb-ToAddModList* that is not part of the current UE configuration (DRB establishment including the case when full configuration option is used):
 - 2> establish a PDCP entity and configure it in accordance with the received *pdcp-Config*;
 - 2> if the PDCP entity of this DRB is not configured with *cipheringDisabled*:
 - 3> if target RAT of handover is E-UTRA/5GC, or;
 - 3> if the UE is only connected to E-UTRA/5GC:

- 4> configure the PDCP entity with the ciphering algorithm and K_{UPenc} key configured/derived as specified in TS 36.331 [10];
- 3> else:
 - 4> configure the PDCP entity with the ciphering algorithms according to *securityConfig* and apply the K_{UPenc} key associated with the master key (K_{eNB}/K_{gNB}) or the secondary key ($S-K_{gNB}$) as indicated in *keyToUse*;
- 2> if the PDCP entity of this DRB is configured with *integrityProtection*:
 - 3> configure the PDCP entity with the integrity algorithms according to *securityConfig* and apply the K_{UPint} key associated with the master (K_{eNB}/K_{gNB}) or the secondary key ($S-K_{gNB}$) as indicated in *keyToUse*;
- ...
- 2> if the UE is operating in EN-DC:
 - 3> if the DRB was configured with the same *eps-BearerIdentity* either by NR or E-UTRA prior to receiving this reconfiguration:
 - 4> associate the established DRB with the corresponding *eps-BearerIdentity*;
 - 3> else:
 - 4> indicate the establishment of the DRB(s) and the *eps-BearerIdentity* of the established DRB(s) to upper layers;
- 1> for each *drb-Identity* value included in the *drb-ToAddModList* that is part of the current UE configuration:
 - 2> if the *reestablishPDCP* is set:
 - 3> if target RAT is E-UTRA/5GC, or:
 - 3> if the UE is only connected to E-UTRA/5GC:
 - 4> if the PDCP entity of this DRB is not configured with *cipheringDisabled*:
 - 5> configure the PDCP entity with the ciphering algorithm and K_{UPenc} key configured/derived as specified in TS 36.331 [10, 5.4.2.3], i.e. the ciphering configuration shall be applied to all subsequent PDCP PDUs received and sent by the UE;
 - 3> else:
 - 4> if the PDCP entity of this DRB is not configured with *cipheringDisabled*:
 - 5> configure the PDCP entity with the ciphering algorithm and K_{UPenc} key associated with the master key (K_{eNB}/K_{gNB}) or the secondary key ($S-K_{gNB}$), as indicated in *keyToUse*, i.e. the ciphering configuration shall be applied to all subsequent PDCP PDUs received and sent by the UE;
 - 4> if the PDCP entity of this DRB is configured with *integrityProtection*:
 - 5> configure the PDCP entity with the integrity algorithms according to *securityConfig* and apply the K_{UPint} key associated with the master (K_{eNB}/K_{gNB}) or the secondary key ($S-K_{gNB}$) as indicated in *keyToUse*;
 - 3> re-establish the PDCP entity of this DRB as specified in 38.323 [5], clause 5.1.2;
 - 2> else, if the *recoverPDCP* is set:
 - 3> trigger the PDCP entity of this DRB to perform data recovery as specified in 38.323 [5];
 - 2> if the *pdcp-Config* is included:
- 3> reconfigure the PDCP entity in accordance with the received *pdcp-Config*.

...

NOTE 1: Void.

NOTE 2: When determining whether a *drb-Identity* value is part of the current UE configuration, the UE does not distinguish which *RadioBearerConfig* and *DRB-ToAddModList* that DRB was originally configured in. To re-associate a DRB with a different key (KeNB to S-KeNB or vice versa), the network provides the *drb-Identity* value in the (target) *drb-ToAddModList* and sets the *reestablishPDCP* flag. The network does not list the *drb-Identity* in the (source) *drb-ToReleaseList*.

NOTE 3: When setting the *reestablishPDCP* flag for a radio bearer, the network ensures that the RLC receiver entities do not deliver old PDCP PDUs to the re-established PDCP entity. It does that e.g. by triggering a reconfiguration with sync of the cell group hosting the old RLC entity or by releasing the old RLC entity.

NOTE 4: In this specification, UE configuration refers to the parameters configured by NR RRC unless otherwise stated.

NOTE 5: Ciphering and integrity protection can be enabled or disabled for a DRB. The enabling/disabling of ciphering or integrity protection can be changed only by releasing and adding the DRB.

[TS 37.340, Annex A]

This clause provides for information an overview on L2 handling for bearer type change in MR-DC, with and without a security key change due to a change of the termination point.

Table A-1: L2 handling for bearer type change with and without a security key change due to a change of the termination point

Bearer type change from row to col	MCG		Split		SCG	
	no change of termination point (no key change)	change of termination point (key change)	no change of termination point (no key change)	change of termination point (key change)	no change of termination point (no key change)	change of termination point (key change)

MCG	N/A	PDCP: Re-establish MCG RLC: See Note 1 MCG MAC: See Note 1 SCG RLC: No action SCG MAC: No action	PDCP: Reconfigure MCG RLC: No action MCG MAC: No action SCG RLC: Establish SCG MAC: Reconfigure	PDCP: Re-establish MCG RLC: See Note 1 MCG MAC: See Note 1 SCG RLC: Establish SCG MAC: Reconfigure	PDCP: Recovery MCG RLC: See Note 3 MCG MAC: Reconfigure SCG RLC: Establish SCG MAC: Reconfigure	PDCP: Re-establish MCG RLC: See Note 3 MCG MAC: Reconfigure SCG RLC: Establish SCG MAC: Reconfigure
Split	PDCP: Recovery MCG RLC: No action MCG MAC: No action SCG RLC: See Note 4 SCG MAC: Reconfigure	PDCP: Re-establish MCG RLC: See Note 1 MCG MAC: See Note 1 SCG RLC: See Note 4 SCG MAC: Reconfigure	N/A	PDCP: Re-establish MCG RLC: See Note 1 MCG MAC: See Note 1 SCG RLC: See Note 1 SCG MAC: See Note 1	PDCP: Recovery MCG RLC: See Note 3 MCG MAC: Reconfigure SCG RLC: No action SCG MAC: No action	PDCP: Re-establish MCG RLC: See Note 3 MCG MAC: Reconfigure SCG RLC: See Note 1 SCG MAC: See Note 1
SCG	PDCP: Recovery MCG RLC: Establish MCG MAC: Reconfigure SCG RLC: See Note 4 SCG MAC: Reconfigure	PDCP: Re-establish MCG RLC: Establish MCG MAC: Reconfigure SCG RLC: See Note 4 SCG MAC: Reconfigure	PDCP: Reconfigure MCG RLC: Establish MCG MAC: Reconfigure SCG RLC: No action SCG MAC: No action	PDCP: Re-establish MCG RLC: Establish MCG MAC: Reconfigure SCG RLC: See Note 1 SCG MAC: See Note 1	N/A	PDCP: Re-establish MCG RLC: No action MCG MAC: No action SCG RLC: See Note 1 SCG MAC: See Note 1

NOTE 1: For EN-DC and NGEN-DC MCG, NE-DC SCG: the MAC/RLC behaviour depends on the solution selected by the network. It can be PCell handover (for EN-DC and NGEN-DC) or PSCell change (for NE-DC), which triggers MAC reset and RLC re-establishment. Alternatively, the logical channel identity can be changed, either via RLC bearer release and add for the same DRB (including RLC re-establishment), or via reconfiguration of the RLC bearer with RLC-re-establishment.

For EN-DC and NGEN-DC SCG, NE-DC MCG, NR-DC MCG and SCG: the MAC/RLC behaviour depends on the solution selected by the network. It can be reconfiguration with sync, with MAC reset and RLC re-establishment. Alternatively, the logical channel identity can be changed via RLC bearer release and add.

NOTE 2: Void

NOTE 3: For EN-DC and NGEN-DC: Re-establishment and release. For NE-DC and NR-DC: Release.

NOTE 4: For NE-DC: Re-establishment and release. For EN-DC, NGEN-DC and NR-DC: Release.

8.2.2.8.2.3 Test description

8.2.2.8.2.3.1 Pre-test conditions

System Simulator:

- NR Cell 1 is the PCell and NR Cell 10 is the PSCell.

UE:

- None.

Preamble:

- If `pc_IP_Ping` is set to TRUE then, the UE is in state NR RRC_CONNECTED using generic procedure parameter Connectivity (*NR-DC*), Bearers (*MCG(s) and SCG*) established according to TS 38.508-1 [4], clause 4.5.4.
- Else, the UE is in state NR RRC_CONNECTED using generic procedure parameter Connectivity (*NR-DC*), Bearers (*MCG(s) and SCG*) established and Test Loop Function (On) with UE test loop mode B according to TS 38.508-1 [4], clause 4.5.4.

8.2.2.8.2.3.2 Test procedure sequence

Table 8.2.2.8.2.3.2-1: Main behaviour

St	Procedure	Message Sequence		TP	Verdict
		U - S	Message		
1	The SS transmits an <i>RRCReconfiguration</i> message containing NR RadioBearerConfig message to modify SN terminated SCG DRB with security key s-KgNB to MN terminated SCG DRB with security key change to KgNB.	<--	<i>RRCReconfiguration</i>	-	-
2	Check: Does the UE transmit an <i>RRCReconfigurationComplete</i> message including nr-SCG-Response?	-->	<i>RRCReconfigurationComplete</i>	1	P
3	Check: Does the test result of generic test procedure in TS 38.508-1 subclause 4.9.1 indicate that the UE is capable of exchanging IP data on SCG DRBn?	-	-	1	P
4	The SS transmits an <i>RRCReconfiguration</i> message containing NR RadioBearerConfig message to modify MN terminated SCG DRB with security key KgNB to SN terminated Split DRB with security key change to s-KgNB.	<--	<i>RRCReconfiguration</i>	-	-
5	Check: Does the UE transmit an <i>RRCReconfigurationComplete</i> message including nr-SCG-Response?	-->	<i>RRCReconfigurationComplete</i>	2	P
6	Check: Does the test result of generic test procedure in TS 38.508-1 subclause 4.9.1 indicate that the UE is capable of exchanging IP data on Split DRBn using NR radio path?	-	-	2	P
7	The SS transmits an <i>RRCReconfiguration</i> message containing NR RadioBearerConfig message to modify SN terminated Split DRB with security key s-KgNB to MN terminated Split DRB with security key change to KgNB.	<--	<i>RRCReconfiguration</i>	-	-
8	Check: Does the UE transmit an <i>RRCReconfigurationComplete</i> message including nr-SCG-Response?	-->	<i>RRCReconfigurationComplete</i>	3	P
9	Check: Does the test result of generic test procedure in TS 38.508-1 subclause 4.9.1 indicate that the UE is capable of exchanging IP data on Split DRBn using NR radio path?	-	-	3	P
10	The SS transmits an <i>RRCReconfiguration</i> message containing NR RadioBearerConfig and nr-Config set to release to modify MN terminated Split DRB with security key KgNB to SN terminated MCG DRB with security key change to s-KgNB.	<--	<i>RRCReconfiguration</i>	-	-
11	Check: Does the UE transmit an <i>RRCReconfigurationComplete</i> message?	-->	<i>RRCReconfigurationComplete</i>	4	P
12	Check: Does the test result of generic test procedure in TS 38.508-1 subclause 4.9.1 indicate that the UE is capable of exchanging IP data on MCG DRBn?	-	-	4	P
13	The SS transmits an <i>RRCReconfiguration</i> message containing NR RadioBearerConfig to modify SN terminated MCG DRB with security key s-KgNB to MN terminated MCG DRB with security key change to KgNB.	<--	<i>RRCReconfiguration</i>	-	-
14	Check: Does the UE transmit an <i>RRCReconfigurationComplete</i> message including nr-SCG-Response?	-->	<i>RRCReconfigurationComplete</i>	5	P
15	Check: Does the test result of generic test procedure in TS 38.508-1 subclause 4.9.1 indicate that the UE is capable of exchanging IP data on MCG DRBn?	-	-	5	P

16	The SS transmits an <i>RRCReconfiguration</i> message containing NR RadioBearerConfig message to modify MN terminated MCG DRB with security key KgNB to SN terminated Split DRB with security key change to s-KgNB.	<--	<i>RRCReconfiguration</i>	-	-
17	Check: Does the UE transmit an <i>RRCReconfigurationComplete</i> message including nr-SCG-Response?	-->	<i>RRCReconfigurationComplete</i>	6	P
18	Check: Does the test result of generic test procedure in TS 38.508-1 subclause 4.9.1 indicate that the UE is capable of exchanging IP data on Split DRBn using NR radio path?	-	-	6	P
19	The SS transmits an <i>RRCReconfiguration</i> message containing NR RadioBearerConfig message to modify SN terminated Split DRB with security key s-KgNB to MN terminated SCG DRB with security key change to KgNB.	<--	<i>RRCReconfiguration</i>	-	-
20	Check: Does the UE transmit an <i>RRCReconfigurationComplete</i> message including nr-SCG-Response?	-->	<i>RRCReconfigurationComplete</i>	7	P
21	Check: Does the test result of generic test procedure in TS 38.508-1 subclause 4.9.1 indicate that the UE is capable of exchanging IP data on SCG DRBn?	-	-	7	P
22	The SS transmits an <i>RRCReconfiguration</i> message containing NR RadioBearerConfig message to modify MN terminated SCG DRB with security key KgNB to SN terminated MCG DRB with security key change to s-KgNB.	<--	<i>RRCReconfiguration</i>	-	-
23	Check: Does the UE transmit an <i>RRCReconfigurationComplete</i> message including nr-SCG-Response?	-->	<i>RRCReconfigurationComplete</i>	8	P
24	Check: Does the test result of generic test procedure in TS 38.508-1 subclause 4.9.1 indicate that the UE is capable of exchanging IP data on MCG DRBn?	-	-	8	P
25	The SS transmits an <i>RRCReconfiguration</i> message containing NR RadioBearerConfig message to modify SN terminated MCG DRB with security key s-KgNB to MN terminated SCG DRB with security key change to KgNB.	<--	<i>RRCReconfiguration</i>	-	-
26	Check: Does the UE transmit an <i>RRCReconfigurationComplete</i> message including nr-SCG-Response?	-->	<i>RRCReconfigurationComplete</i>	9	P
27	Check: Does the test result of generic test procedure in TS 38.508-1 subclause 4.9.1 indicate that the UE is capable of exchanging IP data on SCG DRBn?	-	-	9	P

8.2.2.8.2.3.3 Specific message contents

Table 8.2.2.8.2.3.3-1: RRCReconfiguration (step 1, Table 8.2.2.8.2.3.2-1)

Derivation Path: 38.508-1 [4], Table 4.6.1-13			
Information Element	Value/remark	Comment	Condition
RRCReconfiguration ::= SEQUENCE {			
criticalExtensions CHOICE {			
rrcReconfiguration SEQUENCE {			
nonCriticalExtension SEQUENCE {			
nonCriticalExtension SEQUENCE {			
nonCriticalExtension SEQUENCE {			
mrdc-SecondaryCellGroupConfig CHOICE {			
setup SEQUENCE {			
mrdc-SecondaryCellGroup CHOICE {			
nr-SCG	OCTET STRING (CONTAINING RRCReconfiguration- SCG)		
}			
}			
}			
radioBearerConfig2	RadioBearerConfig-SCG	See Table 8.2.2.8.2.3.3-1A	
}			
}			
}			
}			
}			
}			

Table 8.2.2.8.2.3.3-1A: RadioBearerConfig-SCG (Table 8.2.2.8.2.3.3-1, Table 8.2.2.8.2.3.3-8, Table 8.2.2.8.2.3.3-21, Table 8.2.2.8.2.3.3-28)

Derivation Path: TS 38.508-1 [4], Table 4.6.3-132 with condition DRB1 and Re-establish_PDCP			
Information Element	Value/remark	Comment	Condition
RadioBearerConfig ::= SEQUENCE {			
drb-ToAddModList SEQUENCE (SIZE (1..maxDRB))	1 entry		
OF {			
DRB-ToAddMod[1] SEQUENCE {		entry 1	
drb-Identity	DRB-Identity using condition DRBn	DRBn is allocated for SCG according to internal TTCN mapping	
pdcp-Config	PDCP-Config with Condition Split		
}			
}			
}			

Table 8.2.2.8.2.3.3-2: RRCReconfiguration-SCG (Table 8.2.2.8.2.3.3-1)

Derivation Path: 38.508-1 [4], Table 4.6.1-13			
Information Element	Value/remark	Comment	Condition
RRCReconfiguration ::= SEQUENCE {			
secondaryCellGroup	CellGroupConfig		
}			

Table 8.2.2.8.2.3.3-3: CellGroupConfig (Table 8.2.2.8.2.3.3-2)

Derivation Path: TS 38.508-1, table 4.6.1-3 with condition PSCell_Change			
Information Element	Value/remark	Comment	Condition
CellGroupConfig ::= SEQUENCE {			
rlc-BearerToAddModList SEQUENCE (SIZE(1..maxLC-ID)) OF RLC-BearerConfig {	1 entry		DRBn
RLC-BearerConfig[1]	RLC-BearerConfig as per TS 38.508-1[4] Table 4.6.3-148: <i>RLC- BearerConfig</i> with conditions AM and DRBn and Re-establish_RLC	DRBn is allocated for SCG according to internal TTCN mapping	
}			
}			

Table 8.2.2.8.2.3.3-4: RRCReconfiguration (step 4, Table 8.2.2.8.2.3.2-1)

Derivation Path: 38.508-1 [4], Table 4.6.1-13			
Information Element	Value/remark	Comment	Condition
RRCReconfiguration ::= SEQUENCE {			
criticalExtensions CHOICE {			
rrcReconfiguration SEQUENCE {			
nonCriticalExtension SEQUENCE {			
masterCellGroup	CellGroupConfig	OCTET STRING (CONTAINING CellGroupConfig)	
nonCriticalExtension SEQUENCE {			
nonCriticalExtension SEQUENCE {			
mrdc-SecondaryCellGroupConfig CHOICE {			
setup SEQUENCE {			
mrdc-SecondaryCellGroup CHOICE {			
nr-SCG	OCTET STRING (CONTAINING RRCReconfiguration- SCG)		
}			
}			
}			
}			
radioBearerConfig2	RadioBearerConfig-SCG	See Table 8.2.2.8.2.3.3-4A	
}			
}			

Table 8.2.2.8.2.3.3-4A: RadioBearerConfig-SCG (Table 8.2.2.8.2.3.3-4, Table 8.2.2.8.2.3.3-17)

Derivation Path: TS 38.508-1 [4], Table 4.6.3-132 with condition DRB1 and Re-establish_PDCP			
Information Element	Value/remark	Comment	Condition
RadioBearerConfig ::= SEQUENCE {			
drb-ToAddModList SEQUENCE (SIZE (1..maxDRB)) OF {	1 entry		
DRB-ToAddMod[1] SEQUENCE {		entry 1	
drb-Identity	DRB-Identity using condition DRBn	DRBn is allocated for SCG according to internal TTCN mapping	
pdcp-Config	PDCP-Config with Condition Split		
}			
}			
securityConfig SEQUENCE {			
keyToUse	secondary		
}			
}			

Table 8.2.2.8.2.3.3-5: CellGroupConfig (Table 8.2.2.8.2.3.3-4)

Derivation Path: TS 38.508-1, table 4.6.3-19			
Information Element	Value/remark	Comment	Condition
CellGroupConfig ::= SEQUENCE {			
rlc-BearerToAddModList SEQUENCE (SIZE(1..maxLC-ID)) OF RLC-BearerConfig {	1 entry		DRBn
RLC-BearerConfig[1]	RLC-BearerConfig as per TS 38.508-1[4] Table 4.6.3-148: <i>RLC-BearerConfig</i> with conditions DRBn and Re-establish_RLC	DRBn is allocated for SCG according to internal TTCN mapping	
}			
}			

Table 8.2.2.8.2.3.3-6: RRCReconfiguration-SCG (Table 8.2.2.8.2.3.3-4)

Derivation Path: 38.508-1 [4], Table 4.6.1-13			
Information Element	Value/remark	Comment	Condition
RRCReconfiguration ::= SEQUENCE {			
secondaryCellGroup	CellGroupConfig		
}			

Table 8.2.2.8.2.3.3-7: CellGroupConfig (Table 8.2.2.8.2.3.3-6)

Derivation Path: TS 38.508-1, table 4.6.1-3 with condition PSCell_Change			
Information Element	Value/remark	Comment	Condition
CellGroupConfig ::= SEQUENCE {			
rlc-BearerToAddModList SEQUENCE (SIZE(1..maxLC-ID)) OF RLC-BearerConfig {	1 entry		DRBn
RLC-BearerConfig[1]	RLC-BearerConfig as per TS 38.508-1[4] Table 4.6.3-148: <i>RLC-BearerConfig</i> with conditions AM and DRBm and Re-establish_RLC	entry 1 DRBn is allocated according to internal TTCN mapping	
}			
}			

Table 8.2.2.8.2.3.3-8: *RRCReconfiguration* (step 7, Table 8.2.2.8.2.3.2-1)

Derivation Path: 38.508-1 [4], Table 4.6.1-13			
Information Element	Value/remark	Comment	Condition
RRCReconfiguration ::= SEQUENCE {			
criticalExtensions CHOICE {			
rrcReconfiguration SEQUENCE {			
radioBearerConfig	RadioBearerConfig according to TS 38.508-1[4] Table 4.6.3-132: <i>RadioBearerConfig</i> with conditions SRB1, SRB2, DRBm, and Re-establish_PDCP	DRBm is DRB(s) on MCG are allocated according to internal TTCN mapping	
nonCriticalExtension SEQUENCE {			
masterCellGroup	CellGroupConfig	OCTET STRING (CONTAINING CellGroupConfig)	
nonCriticalExtension SEQUENCE {			
nonCriticalExtension SEQUENCE {			
mrdc-SecondaryCellGroupConfig CHOICE {			
setup SEQUENCE {			
mrdc-SecondaryCellGroup CHOICE {			
nr-SCG	OCTET STRING (CONTAINING RRCReconfiguration-SCG)		
}			
}			
}			
radioBearerConfig2	RadioBearerConfig-SCG	See Table 8.2.2.8.2.3.3-1A	
}			
}			
}			
}			
}			
}			

Table 8.2.2.8.2.3.3-9: CellGroupConfig (Table 8.2.2.8.2.3.3-8)

Derivation Path: TS 38.508-1, table 4.6.3-19 with condition PCell_Change			
Information Element	Value/remark	Comment	Condition
CellGroupConfig ::= SEQUENCE {			
rlc-BearerToAddModList SEQUENCE (SIZE(1..maxLC-ID)) OF RLC-BearerConfig {			
RLC-BearerConfig[1]	RLC-BearerConfig as per TS 38.508-1[4] Table 4.6.3-148: <i>RLC-BearerConfig</i> with conditions SRB1, SRB2, DRBm, DRBn and Re-establish_RLC	DRBm is DRB(s) on MCG and DRBn is DRB on SCG are allocated according to internal TTCN mapping.	
}			
}			

Table 8.2.2.8.2.3.3-10: RRCReconfiguration-SCG (Table 8.2.2.8.2.3.3-8)

Derivation Path: 38.508-1 [4], Table 4.6.1-13			
Information Element	Value/remark	Comment	Condition
RRCReconfiguration ::= SEQUENCE {			
secondaryCellGroup	CellGroupConfig		
}			

Table 8.2.2.8.2.3.3-11: CellGroupConfig (Table 8.2.2.8.2.3.3-10)

Derivation Path: TS 38.508-1, table 4.6.1-3 with condition NR-DC_SCG			
Information Element	Value/remark	Comment	Condition
CellGroupConfig ::= SEQUENCE {			
rlc-BearerToAddModList SEQUENCE (SIZE(1..maxLC-ID)) OF RLC-BearerConfig {	1 entry		DRBn
RLC-BearerConfig[1]	RLC-BearerConfig as per TS 38.508-1[4] Table 4.6.3-148: <i>RLC- BearerConfig</i> with conditions AM and DRBn and Re-establish_RLC	entry 1 DRBn is allocated according to internal TTCN mapping	
}			
}			

Table 8.2.2.8.2.3.3-12: RRCReconfiguration (step 10, Table 8.2.2.8.2.3.2-1)

Derivation Path: 38.508-1 [4], Table 4.6.1-13			
Information Element	Value/remark	Comment	Condition
RRCReconfiguration ::= SEQUENCE {			
criticalExtensions CHOICE {			
rrcReconfiguration SEQUENCE {			
nonCriticalExtension SEQUENCE {			
masterCellGroup	CellGroupConfig	OCTET STRING (CONTAINING CellGroupConfig)	
nonCriticalExtension SEQUENCE {			
nonCriticalExtension SEQUENCE {			
mrdc-SecondaryCellGroupConfig CHOICE {			
release			
}			
radioBearerConfig2	RadioBearerConfig		
}			
}			
}			
}			
}			
}			

Table 8.2.2.8.2.3.3-13: CellGroupConfig (Table 8.2.2.8.2.3.3-12)

Derivation Path: TS 38.508-1, table 4.6.3-19 with condition PCell_Change			
Information Element	Value/remark	Comment	Condition
CellGroupConfig ::= SEQUENCE {			
rlc-BearerToAddModList SEQUENCE (SIZE(1..maxLC-ID)) OF RLC-BearerConfig {	1 entry		DRBn
RLC-BearerConfig[1]	RLC-BearerConfig as per TS 38.508-1[4] Table 4.6.3-148: <i>RLC- BearerConfig</i> with conditions SRB1, SRB2, DRBn, DRBm and Re- establish_RLC	DRBn and DRBm are allocated according to internal TTCN mapping	
}			
}			

Table 8.2.2.8.2.3.3-14: RadioBearerConfig (Table 8.2.2.8.2.3.3-12)

Derivation Path: 38.508-1 [4], Table 4.6.1-13			
Information Element	Value/remark	Comment	Condition
RadioBearerConfig ::= SEQUENCE {			
drb-ToAddModList SEQUENCE (SIZE (1..maxRB)) OF DRB-ToAddMod {	1 entry		
DRB-ToAddMod[1] SEQUENCE {			
cnAssociation CHOICE {			
sdap-Config	SDAP-Config		
}			
drb-Identity	DRB-Identity using condition DRBm		
reestablishPDCP	True		
recoverPDCP	Not present		
pdcpc-Config	PDCP-Config with Condition Split		
}			
securityConfig SEQUENCE {			
keyToUse	Secondary		
}			
}			

Table 8.2.2.8.2.3.3-15: RRCReconfiguration (step 13, Table 8.2.2.8.2.3.2-1)

Derivation Path: 38.508-1 [4], Table 4.6.1-13			
Information Element	Value/remark	Comment	Condition
RRCReconfiguration ::= SEQUENCE {			
criticalExtensions CHOICE {			
rrcReconfiguration SEQUENCE {			
radioBearerConfig	RadioBearerConfig according to TS 38.508-1[4] Table 4.6.3-132: <i>RadioBearerConfig</i> with conditions SRB1, SRB2, DRBn, DRBm, Re-establish_PDCP	DRBn and DRBm is allocated according to internal TTCN mapping	
nonCriticalExtension SEQUENCE {			
masterCellGroup	CellGroupConfig	OCTET STRING (CONTAINING CellGroupConfig)	
}			
}			
}			
}			

Table 8.2.2.8.2.3.3-16: CellGroupConfig (Table 8.2.2.8.2.3.3-15)

Derivation Path: TS 38.508-1, table 4.6.3-19 with condition PCell_Change			
Information Element	Value/remark	Comment	Condition
CellGroupConfig ::= SEQUENCE {			
rlc-BearerToAddModList SEQUENCE (SIZE(1..maxLC-ID)) OF RLC-BearerConfig {	1 entry		DRBn
RLC-BearerConfig[1]	RLC-BearerConfig as per TS 38.508-1[4] Table 4.6.3-148: <i>RLC-BearerConfig</i> with conditions SRB1, SRB2, DRBn, DRBm and Re-establish_RLC	DRBn on MCG and DRBm on SCG are allocated according to internal TTCN mapping	
}			

Table 8.2.2.8.2.3.3-17: *RRCReconfiguration* (step 16, Table 8.2.2.8.2.3.2-1)

Derivation Path: 38.508-1 [4], Table 4.6.1-13			
Information Element	Value/remark	Comment	Condition
RRCReconfiguration ::= SEQUENCE {			
criticalExtensions CHOICE {			
rrcReconfiguration SEQUENCE {			
radioBearerConfig	RadioBearerConfig according to TS 38.508-1[4] Table 4.6.3-132: <i>RadioBearerConfig</i> with conditions SRB1, SRB2, DRBm, Re-establish_PDCP	DRBm on MCG is allocated according to internal TTCN mapping	
nonCriticalExtension SEQUENCE {			
masterCellGroup	CellGroupConfig	OCTET STRING (CONTAINING CellGroupConfig)	
nonCriticalExtension SEQUENCE {			
nonCriticalExtension SEQUENCE {			
mrdc-SecondaryCellGroupConfig CHOICE {			
setup SEQUENCE {			
mrdc-SecondaryCellGroup CHOICE {			
nr-SCG	OCTET STRING (CONTAINING RRCReconfiguration-SCG)		
}			
}			
}			
radioBearerConfig2	RadioBearerConfig-SCG	See Table 8.2.2.8.2.3.3-4A	
}			
}			
}			
}			
}			
}			

Table 8.2.2.8.2.3.3-18: CellGroupConfig (Table 8.2.2.8.2.3.3-17)

Derivation Path: TS 38.508-1, table 4.6.3-19 with condition PCell_Change			
Information Element	Value/remark	Comment	Condition
CellGroupConfig ::= SEQUENCE {			
rlc-BearerToAddModList SEQUENCE (SIZE(1..maxLC-ID)) OF RLC-BearerConfig {			
RLC-BearerConfig[1]	RLC-BearerConfig as per TS 38.508-1[4] Table 4.6.3-148: <i>RLC-BearerConfig</i> with conditions SRB1, SRB2, DRBn, DRBm and Re-establish_RLC	DRBn on MCG and DRBm on SCG are allocated according to internal TTCN mapping	
}			
}			

Table 8.2.2.8.2.3.3-19: RRCReconfiguration-SCG (Table 8.2.2.8.2.3.3-17)

Derivation Path: 38.508-1 [4], Table 4.6.1-13			
Information Element	Value/remark	Comment	Condition
RRCReconfiguration ::= SEQUENCE {			
secondaryCellGroup	CellGroupConfig		
}			

Table 8.2.2.8.2.3.3-23: RRCReconfiguration-SCG (Table 8.2.2.8.2.3.3-21)

Derivation Path: 38.508-1 [4], Table 4.6.1-13			
Information Element	Value/remark	Comment	Condition
RRCReconfiguration ::= SEQUENCE {			
secondaryCellGroup	CellGroupConfig		

Table 8.2.2.8.2.3.3-24: CellGroupConfig (Table 8.2.2.8.2.3.3-23)

Derivation Path: TS 38.508-1, table 4.6.1-3 with condition PSCell_Change			
Information Element	Value/remark	Comment	Condition
CellGroupConfig ::= SEQUENCE {			
rlc-BearerToAddModList SEQUENCE (SIZE(1..maxLC-ID)) OF RLC-BearerConfig {	1 entry		DRBn
RLC-BearerConfig[1]	RLC-BearerConfig as per TS 38.508-1[4] Table 4.6.3-148: <i>RLC-BearerConfig</i> with conditions AM and DRBn and Re-establish_RLC	entry 1 DRBn is allocated according to internal TTCN mapping	
}			
}			

Table 8.2.2.8.2.3.3-25: RRCReconfiguration (step 22, Table 8.2.2.8.2.3.2-1)

Derivation Path: 38.508-1 [4], Table 4.6.1-13			
Information Element	Value/remark	Comment	Condition
RRCReconfiguration ::= SEQUENCE {			
criticalExtensions CHOICE {			
rrcReconfiguration SEQUENCE {			
nonCriticalExtension SEQUENCE {			
masterCellGroup	CellGroupConfig	OCTET STRING (CONTAINING CellGroupConfig)	
nonCriticalExtension SEQUENCE {			
nonCriticalExtension SEQUENCE {			
mrdc-SecondaryCellGroupConfig CHOICE {			
Release			
}			
radioBearerConfig2	RadioBearerConfig		
}			
}			
}			
}			

Table 8.2.2.8.2.3.3-26: CellGroupConfig (Table 8.2.2.8.2.3.3-25)

Derivation Path: TS 38.508-1, table 4.6.3-19			
Information Element	Value/remark	Comment	Condition
CellGroupConfig ::= SEQUENCE {			
rlc-BearerToAddModList SEQUENCE (SIZE(1..maxLC-ID)) OF RLC-BearerConfig {	1 entry		DRBn
RLC-BearerConfig[1]	RLC-BearerConfig as per TS 38.508-1[4] Table 4.6.3-148: <i>RLC-BearerConfig</i> with conditions DRBn and Re-establish_RLC	DRBn of SCG are allocated according to internal TTCN mapping	
}			
}			

Table 8.2.2.8.2.3.3-27: RadioBearerConfig (Table 8.2.2.8.2.3.3-26)

Derivation Path: 38.508-1 [4], Table 4.6.1-13			
Information Element	Value/remark	Comment	Condition
RadioBearerConfig ::= SEQUENCE {			
drb-ToAddModList SEQUENCE (SIZE(1..maxRB)) OF DRB-ToAddMod {	1 entry		
DRB-ToAddMod[1] SEQUENCE {			
cnAssociation CHOICE {			
sdap-Config	SDAP-Config		
}			
drb-Identity	DRB-Identity using condition DRBn	DRBn of SCG are allocated according to internal TTCN mapping	
reestablishPDCP	True		
recoverPDCP	Not present		
pdcpc-Config	PDCP-Config with Condition Split		
}			
securityConfig SEQUENCE {			
keyToUse	Secondary		
}			
}			

Table 8.2.2.8.2.3.3-28: RRCReconfiguration (step 25, Table 8.2.2.8.2.3.2-1)

Derivation Path: 38.508-1 [4], Table 4.6.1-13			
Information Element	Value/remark	Comment	Condition
RRCReconfiguration ::= SEQUENCE {			
criticalExtensions CHOICE {			
rrcReconfiguration SEQUENCE {			
nonCriticalExtension SEQUENCE {			
masterCellGroup	CellGroupConfig	OCTET STRING (CONTAINING CellGroupConfig)	
nonCriticalExtension SEQUENCE {			
nonCriticalExtension SEQUENCE {			
mrdc-SecondaryCellGroupConfig CHOICE {			
setup SEQUENCE {			
mrdc-SecondaryCellGroup CHOICE {			
nr-SCG	OCTET STRING (CONTAINING RRCReconfiguration- SCG)		
}			
}			
}			
radioBearerConfig2	RadioBearerConfig-SCG	See Table 8.2.2.8.2.3.3-1A	
}			
}			
}			
}			
}			
}			

Table 8.2.2.8.2.3.3-29: CellGroupConfig (Table 8.2.2.8.2.3.3-28)

Derivation Path: TS 38.508-1, table 4.6.1-3 with condition PSCell_Change			
Information Element	Value/remark	Comment	Condition
CellGroupConfig ::= SEQUENCE {			
rlc-BearerToReleaseList SEQUENCE (SIZE(1..maxLC-ID)) OF LogicalChannelIdentity {			
LogicalChannelIdentity[1]	Logical ChannelID of DRBn		
}			
}			

Table 8.2.2.8.2.3.3-30: RRCReconfiguration-SCG (Table 8.2.2.8.2.3.3-28)

Derivation Path: 38.508-1 [4], Table 4.6.1-13			
Information Element	Value/remark	Comment	Condition
RRCReconfiguration ::= SEQUENCE {			
secondaryCellGroup	CellGroupConfig		

Table 8.2.2.8.2.3.3-31: CellGroupConfig (Table 8.2.2.8.2.3.3-30)

Derivation Path: TS 38.508-1, table 4.6.1-3 with condition PSCell_Change			
Information Element	Value/remark	Comment	Condition
CellGroupConfig ::= SEQUENCE {			
ric-BearerToAddModList SEQUENCE (SIZE(1..maxLC-ID)) OF RLC-BearerConfig {	1 entry		DRBn
RLC-BearerConfig[1]	RLC-BearerConfig as per TS 38.508-1[4] Table 4.6.3-148: <i>RLC- BearerConfig</i> with conditions AM and DRBn and Re-establish_RLC	entry 1 DRBn is allocated according to internal TTCN mapping	
}			
}			

8.2.2.9 Bearer Modification / Uplink data path / Split DRB Reconfiguration

8.2.2.9.1 Bearer Modification / Uplink data path / Split DRB Reconfiguration / EN-DC

8.2.2.9.1.1 Test Purpose (TP)

(1)

```
with { UE in RRC_CONNECTED state with EN-DC, and, MCG(s) (E-UTRA PDCP) and Split }
ensure that {
  when { UE receives an RRCConnectionReconfiguration message to change the primaryPath to E-UTRA
radio path from NR }
  then { UE changes the uplink data path to E-UTRA radio path and sends an
RRCConnectionReconfigurationComplete message }
}
```

(2)

```
with { UE in RRC_CONNECTED state with EN-DC, and, MCG(s) (E-UTRA PDCP) and Split }
ensure that {
  when { UE receives an RRCConnectionReconfiguration message to change the primaryPath from E-UTRA
radio path to NR }
  then { UE changes the uplink data path to NR radio path and sends an
RRCConnectionReconfigurationComplete message }
}
```

8.2.2.9.1.2 Conformance requirements

References: The conformance requirements covered in the present test case are specified in: TS 36.331, clause 5.3.5.3, TS 38.331, clauses 5.3.5.3 and 5.3.5.6.5. Unless otherwise stated these are Rel-15 requirements.

[TS 36.331, clause 5.3.5.3]

If the *RRCConnectionReconfiguration* message does not include the *mobilityControlInfo* and the UE is able to comply with the configuration included in this message, the UE shall:

...

- 1> if the received *RRCConnectionReconfiguration* includes the *nr-Config* and it is set to *release*: or
- 1> if the received *RRCConnectionReconfiguration* includes *endc-ReleaseAndAdd* and it is set to *TRUE*:
 - 2> perform ENDC release as specified in TS38.331 [82], clause 5.3.5.10;
- 1> if the received *RRCConnectionReconfiguration* includes the *sk-Counter*:
 - 2> perform key update procedure as specified in TS 38.331 [82], clause 5.3.5.7;
- 1> if the received *RRCConnectionReconfiguration* includes the *nr-SecondaryCellGroupConfig*:

- 2> perform NR RRC Reconfiguration as specified in TS 38.331 [82], clause 5.3.5.3;
- 1> if the received *RRCCONNECTIONRECONFIGURATION* includes the *nr-RadioBearerConfig1*:
 - 2> perform radio bearer configuration as specified in TS 38.331 [82], clause 5.3.5.6;
- 1> if the received *RRCCONNECTIONRECONFIGURATION* includes the *nr-RadioBearerConfig2*:
 - 2> perform radio bearer configuration as specified in TS 38.331 [82], clause 5.3.5.6;
- ...
- 1> set the content of *RRCCONNECTIONRECONFIGURATIONCOMPLETE* message as follows:
 - 2> if the *RRCCONNECTIONRECONFIGURATION* message includes *perCC-GapIndicationRequest*:
 - 3> include *perCC-GapIndicationList* and *numFreqEffective*;
 - 2> if the frequencies are configured for reduced measurement performance:
 - 3> include *numFreqEffectiveReduced*;
 - 2> if the received *RRCCONNECTIONRECONFIGURATION* message included *nr-SecondaryCellGroupConfig*:
 - 3> include *scg-ConfigResponseNR* in accordance with TS 38.331 [82], clause 5.3.5.3;
- 1> submit the *RRCCONNECTIONRECONFIGURATIONCOMPLETE* message to lower layers for transmission using the new configuration, upon which the procedure ends;

[TS 38.331, clause 5.3.5.3]

The UE shall perform the following actions upon reception of the *RRCRECONFIGURATION*:

- ...
- 1> if the *RRCRECONFIGURATION* includes the *secondaryCellGroup*:
 - 2> perform the cell group configuration for the SCG according to 5.3.5.5;
- 1> if the *RRCRECONFIGURATION* message contains the *radioBearerConfig*:
 - 2> perform the radio bearer configuration according to 5.3.5.6;
- 1> if the *RRCRECONFIGURATION* message includes the *measConfig*:
 - 2> perform the measurement configuration procedure as specified in 5.5.2
- ...
- 1> set the content of *RRCRECONFIGURATIONCOMPLETE* message as follows:
 - 2> if the *RRCRECONFIGURATION* includes the *masterCellGroup* containing the *reportUplinkTxDirectCurrent*, or;
 - 2> if the *RRCRECONFIGURATION* includes the *secondaryCellGroup* containing the *reportUplinkTxDirectCurrent*:
 - 3> include the *uplinkTxDirectCurrentList*;;
- 1> if the UE is configured with E-UTRA *nr-SecondaryCellGroupConfig* (MCG is E-UTRA):
 - 2> if *RRCRECONFIGURATION* was received via SRB1:
 - 3> construct *RRCRECONFIGURATIONCOMPLETE* message and submit it via the EUTRA MCG embedded in E-UTRA RRC message *RRCCONNECTIONRECONFIGURATIONCOMPLETE* as specified in TS 36.331 [10];
 - 3> if *reconfigurationWithSync* was included in *spCellConfig* of an SCG:
 - 4> initiate the random access procedure on the SpCell, as specified in TS 38.321 [3];
 - 3> else:

4> the procedure ends;

NOTE: The order the UE sends the *RRCConnectionReconfigurationComplete* message and performs the Random Access procedure towards the SCG is left to UE implementation.

2> else (*RRCReconfiguration* was received via SRB3):

3> submit the *RRCReconfigurationComplete* message via SRB3 to lower layers for transmission using the new configuration.

NOTE: For EN-DC, in the case *RRCReconfiguration* is received via SRB1, the random access is triggered by RRC layer itself as there is not necessarily other UL transmission. In the case *RRCReconfiguration* is received via SRB3, the random access is triggered by the MAC layer due to arrival of *RRCReconfigurationComplete*.

1 > else:

2> submit the *RRCReconfigurationComplete* message via SRB1 to lower layers for transmission using the newconfiguration;

2> if this is the first *RRCReconfiguration* message after successful completion of the RRC re-establishment procedure:

3> resume SRB2 and DRBs that are suspended;

1> if *reconfigurationWithSync* was included in *spCellConfig* of an MCG or SCG, and when MAC of an NR cell group successfully completes a random access procedure triggered above;

2> stop timer T304 for that cell group;

2> apply the parts of the CQI reporting configuration, the scheduling request configuration and the sounding RS configuration that do not require the UE to know the SFN of the respective target SpCell, if any;

2> apply the parts of the measurement and the radio resource configuration that require the UE to know the SFN of the respective target SpCell (e.g. measurement gaps, periodic CQI reporting, scheduling request configuration, sounding RS configuration), if any, upon acquiring the SFN of that target SpCell;

2> if the *reconfigurationWithSync* was included in *spCellConfig* of an MCG:

3> if T390 is running:

4> stop timer T390 for all access categories;

4> perform the actions as specified in 5.3.14.4.

3> if *RRCReconfiguration* does not include *dedicatedSIB1-Delivery* and

3> if the active downlink BWP, which is indicated by the *firstActiveDownlinkBWP-Id* for the target SpCell of the MCG, has a common search space configured by *searchSpaceSIB1*:

4> acquire the *SIB1*, which is scheduled as specified in TS 38.213 [13], of the target SpCell of the MCG;

4> upon acquiring *SIB1*, perform the actions specified in clause 5.2.2.4.2;

2> the procedure ends.

NOTE: The UE is only required to acquire broadcasted *SIB1* if the UE can acquire it without disrupting unicast data reception, i.e. the broadcast and unicast beams are quasi co-located.

[TS 38.331, clause 5.3.5.6.5]

The UE shall:

1> for each *drb-Identity* value included in the *drb-ToAddModList* that is not part of the current UE configuration (DRB establishment including the case when full configuration option is used):

- 2> establish a PDCP entity and configure it in accordance with the received *pdcp-Config*;
- 2> if the PDCP entity of this DRB is not configured with *cipheringDisabled*:
 - 3> if target RAT of handover is E-UTRA/5GC, or;
 - 3> if the UE is only connected to E-UTRA/5GC:
 - 4> configure the PDCP entity with the ciphering algorithm and K_{UPenc} key configured/derived as specified in TS 36.331 [10];
 - 3> else:
 - 4> configure the PDCP entity with the ciphering algorithms according to *securityConfig* and apply the K_{UPenc} key associated with the master key (K_{eNB}/K_{gNB}) or the secondary key ($S-K_{gNB}$) as indicated in *keyToUse*;
- 2> if the PDCP entity of this DRB is configured with *integrityProtection*:
 - 3> configure the PDCP entity with the integrity algorithms according to *securityConfig* and apply the K_{UPint} key associated with the master (K_{eNB}/K_{gNB}) or the secondary key ($S-K_{gNB}$) as indicated in *keyToUse*;
- ...
- 2> if the UE is operating in EN-DC:
 - 3> if the DRB was configured with the same *eps-BearerIdentity* either by NR or E-UTRA prior to receiving this reconfiguration:
 - 4> associate the established DRB with the corresponding *eps-BearerIdentity*;
 - 3> else:
 - 4> indicate the establishment of the DRB(s) and the *eps-BearerIdentity* of the established DRB(s) to upper layers;
- 1> for each *drb-Identity* value included in the *drb-ToAddModList* that is part of the current UE configuration:
 - 2> if the *reestablishPDCP* is set:
 - 3> if target RAT is E-UTRA/5GC, or;
 - 3> if the UE is only connected to E-UTRA/5GC:
 - 4> if the PDCP entity of this DRB is not configured with *cipheringDisabled*:
 - 5> configure the PDCP entity with the ciphering algorithm and K_{UPenc} key configured/derived as specified in TS 36.331 [10], clause 5.4.2.3, i.e. the ciphering configuration shall be applied to all subsequent PDCP PDUs received and sent by the UE;
 - 3> else:
 - 4> if the PDCP entity of this DRB is not configured with *cipheringDisabled*:
 - 5> configure the PDCP entity with the ciphering algorithm and K_{UPenc} key associated with the master key (K_{eNB}/K_{gNB}) or the secondary key ($S-K_{gNB}$), as indicated in *keyToUse*, i.e. the ciphering configuration shall be applied to all subsequent PDCP PDUs received and sent by the UE;
 - 4> if the PDCP entity of this DRB is configured with *integrityProtection*:
 - 5> configure the PDCP entity with the integrity algorithms according to *securityConfig* and apply the K_{UPint} key associated with the master (K_{eNB}/K_{gNB}) or the secondary key ($S-K_{gNB}$) as indicated in *keyToUse*;
 - 3> re-establish the PDCP entity of this DRB as specified in 38.323 [5], clause 5.1.2;
 - 2> else, if the *recoverPDCP* is set:
 - 3> trigger the PDCP entity of this DRB to perform data recovery as specified in 38.323 [5];

2> if the *pdcp-Config* is included:

3> reconfigure the PDCP entity in accordance with the received *pdcp-Config*.

...

NOTE 1: Void.

NOTE 2: When determining whether a *drb-Identity* value is part of the current UE configuration, the UE does not distinguish which *RadioBearerConfig* and *DRB-ToAddModList* that DRB was originally configured in. To re-associate a DRB with a different key (KeNB to S-KeNB or vice versa), the network provides the *drb-Identity* value in the (target) *drb-ToAddModList* and sets the *reestablishPDCP* flag. The network does not list the *drb-Identity* in the (source) *drb-ToReleaseList*.

NOTE 3: When setting the *reestablishPDCP* flag for a radio bearer, the network ensures that the RLC receiver entities do not deliver old PDCP PDUs to the re-established PDCP entity. It does that e.g. by triggering a reconfiguration with sync of the cell group hosting the old RLC entity or by releasing the old RLC entity.

NOTE 4: In this specification, UE configuration refers to the parameters configured by NR RRC unless otherwise stated.

NOTE 5: Ciphering and integrity protection can be enabled or disabled for a DRB. The enabling/disabling of ciphering or integrity protection can be changed only by releasing and adding the DRB.

8.2.2.9.1.3 Test description

8.2.2.9.1.3.1 Pre-test conditions

System Simulator:

- E-UTRA Cell 1 is the PCell and NR Cell 1 is the PSCell.

UE:

- None.

Preamble:

- If *pc_IP_Ping* is set to TRUE then, the UE is in state RRC_CONNECTED using generic procedure parameter Connectivity (*EN-DC*), Bearers (*MCG(s) and Split*) established according to TS 38.508-1 [4], clause 4.5.4.
- Else, the UE is in state RRC_CONNECTED using generic procedure parameter Connectivity (*EN-DC*), Bearers (*MCG(s) and Split*) established and Test Loop Function (*On*) with UE test loop mode B according to TS 38.508-1 [4], clause 4.5.4.

8.2.2.9.1.3.2 Test procedure sequence

Table 8.2.2.9.1.3.2-1: Main behaviour

St	Procedure	Message Sequence		TP	Verdict
		U - S	Message		
1	The SS transmits an <i>RRCCONNECTIONRECONFIGURATION</i> message containing NR RadioBearerConfig to change the primaryPath of the Split DRB to E-UTRA radio path from NR.	<--	<i>RRCCONNECTIONRECONFIGURATION</i>	-	-
2	Check: Does the UE transmit an <i>RRCCONNECTIONRECONFIGURATIONCOMPLETE</i> message?	-->	<i>RRCCONNECTIONRECONFIGURATIONCOMPLETE</i>	1	P
3	Check: Does the test result of generic test procedure in TS 38.508-1 subclause 4.9.1 indicate that the UE is capable of exchanging IP data on Split DRB#2 using E-UTRA radio path in the uplink?	-	-	1	P
4	The SS transmits an <i>RRCCONNECTIONRECONFIGURATION</i> message containing NR RadioBearerConfig to change the primaryPath of the Split DRB from E-UTRA radio path to NR.	<--	<i>RRCCONNECTIONRECONFIGURATION</i>	-	-
5	Check: Does the UE transmit an <i>RRCCONNECTIONRECONFIGURATIONCOMPLETE</i> message?	-->	<i>RRCCONNECTIONRECONFIGURATIONCOMPLETE</i>	2	P
6	Check: Does the test result of generic test procedure in TS 38.508-1 subclause 4.9.1 indicate that the UE is capable of exchanging IP data on the Split DRB#2 using NR radio path in the uplink?	-	-	2	P

8.2.2.9.1.3.3 Specific message contents

Table 8.2.2.9.1.3.3-1: RRCConnectionReconfiguration (step 1, Table 8.2.2.9.1.3.2-1)

Derivation Path: 36.508 [7], Table 4.6.1-8			
Information Element	Value/remark	Comment	Condition
RRCConnectionReconfiguration ::= SEQUENCE {			
criticalExtensions CHOICE {			
c1 CHOICE{			
rrcConnectionReconfiguration-r8 SEQUENCE {			
nonCriticalExtension SEQUENCE {			
nonCriticalExtension SEQUENCE {			
nonCriticalExtension SEQUENCE {			
nonCriticalExtension SEQUENCE {			
nonCriticalExtension SEQUENCE {			
nonCriticalExtension SEQUENCE {			
nonCriticalExtension SEQUENCE {			
nr-RadioBearerConfig1-r15	OCTET STRING including RadioBearerConfig.		
}			
}			
}			
}			
}			
}			
}			
}			
}			
}			

Table 8.2.2.9.1.3.3-2: RadioBearerConfig (Table 8.2.2.9.1.3.3-1)

Derivation Path: 38.508-1 [4], Table 4.6.3-132			
Information Element	Value/remark	Comment	Condition
RadioBearerConfig ::= SEQUENCE {			
drb-ToAddModList SEQUENCE (SIZE (1..maxDRB))	1 entry		
OF DRB-ToAddMod {			
DRB-ToAddMod[1] SEQUENCE {		entry 1	
pdcP-Config	PDCP-Config		
}			
}			
}			

Table 8.2.2.9.1.3.3-3: PDCP-Config (Table 8.2.2.9.1.3.3-2)

Derivation Path: 38.508-1 [4], Table 4.6.3-99			
Information Element	Value/remark	Comment	Condition
PDCP-Config ::= SEQUENCE {			
drb SEQUENCE {			
statusReportRequired	true		
}			
moreThanOneRLC SEQUENCE {			
primaryPath SEQUENCE {			
cellGroup	0		
}			
ul-DataSplitThreshold	infinity		
}			
}			

Table 8.2.2.9.1.3.3-4: RRCConnectionReconfiguration (step 4, Table 8.2.2.9.1.3.2-1)

Derivation Path: 36.508 [7], Table 4.6.1-8			
Information Element	Value/remark	Comment	Condition
RRCConnectionReconfiguration ::= SEQUENCE {			
criticalExtensions CHOICE {			
c1 CHOICE{			
rrcConnectionReconfiguration-r8 SEQUENCE {			
nonCriticalExtension SEQUENCE {			
nonCriticalExtension SEQUENCE {			
nonCriticalExtension SEQUENCE {			
nonCriticalExtension SEQUENCE {			
nonCriticalExtension SEQUENCE {			
nonCriticalExtension SEQUENCE {			
nonCriticalExtension SEQUENCE {			
nr-RadioBearerConfig1-r15	OCTET STRING including RadioBearerConfig.		
}			
}			
}			
}			
}			
}			
}			
}			
}			
}			
}			
}			
}			
}			

Table 8.2.2.9.1.3.3-5: RadioBearerConfig (Table 8.2.2.9.1.3.3-4)

Derivation Path: 38.508-1 [4], Table 4.6.3-132			
Information Element	Value/remark	Comment	Condition
RadioBearerConfig ::= SEQUENCE {			
drb-ToAddModList SEQUENCE (SIZE (1..maxDRB)) OF DRB-ToAddMod {	1 entry		
DRB-ToAddMod[1] SEQUENCE {		entry 1	
pdcp-Config	PDCP-Config		
}			
}			
}			

Table 8.2.2.9.1.3.3-6: PDCP-Config (Table 8.2.2.9.1.3.3-5)

Derivation Path: 38.508-1 [4], Table 4.6.3-99			
Information Element	Value/remark	Comment	Condition
PDCP-Config ::= SEQUENCE {			
drb SEQUENCE {			
statusReportRequired	true		
}			
moreThanOneRLC SEQUENCE {			
primaryPath SEQUENCE {			
cellGroup	1		
}			
ul-DataSplitThreshold	infinity		
}			
}			

8.2.2.9.2 Bearer Modification / Uplink data path / Split DRB Reconfiguration / NR-DC

8.2.2.9.2.1 Test Purpose (TP)

(1)

```

with { UE in RRC_CONNECTED state with NR-DC, and, MCG and Split }
ensure that {
  when { UE receives an RRCReconfiguration message to change the primaryPath to SCG radio path from
MCG radio path }
  then { UE changes the uplink data path to SCG radio path and sends an RRCReconfigurationComplete
message }
}

```

(2)

```

with { UE in RRC_CONNECTED state with NR-DC, and, MCG and Split }
ensure that {
  when { UE receives an RRCReconfiguration message to change the primaryPath to MCG radio path from
SCG radio path }
  then { UE changes the uplink data path to MCG radio path and sends an RRCReconfigurationComplete
message }
}

```

8.2.2.9.2.2 Conformance requirements

References: The conformance requirements covered in the present test case are specified in: TS 38.331, clauses 5.3.5.3 and 5.3.5.6.5. Unless otherwise stated these are Rel-15 requirements.

[TS 38.331, clause 5.3.5.3]

The UE shall perform the following actions upon reception of the *RRCReconfiguration*, or upon execution of the conditional reconfiguration (CHO or CPC):

- 1> if the *RRCReconfiguration* is applied due to a conditional reconfiguration execution upon cell selection while timer T311 is running, as defined in 5.3.7.3:
 - 2> remove all the entries within *VarConditionalReconfig*, if any;
 - ...
- 1> else:
 - 2> if the *RRCReconfiguration* includes the *fullConfig*:
 - 3> perform the full configuration procedure as specified in 5.3.5.11;
 - 1> if the *RRCReconfiguration* includes the *masterCellGroup*:
 - 2> perform the cell group configuration for the received *masterCellGroup* according to 5.3.5.5;
 - 1> if the *RRCReconfiguration* includes the *masterKeyUpdate*:
 - 2> perform AS security key update procedure as specified in 5.3.5.7;
 - 1> if the *RRCReconfiguration* includes the *sk-Counter*:
 - 2> perform security key update procedure as specified in 5.3.5.7;
 - 1> if the *RRCReconfiguration* includes the *secondaryCellGroup*:
 - 2> perform the cell group configuration for the SCG according to 5.3.5.5;
 -
 - 1> if the *RRCReconfiguration* message includes the *radioBearerConfig*:
 - 2> perform the radio bearer configuration according to 5.3.5.6;

...

1> set the content of the *RRCReconfigurationComplete* message as follows:

....

2> if the *RRCReconfiguration* message was received via SRB1, but not within *mrdc-SecondaryCellGroup* or E-UTRA *RRCCConnectionReconfiguration*:

3> if the UE is configured to provide the measurement gap requirement information of NR target bands:

4> if the *RRCReconfiguration* message includes the *needForGapsConfigNR*; or

4> if the *NeedForGapsInfoNR* information is changed compared to last time the UE reported this information:

5> include the *NeedForGapsInfoNR* and set the contents as follows:

6> include *intraFreq-needForGap* and set the gap requirement information of intra-frequency measurement for each NR serving cell;

6> if *requestedTargetBandFilterNR* is configured, for each supported NR band that is also included in *requestedTargetBandFilterNR*, include an entry in *interFreq-needForGap* and set the gap requirement information for that band; otherwise, include an entry in *interFreq-needForGap* and set the corresponding gap requirement information for each supported NR band;

...

1> else (*RRCReconfiguration* was received via SRB1):

2> submit the *RRCReconfigurationComplete* message via SRB1 to lower layers for transmission using the new configuration;

2> if this is the first *RRCReconfiguration* message after successful completion of the RRC re-establishment procedure:

3> resume SRB2 and DRBs that are suspended;

...

[TS 38.331, clause 5.3.5.6.5]

The UE shall:

1> for each *drb-Identity* value included in the *drb-ToAddModList* that is not part of the current UE configuration (DRB establishment including the case when full configuration option is used):

2> establish a PDCP entity and configure it in accordance with the received *pdcp-Config*;

...

3> else (i.e., UE connected to NR or UE connected to E-UTRA/EPC):

4> configure the PDCP entity with the ciphering algorithms according to *securityConfig* and apply the K_{UPenc} key associated with the master key (K_{eNB}/K_{gNB}) or the secondary key ($S-K_{gNB}/S-K_{eNB}$) as indicated in *keyToUse*;

2> if the PDCP entity of this DRB is configured with *integrityProtection*:

3> configure the PDCP entity with the integrity protection algorithms according to *securityConfig* and apply the K_{UPint} key associated with the master (K_{gNB}) or the secondary key ($S-K_{gNB}$) as indicated in *keyToUse*;

....

1> for each *drb-Identity* value included in the *drb-ToAddModList* that is part of the current UE configuration and not configured as DAPS bearer:

...

2> if the *pdcp-Config* is included:

3> reconfigure the PDCP entity in accordance with the received *pdcp-Config*.

...

NOTE 1: Void.

NOTE 2: When determining whether a *drb-Identity* value is part of the current UE configuration, the UE does not distinguish which *RadioBearerConfig* and *DRB-ToAddModList* that DRB was originally configured in. To re-associate a DRB with a different key (K_{eNB} to $S-K_{gNB}$, K_{gNB} to $S-K_{eNB}$, K_{gNB} to $S-K_{gNB}$, or vice versa), the network provides the *drb-Identity* value in the (target) *drb-ToAddModList* and sets the *reestablishPDCP* flag. The network does not list the *drb-Identity* in the (source) *drb-ToReleaseList*.

NOTE 3: When setting the *reestablishPDCP* flag for a radio bearer, the network ensures that the RLC receiver entities do not deliver old PDCP PDUs to the re-established PDCP entity. It does that e.g. by triggering a reconfiguration with sync of the cell group hosting the old RLC entity or by releasing the old RLC entity.

NOTE 4: In this specification, UE configuration refers to the parameters configured by NR RRC unless otherwise stated.

NOTE 5: Ciphering and integrity protection can be enabled or disabled for a DRB. The enabling/disabling of ciphering or integrity protection can be changed only by releasing and adding the DRB.

8.2.2.9.2.3 Test description

8.2.2.9.2.3.1 Pre-test conditions

System Simulator:

- NR Cell 1 is the PCell and NR Cell 10 is the PSCell.

UE:

- None.

Preamble:

- If *pc_IP_Ping* is set to TRUE then, the UE is in state RRC_CONNECTED using generic procedure parameter Connectivity (*NR-DC*), Bearers (*MCG and Split*) established according to TS 38.508-1 [4], clause 4.5.4.
- Else, the UE is in state RRC_CONNECTED using generic procedure parameter Connectivity (*NR-DC*), Bearers (*MCG and Split*) established and Test Loop Function (*On*) with UE test loop mode B according to TS 38.508-1 [4], clause 4.5.4.

8.2.2.9.2.3.2 Test procedure sequence

Table 8.2.2.9.2.3.2-1: Main behaviour

St	Procedure	Message Sequence		TP	Verdict
		U - S	Message		
1	The SS transmits an <i>RRCReconfiguration</i> message containing NR RadioBearerConfig to change the primaryPath to SCG radio path from MCG radio path.	<--	NR RRC: <i>RRCReconfiguration</i>	-	-
2	Check: Does the UE transmit an <i>RRCReconfigurationComplete</i> message?	-->	NR RRC: <i>RRCReconfigurationComplete</i>	1	P
3	Check: Does the test result of generic test procedure in TS 38.508-1 subclause 4.9.1 indicate that the UE is capable of exchanging IP data on Split DRB#2 using SCG radio path in the uplink?	-	-	1	P
4	The SS transmits an <i>RRCReconfiguration</i> message containing NR RadioBearerConfig to change the primaryPath to MCG radio path from SCG radio path.	<--	NR RRC: <i>RRCReconfiguration</i>	-	-
5	Check: Does the UE transmit an <i>RRCReconfigurationComplete</i> message?	-->	NR RRC: <i>RRCReconfigurationComplete</i>	2	P
6	Check: Does the test result of generic test procedure in TS 38.508-1 subclause 4.9.1 indicate that the UE is capable of exchanging IP data on on Split DRB#2 using MCG radio path in the uplink?	-	-	2	P

8.2.2.9.2.3.3 Specific message contents

Table 8.2.2.9.2.3.3-1: *RRCReconfiguration* (step 1, Table 8.2.2.9.2.3.2-1)

Derivation Path: 38.508-1 [4], Table 4.6.1-13			
Information Element	Value/remark	Comment	Condition
<i>RRCReconfiguration</i> ::= SEQUENCE {			
criticalExtensions CHOICE {			
rrcReconfiguration SEQUENCE {			
nonCriticalExtension SEQUENCE {			
nonCriticalExtension SEQUENCE {			
nonCriticalExtension SEQUENCE {			
mrdc-SecondaryCellGroupConfig CHOICE {			
setup SEQUENCE {			
mrdc-SecondaryCellGroup CHOICE {			
nr-SCG	OCTET STRING (CONTAINING <i>RRCReconfiguration</i> specified in 38.508-1 [4], Table 4.6.1-13 with condition NR-DC_SCG)		
}			
}			
}			
radioBearerConfig2	RadioBearerConfig-NR- DC_SCG	See Table 8.2.2.9.2.3.3-2	
}			
}			
}			
}			
}			

Table 8.2.2.9.2.3.3-2: RadioBearerConfig-NR-DC_SCG (Table 8.2.2.9.2.3.3-1)

Derivation Path: 38.508-1 [4], Table 4.6.3-132 with condition DRB1			
Information Element	Value/remark	Comment	Condition
RadioBearerConfig ::= SEQUENCE {			
drb-ToAddModList SEQUENCE (SIZE (1..maxDRB))	1 entry		
OF DRB-ToAddMod {			
DRB-ToAddMod[1] SEQUENCE {		entry 1	
drb-Identity	DRB-Identity with condition DRBn	DRBn is allocated for SCG according to internal TTCN mapping	
pdcp-Config	PDCP-Config		
}			
}			
}			

Table 8.2.2.9.2.3.3-3: PDCP-Config (Table 8.2.2.9.2.3.3-2)

Derivation Path: 38.508-1 [4], Table 4.6.3-99			
Information Element	Value/remark	Comment	Condition
PDCP-Config ::= SEQUENCE {			
drb SEQUENCE {			
statusReportRequired	True		
}			
moreThanOneRLC SEQUENCE {			
primaryPath SEQUENCE {			
cellGroup	0		
}			
ul-DataSplitThreshold	Infinity		
}			
}			

Table 8.2.2.9.2.3.3-4: RRCReconfiguration (step 4, Table 8.2.2.9.2.3.2-1)

Derivation Path: 38.508-1 [4], Table 4.6.1-13			
Information Element	Value/remark	Comment	Condition
RRCReconfiguration ::= SEQUENCE {			
criticalExtensions CHOICE {			
rrcReconfiguration SEQUENCE {			
nonCriticalExtension SEQUENCE {			
nonCriticalExtension SEQUENCE {			
nonCriticalExtension SEQUENCE {			
mrdc-SecondaryCellGroupConfig CHOICE {			
setup SEQUENCE {			
mrdc-SecondaryCellGroup CHOICE {			
nr-SCG	OCTET STRING (CONTAINING RRCReconfiguration specified in 38.508-1 [4], Table 4.6.1-13 with condition NR-DC_SCG)		
}			
}			
}			
radioBearerConfig2	RadioBearerConfig-NR-DC_SCG	See Table 8.2.2.9.2.3.3-5	
}			
}			
}			
}			
}			
}			

Table 8.2.2.9.2.3.3-5: RadioBearerConfig-NR-DC_SCG (Table 8.2.2.9.2.3.3-4)

Derivation Path: 38.508-1 [4], Table 4.6.3-132 with condition DRB1			
Information Element	Value/remark	Comment	Condition
RadioBearerConfig ::= SEQUENCE {			
drb-ToAddModList SEQUENCE (SIZE (1..maxDRB))	1 entry		
OF DRB-ToAddMod {			
DRB-ToAddMod[1] SEQUENCE {		entry 1	
drb-Identity	DRB-Identity with condition DRBn	DRBn is allocated for SCG according to internal TTCN mapping	
}			
}			
pdcp-Config	PDCP-Config		
}			
}			
}			

Table 8.2.2.9.2.3.3-6: PDCP-Config (Table 8.2.2.9.2.3.3-5)

Derivation Path: 38.508-1 [4], Table 4.6.3-99			
Information Element	Value/remark	Comment	Condition
PDCP-Config ::= SEQUENCE {			
drb SEQUENCE {			
statusReportRequired	true		
}			
moreThanOneRLC SEQUENCE {			
primaryPath SEQUENCE {			
cellGroup	1		
}			
}			
ul-DataSplitThreshold	infinity		
}			
}			

8.2.3 Measurement Configuration Control and Reporting / Handovers

8.2.3.1 Measurement configuration control and reporting / Inter-RAT measurements / Event B1 / Measurement of NR cells

8.2.3.1.1 Measurement configuration control and reporting / Inter-RAT measurements / Event B1 / Measurement of NR cells / EN-DC

8.2.3.1.1.1 Test Purpose (TP)

(1)

```
with { UE in RRC_CONNECTED state with EN-DC, and, MCG(s) (E-UTRA PDCP) only having completed the
radio bearer establishment and performed the inter RAT measurement for NR cell and not detected
entering condition for the event B1 is met }
ensure that {
  when { UE detects entering condition for the event B1 is not met }
  then { UE does not transmit any MeasurementReport }
}
```

(2)

```
with { UE in RRC_CONNECTED state with EN-DC, and, MCG(s) (E-UTRA PDCP) only having completed the
radio bearer establishment and performed the inter RAT measurement for NR cell and not detected
entering condition for the event B1 is met }
ensure that {
  when { UE detects entering condition for the event B1 is met }
  then { UE transmits a MeasurementReport }
}
```

(3)

```

with { UE in RRC_CONNECTED state with EN-DC, and, MCG(s) (E-UTRA PDCP) only having completed the
radio bearer establishment and performed the inter RAT measurement for NR cell and detected entering
condition for the event B1 is met }
ensure that {
  when { UE detects leaving condition for the event B1 is met }
  then { UE does not transmit any MeasurementReport }
}

```

8.2.3.1.1.2 Conformance requirements

References: The conformance requirements covered in the present TC are specified in: TS 36.331, clauses 5.5.1, 5.5.4.1, 5.5.4.7, 5.5.5 and 5.5.5.3. Unless otherwise stated these are Rel-15 requirements.

[TS 36.331, clause 5.5.1]

The UE reports measurement information in accordance with the measurement configuration as provided by E-UTRAN. E-UTRAN provides the measurement configuration applicable for a UE in RRC_CONNECTED by means of dedicated signalling, i.e. using the *RRConnectionReconfiguration* or *RRConnectionResume* message.

The UE can be requested to perform the following types of measurements:

- Intra-frequency measurements: measurements at the downlink carrier frequency(ies) of the serving cell(s).
- Inter-frequency measurements: measurements at frequencies that differ from any of the downlink carrier frequency(ies) of the serving cell(s).
- Inter-RAT measurements of NR frequencies.

...

The measurement configuration includes the following parameters:

1. **Measurement objects:** The objects on which the UE shall perform the measurements.
 - For intra-frequency and inter-frequency measurements a measurement object is a single E-UTRA carrier frequency. Associated with this carrier frequency, E-UTRAN can configure a list of cell specific offsets, a list of 'blacklisted' cells and a list of 'whitelisted' cells. Blacklisted cells are not considered in event evaluation or measurement reporting.
 - For inter-RAT NR measurements a measurement object is a single NR carrier frequency. Associated with this carrier frequency, E-UTRAN can configure a list of 'blacklisted' cells. Blacklisted cells are not considered in event evaluation or measurement reporting.

...

NOTE 1: Some measurements using the above mentioned measurement objects, only concern a single cell, e.g. measurements used to report neighbouring cell system information, PCell UE Rx-Tx time difference, or a pair of cells, e.g. SSTD measurements between the PCell and the PSCell.

2. **Reporting configurations:** A list of reporting configurations where each reporting configuration consists of the following:
 - Reporting criterion: The criterion that triggers the UE to send a measurement report. This can either be periodical or a single event description.
 - Reporting format: The quantities that the UE includes in the measurement report and associated information (e.g. number of cells to report).
3. **Measurement identities:** A list of measurement identities where each measurement identity links one measurement object with one reporting configuration. By configuring multiple measurement identities it is possible to link more than one measurement object to the same reporting configuration, as well as to link more than one reporting configuration to the same measurement object. The measurement identity is used as a reference number in the measurement report.

4. **Quantity configurations:** One quantity configuration is configured per RAT type. The quantity configuration defines the measurement quantities and associated filtering used for all event evaluation and related reporting of that measurement type. One filter can be configured per measurement quantity, except for NR where the network may configure up to 2 sets of quantity configurations each comprising per measurement quantity separate filters for cell and RS index measurement results. The quantity configuration set that applies for a given measurement is indicated within the NR measurement object.
5. **Measurement gaps:** Periods that the UE may use to perform measurements, i.e. no (UL, DL) transmissions are scheduled.

...

For E-UTRA, the UE measures and reports on the serving cell(s), listed cells, detected cells, transmission resource pools for V2X sidelink communication, and, for RSSI and channel occupancy measurements, the UE measures and reports on any reception on the indicated frequency. For inter-RAT NR, the UE measures and reports on detected cells and, if configured with EN-DC, on NR serving cell(s). For inter-RAT UTRA, the UE measures and reports on listed cells and optionally on cells that are within a range for which reporting is allowed by E-UTRAN. For inter-RAT GERAN, the UE measures and reports on detected cells. For inter-RAT CDMA2000, the UE measures and reports on listed cells. For inter-RAT WLAN, the UE measures and reports on listed cells.

[TS 36.331, clause 5.5.4.1]

If security has been activated successfully, The UE shall:

1> for each *measId* included in the *measIdList* within *VarMeasConfig*:

...

2> else:

...

3> else if the corresponding *measObject* concerns NR:

4> if the *reportSFTD-Meas* is set to *pSCell* in the corresponding *reportConfigInterRAT*:

5> consider the PSCell to be applicable;

4> else if the *reportSFTD-Meas* is set to *neighborCells* in the corresponding *reportConfigInterRAT*:

5> if *cellsForWhichToReportSFTD* is configured in the corresponding *measObjectNR*:6> consider any neighbouring NR cell on the associated frequency that is included in *cellsForWhichToReportSFTD* to be applicable;

5> else:

6> consider up to 3 strongest neighbouring NR cells detected on the associated frequency to be applicable when the concerned cell is not included in the *blackCellsToAddModList* defined within the *VarMeasConfig* for this *measId*;

4> else:

5> if the *eventB1* or *eventB2* is configured in the corresponding *reportConfig*:

6> consider a serving cell, if any, on the associated NR frequency as neighbouring cell;

5> consider any neighbouring cell detected on the associated frequency to be applicable when the concerned cell is not included in the *blackCellsToAddModList* defined within the *VarMeasConfig* for this *measId*;[TS 36.331, clause 5.5.4.7]

The UE shall:

- 1> for UTRA and CDMA2000, only trigger the event for cells included in the corresponding measurement object;
- 1> consider the entering condition for this event to be satisfied when condition B1-1, as specified below, is fulfilled;
- 1> consider the leaving condition for this event to be satisfied when condition B1-2, as specified below, is fulfilled;

Inequality B1-1 (Entering condition)

$$Mn + Ofn - Hys > Thresh$$

Inequality B1-2 (Leaving condition)

$$Mn + Ofn + Hys < Thresh$$

The variables in the formula are defined as follows:

Mn is the measurement result of the inter-RAT neighbour cell, not taking into account any offsets. For CDMA 2000 measurement result, *pilotStrength* is divided by -2.

Ofn is the frequency specific offset of the frequency of the inter-RAT neighbour cell (i.e. *offsetFreq* as defined within the *measObject* corresponding to the frequency of the neighbour inter-RAT cell).

Hys is the hysteresis parameter for this event (i.e. *hysteresis* as defined within *reportConfigInterRAT* for this event).

Thresh is the threshold parameter for this event (i.e. *b1-Threshold* as defined within *reportConfigInterRAT* for this event). For CDMA2000, *b1-Threshold* is divided by -2.

Mn is expressed in dBm or in dB, depending on the measurement quantity of the inter-RAT neighbour cell.

Ofn, ***Hys*** are expressed in dB.

Thresh is expressed in the same unit as ***Mn***.

[TS 36.331, clause 5.5.5]

The purpose of this procedure is to transfer measurement results from the UE to E-UTRAN. The UE shall initiate this procedure only after successful security activation.

For the *measId* for which the measurement reporting procedure was triggered, the UE shall set the *measResults* within the *MeasurementReport* message as follows:

- 1> set the *measId* to the measurement identity that triggered the measurement reporting;
- 1> set the *measResultPCell* to include the quantities of the PCell;
- 1> set the *measResultServFreqList* to include for each E-UTRA SCell that is configured, if any, within *measResultSCell* the quantities of the concerned SCell, if available according to performance requirements in 36.133 [16], except if *purpose* for the *reportConfig* associated with the *measId* that triggered the measurement reporting is set to *reportLocation*;
- 1> if the *reportConfig* associated with the *measId* that triggered the measurement reporting includes *reportAddNeighMeas*:
 - 2> for each E-UTRA serving frequency for which *measObjectId* is referenced in the *measIdList*, other than the frequency corresponding with the *measId* that triggered the measurement reporting:
 - 3> set the *measResultServFreqList* to include within *measResultBestNeighCell* the *physCellId* and the quantities of the best non-serving cell, based on RSRP, on the concerned serving frequency;
- 1> if the *triggerType* is set to *event*; and if the corresponding *measObject* concerns NR; and if *eventId* is set to *eventB1-NR* or *eventB2-NR*; or
- 1> if the *triggerType* is set to *event*; and if *eventId* is set to *eventA3* or *eventA4* or *eventA5*:
 - 2> if *purpose* for the *reportConfig* associated with the *measId* that triggered the measurement reporting is set to a value other than *reportLocation*:
 - 3> set the *measResultServFreqListNR* to include for each NR serving frequency that the UE is configured to measure according to TS 38.331 [82], if any, the following:
 - 4> set *measResultSCell* to include the available results of the NR serving cell, as specified in 5.5.5.2;

- 4> if the *reportConfig* associated with the *measId* that triggered the measurement reporting includes *reportAddNeighMeas*:
 - 5> set *measResultBestNeighCell* to include the available results, as specified in 5.5.5.2, of the best non-serving cell, ordered based on the quantity determined as specified in 5.5.5.2;
- 3> for each (serving or neighbouring) cell for which the UE reports results according to the previous, additionally include available beam results according to the following:
 - 4> if *maxReportRS-Index* is configured, set *measResultRS-IndexList* to include available results, as specified in 5.5.5.2, of up to *maxReportRS-Index* beams, ordered based on the quantity determined as specified in 5.5.5.3;
- 1> if there is at least one applicable neighbouring cell to report:
 - 2> set the *measResultNeighCells* to include the best neighbouring cells up to *maxReportCells* in accordance with the following:
 - 3> if the *triggerType* is set to *event*:
 - 4> include the cells included in the *cellsTriggeredList* as defined within the *VarMeasReportList* for this *measId*;
 - 3> else:
 - 4> include the applicable cells for which the new measurement results became available since the last periodical reporting or since the measurement was initiated or reset;

NOTE 1: The reliability of the report (i.e. the certainty it contains the strongest cells on the concerned frequency) depends on the measurement configuration i.e. the *reportInterval*. The related performance requirements are specified in TS 36.133 [16].

- 3> for each cell that is included in the *measResultNeighCells*, include the *physCellId*;
- 3> if the *triggerType* is set to *event*; or the *purpose* is set to *reportStrongestCells* or to *reportStrongestCellsForSON*:
 - 4> for each included cell, include the layer 3 filtered measured results in accordance with the *reportConfig* for this *measId*, ordered as follows:
 - 5> if the *measObject* associated with this *measId* concerns E-UTRA:
 - 6> set the *measResult* to include the quantity(ies) indicated in the *reportQuantity* within the concerned *reportConfig*;
 - 6> sort the included cells in order of decreasing *triggerQuantity*, i.e. the best cell is included first;
 - 5> if the *measObject* associated with this *measId* concerns NR:
 - 6> set the *measResultCell* to include the quantity(ies) indicated in the *reportQuantityCellNR* within the concerned *reportConfig*;
 - 6> if *maxReportRS-Index* and *reportQuantityRS-IndexNR* are configured, set *measResultRS-IndexList* to include results of the best beam and the beams whose quantity is above *threshRS-Index* defined in the *VarMeasConfig* for the corresponding *measObject*, up to *maxReportRS-Index* beams in total:
 - 7> order beams based on the sorting quantity determined as specified in 5.5.5.3;
 - 7> include *ssbIndex*;
 - 7> for each included beam:
 - 8> include *ssbIndex*;
 - 8> if *reportRS-IndexResultsNR* is configured, for each quantity indicated, include the corresponding measurement result in *measResultNeighCells*;

6> sort the included cells in order of decreasing sorting quantity determined as specified in 5.5.5.3;

...

[TS 36.331, clause 5.5.5.3]

- 1> for cells on the frequency associated with the *measId* that triggered the measurement reporting, if the *reportTrigger* is set to *event*, consider the quantity used in *BN-ThresholdYNR* to be the sorting quantity;
- 1> for other cases, determine the sorting quantity as follows:
 - 2> consider the following quantities as candidate sorting quantities:
 - 3> for cells on the frequency associated with the *measId* that triggered the measurement reporting (for a *triggerType* set to *periodical*):
 - 4> the quantities defined by *reportQuantityCellNR*, when used for sorting cells;
 - 4> the quantities defined by *reportQuantityRS-IndexNR*, when used for sorting beams;
 - 3> for cells, serving or non-serving (i.e. within *reportAddNeighMeas*), on NR serving frequencies other than the one associated with the *measId* triggering reporting:
 - 4> the available quantities of available NR measurement results as specified in 5.5.5.2;
 - 2> if there is a single candidate sorting quantity;
 - 3> consider the concerned quantity to be the sorting quantity;
 - 2> else:
 - 3> if RSRP is one of the candidate sorting quantities;
 - 4> consider RSRP to be the sorting quantity;
 - 3> else:
 - 4> consider RSRQ to be the sorting quantity;

8.2.3.1.1.3 Test description

8.2.3.1.1.3.1 Pre-test conditions

System Simulator:

- E-UTRA Cell 1 and NR Cell 1.

UE:

- None.

Preamble:

- The UE is in state RRC_CONNECTED using generic procedure parameter Connectivity (*EN-DC*) and Bearers (*MCG(s) only*) established according to TS 38.508-1 [4].

8.2.3.1.1.3.2 Test procedure sequence

Table 8.2.3.1.3.2-1 and Table 8.2.3.1.3.2-1A illustrates the downlink power levels and other changing parameters to be applied for the cells at various time instants of the test execution. Row marked "T0" denotes the initial conditions after preamble, while columns marked "T1" and "T2" are to be applied subsequently. The exact instants on which these values shall be applied are described in the texts in this clause.

Table 8.2.3.1.1.3.2-1: Time instances of cell power level and parameter changes for FR1

	Parameter	Unit	E-UTRA Cell 1	NR Cell 1	Remark
T0	Cell-specific RS EPRE	dBm/15 kHz	-85	-	The power level values are such that entering conditions for event B1 are not satisfied.
	SS/PBCH SSS EPRE	dBm/SC S	-	-91	
T1	Cell-specific RS EPRE	dBm/15 kHz	-85	-	The power level values are such that entering conditions for event B1 are satisfied.
	SS/PBCH SSS EPRE	dBm/SC S	-	-79	
T2	Cell-specific RS EPRE	dBm/15 kHz	-85	-	The power level values are such that leaving conditions for event B1 are satisfied.
	SS/PBCH SSS EPRE	dBm/SC S	-	-91	

Table 8.2.3.1.1.3.2-1A: Time instances of cell power level and parameter changes for FR2

	Parameter	Unit	E-UTRA Cell 1	NR Cell 1	Remark
T0	Cell-specific RS EPRE	dBm/15 kHz	-96	-	The power level values are such that entering conditions for event B1 are not satisfied.
	SS/PBCH SSS EPRE	dBm/SC S	-	-100	
T1	Cell-specific RS EPRE	dBm/15 kHz	-96	-	The power level values are such that entering conditions for event B1 are satisfied.
	SS/PBCH SSS EPRE	dBm/SC S	-	-82	
T2	Cell-specific RS EPRE	dBm/15 kHz	-96	-	The power level values are such that leaving conditions for event B1 are satisfied.
	SS/PBCH SSS EPRE	dBm/SC S	-	-100	

Table 8.2.3.1.1.3.2-2: Main behaviour

St	Procedure	Message Sequence		TP	Verdict
		U - S	Message		
1	The SS transmits an <i>RRCConnectionReconfiguration</i> including measConfig to setup inter RAT measurements and reporting for NR Cell 1.	<-	<i>RRCConnectionReconfiguration</i>	-	-
2	The UE transmits an <i>RRCConnectionReconfigurationComplete</i> message to confirm the setup of inter RAT measurements for NR Cell 1.	-->	<i>RRCConnectionReconfigurationComplete</i>	-	-
3	Check: Does the UE transmit a <i>MeasurementReport</i> message on E-UTRA Cell 1 to report the event B1 during the next 10s?	-->	<i>MeasurementReport</i>	1	F
4	The SS changes NR Cell 1 parameters according to the row "T1".	-	-	-	-
5	Check: Does the UE transmit a <i>MeasurementReport</i> message to report the event B1 for NR Cell 1?	-->	<i>MeasurementReport</i>	2	P
6	The SS changes NR Cell 1 parameters according to the row "T2".	-	-	-	-
7	Wait and ignore <i>MeasurementReport</i> messages for 57s if NR Cell 1 is on FR2 frequency else wait for 15 s to allow change of power levels and UE measurements for NR Cell 1.	-	-	-	-
8	Check: Does the UE transmit a <i>MeasurementReport</i> message on E-UTRA Cell 1 to report the event B1 during the next 10s?	-->	<i>MeasurementReport</i>	3	F

8.2.3.1.1.3.3 Specific message contents

Table 8.2.3.1.1.3.3-0: Conditions for specific message contents in Tables 8.2.3.1.1.3.3-2.

Condition	Explanation
Band > 64	If band > 64 is selected

Table 8.2.3.1.1.3.3-1: *RRCConnectionReconfiguration* (step 1, Table 8.2.3.1.1.3.2-2)

Derivation Path: 36.508 [7], Table 4.6.1-8, condition MEAS
--

Table 8.2.3.1.1.3.3-2: *MeasConfig* (Table 8.2.3.1.1.3.3-1)

Derivation Path: 36.508 [7], Table 4.6.6-1			
Information Element	Value/remark	Comment	Condition
MeasConfig ::= SEQUENCE {			
measObjectToAddModList SEQUENCE (SIZE (1..maxObjectId)) OF MeasObjectToAddMod {	2 entries		
MeasObjectToAddMod[1] SEQUENCE {		entry 1	
measObjectId	1		
measObject	MeasObjectEUTRA- GENERIC(f1)		
	MeasObjectEUTRA- GENERIC(maxEARFCN)		Band > 64
}			
MeasObjectToAddMod[2] SEQUENCE {		entry 2	
measObjectId	2		
measObject	MeasObjectNR- GENERIC (NRf1)		
}			
}			
reportConfigToAddModList SEQUENCE (SIZE (1..maxReportConfigId)) OF ReportConfigToAddMod {	1 entry		
ReportConfigToAddMod[1] SEQUENCE {		entry 1	
reportConfigId	1		
reportConfig	ReportConfig1-B1-NR- r15(-85)		FR1
	ReportConfig2-B1-NR- r15(-91 + Δ(NRf1))		FR2
}			
measIdToAddModList SEQUENCE (SIZE (1..maxMeasId)) OF MeasIdToAddMod {	1 entry		
MeasIdToAddMod[1] SEQUENCE {		entry 1	
measId	1		
measObjectId	2		
reportConfigId	1		
}			
}			
quantityConfig	QuantityConfig- DEFAULT		
measGapConfig	MeasGapConfig		
measObjectToAddModList-v9e0 SEQUENCE (SIZE (1..maxObjectId)) OF MeasObjectToAddMod-v9e0 {	1 entry		Band > 64
MeasObjectToAddMod-v9e0[1] SEQUENCE {		entry 1	
measObjectEUTRA-v9e0 SEQUENCE {			
carrierFreq-v9e0	Same downlink EARFCN as used for f1		
}			
}			
}			
}			

Table 8.2.3.1.1.3.3-3: QuantityConfig-DEFAULT (Table 8.2.3.1.1.3.3-2)

Derivation Path: 36.508 [7], Table 4.6.6-3A			
Information Element	Value/remark	Comment	Condition
QuantityConfig-DEFAULT ::= SEQUENCE {			
quantityConfigNRList-r15 SEQUENCE ((SIZE (1..maxQuantSetsNR-r15)) OF QuantityConfigNR-r15 {	1 entry		
QuantityConfigNR-r15[1] SEQUENCE {		entry 1	
measQuantityCellNR-r15 SEQUENCE {			
filterCoeff-RSRP-r15	fc0		
filterCoeff-RSRQ-r15	fc0		
filterCoefficient-SINR-r13	fc0		
}			
}			
}			
}			

Table 8.2.3.1.1.3.3-4: MeasObjectNR-GENERIC (NRf1) (Table 8.2.3.1.1.3.3-2)

Derivation Path: 36.508 [7], Table 4.6.6-2B			
Information Element	Value/remark	Comment	Condition
MeasObjectNR-GENERIC(Freq) ::= SEQUENCE {			
carrierFreq-r15	Downlink carrier frequency of NR cell 1		
}			

Table 8.2.3.1.1.3.3-5: ReportConfig1-B1-NR-r15(-85) (Table 8.2.3.1.1.3.3-2)

Derivation Path: 36.508 [7], Table 4.6.6-7AA			
Information Element	Value/remark	Comment	Condition
ReportConfig-B1-NR ::= SEQUENCE {			
triggerType CHOICE {			
reportAmount	infinity		
reportQuantityCellNR-r15 SEQUENCE {			
ss-rsrp	true		
ss-rsrq	true		
ss-sinr	true		
}			
}			

Table 8.2.3.1.1.3.3-6: MeasurementReport (step 5, Table 8.2.3.1.1.3.2-2)

Derivation Path: 36.508 [7], Table 4.6.1-5			
Information Element	Value/remark	Comment	Condition
MeasurementReport ::= SEQUENCE {			
criticalExtensions CHOICE {			
c1 CHOICE{			
measurementReport-r8 SEQUENCE {			
measResults SEQUENCE {			
measId	1		
measResultPCell SEQUENCE {			
rsrpResult	(0..97)		
rsrqResult	(0..34)		
}			
measResultNeighCells CHOICE {			
measResultNeighCellListNR-r15 SEQUENCE (SIZE (1..maxCellReport)) OF MeasResultCellNR-r15 {	1 entry		
MeasResultCellNR-r15[1] SEQUENCE {		entry 1	
pci-r15 [1]	PhysicalCellIdentity of NR Cell 1		
measResultCell-r15 [1] SEQUENCE {			
rsrpResult-r15	(0..127)		
rsrqResult-r15	(0..127)		
rs-sinr-Result-r15	(0..127)		
}			
measResultRS-IndexList-r15	Not present		
cgi-Info-r15	Not present		
}			
}			
}			
}			
}			
}			

Table 8.2.3.1.1.3.3-7: MeasGapConfig(Table 8.2.3.1.1.3.3-2)

Derivation Path: 36.331, clause 6.3.5			
Information Element	Value/remark	Comment	Condition
MeasGapConfig-GP2 ::= CHOICE {			
setup SEQUENCE {			
gapOffset CHOICE {			
gp1	19	TGRP = 80 ms	
}			
}			
}			

Table 8.2.3.1.1.3.3-8: ReportConfig2-B1-NR-r15(-91 + Δ (NRf1)) (Table 8.2.3.1.1.3.3-2)

Derivation Path: 36.508 [7], Table 4.6.6-7AA			
Information Element	Value/remark	Comment	Condition
ReportConfig-B1-NR ::= SEQUENCE {			
triggerType CHOICE {			
reportAmount	Infinity		
reportQuantityCellNR-r15 SEQUENCE {			
ss-rsrp	true		
ss-rsrq	true		
ss-sinr	true		
}			
}			
NOTE 1: Δ (NRf1) is derived based on calibration procedure defined in the TS 38.508-1 [4], clause 6.1.3.3			

8.2.3.2 Measurement configuration control and reporting / Inter-RAT measurements / Event B1 / Measurement of NR cells / RSRQ based measurements

8.2.3.2.1 Measurement configuration control and reporting / Inter-RAT measurements / Event B1 / Measurement of NR cells / RSRQ based measurements / EN-DC

8.2.3.2.1.1 Test Purpose (TP)

(1)

```
with { UE in RRC_CONNECTED state with EN-DC, and, MCG(s) (E-UTRA PDCP) only having completed the
radio bearer establishment and performed the inter RAT measurement for NR cell, configured b1-
Threshold set to threshold-RSRQ and not detected entering condition for the event B1 is met }
ensure that {
  when { UE detects entering condition for the event B1 is not met }
  then { UE does not transmit any MeasurementReport }
}
```

(2)

```
with { UE in RRC_CONNECTED state with EN-DC, and, MCG(s) (E-UTRA PDCP) only having completed the
radio bearer establishment and performed the inter RAT measurement for NR cell, configured b1-
Threshold set to threshold-RSRQ and not detected entering condition for the event B1 is met }
ensure that {
  when { UE detects entering condition for the event B1 is met }
  then { UE transmits a MeasurementReport }
}
```

(3)

```
with { UE in RRC_CONNECTED state with EN-DC, and, MCG(s) (E-UTRA PDCP) only having completed the
radio bearer establishment and performed the inter RAT measurement for NR cell, configured b1-
Threshold set to threshold-RSRQ and detected entering condition for the event B1 is met }
ensure that {
  when { UE detects leaving condition for the event B1 is met }
  then { UE does not transmit any MeasurementReport }
}
```

8.2.3.2.1.2 Conformance requirements

References: The conformance requirements covered in the present TC are specified in: TS 36.331, clauses 5.5.1, 5.5.4.1, 5.5.4.7, 5.5.5.1 and 5.5.5.3. Unless otherwise stated these are Rel-15 requirements.

[TS 36.331, clause 5.5.1]

The UE reports measurement information in accordance with the measurement configuration as provided by E-UTRAN. E-UTRAN provides the measurement configuration applicable for a UE in RRC_CONNECTED by means of dedicated signalling, i.e. using the *RRCConnectionReconfiguration* or *RRCConnectionResume* message.

The UE can be requested to perform the following types of measurements:

- Intra-frequency measurements: measurements at the downlink carrier frequency(ies) of the serving cell(s).
- Inter-frequency measurements: measurements at frequencies that differ from any of the downlink carrier frequency(ies) of the serving cell(s).
- Inter-RAT measurements of NR frequencies.

...

The measurement configuration includes the following parameters:

1. **Measurement objects:** The objects on which the UE shall perform the measurements.
 - For intra-frequency and inter-frequency measurements a measurement object is a single E-UTRA carrier frequency. Associated with this carrier frequency, E-UTRAN can configure a list of cell specific offsets, a list of 'blacklisted' cells and a list of 'whitelisted' cells. Blacklisted cells are not considered in event evaluation or measurement reporting.
 - For inter-RAT NR measurements a measurement object is a single NR carrier frequency. Associated with this carrier frequency, E-UTRAN can configure a list of 'blacklisted' cells. Blacklisted cells are not considered in event evaluation or measurement reporting.

...

NOTE 1: Some measurements using the above mentioned measurement objects, only concern a single cell, e.g. measurements used to report neighbouring cell system information, PCell UE Rx-Tx time difference, or a pair of cells, e.g. SSTT measurements between the PCell and the PSCell.

2. **Reporting configurations:** A list of reporting configurations where each reporting configuration consists of the following:
 - Reporting criterion: The criterion that triggers the UE to send a measurement report. This can either be periodical or a single event description.
 - Reporting format: The quantities that the UE includes in the measurement report and associated information (e.g. number of cells to report).
3. **Measurement identities:** A list of measurement identities where each measurement identity links one measurement object with one reporting configuration. By configuring multiple measurement identities it is possible to link more than one measurement object to the same reporting configuration, as well as to link more than one reporting configuration to the same measurement object. The measurement identity is used as a reference number in the measurement report.
4. **Quantity configurations:** One quantity configuration is configured per RAT type. The quantity configuration defines the measurement quantities and associated filtering used for all event evaluation and related reporting of that measurement type. One filter can be configured per measurement quantity, except for NR where the network may configure up to 2 sets of quantity configurations each comprising per measurement quantity separate filters for cell and RS index measurement results. The quantity configuration set that applies for a given measurement is indicated within the NR measurement object.
5. **Measurement gaps:** Periods that the UE may use to perform measurements, i.e. no (UL, DL) transmissions are scheduled.

E-UTRAN only configures a single measurement object for a given frequency (except for WLAN and except for CBR measurements), i.e. it is not possible to configure two or more measurement objects for the same frequency with different associated parameters, e.g. different offsets and/ or blacklists. E-UTRAN may configure multiple instances of the same event e.g. by configuring two reporting configurations with different thresholds.

The UE maintains a single measurement object list, a single reporting configuration list, and a single measurement identities list. The measurement object list includes measurement objects, that are specified per RAT type, possibly including intra-frequency object(s) (i.e. the object(s) corresponding to the serving frequency(ies)), inter-frequency object(s) and inter-RAT objects. Similarly, the reporting configuration list includes E-UTRA and inter-RAT reporting configurations. Any measurement object can be linked to any reporting configuration of the same RAT type. Some reporting configurations may not be linked to a measurement object. Likewise, some measurement objects may not be linked to a reporting configuration.

[TS 36.331, clause 5.5.4.1]

If security has been activated successfully, the UE shall:

1> for each *measId* included in the *measIdList* within *VarMeasConfig*:

...

2> else:

...

3> else if the corresponding *measObject* concerns NR:

4> if the *reportSFTD-Meas* is set to *pSCell* in the corresponding *reportConfigInterRAT*:

5> consider the PSCell to be applicable;

4> else if the *reportSFTD-Meas* is set to *neighborCells* in the corresponding *reportConfigInterRAT*:

5> if *cellsForWhichToReportSFTD* is configured in the corresponding *measObjectNR*:

6> consider any neighbouring NR cell on the associated frequency that is included in *cellsForWhichToReportSFTD* to be applicable;

5> else:

6> consider up to 3 strongest neighbouring NR cells detected on the associated frequency to be applicable when the concerned cells are not included in the *blackCellsToAddModList* defined within the *VarMeasConfig* for this *measId*;

...

2> else if the *purpose* is included and set to *reportStrongestCells*, *reportStrongestCellsForSON*, *reportLocationSidelink* or *sensingSidelink* and if a (first) measurement result is available:

3> include a measurement reporting entry within the *VarMeasReportList* for this *measId*;

3> set the *numberOfReportsSent* defined within the *VarMeasReportList* for this *measId* to 0;

3> if the *purpose* is set to *reportStrongestCells* and *reportStrongestCSI-RSs* is not included:

4> if the *triggerType* is set to *periodical* and the corresponding *reportConfig* includes the *ul-DelayConfig*:

5> initiate the measurement reporting procedure, as specified in 5.5.5, immediately after a first measurement result is provided by lower layers;

...

4> else if the *reportAmount* exceeds 1:

5> initiate the measurement reporting procedure, as specified in 5.5.5, immediately after the quantity to be reported becomes available for the PCell;

4> else (i.e. the *reportAmount* is equal to 1):

5> initiate the measurement reporting procedure, as specified in 5.5.5, immediately after the quantity to be reported becomes available for the PCell and for the strongest cell among the applicable cells, or becomes available for the pair of PCell and the PSCell in case of SSTD measurements, or becomes available for each requested pair of PCell and NR cell or the maximal measurement reporting delay as specified in TS 38.133 [84, 8.17.2.3] in case of SFTD measurements;

...

3> else:

- 4> initiate the measurement reporting procedure, as specified in 5.5.5, when it has determined the strongest cells on the associated frequency;
- 2> upon expiry of the periodical reporting timer for this *measId*:
- 3> initiate the measurement reporting procedure, as specified in 5.5.5;
- ...

NOTE 2: The UE does not stop the periodical reporting with *triggerType* set to *event* or to *periodical* while the corresponding measurement is not performed due to the PCell RSRP being equal to or better than *s-Measure* or due to the measurement gap not being setup.

NOTE 3: If the UE is configured with DRX, the UE may delay the measurement reporting for event triggered and periodical triggered measurements until the Active Time, which is defined in TS 36.321 [6].

[TS 36.331, clause 5.5.4.7]

The UE shall:

- 1> for UTRA and CDMA2000, only trigger the event for cells included in the corresponding measurement object;
- 1> consider the entering condition for this event to be satisfied when condition B1-1, as specified below, is fulfilled;
- 1> consider the leaving condition for this event to be satisfied when condition B1-2, as specified below, is fulfilled;

Inequality B1-1 (Entering condition)

$$Mn + Ofn - Hys > Thresh$$

Inequality B1-2 (Leaving condition)

$$Mn + Ofn + Hys < Thresh$$

The variables in the formula are defined as follows:

Mn is the measurement result of the inter-RAT neighbour cell, not taking into account any offsets. For CDMA 2000 measurement result, *pilotStrength* is divided by -2.

Ofn is the frequency specific offset of the frequency of the inter-RAT neighbour cell (i.e. *offsetFreq* as defined within the *measObject* corresponding to the frequency of the neighbour inter-RAT cell).

Hys is the hysteresis parameter for this event (i.e. *hysteresis* as defined within *reportConfigInterRAT* for this event).

Thresh is the threshold parameter for this event (i.e. *b1-Threshold* as defined within *reportConfigInterRAT* for this event). For CDMA2000, *b1-Threshold* is divided by -2.

Mn is expressed in dBm or in dB, depending on the measurement quantity of the inter-RAT neighbour cell.

Ofn*, *Hys are expressed in dB.

Thresh is expressed in the same unit as ***Mn***.

[TS 36.331, clause 5.5.5.1]

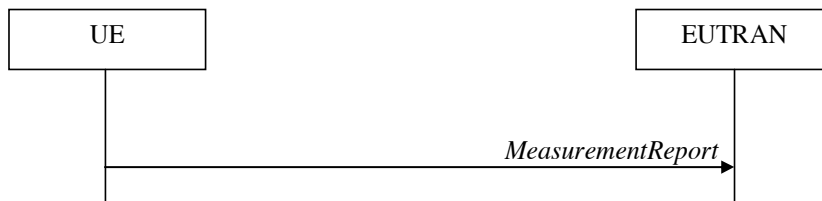

Figure 5.5.5.1-1: Measurement reporting

The purpose of this procedure is to transfer measurement results from the UE to E-UTRAN. The UE shall initiate this procedure only after successful security activation.

For the *measId* for which the measurement reporting procedure was triggered, the UE shall set the *measResults* within the *MeasurementReport* message as follows:

- 1> set the *measId* to the measurement identity that triggered the measurement reporting;
- 1> set the *measResultPCell* to include the quantities of the PCell;
- 1> set the *measResultServFreqList* to include for each E-UTRA SCell that is configured, if any, within *measResultSCell* the quantities of the concerned SCell, if available according to performance requirements in [16], except if *purpose* for the *reportConfig* associated with the *measId* that triggered the measurement reporting is set to *reportLocation*;
- 1> if the *reportConfig* associated with the *measId* that triggered the measurement reporting includes *reportAddNeighMeas*:
 - 2> for each E-UTRA serving frequency for which *measObjectId* is referenced in the *measIdList*, other than the frequency corresponding with the *measId* that triggered the measurement reporting:
 - 3> set the *measResultServFreqList* to include within *measResultBestNeighCell* the *physCellId* and the quantities of the best non-serving cell, based on RSRP, on the concerned serving frequency;
 - 1> if the *triggerType* is set to *event*; and if the corresponding *measObject* concerns NR; and if *eventId* is set to *eventB1* or *eventB2*; or
 - 1> if the *triggerType* is set to *event*; and if *eventId* is set to *eventA3* or *eventA4* or *eventA5*:
 - 2> if *purpose* for the *reportConfig* associated with the *measId* that triggered the measurement reporting is set to a value other than *reportLocation*:
 - 3> set the *measResultServFreqListNR* to include for each NR serving frequency, if any, the following:
 - 4> set *measResultSCell* to include the available results of the NR serving cell, as specified in 5.5.5.2;
 - 4> if the *reportConfig* associated with the *measId* that triggered the measurement reporting includes *reportAddNeighMeas*:
 - 5> set *measResultBestNeighCell* to include the available results, as specified in 5.5.5.2, of the best non-serving cell, ordered based on the quantity determined as specified in 5.5.5.3;
 - 5> for each (serving or neighbouring) cell for which the UE reports results according to the previous, additionally include available beam results according to the following:
 - 6> if *maxReportRS-Index* is configured, set *measResultCellRS-Index* to include available results, as specified in 5.5.5.2, of up to *maxReportRS-Index* beams, ordered based on the quantity determined as specified in 5.5.5.3;
 - 1> if there is at least one applicable neighbouring cell to report:
 - 2> set the *measResultNeighCells* to include the best neighbouring cells up to *maxReportCells* in accordance with the following:
 - 3> if the *triggerType* is set to *event*:
 - 4> include the cells included in the *cellsTriggeredList* as defined within the *VarMeasReportList* for this *measId*;
 - 3> else:
 - 4> include the applicable cells for which the new measurement results became available since the last periodical reporting or since the measurement was initiated or reset;

NOTE 1: The reliability of the report (i.e. the certainty it contains the strongest cells on the concerned frequency) depends on the measurement configuration i.e. the *reportInterval*. The related performance requirements are specified in TS 36.133 [16].

- 3> for each cell that is included in the *measResultNeighCells*, include the *physCellId*;
- 3> if the *triggerType* is set to *event*; or the *purpose* is set to *reportStrongestCells* or to *reportStrongestCellsForSON*:
- 4> for each included cell, include the layer 3 filtered measured results in accordance with the *reportConfig* for this *measId*, ordered as follows:
 - 5> if the *measObject* associated with this *measId* concerns E-UTRA:
 - 6> set the *measResult* to include the quantity(ies) indicated in the *reportQuantity* within the concerned *reportConfig* in order of decreasing *triggerQuantity*, i.e. the best cell is included first;
 - 5> if the *measObject* associated with this *measId* concerns NR:
 - 6> set the *measResultCell* to include the quantity(ies) indicated in the *reportQuantityCellNR* within the concerned *reportConfig* in order of decreasing quantity according to *BN-ThresholdYNR*, i.e. the best cell is included first;
 - 6> if *maxReportRS-Index* and *reportQuantityRS-IndexNR* are configured, set *measResultCellRS-Index* to include results of the best beam and the beams whose quantity is above *threshRS-Index* defined in the *VarMeasConfig* for the corresponding *measObject*, up to *maxReportRS-Index* beams in total, and in order of decreasing quantity, same as used for cell reporting, and as follows:
 - 7> order beams based on the sorting quantity determined as specified in 5.5.5.2;
 - 7> include *ssbIndex*;
 - 7> if *reportRS-IndexResultsNR* is configured, for each quantity indicated, include the corresponding measurement result;

[TS 36.331, clause 5.5.5.3]

When configured to report the best cells or beams, the UE shall determine the quantity that is used to order and select as follows:

- 1> consider the quantities the UE reports as candidate sorting quantities i.e. as follows:
 - 2> for NR cells for which measurement reporting is triggered (i.e. NR cells included in *cellsTriggered*):
 - 3> the quantities defined by *reportQuantityCellNR*, when used for sorting cells;
 - 3> the quantities defined by *reportQuantityRS-IndexNR*, when used for sorting beams;
 - 2> for cells on NR serving frequencies:
 - 3> the available quantities of available NR measurement results as specified in 5.5.5.2;
- 1> if *reportType* is set to *eventTriggered*; and if *eventId* is set to *eventB1* or *eventB2*:
 - 2> consider the trigger quantity to be the sorting quantity;
- 1> if *reportType* is set to *periodical*:
 - 2> if there is a single candidate sorting quantity:
 - 3> consider the concerned quantity to be the sorting quantity;
 - 2> else:
 - 3> if RSRP is one of the candidate sorting quantities;
 - 4> consider RSRP to be the sorting quantity;
 - 3> else:

4> consider RSRQ to be the sorting quantity;

8.2.3.2.1.3 Test description

8.2.3.2.1.3.1 Pre-test conditions

System Simulator:

- E-UTRA Cell 1 and NR Cell 1.

UE:

- None.

Preamble:

- The UE is in state RRC_CONNECTED using generic procedure parameter Connectivity (*EN-DC*), Bearers (*MCG(s) only*) established according to TS 38.508-1 [4], clause 4.5.4.

8.2.3.2.1.3.2 Test procedure sequence

Table 8.2.3.2.1.3.2-1 and Table 8.2.3.2.1.3.2-1A illustrates the downlink power levels and other changing parameters to be applied for the cells at various time instants of the test execution. Row marked "T0" denotes the initial conditions after preamble, while columns marked "T1" and "T2" are to be applied subsequently. The exact instants on which these values shall be applied are described in the texts in this clause.

Table 8.2.3.2.1.3.2-1: Time instances of cell power level and parameter changes for FR1

	Parameter	Unit	E-UTRA Cell 1	NR Cell 1	Remark
T0	Cell-specific RS EPRE	dBm/15 kHz	-85	-	The power level values are such that entering conditions for event B1 are not satisfied.
	SS/PBCH SSS EPRE	dBm/SC S	-	-91	
	SS-RSRQ	dB	-	-16.24	
	Noc	dBm/SC S	-	-87	
T1	Cell-specific RS EPRE	dBm/15 kHz	-85	-	The power level values are such that entering conditions for event B1 are satisfied.
	SS/PBCH SSS EPRE	dBm/SC S	-	-85	
	SS-RSRQ	dB	-	-12.91	
	Noc	dBm/SC S	-	-87	
T2	Cell-specific RS EPRE	dBm/15 kHz	-85	-	The power level values are such that leaving conditions for event B1 are satisfied.
	SS/PBCH SSS EPRE	dBm/SC S	-	-91	
	SS-RSRQ	dB	-	-16.24	
	Noc	dBm/SC S	-	-87	

Table 8.2.3.2.1.3.2-1A: Time instances of cell power level and parameter changes for FR2

	Parameter	Unit	E-UTRA Cell 1	NR Cell 1	Remark
T0	Cell-specific RS EPRE	dBm/15 kHz	FFS	-	The power level values are such that entering conditions for event B1 are not satisfied.
	SS/PBCH SSS EPRE	dBm/SC S	-	FFS	
T1	Cell-specific RS EPRE	dBm/15 kHz	FFS	-	The power level values are such that entering conditions for event B1 are satisfied.
	SS/PBCH SSS EPRE	dBm/SC S	-	FFS	
T2	Cell-specific RS EPRE	dBm/15 kHz	FFS	-	The power level values are such that leaving conditions for event B1 are satisfied.
	SS/PBCH SSS EPRE	dBm/SC S	-	FFS	

Table 8.2.3.2.1.3.2-2: Main behaviour

St	Procedure	Message Sequence		TP	Verdict
		U - S	Message		
1	The SS transmits an <i>RRCCONNECTIONRECONFIGURATION</i> including measConfig to setup inter RAT measurements and reporting for NR Cell 1.	<--	<i>RRCCONNECTIONRECONFIGURATION</i>	-	-
2	The UE transmits an <i>RRCCONNECTIONRECONFIGURATIONCOMPLETE</i> message to confirm the setup of inter RAT measurements for NR Cell 1.	-->	<i>RRCCONNECTIONRECONFIGURATIONCOMPLETE</i>	-	-
3	Check: Does the UE transmit a <i>MEASUREMENTREPORT</i> message on E-UTRA Cell 1 to report the event B1 during the next 10s?	-->	<i>MEASUREMENTREPORT</i>	1	F
4	The SS changes E-UTRA Cell 1 and NR Cell 1 parameters according to the row "T1".	-	-	-	-
5	Check: Does the UE transmit a <i>MEASUREMENTREPORT</i> message to report the event B1 for NR Cell 1?	-->	<i>MEASUREMENTREPORT</i>	2	P
6	The SS changes E-UTRA Cell 1 and NR Cell 1 parameters according to the row "T2".	-	-	-	-
7	Wait and ignore <i>MEASUREMENTREPORT</i> messages for 57s if NR Cell 1 is on FR2 frequency else wait for 15 s to allow change of power levels and UE measurements for NR Cell 1.	-	-	-	-
8	Check: Does the UE transmit a <i>MEASUREMENTREPORT</i> message on E-UTRA Cell 1 to report the event B1 during the next 10s?	-->	<i>MEASUREMENTREPORT</i>	3	F

8.2.3.2.1.3.3 Specific message contents

Table 8.2.3.2.1.3.3-1: *RRCCONNECTIONRECONFIGURATION* (step 1, Table 8.2.3.2.1.3.2-2)

Derivation Path: 36.508 [7], Table 4.6.1-8, condition MEAS
--

Table 8.2.3.2.1.3.3-2: *MeasConfig* (Table 8.2.3.2.1.3.3-1)

Derivation Path: 36.508 [7], Table 4.6.6-1			
Information Element	Value/remark	Comment	Condition
MeasConfig ::= SEQUENCE {			
measObjectToAddModList SEQUENCE (SIZE (1..maxObjectId)) OF MeasObjectToAddMod {	2 entries		
MeasObjectToAddMod[1] SEQUENCE {		entry 1	
measObjectId	IdMeasObject-f1		
measObject	MeasObjectEUTRA- GENERIC(f1)		
	MeasObjectEUTRA- GENERIC(maxEARFCN)		Band > 64
}			
MeasObjectToAddMod[2] SEQUENCE {		entry 2	
measObjectId	IdMeasObject-NRf1		
measObject	MeasObjectNR- GENERIC (NRf1)		
}			
}			
reportConfigToAddModList SEQUENCE (SIZE (1..maxReportConfigId)) OF ReportConfigToAddMod {	1 entry		
ReportConfigToAddMod[1] SEQUENCE {		entry 1	
reportConfigId	IdReportConfig-B1-NR		
reportConfig	ReportConfig-B1-NR-r15		
}			
}			
measIdToAddModList SEQUENCE (SIZE (1..maxMeasId)) OF MeasIdToAddMod {	1 entry		
MeasIdToAddMod[1] SEQUENCE {		entry 1	
measId	1		
measObjectId	IdMeasObject-NRf1		
reportConfigId	IdReportConfig-B1-NR		
}			
}			
quantityConfig	QuantityConfig- DEFAULT		
measGapConfig	MeasGapConfig		
}			

Table 8.2.3.2.1.3.3-3: *QuantityConfig-DEFAULT* (Table 8.2.3.2.1.3.3-2)

Derivation Path: 36.508 [7], Table 4.6.6-3A			
Information Element	Value/remark	Comment	Condition
QuantityConfig-DEFAULT ::= SEQUENCE {			
quantityConfigNRList-r15 SEQUENCE ((SIZE (1..maxQuantSetsNR-r15)) OF QuantityConfigNR-r15 {	1 entry		
QuantityConfigNR-r15[1] SEQUENCE {		entry 1	
measQuantityCellNR-r15 SEQUENCE {			
filterCoeff-RSRP-r15	fc4		
filterCoeff-RSRQ-r15	fc4		
}			
}			
}			
}			

Table 8.2.3.2.1.3.3-4: MeasObjectNR-GENERIC (NRf1) (Table 8.2.3.2.1.3.3-2)

Derivation Path: 36.508 [7], Table 4.6.6-2B			
Information Element	Value/remark	Comment	Condition
MeasObjectNR-GENERIC(Freq) ::= SEQUENCE {			
carrierFreq-r15	Downlink carrier frequency of NR cell 1		
}			

Table 8.2.3.2.1.3.3-5: ReportConfig-B1-NR-r15 (Table 8.2.3.2.1.3.3-2)

Derivation Path: 36.508 [7], Table 4.6.6-7AA			
Information Element	Value/remark	Comment	Condition
ReportConfig-B1-NR ::= SEQUENCE {			
triggerType CHOICE {			
event SEQUENCE {			
eventId CHOICE {			
eventB1-NR-r15 SEQUENCE{			
b1-ThresholdNR-r15 CHOICE{			
nr-RSRQ-r15	5	For FR1	
}			
}			
}			
}			
reportAmount	infinity		
reportQuantityCellNR-r15 SEQUENCE {			
ss-rsrq	true		
}			

Table 8.2.3.2.1.3.3-6: MeasurementReport (step 5, Table 8.2.3.2.1.3.2-2)

Derivation Path: 36.508 [7], Table 4.6.1-5			
Information Element	Value/remark	Comment	Condition
MeasurementReport ::= SEQUENCE {			
criticalExtensions CHOICE {			
c1 CHOICE{			
measurementReport-r8 SEQUENCE {			
measResults SEQUENCE {			
measId	1		
measResultPCell SEQUENCE {			
rsrpResult	(0..97)		
rsrqResult	(0..34)		
}			
measResultNeighCells CHOICE {			
measResultNeighCellListNR-r15 SEQUENCE (SIZE (1..maxCellReport)) OF MeasResultCellNR-r15 {	1 entry		
MeasResultCellNR-r15[1] SEQUENCE {		entry 1	
pci-r15	PhysicalCellIdentity of NR Cell 1		
measResultCell-r15 SEQUENCE {			
rsrqResult-r15	(0..127)		
}			
}			
}			
}			
}			
}			
}			
}			

Table 8.2.3.2.1.3.3-7: MeasGapConfig(Table 8.2.3.2.1.3.3-2)

Derivation Path: 36.331, clause 6.3.5			
Information Element	Value/remark	Comment	Condition
MeasGapConfig-GP2 ::= CHOICE {			
setup SEQUENCE {			
gapOffset CHOICE {			
gp1	19	TGRP = 80 ms	
}			
}			
}			

8.2.3.3 Measurement configuration control and reporting / Inter-RAT measurements / Periodic reporting / Measurement of NR cells

8.2.3.3.1 Measurement configuration control and reporting / Inter-RAT measurements / Periodic reporting / Measurement of NR cells / EN-DC

8.2.3.3.1.1 Test Purpose (TP)

(1)

```
with { UE in RRC_CONNECTED state with EN-DC, and, MCG(s) (E-UTRA PDCP) only having completed the
radio bearer establishment and performed the inter RAT measurement for NR cell }
ensure that {
  when { The UE receives reference signal power for cells on the NR frequencies where measurements
are configured }
  then { UE sends MeasurementReport message at regular intervals for these NR cells }
}
```

(2)

```
with { UE in RRC_CONNECTED state with EN-DC, and, MCG(s) (E-UTRA PDCP) only and a MeasurementReport
message for a configured periodic measurement reporting of NR cells on a configured frequency were
sent }
ensure that {
  when { A previously reported cell become unavailable and the UE receives reference signal power on
a reported NR frequency for a cell which was previously not reported }
  then { UE sends MeasurementReport message at regular intervals for the available NR cells }
}
```

(3)

```
with { UE in RRC_CONNECTED state with EN-DC, and, MCG(s) (E-UTRA PDCP) only and periodic measurement
reporting of NR cells ongoing }
ensure that {
  when { The UE receives a RRCConnectionReconfiguration message removing the measId of periodic
reporting of NR cells }
  then { UE stops sending MeasurementReport message for NR cells }
}
```

8.2.3.3.1.2 Conformance requirements

References: The conformance requirements covered in the present TC are specified in: TS 36.331, clauses 5.5.1, 5.5.4.1, 5.5.4.7 and 5.5.5.1. Unless otherwise stated these are Rel-15 requirements.

[TS 36.331, clause 5.5.1]

The UE reports measurement information in accordance with the measurement configuration as provided by E-UTRAN. E-UTRAN provides the measurement configuration applicable for a UE in RRC_CONNECTED by means of dedicated signalling, i.e. using the *RRCConnectionReconfiguration* or *RRCConnectionResume* message.

The UE can be requested to perform the following types of measurements:

- Intra-frequency measurements: measurements at the downlink carrier frequency(ies) of the serving cell(s).

- Inter-frequency measurements: measurements at frequencies that differ from any of the downlink carrier frequency(ies) of the serving cell(s).
- Inter-RAT measurements of NR frequencies.
- ...

The measurement configuration includes the following parameters:

1. **Measurement objects:** The objects on which the UE shall perform the measurements.
 - For intra-frequency and inter-frequency measurements a measurement object is a single E-UTRA carrier frequency. Associated with this carrier frequency, E-UTRAN can configure a list of cell specific offsets, a list of 'blacklisted' cells and a list of 'whitelisted' cells. Blacklisted cells are not considered in event evaluation or measurement reporting.
 - For inter-RAT NR measurements a measurement object is a single NR carrier frequency. Associated with this carrier frequency, E-UTRAN can configure a list of 'blacklisted' cells. Blacklisted cells are not considered in event evaluation or measurement reporting.
 - ...

NOTE 1: Some measurements using the above mentioned measurement objects, only concern a single cell, e.g. measurements used to report neighbouring cell system information, PCell UE Rx-Tx time difference, or a pair of cells, e.g. SSTD measurements between the PCell and the PSCell.

2. **Reporting configurations:** A list of reporting configurations where each reporting configuration consists of the following:
 - Reporting criterion: The criterion that triggers the UE to send a measurement report. This can either be periodical or a single event description.
 - Reporting format: The quantities that the UE includes in the measurement report and associated information (e.g. number of cells to report).
3. **Measurement identities:** A list of measurement identities where each measurement identity links one measurement object with one reporting configuration. By configuring multiple measurement identities it is possible to link more than one measurement object to the same reporting configuration, as well as to link more than one reporting configuration to the same measurement object. The measurement identity is used as a reference number in the measurement report.
4. **Quantity configurations:** One quantity configuration is configured per RAT type. The quantity configuration defines the measurement quantities and associated filtering used for all event evaluation and related reporting of that measurement type. One filter can be configured per measurement quantity, except for NR where the network may configure up to 2 sets of quantity configurations each comprising per measurement quantity separate filters for cell and RS index measurement results. The quantity configuration set that applies for a given measurement is indicated within the NR measurement object.
5. **Measurement gaps:** Periods that the UE may use to perform measurements, i.e. no (UL, DL) transmissions are scheduled.

E-UTRAN only configures a single measurement object for a given frequency (except for WLAN and except for CBR measurements), i.e. it is not possible to configure two or more measurement objects for the same frequency with different associated parameters, e.g. different offsets and/ or blacklists. E-UTRAN may configure multiple instances of the same event e.g. by configuring two reporting configurations with different thresholds.

The UE maintains a single measurement object list, a single reporting configuration list, and a single measurement identities list. The measurement object list includes measurement objects, that are specified per RAT type, possibly including intra-frequency object(s) (i.e. the object(s) corresponding to the serving frequency(ies)), inter-frequency object(s) and inter-RAT objects. Similarly, the reporting configuration list includes E-UTRA and inter-RAT reporting configurations. Any measurement object can be linked to any reporting configuration of the same RAT type. Some reporting configurations may not be linked to a measurement object. Likewise, some measurement objects may not be linked to a reporting configuration.

[TS 36.331, clause 5.5.4.1]

If security has been activated successfully, the UE shall:

- 1> for each *measId* included in the *measIdList* within *VarMeasConfig*:
 - ...
 - 2> else:
 - ...
 - 3> else if the corresponding *measObject* concerns NR:
 - 4> if the *reportSFTD-Meas* is set to *pSCell* in the corresponding *reportConfigInterRAT*:
 - 5> consider the PSCell to be applicable;
 - 4> else if the *reportSFTD-Meas* is set to *neighborCells* in the corresponding *reportConfigInterRAT*:
 - 5> if *cellsForWhichToReportSFTD* is configured in the corresponding *measObjectNR*:
 - 6> consider any neighbouring NR cell on the associated frequency that is included in *cellsForWhichToReportSFTD* to be applicable;
 - 5> else:
 - 6> consider up to 3 strongest neighbouring NR cells detected on the associated frequency to be applicable when the concerned cells are not included in the *blackCellsToAddModList* defined within the *VarMeasConfig* for this *measId*;
 - 4> else:
 - 5> consider any neighbouring cell detected on the associated frequency to be applicable when the concerned cell is not included in the *blackCellsToAddModList* defined within the *VarMeasConfig* for this *measId*;
 - ...
 - 2> else if the *purpose* is included and set to *reportStrongestCells*, *reportStrongestCellsForSON*, *reportLocation* or *sidelink* and if a (first) measurement result is available:
 - 3> include a measurement reporting entry within the *VarMeasReportList* for this *measId*;
 - 3> set the *numberOfReportsSent* defined within the *VarMeasReportList* for this *measId* to 0;
 - 3> if the *purpose* is set to *reportStrongestCells* and *reportStrongestCSI-RSs* is not included:
 - 4> if the *triggerType* is set to *periodical* and the corresponding *reportConfig* includes the *ul-DelayConfig*:
 - 5> initiate the measurement reporting procedure, as specified in 5.5.5, immediately after a first measurement result is provided by lower layers;
 - ...
 - 4> else if the *reportAmount* exceeds 1:
 - 5> initiate the measurement reporting procedure, as specified in 5.5.5, immediately after the quantity to be reported becomes available for the PCell;
 - 4> else (i.e. the *reportAmount* is equal to 1):
 - 5> initiate the measurement reporting procedure, as specified in 5.5.5, immediately after the quantity to be reported becomes available for the PCell and for the strongest cell among the applicable cells, or becomes available for the pair of PCell and the PSCell in case of SSTD measurements, or becomes available for each requested pair of PCell and NR cell or the maximal measurement reporting delay as specified in TS 38.133 [X, 8.17.2.3] in case of SFTD measurements;

...

3> else:

4> initiate the measurement reporting procedure, as specified in 5.5.5, when it has determined the strongest cells on the associated frequency;

2> upon expiry of the periodical reporting timer for this *measId*:

3> initiate the measurement reporting procedure, as specified in 5.5.5;

...

2> upon expiry of the T321 for this *measId*:

3> include a measurement reporting entry within the *VarMeasReportList* for this *measId*;

3> set the *numberOfReportsSent* defined within the *VarMeasReportList* for this *measId* to 0;

3> initiate the measurement reporting procedure, as specified in 5.5.5;

NOTE 2: The UE does not stop the periodical reporting with *triggerType* set to *event* or to *periodical* while the corresponding measurement is not performed due to the PCell RSRP being equal to or better than *s-Measure* or due to the measurement gap not being setup.

NOTE 3: If the UE is configured with DRX, the UE may delay the measurement reporting for event triggered and periodical triggered measurements until the Active Time, which is defined in TS 36.321 [6].

[TS 36.331, clause 5.5.5.1]

The purpose of this procedure is to transfer measurement results from the UE to E-UTRAN. The UE shall initiate this procedure only after successful security activation.

For the *measId* for which the measurement reporting procedure was triggered, the UE shall set the *measResults* within the *MeasurementReport* message as follows:

1> set the *measId* to the measurement identity that triggered the measurement reporting;

1> set the *measResultPCell* to include the quantities of the PCell;

1> set the *measResultServFreqList* to include for each E-UTRA SCell that is configured, if any, within *measResultSCell* the quantities of the concerned SCell, if available according to performance requirements in [16], except if *purpose* for the *reportConfig* associated with the *measId* that triggered the measurement reporting is set to *reportLocation*;

1> if the *reportConfig* associated with the *measId* that triggered the measurement reporting includes *reportAddNeighMeas*:

2> for each E-UTRA serving frequency for which *measObjectId* is referenced in the *measIdList*, other than the frequency corresponding with the *measId* that triggered the measurement reporting:

3> set the *measResultServFreqList* to include within *measResultBestNeighCell* the *physCellId* and the quantities of the best non-serving cell, based on RSRP, on the concerned serving frequency;

...

1> if there is at least one applicable neighbouring cell to report:

2> set the *measResultNeighCells* to include the best neighbouring cells up to *maxReportCells* in accordance with the following:

3> if the *triggerType* is set to *event*:

4> include the cells included in the *cellsTriggeredList* as defined within the *VarMeasReportList* for this *measId*;...3> else:

- 4> include the applicable cells for which the new measurement results became available since the last periodical reporting or since the measurement was initiated or reset;

NOTE 1: The reliability of the report (i.e. the certainty it contains the strongest cells on the concerned frequency) depends on the measurement configuration i.e. the *reportInterval*. The related performance requirements are specified in TS 36.133 [16].

- 3> for each cell that is included in the *measResultNeighCells*, include the *physCellId*;
- 3> if the *triggerType* is set to *event*; or the *purpose* is set to *reportStrongestCells* or to *reportStrongestCellsForSON*:
 - 4> for each included cell, include the layer 3 filtered measured results in accordance with the *reportConfig* for this *measId*, ordered as follows:
 - 5> if the *measObject* associated with this *measId* concerns E-UTRA:
 - 6> set the *measResult* to include the quantity(ies) indicated in the *reportQuantity* within the concerned *reportConfig* in order of decreasing *triggerQuantity*, i.e. the best cell is included first;
 - 5> if the *measObject* associated with this *measId* concerns NR:
 - 6> set the *measResultCell* to include the quantity(ies) indicated in the *reportQuantityCellNR* within the concerned *reportConfig* in order of decreasing quantity according to *bN-ThresholdYNR*, i.e. the best cell is included first;
 - 6> if *maxReportRS-Index* and *reportQuantityRS-IndexNR* are configured, set *measResultCellRS-Index* to include results of the best beam and the beams whose quantity is above *threshRS-Index* defined in the *VarMeasConfig* for the corresponding *measObject*, up to *maxReportRS-Index* beams in total, and in order of decreasing quantity, same as used for cell reporting, and as follows:
 - 7> order beams based on the reporting quantity determined as specified in 5.5.5.2;
 - 7> include *ssbIndex*;
 - 7> if *reportQuantityRS-IndexNR* and *reportRS-IndexResultsNR* are configured, for each quantity indicated, include the corresponding measurement result;
 - 5> if the *measObject* associated with this *measId* concerns UTRA FDD and if *ReportConfigInterRAT* includes the *reportQuantityUTRA-FDD*:
 - 6> set the *measResult* to include the quantities indicated by the *reportQuantityUTRA-FDD* in order of decreasing *measQuantityUTRA-FDD* within the *quantityConfig*, i.e. the best cell is included first;
 - 5> if the *measObject* associated with this *measId* concerns UTRA FDD and if *ReportConfigInterRAT* does not include the *reportQuantityUTRA-FDD*; or
 - 5> if the *measObject* associated with this *measId* concerns UTRA TDD, GERAN or CDMA2000:
 - 6> set the *measResult* to the quantity as configured for the concerned RAT within the *quantityConfig* in order of either decreasing quantity for UTRA and GERAN or increasing quantity for CDMA2000 *pilotStrength*, i.e. the best cell is included first;
- 1> for the cells included according to the previous (i.e. covering the PCell, the SCells, the best non-serving cells on serving frequencies as well as neighbouring EUTRA cells) include results according to the extended RSRQ if corresponding results are available according to the associated performance requirements defined in 36.133 [16];
- 1> if there is at least one applicable CSI-RS resource to report:
 - 2> set the *measResultCSI-RS-List* to include the best CSI-RS resources up to *maxReportCells* in accordance with the following:
 - 3> if the *triggerType* is set to *event*:

4> include the CSI-RS resources included in the *csi-RS-TriggeredList* as defined within the *VarMeasReportList* for this *measId*;

3> else:

4> include the applicable CSI-RS resources for which the new measurement results became available since the last periodical reporting or since the measurement was initiated or reset;

NOTE 2: The reliability of the report (i.e. the certainty it contains the strongest CSI-RS resources on the concerned frequency) depends on the measurement configuration i.e. the *reportInterval*. The related performance requirements are specified in TS 36.133 [16].

...

1> increment the *numberOfReportsSent* as defined within the *VarMeasReportList* for this *measId* by 1;

1> stop the periodical reporting timer, if running;

1> if the *numberOfReportsSent* as defined within the *VarMeasReportList* for this *measId* is less than the *reportAmount* as defined within the corresponding *reportConfig* for this *measId*:

2> start the periodical reporting timer with the value of *reportInterval* as defined within the corresponding *reportConfig* for this *measId*;

1> else:

2> if the *triggerType* is set to *periodical*:

3> remove the entry within the *VarMeasReportList* for this *measId*;

3> remove this *measId* from the *measIdList* within *VarMeasConfig*;

...

1> submit the *MeasurementReport* message to lower layers for transmission, upon which the procedure ends;

8.2.3.3.1.3 Test description

8.2.3.3.1.3.1 Pre-test conditions

System Simulator:

- E-UTRA Cell 1, NR Cell 1 and NR Cell 2.

UE:

- None.

Preamble:

- The UE is in state RRC_CONNECTED using generic procedure parameter Connectivity (*EN-DC*), Bearers (*MCG(s) only*) established according to TS 38.508-1 [4], clause 4.5.4.

8.2.3.3.1.3.2 Test procedure sequence

Table 8.2.3.3.1.3.2-1 and Table 8.2.3.3.1.3.2-1A illustrates the downlink power levels and other changing parameters to be applied for the cells at various time instants of the test execution. Row marked "T0" denotes the initial conditions after preamble, while columns marked "T1", "T2" and "T3" are to be applied subsequently. The exact instants on which these values shall be applied are described in the texts in this clause.

Table 8.2.3.3.1.3.2-1: Time instances of cell power level and parameter changes for FR1

	Parameter	Unit	E-UTRA Cell 1	NR Cell 1	NR Cell 2	Remark
T0	Cell-specific RS EPRE	dBm/15 kHz	-85	-	-	The power level values are such that camping on E-UTRA Cell 1 is guarantee.
	SS/PBCH SSS EPRE	dBm/SCS	-	Off	Off	
T1	Cell-specific RS EPRE	dBm/15 kHz	-85	-	-	The power level values are such that NR Cell 1 is satisfied for periodic reporting.
	SS/PBCH SSS EPRE	dBm/SCS	-	-91	Off	
T2	Cell-specific RS EPRE	dBm/15 kHz	-85	-	-	The power level values are such that NR Cell 2 is satisfied for periodic reporting and NR Cell 1 become unavailable.
	SS/PBCH SSS EPRE	dBm/SCS	-	Off	-91	
T3	Cell-specific RS EPRE	dBm/15 kHz	-85	-	-	The power level values are such that NR Cell 1 and NR Cell 2 are satisfied for periodic reporting.
	SS/PBCH SSS EPRE	dBm/SCS	-	-91	-91	

Table 8.2.3.3.1.3.2-1A: Time instances of cell power level and parameter changes for FR2

	Parameter	Unit	E-UTRA Cell 1	NR Cell 1	NR Cell 2	Remark
T0	Cell-specific RS EPRE	dBm/15 kHz	-96	-	-	The power level values are such that camping on E-UTRA Cell 1 is guarantee.
	SS/PBCH SSS EPRE	dBm/SCS	-	Off	Off	
T1	Cell-specific RS EPRE	dBm/15 kHz	-96	-	-	The power level values are such that NR Cell 1 is satisfied for periodic reporting.
	SS/PBCH SSS EPRE	dBm/SCS	-	-82	Off	
T2	Cell-specific RS EPRE	dBm/15 kHz	-96	-	-	The power level values are such that NR Cell 2 is satisfied for periodic reporting and NR Cell 1 become unavailable.
	SS/PBCH SSS EPRE	dBm/SCS	-	Off	-82	
T3	Cell-specific RS EPRE	dBm/15 kHz	-96	-	-	The power level values are such that NR Cell 1 and NR Cell 2 are satisfied for periodic reporting.
	SS/PBCH SSS EPRE	dBm/SCS	-	-82	-82	

Table 8.2.3.3.1.3.2-2: Main behaviour

St	Procedure	Message Sequence		TP	Verdict
		U - S	Message		
1	The SS transmits an <i>RRCCONNECTIONRECONFIGURATION</i> including measConfig to setup inter RAT measurements and reporting for NR Cell.	<--	<i>RRCCONNECTIONRECONFIGURATION</i>	-	-
2	The UE transmits an <i>RRCCONNECTIONRECONFIGURATIONCOMPLETE</i> message to confirm the setup of inter RAT measurements for NR Cell.	-->	<i>RRCCONNECTIONRECONFIGURATIONCOMPLETE</i>	-	-
3	The SS changes NR Cell y parameters according to the row "T1".	-	-	-	-
4	Wait and ignore <i>MEASUREMENTREPORT</i> messages for 57s if NR Cell 1 is on FR2 frequency else wait for 15 s to allow change of power levels and UE measurements for NR Cell 1.	-	-	-	-
5	Check: Does the UE transmit a <i>MEASUREMENTREPORT</i> message on E-UTRA Cell 1 to perform periodical reporting for NR Cell 1?	-->	<i>MEASUREMENTREPORT</i>	1	P
6	The SS changes NR Cell y parameters according to the row "T2".	-	-	-	-
7	Wait and ignore <i>MEASUREMENTREPORT</i> messages for 57s if NR Cell 1 is on FR2 frequency else wait for 15 s to allow change of power levels and UE measurements for NR Cell 2.	-	-	-	-
8	Check: Does the UE transmit a <i>MEASUREMENTREPORT</i> message on E-UTRA Cell 1 to perform periodical reporting for NR Cell 2?	-->	<i>MEASUREMENTREPORT</i>	2	P
9	The SS changes NR Cell y parameters according to the row "T3".	-	-	-	-
10	Wait and ignore <i>MEASUREMENTREPORT</i> messages for 57s if NR Cell 1 is on FR2 frequency else wait for 15 s to allow change of power levels and UE measurements for NR Cell 1 and NR Cell 2.	-	-	-	-
11	The SS transmits an <i>RRCCONNECTIONRECONFIGURATION</i> including measConfig to remove inter RAT measurements and reporting for NR Cell.	<--	<i>RRCCONNECTIONRECONFIGURATION</i>	-	-
12	The UE transmits an <i>RRCCONNECTIONRECONFIGURATIONCOMPLETE</i> message to confirm the remove of inter RAT measurements for NR Cell.	-->	<i>RRCCONNECTIONRECONFIGURATIONCOMPLETE</i>	-	-
13	Check: Does the UE transmit a <i>MEASUREMENTREPORT</i> message on E-UTRA Cell 1 to perform periodical reporting for NR Cell 1 and NR Cell 2 during the next 10s?	-->	<i>MEASUREMENTREPORT</i>	3	F

8.2.3.3.1.3.3 Specific message contents

Table 8.2.3.3.1.3.3-1: *RRCCONNECTIONRECONFIGURATION* (step 1, Table 8.2.3.3.1.3.2-2)

Derivation Path: 36.508 [7], Table 4.6.1-8, condition MEAS
--

Table 8.2.3.3.1.3.3-2: MeasConfig (Table 8.2.3.3.1.3.3-1)

Derivation Path: 36.508 [7], Table 4.6.6-1			
Information Element	Value/remark	Comment	Condition
MeasConfig ::= SEQUENCE {			
measObjectToAddModList SEQUENCE (SIZE (1..maxObjectld)) OF MeasObjectToAddMod {	1 entry		
MeasObjectToAddMod[1] SEQUENCE {		entry 1	
measObjectld	ldMeasObject-NRf1		
measObject	MeasObjectNR- GENERIC (NRf1)		
}			
}			
reportConfigToAddModList SEQUENCE (SIZE (1..maxReportConfigld)) OF ReportConfigToAddMod {	1 entry		
ReportConfigToAddMod[1] SEQUENCE {		entry 1	
reportConfigld	ldReportConfig-NR		
reportConfig	ReportConfigInterRAT- PERIODICAL-NR		
}			
}			
measldToAddModList SEQUENCE (SIZE (1..maxMeasld)) OF MeasldToAddMod {	1 entry		
MeasldToAddMod[1] SEQUENCE {		entry 1	
measld	1		
measObjectld	ldMeasObject-NRf1		
reportConfigld	ldReportConfig-NR		
}			
}			
quantityConfig	QuantityConfig- DEFAULT		
measGapConfig	MeasGapConfig		
}			

Table 8.2.3.3.1.3.3-3: QuantityConfig-DEFAULT (Table 8.2.3.3.1.3.3-2)

Derivation Path: 36.508 [7], Table 4.6.6-3A			
Information Element	Value/remark	Comment	Condition
QuantityConfig-DEFAULT ::= SEQUENCE {			
quantityConfigNRList-r15 SEQUENCE ((SIZE (1..maxQuantSetsNR-r15)) OF QuantityConfigNR-r15 {	1 entry		
QuantityConfigNR-r15[1] SEQUENCE {		entry 1	
measQuantityCellNR-r15 SEQUENCE {			
filterCoeff-RSRP-r15	fc0		
filterCoeff-RSRQ-r15	fc0		
filterCoefficient-SINR-r13	fc0		
}			
}			
}			
}			

Table 8.2.3.3.1.3.3-4: MeasObjectNR-GENERIC (NRf1) (Table 8.2.3.3.1.3.3-2)

Derivation Path: 36.508 [7], Table 4.6.6-2B			
Information Element	Value/remark	Comment	Condition
MeasObjectNR-GENERIC(Freq) ::= SEQUENCE {			
carrierFreq-r15	Downlink carrier frequency of NR cell 1		
}			

Table 8.2.3.3.1.3.3-5: ReportConfigInterRAT-PERIODICAL-NR (Table 8.2.3.3.1.3.3-2)

Derivation path: 36.508 [7], Table 4.6.6-7			
Information Element	Value/remark	Comment	Condition
ReportConfigInterRAT ReportConfigInterRAT-PERIODICAL-NR ::= SEQUENCE {			
maxReportCells	2		
reportAmount	Infinity		
reportQuantityCellNR-r15 SEQUENCE {			
ss-rsrp	true		
ss-rsrq	true		
ss-sinr	true		pc_ss_SINR_Meas
	false		
}			
}			

Table 8.2.3.3.1.3.3-6: MeasurementReport (step 5, Table 8.2.3.3.1.3.2-2)

Derivation Path: 36.508 [7], Table 4.6.1-5			
Information Element	Value/remark	Comment	Condition
MeasurementReport ::= SEQUENCE {			
criticalExtensions CHOICE {			
c1 CHOICE{			
measurementReport-r8 SEQUENCE {			
measResults SEQUENCE {			
measId	1		
measResultPCell SEQUENCE {			
rsrpResult	(0..97)		
rsrqResult	(0..34)		
}			
measResultNeighCells CHOICE {			
measResultNeighCellListNR-r15 SEQUENCE (SIZE (1..maxCellReport)) OF MeasResultCellNR-r15 {	1 entry		
MeasResultCellNR-r15[1] SEQUENCE {		entry 1	
pci-r15	PhysicalCellIdentity of NR Cell 1		
measResultCell-r15 SEQUENCE {			
rsrpResult-r15	(0..127)		
rsrqResult-r15	(0..127)		
rs-sinr-Result-r15	(0..127)		pc_ss_SINR_Meas
	Not present		
}			
}			
}			
}			
}			
}			
}			
}			
}			

Table 8.2.3.3.1.3.3-7: MeasurementReport (step 8, Table 8.2.3.3.1.3.2-2)

Derivation Path: 36.508 [7], Table 4.6.1-5			
Information Element	Value/remark	Comment	Condition
MeasurementReport ::= SEQUENCE {			
criticalExtensions CHOICE {			
c1 CHOICE{			
measurementReport-r8 SEQUENCE {			
measResults SEQUENCE {			
measId	1		
measResultPCell SEQUENCE {			
rsrpResult	(0..97)		
rsrqResult	(0..34)		
}			
measResultNeighCells CHOICE {			
measResultNeighCellListNR-r15 SEQUENCE (SIZE (1..maxCellReport)) OF MeasResultCellNR-r15 {	1 entry		
MeasResultCellNR-r15[1] SEQUENCE {		entry 1	
pci-r15	PhysicalCellIdentity of NR Cell 2		
measResultCell-r15 SEQUENCE {			
rsrpResult-r15	(0..127)		
rsrqResult-r15	(0..127)		
rs-sinr-Result-r15	(0..127)		pc_ss_SIN R_Meas
}	Not present		
}			
}			
}			
}			
}			
}			
}			

Table 8.2.3.3.1.3.3-8: MeasConfig (step 11, Table 8.2.3.3.1.3.2-2)

Derivation Path: 36.508 [7], Table 4.6.6-1			
Information Element	Value/remark	Comment	Condition
MeasConfig ::= SEQUENCE {			
measIdToRemoveList SEQUENCE (SIZE (1..maxMeasId)) OF MeasId {	1 entry		
measId[1]	1	entry 1	
}			
}			

Table 8.2.3.3.1.3.3-9: MeasGapConfig (Table 8.2.3.3.1.3.3-2)

Derivation Path: 36.508, clause 6.5.1-2			
Information Element	Value/remark	Comment	Condition
MeasGapConfig-GP2 ::= CHOICE {			
setup SEQUENCE {			
gapOffset CHOICE {			
gp1	19	TGRP = 80 ms	
}			
}			
}			

8.2.3.4 Measurement configuration control and reporting / Event A1 / Measurement of NR PSCell

8.2.3.4.1 Measurement configuration control and reporting / Event A1 / Measurement of NR PSCell / EN-DC

8.2.3.4.1.1 Test Purpose (TP)

(1)

```
with { UE in RRC_CONNECTED state in EN-DC, and, MCG(s) (E-UTRA PDCP) and SCG and measurement
configured for event A1 with event based periodical reporting }
ensure that {
  when { Serving NR cell becomes better than absolute threshold plus hysteresis }
  then {UE sends MeasurementReport message at regular intervals while entering condition for event
A1 is satisfied }
}
```

(2)

```
with { UE in RRC_CONNECTED state in EN-DC, and, MCG(s) (E-UTRA PDCP) and SCG and periodical
measurement reporting triggered by event A1 ongoing }
ensure that {
  when { Serving NR cell becomes worse than absolute threshold minus hysteresis }
  then {UE stops sending MeasurementReport message }
}
```

(3)

```
with { UE in RRC_CONNECTED state with EN-DC, and, MCG(s) (E-UTRA PDCP) and SCG and measurements are
re-configured for event A1 with event based reporting to report on leaving condition }
ensure that {
  when { Serving NR cell becomes worse than absolute threshold minus hysteresis }
  then { UE sends MeasurementReport message when leaving condition for event A1 is satisfied }
}
```

8.2.3.4.1.2 Conformance requirements

References: The conformance requirements covered in the present TC are specified in: TS 36.331:5.3.5.3; TS 38.331:5.3.5.3, 5.5.2, 5.5.4.1, 5.5.4.2 and 5.5.5.1. Unless otherwise stated these are Rel-15 requirements.

[TS 36.331, clause 5.3.5.3]

If the *RRCConnectionReconfiguration* message does not include the *mobilityControlInfo* and the UE is able to comply with the configuration included in this message, the UE shall:

...

- 1> if the received *RRCConnectionReconfiguration* includes the *nr-SecondaryCellGroupConfig*:
- 2> perform NR RRC Reconfiguration as specified in TS 38.331 [82, 5.3.5.3];

[TS 38.331, clause 5.3.5.3]

The UE shall perform the following actions upon reception of the *RRCReconfiguration*:

...

- 1> if the *RRCReconfiguration* message includes the *measConfig*:
- 2> perform the measurement configuration procedure as specified in 5.5.2.
- 1> set the content of *RRCReconfigurationComplete* message as follows:

- 2> if the *RRCReconfiguration* includes the *masterCellGroup* containing the *reportUplinkTxDirectCurrent*, or;
- 2> if the *RRCReconfiguration* includes the *secondaryCellGroup* containing the *reportUplinkTxDirectCurrent*;
- 3> include the *uplinkTxDirectCurrentList*;
- 1> if the UE is configured with E-UTRA *nr-SecondaryCellGroupConfig* (MCG is E-UTRA):
 - 2> if *RRCReconfiguration* was received via SRB1:
 - 3> submit the *RRCReconfigurationComplete* via the EUTRA MCG embedded in E-UTRA RRC message *RRCConnectionReconfigurationComplete* as specified in TS 36.331 [10];
 - 3> if *reconfigurationWithSync* was included in *spCellConfig* of an SCG:
 - 4> initiate the random access procedure on the SpCell, as specified in TS 38.321 [3];
 - 3> else:
 - 4> the procedure ends;

NOTE: The order the UE sends the *RRCConnectionReconfigurationComplete* message and performs the Random Access procedure towards the SCG is left to UE implementation.

- 2> else (*RRCReconfiguration* was received via SRB3):
 - 3> submit the *RRCReconfigurationComplete* message via SRB3 to lower layers for transmission using the new configuration;

NOTE: For EN-DC, in the case of SRB1, the random access is triggered by RRC layer itself as there is not necessarily other UL transmission. In the case of SRB3, the random access is triggered by the MAC layer due to arrival of *RRCReconfigurationComplete*.

- 1 > else:
 - 2> submit the *RRCReconfigurationComplete* message via SRB1 to lower layers for transmission using the new configuration;

[TS 38.331, clause 5.5.2.3]

The network applies the procedure as follows:

- configure a *measId* only if the corresponding measurement object, the corresponding reporting configuration and the corresponding quantity configuration, are configured;

The UE shall:

- 1> for each *measId* included in the received *measIdToAddModList*:
 - 2> if an entry with the matching *measId* exists in the *measIdList* within the *VarMeasConfig*:
 - 3> replace the entry with the value received for this *measId*;
 - 2> else:
 - 3> add a new entry for this *measId* within the *VarMeasConfig*;
 - 2> remove the measurement reporting entry for this *measId* from the *VarMeasReportList*, if included;
 - 2> stop the periodical reporting timer and reset the associated information (e.g. *timeToTrigger*) for this *measId*;

[TS 38.331, clause 5.5.4.1]

If security has been activated successfully, the UE shall:

- 1> for each *measId* included in the *measIdList* within *VarMeasConfig*:
 - 2> if the corresponding *reportConfig* includes a *reportType* set to *eventTriggered* or *periodical*;

- 3> if the corresponding *measObject* concerns NR;
 - 4> if the *eventA1* or *eventA2* is configured in the corresponding *reportConfig*:
 - 5> consider only the serving cell to be applicable;
 - ...
- 2> if the *reportType* is set to *eventTriggered* and if the leaving condition applicable for this event is fulfilled for one or more of the cells included in the *cellsTriggeredList* defined within the *VarMeasReportList* for this *measId* for all measurements after layer 3 filtering taken during *timeToTrigger* defined within the *VarMeasConfig* for this event:
 - 3> remove the concerned cell(s) in the *cellsTriggeredList* defined within the *VarMeasReportList* for this *measId*;
 - 3> if *reportOnLeave* is set to *TRUE* for the corresponding reporting configuration:
 - 4> initiate the measurement reporting procedure, as specified in 5.5.5;
- 2> upon expiry of the periodical reporting timer for this *measId*:
 - ...
 - 3> initiate the measurement reporting procedure, as specified in 5.5.5;

[TS 38.331, clause 5.5.4.2]

The UE shall:

- 1> consider the entering condition for this event to be satisfied when condition A1-1, as specified below, is fulfilled;
- 1> consider the leaving condition for this event to be satisfied when condition A1-2, as specified below, is fulfilled;
- 1> for this measurement, consider the NR serving cell corresponding to the associated *measObjectNR* associated with this event.

Inequality A1-1 (Entering condition)

$$Ms - Hys > Thresh$$

Inequality A1-2 (Leaving condition)

$$Ms + Hys < Thresh$$

The variables in the formula are defined as follows:

Ms is the measurement result of the serving cell, not taking into account any offsets.

Hys is the hysteresis parameter for this event (i.e. *hysteresis* as defined within *reportConfigNR* for this event).

Thresh is the threshold parameter for this event (i.e. *a1-Threshold* as defined within *reportConfigNR* for this event).

Ms is expressed in dBm in case of RSRP, or in dB in case of RSRQ and RS-SINR.

Hys is expressed in dB.

Thresh is expressed in the same unit as ***Ms***.

[TS 38.331, clause 5.5.5.1]



Figure 5.5.5.1-1: Measurement reporting

The purpose of this procedure is to transfer measurement results from the UE to the network. The UE shall initiate this procedure only after successful security activation.

For the *measId* for which the measurement reporting procedure was triggered, the UE shall set the *measResults* within the *MeasurementReport* message as follows:

- 1> set the *measId* to the measurement identity that triggered the measurement reporting;
- 1> set the *measResultServingCell* within *measResultServingMOList* to include RSRP, RSRQ and the available SINR for each configured serving cell derived based on the *rsType* indicated in the associated *reportConfig*;
- 1> set the *measResultServingCell* within *measResultServingMOList* to include for each NR serving cell that is configured, if any, the *servFreqId*;
- ...
- 1> increment the *numberOfReportsSent* as defined within the *VarMeasReportList* for this *measId* by 1;
- 1> stop the periodical reporting timer, if running;
- 1> if the *numberOfReportsSent* as defined within the *VarMeasReportList* for this *measId* is less than the *reportAmount* as defined within the corresponding *reportConfig* for this *measId*:
 - 2> start the periodical reporting timer with the value of *reportInterval* as defined within the corresponding *reportConfig* for this *measId*.
- 1> else:
 - 2> if the *reportType* is set to *periodical*:
 - 3> remove the entry within the *VarMeasReportList* for this *measId*;
 - 3> remove this *measId* from the *measIdList* within *VarMeasConfig*.
- 1> if the UE is configured with EN-DC:
 - 2> if SRB3 is configured:
 - 3> submit the *MeasurementReport* message via SRB3 to lower layers for transmission, upon which the procedure ends;
 - 2>else:
 - 3> submit the *MeasurementReport* message via the EUTRA MCG embedded in E-UTRA RRC message *ULInformationTransferMRDC* as specified in TS 36.331 [10].
- 1> else:
 - 2>submit the *MeasurementReport* message to lower layers for transmission, upon which the procedure ends.

8.2.3.4.1.3 Test description

System Simulator:

- EUTRA Cell 1 is the PCell and NR Cell 1 is the PSCell.

UE:

- None

Preamble:

- The UE is in state RRC_CONNECTED using generic procedure parameter Connectivity (*EN-DC*) and Bearers (*MCG(s) and SCG*) on E-UTRA Cell 1 according to TS 38.508-1 [4], clause 4.5.4.

8.2.3.4.1.3.2 Test procedure sequence

Table 8.2.3.4.1.3.2-1 and Table 8.2.3.4.1.3.2-1A illustrates the downlink power levels to be applied for NR Cell 1 at various time instants of the test execution. Row marked "T0" denotes the conditions after the preamble, while row marked "T1" are to be applied subsequently. The exact instants on which these values shall be applied are described in the texts in this clause.

Table 8.2.3.4.1.3.2-1: Time instances of cell power level and parameter changes for FR1

	Parameter	Unit	E-UTRA Cell 1	NR Cell 1	Remark
T0	Cell-specific RS EPRE	dBm/15 kHz	-85	-	Power level is such that exit condition for event A1 is satisfied $Ms < Thresh + Hys$
	SS/PBCH SSS EPRE	dBm/SCS	-	-91	
T1	Cell-specific RS EPRE	dBm/15 kHz	-85	-	Power level is such that entry condition for event A1 is satisfied $Ms - Hys > Thresh$
	SS/PBCH SSS EPRE	dBm/SCS	-	-79	

Table 8.2.3.4.1.3.2-1A: Time instances of cell power level and parameter changes for FR2

	Parameter	Unit	E-UTRA Cell 1	NR Cell 1	Remark
T0	Cell-specific RS EPRE	dBm/15 kHz	-96	-	Power level is such that $Ms < Thresh + Hys$
	SS/PBCH SSS EPRE	dBm/SCS	-	-100	
T1	Cell-specific RS EPRE	dBm/15 kHz	-96	-	Power level is such that entry condition for event A1 is satisfied $Ms - Hys > Thresh$
	SS/PBCH SSS EPRE	dBm/SCS	-	-82	

Table 8.2.3.4.1.3.2-2: Main behaviour

St	Procedure	Message Sequence		TP	Verdict
		U - S	Message		
1	The SS transmits an <i>RRCConnectionReconfiguration</i> message including nr Config to setup intra NR measurement for NR Cell 1 and reporting for event A1	<--	<i>RRCConnectionReconfiguration</i>	-	-
2	The UE transmit an <i>RRCConnectionReconfigurationComplete</i> message	-->	<i>RRCConnectionReconfigurationComplete</i>	-	-
3	SS re-adjusts the cell-specific reference signal level according to row "T1".	-	-	-	-
4	Check: Does the UE transmit a <i>MeasurementReport</i> encapsulated in <i>ULInformationTransferMRDC</i> message to report event A1 with the measured [Results] for NR Cell 1?	-->	<i>ULInformationTransferMRDC (MeasurementReport)</i>	1	P
-	EXCEPTION: Step 5 below is repeated until 3 <i>MeasurementReport</i> messages are received from the UE	-	-	-	-
5	Check: Does the UE transmit a <i>MeasurementReport</i> encapsulated in <i>ULInformationTransferMRDC</i> message, with the measured [Results] value for NR Cell 1?	-->	<i>ULInformationTransferMRDC (MeasurementReport)</i>	1	P
6	SS re-adjusts the cell-specific reference signal level according to row "T0".	-	-	-	-
7	Wait and ignore <i>MeasurementReport</i> messages for 15 s to allow change of power levels for NR Cell 1 and UE measurement.	-	-	-	-
8	Check: Does the UE transmit a <i>MeasurementReport</i> encapsulated in <i>ULInformationTransferMRDC</i> message, with the measured [Results] value for NR Cell 1 within the next 10s?	-->	<i>ULInformationTransferMRDC (MeasurementReport)</i>	2	F
9	The SS transmits an <i>RRCConnectionReconfiguration</i> message including nr Config to setup intra NR measurement for NR Cell 1 and reporting for event A1 on leaving condition.	<--	<i>RRCConnectionReconfiguration</i>	-	-
10	The UE transmit an <i>RRCConnectionReconfigurationComplete</i> message?	-->	<i>RRCConnectionReconfigurationComplete</i>	-	-
11	SS re-adjusts the cell-specific reference signal level according to row "T1" in table 8.2.3.4.1.3.2-1.	-	-	-	-
12	The UE transmit a <i>MeasurementReport</i> encapsulated in <i>ULInformationTransferMRDC</i> message to report event A1 for NR Cell 1.	-->	<i>ULInformationTransferMRDC (MeasurementReport)</i>	-	-
13	SS re-adjusts the cell-specific reference signal level according to row "T0" in table 8.2.3.4.1.3.2-1.	-	-	-	-
14	Check: Does the UE transmit a <i>MeasurementReport</i> encapsulated in <i>ULInformationTransferMRDC</i> message, with the measured [Results] value for NR Cell 1?	-->	<i>ULInformationTransferMRDC (MeasurementReport)</i>	3	P

8.2.3.4.1.3.3 Specific message contents

Table 8.2.3.4.1.3.3-1: *RRCConnectionReconfiguration* (step 1, 9, Table 8.2.3.4.1.3.2-2)

Derivation Path: 36.508 [7], Table 4.6.1-8 with condition EN-DC_EmbedNR_RRCRecon
--

Table 8.2.3.4.1.3.3-2: *RRCReconfiguration* (Table 8.2.3.4.1.3.3-1)

Derivation Path: TS 38.508-1 [4], Table [4.6.1-13] with condition EN-DC_MEAS
--

Table 8.2.3.4.1.3.3-3: MeasConfig (Table 8.2.3.4.1.3.3-2)

Derivation path: 38.508-1[4] Table 4.6.3-69			
Information Element	Value/Remark	Comment	Condition
measConfig ::= SEQUENCE {			
measObjectToAddModList SEQUENCE (SIZE (1..maxNrofObjectId)) OF MeasObjectToAddMod {	1 entry		
MeasObjectToAddMod[1] SEQUENCE {		entry 1	
measObjectId	MeasObjectId		
measObject CHOICE {			
measObjectNR	MeasObjectNR-GENERIC(72)		
}			
}			
reportConfigToAddModList SEQUENCE (SIZE (1..maxReportConfigId)) OF ReportConfigToAddMod {	1 entry		
ReportConfigToAddMod[1] SEQUENCE {		entry 1	
reportConfigId	ReportConfigId		
reportConfig	ReportConfig1-A1		FR1
	ReportConfig2-A1		FR2
}			
}			
measIdToAddModList SEQUENCE (SIZE (1..maxNrofMeasId)) OF MeasIdToAddMod {	1 entry		
MeasIdToAddMod[1] SEQUENCE {		entry 1	
measId[1]	MeasId		
measObjectId[1]	MeasObjectId		
reportConfigId[1]	ReportConfigId		
}			
}			
}			

Table 8.2.3.4.1.3.3-4: MeasObjectNR-GENERIC(72) (Table 8.2.3.4.1.3.3-3)

Derivation Path: 38.508-1 [4], Table 4.6.3-76			
Information Element	Value/remark	Comment	Condition
MeasObjectNR-GENERIC(Freq) ::= SEQUENCE {			
ssbFrequency	Downlink carrier frequency of NR cell 1		
}			

Table 8.2.3.4.1.3.3-5: ReportConfig1-A1 (Step 1, Table 8.2.3.4.1.3.3-3)

Derivation Path: 38.508-1 [4], Table 4.6.3-142 with condition EVENT_A1			
Information Element	Value/remark	Comment	Condition
ReportConfigNR ::= SEQUENCE {			
reportType CHOICE {			
eventTriggered SEQUENCE {			
eventId CHOICE {			
eventA1 SEQUENCE {			
a1-Threshold CHOICE {			
rsrp	72		
}			
hysteresis	6	3dB	
}			
reportAmount	Infinity		
}			
}			
}			

Table 8.2.3.4.1.3.3-6: RRCConnectionReconfigurationComplete (step 2, 10 Table 8.2.3.4.1.3.2-2)

Derivation Path: 36.508 [7], Table 4.6.1-9 with condition MCG_and_SCG

Table 8.2.3.4.1.3.3-7: MeasurementReport (steps 4, 5, 12, 14, Table 8.2.3.4.1.3.2-2)

Derivation Path: 38.508-1 [4], Table 4.6.1-5A			
Information Element	Value/remark	Comment	Condition
MeasurementReport ::= SEQUENCE {			
criticalExtensions CHOICE {			
measurementReport SEQUENCE {			
measResults	MeasResults		
}			
}			
}			

Table 8.2.3.4.1.3.3-8: MeasResults (Table 8.2.3.4.1.3.3-7)

Derivation Path: 38.508-1 [4], clause 4.6.3-79 with condition A1			
Information Element	Value/remark	Comment	Condition
MeasResults ::= SEQUENCE {			
measResultServingMOList SEQUENCE (SIZE (1..maxNrofServingCells)) OF MeasResultServMO {	1 entry		
MeasResultServMO[1] SEQUENCE {		entry 1	
servCellId	Cell index corresponding to NR Cell 1		
measResultServingCell SEQUENCE {			
physCellId	Physical CellID of the NR Cell 1		
measResult SEQUENCE {			
cellResults SEQUENCE {			
resultsSSB-Cell SEQUENCE {			
rsrp	(0..127)		
rsrq	(0..127)		
sinr	(0..127)		pc_ss_SINR_Meas
Not present			
}			
}			
}			
}			
}			
}			

Table 8.2.3.4.1.3.3-9: ReportConfig1-A1 (Step 9, Table 8.2.3.4.1.3.3-3)

Derivation Path: 38.508-1 [4], Table 4.6.3-142 with condition EVENT_A1			
Information Element	Value/remark	Comment	Condition
ReportConfigNR::= SEQUENCE {			
reportType CHOICE {			
eventTriggered SEQUENCE {			
eventId CHOICE {			
eventA1 SEQUENCE {			
a1-Threshold CHOICE {			
rsrp	72		
}			
reportOnLeave	True		
hysteresis	6	3dB	
}			
reportAmount	1		
}			
}			

Table 8.2.3.4.1.3.3-10: ReportConfig2-A1 (Step 1, Table 8.2.3.4.1.3.3-3)

Derivation Path: 38.508-1 [4], Table 4.6.3-142 with condition EVENT_A1			
Information Element	Value/remark	Comment	Condition
ReportConfigNR::= SEQUENCE {			
reportType CHOICE {			
eventTriggered SEQUENCE {			
eventId CHOICE {			
eventA1 SEQUENCE {			
a1-Threshold CHOICE {			
rsrp	69+delta(NRfs)		
}			
hysteresis	6	3dB	
}			
reportAmount	Infinity		
}			
}			

NOTE 1: delta(NRfs) is derived based on calibration procedure defined in the TS 38.508-1 [4], clause 6.1.3.3

Table 8.2.3.4.1.3.3-11: ReportConfig2-A1 (Step 9, Table 8.2.3.4.1.3.3-3)

Derivation Path: 38.508-1 [4], Table 4.6.3-142 with condition EVENT_A1			
Information Element	Value/remark	Comment	Condition
ReportConfigNR ::= SEQUENCE {			
reportType CHOICE {			
eventTriggered SEQUENCE {			
eventId CHOICE {			
eventA1 SEQUENCE {			
a1-Threshold CHOICE {			
rsrp	69+delta(NRfs))		
}			
reportOnLeave	True		
hysteresis	6	3dB	
}			
reportAmount	1		
}			
}			
NOTE 1: delta(NRfs) is derived based on calibration procedure defined in the TS 38.508-1 [4], clause 6.1.3.3			

8.2.3.5 Measurement configuration control and reporting / Event A2 / Measurement of NR PSCell

8.2.3.5.1 Measurement configuration control and reporting / Event A2 / Measurement of NR PSCell / EN-DC

8.2.3.5.1.1 Test Purpose (TP)

(1)

```
with { UE in RRC_CONNECTED state in EN-DC mode and measurement configured for event A2 with event
based periodical reporting }
ensure that {
  when { Serving NR cell becomes worse than absolute threshold minus hysteresis }
  then { UE sends MeasurementReport message at regular intervals while entering condition for
event A2 is satisfied }
}
```

(2)

```
with { UE in RRC_CONNECTED state in EN-DC mode and periodical measurement reporting triggered by
event A2 ongoing }
ensure that {
  when { Serving NR cell becomes better than absolute threshold plus hysteresis }
  then { UE stops sending MeasurementReport message }
}
```

8.2.3.5.1.2 Conformance requirements

References: The conformance requirements covered in the present TC are specified in: TS 36.331, clause 5.3.5.3, TS 38.331, clauses 5.3.5.3, 5.5.4.3. Unless otherwise stated these are Rel-15 requirements.

[TS 36.331, clause 5.3.5.3]

1> else:

2> if the *RRCCConnectionReconfiguration* message includes the *radioResourceConfigDedicated*:

3> perform the radio resource configuration procedure as specified in 5.3.10;

NOTE 3: If the *RRCConnectionReconfiguration* message includes the establishment of radio bearers other than SRB1, the UE may start using these radio bearers immediately, i.e. there is no need to wait for an outstanding acknowledgment of the *SecurityModeComplete* message.

...

1> if the received *RRCConnectionReconfiguration* includes the *sCellToAddModList*:

2> perform SCell addition or modification as specified in 5.3.10.3b;

[TS 38.331, clause 5.3.5.3]

1> if the *RRCReconfiguration* message includes the *measConfig*:

2> perform the measurement configuration procedure as specified in 5.5.2;

...

1> if the UE is configured with E-UTRA *nr-SecondaryCellGroupConfig* (MCG is E-UTRA):

2> if *RRCReconfiguration* was received via SRB1:

3> submit the *RRCReconfigurationComplete* via the EUTRA MCG embedded in E-UTRA RRC message *RRCConnectionReconfigurationComplete* as specified in TS 36.331 [10];

3> if *reconfigurationWithSync* was included in *spCellConfig* of an SCG:

4> initiate the random access procedure on the SpCell, as specified in TS 38.321 [3];

3> else:

4> the procedure ends;

NOTE: The order the UE sends the *RRCConnectionReconfigurationComplete* message and performs the Random Access procedure towards the SCG is left to UE implementation.

2> else (*RRCReconfiguration* was received via SRB3):

3> submit the *RRCReconfigurationComplete* message via SRB3 to lower layers for transmission using the new configuration;

NOTE: For EN-DC, in the case of SRB1, the random access is triggered by RRC layer itself as there is not necessarily other UL transmission. In the case of SRB3, the random access is triggered by the MAC layer due to arrival of *RRCReconfigurationComplete*.

1 > else:

2> submit the *RRCReconfigurationComplete* message via SRB1 to lower layers for transmission using the new configuration;

....

[TS 38.331, clause 5.5.4.3]

The UE shall:

1> consider the entering condition for this event to be satisfied when condition A2-1, as specified below, is fulfilled;

1> consider the leaving condition for this event to be satisfied when condition A2-2, as specified below, is fulfilled;

1> for this measurement, consider the primary or secondary cell that is configured on the frequency indicated in the associated *measObjectNR* to be the serving cell;

Inequality A2-1 (Entering condition)

$$M_s + H_{ys} < Thresh$$

Inequality A2-2 (Leaving condition)

$M_s - H_{ys} > Thresh$

The variables in the formula are defined as follows:

M_s is the measurement result of the serving cell, not taking into account any offsets.

H_{ys} is the hysteresis parameter for this event (i.e. *hysteresis* as defined within *reportConfigNR* for this event).

$Thresh$ is the threshold parameter for this event (i.e. *a2-Threshold* as defined within *reportConfigNR* for this event).

M_s is expressed in dBm in case of RSRP, or in dB in case of RSRQ and RS-SINR.

H_{ys} is expressed in dB.

$Thresh$ is expressed in the same unit as M_s .

8.2.3.5.1.3 Test description

8.2.3.5.1.3.1 Pre-test conditions

System Simulator:

- EUTRA Cell 1 is the PCell and NR Cell 1 is the PSCell.

UE:

- None

Preamble:

- The UE is in state RRC_CONNECTED using generic procedure parameter Connectivity (EN-DC) and DC Bearers (MCG(s) and SCG) on E-UTRA Cell 1 according to TS 38.508-1, clause 4.5.4 [4].

8.2.3.5.1.3.2 Test procedure sequence

Table 8.2.3.5.1.3.2-1 and Table 8.2.3.5.1.3.2-1A illustrates the downlink power levels to be applied for NR Cell 1 at various time instants of the test execution. Row marked "T0" denotes the conditions after the preamble, while rows marked "T1" and "T2" are to be applied subsequently. The exact instants on which these values shall be applied are described in the texts in this clause.

Table 8.2.3.5.1.3.2-1: Time instances of cell power level and parameter changes for FR1

	Parameter	Unit	EUTRA Cell 1	NR Cell 1	Remark
T0	Cell-specific RS EPRE	dBm/15 kHz	-85	-	
	SS/PBCH SSS EPRE	dBm/S CS	-	-79	Power level is such that $M_s > Thresh + H_{ys}$
T1	Cell-specific RS EPRE	dBm/15 kHz	-85	-	
	SS/PBCH SSS EPRE	dBm/S CS	-	-95	Power level is such that entry condition for event A2 is satisfied $M_s + H_{ys} < Thresh$
T2	Cell-specific RS EPRE	dBm/15 kHz	-85	-	
	SS/PBCH SSS EPRE	dBm/S CS	-	-79	Power level is such that exit condition for event A2 is satisfied $M_s > Thresh + H_{ys}$

Table 8.2.3.5.1.3.2-1A: Time instances of cell power level and parameter changes for FR2

	Parameter	Unit	EUTRA Cell 1	NR Cell 1	Remark
T0	Cell-specific RS EPRE	dBm/15 kHz	-96	-	
	SS/PBCH SSS EPRE	dBm/S CS	-	-82	Power level is such that $M_s > Thresh + Hys$
T1	Cell-specific RS EPRE	dBm/15 kHz	-96	-	
	SS/PBCH SSS EPRE	dBm/S CS	-	-100	Power level is such that entry condition for event A2 is satisfied $M_s + Hys < Thresh$
T2	Cell-specific RS EPRE	dBm/15 kHz	-96	-	
	SS/PBCH SSS EPRE	dBm/S CS	-	-82	Power level is such that exit condition for event A2 is satisfied $M_s > Thresh + Hys$

Table 8.2.3.5.1.3.2-2: Main behaviour

St	Procedure	Message Sequence		TP	Verdict
		U - S	Message		
1	The SS transmits an <i>RRCConnectionReconfiguration</i> message including <i>measConfig</i> to setup intra NR measurement for PSCell and reporting for event A2	<--	<i>RRCConnectionReconfiguration</i>	-	-
2	The UE transmits an <i>RRCConnectionReconfigurationComplete</i> message	-->	<i>RRCConnectionReconfigurationComplete</i>	-	-
3	SS re-adjusts the cell-specific reference signal level according to row "T1".	-	-	-	-
4	Check: Does the UE transmit <i>ULInformationTransferMRDC</i> message containing NR <i>MeasurementReport</i> message to report event A2 with the measured results for NR Cell 1?	-->	<i>ULInformationTransferMRDC (MeasurementReport)</i>	1	P
-	EXCEPTION: Step 5 below is repeated until 3 <i>MeasurementReport</i> messages are received from the UE	-	-	-	-
5	Check: Does the UE transmit a <i>ULInformationTransferMRDC</i> message containing NR <i>MeasurementReport</i> message to report event A2 with the measured results for NR Cell 1?	-->	<i>ULInformationTransferMRDC (MeasurementReport)</i>	1	P
6	SS re-adjusts the cell-specific reference signal level according to row "T2".	-	-	-	-
7	Wait and ignore <i>MeasurementReport</i> messages for 15 s to allow change of power levels for NR Cell 1 and UE measurement.	-	-	-	-
8	Check: Does the UE attempt to transmit an uplink message within the next 10s?	-	-	2	F

8.2.3.5.1.3.3 Specific message contents

Table 8.2.3.5.1.3.3-1: RRCConnectionReconfiguration (step 1, Table 8.2.3.5.1.3.2-2)

Derivation Path: 36.508 [7], Table 4.6.1-8 with condition EN-DC_EmbedNR_RRCRecon
--

Table 8.2.3.5.1.3.3-2: RRCReconfiguration (Table 8.2.3.5.1.3.3-1)

Derivation Path: 38.508-1 [4], Table 4.6.1-13 with condition EN-DC_MEAS

Table 8.2.3.5.1.3.3-3: MeasConfig (Table 8.2.3.5.1.3.3-2)

Derivation path: 38.508-1[4], Table 4.6.3-69			
Information Element	Value/Remark	Comment	Condition
measConfig ::= SEQUENCE {			
measObjectToAddModList SEQUENCE (SIZE (1..maxNrofObjectId)) OF MeasObjectToAddMod {	1 entry		
MeasObjectToAddMod[1] SEQUENCE {		entry 1	
measObjectId	1		
measObject CHOICE {			
measObjectNR	Downlink ARFCN of NR Cell2(68)	ssbFrequency IE equals to ARFCN of NR Cell1	
}			
}			
reportConfigToAddModList SEQUENCE (SIZE (1..maxReportConfigId)) OF ReportConfigToAddMod {	1 entry		
ReportConfigToAddMod[1] SEQUENCE {		entry 1	
reportConfigId	1		
reportConfig	ReportConfigNR1-A2		FR1
	ReportConfigNR2-A2		FR2
}			
}			
measIdToAddModList SEQUENCE (SIZE (1..maxMeasId)) OF MeasIdToAddMod {	1 entry		
MeasIdToAddMod[1] SEQUENCE {		entry 1	
measId[1]	1		
measObjectId[1]	1		
reportConfigId[1]	1		
}			
}			
}			

Table 8.2.3.5.1.3.3-4: RRCConnectionReconfigurationComplete (step 2, Table 8.2.3.5.1.3.2-2)

Derivation Path: 36.508 [7], Table 4.6.1-9 with condition MCG_and_SCG

Table 8.2.3.5.1.3.3-5: MeasurementReport (steps 4, 5, Table 8.2.3.5.1.3.2-2)

Derivation Path: TS 38.331 [6], clause 6.2.2			
Information Element	Value/remark	Comment	Condition
MeasurementReport ::= SEQUENCE {			
criticalExtensions CHOICE {			
c1 CHOICE {			
measurementReport SEQUENCE {			
measResults SEQUENCE {			
measId	1		
measResultServingMOList SEQUENCE {	1 entry		
servCellId	Cell index corresponding to NR Cell 1		
measResultServingCell SEQUENCE {			
physCellId	Physical CellID of the NR Cell 1		
measResult SEQUENCE {			
cellResults SEQUENCE {			
resultsSSB-Cell SEQUENCE {			
rsrp	(0..127)		
rsrq	(0..127)		
sinr	(0..127)		pc_ss_SINR Meas
Not present			
}			
}			
}			
}			
}			
}			
}			

Table 8.2.3.5.1.3.3-6: ReportConfigNR-A2(68) (Table 8.2.3.5.1.3.3-3)

Derivation Path: 38.508-1 [4], Table 4.6.3-142 with condition EVENT_A2			
Information Element	Value/remark	Comment	Condition
ReportConfigNR ::= SEQUENCE {			
reportType CHOICE {			
eventTriggered SEQUENCE {			
eventId CHOICE {			
reportAmount	infinity		
}			
}			
}			
}			

Table 8.2.3.5.1.3.3-7: ReportConfigNR-A2(66 + Δ (NRf1)) (Table 8.2.3.5.1.3.3-3)

Derivation Path: 38.508-1 [4], Table 4.6.3-142 with condition EVENT_A2			
Information Element	Value/remark	Comment	Condition
ReportConfigNR ::= SEQUENCE {			
reportType CHOICE {			
eventTriggered SEQUENCE {			
eventId CHOICE {			
reportAmount	infinity		
}			
}			
}			
}			
NOTE 1: Δ (NRf1) is derived based on calibration procedure defined in the TS 38.508-1 [4], clause 6.1.3.3			

8.2.3.6 Measurement configuration control and reporting / Event A3 / Measurement of Neighbour NR cells

8.2.3.6.1 Measurement configuration control and reporting / Event A3 / Measurement of Neighbour NR cells / Intra-frequency measurements / EN-DC

8.2.3.6.1.1 Test Purpose (TP)

(1)

```
with { UE in RRC_CONNECTED state with EN-DC, and, MCG(s) (E-UTRA PDCP) and SCG and measurements
configured for event A3 }
ensure that {
  when { Entry condition for event A3 is not met for neighbour NR cell }
  then { UE does not send MeasurementReport }
}
```

(2)

```
with { UE in RRC_CONNECTED state with EN-DC, and, MCG(s) (E-UTRA PDCP) and SCG and measurements
configured for event A3 }
ensure that {
  when { Neighbour NR cell becomes offset better than serving NR PSCell }
  then { UE sends MeasurementReport with correct measId for event A3 }
}
```

8.2.3.6.1.2 Conformance requirements

References: The conformance requirements covered in the present TC are specified in: TS 36.331, clause 5.3.5.3, TS 38.331, clauses 5.3.5.3, 5.5.2, 5.5.4.1, 5.5.4.4 and 5.5.5. Unless otherwise stated these are Rel-15 requirements.

[TS 36.331, clause 5.3.5.3]

If the *RRCCConnectionReconfiguration* message does not include the *mobilityControlInfo* and the UE is able to comply with the configuration included in this message, the UE shall:

- 1> if the *RRCCConnectionReconfiguration* message includes the *measConfig*:
 - 2> perform the measurement configuration procedure as specified in 5.5.2;
- 1> set the content of *RRCCConnectionReconfigurationComplete* message as follows:
 - 2> if the received *RRCCConnectionReconfiguration* message included *nr-SecondaryCellGroupConfig*:
 - 3> include *scg-ConfigResponseNR* in accordance with TS 38.331 [82], clause 5.3.5.3;
- 1> set the content of *RRCCConnectionReconfigurationComplete* message as follows:
 - 2> if the received *RRCCConnectionReconfiguration* message included *nr-SecondaryCellGroupConfig*:

- 3> include *scg-ConfigResponseNR* in accordance with TS 38.331 [82, 5.3.5.3]; 1> submit the *RRCConnectionReconfigurationComplete* message to lower layers for transmission using the new configuration, upon which the procedure ends;

[TS 38.331, clause 5.3.5.3]

The UE shall perform the following actions upon reception of the *RRCReconfiguration*:

- 1> if the *RRCReconfiguration* includes the *secondaryCellGroup*:
 - 2> perform the cell group configuration for the SCG according to 5.3.5.5;
- 1> if the *RRCReconfiguration* message includes the *measConfig*:
 - 2> perform the measurement configuration procedure as specified in 5.5.2;
 - 1> if the UE is configured with E-UTRA *nr-SecondaryCellGroupConfig* (MCG is E-UTRA):
 - 2> if *RRCReconfiguration* was received via SRB1:
 - 3> construct *RRCReconfigurationComplete* message and submit it via the EUTRA MCG embedded in E-UTRA RRC message *RRCConnectionReconfigurationComplete* as specified in TS 36.331 [10];

[TS 38.331, clause 5.5.2]

The UE shall:

- 1> if the received *measConfig* includes the *measObjectToAddModList*:
 - 2> perform the measurement object addition/modification procedure as specified in 5.5.2.5;
- 1> if the received *measConfig* includes the *reportConfigToAddModList*:
 - 2> perform the reporting configuration addition/modification procedure as specified in 5.5.2.7;
- 1> if the received *measConfig* includes the *measIdToAddModList*:
 - 2> perform the measurement identity addition/modification procedure as specified in 5.5.2.3;

[TS 38.331, clause 5.5.4.1]

If security has been activated successfully, the UE shall:

- 1> for each *measId* included in the *measIdList* within *VarMeasConfig*:
 - 2> if the corresponding *reportConfig* includes a *reportType* set to *eventTriggered* or *periodical*;
 - 3> if the corresponding *measObject* concerns NR;
 - 4> if the *eventA1* or *eventA2* is configured in the corresponding *reportConfig*:
 - 5> consider only the serving cell to be applicable;
 - 4> else:
 - 5> for events involving a serving cell associated with a *measObjectNR* and neighbours associated with another *measObjectNR*, consider any serving cell associated with the other *measObjectNR* to be a neighbouring cell as well;
 - 2> if the *reportType* is set to *eventTriggered* and if the entry condition applicable for this event, i.e. the event corresponding with the *eventId* of the corresponding *reportConfig* within *VarMeasConfig*, is fulfilled for one or more applicable cells for all measurements after layer 3 filtering taken during *timeToTrigger* defined for this event within the *VarMeasConfig*, while the *VarMeasReportList* does not include a measurement reporting entry for this *measId* (a first cell triggers the event):
 - 3> include a measurement reporting entry within the *VarMeasReportList* for this *measId*;
 - 3> set the *numberOfReportsSent* defined within the *VarMeasReportList* for this *measId* to 0;

- 3> include the concerned cell(s) in the *cellsTriggeredList* defined within the *VarMeasReportList* for this *measId*;
- 3> initiate the measurement reporting procedure, as specified in 5.5.5;
- 2> if the *reportType* is set to *eventTriggered* and if the entry condition applicable for this event, i.e. the event corresponding with the *eventId* of the corresponding *reportConfig* within *VarMeasConfig*, is fulfilled for one or more applicable cells not included in the *cellsTriggeredList* for all measurements after layer 3 filtering taken during *timeToTrigger* defined for this event within the *VarMeasConfig* (a subsequent cell triggers the event):
 - 3> set the *numberOfReportsSent* defined within the *VarMeasReportList* for this *measId* to 0;
 - 3> include the concerned cell(s) in the *cellsTriggeredList* defined within the *VarMeasReportList* for this *measId*;
 - 3> initiate the measurement reporting procedure, as specified in 5.5.5;

[TS 38.331, clause 5.5.4.4]

The UE shall:

- 1> consider the entering condition for this event to be satisfied when condition A3-1, as specified below, is fulfilled;
- 1> consider the leaving condition for this event to be satisfied when condition A3-2, as specified below, is fulfilled;
- 1> use the SpCell for *Mp*, *Ofp* and *Ocp*.

NOTE The cell(s) that triggers the event is on the frequency indicated in the associated *measObjectNR* which may be different from the frequency used by the NR SpCell.

Inequality A3-1 (Entering condition)

$$Mn + Ofn + Ocn - Hys > Mp + Ofp + Ocp + Off$$

Inequality A3-2 (Leaving condition)

$$Mn + Ofn + Ocn + Hys < Mp + Ofp + Ocp + Off$$

The variables in the formula are defined as follows:

Mn is the measurement result of the neighbouring cell, not taking into account any offsets.

Ofn is the measurement object specific offset of the neighbour cell (i.e. *offsetMO* as defined within *measObjectNR* corresponding to the frequency of the neighbour cell).

Ocn is the cell specific offset of the neighbour cell (i.e. *cellIndividualOffset* as defined within *measObjectNR* corresponding to the frequency of the neighbour cell), and set to zero if not configured for the neighbour cell.

Mp is the measurement result of the SpCell, not taking into account any offsets.

Ofp is the measurement object specific offset of the frequency of the SpCell (i.e. *offsetMO* as defined within *measObjectNR* corresponding to the frequency of the SpCell).

Ocp is the cell specific offset of the SpCell (i.e. *cellIndividualOffset* as defined within *measObjectNR* corresponding to the frequency of the SpCell), and is set to zero if not configured for the SpCell.

Hys is the hysteresis parameter for this event (i.e. *hysteresis* as defined within *reportConfigNR* for this event).

Off is the offset parameter for this event (i.e. *a3-Offset* as defined within *reportConfigNR* for this event).

Mn, **Mp** are expressed in dBm in case of RSRP, or in dB in case of RSRQ and RS-SINR.

Ofn, **Ocn**, **Ofp**, **Ocp**, **Hys**, **Off** are expressed in dB.

[TS 38.331, clause 5.5.5]

For the *measId* for which the measurement reporting procedure was triggered, the UE shall set the *measResults* within the *MeasurementReport* message as follows:

- 1> set the *measId* to the measurement identity that triggered the measurement reporting;
- 1> for each serving cell configured with *servingCellMO*:
 - 2> if the *reportConfig* associated with the *measId* that triggered the measurement reporting includes *rsType*:
 - 3> if the serving cell measurements based on the *rsType* included in the *reportConfig* that triggered the measurement report are available:
 - 4> set the *measResultServingCell* within *measResultServingMOList* to include RSRP, RSRQ and the available SINR of the serving cell, derived based on the *rsType* included in the *reportConfig* that triggered the measurement report;
- 1> set the *servCellId* within *measResultServingMOList* to include each NR serving cell that is configured with *servingCellMO*, if any;
- ...
- 1> if there is at least one applicable neighbouring cell to report:
 - 2> if the *reportType* is set to *eventTriggered* or *periodical*:
 - 3> set the *measResultNeighCells* to include the best neighbouring cells up to *maxReportCells* in accordance with the following:
 - 4> if the *reportType* is set to *eventTriggered*:
 - 5> include the cells included in the *cellsTriggeredList* as defined within the *VarMeasReportList* for this *measId*;
 - 4> else:
 - ...
 - 4> for each cell that is included in the *measResultNeighCells*, include the *physCellId*;
 - 4> if the *reportType* is set to *eventTriggered* or *periodical*:
 - 5> for each included cell, include the layer 3 filtered measured results in accordance with the *reportConfig* for this *measId*, ordered as follows:
 - 6> if the *measObject* associated with this *measId* concerns NR:
 - 7> if *rsType* in the associated *reportConfig* is set to *ssb*:
 - 8> set *resultsSSB-Cell* within the *measResult* to include the SS/PBCH block based quantity(ies) indicated in the *reportQuantityCell* within the concerned *reportConfig*, in decreasing order of the sorting quantity, determined as specified in 5.5.5.3, i.e. the best cell is included first;
 - 7> else if *rsType* in the associated *reportConfig* is set to *csi-rs*:
 - ...
 - 1> if the UE is configured with EN-DC:
 - 2> if SRB3 is configured:
 - 3> submit the *MeasurementReport* message via SRB3 to lower layers for transmission, upon which the procedure ends;
 - 2>else:
 - 3> submit the *MeasurementReport* message via the EUTRA MCG embedded in E-UTRA RRC message *ULInformationTransferMRDC* as specified in TS 36.331 [10].

1> else:

2>submit the *MeasurementReport* message to lower layers for transmission, upon which the procedure ends.

8.2.3.6.1.3 Test description

8.2.3.6.1.3.1 Pre-test conditions

System Simulator:

- EUTRA Cell 1 is the PCell and NR Cell 1 is the PS Cell.
- NR Cell 2 is the intra-frequency neighbour cell.

UE:

- None

Preamble:

- The UE is in state RRC_CONNECTED in EN-DC mode and DC Bearers (MCG and SCG) on E-UTRA Cell 1 according to TS 38.508-1 [4].

8.2.3.6.1.3.2 Test procedure sequence

Table 8.2.3.6.1.3.2-1 and Table 8.2.3.6.1.3.2-1A illustrates the downlink power levels to be applied for NR Cell 1 and NR Cell 2 at various time instants of the test execution. Row marked "T0" denotes the conditions after the preamble, while rows marked "T1" is to be applied subsequently. The exact instants on which these values shall be applied are described in the texts in this clause.

Table 8.2.3.6.1.3.2-1: Time instances of cell power level and parameter changes for FR1

	Parameter	Unit	EUTRA Cell 1	NR Cell 1	NR Cell 2		Remark
T0	Cell-specific RS EPRE	dBm/15 kHz	-85	-	-		Power levels are such that entry condition for event A3 is not satisfied for any of the neighbour NR cells: $Mn + Ofn + Ocn - Hys > Mp + Ofp + Ocp + Off$
	SS/PBCH SSS EPRE	dBm/S CS	-	-85	-91		
T1	Cell-specific RS EPRE	dBm/15 kHz	-85	-	-		Power levels are such that entry condition for event A3 is satisfied for intra-frequency neighbour NR cell (<i>measId 1</i>): $Mn + Ofn + Ocn - Hys > Ms + OfS + Ocs + Off$
	SS/PBCH SSS EPRE	dBm/S CS	-	-85	-79		

Table 8.2.3.6.1.3.2-1A: Time instances of cell power level and parameter changes for FR2

	Parameter	Unit	EUTRA Cell 1	NR Cell 1	NR Cell 2		Remark
T0	Cell-specific RS EPRE	dBm/15 kHz	-96	-	-		Power levels are such that entry condition for event A3 is not satisfied for any of the neighbour NR cells: $Mn + Ofn + Ocn - Hys > Mp + Ofp + Ocp + Off$
	SS/PBCH SSS EPRE	dBm/S CS	-	-91	-100		
T1	Cell-specific RS EPRE	dBm/15 kHz	-96	-	-		Power levels are such that entry condition for event A3 is satisfied for intra-frequency neighbour NR cell (<i>measId 1</i>): $Mn + Ofn + Ocn - Hys > Ms + OfS + Ocs + Off$
	SS/PBCH SSS EPRE	dBm/S CS	-	-91	-82		

Table 8.2.3.6.1.3.2-2: Main behaviour

St	Procedure	Message Sequence		TP	Verdict
		U - S	Message		
1	The SS transmits an <i>RRCConnectionReconfiguration</i> message containing NR <i>RRCReconfiguration</i> to setup measurements for neighbour NR Cells and reporting for event A3	<--	<i>RRCConnectionReconfiguration (RRCReconfiguration)</i>	-	-
2	Check: Does the UE transmit an <i>RRCConnectionReconfigurationComplete</i> message containing NR <i>RRCReconfigurationComplete</i> message?	-->	<i>RRCConnectionReconfigurationComplete (RRCReconfigurationComplete)</i>	-	-
3	Check: Does the UE transmit an <i>ULInformationTransferMRDC</i> message containing NR <i>MeasurementReport</i> message within the next 10s to report event A3?	-->	<i>ULInformationTransferMRDC (MeasurementReport)</i>	1	F
4	The SS re-adjusts the cell-specific reference signal level according to row "T1".	-	-	-	-
5	Check: Does the UE transmit an <i>ULInformationTransferMRDC</i> message containing NR <i>MeasurementReport</i> message to report event A3 (<i>measId 1</i>) with the measured value for NR Cell 2?	-->	<i>ULInformationTransferMRDC (MeasurementReport)</i>	2	P

8.2.3.6.1.3.3 Specific message contents

Table 8.2.3.6.1.3.3-1: *RRCConnectionReconfiguration* (step 1, Table 8.2.3.6.1.3.2-2)

Derivation Path: 36.508 [7], Table 4.6.1-8 with condition EN-DC_EmbedNR_RRCRecon
--

Table 8.2.3.6.1.3.3-2: *RRCReconfiguration* (Table 8.2.3.6.1.3.3-1)

Derivation Path: 38.508-1 [4], Table 4.6.1-13 with condition EN-DC_MEAS

Table 8.2.3.6.1.3.3-3: MeasConfig-A3 (Table 8.2.3.6.1.3.3-2)

Derivation Path: 38.508-1 [4], Table 4.6.3-69			
Information Element	Value/remark	Comment	Condition
MeasConfig ::= SEQUENCE {			
measObjectToAddModList	MeasObjectNRAddMod		
ReportConfigToAddModList SEQUENCE (SIZE (1..maxReportConfigId)) OF ReportConfigToAddMod {			
ReportConfigToAddMod[1] SEQUENCE {		entry 1	
reportConfigId	ReportConfigId		
reportConfig CHOICE {			
reportConfigNR	ReportConfigNR(2) Same as TS 38.508-1 [4], Table 4.6.3-142 except for reportAmount set to 'r1'	a3-Offset value set to 1 dB (2*0.5 dB)	EVENT_A3
}			
}			
MeasIdToAddModList ::= SEQUENCE (SIZE (1..maxNrofMeasId)) OF MeasIdToAddMod {	1 entry		
MeasIdToAddMod[1] SEQUENCE {		entry 1	
measId	1		
measObjectId	1		
reportConfigId	1		
}			
}			
}			

Table 8.2.3.6.1.3.3-4: MeasObjectNRAddMod (Table 8.2.3.6.1.3.3-3)

Derivation Path: 38.508-1 [4], Table 4.6.3-76			
Information Element	Value/remark	Comment	Condition
measObjectToAddModList ::= SEQUENCE (SIZE (1..maxNrofObjectId)) OF MeasObjectToAddMod {	1 entry		
MeasObjectToAddMod[1] SEQUENCE {		entry 1	
measObjectId	1		
measObject CHOICE {			
measObjectNR	MeasObjectNR(59)	ssbFrequency IE equals the ARFCN for NR Cell 2 Thresh value set to -97dBm	
}			
}			
}			

Table 8.2.3.6.1.3.3-5: RRCConnectionReconfigurationComplete (step 2, Table 8.2.3.6.1.3.2-2)

Derivation Path: 36.508 [7], Table 4.6.1-9 with condition MCG_and_SCG

8.2.3.6.1a Measurement configuration control and reporting / Event A3 / Measurement of Neighbor NR cell / Inter-frequency measurements / EN-DC

8.2.3.6.1a.1 Test Purpose (TP)

(1)
 with { UE in RRC_CONNECTED state with EN-DC, and, MCG(s) (E-UTRA PDCP) and SCG and inter-frequency measurements configured for event A3 }
 ensure that {
 when { Entry condition for event A3 is not met for neighbour NR cell }
 then { UE does not send MeasurementReport }
 }

(2)
 with { UE in RRC_CONNECTED state with EN-DC, and, MCG(s) (E-UTRA PDCP) and SCG and inter-frequency measurements configured for event A3 }
 ensure that {
 when { Neighbour NR cell becomes offset better than serving NR PSCell }
 then { UE sends MeasurementReport with correct measId for event A3 }
 }

8.2.3.6.1a.2 Conformance requirements

Same as test case 8.2.3.6.1 with the following difference:

[TS 36.331, clause 5.5.2.9]

The UE shall:

1> if *measGapConfig* is set to *setup*:

...

2> if EN-DC is configured:

3> if the UE is configured with *fr1-Gap* set to *TRUE*:

4> apply the gap configuration for LTE serving cells and for NR serving cells on FR1;

3> else:

4> apply the gap configuration for all LTE and NR serving cells;

Test description

8.2.3.6.1a.3.1 Pre-test conditions

Same as test case 8.2.3.6.1 with the following differences:

- Cells configuration: NR Cell 3 replaces NR Cell 2.

8.2.3.6.1a.3.2 Test procedure sequence

Same as test case 8.2.3.6.1 with the following differences:

- Cells configuration: NR Cell 3 replaces NR Cell 2.

8.2.3.6.1a.3.3 Specific message contents

Same as test case 8.2.3.6.1 with the following differences:

- Cells configuration: NR Cell 3 replaces NR Cell 2.

Table 8.2.3.6.1a.3.3-0: RRCConnectionReconfiguration (step 1, Table 8.2.3.6.1.3.2-2)

Derivation Path: 36.508 [7], Table 4.6.1-8 with condition EN-DC_EmbedNR_RRCRecon			
Information Element	Value/remark	Comment	Condition
RRCConnectionReconfiguration ::= SEQUENCE {			
criticalExtensions CHOICE {			
c1 CHOICE{			
rrcConnectionReconfiguration-r8 SEQUENCE {			
measConfig	Table 8.2.3.6.1a.3.3-0a		
}			
}			
}			

Table 8.2.3.6.1a.3.3-0a: measConfig (Table 8.2.3.6.1a.3.3-0)

Derivation Path: 36.508 [7], Table 4.6.6-1			
Information Element	Value/remark	Comment	Condition
measConfig ::= SEQUENCE {			
measGapConfig CHOICE {			
setup SEQUENCE {			
gapOffset CHOICE {			
gp0	9	MGRP = 40 ms, MGL = 6 ms	
}			
}			
fr1-gap-r15	False		
mgta-r15	False		
}			

Table 8.2.3.6.1a.3.3-1: *MeasConfig-A3* (Table 8.2.3.6.1.3.3-2)

Derivation Path: 38.508-1 [4] Table 4.6.3-69			
Information Element	Value/remark	Comment	Condition
MeasConfig ::= SEQUENCE {			
measObjectToAddModList SEQUENCE (SIZE (1..maxNrofMeasId)) OF MeasObjectToAddMod {	2 entries		
MeasObjectToAddMod[1] SEQUENCE {		entry 1	
measObjectId	1		
measObject CHOICE {			
measObjectNR	MeasObjectNR-f1	Table 8.2.3.6.1a.3.3-2	
}			
}			
MeasObjectToAddMod[2] SEQUENCE {		entry 2	
measObjectId	2		
measObject CHOICE {			
measObjectNR	MeasObjectNR-f2	Table 8.2.3.6.1a.3.3-3	
}			
}			
reportConfigToAddModList SEQUENCE(SIZE (1..maxReportConfigId)) OF ReportConfigToAddMod {	1 entry		
ReportConfigToAddMod[1] SEQUENCE {		entry 1	
reportConfigId	1		
reportConfig CHOICE {			
reportConfigNR	ReportConfigNR(2) Same as TS 38.508-1 Table 4.6.3-142 except for reportAmount set to 'r1'	a3-Offset Thresh value set to -1 dB (2*0.5 dB)	EVENT_A3 AND FR1
}	ReportConfigNR(2+ Delta(NRf ₂) - Delta(NRf ₁)) Same as TS 38.508-1 [4], Table 4.6.3-142 except for reportAmount set to 'r1'	a3-Offset value set to (2+ Delta(NRf ₂) - Delta(NRf ₁)). (Note 1)	EVENT_A3 AND FR2
}			
}			
measIdToAddModList SEQUENCE (SIZE (1..maxNrofMeasId)) OF MeasIdToAddMod {	1 entry		
MeasIdToAddMod[1] SEQUENCE {		entry 1	
measId	1		
measObjectId	2		
reportConfigId	1		
}			
}			
Note 1: Delta(NRf ₂) and Delta(NRf ₁) are derived based on calibration procedure defined in the TS 38.508-1 [4], clause 6.1.3.3.			

Table 8.2.3.6.1a.3.3-2: *MeasObjectNR-f1* (Table 8.2.3.6.1a.3.3-1)

Derivation Path: TS 38.508-1 [4], Table 4.6.3-76			
Information Element	Value/remark	Comment	Condition
MeasObjectNR ::= SEQUENCE {			
ssbFrequency	ARFCN-ValueNR for SSB of NR Cell 1		
absThreshSS-BlocksConsolidation	Not present		
nrofSS-BlocksToAverage	Not present		
}			

Table 8.2.3.6.1a.3.3-3: MeasObjectNR-f2 (Table 8.2.3.6.1a.3.3-1)

Derivation Path: TS 38.508-1 [4], Table 4.6.3-76			
Information Element	Value/remark	Comment	Condition
MeasObjectNR ::= SEQUENCE {			
ssbFrequency	ARFCN-ValueNR for SSB of NR Cell 3		
absThreshSS-BlocksConsolidation	Not present		
nrofSS-BlocksToAverage	Not present		
}			

8.2.3.6.1b Measurement configuration control and reporting / Event A3 / Measurement of Neighbor NR cell / Inter-band measurements / EN-DC

8.2.3.6.1b.1 Test Purpose (TP)

(1)
with { UE in RRC_CONNECTED state with EN-DC, and, MCG(s) (E-UTRA PDCP) and SCG and inter-band measurements configured for event A3 }
ensure that {
 when { Entry condition for event A3 is not met for neighbour NR cell }
 then { UE does not send MeasurementReport }
}

(2)
with { UE in RRC_CONNECTED state with EN-DC, and, MCG(s) (E-UTRA PDCP) and SCG and inter-band measurements configured for event A3 }
ensure that {
 when { Neighbour NR cell becomes offset better than serving NR PCell }
 then { UE sends MeasurementReport with correct measId for event A3 }
}

8.2.3.6.1b.2 Conformance requirements

Same as test case 8.2.3.6.1 with the following difference:

[TS 36.331, clause 5.5.2.9]

The UE shall:

1> if *measGapConfig* is set to *setup*:

...

2> if EN-DC is configured:

3> if the UE is configured with *fr1-Gap* set to *TRUE*:

4> apply the gap configuration for LTE serving cells and for NR serving cells on FR1;

3> else:

4> apply the gap configuration for all LTE and NR serving cells;

...

8.2.3.6.1b.3 Test description

8.2.3.6.1b.3.1 Pre-test conditions

Same as test case 8.2.3.6.1 with the following differences:

- Cells configuration: NR Cell 10 replaces NR Cell 2.

8.2.3.6.1b.3.2 Test procedure sequence

Same as test case 8.2.3.6.1 with the following differences:

- Cells configuration: NR Cell 10 replaces NR Cell 2.

8.2.3.6.1b.3.3 Specific message contents

Same as test case 8.2.3.6.1 with the following differences:

- Cells configuration: NR Cell 10 replaces NR Cell 2.

Table 8.2.3.6.1b.3.3-0: RRCConnectionReconfiguration (step 1, Table 8.2.3.6.1.3.2-2)

Derivation Path: 36.508 [7], Table 4.6.1-8 with condition EN-DC_EmbedNR_RRCRecon			
Information Element	Value/remark	Comment	Condition
RRCConnectionReconfiguration ::= SEQUENCE {			
criticalExtensions CHOICE {			
c1 CHOICE{			
rrcConnectionReconfiguration-r8 SEQUENCE {			
measConfig	Table 8.2.3.6.1b.3.3-0a		
}			
}			
}			
}			

Table 8.2.3.6.1b.3.3-0a: measConfig (Table 8.2.3.6.1b.3.3-0)

Derivation Path: 36.508 [7], Table 4.6.6-1			
Information Element	Value/remark	Comment	Condition
measConfig ::= SEQUENCE {			
measGapConfig CHOICE {			
setup SEQUENCE {			
gapOffset CHOICE {			
gp0	9	MGRP = 40 ms, MGL = 6 ms	
}			
}			
}			
fr1-gap-r15	False		
mgta-r15	False		
}			

Table 8.2.3.6.1b.3.3-1: *MeasConfig-A3* (Table 8.2.3.6.1.3.3-2)

Derivation Path: 38.508-1 [4] Table 4.6.3-69			
Information Element	Value/remark	Comment	Condition
MeasConfig ::= SEQUENCE {			
measObjectToAddModList SEQUENCE (SIZE (1..maxNrofMeasId)) OF MeasObjectToAddMod {	2 entries		
MeasObjectToAddMod[1] SEQUENCE {		entry 1	
measObjectId	1		
measObject CHOICE {			
measObjectNR	MeasObjectNR-f1	Table 8.2.3.6.1b.3.3-2	
}			
}			
MeasObjectToAddMod[2] SEQUENCE {		entry 2	
measObjectId	2		
measObject CHOICE {			
measObjectNR	MeasObjectNR-f2	Table 8.2.3.6.1b.3.3-3	
}			
}			
reportConfigToAddModList SEQUENCE(SIZE (1..maxReportConfigId)) OF ReportConfigToAddMod {	1 entry		
ReportConfigToAddMod[1] SEQUENCE {		entry 1	
reportConfigId	1		
reportConfig CHOICE {			
reportConfigNR	ReportConfigNR(2) Same as TS 38.508-1 Table 4.6.3-107 except for reportAmount set to 'r1'	a3-Offset Thresh value set to -1 dB (2*0.5 dB)	EVENT_A3
}			
}			
}			
measIdToAddModList SEQUENCE (SIZE (1..maxNrofMeasId)) OF MeasIdToAddMod {	1 entry		
MeasIdToAddMod[1] SEQUENCE {		entry 1	
measId	1		
measObjectId	2		
reportConfigId	1		
}			
}			
}			

Table 8.2.3.6.1b.3.3-2: *MeasObjectNR-f1* (Table 8.2.3.6.1b.3.3-1)

Derivation Path: TS 38.508-1 [4], Table 4.6.3-76			
Information Element	Value/remark	Comment	Condition
MeasObjectNR ::= SEQUENCE {			
ssbFrequency	ARFCN-ValueNR for SSB of NR Cell 1		
absThreshSS-BlocksConsolidation	Not present		
nrofSS-BlocksToAverage	Not present		
}			

Table 8.2.3.6.1b.3.3-3: *MeasObjectNR-f2* (Table 8.2.3.6.1b.3.3-1)

Derivation Path: TS 38.508-1 [4], Table 4.6.3-76			
Information Element	Value/remark	Comment	Condition
MeasObjectNR ::= SEQUENCE {			
ssbFrequency	ARFCN-ValueNR for SSB of NR Cell 10		
absThreshSS-BlocksConsolidation	Not present		
nrofSS-BlocksToAverage	Not present		
}			

8.2.3.7 Measurement configuration control and reporting / Event A4 (intra-frequency, inter-frequency and inter-band measurements) / Measurement of Neighbour NR cell

8.2.3.7.1 Measurement configuration control and reporting / Event A4 / Measurement of Neighbour NR cell / Intra-frequency measurements / EN-DC

8.2.3.7.1.1 Test Purpose (TP)

(1)

```
with { UE in RRC_CONNECTED state with EN-DC, and, MCG(s) (E-UTRA PDCP) and SCG and measurement
configured for event A4 with event based periodical reporting }
ensure that {
  when { Neighbour NR cell becomes better than absolute threshold }
    then { UE sends MeasurementReport message at regular intervals while entering condition for
event A4 is satisfied }
}
```

(2)

```
with { UE in RRC_CONNECTED state with EN-DC, and, MCG(s) (E-UTRA PDCP) and SCG and periodical
measurement reporting triggered by event A4 ongoing }
ensure that {
  when { Neighbour NR cell becomes worse than absolute threshold }
    then { UE stops sending MeasurementReport message }
}
```

8.2.3.7.1.2 Conformance requirements

References: The conformance requirements covered in the current TC are specified in: TS 36.331, clause 5.3.5.3, and TS 38.331, clause 5.3.5.3, 5.5.2.1, 5.5.4.1, 5.5.4.5 and 5.5.5.1. Unless otherwise stated these are Rel-15 requirements.

[TS 36.331, clause 5.3.5.3]

If the *RRCConnectionReconfiguration* message does not include the *mobilityControlInfo* and the UE is able to comply with the configuration included in this message, the UE shall:

...

1> if the received *RRCConnectionReconfiguration* includes the *nr-SecondaryCellGroupConfig*:

2> perform NR RRC Reconfiguration as specified in TS 38.331 [82, 5.3.5.3];

...

1> set the content of *RRCConnectionReconfigurationComplete* message as follows:

...

2> if the received *RRCConnectionReconfiguration* message included *nr-SecondaryCellGroupConfig*:

3> include *scg-ConfigResponseNR* in accordance with TS 38.331 [82, 5.3.5.3];

- 1> submit the *RRCConnectionReconfigurationComplete* message to lower layers for transmission using the new configuration, upon which the procedure ends;

[TS 38.331, clause 5.3.5.3]

The UE shall perform the following actions upon reception of the *RRCReconfiguration*:

- 1> if the *RRCReconfiguration* includes the *secondaryCellGroup*:
 - 2> perform the cell group configuration for the SCG according to 5.3.5.5;
- ...
- 1> if the *RRCReconfiguration* message includes the *measConfig*:
 - 2> perform the measurement configuration procedure as specified in 5.5.2;
- ...
- 1> if the UE is configured with E-UTRA *nr-SecondaryCellGroupConfig* (MCG is E-UTRA):
 - 2> if *RRCReconfiguration* was received via SRB1:
 - 3> submit the *RRCReconfigurationComplete* via the EUTRA MCG embedded in E-UTRA RRC message *RRCConnectionReconfigurationComplete* as specified in TS 36.331 [10];

[TS 38.331, clause 5.5.2.1]

The network applies the procedure as follows:

- to ensure that, whenever the UE has a *measConfig*, it includes a *measObject* for the SpCell and for each NR SCell to be measured;
- to configure at most one measurement identity using a reporting configuration with the *reportType* set to *reportCGI*;
- to ensure that, for all SSB based reporting configurations have at most one measurement object with the same *ssbFrequency* and *ssbSubcarrierSpacing*;

The UE shall:

- ...
- 1> if the received *measConfig* includes the *measObjectToAddModList*:
 - 2> perform the measurement object addition/modification procedure as specified in 5.5.2.5;
- ...
- 1> if the received *measConfig* includes the *reportConfigToAddModList*:
 - 2> perform the reporting configuration addition/modification procedure as specified in 5.5.2.7;
- ...
- 1> if the received *measConfig* includes the *measIdToAddModList*:
 - 2> perform the measurement identity addition/modification procedure as specified in 5.5.2.3;
- 1> if the received *measConfig* includes the *measGapConfig*:
 - 2> perform the measurement gap configuration procedure as specified in 5.5.2.9;

[TS 38.331, clause 5.5.4.1]

If security has been activated successfully, the UE shall:

- 1> for each *measId* included in the *measIdList* within *VarMeasConfig*:

- 2> if the corresponding *reportConfig* includes a *reportType* set to *eventTriggered* or *periodical*;
 - 3> if the corresponding *measObject* concerns NR;
 - 4> if the *eventA1* or *eventA2* is configured in the corresponding *reportConfig*;
 - 5> consider only the serving cell to be applicable;
 - 4> else:
 - 5> for events involving a serving cell associated with a *measObjectNR* and neighbours associated with another *measObjectNR*, consider any serving cell associated with the other *measObjectNR* to be a neighbouring cell as well;
 - 5> if *useWhiteCellList* is set to TRUE:
 - ...
 - 5> else:
 - 6> consider any neighbouring cell detected based on parameters in the associated *measObjectNR* to be applicable when the concerned cell is not included in the *blackCellsToAddModList* defined within the *VarMeasConfig* for this *measId*;
- 2> if the *reportType* is set to *eventTriggered* and if the entry condition applicable for this event, i.e. the event corresponding with the *eventId* of the corresponding *reportConfig* within *VarMeasConfig*, is fulfilled for one or more applicable cells for all measurements after layer 3 filtering taken during *timeToTrigger* defined for this event within the *VarMeasConfig*, while the *VarMeasReportList* does not include a measurement reporting entry for this *measId* (a first cell triggers the event):
 - 3> include a measurement reporting entry within the *VarMeasReportList* for this *measId*;
 - 3> set the *numberOfReportsSent* defined within the *VarMeasReportList* for this *measId* to 0;
 - 3> include the concerned cell(s) in the *cellsTriggeredList* defined within the *VarMeasReportList* for this *measId*;
 - 3> initiate the measurement reporting procedure, as specified in 5.5.5;
- 2> if the *reportType* is set to *eventTriggered* and if the entry condition applicable for this event, i.e. the event corresponding with the *eventId* of the corresponding *reportConfig* within *VarMeasConfig*, is fulfilled for one or more applicable cells not included in the *cellsTriggeredList* for all measurements after layer 3 filtering taken during *timeToTrigger* defined for this event within the *VarMeasConfig* (a subsequent cell triggers the event):
 - 3> set the *numberOfReportsSent* defined within the *VarMeasReportList* for this *measId* to 0;
 - 3> include the concerned cell(s) in the *cellsTriggeredList* defined within the *VarMeasReportList* for this *measId*;
 - 3> initiate the measurement reporting procedure, as specified in 5.5.5;
- 2> if the *reportType* is set to *eventTriggered* and if the leaving condition applicable for this event is fulfilled for one or more of the cells included in the *cellsTriggeredList* defined within the *VarMeasReportList* for this *measId* for all measurements after layer 3 filtering taken during *timeToTrigger* defined within the *VarMeasConfig* for this event:
 - 3> remove the concerned cell(s) in the *cellsTriggeredList* defined within the *VarMeasReportList* for this *measId*;
 - 3> if *reportOnLeave* is set to *TRUE* for the corresponding reporting configuration:
 - 4> initiate the measurement reporting procedure, as specified in 5.5.5;
 - 3> if the *cellsTriggeredList* defined within the *VarMeasReportList* for this *measId* is empty:
 - 4> remove the measurement reporting entry within the *VarMeasReportList* for this *measId*;

- 4> stop the periodical reporting timer for this *measId*, if running;
- 2> if *reportType* is set to *periodical* and if a (first) measurement result is available:
 - 3> include a measurement reporting entry within the *VarMeasReportList* for this *measId*;
 - 3> set the *numberOfReportsSent* defined within the *VarMeasReportList* for this *measId* to 0;
 - 4> if the *reportAmount* exceeds 1:
 - 5> initiate the measurement reporting procedure, as specified in 5.5.5, immediately after the quantity to be reported becomes available for the NR SpCell;
 - 4> else (i.e. the *reportAmount* is equal to 1):
 - 5> initiate the measurement reporting procedure, as specified in 5.5.5, immediately after the quantity to be reported becomes available for the NR SpCell and for the strongest cell among the applicable cells;
- 2> upon expiry of the periodical reporting timer for this *measId*:
 - 3> initiate the measurement reporting procedure, as specified in 5.5.5.

[TS 38.331, clause 5.5.4.5]

The UE shall:

- 1> consider the entering condition for this event to be satisfied when condition A4-1, as specified below, is fulfilled;
- 1> consider the leaving condition for this event to be satisfied when condition A4-2, as specified below, is fulfilled.

Inequality A4-1 (Entering condition)

$$Mn + Ofn + Ocn - Hys > Thresh$$

Inequality A4-2 (Leaving condition)

$$Mn + Ofn + Ocn + Hys < Thresh$$

The variables in the formula are defined as follows:

Mn is the measurement result of the neighbouring cell, not taking into account any offsets.

Ofn is the measurement object specific offset of the neighbour cell (i.e. *offsetMO* as defined within *measObjectNR* corresponding to the neighbour cell).

Ocn is the measurement object specific offset of the neighbour cell (i.e. *cellIndividualOffset* as defined within *measObjectNR* corresponding to the neighbour cell), and set to zero if not configured for the neighbour cell.

Hys is the hysteresis parameter for this event (i.e. *hysteresis* as defined within *reportConfigNR* for this event).

Thresh is the threshold parameter for this event (i.e. *a4-Threshold* as defined within *reportConfigNR* for this event).

Mn is expressed in dBm in case of RSRP, or in dB in case of RSRQ and RS-SINR.

Ofn*, *Ocn*, *Hys are expressed in dB.

Thresh is expressed in the same unit as ***Mn***.

[TS 38.331, clause 5.5.5.1]

The purpose of this procedure is to transfer measurement results from the UE to the network. The UE shall initiate this procedure only after successful security activation.

For the *measId* for which the measurement reporting procedure was triggered, the UE shall set the *measResults* within the *MeasurementReport* message as follows:

- 1> set the *measId* to the measurement identity that triggered the measurement reporting;

- 1> set the *measResultServingCell* within *measResultServingMOList* to include RSRP, RSRQ and the available SINR for each configured serving cell derived based on the *rsType* indicated in the associated *reportConfig*;
- 1> set the *measResultServingCell* within *measResultServingMOList* to include for each NR serving cell that is configured with *servingCellMO*, if any, the *servCellId*;
- 1> if there is at least one applicable neighbouring cell to report:
 - 2> set the *measResultNeighCells* to include the best neighbouring cells up to *maxReportCells* in accordance with the following:
 - 3> if the *reportType* is set to *eventTriggered*:
 - 4> include the cells included in the *cellsTriggeredList* as defined within the *VarMeasReportList* for this *measId*;
 - 3> else:
 - 3> for each cell that is included in the *measResultNeighCells*, include the *physCellId*;
 - 3> if the *reportType* is set to *eventTriggered*:
 - 4> for each included cell, include the layer 3 filtered measured results in accordance with the *reportConfig* for this *measId*, ordered as follows:
 - 5> if the *measObject* associated with this *measId* concerns NR:
 - 6> if *rsType* in the associated *reportConfig* is set to *ssb*:
 - 7> set *resultsSSB-Cell* within the *measResult* to include the SS/PBCH block based quantity(ies) indicated in the *reportQuantityCell* within the concerned *reportConfig*, in order of decreasing trigger quantity, i.e. the best cell is included first:
 - 8> if *reportQuantityRSIndexes* and *maxNrofRSIndexesToReport* are configured, include beam measurement information as described in 5.5.5.2;
 - 6> else if *rsType* in the associated *reportConfig* is set to *csi-rs*:
 - ...
 - 1> increment the *numberOfReportsSent* as defined within the *VarMeasReportList* for this *measId* by 1;
 - 1> stop the periodical reporting timer, if running;
 - 1> if the *numberOfReportsSent* as defined within the *VarMeasReportList* for this *measId* is less than the *reportAmount* as defined within the corresponding *reportConfig* for this *measId*:
 - 2> start the periodical reporting timer with the value of *reportInterval* as defined within the corresponding *reportConfig* for this *measId*;
 - 1> else:
 - 2> if the *reportType* is set to *periodical*:
 - 3> remove the entry within the *VarMeasReportList* for this *measId*;
 - 3> remove this *measId* from the *measIdList* within *VarMeasConfig*;
 - 1> if the UE is configured with EN-DC:
 - 2> if SRB3 is configured:
 - 3> submit the *MeasurementReport* message via SRB3 to lower layers for transmission, upon which the procedure ends;
 - 2>else:

3> submit the *MeasurementReport* message via the EUTRA MCG embedded in E-UTRA RRC message *ULInformationTransferMRDC* as specified in TS 36.331 [10].

1> else:

2> submit the *MeasurementReport* message to lower layers for transmission, upon which the procedure ends.

8.2.3.7.1.3 Test description

8.2.3.7.1.3.1 Pre-test conditions

System Simulator:

- E-UTRA Cell 1 is the PCell and NR Cell 1 is the PSCell
- NR Cell 2 is the intra-frequency neighbour cell of NR Cell 1.

UE:

- None

Preamble:

- The UE is in state RRC_CONNECTED using generic procedure parameter Connectivity (EN-DC) and DC Bearers (MCG(s) and SCG) on E-UTRA Cell 1 according to TS 38.508-1 [4], clause 4.5.4.

8.2.3.7.1.3.2 Test procedure sequence

Table 8.2.3.7.1.3.2-1 and Table 8.2.3.7.1.3.2-1A illustrates the downlink power levels to be applied for E-UTRA Cell 1, NR Cell 1 and NR Cell 2 at various time instants of the test execution. Row marked "T0" denotes the conditions after the preamble, while rows marked "T1" and "T2" are to be applied subsequently. The exact instants on which these values shall be applied are described in the texts in this clause.

Table 8.2.3.7.1.3.2-1: Time instances of cell power level and parameter changes for FR1

| | Parameter | Unit | E-UTRA Cell 1 | NR Cell 1 | NR Cell 2 | Remark |
|----|-----------------------|------------|---------------|-----------|-----------|---|
| T0 | Cell-specific RS EPRE | dBm/15k Hz | -85 | - | - | The power level values are such that entry condition for event A4 is not satisfied |
| | SS/PBCH SSS EPRE | dBm/SC S | - | -88 | Off | |
| T1 | Cell-specific RS EPRE | dBm/15k Hz | -85 | - | - | The power level values are such that entry condition for event A4 is satisfied for intra-frequency neighbour NR Cell 2 |
| | SS/PBCH SSS EPRE | dBm/SC S | - | -88 | -79 | |
| T2 | Cell-specific RS EPRE | dBm/15k Hz | -85 | - | - | The power level values are such that entry conditions for event A4 is not satisfied for intra-frequency neighbour NR Cell 2 |
| | SS/PBCH SSS EPRE | dBm/SC S | - | -88 | -91 | |

Table 8.2.3.7.1.3.2-1A: Time instances of cell power level and parameter changes for FR2

| | Parameter | Unit | E-UTRA Cell 1 | NR Cell 1 | NR Cell 2 | Remark |
|----|-----------------------|------------|---------------|-----------|-----------|---|
| T0 | Cell-specific RS EPRE | dBm/15k Hz | -96 | - | - | The power level values are such that entry condition for event A4 is not satisfied |
| | SS/PBCH SSS EPRE | dBm/SC S | - | -91 | Off | |
| T1 | Cell-specific RS EPRE | dBm/15k Hz | -96 | - | - | The power level values are such that entry condition for event A4 is satisfied for intra-frequency neighbour NR Cell 2 |
| | SS/PBCH SSS EPRE | dBm/SC S | - | -91 | -82 | |
| T2 | Cell-specific RS EPRE | dBm/15k Hz | -96 | - | - | The power level values are such that entry conditions for event A4 is not satisfied for intra-frequency neighbour NR Cell 2 |
| | SS/PBCH SSS EPRE | dBm/SC S | - | -91 | -100 | |

Table 8.2.3.7.1.3.2-2: Main behaviour

| St | Procedure | Message Sequence | | TP | Verdict |
|----|---|------------------|---|----|---------|
| | | U - S | Message | | |
| 1 | The SS transmits an <i>RRCConnectionReconfiguration</i> message containing NR <i>RRCReconfiguration</i> message to setup NR measurement and reporting of event A4. | <-- | <i>RRCConnectionReconfiguration</i> (<i>RRCReconfiguration</i>) | - | - |
| 2 | Check: Does the UE transmit an <i>RRCConnectionReconfigurationComplete</i> message containing NR <i>RRCReconfigurationComplete</i> message? | --> | <i>RRCConnectionReconfigurationComplete</i> (<i>RRCReconfigurationComplete</i>) | - | - |
| 3 | The SS re-adjusts the cell-specific reference signal level according to row "T1". | - | - | - | - |
| 4 | Check: Does the UE transmit <i>ULInformationTransferMRDC</i> message containing NR <i>MeasurementReport</i> message to report event A4 with the measured Results for NR Cell 2? | --> | <i>ULInformationTransferMRDC</i> (<i>MeasurementReport</i>) | 1 | P |
| - | EXCEPTION: Step 5 below is repeated until 3 <i>MeasurementReport</i> messages are received from the UE | - | - | - | - |
| 5 | Check: Does the UE transmit <i>ULInformationTransferMRDC</i> message containing NR <i>MeasurementReport</i> message to report event A4 with the measured Results for NR Cell 2? | --> | <i>ULInformationTransferMRDC</i> (<i>MeasurementReport</i>) | 1 | P |
| 6 | The SS re-adjusts the cell-specific reference signal level according to row "T2". | - | - | - | - |
| 7 | Wait and ignore <i>MeasurementReport</i> messages for 15 s to allow change of power levels for NR Cell 2 and UE measurement. | - | - | - | - |
| 8 | Check: Does the UE attempt to transmit an uplink message within the next 10s? | - | - | 2 | F |

8.2.3.7.1.3.3 Specific message contents

Table 8.2.3.7.1.3.3-1: RRCConnectionReconfiguration (step 1, Table 8.2.3.7.1.3.2-2)

| |
|--|
| Derivation Path: 36.508 [7], Table 4.6.1-8 with condition EN-DC_EmbedNR_RRCRecon |
|--|

Table 8.2.3.7.1.3.3-2: RRCReconfiguration (Table 8.2.3.7.1.3.3-1)

Derivation Path: 38.508-1 [4], Table 4.6.1-13 with condition EN-DC_MEAS

Table 8.2.3.7.1.3.3-3: MeasConfig-A4 (Table 8.2.3.7.1.3.3-2)

| Derivation Path: 38.508-1 [4], Table 4.6.3-69 | | | |
|---|--------------------|---------|-----------|
| Information Element | Value/remark | Comment | Condition |
| MeasConfig ::= SEQUENCE { | | | |
| measObjectToAddModList | MeasObjectNR-A4 | | |
| reportConfigToAddModList | ReportConfigNR1-A4 | | FR1 |
| reportConfigToAddModList | ReportConfigNR2-A4 | | FR2 |
| measIdToAddModList SEQUENCE (SIZE (1..maxNrofMeasId)) OF MeasIdToAddMod { | 1 entry | | |
| MeasIdToAddMod[1] SEQUENCE { | | entry 1 | |
| measId | 1 | | |
| measObjectId | 1 | | |
| reportConfigId | 1 | | |
| } | | | |
| } | | | |
| } | | | |

Table 8.2.3.7.1.3.3-4: MeasObjectNR-A4 (Table 8.2.3.7.1.3.3-3)

| Derivation Path: 38.508-1 [4], Table 4.6.3-76 | | | |
|---|--|---------|-----------|
| Information Element | Value/remark | Comment | Condition |
| measObjectToAddModList ::= SEQUENCE (SIZE (1..maxNrofObjectId)) OF MeasObjectToAddMod { | 1 entry | | |
| MeasObjectToAddMod[1] SEQUENCE { | | entry 1 | |
| measObjectId[1] | 1 | | |
| measObject CHOICE { | | | |
| measObjectNR SEQUENCE { | | | |
| ssbFrequency | ssbFrequency IE equals the ARFCN for NR Cell 2 | | |
| absThreshSS-BlocksConsolidation | Not Present | | |
| absThreshCSI-RS-Consolidation | Not Present | | |
| } | | | |
| } | | | |
| } | | | |
| } | | | |

Table 8.2.3.7.1.3.3-5: ReportConfigNR1-A4 (Table 8.2.3.7.1.3.3-3)

| Derivation Path: 38.508-1 [4], Table 4.6.3-143 with condition EVENT_A4 | | | |
|---|--------------|---------------------------------|-----------|
| Information Element | Value/remark | Comment | Condition |
| ReportConfigToAddModList ::= SEQUENCE (SIZE (1..maxNrofMeasId)) OF ReportConfigToAddMod { | 1 entry | | |
| ReportConfigToAddMod[1] SEQUENCE { | | entry 1 | |
| reportConfigId | 1 | | |
| reportConfig CHOICE { | | | |
| reportConfigNR SEQUENCE { | | | |
| reportType CHOICE { | | | |
| eventTriggered SEQUENCE { | | | |
| eventId CHOICE { | | | |
| eventA4 SEQUENCE { | | | |
| a4-Threshold CHOICE { | | | |
| rsrp | 71 | SS RSRP corresponding to -86dBm | |
| } | | | |
| } | | | |
| } | | | |
| } | | | |
| } | | | |
| } | | | |
| } | | | |
| reportInterval | ms1024 | | |
| reportAmount | Infinity | | |
| } | | | |
| } | | | |

Table 8.2.3.7.1.3.3-6: RRCConnectionReconfigurationComplete (step 2, Table 8.2.3.7.1.3.2-2)

Derivation Path: 36.508 [7], Table 4.6.1-9 with condition MCG_and_SCG

Table 8.2.3.7.1.3.3-7: ULInformationTransferMRDC (steps 4, 5, Table 8.2.3.7.1.3.2-2)

| Derivation Path: 36.508 [7], Table 4.6.1-27 | | | |
|---|---|---------|-----------|
| Information Element | Value/remark | Comment | Condition |
| ULInformationTransferMRDC ::= SEQUENCE { | | | |
| ul-DCCH-MessageNR-r15 | OCTET STRING including the MeasurementReport message according to Table 8.2.3.7.1.3.3-8 | | |
| } | | | |

Table 8.2.3.7.1.3.3-9: ReportConfigNR2-A4 (Table 8.2.3.7.1.3.3-3)

| Derivation Path: 38.508-1 [4], Table 4.6.3-143 with condition EVENT_A4 | | | |
|---|------------------|---------------------------------|-----------|
| Information Element | Value/remark | Comment | Condition |
| ReportConfigToAddModList ::= SEQUENCE (SIZE (1..maxNrofMeasId)) OF ReportConfigToAddMod { | 1 entry | | |
| ReportConfigToAddMod[1] SEQUENCE { | | entry 1 | |
| reportConfigId | 1 | | |
| reportConfig CHOICE { | | | |
| reportConfigNR SEQUENCE { | | | |
| reportType CHOICE { | | | |
| eventTriggered SEQUENCE { | | | |
| eventId CHOICE { | | | |
| eventA4 SEQUENCE { | | | |
| a4-Threshold CHOICE { | | | |
| rsrp | 66 + delta(NRfs) | SS RSRP corresponding to -91dBm | |
| } | | | |
| } | | | |
| } | | | |
| } | | | |
| } | | | |
| } | | | |
| reportInterval | ms1024 | | |
| reportAmount | Infinity | | |
| } | | | |
| } | | | |

NOTE 1: delta(NRfs) is derived based on calibration procedure defined in the TS 38.508-1 [4], clause 6.1.3.3

8.2.3.7.1a Measurement configuration control and reporting / Event A4 / Measurement of Neighbor NR cell / Inter-frequency measurements / EN-DC

8.2.3.7.1a.1 Test Purpose (TP)

(1)

```
with { UE in RRC_CONNECTED state with EN-DC, and, MCG(s) (E-UTRA PDCP) and SCG and inter-frequency
measurements configured for event A4 with event based periodical reporting }
ensure that {
  when { Neighbour NR cell becomes better than absolute threshold }
  then { UE sends MeasurementReport message at regular intervals while entering condition for
event A4 is satisfied }
}
```

(2)

```
with { UE in RRC_CONNECTED state with EN-DC, and, MCG(s) (E-UTRA PDCP) and SCG and periodical
measurement reporting triggered by event A4 ongoing }
ensure that {
  when { Neighbour NR cell becomes worse than absolute threshold }
  then { UE stops sending MeasurementReport message }
}
```

8.2.3.7.1a.2 Conformance requirements

Same as test case 8.2.3.7.1 with the following difference:

[TS 36.331, clause 5.5.2.9]

The UE shall:

- 1> if *measGapConfig* is set to *setup*:

...

2> if EN-DC is configured:

3> if the UE is configured with *fr1-Gap* set to *TRUE*:

4> apply the gap configuration for LTE serving cells and for NR serving cells on FR1;

3> else:

4> apply the gap configuration for all LTE and NR serving cells;

8.2.3.7.1a.3 Test description**8.2.3.7.1a.3.1 Pre-test conditions**

Same as test case 8.2.3.7.1 with the following differences:

- Cells configuration: NR Cell 3 replaces NR Cell 2.

8.2.3.7.1a.3.2 Test procedure sequence

Same as test case 8.2.3.7.1 with the following differences:

- Cells configuration: NR Cell 3 replaces NR Cell 2.

8.2.3.7.1a.3.3 Specific message contents

Same as test case 8.2.3.7.1 with the following differences:

Cells configuration: NR Cell 3 replaces NR Cell 2.

Table 8.2.3.7.1a.3.3-0: RRCConnectionReconfiguration (step 1, Table 8.2.3.7.1.3.2-2)

| Derivation Path: 36.508 [7], Table 4.6.1-8 with condition EN-DC_EmbedNR_RRCRecon | | | |
|--|-------------------------|---------|-----------|
| Information Element | Value/remark | Comment | Condition |
| RRCConnectionReconfiguration ::= SEQUENCE { | | | |
| criticalExtensions CHOICE { | | | |
| c1 CHOICE{ | | | |
| rrcConnectionReconfiguration-r8 SEQUENCE { | | | |
| measConfig | Table 8.2.3.7.1a.3.3-0a | | |
| } | | | |
| } | | | |
| } | | | |
| } | | | |

Table 8.2.3.7.1a.3.3-0a: measConfig (Table 8.2.3.7.1a.3.3-0)

| Derivation Path: 36.508 [7], Table 4.6.6-1 | | | |
|--|--------------|-----------------------------|-----------|
| Information Element | Value/remark | Comment | Condition |
| measConfig SEQUENCE { | | | |
| measGapConfig CHOICE { | | | |
| setup SEQUENCE { | | | |
| gapOffset CHOICE { | | | |
| gp0 | 9 | MGRP = 40 ms,
MGL = 6 ms | |
| } | | | |
| } | | | |
| } | | | |
| fr1-gap-r15 | False | | |
| mgta-r15 | False | | |
| } | | | |

Table 8.2.3.7.1a.3.3-1: *MeasConfig-A4* (Table 8.2.3.7.1.3.3-2)

| Derivation Path: 38.508-1 [4] Table 4.6.3-69 | | | |
|--|---|-------------------------------|---------------------|
| Information Element | Value/remark | Comment | Condition |
| MeasConfig ::= SEQUENCE { | | | |
| measObjectToAddModList SEQUENCE (SIZE (1..maxNrofMeasId)) OF MeasObjectToAddMod { | 2 entries | | |
| MeasObjectToAddMod[1] SEQUENCE { | | entry 1 | |
| measObjectId | 1 | | |
| measObject CHOICE { | | | |
| measObjectNR | MeasObjectNR-f1 | Table 8.2.3.7.1a.3.3-2 | |
| } | | | |
| } | | | |
| MeasObjectToAddMod[2] SEQUENCE { | | entry 2 | |
| measObjectId | 2 | | |
| measObject CHOICE { | | | |
| measObjectNR | MeasObjectNR-f2 | Table 8.2.3.7.1a.3.3-3 | |
| } | | | |
| } | | | |
| } | | | |
| reportConfigToAddModList SEQUENCE(SIZE (1..maxReportConfigId)) OF ReportConfigToAddMod { | 1 entry | | |
| ReportConfigToAddMod[1] SEQUENCE { | | entry 1 | |
| reportConfigId | 1 | | |
| reportConfig CHOICE { | | | |
| reportConfigNR | ReportConfigNR(71)
Same as TS 38.508-1 [4],
Table 4.6.3-142 except
for reportAmount set to
'infinity'. ReportInterval
value is set to 'ms1024' | Thresh value set
to -85dBm | EVENT_A4
and FR1 |
| | ReportConfigNR(66 +
delta(NRfs))
Same as TS 38.508-1 [4],
Table 4.6.3-142 except
for reportAmount set to
'infinity'. ReportInterval | Thresh value set
to -91dBm | EVENT_A4
and FR2 |
| } | | | |
| } | | | |
| } | | | |
| } | | | |
| measIdToAddModList SEQUENCE (SIZE (1..maxNrofMeasId)) OF MeasIdToAddMod { | 1 entry | | |
| MeasIdToAddMod[1] SEQUENCE { | | entry 1 | |
| measId | 1 | | |
| measObjectId | 2 | | |
| reportConfigId | 1 | | |
| } | | | |
| } | | | |
| } | | | |

Table 8.2.3.7.1a.3.3-2: *MeasObjectNR-f1* (Table 8.2.3.7.1a.3.3-1)

| Derivation Path: TS 38.508-1 [4], Table 4.6.3-76 | | | |
|--|---------------------------------------|---------|-----------|
| Information Element | Value/remark | Comment | Condition |
| MeasObjectNR ::= SEQUENCE { | | | |
| ssbFrequency | ARFCN-ValueNR for
SSB of NR Cell 1 | | |
| absThreshSS-BlocksConsolidation | Not present | | |
| nrofSS-BlocksToAverage | Not present | | |
| } | | | |

Table 8.2.3.7.1a.3.3-3: MeasObjectNR-f2 (Table 8.2.3.7.1a.3.3-1)

| Derivation Path: TS 38.508-1 [4], Table 4.6.3-76 | | | |
|--|------------------------------------|---------|-----------|
| Information Element | Value/remark | Comment | Condition |
| MeasObjectNR ::= SEQUENCE { | | | |
| ssbFrequency | ARFCN-ValueNR for SSB of NR Cell 3 | | |
| absThreshSS-BlocksConsolidation | Not present | | |
| nrofSS-BlocksToAverage | Not present | | |
| } | | | |

8.2.3.7.1b Measurement configuration control and reporting / Event A4 / Measurement of Neighbor NR cell / Inter-band measurements / EN-DC

8.2.3.7.1b.1 Test Purpose (TP)

(1)

```
with { UE in RRC_CONNECTED state with EN-DC, and, MCG(s) (E-UTRA PDCP) and SCG and inter-band
measurements configured for event A4 with event based periodical reporting }
ensure that {
  when { Neighbour NR cell becomes better than absolute threshold }
  then { UE sends MeasurementReport message at regular intervals while entering condition for
event A4 is satisfied }
}
```

(2)

```
with { UE in RRC_CONNECTED state with EN-DC, and, MCG(s) (E-UTRA PDCP) and SCG and periodical
measurement reporting triggered by event A4 ongoing }
ensure that {
  when { Neighbour NR cell becomes worse than absolute threshold }
  then { UE stops sending MeasurementReport message }
}
```

8.2.3.7.1b.2 Conformance requirements

Same as test case 8.2.3.7.1 with the following difference:

[TS 36.331, clause 5.5.2.9]

The UE shall:

1> if *measGapConfig* is set to *setup*:

...

2> if EN-DC is configured:

3> if the UE is configured with *fr1-Gap* set to *TRUE*:

4> apply the gap configuration for LTE serving cells and for NR serving cells on FR1;

3> else:

4> apply the gap configuration for all LTE and NR serving cells;

...

8.2.3.7.1b.3 Test description

8.2.3.7.1b.3.1 Pre-test conditions

Same as test case 8.2.3.7.1 with the following differences:

- Cells configuration: NR Cell 10 replaces NR Cell 2.

8.2.3.7.1b.3.2 Test procedure sequence

Same as test case 8.2.3.7.1 with the following differences:

- Cells configuration: NR Cell 10 replaces NR Cell 2.

8.2.3.7.1b.3.3 Specific message contents

Same as test case 8.2.3.7.1 with the following differences:

- Cells configuration: NR Cell 10 replaces NR Cell 2.

Table 8.2.3.7.1b.3.3-0: RRCConnectionReconfiguration (step 1, Table 8.2.3.7.1.3.2-2)

| Derivation Path: 36.508 [7], Table 4.6.1-8 with condition EN-DC_EmbedNR_RRCRecon | | | |
|--|-------------------------|---------|-----------|
| Information Element | Value/remark | Comment | Condition |
| RRCConnectionReconfiguration ::= SEQUENCE { | | | |
| criticalExtensions CHOICE { | | | |
| c1 CHOICE{ | | | |
| rrcConnectionReconfiguration-r8 SEQUENCE { | | | |
| measConfig | Table 8.2.3.7.1b.3.3-0a | | |
| } | | | |
| } | | | |
| } | | | |
| } | | | |

Table 8.2.3.7.1b.3.3-0a: measConfig (Table 8.2.3.7.1b.3.3-0)

| Derivation Path: 36.508 [7], Table 4.6.6-1 | | | |
|--|--------------|-----------------------------|-----------|
| Information Element | Value/remark | Comment | Condition |
| measConfig ::= SEQUENCE { | | | |
| measGapConfig CHOICE { | | | |
| setup SEQUENCE { | | | |
| gapOffset CHOICE { | | | |
| gp0 | 9 | MGRP = 40 ms,
MGL = 6 ms | |
| } | | | |
| } | | | |
| } | | | |
| fr1-gap-r15 | False | | |
| mgta-r15 | False | | |
| } | | | |

Table 8.2.3.7.1b.3.3-1: *MeasConfig-A4* (Table 8.2.3.7.1.3.3-2)

| Derivation Path: 38.508-1 [4] Table 4.6.3-69 | | | |
|--|---|-------------------------------|-----------|
| Information Element | Value/remark | Comment | Condition |
| MeasConfig ::= SEQUENCE { | | | |
| measObjectToAddModList SEQUENCE (SIZE (1..maxNrofMeasId)) OF MeasObjectToAddMod { | 2 entries | | |
| MeasObjectToAddMod[1] SEQUENCE { | | entry 1 | |
| measObjectId | 1 | | |
| measObject CHOICE { | | | |
| measObjectNR | MeasObjectNR-f1 | Table 8.2.3.7.1b.3.3-2 | |
| } | | | |
| } | | | |
| MeasObjectToAddMod[2] SEQUENCE { | | entry 2 | |
| measObjectId | 2 | | |
| measObject CHOICE { | | | |
| measObjectNR | MeasObjectNR-f2 | Table 8.2.3.7.1b.3.3-3 | |
| } | | | |
| } | | | |
| reportConfigToAddModList SEQUENCE(SIZE (1..maxReportConfigId)) OF ReportConfigToAddMod { | 1 entry | | |
| ReportConfigToAddMod[1] SEQUENCE { | | entry 1 | |
| reportConfigId | 1 | | |
| reportConfig CHOICE { | | | |
| reportConfigNR | ReportConfigNR(71)
Same as TS 38.508-1 [4],
Table 4.6.3-142 except
for reportAmount set to
'infinity'. ReportInterval
value is set to 'ms1024' | Thresh value set
to -85dBm | EVENT_A4 |
| } | | | |
| } | | | |
| measIdToAddModList SEQUENCE (SIZE (1..maxNrofMeasId)) OF MeasIdToAddMod { | 1 entry | | |
| MeasIdToAddMod[1] SEQUENCE { | | entry 1 | |
| measId | 1 | | |
| measObjectId | 2 | | |
| reportConfigId | 1 | | |
| } | | | |
| } | | | |
| } | | | |

Table 8.2.3.7.1b.3.3-2: *MeasObjectNR-f1* (Table 8.2.3.7.1b.3.3-1)

| Derivation Path: TS 38.508-1 [4], Table 4.6.3-76 | | | |
|--|---------------------------------------|---------|-----------|
| Information Element | Value/remark | Comment | Condition |
| MeasObjectNR ::= SEQUENCE { | | | |
| ssbFrequency | ARFCN-ValueNR for
SSB of NR Cell 1 | | |
| absThreshSS-BlocksConsolidation | Not present | | |
| nrofSS-BlocksToAverage | Not present | | |
| } | | | |

Table 8.2.3.7.1b.3.3-3: MeasObjectNR-f2 (Table 8.2.3.7.1b.3.3-1)

| Derivation Path: TS 38.508-1 [4], Table 4.6.3-76 | | | |
|--|-------------------------------------|---------|-----------|
| Information Element | Value/remark | Comment | Condition |
| MeasObjectNR ::= SEQUENCE { | | | |
| ssbFrequency | ARFCN-ValueNR for SSB of NR Cell 10 | | |
| absThreshSS-BlocksConsolidation | Not present | | |
| nrofSS-BlocksToAverage | Not present | | |
| } | | | |

8.2.3.8 Measurement configuration control and reporting / Event A5 / Measurement of Neighbour NR cell

8.2.3.8.1 Measurement configuration control and reporting / Event A5 / Measurement of Neighbour NR cell / Intra-frequency measurements / EN-DC

8.2.3.8.1.1 Test Purpose (TP)

(1)

```
with { UE in RRC_CONNECTED state with EN-DC, and, MCG(s) (E-UTRA PDCP) and SCG and measurement
configured for event A5 with event based periodical reporting }
ensure that {
  when { Serving NR PSCell becomes worse than absolute threshold1 and neighbour NR cell becomes
better than absolute threshold2 }
  then { UE sends MeasurementReport message at regular intervals while entering conditions for
event A5 are satisfied }
}
```

(2)

```
with { UE in RRC_CONNECTED state with EN-DC, and, MCG(s) (E-UTRA PDCP) and SCG and periodical
measurement reporting triggered by event A5 ongoing }
ensure that {
  when { Serving NR PSCell becomes better than absolute threshold1 or neighbour NR cell becomes
worse than absolute threshold2 }
  then { UE stops sending MeasurementReport message }
}
```

8.2.3.8.1.2 Conformance requirements

References: The conformance requirements covered in the present TC are specified in: TS 36.331, clause 5.3.5.3, TS 38.331, clauses 5.3.5.3, 5.5.2, 5.5.4.1 and 5.5.4.6. Unless otherwise stated these are Rel-15 requirements.

[TS 36.331, clause 5.3.5.3]

If the *RRCCConnectionReconfiguration* message does not include the *mobilityControlInfo* and the UE is able to comply with the configuration included in this message, the UE shall:

- 1> if the *RRCCConnectionReconfiguration* message includes the *measConfig*:
 - 2> perform the measurement configuration procedure as specified in 5.5.2;
- 1> set the content of *RRCCConnectionReconfigurationComplete* message as follows:
 - 2> if the received *RRCCConnectionReconfiguration* message included *nr-SecondaryCellGroupConfig*:
 - 3> include *scg-ConfigResponseNR* in accordance with TS 38.331 [82], clause 5.3.5.3;
- 1> set the content of *RRCCConnectionReconfigurationComplete* message as follows:
 - 2> if the received *RRCCConnectionReconfiguration* message included *nr-SecondaryCellGroupConfig*:
 - 3> include *scg-ConfigResponseNR* in accordance with TS 38.331 [82, 5.3.5.3];

- 1> submit the *RRCConnectionReconfigurationComplete* message to lower layers for transmission using the new configuration, upon which the procedure ends;

[TS 38.331, clause 5.3.5.3]

The UE shall perform the following actions upon reception of the *RRCReconfiguration*:

- 1> if the *RRCReconfiguration* includes the *secondaryCellGroup*:
 - 2> perform the cell group configuration for the SCG according to 5.3.5.5;
- 1> if the *RRCReconfiguration* message includes the *measConfig*:
 - 2> perform the measurement configuration procedure as specified in 5.5.2;
 - 1> if the UE is configured with E-UTRA *nr-SecondaryCellGroupConfig* (MCG is E-UTRA):
 - 2> if *RRCReconfiguration* was received via SRB1:
 - 3> construct *RRCReconfigurationComplete* message and submit it via the EUTRA MCG embedded in E-UTRA RRC message *RRCConnectionReconfigurationComplete* as specified in TS 36.331 [10];

[TS 38.331, clause 5.5.2]

The UE shall:

- 1> if the received *measConfig* includes the *measObjectToAddModList*:
 - 2> perform the measurement object addition/modification procedure as specified in 5.5.2.5;
- 1> if the received *measConfig* includes the *reportConfigToAddModList*:
 - 2> perform the reporting configuration addition/modification procedure as specified in 5.5.2.7;
- 1> if the received *measConfig* includes the *measIdToAddModList*:
 - 2> perform the measurement identity addition/modification procedure as specified in 5.5.2.3;

[TS 38.331, clause 5.5.4.1]

If security has been activated successfully, the UE shall:

- 1> for each *measId* included in the *measIdList* within *VarMeasConfig*:
 - 2> if the corresponding *reportConfig* includes a *reportType* set to *eventTriggered* or *periodical*;
 - 3> if the corresponding *measObject* concerns NR;
 - 4> if the *eventA1* or *eventA2* is configured in the corresponding *reportConfig*:
 - 5> consider only the serving cell to be applicable;
 - 4> else:
 - 5> for events involving a serving cell associated with a *measObjectNR* and neighbours associated with another *measObjectNR*, consider any serving cell associated with the other *measObjectNR* to be a neighbouring cell as well;
 - 2> if the *reportType* is set to *eventTriggered* and if the entry condition applicable for this event, i.e. the event corresponding with the *eventId* of the corresponding *reportConfig* within *VarMeasConfig*, is fulfilled for one or more applicable cells for all measurements after layer 3 filtering taken during *timeToTrigger* defined for this event within the *VarMeasConfig*, while the *VarMeasReportList* does not include a measurement reporting entry for this *measId* (a first cell triggers the event):
 - 3> include a measurement reporting entry within the *VarMeasReportList* for this *measId*;
 - 3> set the *numberOfReportsSent* defined within the *VarMeasReportList* for this *measId* to 0;

- 3> include the concerned cell(s) in the *cellsTriggeredList* defined within the *VarMeasReportList* for this *measId*;
- 3> initiate the measurement reporting procedure, as specified in 5.5.5;
- 2> if the *reportType* is set to *eventTriggered* and if the entry condition applicable for this event, i.e. the event corresponding with the *eventId* of the corresponding *reportConfig* within *VarMeasConfig*, is fulfilled for one or more applicable cells not included in the *cellsTriggeredList* for all measurements after layer 3 filtering taken during *timeToTrigger* defined for this event within the *VarMeasConfig* (a subsequent cell triggers the event):
 - 3> set the *numberOfReportsSent* defined within the *VarMeasReportList* for this *measId* to 0;
 - 3> include the concerned cell(s) in the *cellsTriggeredList* defined within the *VarMeasReportList* for this *measId*;
 - 3> initiate the measurement reporting procedure, as specified in 5.5.5;

[TS 38.331, clause 5.5.4.6]

The UE shall:

- 1> consider the entering condition for this event to be satisfied when both condition A5-1 and condition A5-2, as specified below, are fulfilled;
- 1> consider the leaving condition for this event to be satisfied when condition A5-3 or condition A5-4, i.e. at least one of the two, as specified below, is fulfilled;
- 1> use the SpCell for *Mp*.

NOTE: The cell(s) that triggers the event is on the frequency indicated in the associated *measObjectNR* which may be different from the frequency used by the NR SpCell.

Inequality A5-1 (Entering condition 1)

$$M_p + H_{ys} < Thresh_1$$

Inequality A5-2 (Entering condition 2)

$$M_n + Ofn + Ocn - H_{ys} > Thresh_2$$

Inequality A5-3 (Leaving condition 1)

$$M_p - H_{ys} > Thresh_1$$

Inequality A5-4 (Leaving condition 2)

$$M_n + Ofn + Ocn + H_{ys} < Thresh_2$$

The variables in the formula are defined as follows:

M_p is the measurement result of the NR SpCell, not taking into account any offsets.

M_n is the measurement result of the neighbouring cell/SCell, not taking into account any offsets.

Ofn is the measurement object specific offset of the neighbour/SCell cell (i.e. *offsetMO* as defined within *measObjectNR* corresponding to the frequency of the neighbour cell/SCell).

Ocn is the cell specific offset of the neighbour cell (i.e. *cellIndividualOffset* as defined within *measObjectNR* corresponding to the neighbour cell/SCell), and set to zero if not configured for the neighbour cell.

H_{ys} is the hysteresis parameter for this event (i.e. *hysteresis* as defined within *reportConfigNR* for this event).

Thresh₁ is the threshold parameter for this event (i.e. *a5-Threshold1* as defined within *reportConfigNR* for this event).

Thresh2 is the threshold parameter for this event (i.e. *a5-Threshold2* as defined within *reportConfigNR* for this event).

Mn, *Mp* are expressed in dBm in case of RSRP, or in dB in case of RSRQ and RS-SINR.

Ofn, *Ocn*, *Hys* are expressed in dB.

Thresh1 is expressed in the same unit as *Mp*.

Thresh2 is expressed in the same unit as *Mn*.

[TS 38.331, clause 5.5.5]

For the *measId* for which the measurement reporting procedure was triggered, the UE shall set the *measResults* within the *MeasurementReport* message as follows:

- 1> set the *measId* to the measurement identity that triggered the measurement reporting;
- 1> set the *measResultServingCell* within *measResultServingMOList* to include RSRP, RSRQ and the available SINR for each configured serving cell derived based on the *rsType* indicated in the associated *reportConfig*;
- 1> set the *measResultServingCell* within *measResultServingMOList* to include for each NR serving cell that is configured with *servingCellMO*, if any, the *servCellId*;
- ...
- 1> if there is at least one applicable neighbouring cell to report:
 - 2> if the *reportType* is set to *eventTriggered* or *periodical*:
 - 3> set the *measResultNeighCells* to include the best neighbouring cells up to *maxReportCells* in accordance with the following:
 - 4> if the *reportType* is set to *eventTriggered*:
 - 5> include the cells included in the *cellsTriggeredList* as defined within the *VarMeasReportList* for this *measId*;
 - 4> else:
 - 5> include the applicable cells for which the new measurement results became available since the last periodical reporting or since the measurement was initiated or reset;
 - 4> for each cell that is included in the *measResultNeighCells*, include the *physCellId*;
 - 4> if the *reportType* is set to *eventTriggered* or *periodical*:
 - 5> for each included cell, include the layer 3 filtered measured results in accordance with the *reportConfig* for this *measId*, ordered as follows:
 - 6> if the *measObject* associated with this *measId* concerns NR:
 - 7> if *rsType* in the associated *reportConfig* is set to *ssb*:
 - 8> set *resultsSSB-Cell* within the *measResult* to include the SS/PBCH block based quantity(ies) indicated in the *reportQuantityCell* within the concerned *reportConfig*, in decreasing order of the sorting quantity, determined as specified in 5.5.5.3, i.e. the best cell is included first;
- 1> if the UE is configured with EN-DC:
 - 2> if SRB3 is configured:
 - 3> submit the *MeasurementReport* message via SRB3 to lower layers for transmission, upon which the procedure ends;
 - 2>else:

3> submit the *MeasurementReport* message via the EUTRA MCG embedded in E-UTRA RRC message *ULInformationTransferMRDC* as specified in TS 36.331 [10].

1> else:

2>submit the *MeasurementReport* message to lower layers for transmission, upon which the procedure ends.

8.2.3.8.1.3 Test description

8.2.3.8.1.3.1 Pre-test conditions

System Simulator:

- EUTRA Cell 1 is the PCell and NR Cell 1 is the Serving PS Cell.
- NR Cell 2 is the intra-frequency neighbour cell.

UE:

- None

Preamble:

- The UE is in state RRC_CONNECTED in EN-DC mode and DC Bearers (MCG and SCG) on E-UTRA Cell 1 according to TS 38.508-1 [4].

8.2.3.8.1.3.2 Test procedure sequence

Table 8.2.3.8.1.3.2-1 and Table 8.2.3.8.1.3.2-1A illustrates the downlink power levels to be applied for NR Cell 1 and NR Cell 2 at various time instants of the test execution. Row marked "T0" denotes the conditions after the preamble, while rows marked "T1", "T2", "T3", "T4" and "T5" are to be applied subsequently. The exact instants on which these values shall be applied are described in the texts in this clause.

Table 8.2.3.8.1.3.2-1: Time instances of cell power level and parameter changes for FR1

| | Parameter | Unit | EUTRA
Cell 1 | NR
Cell 1 | NR
Cell 2 | Remark |
|----|-----------------------|-----------|-----------------|--------------|--------------|--|
| T0 | Cell-specific RS EPRE | dBm/15kHz | -85 | - | - | Power levels are such that entry condition for event A5 is not satisfied, i.e. condition A5-1 ($Mp+Hys < Thresh1$) is fulfilled but condition A5-2 ($Mn+Ofn+Ocn-Hys > Thresh2$) is not fulfilled for intra-frequency neighbour NR Cell 2. |
| | SS/PBCH SSS EPRE | dBm/SCS | - | -90 | -96 | |
| T1 | Cell-specific RS EPRE | dBm/15kHz | -85 | - | - | Power levels are such that entry condition for event A5 is not satisfied, i.e. condition A5-1 ($Mp+Hys < Thresh1$) is not fulfilled but condition A5-2 ($Mn+Ofn+Ocn-Hys > Thresh2$) is fulfilled for intra-frequency neighbour NR Cell 2. |
| | SS/PBCH SSS EPRE | dBm/SCS | - | -78 | -84 | |
| T2 | Cell-specific RS EPRE | dBm/15kHz | -85 | - | - | Power levels are such that entry condition for event A5 is satisfied, i.e. condition A5-1 ($Mp+Hys < Thresh1$) and condition A5-2 ($Mn+Ofn+Ocn-Hys > Thresh2$) are fulfilled for intra-frequency neighbour NR Cell 2 (i.e. periodical reporting for event A5 starts). |
| | SS/PBCH SSS EPRE | dBm/SCS | - | -90 | -84 | |
| T3 | Cell-specific RS EPRE | dBm/15kHz | -85 | - | - | Power levels are such that leaving condition for event A5 is satisfied, i.e. condition A5-3 ($Mp-Hys > Thresh1$) is satisfied but condition A5-4 ($Mn+Ofn+Ocn+Hys < Thresh2$) is not satisfied for intra-frequency neighbour NR Cell 2 (i.e. periodical reporting for event A5 stops). |
| | SS/PBCH SSS EPRE | dBm/SCS | - | -78 | -84 | |
| T4 | Cell-specific RS EPRE | dBm/15kHz | -85 | - | - | Power levels are such that entry condition for event A5 is satisfied, i.e. condition A5-1 ($Mp+Hys < Thresh1$) and condition A5-2 ($Mn+Ofn+Ocn-Hys > Thresh2$) are fulfilled for intra-frequency neighbour NR Cell 2 (i.e. periodical reporting for event A5 starts). |
| | SS/PBCH SSS EPRE | dBm/SCS | - | -90 | -84 | |
| T5 | Cell-specific RS EPRE | dBm/15kHz | -85 | - | - | Power levels are such that leaving condition for event A5 is satisfied, i.e. condition A5-3 ($Mp-Hys > Thresh1$) is not satisfied but condition A5-4 ($Mn+Ofn+Ocn+Hys < Thresh2$) is satisfied for intra-frequency neighbour NR Cell 2 (i.e. periodical reporting for event A5 stops). |
| | SS/PBCH SSS EPRE | dBm/SCS | - | -90 | -96 | |

Table 8.2.3.8.1.3.2-1A: Time instances of cell power level and parameter changes for FR2

| | Parameter | Unit | EUTRA
Cell 1 | NR
Cell 1 | NR
Cell 2 | Remark |
|----|-----------------------|-----------|-----------------|--------------|--------------|--|
| T0 | Cell-specific RS EPRE | dBm/15kHz | -96 | - | - | Power levels are such that entry condition for event A5 is not satisfied, i.e. condition A5-1 ($Mp+Hys < Thresh1$) is fulfilled but condition A5-2 ($Mn+Ofn+Ocn-Hys > Thresh2$) is not fulfilled for intra-frequency neighbour NR Cell 2. |
| | SS/PBCH SSS EPRE | dBm/SCS | - | -100 | -109 | |
| T1 | Cell-specific RS EPRE | dBm/15kHz | -96 | - | - | Power levels are such that entry condition for event A5 is not satisfied, i.e. condition A5-1 ($Mp+Hys < Thresh1$) is not fulfilled but condition A5-2 ($Mn+Ofn+Ocn-Hys > Thresh2$) is fulfilled for intra-frequency neighbour NR Cell 2. |
| | SS/PBCH SSS EPRE | dBm/SCS | - | -82 | -91 | |
| T2 | Cell-specific RS EPRE | dBm/15kHz | -96 | - | - | Power levels are such that entry condition for event A5 is satisfied, i.e. condition A5-1 ($Mp+Hys < Thresh1$) and condition A5-2 ($Mn+Ofn+Ocn-Hys > Thresh2$) are fulfilled for intra-frequency neighbour NR Cell 2 (i.e. periodical reporting for event A5 starts). |
| | SS/PBCH SSS EPRE | dBm/SCS | - | -100 | -82 | |
| T3 | Cell-specific RS EPRE | dBm/15kHz | -96 | - | - | Power levels are such that leaving condition for event A5 is satisfied, i.e. condition A5-3 ($Mp-Hys > Thresh1$) is satisfied but condition A5-4 ($Mn+Ofn+Ocn+Hys < Thresh2$) is not satisfied for intra-frequency neighbour NR Cell 2 (i.e. periodical reporting for event A5 stops). |
| | SS/PBCH SSS EPRE | dBm/SCS | - | -82 | -82 | |
| T4 | Cell-specific RS EPRE | dBm/15kHz | -96 | - | - | Power levels are such that entry condition for event A5 is satisfied, i.e. condition A5-1 ($Mp+Hys < Thresh1$) and condition A5-2 ($Mn+Ofn+Ocn-Hys > Thresh2$) are fulfilled for intra-frequency neighbour NR Cell 2 (i.e. periodical reporting for event A5 starts). |
| | SS/PBCH SSS EPRE | dBm/SCS | - | -100 | -82 | |
| T5 | Cell-specific RS EPRE | dBm/15kHz | -96 | - | - | Power levels are such that leaving condition for event A5 is satisfied, i.e. condition A5-3 ($Mp-Hys > Thresh1$) is not satisfied but condition A5-4 ($Mn+Ofn+Ocn+Hys < Thresh2$) is satisfied for intra-frequency neighbour NR Cell 2 (i.e. periodical reporting for event A5 stops). |
| | SS/PBCH SSS EPRE | dBm/SCS | - | -100 | -100 | |

Table 8.2.3.8.1.3.2-2: Main behaviour

| St | Procedure | Message Sequence | | TP | Verdict |
|-----|--|------------------|---|----|---------|
| | | U - S | Message | | |
| 1 | The SS transmits an <i>RRCConnectionReconfiguration</i> message containing NR <i>RRCReconfiguration</i> message to setup measurements for neighbour NR Cells and reporting for event A5. | <-- | <i>RRCConnectionReconfiguration</i> (<i>RRCReconfiguration</i>) | - | - |
| 2 | Check: Does the UE transmit an <i>RRCConnectionReconfigurationComplete</i> message containing NR <i>RRCReconfigurationComplete</i> message? | --> | <i>RRCConnectionReconfigurationComplete</i> (<i>RRCReconfigurationComplete</i>) | - | - |
| 3 | Check: Does the UE transmit an <i>ULInformationTransferMRDC</i> message containing NR <i>MeasurementReport</i> message within the next 10s? | --> | <i>ULInformationTransferMRDC</i> (<i>MeasurementReport</i>) | 1 | F |
| 4 | The SS re-adjusts the cell-specific reference signal level according to row "T1". | - | - | - | - |
| 5 | Check: Does the UE transmit an <i>ULInformationTransferMRDC</i> message containing NR <i>MeasurementReport</i> message to report event A5 with the measured value for NR Cell 2? | --> | <i>ULInformationTransferMRDC</i> (<i>MeasurementReport</i>) | 1 | F |
| - | EXCEPTION: Steps 5a1-5a2 are executed in case of FR2 | - | - | - | - |
| 5a1 | The SS transmits an <i>RRCConnectionReconfiguration</i> message containing NR <i>RRCReconfiguration</i> message to setup measurements for neighbour NR Cells and reporting for event A5. | <-- | <i>RRCConnectionReconfiguration</i> (<i>RRCReconfiguration</i>) | - | - |
| 5a2 | Check: Does the UE transmit an <i>RRCConnectionReconfigurationComplete</i> message containing NR <i>RRCReconfigurationComplete</i> message? | --> | <i>RRCConnectionReconfigurationComplete</i> (<i>RRCReconfigurationComplete</i>) | - | - |
| 6 | The SS re-adjusts the cell-specific reference signal level according to row "T2". | - | - | - | - |
| 7 | Check: Does the UE transmit an <i>ULInformationTransferMRDC</i> message containing NR <i>MeasurementReport</i> message to report event A5 with the measured value for NR Cell 2? | --> | <i>ULInformationTransferMRDC</i> (<i>MeasurementReport</i>) | 1 | P |
| - | EXCEPTION: Step 8 below is repeated until 3 <i>MeasurementReport</i> messages are received from the UE. | - | - | - | - |
| 8 | Check: Does the UE transmit an <i>ULInformationTransferMRDC</i> message containing NR <i>MeasurementReport</i> message, with the measured value for NR Cell 2? | --> | <i>ULInformationTransferMRDC</i> (<i>MeasurementReport</i>) | 1 | P |
| 9 | The SS re-adjusts the cell-specific reference signal level according to row "T3". | - | - | - | - |
| 10 | Wait and ignore NR <i>MeasurementReport</i> messages for 15 s to allow change of power levels for NR Cell 2 and UE measurements. | - | - | - | - |
| 11 | Check: Does the UE attempt to transmit an uplink message within the next 10s? | --> | <i>ULInformationTransferMRDC</i> (<i>MeasurementReport</i>) | 2 | F |
| 12 | The SS re-adjusts the cell-specific reference signal level according to row "T4". | - | - | - | - |
| 13 | Check: Does the UE transmit an <i>ULInformationTransferMRDC</i> message containing NR <i>MeasurementReport</i> message to report event A5 with the measured value for NR Cell 2? | --> | <i>ULInformationTransferMRDC</i> (<i>MeasurementReport</i>) | 1 | P |
| 14 | The SS re-adjusts the cell-specific reference signal level according to row "T5". | - | - | - | - |
| 15 | Wait and ignore NR <i>MeasurementReport</i> messages for 15 s to allow change of power levels for NR Cell 2 and UE measurements. | - | - | - | - |
| 16 | Check: Does the UE attempt to transmit an uplink message within the next 10s? | --> | <i>ULInformationTransferMRDC</i> (<i>MeasurementReport</i>) | 2 | F |

8.2.3.8.1.3.3 Specific message contents

Table 8.2.3.8.1.3.3-1: RRCConnectionReconfiguration (step 1, Step 5a1 Table 8.2.3.8.1.3.2-2)

Derivation Path: 36.508 [7], Table 4.6.1-8 with condition EN-DC_EmbedNR_RRCRecon

Table 8.2.3.8.1.3.3-2: RRCReconfiguration (Table 8.2.3.8.1.3.3-1)

Derivation Path: 38.508-1 [4], Table 4.6.1-13 with condition EN-DC_MEAS

Table 8.2.3.8.1.3.3-3: MeasConfig-A5 (Table 8.2.3.8.1.3.3-2, Step 1)

| Derivation Path: 38.508-1 [4], Table 4.6.3-69 | | | |
|--|---|--|------------------|
| Information Element | Value/remark | Comment | Condition |
| MeasConfig ::= SEQUENCE { | | | |
| measObjectToAddModList | MeasObjectNR | | |
| ReportConfigToAddModList SEQUENCE(SIZE (1..maxReportConfigId)) OF ReportConfigToAddMod { | 1 entry | | |
| ReportConfigToAddMod[1] SEQUENCE { | | entry 1 | |
| reportConfigId[1] | ReportConfigId | | |
| reportConfig[1] CHOICE { | | | |
| reportConfigNR | ReportConfigNR(72,66). Same as TS 38.508-1 Table 4.6.3-142 except for hysteresis value in eventA5 set to '0', reportAmount set to 'infinity', and reportInterval value set to 'ms1024'. | Thresh values set to -84 dBm, -90 dBm | EVENT_A5 AND FR1 |
| | ReportConfigNR(65+Delta(NRf1),56+Delta(NRf1)). Same as TS 38.508-1 Table 4.6.3-142 except for hysteresis value in eventA5 set to '0', reportAmount set to 'infinity', and reportInterval value set to 'ms1024'. | Thresh values set to -91 dBm, -100 dBm | EVENT_A5 AND FR2 |
| } | | | |
| } | | | |
| MeasIdToAddModList SEQUENCE (SIZE (1..maxNrofMeasId)) OF MeasIdToAddMod { | 1 entry | | |
| MeasIdToAddMod[1] SEQUENCE { | | entry 1 | |
| measId | 1 | | |
| measObjectId | 1 | | |
| reportConfigId | 1 | | |
| } | | | |
| } | | | |
| } | | | |
| NOTE 1: Delta(NRf1) is derived based on calibration procedure defined in the TS 38.508-1 [4], clause 6.1.3.3 | | | |

Table 8.2.3.8.1.3.3-3A: MeasConfig-A5 (Table 8.2.3.8.1.3.3-2, Step 5a1)

| Derivation Path: 38.508-1 [4], Table 4.6.3-69 | | | |
|--|---|---------------------------------------|------------------|
| Information Element | Value/remark | Comment | Condition |
| MeasConfig ::= SEQUENCE { | | | |
| measObjectToAddModList | MeasObjectNR | | |
| ReportConfigToAddModList SEQUENCE(SIZE (1..maxReportConfigId)) OF ReportConfigToAddMod { | | | |
| ReportConfigToAddMod[1] SEQUENCE { | | entry 1 | |
| reportConfigId | ReportConfigId | | |
| reportConfig CHOICE { | | | |
| reportConfigNR | ReportConfigNR(65+Delta(NRf1),65+Delta(NRf1)). Same as TS 38.508-1 Table 4.6.3-142 except for hysteresis value in eventA5 set to '0', reportAmount set to 'infinity', and reportInterval value set to 'ms1024'. | Thresh values set to -91 dBm, -91 dBm | EVENT_A5 AND FR2 |
| } | | | |
| } | | | |
| MeasIdToAddModList SEQUENCE (SIZE (1..maxNrofMeasId)) OF MeasIdToAddMod { | 1 entry | | |
| MeasIdToAddMod[1] SEQUENCE { | | entry 1 | |
| measId | 1 | | |
| measObjectId | 1 | | |
| reportConfigId | 1 | | |
| } | | | |
| } | | | |
| } | | | |

Table 8.2.3.8.1.3.3-4: MeasObjectNR (Table 8.2.3.8.1.3.3-3)

| Derivation Path: 38.508-1 [4], Table 4.6.3-76 | | | |
|---|------------------|--|-----------|
| Information Element | Value/remark | Comment | Condition |
| measObjectToAddModList ::= SEQUENCE (SIZE (1..maxNrofObjectId)) OF MeasObjectToAddMod { | 1 entry | | |
| MeasObjectToAddMod[1] SEQUENCE { | | entry 1 | |
| measObjectId | 1 | | |
| measObject CHOICE { | | | |
| measObjectNR | MeasObjectNR(60) | ssbFrequency IE equals the ARFCN for NR Cell 2
Thresh value set to -97dBm | |
| } | | | |
| } | | | |
| } | | | |

Table 8.2.3.8.1.3.3-5: RRCConnectionReconfigurationComplete (step 2, Table 8.2.3.8.1.3.2-2)

| Derivation Path: 36.508 [7], Table 4.6.1-9 with condition MCG_and_SCG |
|---|
|---|

Table 8.2.3.8.1.3.3-6: ULInformationTransferMRDC (steps 7, 8, 13 Table 8.2.3.8.1.3.2-2)

| Derivation Path: 36.508 [7], Table 4.6.1-27 | | | |
|---|---|---------|-----------|
| Information Element | Value/remark | Comment | Condition |
| ULInformationTransferMRDC ::= SEQUENCE { | | | |
| ul-DCCH-MessageNR-r15 | OCTET STRING including the MeasurementReport message according to Table 8.2.3.8.1.3.3-7 | | |
| } | | | |

Table 8.2.3.8.1.3.3-7: MeasurementReport (Table 8.2.3.8.1.3.3-6)

| Derivation Path: 38.508-1 [4], Table 4.6.1-5A | | | |
|--|--|------------------|-----------------|
| Information Element | Value/remark | Comment | Condition |
| measurementReport ::= SEQUENCE { | | | |
| measResults SEQUENCE { | | | |
| measId | 1 | | |
| measResultServingMOList SEQUENCE (SIZE (1..maxNrofServingCells)) { | | Report NR Cell 1 | |
| servCellId | Cell index corresponding to NR Cell 1 | | |
| measResultServingCell SEQUENCE { | | | |
| physCellId | Phy cell id corresponding to NR Cell 1 | | |
| measResult SEQUENCE { | | | |
| cellResults SEQUENCE{ | | | |
| resultsSSB-Cell SEQUENCE { | | | |
| rsrp | (0..127) | | |
| rsrq | (0..127) | | |
| sinr | (0..127) | | pc_ss_SINR_Meas |
| Not present | | | |
| } | | | |
| } | | | |
| } | | | |
| } | | | |
| measResultNeighCells SEQUENCE (SIZE (1..maxCellReport)) { | 1 entry | Report NR Cell 2 | |
| measResultListNR SEQUENCE { | | | |
| physCellId | Phy cell id corresponding to NR Cell 2 | | |
| measResult SEQUENCE { | | | |
| cellResults SEQUENCE{ | | | |
| resultsSSB-Cell SEQUENCE { | | | |
| rsrp | (0..127) | | |
| rsrq | (0..127) | | |
| sinr | (0..127) | | pc_ss_SINR_Meas |
| Not present | | | |
| } | | | |
| } | | | |
| } | | | |
| resultsCSI-RS-Cell | Not present | | |
| rsIndexResults | Not present | | |
| cgi-Info | Not present | | |
| } | | | |

8.2.3.8.1a Measurement configuration control and reporting / Event A5 / Measurement of Neighbor NR cell / Inter-frequency measurements / EN-DC

8.2.3.8.1a.1 Test Purpose (TP)

(1)

```
with { UE in RRC_CONNECTED state with EN-DC, and, MCG(s) (E-UTRA PDCP) and SCG and inter-frequency
measurements configured for event A5 with event based periodical reporting }
ensure that {
  when { Serving NR PSCell becomes worse than absolute threshold1 and neighbour NR cell becomes
better than absolute threshold2 }
  then { UE sends MeasurementReport message at regular intervals while entering conditions for
event A5 are satisfied }
}
```

(2)

```
with { UE in RRC_CONNECTED state with EN-DC, and, MCG(s) (E-UTRA PDCP) and SCG and periodical
measurement reporting triggered by event A5 ongoing }
ensure that {
  when { Serving NR PSCell becomes better than absolute threshold1 or neighbour NR cell becomes
worse than absolute threshold2 }
  then { UE stops sending MeasurementReport message }
}
```

8.2.3.8.1a.2 Conformance requirements

Same as test case 8.2.3.8.1 with the following difference:

[TS 36.331, clause 5.5.2.9]

The UE shall:

1> if *measGapConfig* is set to *setup*:

...

2> if EN-DC is configured:

3> if the UE is configured with *fr1-Gap* set to *TRUE*:

4> apply the gap configuration for LTE serving cells and for NR serving cells on FR1;

3> else:

4> apply the gap configuration for all LTE and NR serving cells;

...

8.2.3.8.1a.3 Test description

8.2.3.8.1a.3.1 Pre-test conditions

Same as test case 8.2.3.8.1 with the following differences:

- Cells configuration: NR Cell 3 replaces NR Cell 2.

8.2.3.8.1a.3.2 Test procedure sequence

Same as test case 8.2.3.8.1 with the following differences:

- Cells configuration: NR Cell 3 replaces NR Cell 2.

8.2.3.8.1a.3.3 Specific message contents

Same as test case 8.2.3.8.1 with the following differences:

- Cells configuration: NR Cell 3 replaces NR Cell 2.

Table 8.2.3.8.1a.3.3-0: RRCConnectionReconfiguration (step 1, Table 8.2.3.8.1.3.2-2)

| Derivation Path: 36.508 [7], Table 4.6.1-8 with condition EN-DC_EmbedNR_RRCRecon | | | |
|--|-------------------------|---------|-----------|
| Information Element | Value/remark | Comment | Condition |
| RRCConnectionReconfiguration ::= SEQUENCE { | | | |
| criticalExtensions CHOICE { | | | |
| c1 CHOICE{ | | | |
| rrcConnectionReconfiguration-r8 SEQUENCE { | | | |
| measConfig | Table 8.2.3.8.1a.3.3-0a | | |
| } | | | |
| } | | | |
| } | | | |
| } | | | |

Table 8.2.3.8.1a.3.3-0a: measConfig (Table 8.2.3.8.1a.3.3-0)

| Derivation Path: 36.508 [7], Table 4.6.6-1 | | | |
|--|--------------|-----------------------------|-----------|
| Information Element | Value/remark | Comment | Condition |
| measConfig ::= SEQUENCE { | | | |
| measGapConfig CHOICE { | | | |
| setup SEQUENCE { | | | |
| gapOffset CHOICE { | | | |
| gp0 | 9 | MGRP = 40 ms,
MGL = 6 ms | |
| } | | | |
| } | | | |
| } | | | |
| fr1-gap-r15 | False | | |
| mgta-r15 | False | | |
| } | | | |

Table 8.2.3.8.1a.3.3-1: *MeasConfig-A5* (Table 8.2.3.8.1.3.3-2)

| Derivation Path: 38.508-1 [4] Table 4.6.3-69 | | | |
|---|---|--|---------------------|
| Information Element | Value/remark | Comment | Condition |
| MeasConfig ::= SEQUENCE { | | | |
| measObjectToAddModList SEQUENCE (SIZE (1..maxNrofMeasId)) OF MeasObjectToAddMod { | 2 entries | | |
| MeasObjectToAddMod[1] SEQUENCE { | | entry 1 | |
| measObjectId | 1 | | |
| measObject CHOICE { | | | |
| measObjectNR | MeasObjectNR-f1 | Table 8.2.3.8.1a.3.3-2 | |
| } | | | |
| } | | | |
| MeasObjectToAddMod[2] SEQUENCE { | | entry 2 | |
| measObjectId | 2 | | |
| measObject CHOICE { | | | |
| measObjectNR | MeasObjectNR-f2 | Table 8.2.3.8.1a.3.3-3 | |
| } | | | |
| } | | | |
| reportConfigToAddModList SEQUENCE(SIZE (1..maxReportConfigId)) OF ReportConfigToAddMod { | 1 entry | | |
| ReportConfigToAddMod[1] SEQUENCE { | | entry 1 | |
| reportConfigId | 1 | | |
| reportConfig CHOICE { | | | |
| reportConfigNR | ReportConfigNR(77,71)
Same as TS 38.508-1 [4],
Table 4.6.3-142 except
for hysteresis value in
eventA5 set to '0',
reportAmount set to
'infinity', and
reportInterval value is set
to 'ms1024' | Thresh values
set to -79dBm, -
85dBm | EVENT_A5
and FR1 |
| ReportConfigNR(66+
Delta(NRf1),57+Delta(NR
f2)). Same as TS 38.508-
1 Table 4.6.3-107 except
for hysteresis value in
eventA5 set to '0',
reportAmount set to
'infinity', and
reportInterval value set to
'ms1024'. | Thresh values
set to -91dBm,
-100 dBm | EVENT_A5
AND FR2 | |
| } | | | |
| } | | | |
| } | | | |
| measIdToAddModList SEQUENCE (SIZE (1..maxNrofMeasId)) OF MeasIdToAddMod { | 1 entry | | |
| MeasIdToAddMod[1] SEQUENCE { | | entry 1 | |
| measId | 1 | | |
| measObjectId | 2 | | |
| reportConfigId | 1 | | |
| } | | | |
| } | | | |
| } | | | |
| } | | | |
| NOTE 1: Delta(NRf1) and Delta(NRf2) is derived based on calibration procedure defined in the TS 38.508-1 [4], clause 6.1.3.3 | | | |

Table 8.2.3.8.1a.3.3-2: MeasObjectNR-f1 (Table 8.2.3.8.1a.3.3-1)

| Derivation Path: TS 38.508-1 [4], Table 4.6.3-76 | | | |
|--|------------------------------------|---------|-----------|
| Information Element | Value/remark | Comment | Condition |
| MeasObjectNR ::= SEQUENCE { | | | |
| ssbFrequency | ARFCN-ValueNR for SSB of NR Cell 1 | | |
| absThreshSS-BlocksConsolidation | Not present | | |
| nrofSS-BlocksToAverage | Not present | | |
| } | | | |

Table 8.2.3.8.1a.3.3-3: MeasObjectNR-f2 (Table 8.2.3.8.1a.3.3-1)

| Derivation Path: TS 38.508-1 [4], Table 4.6.3-76 | | | |
|--|------------------------------------|---------|-----------|
| Information Element | Value/remark | Comment | Condition |
| MeasObjectNR ::= SEQUENCE { | | | |
| ssbFrequency | ARFCN-ValueNR for SSB of NR Cell 3 | | |
| absThreshSS-BlocksConsolidation | Not present | | |
| nrofSS-BlocksToAverage | Not present | | |
| } | | | |

Table 8.2.3.8.1a.3.3-4: MeasConfig-A5 (Table 8.2.3.8.1.3.3-2, Step 5a1)

| Derivation Path: 38.508-1 [4], Table 4.6.3-69 | | | |
|--|---|--------------------------------------|------------------|
| Information Element | Value/remark | Comment | Condition |
| MeasConfig ::= SEQUENCE { | | | |
| measObjectToAddModList | MeasObjectNR | | |
| ReportConfigToAddModList SEQUENCE(SIZE (1..maxReportConfigId)) OF ReportConfigToAddMod { | 1 entry | | |
| ReportConfigToAddMod[1] SEQUENCE { | | entry 1 | |
| reportConfigId | ReportConfigId | | |
| reportConfig CHOICE { | | | |
| reportConfigNR | ReportConfigNR(66+Delta(NRf1),66+Delta(NRf2)). Same as TS 38.508-1 Table 4.6.3-107 except for hysteresis value in eventA5 set to '0', reportAmount set to 'infinity', and reportInterval value set to 'ms1024'. | Thresh values set to -91dBm, -91 dBm | EVENT_A5 AND FR2 |
| } | | | |
| } | | | |
| MeasIdToAddModList SEQUENCE(SIZE (1..maxNrofMeasId)) OF MeasIdToAddMod { | 1 entry | | |
| MeasIdToAddMod[1] SEQUENCE { | | entry 1 | |
| measId | 1 | | |
| measObjectId | 1 | | |
| reportConfigId | 1 | | |
| } | | | |
| } | | | |
| } | | | |
| NOTE 1: Delta(NRf1) and Delta(NRf2) is derived based on calibration procedure defined in the TS 38.508-1 [4], clause 6.1.3.3 | | | |

8.2.3.8.1b Measurement configuration control and reporting / Event A5 / Measurement of Neighbor NR cell / Inter-band measurements / EN-DC

8.2.3.8.1b.1 Test Purpose (TP)

(1)

```
with { UE in RRC_CONNECTED state with EN-DC, and, MCG(s) (E-UTRA PDCP) and SCG and inter-band
measurements configured for event A5 with event based periodical reporting }
ensure that {
  when { Serving NR PSCell becomes worse than absolute threshold1 and neighbour NR cell becomes
better than absolute threshold2 }
  then { UE sends MeasurementReport message at regular intervals while entering conditions for
event A5 are satisfied }
}
```

(2)

```
with { UE in RRC_CONNECTED state with EN-DC, and, MCG(s) (E-UTRA PDCP) and SCG and periodical
measurement reporting triggered by event A5 ongoing }
ensure that {
  when { Serving NR PSCell becomes better than absolute threshold1 or neighbour NR cell becomes
worse than absolute threshold2 }
  then { UE stops sending MeasurementReport message }
}
```

8.2.3.8.1b.2 Conformance requirements

Same as test case 8.2.3.8.1 with the following difference:

[TS 36.331, clause 5.5.2.9]

The UE shall:

1> if *measGapConfig* is set to *setup*:

...

2> if EN-DC is configured:

3> if the UE is configured with *fr1-Gap* set to *TRUE*:

4> apply the gap configuration for LTE serving cells and for NR serving cells on FR1;

3> else:

4> apply the gap configuration for all LTE and NR serving cells;

...

8.2.3.8.1b.3 Test description

8.2.3.8.1b.3.1 Pre-test conditions

Same as test case 8.2.3.8.1 with the following differences:

- Cells configuration: NR Cell 10 replaces NR Cell 2.

8.2.3.8.1b.3.2 Test procedure sequence

Same as test case 8.2.3.8.1 with the following differences:

- Cells configuration: NR Cell 10 replaces NR Cell 2.

8.2.3.8.1b.3.3 Specific message contents

Same as test case 8.2.3.8.1 with the following differences:

- Cells configuration: NR Cell 10 replaces NR Cell 2.

Table 8.2.3.8.1b.3.3-0: RRCConnectionReconfiguration (step 1, Table 8.2.3.8.1.3.2-2)

| Derivation Path: 36.508 [7], Table 4.6.1-8 with condition EN-DC_EmbedNR_RRCRecon | | | |
|--|-------------------------|---------|-----------|
| Information Element | Value/remark | Comment | Condition |
| RRCConnectionReconfiguration ::= SEQUENCE { | | | |
| criticalExtensions CHOICE { | | | |
| c1 CHOICE{ | | | |
| rrcConnectionReconfiguration-r8 SEQUENCE { | | | |
| measConfig | Table 8.2.3.8.1b.3.3-0a | | |
| } | | | |
| } | | | |
| } | | | |

Table 8.2.3.8.1b.3.3-0a: measConfig (Table 8.2.3.8.1b.3.3-0)

| Derivation Path: 36.508 [7], Table 4.6.6-1 | | | |
|--|--------------|-----------------------------|-----------|
| Information Element | Value/remark | Comment | Condition |
| measConfig SEQUENCE { | | | |
| measGapConfig CHOICE { | | | |
| setup SEQUENCE { | | | |
| gapOffset CHOICE { | | | |
| gp0 | 9 | MGRP = 40 ms,
MGL = 6 ms | |
| } | | | |
| } | | | |
| } | | | |
| fr1-gap-r15 | False | | |
| mgta-r15 | False | | |
| } | | | |

Table 8.2.3.8.1b.3.3-1: *MeasConfig-A5* (Table 8.2.3.8.1.3.3-2)

| Derivation Path: 38.508-1 [4] Table 4.6.3-69 | | | |
|--|---|--|-----------|
| Information Element | Value/remark | Comment | Condition |
| MeasConfig ::= SEQUENCE { | | | |
| measObjectToAddModList SEQUENCE (SIZE (1..maxNrofMeasId)) OF MeasObjectToAddMod { | 2 entries | | |
| MeasObjectToAddMod[1] SEQUENCE { | | entry 1 | |
| measObjectId | 1 | | |
| measObject CHOICE { | | | |
| measObjectNR | MeasObjectNR-f1 | Table 8.2.3.8.1b.3.3-2 | |
| } | | | |
| } | | | |
| MeasObjectToAddMod[2] SEQUENCE { | | entry 2 | |
| measObjectId | 2 | | |
| measObject CHOICE { | | | |
| measObjectNR | MeasObjectNR-f2 | Table 8.2.3.8.1b.3.3-3 | |
| } | | | |
| } | | | |
| reportConfigToAddModList SEQUENCE(SIZE (1..maxReportConfigId)) OF ReportConfigToAddMod { | 1 entry | | |
| ReportConfigToAddMod[1] SEQUENCE { | | entry 1 | |
| reportConfigId | 1 | | |
| reportConfig CHOICE { | | | |
| reportConfigNR | ReportConfigNR(77,71)
Same as TS 38.508-1 [4],
Table 4.6.3-142 except
for hysteresis value in
eventA5 set to '0',
reportAmount set to
'infinity', and
reportInterval value is set
to 'ms1024' | Thresh values
set to -79dBm, -
85dBm | EVENT_A5 |
| } | | | |
| } | | | |
| } | | | |
| measIdToAddModList SEQUENCE (SIZE (1..maxNrofMeasId)) OF MeasIdToAddMod { | 1 entry | | |
| MeasIdToAddMod[1] SEQUENCE { | | entry 1 | |
| measId | 1 | | |
| measObjectId | 2 | | |
| reportConfigId | 1 | | |
| } | | | |
| } | | | |
| } | | | |

Table 8.2.3.8.1b.3.3-2: *MeasObjectNR-f1* (Table 8.2.3.8.1b.3.3-1)

| Derivation Path: TS 38.508-1 [4], Table 4.6.3-76 | | | |
|--|---------------------------------------|---------|-----------|
| Information Element | Value/remark | Comment | Condition |
| MeasObjectNR ::= SEQUENCE { | | | |
| ssbFrequency | ARFCN-ValueNR for
SSB of NR Cell 1 | | |
| absThreshSS-BlocksConsolidation | Not present | | |
| nrofSS-BlocksToAverage | Not present | | |
| } | | | |

Table 8.2.3.8.1b.3.3-3: MeasObjectNR-f2 (Table 8.2.3.8.1b.3.3-1)

| Derivation Path: TS 38.508-1 [4], Table 4.6.3-76 | | | |
|--|-------------------------------------|---------|-----------|
| Information Element | Value/remark | Comment | Condition |
| MeasObjectNR ::= SEQUENCE { | | | |
| ssbFrequency | ARFCN-ValueNR for SSB of NR Cell 10 | | |
| absThreshSS-BlocksConsolidation | Not present | | |
| nrofSS-BlocksToAverage | Not present | | |
| } | | | |

8.2.3.9 Measurement configuration control and reporting / SS/PBCH block based / CSI-RS based intra-frequency measurements / Measurement of Neighbour NR cell

8.2.3.9.1 Measurement configuration control and reporting / SS/PBCH block based / CSI-RS based Intra-frequency measurements / Measurement of Neighbour NR Cell / EN-DC

8.2.3.9.1.1 Test Purpose (TP)

(1)

```
with { UE in RRC_CONNECTED state in EN-DC mode and measurement configured for SS/PBCH measurement
reporting of intra-frequency on specified frequency }
ensure that {
  when { SS/PBCH block sorting quantity is above absThreshSS-BlocksConsolidation for each beam of NR
Neighbour Cell }
  then { UE sends MeasurementReport message containing rsIndexResults with resultsSSB-Indexes }
}
```

(2)

```
with { UE in RRC_CONNECTED state in EN-DC mode and measurement configured for SS/PBCH measurement
reporting of intra-frequency on specified frequency }
ensure that {
  when { SS/PBCH block sorting quantity is below absThreshSS-BlocksConsolidation for one beam of NR
Neighbour Cell and another beam(s) is above absThreshSS-BlocksConsolidation }
  then { UE sends MeasurementReport message containing rsIndexResults with resultsSSB-Indexes
includes RsIndex above absThreshSS-BlocksConsolidation and excludes RsIndex below absThreshSS-
BlocksConsolidation }
}
```

(3)

```
with { UE in RRC_CONNECTED state in EN-DC mode and measurement configured for CSI-RS measurement
reporting of intra frequency on specified frequency }
ensure that {
  when { CSI-RS sorting quantity is above absThreshCSI-RS-Consolidation for each beam of NR
Neighbour Cell }
  then { UE sends MeasurementReport message containing rsIndexResults with resultsCSI-RS-Indexes }
}
```

(4)

```
with { UE in RRC_CONNECTED state in EN-DC mode and measurement configured for CSI-RS measurement
reporting of intra frequency on specified frequency }
ensure that {
  when { CSI-RS sorting quantity is below absThreshCSI-RS-Consolidation for one beam of NR Neighbour
Cell and another beam(s) is above absThreshCSI-RS-Consolidation }
  then { UE sends MeasurementReport message containing rsIndexResults with resultsCSI-RS-Indexes
includes RsIndex above absThreshCSI-RS-Consolidation and excludes RsIndex below absThreshCSI-RS-
Consolidation }
}
```

8.2.3.9.1.2 Conformance requirements

References: The conformance requirements covered in the present TC are specified in: TS 38.331 clauses 5.5.5.1 and 5.5.5.2. Unless otherwise stated these are Rel-15 requirements.

[TS 38.331, clause 5.5.5.1]

The purpose of this procedure is to transfer measurement results from the UE to the network. The UE shall initiate this procedure only after successful security activation.

For the *measId* for which the measurement reporting procedure was triggered, the UE shall set the *measResults* within the *MeasurementReport* message as follows:

- 1> set the *measId* to the measurement identity that triggered the measurement reporting;
- 1> for each serving cell configured with *servingCellMO*:
 - 2> if the *reportConfig* associated with the *measId* that triggered the measurement reporting includes *rsType*:
 - 3> if the serving cell measurements based on the *rsType* included in the *reportConfig* that triggered the measurement report are available:
 - 4> set the *measResultServingCell* within *measResultServingMOList* to include RSRP, RSRQ and the available SINR of the serving cell, derived based on the *rsType* included in the *reportConfig* that triggered the measurement report;
 - 2> else:
 - 3> if SSB based serving cell measurements are available:
 - 4> set the *measResultServingCell* within *measResultServingMOList* to include RSRP, RSRQ and the available SINR of the serving cell, derived based on SSB;
 - 3> else if CSI-RS based serving cell measurements are available:
 - 4> set the *measResultServingCell* within *measResultServingMOList* to include RSRP, RSRQ and the available SINR of the serving cell, derived based on CSI-RS;
 - 1> set the *servingCellId* within *measResultServingMOList* to include for each NR serving cell that is configured, if any;
 - 1> if the *reportConfig* associated with the *measId* that triggered the measurement reporting includes *reportQuantityRS-Indexes* and *maxNrofRS-IndexesToReport*:
 - 2> for each serving cell configured with *servingCellMO*, include beam measurement information according to the associated *reportConfig* as described in 5.5.5.2;
- ...
- 1> if there is at least one applicable neighbouring cell to report:
 - 2> if the *reportType* is set to *eventTriggered* or *periodical*:
 - 3> set the *measResultNeighCells* to include the best neighbouring cells up to *maxReportCells* in accordance with the following:
 - 4> if the *reportType* is set to *eventTriggered*:
 - 5> include the cells included in the *cellsTriggeredList* as defined within the *VarMeasReportList* for this *measId*;
 - 4> else:
 - 5> include the applicable cells for which the new measurement results became available since the last periodical reporting or since the measurement was initiated or reset;
 - 4> for each cell that is included in the *measResultNeighCells*, include the *physCellId*;

- 4> if the *reportType* is set to *eventTriggered*:
 - 5> for each included cell, include the layer 3 filtered measured results in accordance with the *reportConfig* for this *measId*, ordered as follows:
 - 6> if the *measObject* associated with this *measId* concerns NR:
 - 7> if *rsType* in the associated *reportConfig* is set to *ssb*:
 - 8> set *resultsSSB-Cell* within the *measResult* to include the SS/PBCH block based quantity(ies) indicated in the *reportQuantityCell* within the concerned *reportConfig*, in decreasing order of the sorting quantity, determined as specified in 5.5.5.3, i.e. the best cell is included first;
 - 8> if *reportQuantityRS-Indexes* and *maxNrofRS-IndexesToReport* are configured, include beam measurement information as described in 5.5.5.2;
 - 7> else if *rsType* in the associated *reportConfig* is set to *csi-rs*:
 - 8> set *resultsCSI-RS-Cell* within the *measResult* to include the CSI-RS based quantity(ies) indicated in the *reportQuantityCell* within the concerned *reportConfig*, in decreasing order of the sorting quantity, determined as specified in 5.5.5.3, i.e. the best cell is included first;
 - 8> if *reportQuantityRS-Indexes* and *maxNrofRS-IndexesToReport* are configured, include beam measurement information as described in 5.5.5.2;

[TS 38.331, clause 5.5.5.1]

- 1> increment the *numberOfReportsSent* as defined within the *VarMeasReportList* for this *measId* by 1;
- 1> stop the periodical reporting timer, if running;
- 1> if the *numberOfReportsSent* as defined within the *VarMeasReportList* for this *measId* is less than the *reportAmount* as defined within the corresponding *reportConfig* for this *measId*:
 - 2> start the periodical reporting timer with the value of *reportInterval* as defined within the corresponding *reportConfig* for this *measId*;
- 1> else:
 - 2> if the *reportType* is set to *periodical*:
 - 3> remove the entry within the *VarMeasReportList* for this *measId*;
 - 3> remove this *measId* from the *measIdList* within *VarMeasConfig*;
- 1> if the UE is in (NG)EN-DC:
 - 2> if SRB3 is configured:
 - 3> submit the *MeasurementReport* message via SRB3 to lower layers for transmission, upon which the procedure ends;
 - 2>else:
 - 3> submit the *MeasurementReport* message via the EUTRA MCG embedded in E-UTRA RRC message *ULInformationTransferMRDC* as specified in TS 36.331 [10].

[TS 38.331, clause 5.5.5.2]

For beam measurement information to be included in a measurement report the UE shall:

- 1> if *reportType* is set to *eventTriggered*:
 - 2> consider the trigger quantity as the sorting quantity if available, otherwise RSRP as sorting quantity if available, otherwise RSRQ as sorting quantity if available, otherwise SINR as sorting quantity;

- 1> set *rsIndexResults* to include up to *maxNrofRS-IndexesToReportSS/PBCH* block indexes or CSI-RS indexes in order of decreasing sorting quantity as follows:
 - 2> if the measurement information to be included is based on SS/PBCH block:
 - 3> include within *resultsSSB-Indexes* the index associated to the best beam for that SS/PBCH block sorting quantity and if *absThreshSS-BlocksConsolidation* is included in the *VarMeasConfig* for the *measObject* associated to the cell for which beams are to be reported, the remaining beams whose sorting quantity is above *absThreshSS-BlocksConsolidation*;
 - 3> if *includeBeamMeasurements* is configured, include the SS/PBCH based measurement results for the quantities in *reportQuantityRS-Indexes* set to *true* for each SS/PBCH block index;
 - 2> else if the beam measurement information to be included is based on CSI-RS:
 - 3> include within *resultsCSI-RS-Indexes* the index associated to the best beam for that CSI-RS sorting quantity and, if *absThreshCSI-RS-Consolidation* is included in the *VarMeasConfig* for the *measObject* associated to the cell for which beams are to be reported, the remaining beams whose sorting quantity is above *absThreshCSI-RS-Consolidation*;
 - 3> if *includeBeamMeasurements* is configured, include the CSI-RS based measurement results for the quantities in *reportQuantityRS-Indexes* set to *true* for each CSI-RS index.

8.2.3.9.1.3 Test description

8.2.3.9.1.3.1 Pre-test conditions

System Simulator:

- EUTRA Cell 1 is the PCell and NR Cell 1 is the PS Cell and NR Cell 2 is the intra-frequency neighbour cell of NR Cell 1. NR Cell2 has two beams: SSB/CSI-RS index#0 and SSB/CSI-RS index#1.

UE:

- None

Preamble:

- The UE is in state RRC_CONNECTED in EN-DC using generic procedure parameter Connectivity (EN-DC) and DC Bearers (MCG(s) and SCG) on E-UTRA Cell 1 according to TS 38.508-1 [4].

8.2.3.9.1.3.2 Test procedure sequence

Table 8.2.3.9.1.3.2-1 and Table 8.2.3.9.1.3.2-1A illustrates the downlink power levels to be applied for NR Cell 1 and NR Cell 2 at various time instants of the test execution. Row marked "T0" denotes the conditions after the preamble, while rows marked "T1" and "T2" are to be applied subsequently. The exact instants on which these values shall be applied are described in the texts in this clause.

Table 8.2.3.9.1.3.2-1: Time instances of cell power level and parameter changes for FR1

| | Parameter | Unit | E-UTRA Cell 1 | NR Cell 1 | NR Cell 2 | NR Cell 2 Beam 0 (NOTE) | NR Cell 2 Beam 1 (NOTE) | Remark |
|-------|---|------------|---------------|-----------|-----------|-------------------------|-------------------------|---|
| T0 | Cell-specific RS EPRE | dBm/15k Hz | -85 | - | - | - | - | |
| | SS/PBCH SSS EPRE | dBm/SC S | - | -94 | - | - | - | |
| | Reference Power | dBm/SC S | - | - | -90 | - | - | |
| | SS/PBCH SSS EPRE, CSI-RS EPRE offset | dB | - | - | - | -4 | -4 | |
| T1 | Cell-specific RS EPRE | dBm/15k Hz | -85 | - | - | - | - | $Mn + Ofn + Ocn - Hys > Mp + Ofp + Ocp + Off$
Power level is such that SS/PBCH quality and CSI-RS quality for both beams of NR Cell 2 are above <i>absThreshSS-BlocksConsolidation</i> . |
| | SS/PBCH SSS EPRE | dBm/SC S | - | -106 | - | - | - | |
| | Reference Power | dBm/SC S | - | - | -90 | - | - | |
| | SS/PBCH SSS EPRE, CSI-RS EPRE offset | dB | - | - | - | -4 | -4 | |
| T2 | Cell-specific RS EPRE | dBm/15k Hz | -85 | - | - | - | - | $Mn + Ofn + Ocn + Hys < Mp + Ofp + Ocp + Off$
Power level is such that SS/PBCH quality and CSI-RS quality for both beams of NR Cell 2 are below <i>absThreshSS-BlocksConsolidation</i> |
| | SS/PBCH SSS EPRE | dBm/SC S | - | -106 | - | - | - | |
| | Reference Power | dBm/SC S | - | - | -90 | - | - | |
| | SS/PBCH SSS EPRE, CSI-RS EPRE offset | dB | - | - | - | -12 | -12 | |
| T3 | Cell-specific RS EPRE | dBm/15k Hz | -85 | - | - | - | - | Power level is such that SS/PBCH quality and CSI-RS quality for beam 0 of NR Cell 2 is above <i>absThreshSS-BlocksConsolidation</i> and for beam 1 of NR Cell 2 is below <i>absThreshSS-BlocksConsolidation</i> . |
| | SS/PBCH SSS EPRE | dBm/SC S | - | -106 | - | - | - | |
| | Reference Power | dBm/SC S | - | - | -90 | - | - | |
| | SS/PBCH SSS EPRE, CSI-RS EPRE offset | dB | - | - | - | -4 | -12 | |
| NOTE: | "Beam 0" refers to transmission of the SS/PBCH block with SSB index #0 (according to the <i>ssb-PositionsInBurst</i>) and CSI-RS with index #0 (according to the <i>csi-rs-ResourceList-Mobility</i> being signalled to the UE at step 9); "Beam 1" refers to transmission of the SS/PBCH block with SSB index #1 (according to the <i>ssb-PositionsInBurst</i>) and CSI-RS with index #1 (according to the <i>csi-rs-ResourceList-Mobility</i> being signalled to the UE at step 9). For each beam SSS and CSI-RS have the same power levels at any given time instance. | | | | | | | |

Table 8.2.3.9.1.3.2-1A: Time instances of cell power level and parameter changes for FR2

| | Parameter | Unit | E-UTRA Cell 1 | NR Cell 1 | NR Cell 2 | NR Cell 2 Beam 0 (NOTE) | NR Cell 2 Beam 1 (NOTE) | Remark |
|-------|---|------------|---------------|-----------|-----------|-------------------------|-------------------------|---|
| T0 | Cell-specific RS EPRE | dBm/15k Hz | -96 | - | - | - | - | |
| | SS/PBCH SSS EPRE | dBm/SC S | - | -82 | - | - | - | |
| | Reference Power | dBm/SC S | - | - | -90 | - | - | |
| | SS/PBCH SSS EPRE, CSI-RS EPRE offset | dB | - | - | - | -1 | -1 | |
| T1 | Cell-specific RS EPRE | dBm/15k Hz | -96 | - | - | - | - | $Mn + Ofn + Ocn - Hys > Mp + Ofp + Ocp + Off$
Power level is such that SS/PBCH quality and CSI-RS quality for both beams of NR Cell 2 are above <i>absThreshSS-BlocksConsolidation</i> . |
| | SS/PBCH SSS EPRE | dBm/SC S | - | -100 | - | - | - | |
| | Reference Power | dBm/SC S | - | - | -90 | - | - | |
| | SS/PBCH SSS EPRE, CSI-RS EPRE offset | dB | - | - | - | -1 | -1 | |
| T2 | Cell-specific RS EPRE | dBm/15k Hz | -96 | - | - | - | - | $Mn + Ofn + Ocn + Hys < Mp + Ofp + Ocp + Off$
Power level is such that SS/PBCH quality and CSI-RS quality for both beams of NR Cell 2 are below <i>absThreshSS-BlocksConsolidation</i> |
| | SS/PBCH SSS EPRE | dBm/SC S | - | -82 | - | - | - | |
| | Reference Power | dBm/SC S | - | - | -90 | - | - | |
| | SS/PBCH SSS EPRE, CSI-RS EPRE offset | dB | - | - | - | -10 | -10 | |
| T3 | Cell-specific RS EPRE | dBm/15k Hz | -96 | - | - | - | - | Power level is such that SS/PBCH quality and CSI-RS quality for beam 0 of NR Cell 2 is above <i>absThreshSS-BlocksConsolidation</i> and for beam 1 of NR Cell 2 is below <i>absThreshSS-BlocksConsolidation</i> . |
| | SS/PBCH SSS EPRE | dBm/SC S | - | -100 | - | - | - | |
| | Reference Power | dBm/SC S | - | - | -90 | - | - | |
| | SS/PBCH SSS EPRE, CSI-RS EPRE offset | dB | - | - | - | -1 | -10 | |
| NOTE: | "Beam 0" refers to transmission of the SS/PBCH block with SSB index #0 (according to the <i>ssb-PositionsInBurst</i>) and CSI-RS with index #0 (according to the <i>csi-rs-ResourceList-Mobility</i> being signalled to the UE at step 9); "Beam 1" refers to transmission of the SS/PBCH block with SSB index #1 (according to the <i>ssb-PositionsInBurst</i>) and CSI-RS with index #1 (according to the <i>csi-rs-ResourceList-Mobility</i> being signalled to the UE at step 9). For each beam SSS and CSI-RS have the same power levels at any given time instance. | | | | | | | |

Table 8.2.3.9.1.3.2-2: Main behaviour

| St | Procedure | Message Sequence | | TP | Verdict |
|-----|--|------------------|---|----|---------|
| | | U - S | Message | | |
| 1 | The SS transmits an <i>RRCConnectionReconfiguration</i> message containing NR <i>RRCReconfiguration</i> including <i>measConfig</i> to setup SS/PBCH block based intra-frequency NR measurement for PSCell (NR Cell 1) and reporting for event A3. | <-- | EUTRA RRC:
<i>RRCConnectionReconfiguration(RRCReconfiguration)</i> | - | - |
| 2 | The UE transmits an <i>RRCConnectionReconfigurationComplete</i> message containing NR <i>RRCReconfigurationComplete</i> . | --> | EUTRA RRC:
<i>RRCConnectionReconfigurationComplete(RRCReconfigurationComplete)</i> | - | - |
| 3 | The SS re-adjusts the cell-specific reference signal level according to row "T1". | - | - | - | - |
| 4 | Check: Does the UE transmit a <i>MeasurementReport</i> message to report event A3 with the measured results for NR Cell 2 with beam information containing <i>RsIndex[0]</i> and <i>RsIndex[1]</i> ? | --> | EUTRA RRC:
<i>ULInformationTransferMRDC(MeasurementReport)</i> | 1 | P |
| 4A | The SS re-adjusts the cell-specific reference signal level according to the row "T2". | - | - | - | - |
| 4B | Check: Does the UE transmit a <i>MeasurementReport</i> message on E-UTRA Cell 1 to report the event A3 during the next 10s? | - | - | 1 | F |
| 5 | The SS re-adjusts the cell-specific reference signal level according to row "T3". | - | - | - | - |
| 6 | Check: Does the UE transmit a <i>MeasurementReport</i> message to report event A3 with the measured results for NR Cell 2 with beam information containing <i>RsIndex[0]</i> and excludes <i>RsIndex[1]</i> ? | --> | EUTRA RRC:
<i>ULInformationTransferMRDC(MeasurementReport)</i> | 2 | P |
| 7-8 | Void | - | - | - | - |
| 9 | The SS transmits an <i>RRCConnectionReconfiguration</i> message containing NR <i>RRCReconfiguration</i> including <i>measConfig</i> to setup CSI-RS based intra-frequency NR measurement for PSCell (NR Cell 1) and reporting for event A3. | <-- | EUTRA RRC:
<i>RRCConnectionReconfiguration(RRCReconfiguration)</i> | - | - |
| 10 | The UE transmits an <i>RRCConnectionReconfigurationComplete</i> message containing NR <i>RRCReconfigurationComplete</i> . | --> | EUTRA RRC:
<i>RRCConnectionReconfigurationComplete(RRCReconfigurationComplete)</i> | - | - |
| 11 | SS re-adjusts the cell-specific reference signal level according to row "T1". | - | - | - | - |
| 12 | Check: Does the UE transmit a <i>MeasurementReport</i> message to report event A3 with the measured results for NR Cell 2 with beam information containing <i>RsIndex[0]</i> and <i>RsIndex[1]</i> ? | --> | EUTRA RRC:
<i>ULInformationTransferMRDC(MeasurementReport)</i> | 3 | P |
| 12A | The SS re-adjusts the cell-specific reference signal level according to the row "T2". | - | - | - | - |
| 12B | Check: Does the UE transmit a <i>MeasurementReport</i> message on E-UTRA Cell 1 to report the event A3 during the next 10s? | - | - | 3 | F |
| 13 | The SS re-adjusts the cell-specific reference signal level according to row "T3". | - | - | - | - |
| 14 | Check: Does the UE transmit a <i>MeasurementReport</i> message to report event A3 with the measured results for NR Cell 2 with beam information containing <i>RsIndex[0]</i> and excludes <i>RsIndex[1]</i> ? | --> | EUTRA RRC:
<i>ULInformationTransferMRDC(MeasurementReport)</i> | 4 | P |

8.2.3.9.1.3.3 Specific message contents

Table 8.2.3.9.1.3.3-1: RRCConnectionReconfiguration (steps 1, 9 Table 8.2.3.9.1.3.2-2)

Derivation Path: 36.508 [7], Table 4.6.1-8 with condition EN-DC_EmbedNR_RRCRecon

Table 8.2.3.9.1.3.3-2: RRCReconfiguration (Table 8.2.3.9.1.3.3-1)

Derivation Path: 38.508-1 [4], Table 4.6.1-13 with condition EN-DC_MEAS

Table 8.2.3.9.1.3.3-3: MeasConfig (Table 8.2.3.9.1.3.3-2)

| Derivation Path: 38.508-1 [4], Table 4.6.3-69 | | | |
|---|---------------------|---------|-----------|
| Information Element | Value/remark | Comment | Condition |
| MeasConfig ::= SEQUENCE { | | | |
| measObjectToAddModList | IdMeasObjectToAdd | | Step 1 |
| | Not present | | Step 9 |
| reportConfigToAddModList | IdReportConfigToAdd | | Step 1 |
| | Not present | | Step 9 |
| measIdToAddModList | IdMeasIdToAdd | | |
| } | | | |

Table 8.2.3.9.1.3.3-4: IdMeasObjectToAdd (Table 8.2.3.9.1.3.3-3)

| Derivation Path: TS 38.331 [6], clause 6.3.2 | | | |
|---|-----------------|---------|-----------|
| Information Element | Value/remark | Comment | Condition |
| MeasObjectToAddModList ::= SEQUENCE (SIZE (1..maxNrofMeasId)) OF MeasObjectToAddMod { | 1 entry | | |
| MeasObjectToAddMod[1] SEQUENCE { | | entry 1 | |
| measObjectId | 1 | | |
| measObject CHOICE { | | | |
| measObjectNR | Id-MeasObjectNR | | |
| } | | | |
| } | | | |
| } | | | |

Table 8.2.3.9.1.3.3-5: Id-MeasObjectNR (Table 8.2.3.9.1.3.3-4)

| Derivation Path: 38.508-1 [4], Table 4.6.3-76 | | | |
|--|--|---|--|
| Information Element | Value/remark | Comment | Condition |
| MeasObjectNR ::= SEQUENCE { | | | |
| ssbFrequency | Downlink ARFCN of NR Cell 1 | | |
| refFreqCSI-RS | Same as "Point A" defined for the downlink of NR Cell 1 | | |
| referenceSignalConfig SEQUENCE { | | | |
| ssb-ConfigMobility SEQUENCE { | | | |
| ssb-ToMeasure CHOICE { | | | |
| setup CHOICE { | | | |
| shortBitmap | 1100 | | (FREQ<=3G Hz AND (FR1_FDD OR NOT CASE_C)) OR (FREQ<=2.4 GHz AND FR1_TDD) |
| mediumBitmap | 11000000 | | (FREQ>3G Hz AND FR1) OR (FREQ>2.4 GHz AND FR1_TDD AND CASE_C) |
| longBitmap | 11000000 00000000
00000000 00000000
00000000 00000000
00000000 00000000 | | FR2 |
| } | | | |
| } | | | |
| } | | | |
| csi-rs-ResourceConfigMobility CHOICE { | | | |
| setup SEQUENCE { | | | |
| subcarrierSpacing | SubcarrierSpacing | | |
| csi-RS-CellList-Mobility SEQUENCE (SIZE (1..maxNrofCSI-RS-CellsRRM)) OF CSI-RS-CellMobility { | 2 entries | | |
| CSI-RS-CellMobility SEQUENCE { | | entry 1 | |
| cellId | Physical CellID of the NR Cell 1 | | |
| csi-rs-MeasurementBW SEQUENCE { | | | |
| nrofPRBs | size24 | | |
| startPRB | same value as 'offsetToCarrier' as defined for the DL frequency of NR Cell 1 | | |
| } | | | |
| density | d3 | | |
| csi-rs-ResourceList-Mobility SEQUENCE (SIZE (1..maxNrofCSI-RS-ResourcesRRM)) OF CSI-RS-Resource-Mobility { | 1 entry | | |
| CSI-RS-Resource-Mobility[1] SEQUENCE { | | entry 1 | |
| csi-RS-Index | 0 | | |
| slotConfig CHOICE { | | | |
| ms20 | 0 | To avoid collision with CSI-RS of NR Cell 2 | |
| } | | | |
| associatedSSB | Not present | | |
| } | | | |
| } | | | |
| associatedSSB SEQUENCE { | | | pc_csi_RSR |

| | | | |
|---|--|--|---|
| | | | P_AndRSR
Q_MeasWit
hSSB |
| ssb-Index | 0 | | |
| isQuasiColocated | false | | |
| } | | | |
| frequencyDomainAllocation CHOICE { | | | |
| row1 | 1000 | | |
| } | | | |
| firstOFDMSymbolInTimeDomain | 4 | | |
| sequenceGenerationConfig | 24 | | |
| } | | | |
| } | | | |
| CSI-RS-CellMobility[2] SEQUENCE { | | entry 2 | |
| cellId | Physical CellID of the NR
Cell 2 | | |
| csi-rs-MeasurementBW[2] SEQUENCE { | | | |
| nrofPRBs | size24 | | |
| startPRB | same value as
'offsetToCarrier' as
defined for the DL
frequency of the cell | | |
| } | | | |
| density | d3 | | |
| csi-rs-ResourceList-Mobility SEQUENCE
(SIZE (1..maxNrofCSI-RS-ResourcesRRM)) OF CSI-
RS-Resource-Mobility { | 2 entries | | |
| CSI-RS-Resource-Mobility[1] SEQUENCE { | | entry 1 | |
| csi-RS-Index | 0 | CSI-RS with Index
0 | |
| slotConfig CHOICE { | | | |
| ms20 | $10 * 2^\mu$ | μ is numerology
index
(SCS=15kHz: 0,
SCS=30kHz: 1,
etc.) | |
| } | | | |
| } | | | |
| associatedSSB | Not present | | |
| associatedSSB SEQUENCE { | | | pc_csi_RSR
P_AndRSR
Q_MeasWit
hSSB |
| ssb-Index | 0 | | |
| isQuasiColocated | false | | |
| } | | | |
| frequencyDomainAllocation CHOICE { | | | |
| row1 | 1000 | | |
| } | | | |
| firstOFDMSymbolInTimeDomain | 4 | | |
| sequenceGenerationConfig | 24 | | |
| } | | | |
| CSI-RS-Resource-Mobility[2] SEQUENCE { | | entry 2 | |
| csi-RS-Index | 1 | CSI-RS with Index
1 | |
| slotConfig CHOICE { | | | |
| ms20 | $10 * 2^\mu$ | μ : numerology
index
(SCS=15kHz: 0,
SCS=30kHz: 1,
etc.) | |
| } | | | |
| associatedSSB | Not present | | |
| associatedSSB SEQUENCE { | | | pc_csi_RSR
P_AndRSR
Q_MeasWit |

| | | | |
|---|-------|-------------------------|------|
| | | | hSSB |
| ssb-Index | 1 | | |
| isQuasiColocated | false | | |
| } | | | |
| frequencyDomainAllocation CHOICE { | | | |
| row1 | 0001 | | |
| } | | | |
| firstOFDMSymbolInTimeDomain | 0 | | |
| sequenceGenerationConfig | 24 | | |
| } | | | |
| } | | | |
| } | | | |
| } | | | |
| } | | | |
| } | | | |
| absThreshSS-BlocksConsolidation SEQUENCE { | | | |
| thresholdRSRP | 57 | corresponding to -99dBm | FR1 |
| | 66 | corresponding to -90dBm | FR2 |
| } | | | |
| absThreshCSI-RS-Consolidation SEQUENCE { | 2 | | |
| thresholdRSRP57corresponding to -99dBmFR166corresponding to -90dBmFR2 | | | |
| thresholdRSRQNot Present thresholdSINRNot Present } | | | |
| nrofCSI-RS-ResourcesToAverage | | | |
| } | | | |

Table 8.2.3.9.1.3.3-6: IdReportConfigToAdd (Table 8.2.3.9.1.3.3-3)

| Derivation Path: TS 38.331 [6], clause 6.3.2 | | | |
|--|--------------------------|---------|-----------|
| Information Element | Value/remark | Comment | Condition |
| ReportConfigToAddModList ::= SEQUENCE(SIZE (1..maxReportConfigId)) OF ReportConfigToAddMod { | 2 entries | | |
| ReportConfigToAddMod[1] SEQUENCE { | | entry 1 | |
| reportConfigId | 1 | | |
| reportConfig CHOICE { | | | |
| reportConfigNR | IdReportConfig-A3-SSB | | |
| } | | | |
| } | | | |
| ReportConfigToAddMod[2] SEQUENCE { | | entry 2 | |
| reportConfigId | 2 | | |
| reportConfig CHOICE { | | | |
| reportConfigNR | IdReportConfig-A3-CSI-RS | | |
| } | | | |
| } | | | |
| } | | | |

Table 8.2.3.9.1.3.3-7: IdReportConfig-A3-SSB (Table 8.2.3.9.1.3.3-6)

| Derivation Path: 38.508-1 [4], Table 4.6.3-142 with condition EVENT_A3 | | | |
|--|--------------|---------|-----------|
| Information Element | Value/remark | Comment | Condition |
| ReportConfigNR ::= SEQUENCE { | | | |
| reportType CHOICE { | | | |
| eventTriggered SEQUENCE { | | | |
| eventId CHOICE { | | | |
| eventA3 SEQUENCE { | | | |
| a3-Offset CHOICE { | | | |
| rsrp | 2 | | |
| } | | | |
| } | | | |
| } | | | |
| reportAmount | r1 | | |
| reportQuantityRS-Indexes SEQUENCE { | | | |
| rsrp | true | | |
| rsrq | false | | |
| sinr | false | | |
| } | | | |
| maxNrofRS-IndexesToReport | 2 | | |
| includeBeamMeasurements | true | | |
| } | | | |
| } | | | |

Table 8.2.3.9.1.3.3-7A: IdReportConfig-A3-CSI-RS (Table 8.2.3.9.1.3.3-6)

| Derivation Path: 38.508-1 [4], Table 4.6.3-142 with condition EVENT_A3 | | | |
|--|--------------|---------|-----------|
| Information Element | Value/remark | Comment | Condition |
| ReportConfigNR ::= SEQUENCE { | | | |
| reportType CHOICE { | | | |
| eventTriggered SEQUENCE { | | | |
| eventId CHOICE { | | | |
| eventA3 SEQUENCE { | | | |
| a3-Offset CHOICE { | | | |
| rsrp | 2 | | |
| } | | | |
| } | | | |
| } | | | |
| rsType | csi-rs | | |
| reportAmount | r1 | | |
| reportQuantityCell SEQUENCE { | | | |
| sinr | false | | |
| } | | | |
| reportQuantityRS-Indexes SEQUENCE { | | | |
| rsrp | true | | |
| rsrq | false | | |
| sinr | false | | |
| } | | | |
| maxNrofRS-IndexesToReport | 2 | | |
| includeBeamMeasurements | true | | |
| } | | | |
| } | | | |

Table 8.2.3.9.1.3.3-8: IdMeasIdToAdd (Table 8.2.3.9.1.3.3-3)

| Derivation Path: TS 38.508-1 [4], Table 4.6.3-73 | | | |
|---|--------------|---------|-----------|
| Information Element | Value/remark | Comment | Condition |
| MeasIdToAddModList ::= SEQUENCE (SIZE (1..maxNrofMeasId)) OF MeasIdToAddMod { | 1 entry | | |
| MeasIdToAddMod[1] SEQUENCE { | | entry 1 | |
| measId | 1 | | |
| measObjectId | 1 | | |
| reportConfigId | 1 | | Step 1 |
| | 2 | | Step 9 |
| } | | | |
| } | | | |

Table 8.2.3.9.1.3.3-9: RRCConnectionReconfigurationComplete (steps 2, 10, Table 8.2.3.9.1.3.2-2)

| Derivation Path: 36.508 [7], Table 4.6.1-9 with condition MCG_and_SCG |
|---|
|---|

Table 8.2.3.9.1.3.3-10: ULInformationTransferMRDC (steps 4, 6, 12, 14 Table 8.2.3.9.1.3.2-2)

| Derivation Path: 36.508 [7], Table 4.6.1-27 | | | |
|--|--|---------|-----------|
| Information Element | Value/remark | Comment | Condition |
| ULInformationTransferMRDC-r15 ::= SEQUENCE { | | | |
| criticalExtensions CHOICE { | | | |
| c1 CHOICE { | | | |
| ulInformationTransferMRDC-r15 SEQUENCE { | | | |
| ul-DCCH-MessageNR-r15 | OCTET STRING
containing NR RRC
MeasurementReport | | |
| } | | | |
| } | | | |
| } | | | |
| } | | | |

Table 8.2.3.9.1.3.3-11: MeasurementReport (step 4, Table 8.2.3.9.1.3.2-2)

| Derivation Path: 38.508-1 [4], Table 4.6.1-7 | | | |
|--|--------------|---------|-----------|
| Information Element | Value/remark | Comment | Condition |
| MeasurementReport ::= SEQUENCE { | | | |
| criticalExtensions CHOICE { | | | |
| measurementReport SEQUENCE { | | | |
| measResults | MeasResults | | |
| } | | | |
| } | | | |
| } | | | |

| | | | |
|------------------------------------|-------------|---------|--|
| ssb-Results SEQUENCE { | | | |
| rsrp | (0..127) | | |
| rsrq | Not present | | |
| sinr | Not present | | |
| } | | | |
| } | | | |
| ResultsPerSSB-Index [2] SEQUENCE { | | entry 2 | |
| ssb-Index | SSB index 1 | | |
| ssb-Results SEQUENCE { | | | |
| rsrp | (0..127) | | |
| rsrq | Not present | | |
| sinr | Not present | | |
| } | | | |
| } | | | |
| } | | | |
| resultsCSI-RS-Indexes | Not present | | |
| } | | | |
| } | | | |
| } | | | |
| cgi-Info | Not present | | |
| } | | | |
| } | | | |
| } | | | |

Table 8.2.3.9.1.3.3-12: MeasurementReport (step 6, Table 8.2.3.9.1.3.2-2)

| Derivation Path: 38.508-1 [4], Table 4.6.1-7 | | | |
|--|--------------|---------|-----------|
| Information Element | Value/remark | Comment | Condition |
| MeasurementReport ::= SEQUENCE { | | | |
| criticalExtensions CHOICE { | | | |
| measurementReport SEQUENCE { | | | |
| measResults | MeasResults | | |
| } | | | |
| } | | | |
| } | | | |
| } | | | |

| | | | |
|------------------------|-------------|--|--|
| ssb-Results SEQUENCE { | | | |
| rsrp | (0..127) | | |
| rsrq | Not present | | |
| sinr | Not present | | |
| } | | | |
| } | | | |
| } | | | |
| resultsCSI-RS-Indexes | Not present | | |
| } | | | |
| } | | | |
| } | | | |
| cgi-Info | Not present | | |
| } | | | |
| } | | | |
| } | | | |

Table 8.2.3.9.1.3.3-13: Void

Table 8.2.3.9.1.3.3-14: Void

Table 8.2.3.9.1.3.3-14A: Void

Table 8.2.3.9.1.3.3-14B: Void

Table 8.2.3.9.1.3.3-14C: Void

Table 8.2.3.9.1.3.3-14D: Void

Table 8.2.3.9.1.3.3-15: MeasurementReport (step 12, Table 8.2.3.9.1.3.2-2)

| Derivation Path: 38.508-1 [4], Table 4.6.1-7 | | | |
|--|--------------|---------|-----------|
| Information Element | Value/remark | Comment | Condition |
| MeasurementReport ::= SEQUENCE { | | | |
| criticalExtensions CHOICE { | | | |
| measurementReport SEQUENCE { | | | |
| measResults | MeasResults | | |
| } | | | |
| } | | | |
| } | | | |
| } | | | |

Table 8.2.3.9.1.3.3-15A: MeasResults (Table 8.2.3.9.1.3.3-15)

| Derivation Path: 38.508-1 [4], Table 4.6.3-79 | | | |
|--|---|---------|-----------|
| Information Element | Value/remark | Comment | Condition |
| MeasResults ::= SEQUENCE { | | | |
| measId | 1 | | |
| measResultServingMOList SEQUENCE {(SIZE (1..maxNrofServingCells)) OF MeasResultServMO { | 1 entry | | |
| MeasResultServMO[1] SEQUENCE { | | entry 1 | |
| servCellId | ServCellIndex of NR Cell 1 | | |
| measResultServingCell SEQUENCE { | | | |
| physCellId | Physical CellID of the NR Cell 1 | | |
| measResult SEQUENCE { | | | |
| cellResults SEQUENCE { | | | |
| resultsSSB-Cell | Not present | | |
| resultsCSI-RS-Cell SEQUENCE { | | | |
| rsrp | (0..127) | | |
| rsrq | (0..127) | | |
| sinr | Not present | | |
| } | | | |
| } | | | |
| rsIndexResults SEQUENCE { | | | |
| resultsSSB-Indexes | Not present | | |
| resultsCSI-RS-Indexes SEQUENCE (SIZE (1..maxNrofIndexesToReport2)) OF ResultsPerCSI-RS-Index { | 1 entry | | |
| ResultsPerCSI-RS-Index[1] SEQUENCE { | | entry 1 | |
| csi-RS-Index | 0 | | |
| csi-RS-Results SEQUENCE { | | | |
| rsrp | (0..127) | | |
| rsrq | Not present | | |
| sinr | Not present | | |
| } | | | |
| } | | | |
| } | | | |
| } | | | |
| } | | | |
| measResultNeighCells CHOICE { | | | |
| measResultListNR SEQUENCE (SIZE (1..maxCellReport)) OF MeasResultNR { | 1 entry | | |
| MeasResultNR[1] SEQUENCE { | | entry 1 | |
| physCellId | Physical CellID of the NR Cell 2 | | |
| measResult SEQUENCE { | | | |
| cellResults SEQUENCE{ | | | |
| resultsSSB-Cell | Not present | | |
| resultsCSI-RS-Cell SEQUENCE { | | | |
| rsrp | (0..127) | | |
| rsrq | (0..127) | | |
| sinr | Not present | | |
| } | | | |
| } | | | |
| rsIndexResults SEQUENCE { | | | |
| resultsSSB-Indexes | Not Present | | |
| resultsCSI-RS-Indexes SEQUENCE (SIZE (1..maxNrofIndexesToReport2)) OF ResultsPerCSI-RS-Index { | 2 entries that may appear in an arbitrary order | | |
| ResultsPerCSI-RS-Index[1] SEQUENCE { | | entry 1 | |
| csi-RS-Index | CSI-RS-index 0 | | |
| csi-RS--Results SEQUENCE { | | | |
| rsrp | (0..127) | | |

| | | | |
|--------------------------------------|----------------|---------|--|
| rsrq | Not present | | |
| sinr | Not present | | |
| } | | | |
| } | | | |
| ResultsPerCSI-RS-Index[2] SEQUENCE { | | entry 2 | |
| csi-RS-Index | CSI-RS-index 1 | | |
| csi-RS--Results SEQUENCE { | | | |
| rsrp | (0..127) | | |
| rsrq | Not present | | |
| sinr | Not present | | |
| } | | | |
| } | | | |
| } | | | |
| } | | | |
| cgi-Info | Not present | | |
| } | | | |
| } | | | |
| } | | | |
| } | | | |
| } | | | |

Table 8.2.3.9.1.3.3-16: MeasurementReport (step 14, Table 8.2.3.9.1.3.2-2)

| Derivation Path: 38.508-1 [4], Table 4.6.1-7 | | | |
|--|--------------|---------|-----------|
| Information Element | Value/remark | Comment | Condition |
| MeasurementReport ::= SEQUENCE { | | | |
| criticalExtensions CHOICE { | | | |
| measurementReport SEQUENCE { | | | |
| measResults | MeasResults | | |
| } | | | |
| } | | | |
| } | | | |

Table 8.2.3.9.1.3.3-16A: MeasResults (Table 8.2.3.9.1.3.3-16)

| Derivation Path: 38.508-1 [4], Table 4.6.3-79 | | | |
|--|----------------------------------|---------|-----------|
| Information Element | Value/remark | Comment | Condition |
| MeasResults ::= SEQUENCE { | | | |
| measId | 1 | | |
| measResultServingMOList SEQUENCE (SIZE (1..maxNrofServingCells)) OF MeasResultServMO { | 1 entry | | |
| MeasResultServMO[1] SEQUENCE { | | entry 1 | |
| servCellId | ServCellIndex of NR Cell 1 | | |
| measResultServingCell SEQUENCE { | | | |
| physCellId | Physical CellID of the NR Cell 1 | | |
| measResult SEQUENCE { | | | |
| cellResults SEQUENCE { | | | |
| resultsSSB-Cell | Not present | | |
| resultsCSI-RS-Cell ::= SEQUENCE { | | | |
| rsrp | (0..127) | | |
| rsrq | (0..127) | | |
| sinr | Not present | | |
| } | | | |
| } | | | |
| rsIndexResults SEQUENCE { | | | |
| resultsSSB-Indexes | Not present | | |
| resultsCSI-RS-Indexes SEQUENCE (SIZE (1..maxNrofIndexesToReport2)) OF ResultsPerCSI-RS-Index { | 1 entry | | |
| ResultsPerCSI-RS-Index[1] SEQUENCE { | | entry 1 | |
| csi-RS-Index | 0 | | |
| csi-RS-Results SEQUENCE { | | | |
| rsrp | (0..127) | | |
| rsrq | Not present | | |
| sinr | Not present | | |
| } | | | |
| } | | | |
| } | | | |
| } | | | |
| } | | | |
| } | | | |
| measResultNeighCells CHOICE { | | | |
| measResultListNR SEQUENCE (SIZE (1..maxCellReport)) OF MeasResultNR { | 1 entry | | |
| MeasResultNR[1] SEQUENCE { | | entry 1 | |
| physCellId | Physical CellID of the NR Cell 2 | | |
| measResult SEQUENCE { | | | |
| cellResults SEQUENCE { | | | |
| resultsSSB-Cell | Not present | | |
| resultsCSI-RS-Cell SEQUENCE { | | | |
| rsrp | (0..127) | | |
| rsrq | (0..127) | | |
| sinr | Not present | | |
| } | | | |
| } | | | |
| } | | | |
| } | | | |
| } | | | |
| } | | | |
| rsIndexResults SEQUENCE { | | | |
| resultsSSB-Indexes | Not Present | | |
| resultsCSI-RS-Indexes SEQUENCE (SIZE (1..maxNrofIndexesToReport2)) OF ResultsPerCSI-RS-Index { | 1 entry | | |
| ResultsPerCSI-RS-Index[1] SEQUENCE { | | entry 1 | |
| csi-RS-Index | CSI-RS-Index 0 | | |
| csi-RS-Results SEQUENCE { | | | |
| rsrp | (0..127) | | |

| | | | |
|----------|-------------|--|--|
| rsrq | Not present | | |
| sinr | Not present | | |
| } | | | |
| } | | | |
| } | | | |
| } | | | |
| } | | | |
| cgi-Info | Not present | | |
| } | | | |
| } | | | |
| } | | | |

8.2.3.10 Measurement configuration control and reporting / SS/PBCH block based / CSI-RS based inter-frequency measurements / Measurement of Neighbour NR cell

8.2.3.10.1 Measurement configuration control and reporting / SS/PBCH block based /CSI-RS based Inter-frequency measurements/ Measurement of Neighbour NR Cell / EN-DC

8.2.3.10.1.1 Test Purpose (TP)

(1)

```
with { UE in RRC_CONNECTED state in EN-DC mode and measurement configured for SS/PBCH measurement
reporting of inter frequency on specified frequency }
ensure that {
  when { SS/PBCH block sorting quantity is above absThreshSS-BlocksConsolidation for each beam of NR
Neighbour Cell }
  then { UE sends MeasurementReport message containing rsIndexResults with resultsSSB-Indexes }
}
```

(2)

```
with { UE in RRC_CONNECTED state in EN-DC mode and measurement configured for SS/PBCH measurement
reporting of inter frequency on specified frequency }
ensure that {
  when { SS/PBCH block sorting quantity is below absThreshSS-BlocksConsolidation for one beam of NR
Neighbour Cell and another beam(s) is above absThreshSS-BlocksConsolidation }
  then { UE sends MeasurementReport message containing rsIndexResults with resultsSSB-Indexes
includes RsIndex above absThreshSS-BlocksConsolidation and excludes RsIndex below absThreshSS-
BlocksConsolidation }
}
```

(3)

```
with { UE in RRC_CONNECTED state in EN-DC mode and measurement configured for CSI-RS measurement
reporting of inter frequency on specified frequency }
ensure that {
  when { CSI-RS sorting quantity is above absThreshCSI-RS-Consolidation for each beam of NR
Neighbour Cell }
  then { UE sends MeasurementReport message containing rsIndexResults with resultsCSI-RS-Indexes }
}
```

(4)

```
with { UE in RRC_CONNECTED state in EN-DC mode and measurement configured for CSI-RS measurement
reporting of inter frequency on specified frequency }
ensure that {
  when { CSI-RS sorting quantity is below absThreshCSI-RS-Consolidation for one beam of NR Neighbour
Cell and another beam(s) is above absThreshCSI-RS-Consolidation }
  then { UE sends MeasurementReport message containing rsIndexResults with resultsCSI-RS-Indexes
includes RsIndex above absThreshCSI-RS-Consolidation and excludes RsIndex below absThreshCSI-RS-
Consolidation }
}
```

8.2.3.10.1.2 Conformance requirements

References: The conformance requirements covered in the present TC are specified in: TS 38.331 clauses 5.5.5.1 and 5.5.5.2. Unless otherwise stated these are Rel-15 requirements.

[TS 38.331, clause 5.5.5.1]

The purpose of this procedure is to transfer measurement results from the UE to the network. The UE shall initiate this procedure only after successful security activation.

For the *measId* for which the measurement reporting procedure was triggered, the UE shall set the *measResults* within the *MeasurementReport* message as follows:

- 1> set the *measId* to the measurement identity that triggered the measurement reporting;
- 1> for each serving cell configured with *-servingCellMO*:
 - 2> if the *reportConfig* associated with the *measId* that triggered the measurement reporting includes *rsType*:
 - 3> if the serving cell measurements based on the *rsType* included in the *reportConfig* that triggered the measurement report are available:
 - 4> set the *measResultServingCell* within *measResultServingMOList* to include RSRP, RSRQ and the available SINR of the serving cell, derived based on the *rsType* included in the *reportConfig* that triggered the measurement report;
 - 2> else:
 - 3> if SSB based serving cell measurements are available:
 - 4> set the *measResultServingCell* within *measResultServingMOList* to include RSRP, RSRQ and the available SINR of the serving cell, derived based on SSB;
 - 3> else if CSI-RS based serving cell measurements are available:
 - 4> set the *measResultServingCell* within *measResultServingMOList* to include RSRP, RSRQ and the available SINR of the serving cell, derived based on CSI-RS;
- 1> set the *-servingCellId* within *measResultServingMOList* to include for each NR serving cell that is configured, if any;
- 1> if the *reportConfig* associated with the *measId* that triggered the measurement reporting includes *reportQuantityRS-Indexes* and *maxNrofRS-IndexesToReport*:
 - 2> for each serving cell configured with *-servingCellMO*, include beam measurement information according to the associated *reportConfig* as described in 5.5.5.2;
- ...
- 1> if there is at least one applicable neighbouring cell to report:
 - 2> if the *reportType* is set to *eventTriggered* or *periodical*:
 - 3> set the *measResultNeighCells* to include the best neighbouring cells up to *maxReportCells* in accordance with the following:
 - 4> if the *reportType* is set to *eventTriggered*:
 - 5> include the cells included in the *cellsTriggeredList* as defined within the *VarMeasReportList* for this *measId*;
 - 4> else:
 - 5> include the applicable cells for which the new measurement results became available since the last periodical reporting or since the measurement was initiated or reset;

- 4> for each cell that is included in the *measResultNeighCells*, include the *physCellId*;
- 4> if the *reportType* is set to *eventTriggered* or *periodical*:
 - 5> for each included cell, include the layer 3 filtered measured results in accordance with the *reportConfig* for this *measId*, ordered as follows:
 - 6> if the *measObject* associated with this *measId* concerns NR:
 - 7> if *rsType* in the associated *reportConfig* is set to *ssb*:
 - 8> set *resultsSSB-Cell* within the *measResult* to include the SS/PBCH block based quantity(ies) indicated in the *reportQuantityCell* within the concerned *reportConfig*, in decreasing order of the sorting quantity, determined as specified in 5.5.5.3, i.e. the best cell is included first;
 - 8> if *reportQuantityRS-Indexes* and *maxNrofRS-IndexesToReport* are configured, include beam measurement information as described in 5.5.5.2;
 - 7> else if *rsType* in the associated *reportConfig* is set to *csi-rs*:
 - 8> set *resultsCSI-RS-Cell* within the *measResult* to include the CSI-RS based quantity(ies) indicated in the *reportQuantityCell* within the concerned *reportConfig*, in decreasing order of the sorting quantity, determined as specified in 5.5.5.3, i.e. the best cell is included first;
 - 8> if *reportQuantityRS-Indexes* and *maxNrofRS-IndexesToReport* are configured, include beam measurement information as described in 5.5.5.2;

[TS 38.331, clause 5.5.5.1]

- 1> increment the *numberOfReportsSent* as defined within the *VarMeasReportList* for this *measId* by 1;
- 1> stop the periodical reporting timer, if running;
- 1> if the *numberOfReportsSent* as defined within the *VarMeasReportList* for this *measId* is less than the *reportAmount* as defined within the corresponding *reportConfig* for this *measId*:
 - 2> start the periodical reporting timer with the value of *reportInterval* as defined within the corresponding *reportConfig* for this *measId*;
- 1> else:
 - 2> if the *reportType* is set to *periodical*:
 - 3> remove the entry within the *VarMeasReportList* for this *measId*;
 - 3> remove this *measId* from the *measIdList* within *VarMeasConfig*;
- 1> if the UE is in (NG)EN-DC:
 - 2> if SRB3 is configured:
 - 3> submit the *MeasurementReport* message via SRB3 to lower layers for transmission, upon which the procedure ends;
 - 2>else:
 - 3> submit the *MeasurementReport* message via the EUTRA MCG embedded in E-UTRA RRC message *ULInformationTransferMRDC* as specified in TS 36.331 [10].

[TS 38.331, clause 5.5.5.2]

For beam measurement information to be included in a measurement report the UE shall:

- 1> if *reportType* is set to *eventTriggered*:

- 2> consider the trigger quantity as the sorting quantity if available, otherwise RSRP as sorting quantity if available, otherwise RSRQ as sorting quantity if available, otherwise SINR as sorting quantity;
- 1> set *rsIndexResults* to include up to *maxNrofRS-IndexesToReport* SS/PBCH block indexes or CSI-RS indexes in order of decreasing sorting quantity as follows:
 - 2> if the measurement information to be included is based on SS/PBCH block:
 - 3> include within *resultsSSB-Indexes* the index associated to the best beam for that SS/PBCH block sorting quantity and if *absThreshSS-BlocksConsolidation* is included in the *VarMeasConfig* for the *measObject* associated to the cell for which beams are to be reported, the remaining beams whose sorting quantity is above *absThreshSS-BlocksConsolidation*;
 - 3> if *includeBeamMeasurements* is configured, include the SS/PBCH based measurement results for the quantities in *reportQuantityRS-Indexes* set to *true* for each SS/PBCH block index;
 - 2> else if the beam measurement information to be included is based on CSI-RS:
 - 3> include within *resultsCSI-RS-Indexes* the index associated to the best beam for that CSI-RS sorting quantity and, if *absThreshCSI-RS-Consolidation* is included in the *VarMeasConfig* for the *measObject* associated to the cell for which beams are to be reported, the remaining beams whose sorting quantity is above *absThreshCSI-RS-Consolidation*;
 - 3> if *includeBeamMeasurements* is configured, include the CSI-RS based measurement results for the quantities in *reportQuantityRS-Indexes* set to *true* for each CSI-RS index.

8.2.3.10.1.3 Test description

8.2.3.10.1.3.1 Pre-test conditions

System Simulator:

- EUTRA Cell 1 is the PCell and NR Cell 1 is the PS Cell and NR Cell 3 is the inter-frequency neighbour cell of NR Cell 1. NR Cell 3 has two beams: SSB/CSI-RS index#0 and SSB/CSI-RS index#1.

UE:

- None

Preamble:

- The UE is in state RRC_CONNECTED in EN-DC using generic procedure parameter Connectivity (EN-DC) and DC Bearers (MCG(s) and SCG) on E-UTRA Cell 1 according to TS 38.508-1 [4].

8.2.3.10.1.3.2 Test procedure sequence

Table 8.2.3.10.1.3.2-1 and Table 8.2.3.10.1.3.2-1A illustrates the downlink power levels to be applied for NR Cell 1 and NR Cell 3 at various time instants of the test execution. Row marked "T0" denotes the conditions after the preamble, while rows marked "T1" and "T2" are to be applied subsequently. The exact instants on which these values shall be applied are described in the texts in this clause.

Table 8.2.3.10.1.3.2-1: Time instances of cell power level and parameter changes for FR1

| | Parameter | Unit | E-UTRA Cell 1 | NR Cell 1 | NR Cell 3 | NR Cell 3 Beam 0 (NOTE) | NR Cell 3 Beam 1 (NOTE) | Remark |
|-------|---|------------|---------------|-----------|-----------|-------------------------|-------------------------|---|
| T0 | Cell-specific RS EPRE | dBm/15k Hz | -85 | - | - | - | - | |
| | SS/PBCH SSS EPRE | dBm/SC S | - | -94 | - | - | - | |
| | Reference Power | dBm/SC S | - | - | -90 | - | - | |
| | SS/PBCH SSS EPRE, CSI-RS EPRE offset | dB | - | - | - | -4 | -4 | |
| T1 | Cell-specific RS EPRE | dBm/15k Hz | -85 | - | - | - | - | $Mn + Ofn + Ocn - Hys > Mp + Ofp + Ocp + Off$
Power level is such that SS/PBCH quality and CSI-RS quality for both beams of NR Cell 3 are above <i>absThreshSS-BlocksConsolidation</i> . |
| | SS/PBCH SSS EPRE | dBm/SC S | - | -106 | - | - | - | |
| | Reference Power | dBm/SC S | - | - | -90 | - | - | |
| | SS/PBCH SSS EPRE, CSI-RS EPRE offset | dB | - | - | - | -4 | -4 | |
| T2 | Cell-specific RS EPRE | dBm/15k Hz | -85 | - | - | - | - | $Mn + Ofn + Ocn + Hys < Mp + Ofp + Ocp + Off$
Power level is such that SS/PBCH quality and CSI-RS quality for both beams of NR Cell 3 are below <i>absThreshSS-BlocksConsolidation</i> |
| | SS/PBCH SSS EPRE | dBm/SC S | - | -106 | - | - | - | |
| | Reference Power | dBm/SC S | - | - | -90 | - | - | |
| | SS/PBCH SSS EPRE, CSI-RS EPRE offset | dB | - | - | - | -12 | -12 | |
| T3 | Cell-specific RS EPRE | dBm/15k Hz | -85 | - | - | - | - | Power level is such that SS/PBCH quality and CSI-RS quality for beam 0 of NR Cell 3 is above <i>absThreshSS-BlocksConsolidation</i> and for beam 1 of NR Cell 3 is below <i>absThreshSS-BlocksConsolidation</i> . |
| | SS/PBCH SSS EPRE | dBm/SC S | - | -106 | - | - | - | |
| | Reference Power | dBm/SC S | - | - | -90 | - | - | |
| | SS/PBCH SSS EPRE, CSI-RS EPRE offset | dB | - | - | - | -4 | -12 | |
| NOTE: | "Beam 0" refers to transmission of the SS/PBCH block with SSB index #0 (according to the <i>ssb-PositionsInBurst</i>) and CSI-RS with index #0 (according to the <i>csi-rs-ResourceList-Mobility</i> being signalled to the UE at step 9); "Beam 1" refers to transmission of the SS/PBCH block with SSB index #1 (according to the <i>ssb-PositionsInBurst</i>) and CSI-RS with index #1 (according to the <i>csi-rs-ResourceList-Mobility</i> being signalled to the UE at step 9). For each beam SSS and CSI-RS have the same power levels at any given time instance. | | | | | | | |

Table 8.2.3.10.1.3.2-1A: Time instances of cell power level and parameter changes for FR2

| | Parameter | Unit | E-UTRA Cell 1 | NR Cell 1 | NR Cell 3 | NR Cell 3 Beam 0 (NOTE) | NR Cell 3 Beam 1 (NOTE) | Remark |
|-------|---|------------|---------------|-----------|-----------|-------------------------|-------------------------|---|
| T0 | Cell-specific RS EPRE | dBm/15k Hz | -96 | - | - | - | - | |
| | SS/PBCH SSS EPRE | dBm/SC S | - | -82 | - | - | - | |
| | Reference Power | dBm/SC S | - | - | -81 | - | - | |
| | SS/PBCH SSS EPRE, CSI-RS EPRE offset | dB | - | - | - | -1 | -1 | |
| T1 | Cell-specific RS EPRE | dBm/15k Hz | -96 | - | - | - | - | $Mn + Ofn + Ocn - Hys > Mp + Ofp + Ocp + Off$
Power level is such that SS/PBCH quality and CSI-RS quality for both beams of NR Cell 3 are above <i>absThreshSS-BlocksConsolidation</i> . |
| | SS/PBCH SSS EPRE | dBm/SC S | - | -100 | - | - | - | |
| | Reference Power | dBm/SC S | - | - | -81 | - | - | |
| | SS/PBCH SSS EPRE, CSI-RS EPRE offset | dB | - | - | - | -1 | -1 | |
| T2 | Cell-specific RS EPRE | dBm/15k Hz | -96 | - | - | - | - | $Mn + Ofn + Ocn + Hys < Mp + Ofp + Ocp + Off$
Power level is such that SS/PBCH quality and CSI-RS quality for both beams of NR Cell 3 are below <i>absThreshSS-BlocksConsolidation</i> |
| | SS/PBCH SSS EPRE | dBm/SC S | - | -100 | - | - | - | |
| | Reference Power | dBm/SC S | - | - | -81 | - | - | |
| | SS/PBCH SSS EPRE, CSI-RS EPRE offset | dB | - | - | - | -19 | -19 | |
| T3 | Cell-specific RS EPRE | dBm/15k Hz | -96 | - | - | - | - | Power level is such that SS/PBCH quality and CSI-RS quality for beam 0 of NR Cell 3 is above <i>absThreshSS-BlocksConsolidation</i> and for beam 1 of NR Cell 3 is below <i>absThreshSS-BlocksConsolidation</i> . |
| | SS/PBCH SSS EPRE | dBm/SC S | - | -100 | - | - | - | |
| | Reference Power | dBm/SC S | - | - | -81 | - | - | |
| | SS/PBCH SSS EPRE, CSI-RS EPRE offset | dB | - | - | - | -1 | -19 | |
| NOTE: | "Beam 0" refers to transmission of the SS/PBCH block with SSB index #0 (according to the <i>ssb-PositionsInBurst</i>) and CSI-RS with index #0 (according to the <i>csi-rs-ResourceList-Mobility</i> being signalled to the UE at step 9); "Beam 1" refers to transmission of the SS/PBCH block with SSB index #1 (according to the <i>ssb-PositionsInBurst</i>) and CSI-RS with index #1 (according to the <i>csi-rs-ResourceList-Mobility</i> being signalled to the UE at step 9). For each beam SSS and CSI-RS have the same power levels at any given time instance. | | | | | | | |

Table 8.2.3.10.1.3.2-2: Main behaviour

| St | Procedure | Message Sequence | | TP | Verdict |
|-----|--|------------------|---|----|---------|
| | | U - S | Message | | |
| 1 | The SS transmits an <i>RRCConnectionReconfiguration</i> message containing NR <i>RRCReconfiguration</i> including <i>measConfig</i> to setup SS/PBCH block based inter-frequency NR measurement for PSCell (NR Cell 1) and reporting for A3. | <-- | EUTRA RRC:
<i>RRCConnectionReconfiguration(RRCReconfiguration)</i> | - | - |
| 2 | The UE transmits an <i>RRCConnectionReconfigurationComplete</i> message containing NR <i>RRCReconfigurationComplete</i> . | --> | EUTRA RRC:
<i>RRCConnectionReconfigurationComplete(RRCReconfigurationComplete)</i> | - | - |
| 3 | The SS re-adjusts the cell-specific reference signal level according to row "T1". | - | - | - | - |
| 4 | Check: Does the UE transmit a <i>MeasurementReport</i> message to report event A3 with the measured results for NR Cell 3 with beam information containing <i>RsIndex[0]</i> and <i>RsIndex[1]</i> ? | --> | EUTRA RRC:
<i>ULInformationTransferMRDC(MeasurementReport)</i> | 1 | P |
| 4A | The SS re-adjusts the cell-specific reference signal level according to the row "T2". | - | - | - | - |
| 4B | Check: Does the UE transmit a <i>MeasurementReport</i> message on E-UTRA Cell 1 to report the event A3 during the next 10s? | - | - | 1 | F |
| 5 | The SS re-adjusts the cell-specific reference signal level according to row "T3". | - | - | - | - |
| 6 | Check: Does the UE transmit a <i>MeasurementReport</i> message to report event A3 with the measured results for NR Cell 3 with beam information containing <i>RsIndex[0]</i> and excludes <i>RsIndex[1]</i> ? | --> | EUTRA RRC:
<i>ULInformationTransferMRDC(MeasurementReport)</i> | 2 | P |
| 7-8 | Void | - | - | - | - |
| 9 | The SS transmits an <i>RRCConnectionReconfiguration</i> message containing NR <i>RRCReconfiguration</i> including <i>measConfig</i> to setup CSI-RS based inter-frequency NR measurement for PSCell (NR Cell 1) and event A3. | <-- | EUTRA RRC:
<i>RRCConnectionReconfiguration(RRCReconfiguration)</i> | - | - |
| 10 | The UE transmits an <i>RRCConnectionReconfigurationComplete</i> message containing NR <i>RRCReconfigurationComplete</i> . | --> | EUTRA RRC:
<i>RRCConnectionReconfigurationComplete(RRCReconfigurationComplete)</i> | - | - |
| 11 | The SS re-adjusts the cell-specific reference signal level according to row "T1". | - | - | - | - |
| 12 | Check: Does the UE transmit a <i>MeasurementReport</i> message to report event A3 with the measured results for NR Cell 3 with beam information containing <i>RsIndex[0]</i> and <i>RsIndex[1]</i> ? | --> | EUTRA RRC:
<i>ULInformationTransferMRDC(MeasurementReport)</i> | 3 | P |
| 12A | The SS re-adjusts the cell-specific reference signal level according to the row "T2". | - | - | - | - |
| 12B | Check: Does the UE transmit a <i>MeasurementReport</i> message on E-UTRA Cell 1 to report the event A3 during the next 10s? | - | - | 3 | F |
| 13 | The SS re-adjusts the cell-specific reference signal level according to row "T3". | - | - | - | - |
| 14 | Check: Does the UE transmit a <i>MeasurementReport</i> message to report event A3 with the measured results for NR Cell 3 with beam information containing <i>RsIndex[0]</i> and excludes <i>RsIndex[1]</i> ? | --> | EUTRA RRC:
<i>ULInformationTransferMRDC(MeasurementReport)</i> | 4 | P |

8.2.3.10.1.3.3 Specific message contents

Table 8.2.3.10.1.3.3-1: RRCConnectionReconfiguration (steps 1, 9, Table 8.2.3.10.1.3.2-2)

Derivation Path: 36.508 [7], Table 4.6.1-8 with condition EN-DC_EmbedNR_RRCRecon

Table 8.2.3.10.1.3.3-2: RRCReconfiguration (Table 8.2.3.10.1.3.3-1)

Derivation Path: 38.508-1 [4], Table 4.6.1-13 with condition EN-DC_MEAS

Table 8.2.3.10.1.3.3-3: MeasConfig (Table 8.2.3.10.1.3.3-2)

| Derivation Path: 38.508-1 [4], Table 4.6.3-69 | | | |
|---|---------------------|---------|-----------|
| Information Element | Value/remark | Comment | Condition |
| MeasConfig ::= SEQUENCE { | | | |
| measObjectToAddModList | IdMeasObjectToAdd | | Step 1 |
| | Not present | | Step 9 |
| reportConfigToAddModList | IdReportConfigToAdd | | Step 1 |
| | Not present | | Step 9 |
| measIdToAddModList | IdMeasIdToAdd | | |
| } | | | |

Table 8.2.3.10.1.3.3-4: IdMeasObjectToAdd (Table 8.2.3.10.1.3.3-3)

| Derivation Path: TS 38.331 [6], clause 6.3.2 | | | |
|---|--------------------|---------|-----------|
| Information Element | Value/remark | Comment | Condition |
| MeasObjectToAddModList ::= SEQUENCE (SIZE (1..maxNrofMeasId)) OF MeasObjectToAddMod { | 2 entries | | |
| MeasObjectToAddMod[1] SEQUENCE { | | entry 1 | |
| measObjectId | 1 | | |
| measObject CHOICE { | | | |
| measObjectNR | Id-MeasObjectNR-f1 | | |
| } | | | |
| } | | | |
| MeasObjectToAddMod[2] SEQUENCE { | | entry 2 | |
| measObjectId | 2 | | |
| measObject CHOICE { | | | |
| measObjectNR | Id-MeasObjectNR-f2 | | |
| } | | | |
| } | | | |
| } | | | |

| | | | |
|-------------------------------|-------------|-------|--|
| | | 90dBm | |
| thresholdRSRQ | Not Present | | |
| thresholdSINR | Not Present | | |
| } | | | |
| nrofCSI-RS-ResourcesToAverage | 2 | | |
| } | | | |

Table 8.2.3.10.1.3.3-5A: Id-MeasObjectNR-f2 (Table 8.2.3.10.1.3.3-4)

| Derivation Path: 38.508-1 [4], Table 4.6.3-76 | | | |
|--|--|--|--|
| Information Element | Value/remark | Comment | Condition |
| MeasObjectNR ::= SEQUENCE { | | | |
| ssbFrequency | Downlink ARFCN of NCell 3 | | |
| refFreqCSI-RS | Same as "Point A" defined for the downlink of NR Cell3 | | |
| referenceSignalConfig SEQUENCE { | | | |
| ssb-ConfigMobility SEQUENCE { | | | |
| ssb-ToMeasure CHOICE { | | | |
| setup CHOICE { | | | |
| shortBitmap | 1100 | | (FREQ<=3G Hz AND (FR1_FDD OR NOT CASE_C)) OR (FREQ<=2.4 GHz AND FR1_TDD) |
| mediumBitmap | 11000000 | | (FREQ>3G Hz AND FR1) OR (FREQ>2.4 GHz AND FR1_TDD AND CASE_C) |
| longBitmap | 11000000 00000000
00000000 00000000
00000000 00000000
00000000 00000000 | | FR2 |
| } | | | |
| } | | | |
| } | | | |
| csi-rs-ResourceConfigMobility CHOICE { | | | |
| setup SEQUENCE { | | | |
| subcarrierSpacing | SubcarrierSpacing | | |
| csi-RS-CellList-Mobility SEQUENCE (SIZE (1..maxNrofCSI-RS-CellsRRM)) OF CSI-RS-CellMobility { | 1 entry | | |
| CSI-RS-CellMobility[1] SEQUENCE { | | entry 1 | |
| cellId | Physical CellID of the NR Cell 3 | | |
| csi-rs-MeasurementBW SEQUENCE { | | | |
| nrofPRBs | size24 | | |
| startPRB | same value as 'offsetToCarrier' as defined for the DL frequency of the cell | | |
| } | | | |
| density[1] | d3 | | |
| csi-rs-ResourceList-Mobility[1] SEQUENCE (SIZE (1.. maxNrofCSI-RS-ResourcesRRM)) OF CSI-RS-Resource-Mobility { | 2 entries | | |
| CSI-RS-Resource-Mobility[1] SEQUENCE { | | entry 1 | |
| csi-RS-Index | 0 | CSI-RS with Index 0 | |
| slotConfig CHOICE { | | | |
| ms20 | $10 * 2^\mu$ | μ is numerology index (SCS=15kHz: 0, SCS=30kHz: 1, etc.) | |

| | | | |
|--|--------------|---|---|
| } | | | |
| associatedSSB | Not present | | |
| associatedSSB SEQUENCE { | | | pc_csi_RSR
P_AndRSR
Q_MeasWit
hSSB |
| ssb-Index | 0 | | |
| isQuasiColocated | false | | |
| } | | | |
| frequencyDomainAllocation CHOICE { | | | |
| row1 | 1000 | | |
| } | | | |
| firstOFDMSymbolInTimeDomain | 4 | | |
| sequenceGenerationConfig | 24 | | |
| } | | | |
| CSI-RS-Resource-Mobility[2] SEQUENCE { | | entry 2 | |
| csi-RS-Index | 1 | CSI-RS with Index
1 | |
| slotConfig CHOICE { | | | |
| ms20 | $10 * 2^\mu$ | μ : numerology
index
(SCS=15kHz: 0,
SCS=30kHz: 1,
etc.) | |
| } | | | |
| associatedSSB | Not present | | |
| associatedSSB SEQUENCE { | | | pc_csi_RSR
P_AndRSR
Q_MeasWit
hSSB |
| ssb-Index | 1 | | |
| isQuasiColocated | false | | |
| } | | | |
| frequencyDomainAllocation CHOICE { | | | |
| row1 | 0001 | | |
| } | | | |
| firstOFDMSymbolInTimeDomain | 0 | | |
| sequenceGenerationConfig | 24 | | |
| } | | | |
| } | | | |
| } | | | |
| } | | | |
| } | | | |
| } | | | |
| absThreshSS-BlocksConsolidation SEQUENCE { | | | |
| thresholdRSRP | 57 | corresponding to -
99dBm | FR1 |
| | 66 | corresponding to -
90dBm | FR2 |
| } | | | |
| absThreshCSI-RS-Consolidation SEQUENCE { | | | |
| thresholdRSRP | 57 | corresponding to -
99dBm | FR1 |
| | 66 | corresponding to -
90dBm | FR2 |
| thresholdRSRQ | Not Present | | |
| thresholdSINR | Not Present | | |
| } | | | |
| nrofCSI-RS-ResourcesToAverage | 2 | | |
| } | | | |

Table 8.2.3.10.1.3.3-6: IdReportConfigToAdd (Table 8.2.3.10.1.3.3-3)

| Derivation Path: TS 38.331 [6], clause 6.3.2 | | | |
|--|--------------------------|---------|-----------|
| Information Element | Value/remark | Comment | Condition |
| ReportConfigToAddModList ::= SEQUENCE(SIZE (1..maxReportConfigId)) OF ReportConfigToAddMod { | 2 entries | | |
| ReportConfigToAddMod[1] SEQUENCE { | | entry 1 | |
| reportConfigId | 1 | | |
| reportConfig CHOICE { | | | |
| reportConfigNR | IdReportConfig-A3-SSB | | |
| } | | | |
| ReportConfigToAddMod[2] SEQUENCE { | | entry 2 | |
| reportConfigId | 2 | | |
| reportConfig CHOICE { | | | |
| reportConfigNR | IdReportConfig-A3-CSI-RS | | |
| } | | | |
| } | | | |
| } | | | |
| } | | | |

Table 8.2.3.10.1.3.3-7: IdReportConfig-A3-SSB (Table 8.2.3.10.1.3.3-3)

| Derivation Path: 38.508-1 [4], Table 4.6.3-142 with condition EVENT_A3 | | | |
|--|--|---|-----------|
| Information Element | Value/remark | Comment | Condition |
| ReportConfigNR ::= SEQUENCE { | | | |
| reportType CHOICE { | | | |
| eventTriggered SEQUENCE { | | | |
| eventId CHOICE { | | | |
| eventA3 SEQUENCE { | | | |
| a3-Offset CHOICE { | | | |
| rsrp | 2 | | FR1 |
| } | 2+ Delta(NRf ₂) - Delta(NRf ₁) | a3-Offset value set to (2+ Delta(NRf ₂) - Delta(NRf ₁)). (Note 1) | FR2 |
| } | | | |
| } | | | |
| } | | | |
| } | | | |
| reportAmount | r1 | | |
| reportQuantityRS-Indexes SEQUENCE { | | | |
| rsrp | true | | |
| rsrq | false | | |
| sinr | false | | |
| } | | | |
| maxNrofRS-IndexesToReport | 2 | | |
| includeBeamMeasurements | true | | |
| } | | | |
| } | | | |
| } | | | |
| } | | | |

NOTE 1: Delta(NRf₂) and Delta(NRf₁) are derived based on calibration procedure defined in the TS 38.508-1 [4], clause 6.1.3.3 where Delta(NRf₁) derived NR Cell1 and Delta(NRf₂) derived NR Cell3

Table 8.2.3.10.1.3.3-10: ULInformationTransferMRDC (steps 4, 6,12,14 Table 8.2.3.10.1.3.2-2)

| Derivation Path: 36.508 [7], Table 4.6.1-27 | | | |
|--|--|---------|-----------|
| Information Element | Value/remark | Comment | Condition |
| ULInformationTransferMRDC-r15 ::= SEQUENCE { | | | |
| criticalExtensions CHOICE { | | | |
| c1 CHOICE { | | | |
| ulInformationTransferMRDC-r15 SEQUENCE { | | | |
| ul-DCCH-MessageNR-r15 | OCTET STRING
containing NR RRC
MeasurementReport | | |
| } | | | |
| } | | | |
| } | | | |
| } | | | |

Table 8.2.3.10.1.3.3-11: MeasurementReport (step 4, Table 8.2.3.10.1.3.2-2)

| Derivation Path: 38.508-1 [4], Table 4.6.1-7 | | | |
|--|--------------|---------|-----------|
| Information Element | Value/remark | Comment | Condition |
| MeasurementReport ::= SEQUENCE { | | | |
| criticalExtensions CHOICE { | | | |
| measurementReport SEQUENCE { | | | |
| measResults | MeasResults | | |
| } | | | |
| } | | | |
| } | | | |

| | | | |
|-----------------------------------|-------------|---------|--|
| ssb-Results SEQUENCE { | | | |
| rsrp | (0..127) | | |
| rsrq | Not present | | |
| sinr | Not present | | |
| } | | | |
| } | | | |
| ResultsPerSSB-Index[2] SEQUENCE { | | entry 2 | |
| ssb-Index | SSB index 1 | | |
| ssb-Results SEQUENCE { | | | |
| rsrp | (0..127) | | |
| rsrq | Not present | | |
| sinr | Not present | | |
| } | | | |
| } | | | |
| } | | | |
| resultsCSI-RS-Indexes | Not present | | |
| } | | | |
| } | | | |
| cgi-Info | Not present | | |
| } | | | |
| } | | | |
| } | | | |
| } | | | |

Table 8.2.3.10.1.3.3-12: MeasurementReport (step 6, Table 8.2.3.10.1.3.2-2)

| Derivation Path: 38.508-1 [4], Table 4.6.1-7 | | | |
|--|--------------|---------|-----------|
| Information Element | Value/remark | Comment | Condition |
| MeasurementReport ::= SEQUENCE { | | | |
| criticalExtensions CHOICE { | | | |
| measurementReport SEQUENCE { | | | |
| measResults | MeasResults | | |
| } | | | |
| } | | | |
| } | | | |
| } | | | |

| | | | |
|------------------------|-------------|--|--|
| ssb-Results SEQUENCE { | | | |
| rsrp | (0..127) | | |
| rsrq | Not present | | |
| sinr | Not present | | |
| } | | | |
| } | | | |
| } | | | |
| resultsCSI-RS-Indexes | Not present | | |
| } | | | |
| } | | | |
| } | | | |
| cgi-Info | Not present | | |
| } | | | |
| } | | | |
| } | | | |

Table 8.2.3.10.1.3.3-13: Void

Table 8.2.3.10.1.3.3-14: Void

Table 8.2.3.10.1.3.3-14A: Void

Table 8.2.3.10.1.3.3-14B: Void

Table 8.2.3.10.1.3.3-14C: Void

Table 8.2.3.10.1.3.3-14D: Void

Table 8.2.3.10.1.3.3-14E: Void

Table 8.2.3.10.1.3.3-14F: MeasurementReport (step 12, Table 8.2.3.10.1.3.2-2)

| Derivation Path: 38.508-1 [4], Table 4.6.1-7 | | | |
|--|--------------|---------|-----------|
| Information Element | Value/remark | Comment | Condition |
| MeasurementReport ::= SEQUENCE { | | | |
| criticalExtensions CHOICE { | | | |
| measurementReport SEQUENCE { | | | |
| measResults | MeasResults | | |
| } | | | |
| } | | | |
| } | | | |
| } | | | |

Table 8.2.3.10.1.3.3-15: MeasResults

| Derivation Path: 38.508-1 [4], Table 4.6.3-79 | | | |
|--|---|---------|-----------|
| Information Element | Value/remark | Comment | Condition |
| MeasResults ::= SEQUENCE { | | | |
| measId | 1 | | |
| measResultServingMOList SEQUENCE {(SIZE (1..maxNrofServingCells)) OF MeasResultServMO { | 1 entry | | |
| MeasResultServMO[1] SEQUENCE { | | entry 1 | |
| servCellId | ServCellIndex of NR Cell 1 | | |
| measResultServingCell SEQUENCE { | | | |
| physCellId | Physical CellID of the NR Cell 1 | | |
| measResult SEQUENCE { | | | |
| cellResults SEQUENCE{ | | | |
| resultsSSB-Cell | Not present | | |
| resultsCSI-RS-Cell SEQUENCE { | | | |
| rsrp | (0..127) | | |
| rsrq | (0..127) | | |
| sinr | Not present | | |
| } | | | |
| } | | | |
| rsIndexResults SEQUENCE { | | | |
| resultsSSB-Indexes | Not present | | |
| resultsCSI-RS-Indexes SEQUENCE (SIZE (1..maxNrofIndexesToReport2)) OF ResultsPerCSI-RS-Index { | 1 entry | | |
| ResultsPerCSI-RS-Index[1] SEQUENCE { | | entry 1 | |
| csi-RS-Index | 0 | | |
| csi-RS-Results SEQUENCE { | | | |
| rsrp | (0..127) | | |
| rsrq | Not present | | |
| sinr | Not present | | |
| } | | | |
| } | | | |
| } | | | |
| } | | | |
| } | | | |
| measResultNeighCells CHOICE { | | | |
| measResultListNR SEQUENCE (SIZE (1..maxCellReport)) OF MeasResultNR { | 1 entry | | |
| MeasResultNR[1] SEQUENCE { | | entry 1 | |
| physCellId | Physical CellID of the NR Cell 3 | | |
| measResult SEQUENCE { | | | |
| cellResults SEQUENCE { | | | |
| resultsSSB-Cell | Not present | | |
| resultsCSI-RS-Cell SEQUENCE { | | | |
| rsrp | (0..127) | | |
| rsrq | (0..127) | | |
| sinr | Not present | | |
| } | | | |
| } | | | |
| } | | | |
| } | | | |
| rsIndexResults SEQUENCE { | | | |
| resultsSSB-Indexes | Not present | | |
| resultsCSI-RS-Indexes SEQUENCE (SIZE (1..maxNrofIndexesToReport2)) OF ResultsPerCSI-RS-Index { | 2 entries that may appear in an arbitrary order | | |
| ResultsPerCSI-RS-Index[1] SEQUENCE { | | entry 1 | |
| csi-RS-Index | CSI-RS-Index #0 | | |
| csi-RS-Results SEQUENCE { | | | |
| rsrp | (0..127) | | |

| | | | |
|--------------------------------------|----------------|---------|--|
| rsrq | Not present | | |
| sinr | Not present | | |
| } | | | |
| } | | | |
| ResultsPerCSI-RS-Index[2] SEQUENCE { | | entry 2 | |
| csi-RS-Index | CSI-RS-Index#1 | | |
| csi-RS--Results SEQUENCE { | 0 | | |
| rsrp | (0..127) | | |
| rsrq | Not present | | |
| sinr | Not present | | |
| } | | | |
| } | | | |
| } | | | |
| } | | | |
| cgi-Info | Not present | | |
| } | | | |
| } | | | |
| } | | | |
| } | | | |
| } | | | |

Table 8.2.3.10.1.3.3-15A: MeasurementReport (step 14, Table 8.2.3.10.1.3.2-2)

| Derivation Path: 38.508-1 [4], Table 4.6.1-7 | | | |
|--|--------------|---------|-----------|
| Information Element | Value/remark | Comment | Condition |
| MeasurementReport ::= SEQUENCE { | | | |
| criticalExtensions CHOICE { | | | |
| measurementReport SEQUENCE { | | | |
| measResults | MeasResults | | |
| } | | | |
| } | | | |
| } | | | |

Table 8.2.3.10.1.3.3-16: MeasResults (Table 8.2.3.10.1.3.3-15A)

| Derivation Path: TS 38.331 [6], clause 6.2.2 | | | |
|--|----------------------------------|---------|-----------|
| Information Element | Value/remark | Comment | Condition |
| MeasResults ::= SEQUENCE { | | | |
| measId | 1 | | |
| measResultServingMOList SEQUENCE (SIZE (1..maxNrofServingCells)) OF MeasResultServMO { | 1 entry | | |
| MeasResultServMO[1] SEQUENCE { | | entry 1 | |
| servCellId | ServCellIndex of NR Cell 1 | | |
| measResultServingCell SEQUENCE { | | | |
| physCellId | Physical CellID of the NR Cell 1 | | |
| measResult SEQUENCE { | | | |
| cellResults SEQUENCE { | | | |
| resultsSSB-Cell | Not present | | |
| resultsCSI-RS-Cell ::= SEQUENCE { | | | |
| rsrp | (0..127) | | |
| rsrq | (0..127) | | |
| sinr | Not present | | |
| } | | | |
| } | | | |
| rsIndexResults SEQUENCE { | | | |
| resultsSSB-Indexes | Not present | | |
| resultsCSI-RS-Indexes SEQUENCE (SIZE (1..maxNrofIndexesToReport2)) OF ResultsPerCSI-RS-Index { | 1 entry | | |
| ResultsPerCSI-RS-Index[1] SEQUENCE { | | entry 1 | |
| csi-RS-Index | 0 | | |
| csi-RS-Results SEQUENCE { | | | |
| rsrp | (0..127) | | |
| rsrq | Not present | | |
| sinr | Not present | | |
| } | | | |
| } | | | |
| } | | | |
| } | | | |
| } | | | |
| } | | | |
| measResultNeighCells CHOICE { | | | |
| measResultListNR SEQUENCE (SIZE (1..maxCellReport)) OF MeasResultNR { | 1 entry | | |
| MeasResultNR[1] SEQUENCE { | | entry 1 | |
| physCellId | Physical CellID of the NR Cell 3 | | |
| measResult SEQUENCE { | | | |
| cellResults SEQUENCE { | | | |
| resultsSSB-Cell | Not present | | |
| resultsCSI-RS-Cell SEQUENCE { | | | |
| rsrp | (0..127) | | |
| rsrq | (0..127) | | |
| sinr | Not present | | |
| } | | | |
| } | | | |
| rsIndexResults SEQUENCE { | | | |
| resultsSSB-Indexes | Not Present | | |
| resultsCSI-RS-Indexes SEQUENCE (SIZE (1..maxNrofIndexesToReport2)) OF ResultsPerCSI-RS-Index { | 1 entry | | |
| ResultsPerCSI-RS-Index [1] SEQUENCE { | | entry 1 | |
| csi-RS-Index | CSI-RS-Index 0 | | |
| csi-RS-Results SEQUENCE { | | | |
| rsrp | (0..127) | | |
| } | | | |
| } | | | |
| } | | | |
| } | | | |
| } | | | |

| | | | |
|----------|-------------|--|--|
| rsrq | Not present | | |
| sinr | Not present | | |
| } | | | |
| } | | | |
| } | | | |
| } | | | |
| } | | | |
| cgi-Info | Not present | | |
| } | | | |
| } | | | |
| } | | | |

8.2.3.11 Measurement configuration control and reporting / Measurement Gaps

8.2.3.11.1 Measurement configuration control and reporting / Measurement Gaps / NR FR1 / EN-DC

8.2.3.11.1.1 Test Purpose (TP)

(1)

```
with { UE in RRC_CONNECTED state with EN-DC, and, MCG (E-UTRA PDCP) and SCG }
ensure that {
  when { UE receives RRCConnectionReconfiguration message to setup fr1-Gap to report periodical
measurements for LTE serving and NR neighbor cell on FR1 frequency }
  then { UE applies fr1-Gap and sends periodical measurement reports for LTE serving and NR
neighbor cell on FR1 frequency }
}
```

(2)

```
with { UE in RRC_CONNECTED state with EN-DC, and, MCG (E-UTRA PDCP) and SCG }
ensure that {
  when { UE receives RRCConnectionReconfiguration message to setup fr1-Gap and nr-Config IE
containing MeasConfig to report periodical measurements for NR serving and neighbor cells on FR1
frequency }
  then { UE applies fr1-Gap and sends periodical measurement reports for NR serving and neighbor
cells on FR1 frequency }
}
```

8.2.3.11.1.2 Conformance requirements

References: The conformance requirements covered in the current TC are specified in: TS 36.331, clause 5.3.5.3 and 5.5.2.9, and TS 38.331, clause 5.5.2.1 and 5.5.5.1. Unless otherwise stated these are Rel-15 requirements.

[TS 36.331, clause 5.3.5.3]

If the *RRCConnectionReconfiguration* message does not include the *mobilityControlInfo* and the UE is able to comply with the configuration included in this message, the UE shall:

...

1> if the received *RRCConnectionReconfiguration* includes the *nr-SecondaryCellGroupConfig*:

2> perform NR RRC Reconfiguration as specified in TS 38.331 [82], clause 5.3.5.3;

...

1> if the *RRCConnectionReconfiguration* message includes the *measConfig*:

2> perform the measurement configuration procedure as specified in 5.5.2;

...

1> set the content of *RRCCConnectionReconfigurationComplete* message as follows:

...

2> if the received *RRCCConnectionReconfiguration* message included *nr-SecondaryCellGroupConfig*:

3> include *scg-ConfigResponseNR* in accordance with TS 38.331 [82, 5.3.5.3];

1> submit the *RRCCConnectionReconfigurationComplete* message to lower layers for transmission using the new configuration, upon which the procedure ends;

[TS 36.331, clause 5.5.2.9]

The UE shall:

1> if *measGapConfig* is set to *setup*:

2> if a measurement gap configuration *measGapConfig* or *measGapConfigPerCC-List* is already setup, release the measurement gap configuration;

2> if the *gapOffset* in *measGapConfig* indicates a non-uniform gap pattern:

...

2> else:

3> setup the measurement gap configuration indicated by the *measGapConfig* in accordance with the received *gapOffset*, i.e., the first subframe of each gap occurs at an SFN and subframe meeting the following condition (SFN and subframe of MCG cells):

$$\text{SFN mod } T = \text{FLOOR}(\text{gapOffset}/10);$$

$$\text{subframe} = \text{gapOffset mod } 10;$$

with $T = \text{MGRP}/10$ as defined in TS 36.133 [16];

2> if EN-DC is configured:

3> if the UE is configured with *fr1-Gap* set to *TRUE*:

4> apply the gap configuration for LTE serving cells and for NR serving cells on FR1;

3> else:

4> apply the gap configuration for all LTE and NR serving cells;

2> if *mgta* is set to *TRUE*, apply a timing advance value of 0.5ms to the gap occurrences calculated above according to TS 38.133 [16];

NOTE 1: The UE applies a single gap, which timing is relative to the MCG cells, even when configured with DC. In case of EN-DC, the UE may either be configured with a single (common) gap or with two separate gaps i.e. a first one for FR1 (configured by E-UTRA RRC) and a second one for FR2 (configured by NR RRC).

1> else if *measGapConfig* is set to *release*:

2> release the measurement gap configuration *measGapConfig*;

...

[TS 38.331, clause 5.5.2.1]

The network applies the procedure as follows:

- to ensure that, whenever the UE has a *measConfig*, it includes a *measObject* for the SpCell and for each NR SCell to be measured;

- to configure at most one measurement identity using a reporting configuration with the *reportType* set to *reportCGI*;
- to ensure that, for all SSB based reporting configurations have at most one measurement object with the same *ssbFrequency* and *ssbSubcarrierSpacing*;

The UE shall:

- 1> if the received *measConfig* includes the *measObjectToRemoveList*:
 - 2> perform the measurement object removal procedure as specified in 5.5.2.4;
 - 1> if the received *measConfig* includes the *measObjectToAddModList*:
 - 2> perform the measurement object addition/modification procedure as specified in 5.5.2.5;
 - 1> if the received *measConfig* includes the *reportConfigToRemoveList*:
 - 2> perform the reporting configuration removal procedure as specified in 5.5.2.6;
 - 1> if the received *measConfig* includes the *reportConfigToAddModList*:
 - 2> perform the reporting configuration addition/modification procedure as specified in 5.5.2.7;
 - 1> if the received *measConfig* includes the *quantityConfig*:
 - 2> perform the quantity configuration procedure as specified in 5.5.2.8;
 - 1> if the received *measConfig* includes the *measIdToRemoveList*:
 - 2> perform the measurement identity removal procedure as specified in 5.5.2.2;
 - 1> if the received *measConfig* includes the *measIdToAddModList*:
 - 2> perform the measurement identity addition/modification procedure as specified in 5.5.2.3;
 - 1> if the received *measConfig* includes the *measGapConfig*:
 - 2> perform the measurement gap configuration procedure as specified in 5.5.2.9;
- ...

[TS 38.331, clause 5.5.5.1]



Figure 5.5.5.1-1: Measurement reporting

The purpose of this procedure is to transfer measurement results from the UE to the network. The UE shall initiate this procedure only after successful security activation.

For the *measId* for which the measurement reporting procedure was triggered, the UE shall set the *measResults* within the *MeasurementReport* message as follows:

- 1> for each serving cell configured with *servingCellMO*:
 - 2> if the *reportConfig* associated with the *measId* that triggered the measurement reporting includes *rsType*:

- 3> if the serving cell measurements based on the *rsType* included in the *reportConfig* that triggered the measurement report are available:
 - 4> set the *measResultServingCell* within *measResultServingMOList* to include RSRP, RSRQ and the available SINR of the serving cell, derived based on the *rsType* included in the *reportConfig* that triggered the measurement report;
- 1> set the *servCellId* within *measResultServingMOList* to include each NR serving cell that is configured with *servingCellMO*, if any;
- ...
- 1> if there is at least one applicable neighbouring cell to report:
 - 2> if the *reportType* is set to *eventTriggered* or *periodical*:
 - 3> set the *measResultNeighCells* to include the best neighbouring cells up to *maxReportCells* in accordance with the following:
 - 4> if the *reportType* is set to *eventTriggered*:
 - 5> include the cells included in the *cellsTriggeredList* as defined within the *VarMeasReportList* for this *measId*;
 - 4> else:
 - ...
 - 4> for each cell that is included in the *measResultNeighCells*, include the *physCellId*;
 - 4> if the *reportType* is set to *eventTriggered* or *periodical*:
 - 5> for each included cell, include the layer 3 filtered measured results in accordance with the *reportConfig* for this *measId*, ordered as follows:
 - 6> if the *measObject* associated with this *measId* concerns NR:
 - 7> if *rsType* in the associated *reportConfig* is set to *ssb*:
 - 8> set *resultsSSB-Cell* within the *measResult* to include the SS/PBCH block based quantity(ies) indicated in the *reportQuantityCell* within the concerned *reportConfig*, in decreasing order of the sorting quantity, determined as specified in 5.5.5.3, i.e. the best cell is included first;
 - ...
 - 1> increment the *numberOfReportsSent* as defined within the *VarMeasReportList* for this *measId* by 1;
 - 1> stop the periodical reporting timer, if running;
 - 1> if the *numberOfReportsSent* as defined within the *VarMeasReportList* for this *measId* is less than the *reportAmount* as defined within the corresponding *reportConfig* for this *measId*:
 - 2> start the periodical reporting timer with the value of *reportInterval* as defined within the corresponding *reportConfig* for this *measId*;
 - 1> else:
 - 2> if the *reportType* is set to *periodical*:
 - 3> remove the entry within the *VarMeasReportList* for this *measId*;
 - 3> remove this *measId* from the *measIdList* within *VarMeasConfig*;
 - 1> if the UE is configured with EN-DC:
 - 2> if SRB3 is configured:

3> submit the *MeasurementReport* message via SRB3 to lower layers for transmission, upon which the procedure ends;

2> else:

3> submit the *MeasurementReport* message via the EUTRA MCG embedded in E-UTRA RRC message *ULInformationTransferMRDC* as specified in TS 36.331 [10].

...

8.2.3.11.1.3 Test description

8.2.3.11.1.3.1 Pre-test conditions

System Simulator:

- E-UTRA Cell 1 is PCell , NR Cell 1 is PSCell on FR1 and NR Cell 3 is inter-frequency neighbour Cell on FR1.

UE:

- None.

Preamble:

- The UE is in state RRC_CONNECTED using generic procedure parameter Connectivity (*EN-DC*) and Bearers (*MCG and SCG*) established according to TS 38.508-1 [4].

8.2.3.11.1.3.2 Test procedure sequence

Table 8.2.3.11.3.2-1 illustrates the downlink power levels and other changing parameters to be applied for the cells at various time instants of the test execution. Row marked "T0" denotes the initial conditions after preamble. The exact instants on which these values shall be applied are described in the texts in this clause.

Table 8.2.3.11.1.3.2-1: Time instances of cell power level and parameter changes

| | Parameter | Unit | E-UTRA Cell 1 | NR Cell 1 | NR Cell 3 | Remark |
|----|-----------------------|------------|---------------|-----------|-----------|--|
| T0 | Cell-specific RS EPRE | dBm/15 kHz | -85 | - | - | Switch on NR neighbour Cell and UE start to perform E-UTRA interRAT measurement. |
| | SS/PBCH SSS EPRE | dBm/SC S | - | -88 | -88 | |

Table 8.2.3.11.1.3.2-2: Main behaviour

| St | Procedure | Message Sequence | | TP | Verdict |
|----|---|------------------|--|----|---------|
| | | U - S | Message | | |
| 1 | The SS transmits an <i>RRCCONNECTIONRECONFIGURATION</i> message to setup fr1-Gap to report periodical measurements for E-UTRA serving Cell 1 and NR neighbor cell 3 on FR1 frequency. | <-- | <i>RRCCONNECTIONRECONFIGURATION</i> | - | - |
| 2 | The UE transmits an <i>RRCCONNECTIONRECONFIGURATIONCOMPLETE</i> message to confirm the setup of fr1-Gap and report periodical measurements for E-UTRA serving cell1 and NR neighbor cell 3 on FR1 frequency. | --> | <i>RRCCONNECTIONRECONFIGURATIONCOMPLETE</i> | - | - |
| 3 | Wait and ignore <i>MEASUREMENTREPORT</i> messages for 8 s to allow UE to measure the neighbouring cells. | - | - | - | - |
| - | EXCEPTION: In parallel to events described in step 4 the steps specified in table 8.2.3.11.1.3.2-3 shall take place. | - | - | - | - |
| 4 | Wait for 30 s to ensure that the UE performs a periodical inter frequency reporting. | - | - | - | - |
| - | EXCEPTION: Steps 5 to 7 shall be repeated for k=1 to 11 (increment=1).
Note: skip the gap pattern among #2 - #11 not supported by the UE according to the PICS setting given in TS 38.508-2[5] table A.4.3.6-1 | - | - | - | - |
| 5 | The SS transmits an <i>RRCCONNECTIONRECONFIGURATION</i> including measConfig to change fr1-Gap. | <-- | <i>RRCCONNECTIONRECONFIGURATION</i> | - | - |
| 6 | The UE transmits an <i>RRCCONNECTIONRECONFIGURATIONCOMPLETE</i> message to confirm the change of fr1-Gap. | --> | <i>RRCCONNECTIONRECONFIGURATIONCOMPLETE</i> | - | - |
| - | EXCEPTION: In parallel to events described in step 7 the steps specified in table 8.2.3.11.1.3.2-3 shall take place. | - | - | - | - |
| 7 | Wait for 30 s to ensure that the UE performs a periodical inter frequency reporting. | - | - | - | - |
| 8 | SS transmits an <i>RRCCONNECTIONRECONFIGURATION</i> message including measConfig to release fr1-Gap and measid of periodical measurements. | <-- | <i>RRCCONNECTIONRECONFIGURATION</i> | - | - |
| 9 | The UE transmits an <i>RRCCONNECTIONRECONFIGURATIONCOMPLETE</i> message. | --> | <i>RRCCONNECTIONRECONFIGURATIONCOMPLETE</i> | - | - |
| 10 | Wait 10s | - | - | - | - |
| 11 | The SS transmits an <i>RRCCONNECTIONRECONFIGURATION</i> including measConfig to setup fr1-Gap and nr-Config IE containing measConfig to report periodical measurements for NR serving Cell 1 and NR neighbor cell 3 on FR1 frequency. | <-- | <i>RRCCONNECTIONRECONFIGURATION (RRCRECONFIGURATION)</i> | - | - |
| 12 | The UE transmits an <i>RRCCONNECTIONRECONFIGURATIONCOMPLETE</i> message to confirm the setup of fr1-Gap and report periodical measurements for NR serving Cell 1 and NR neighbor cell 3 on FR1 frequency. | --> | <i>RRCCONNECTIONRECONFIGURATIONCOMPLETE (RRCRECONFIGURATIONCOMPLETE)</i> | - | - |
| 13 | Wait and ignore <i>MEASUREMENTREPORT</i> messages for 8 s to allow for UE to measure the neighbouring cells. | - | - | - | - |
| - | EXCEPTION: In parallel to events described in step 14 the steps specified in table 8.2.3.11.1.3.2-4 shall take place. | - | - | - | - |
| 14 | Wait for 30 s to ensure that the UE performs a | - | - | - | - |

| | | | | | |
|----|--|-----|---|---|---|
| | periodical inter frequency reporting. | | | | |
| - | EXCEPTION: Steps 15 to 17 shall be repeated for k=1 to 11 (increment=1).
Note: skip the gap pattern among #2 - #11 not supported by the UE according to the PICS setting given in TS 38.508-2[5] table A.4.3.6-1. | - | - | - | - |
| 15 | The SS transmits an <i>RRCConnectionReconfiguration</i> including measConfig to change fr1-Gap. | <- | <i>RRCConnectionReconfiguration</i> | - | - |
| 16 | The UE transmits an <i>RRCConnectionReconfigurationComplete</i> message to confirm the change of fr1-Gap. | --> | <i>RRCConnectionReconfigurationComplete</i> | - | - |
| - | EXCEPTION: In parallel to events described in step 17 the steps specified in table 8.2.3.11.1.3.2-4 shall take place. | - | - | - | - |
| 17 | Wait for 30 s to ensure that the UE performs a periodical inter frequency reporting. | - | - | - | - |
| 18 | SS transmits an <i>RRCConnectionReconfiguration</i> message including measConfig to release fr1-Gap and measid of periodical measurements. | <- | <i>RRCConnectionReconfiguration</i> | - | - |
| 19 | The UE transmits an <i>RRCConnectionReconfigurationComplete</i> message. | --> | <i>RRCConnectionReconfigurationComplete</i> | - | - |

Table 8.2.3.11.1.3.2-3: Parallel behaviour

| St | Procedure | Message Sequence | | TP | Verdict |
|----|---|------------------|--------------------------|----|---------|
| | | U - S | Message | | |
| - | EXCEPTION: After the 1st message is received, step 1 below shall be repeated every time the duration indicated in the IE <i>reportInterval</i> has elapsed. | - | - | - | - |
| 1 | Check: Does the UE transmit a <i>MeasurementReport</i> message to perform periodical interRAT reporting for E-UTRA serving Cell 1 and NR Cell 3? | --> | <i>MeasurementReport</i> | 1 | P |

Table 8.2.3.11.1.3.2-4: Parallel behaviour

| St | Procedure | Message Sequence | | TP | Verdict |
|----|--|------------------|--|----|---------|
| | | U - S | Message | | |
| - | EXCEPTION: After the 1st message is received, step 1 below shall be repeated every time the duration indicated in the IE <i>reportInterval</i> has elapsed. | - | - | - | - |
| 1 | Check: Does the UE transmit a <i>MeasurementReport</i> encapsulated in <i>ULInformationTransferMRDC</i> message to perform periodical inter frequency reporting for NR serving Cell 1 and NR Cell 3? | --> | <i>ULInformationTransferMRDC</i>
(<i>MeasurementReport</i>) | 2 | P |

8.2.3.11.1.3.3 Specific message contents

Table 8.2.3.11.1.3.3-0: Conditions for specific message contents in Table 8.2.3.11.1.3.3-1

| Condition | Explanation |
|-----------|--------------------------|
| Band > 64 | If band > 64 is selected |

Table 8.2.3.11.1.3.3-1: RRCConnectionReconfiguration (step 1, Table 8.2.3.11.1.3.2-2)

| Derivation Path: 36.508 [7], Table 4.6.1-8 | | | |
|---|-------------------------------------|-----------------------------|-----------|
| Information Element | Value/remark | Comment | Condition |
| RRCConnectionReconfiguration ::= SEQUENCE { | | | |
| criticalExtensions CHOICE { | | | |
| c1 CHOICE { | | | |
| rrcConnectionReconfiguration-r8 SEQUENCE { | | | |
| measConfig SEQUENCE { | | | |
| measObjectToAddModList SEQUENCE (SIZE (1.. maxNrofObjectld)) OF MeasObjectToAddMod { | 2 entries | | |
| MeasObjectToAddMod[1] SEQUENCE { | | entry 1 | |
| measObjectld | 1 | MeasObjectldEutra-f1 | |
| measObject CHOICE { | | | |
| measObjectEUTRA | MeasObjectEUTRA-GENERIC(f1) | | |
| measObjectEUTRA | MeasObjectEUTRA-GENERIC(maxEARFCN) | | Band > 64 |
| } | | | |
| } | | | |
| MeasObjectToAddMod[2] SEQUENCE { | | entry 2 | |
| measObjectld | 2 | MeasObjectldNR-f2 | |
| measObject CHOICE { | | | |
| measObjectNR-r15 | MeasObjectNR-GENERIC(NRf2) | | |
| } | | | |
| } | | | |
| reportConfigToAddModList SEQUENCE (SIZE (1..maxReportConfigld)) OF ReportConfigToAddMod { | 1 entry | | |
| ReportConfigToAddMod[1] SEQUENCE { | | entry 1 | |
| reportConfigld | 1 | | |
| reportConfig | ReportConfigInterRAT-PERIODICAL | | |
| } | | | |
| } | | | |
| measldToAddModList SEQUENCE (SIZE (1.. maxNrofMeasld)) OF MeasldToAddMod { | 1 entry | | |
| MeasldToAddMod[1] SEQUENCE { | | entry 1 | |
| measld | 1 | | |
| measObjectld | 2 | MeasObjectldNR-f2 | |
| reportConfigld | 1 | | |
| } | | | |
| } | | | |
| quantityConfig | QuantityConfig-DEFAULT | | |
| measGapConfig CHOICE { | | | |
| setup SEQUENCE { | | | |
| gapOffset CHOICE { | | | |
| gp0 | 9 | MGRP = 40 ms,
MGL = 6 ms | |
| } | | | |
| } | | | |
| measObjectToAddModList-v9e0 SEQUENCE (SIZE (1..maxObjectld)) OF MeasObjectToAddMod-v9e0 { | 1 entry | | Band > 64 |
| MeasObjectToAddMod-v9e0[1] SEQUENCE { | | entry 1 | |
| measObjectEUTRA-v9e0 SEQUENCE { | | | |
| carrierFreq-v9e0 | Same downlink EARFCN as used for f1 | | |
| } | | | |

| | | | |
|-------------|------|------------|--|
| } | | | |
| fr1-gap-r15 | True | | |
| mgta-r15 | True | Mgta=0.5ms | |
| } | | | |
| } | | | |
| } | | | |
| } | | | |

Table 8.2.3.11.1.3.3-2: MeasObjectNR-GENERIC(NRf2) (Table 8.2.3.11.1.3.3-1)

| Derivation Path: 36.508 [7], Table 4.6.6-2B | | | |
|---|---|---------|-----------|
| Information Element | Value/remark | Comment | Condition |
| MeasObjectNR-r15 ::= SEQUENCE { | | | |
| carrierFreq-r15 | Downlink carrier frequency of NR cell 3 | | |
| } | | | |

Table 8.2.3.11.1.3.3-3: ReportConfigInterRAT-PERIODICAL (Table 8.2.3.11.1.3.3-1)

| Derivation Path: 36.508 [7], Table 4.6.6-9 | | | |
|--|--------------|---------|-----------|
| Information Element | Value/remark | Comment | Condition |
| ReportConfigInterRAT-PERIODICAL ::= SEQUENCE { | | | |
| reportQuantityCellNR-r15 SEQUENCE { | | | |
| ss-rsrp | true | | |
| ss-rsrq | true | | |
| ss-sinr | false | | |
| } | | | |
| } | | | |

Table 8.2.3.11.1.3.3-4: QuantityConfig-DEFAULT (Table 8.2.3.11.1.3.3-1)

| Derivation Path: 36.508 [7], Table 4.6.6-3A | | | |
|---|--------------|---------|-----------|
| Information Element | Value/remark | Comment | Condition |
| QuantityConfig-DEFAULT ::= SEQUENCE { | | | |
| quantityConfigNRList-r15 SEQUENCE ((SIZE (1..maxQuantSetsNR-r15)) OF QuantityConfigNR-r15 { | 1 entry | | |
| QuantityConfigNR-r15[1] SEQUENCE { | | entry 1 | |
| measQuantityCellNR-r15 SEQUENCE { | | | |
| filterCoeff-RSRP-r15 | fc4 | | |
| filterCoeff-RSRQ-r15 | fc4 | | |
| filterCoefficient-SINR-r13 | fc4 | | |
| } | | | |
| } | | | |
| } | | | |
| } | | | |

Table 8.2.3.11.1.3.3-5: MeasurementReport (step 1, Table 8.2.3.11.1.3.2-3)

| Derivation Path: 36.508 [7], Table 4.6.1-5 | | | |
|--|-----------------------------------|---------|-----------|
| Information Element | Value/remark | Comment | Condition |
| MeasurementReport ::= SEQUENCE { | | | |
| criticalExtensions CHOICE { | | | |
| c1 CHOICE{ | | | |
| measurementReport-r8 SEQUENCE { | | | |
| measResults SEQUENCE { | | | |
| measId | 1 | | |
| measResultPCell SEQUENCE { | | | |
| rsrpResult | (0..97) | | |
| rsrqResult | (0..34) | | |
| } | | | |
| measResultNeighCells CHOICE { | | | |
| measResultNeighCellListNR-r15 SEQUENCE (SIZE (1..maxCellReport)) OF MeasResultCellNR-r15 { | 1 entry | | |
| MeasResultCellNR-r15[1] SEQUENCE { | | entry 1 | |
| pci-r15 | PhysicalCellIdentity of NR Cell 3 | | |
| measResultCell-r15 SEQUENCE { | | | |
| rsrpResult-r15 | (0..127) | | |
| rsrqResult-r15 | (0..127) | | |
| } | | | |
| } | | | |
| } | | | |
| } | | | |
| } | | | |
| } | | | |
| } | | | |

Table 8.2.3.11.1.3.3-6: RRCConnectionReconfiguration (steps 5, 15 Table 8.2.3.11.1.3.2-2)

| Derivation Path: 36.508 [7], Table 4.6.1-8 | | | |
|---|--------------|--|------------------------------|
| Information Element | Value/remark | Comment | Condition |
| RRCConnectionReconfiguration ::= SEQUENCE { | | | |
| criticalExtensions CHOICE { | | | |
| c1 CHOICE{ | | | |
| rrcConnectionReconfiguration-r8 SEQUENCE { | | | |
| measConfig SEQUENCE { | | | |
| quantityConfig | Not present | | |
| measGapConfig CHOICE { | | | |
| setup SEQUENCE { | | | |
| gapOffset CHOICE { | | | |
| gp1 | 9 | Gap Pattern #1, MGRP = 80 ms, MGL = 6 ms | k=1 |
| gp2-r14 | 9 | Gap Pattern #2, MGRP = 40 ms, MGL = 3 ms | k=2
pc_gp2_gp3_en_dc=True |
| gp3-r14 | 9 | Gap Pattern #3, MGRP = 80 ms, MGL = 3 ms | k=3
pc_gp2_gp3_en_dc=True |
| gp4-r15 | 9 | Gap Pattern #4, MGRP = 20 ms, MGL = 6 ms | k=4
pc_gp4_en_dc=True |
| gp5-r15 | 9 | Gap Pattern #5, MGRP = 160 ms, MGL = 6 ms | k=5
pc_gp5_en_dc=True |
| gp6-r15 | 9 | Gap Pattern #6, MGRP = 20 ms, MGL = 4 ms | k=6
pc_gp6_en_dc=True |
| gp7-r15 | 9 | Gap Pattern #7, MGRP = 40 ms, MGL = 4 ms | k=7
pc_gp7_en_dc=True |
| gp8-r15 | 9 | Gap Pattern #8, MGRP = 80 ms, MGL = 4 ms | k=8
pc_gp8_en_dc=True |
| gp9-r15 | 9 | Gap Pattern #9, MGRP = 160 ms, MGL = 4 ms | k=9
pc_gp9_en_dc=True |
| gp10-r15 | 9 | Gap Pattern #10, MGRP = 20 ms, MGL = 3 ms | k=10
pc_gp10_en_dc=True |
| gp11-r15 | 9 | Gap Pattern #11, MGRP = 160 ms, MGL = 3 ms | k=11
pc_gp11_en_dc=True |
| } | | | |
| } | | | |
| } | | | |
| fr1-gap-r15 | True | | |
| mgta-r15 | False | Mgta=0ms | k=6-11 |
| | True | Mgta=0.5ms | k=1-5 |
| } | | | |
| } | | | |
| } | | | |
| } | | | |

Table 8.2.3.11.1.3.3-7: RRCConnectionReconfiguration (step 8 Table 8.2.3.11.1.3.2-2)

| Derivation Path: 36.508 [7], Table 4.6.1-8 | | | |
|---|--------------|---------|-----------|
| Information Element | Value/remark | Comment | Condition |
| RRCConnectionReconfiguration ::= SEQUENCE { | | | |
| criticalExtensions CHOICE { | | | |
| c1 CHOICE{ | | | |
| rrcConnectionReconfiguration-r8 SEQUENCE { | | | |
| measConfig SEQUENCE { | | | |
| measIdToRemoveList SEQUENCE (SIZE | 1 entry | | |
| (1..maxMeasId) OF MeasId { | | | |
| MeasId[1] | 1 | entry 1 | |
| } | | | |
| } | | | |
| quantityConfig | Not present | | |
| measConfig SEQUENCE { | | | |
| measGapConfig CHOICE { | | | |
| release | NULL | | |
| } | | | |
| } | | | |
| } | | | |
| } | | | |
| } | | | |
| } | | | |

Table 8.2.3.11.1.3.3-10: MeasConfig (Table 8.2.3.11.1.3.3-9)

| Derivation path: 38.508-1[4] Table 4.6.3-69 | | | |
|---|-------------------------|-------------------|-----------|
| Information Element | Value/Remark | Comment | Condition |
| measConfig ::= SEQUENCE { | | | |
| measObjectToAddModList SEQUENCE (SIZE (1..maxNrofObjectId)) OF MeasObjectToAddMod { | 2 entries | | |
| MeasObjectToAddMod[1] SEQUENCE { | | entry 1 | |
| measObjectId | 1 | MeasObjectIdNR-f1 | |
| measObject CHOICE { | | | |
| measObjectNR | MeasObjectNR-GENERIC(0) | NR Cell 1 | |
| } | | | |
| } | | | |
| MeasObjectToAddMod[2] SEQUENCE { | | entry 2 | |
| measObjectId | 2 | MeasObjectIdNR-f2 | |
| measObject CHOICE { | | | |
| measObjectNR | MeasObjectNR-GENERIC(0) | NR Cell 3 | |
| } | | | |
| } | | | |
| } | | | |
| reportConfigToAddModList SEQUENCE (SIZE (1..maxReportConfigId)) OF ReportConfigToAddMod { | 1 entry | | |
| ReportConfigToAddMod[1] SEQUENCE { | | entry 1 | |
| reportConfigId | 1 | ReportConfigId | |
| reportConfig | ReportConfig-Periodical | | |
| } | | | |
| } | | | |
| measIdToAddModList SEQUENCE (SIZE (1..maxNrofMeasId)) OF MeasIdToAddMod { | 1 entry | | |
| MeasIdToAddMod[1] SEQUENCE { | | entry 1 | |
| measId | 2 | | |
| measObjectId | 2 | MeasObjectIdNR-f2 | |
| reportConfigId | 1 | ReportConfigId | |
| } | | | |
| } | | | |
| quantityConfig | QuantityConfig | | |
| } | | | |

Table 8.2.3.11.1.3.3-11: MeasObjectNR-GENERIC(0) (Table 8.2.3.11.1.3.3-10)

| Derivation Path: 38.508-1 [4], Table 4.6.3-76 | | | |
|---|---------------------------------|---------|-----------|
| Information Element | Value/remark | Comment | Condition |
| MeasObjectNR ::= SEQUENCE { | | | |
| ssbFrequency | Downlink ARFCN of NR cell 3 SSB | | |
| } | | | |

Table 8.2.3.11.1.3.3-12: MeasObjectNR-GENERIC(0) (Table 8.2.3.11.1.3.3-10)

| Derivation Path: 38.508-1 [4], Table 4.6.3-76 | | | |
|---|---------------------------------|---------|-----------|
| Information Element | Value/remark | Comment | Condition |
| MeasObjectNR ::= SEQUENCE { | | | |
| ssbFrequency | Downlink ARFCN of NR cell 1 SSB | | |
| } | | | |

Table 8.2.3.11.1.3.3-13: ReportConfig-Periodical (Table 8.2.3.11.1.3.3-10)

| Derivation Path: 38.508-1 [4], Table 4.6.3-142 with condition Periodical | | | |
|--|--------------|---------|-----------|
| Information Element | Value/remark | Comment | Condition |
| ReportConfigNR ::= SEQUENCE { | | | |
| reportType CHOICE { | | | |
| Periodical SEQUENCE { | | | |
| reportQuantityCell SEQUENCE { | | | |
| rsrp | true | | |
| rsrq | true | | |
| sinr | false | | |
| } | | | |
| maxReportCells | 1 | | |
| } | | | |
| } | | | |
| } | | | |

Table 8.2.3.11.1.3.3-14: QuantityConfig (Table 8.2.3.11.1.3.3-10)

| Derivation Path: 38.508-1 [4], Table 4.6.3-127 | | | |
|--|--------------|---------|-----------|
| Information Element | Value/remark | Comment | Condition |
| QuantityConfig ::= SEQUENCE { | | | |
| quantityConfigNR-List SEQUENCE (SIZE (1..maxNrofQuantityConfig)) OF QuantityConfigNR { | 1 entry | | |
| QuantityConfigNR[1] SEQUENCE { | | entry 1 | |
| quantityConfigCell SEQUENCE { | | | |
| ssb-FilterConfig SEQUENCE { | | | |
| filterCoefficientRSRP | fc4 | | |
| filterCoefficientRSRQ | fc4 | | |
| filterCoefficientRS-SINR | fc4 | | |
| } | | | |
| } | | | |
| } | | | |
| } | | | |
| } | | | |

Table 8.2.3.11.1.3.3-15: ULInformationTransferMRDC (step1, Table 8.2.3.11.1.3.2-4)

| Derivation Path: 36.508 [7], Table 4.6.1-27 | | | |
|---|---|---------|-----------|
| Information Element | Value/remark | Comment | Condition |
| ULInformationTransferMRDC ::= SEQUENCE { | | | |
| ul-DCCH-MessageNR-r15 | OCTET STRING including the MeasurementReport message according to Table 8.2.3.11.1.3.3-16 | | |
| } | | | |

Table 8.2.3.11.1.3.3-16: MeasurementReport (Table 8.2.3.11.1.3.3-15)

| Derivation Path: TS 38.508-1 [4], clause 4.6.1-5A | | | |
|---|----------------------------------|---------|-----------|
| Information Element | Value/remark | Comment | Condition |
| MeasurementReport ::= SEQUENCE { | | | |
| criticalExtensions CHOICE { | | | |
| c1 CHOICE { | | | |
| measurementReport ::= SEQUENCE { | | | |
| measResults SEQUENCE { | | | |
| measId | 2 | | |
| measResultServingMOList SEQUENCE { | 1 entry | | |
| servCellId | ServCellIndex of NR Cell 1 | | |
| measResultServingCell SEQUENCE { | | | |
| physCellId | Physical CellID of the NR Cell 1 | | |
| measResult SEQUENCE { | | | |
| cellResults SEQUENCE { | | | |
| resultsSSB-Cell SEQUENCE { | | | |
| rsrp | (0..127) | | |
| rsrq | (0..127) | | |
| } | | | |
| } | | | |
| } | | | |
| } | | | |
| measResultNeighCells CHOICE { | | | |
| measResultListNR SEQUENCE { | 1 entry | | |
| physCellId | Physical CellID of the NR Cell 3 | | |
| measResult SEQUENCE { | | | |
| cellResults SEQUENCE { | | | |
| resultsSSB-Cell SEQUENCE { | | | |
| rsrp | (0..127) | | |
| rsrq | (0..127) | | |
| } | | | |
| resultsCSI-RS-Cell | Not present | | |
| } | | | |
| rsIndexResults | Not present | | |
| } | | | |
| cgi-Info | Not present | | |
| } | | | |
| } | | | |
| } | | | |

Table 8.2.3.11.1.3.3-17: RRCConnectionReconfiguration (step 18, Table 8.2.3.11.1.3.2-2)

| Derivation Path: 36.508 [7], Table 4.6.1-8 with condition EN-DC_EmbedNR_RRCRecon | | | |
|--|--------------|---------|-----------|
| Information Element | Value/remark | Comment | Condition |
| RRCConnectionReconfiguration ::= SEQUENCE { | | | |
| criticalExtensions CHOICE { | | | |
| c1 CHOICE { | | | |
| rrcConnectionReconfiguration-r8 SEQUENCE { | | | |
| measConfig SEQUENCE { | | | |
| measGapConfig CHOICE { | | | |
| release | NULL | | |
| } | | | |
| } | | | |
| } | | | |
| } | | | |
| } | | | |
| } | | | |

Table 8.2.3.11.1.3.3-18: RRCReconfiguration (Table 8.2.3.11.1.3.3-17)

| Derivation Path: TS 38.508-1 [4], Table 4.6.1-13 | | | |
|---|---------------------------|------------------------------|-----------|
| Information Element | Value/remark | Comment | Condition |
| RRCReconfiguration ::= SEQUENCE { | | | |
| rrc-TransactionIdentifier | RRC-TransactionIdentifier | 38.508-1 [4] Table 4.6.5-12. | |
| criticalExtensions CHOICE { | | | |
| c1 CHOICE { | | | |
| rrcReconfiguration SEQUENCE { | | | |
| radioBearerConfig | Not present | | |
| secondaryCellGroup | Not present | | |
| measConfig SEQUENCE { | | | |
| measObjectToAddModList | Not present | | |
| reportConfigToAddModList | Not present | | |
| measIdToRemoveList SEQUENCE (SIZE (1..maxMeasId)) OF MeasId { | 1 entry | | |
| MeasId[1] | 2 | entry 1 | |
| } | | | |
| measIdToAddModList | Not present | | |
| quantityConfig | Not present | | |
| } | | | |
| lateNonCriticalExtension | Not present | | |
| nonCriticalExtension | Not present | | |
| } | | | |
| } | | | |
| } | | | |

8.2.3.11.2 Measurement configuration control and reporting / Measurement Gaps / NR FR2 / EN-DC

8.2.3.11.2.1 Test Purpose (TP)

(1)

```
with { UE in RRC_CONNECTED state with EN-DC, and, MCG (E-UTRA PDCP) and SCG }
ensure that {
  when { UE receives RRCConnectionReconfiguration message with nr-Config IE containing MeasConfig to
  setup gapFR2 and report periodical measurements for NR neighbor cell on FR2 frequency }
  then { UE applies gapFR2 and sends periodical measurements for NR neighbor cell on FR2 frequency
}
}
```

8.2.3.11.2.2 Conformance requirements

References: The conformance requirements covered in the current TC are specified in: TS 36.331, clause 5.3.5.3, and TS 38.331, clause 5.5.2.9. Unless otherwise stated these are Rel-15 requirements.

[TS 36.331, clause 5.3.5.3]

If the *RRCConnectionReconfiguration* message does not include the *mobilityControlInfo* and the UE is able to comply with the configuration included in this message, the UE shall:

...

1> set the content of *RRCConnectionReconfigurationComplete* message as follows:

...

2> if the received *RRCConnectionReconfiguration* message included *nr-SecondaryCellGroupConfig*:

3> include *scg-ConfigResponseNR* in accordance with TS 38.331 [82, 5.3.5.3];

- 1> submit the *RRCCONNECTIONRECONFIGURATIONCOMPLETE* message to lower layers for transmission using the new configuration, upon which the procedure ends;

[TS 38.331, clause 5.5.2.9]

The UE shall:

...

- 1> if *gapFR2* is set to setup:
 - 2> if an FR2 measurement gap configuration is already setup, release the FR2 measurement gap configuration;
 - 2> setup the FR2 measurement gap configuration indicated by the *measGapConfig* in accordance with the received *gapOffset*, i.e., the first subframe of each gap occurs at an SFN and subframe meeting the following condition:
 - SFN mod $T = \text{FLOOR}(\text{gapOffset}/10)$;
 - subframe = $\text{gapOffset} \bmod 10$;
 - with $T = \text{MGRP}/10$ as defined in TS 38.133 [14];
 - 2> if *mgta* is configured, apply the specified timing advance to the gap occurrences calculated above (i.e. the UE starts the measurement *mgta* ms before the gap subframe occurrences);
- 1> else if *gapFR2* is set to release:
 - 2> release the FR2 measurement gap configuration;
- 1> if *gapUE* is set to setup:
 - 2> if a per UE measurement gap configuration is already setup, release the per UE measurement gap configuration;
 - 2> setup the per UE measurement gap configuration indicated by the *measGapConfig* in accordance with the received *gapOffset*, i.e., the first subframe of each gap occurs at an SFN and subframe meeting the following condition:
 - SFN mod $T = \text{FLOOR}(\text{gapOffset}/10)$;
 - subframe = $\text{gapOffset} \bmod 10$;
 - with $T = \text{MGRP}/10$ as defined in TS 38.133 [14];
 - 2> if *mgta* is configured, apply the specified timing advance to the gap occurrences calculated above (i.e. the UE starts the measurement *mgta* ms before the gap subframe occurrences);
- 1> else if *gapUE* is set to release:
 - 2> release the per UE measurement gap configuration.

...

NOTE 1: For *gapFR2* configuration, the SFN and subframe of a serving cell on FR2 frequency is used in the gap calculation

8.2.3.11.2.3 Test description

8.2.3.11.2.3.1 Pre-test conditions

System Simulator:

- E-UTRA Cell 1 is PCell, NR Cell 1 is PSCell on FR2 and NR Cell 3 is inter-frequency neighbour Cell on FR2.

UE:

- None.

Preamble:

- The UE is in state RRC_CONNECTED using generic procedure parameter Connectivity (*EN-DC*) and Bearers (*MCG and SCG*) established according to TS 38.508-1 [4].

8.2.3.11.2.3.2 Test procedure sequence

Table 8.2.3.11.3.2-1 illustrates the downlink power levels and other changing parameters to be applied for the cells at various time instants of the test execution. Row marked "T0" denotes the initial conditions after preamble. The exact instants on which these values shall be applied are described in the texts in this clause.

Table 8.2.3.11.2.3.2-1: Time instances of cell power level and parameter changes for FR2

| | Parameter | Unit | E-UTRA Cell 1 | NR Cell 1 | NR Cell 3 | Remark |
|----|-----------------------|------------|---------------|-----------|-----------|--|
| T0 | Cell-specific RS EPRE | dBm/15 kHz | -96 | - | - | Switch on NR neighbour Cell and UE start to perform E-UTRA interRAT measurement. |
| | SS/PBCH SSS EPRE | dBm/SCS | - | -91 | -91 | |

Table 8.2.3.11.2.3.2-2: Main behaviour

| St | Procedure | Message Sequence | | TP | Verdict |
|----|--|------------------|--|----|---------|
| | | U - S | Message | | |
| 1 | The SS transmits an <i>RRCConnectionReconfiguration</i> including nr-Config IE containing measConfig to setup gapFR2 and report periodical measurements for NR neighbor cell 3 on FR2 frequency. | <-- | <i>RRCConnectionReconfiguration</i>
(<i>RRCReconfiguration</i>) | - | - |
| 2 | The UE transmits an <i>RRCConnectionReconfigurationComplete</i> message to confirm the setup gapFR2 and report periodical measurements for NR neighbor cell 3 on FR2 frequency. | --> | <i>RRCConnectionReconfigurationComplete</i>
(<i>RRCReconfigurationComplete</i>) | - | - |
| 3 | Wait and ignore <i>MeasurementReport</i> messages for 8 s to allow for UE to measure the neighbouring cells. | - | - | - | - |
| - | EXCEPTION: In parallel to events described in step 4 the steps specified in table 8.2.3.11.2.3.2-3 shall take place | - | - | - | - |
| 4 | Wait for 30 s to ensure that the UE performs a periodical inter frequency reporting. | - | - | - | - |
| - | EXCEPTION: Steps 5 to 7 shall be repeated for k=13 to 23 (increment=1).
Note: skip the gap pattern among #12 and #15 - #23 not supported by the UE according to the PICS setting. | - | - | - | - |
| 5 | The SS transmits an <i>RRCConnectionReconfiguration</i> including nr-Config IE containing measConfig to change gapFR2 | <-- | <i>RRCConnectionReconfiguration</i>
(<i>RRCReconfiguration</i>) | - | - |
| 6 | The UE transmits an <i>RRCConnectionReconfigurationComplete</i> message to confirm the change of gapFR2 | --> | <i>RRCConnectionReconfigurationComplete</i>
(<i>RRCReconfigurationComplete</i>) | - | - |
| - | EXCEPTION: In parallel to events described in step 7 the steps specified in table 8.2.3.11.1.3.2-3 shall take place | - | - | - | - |
| 7 | Wait for 30 s to ensure that the UE performs a periodical inter frequency reporting. | - | - | - | - |
| 8 | SS transmits an <i>RRCConnectionReconfiguration</i> message including measConfig to release gapFR2 and measid of periodical measurements. | <-- | <i>RRCConnectionReconfiguration</i>
(<i>RRCReconfiguration</i>) | - | - |
| 9 | The UE transmits an <i>RRCConnectionReconfigurationComplete</i> message | --> | <i>RRCConnectionReconfigurationComplete</i>
(<i>RRCReconfigurationComplete</i>) | - | - |

Table 8.2.3.11.2.3.2-3: Parallel behaviour

| St | Procedure | Message Sequence | | TP | Verdict |
|----|--|------------------|--|----|---------|
| | | U - S | Message | | |
| - | EXCEPTION: After the 1st message is received, step 1 below shall be repeated every time the duration indicated in the IE <i>reportInterval</i> has elapsed | - | - | - | - |
| 1 | Check: Does the UE transmit a <i>MeasurementReport</i> encapsulated in <i>ULInformationTransferMRDC</i> message to perform periodical inter frequency reporting for NR serving Cell 1 and NR Cell 3? | --> | <i>ULInformationTransferMRDC</i>
(<i>MeasurementReport</i>) | 1 | P |

8.2.3.11.2.3.3 Specific message contents

Table 8.2.3.11.2.3.3-1: RRCConnectionReconfiguration (step 1, Table 8.2.3.11.2.3.2-2)

Derivation Path: 36.508 [7], Table 4.6.1-8 with condition EN-DC_EmbedNR_RRCRecon

Table 8.2.3.11.2.3.3-2: RRCReconfiguration (Table 8.2.3.11.2.3.3-1)

Derivation Path: TS 38.508-1 [4], Table 4.6.1-13 with condition EN-DC_MEAS

Table 8.2.3.11.2.3.3-3: MeasConfig (Table 8.2.3.11.2.3.3-2)

| Derivation path: 38.508-1[4] Table 4.6.3-69 | | | |
|---|-------------------------|-------------------|-----------------|
| Information Element | Value/Remark | Comment | Condition |
| measConfig ::= SEQUENCE { | | | |
| measObjectToAddModList SEQUENCE (SIZE (1..maxNrofObjectId)) OF MeasObjectToAddMod { | 2 entries | | |
| MeasObjectToAddMod[1] SEQUENCE { | | entry 1 | |
| measObjectId | 1 | MeasObjectIdNR-f1 | |
| measObject CHOICE { | | | |
| measObjectNR | MeasObjectNR-GENERIC(0) | NR Cell 1 | |
| } | | | |
| } | | | |
| MeasObjectToAddMod[2] SEQUENCE { | | entry 2 | |
| measObjectId | 2 | MeasObjectIdNR-f2 | |
| measObject CHOICE { | | | |
| measObjectNR | MeasObjectNR-GENERIC(0) | NR Cell 3 | |
| } | | | |
| } | | | |
| reportConfigToAddModList SEQUENCE (SIZE (1..maxReportConfigId)) OF ReportConfigToAddMod { | 1 entry | | |
| ReportConfigToAddMod[1] SEQUENCE { | | entry 1 | |
| reportConfigId | 1 | ReportConfigId | |
| reportConfig | ReportConfig-Periodical | | |
| } | | | |
| measIdToAddModList SEQUENCE (SIZE (1..maxNrofMeasId)) OF MeasIdToAddMod { | 1 entry | | |
| MeasIdToAddMod[1] SEQUENCE { | | entry 1 | |
| measId | 1 | | |
| measObjectId | 2 | MeasObjectIdNR-f2 | |
| reportConfigId | 1 | ReportConfigId | |
| } | | | |
| quantityConfig | QuantityConfig | | |
| measGapConfig SEQUENCE { | MeasGapConfig | | |
| gapFR2 SteupRelease { | | | |
| gapOffset | -9 | | |
| mgl | ms5dot5 | 5.5ms | Gap pattern #13 |
| mgrp | ms40 | 40ms | |
| mgta | ms0dot25 | 0.25ms | |
| } | | | |
| } | | | |
| } | | | |

Table 8.2.3.11.2.3.3-4: MeasObjectNR-GENERIC(0) (Table 8.2.3.11.2.3.3-3)

| Derivation Path: 38.508-1 [4], Table 4.6.3-76 | | | |
|---|---------------------------------|---------|-----------|
| Information Element | Value/remark | Comment | Condition |
| MeasObjectNR ::= SEQUENCE { | | | |
| ssbFrequency | Downlink ARFCN of NR cell 1 SSB | | |
| } | | | |

Table 8.2.3.11.2.3.3-5: MeasObjectNR-GENERIC(0) (Table 8.2.3.11.2.3.3-3)

| Derivation Path: 38.508-1 [4], Table 4.6.3-76 | | | |
|---|---------------------------------|---------|-----------|
| Information Element | Value/remark | Comment | Condition |
| MeasObjectNR ::= SEQUENCE { | | | |
| ssbFrequency | Downlink ARFCN of NR cell 3 SSB | | |
| } | | | |

Table 8.2.3.11.2.3.3-6: ReportConfig-Periodical (Table 8.2.3.11.2.3.3-3)

| Derivation Path: 38.508-1 [4], Table 4.6.3-142 with condition Periodical | | | |
|--|--------------|---------|-----------|
| Information Element | Value/remark | Comment | Condition |
| ReportConfigNR ::= SEQUENCE { | | | |
| reportType CHOICE { | | | |
| Periodical SEQUENCE { | | | |
| reportQuantityCell SEQUENCE { | | | |
| rsrp | true | | |
| rsrq | true | | |
| sinr | false | | |
| } | | | |
| maxReportCells | 1 | | |
| } | | | |
| } | | | |
| } | | | |

Table 8.2.3.11.2.3.3-7: QuantityConfig (Table 8.2.3.11.1.3.3-3)

| Derivation Path: 38.508-1 [4], Table 4.6.3-127 | | | |
|--|--------------|---------|-----------|
| Information Element | Value/remark | Comment | Condition |
| QuantityConfig ::= SEQUENCE { | | | |
| quantityConfigNR-List SEQUENCE (SIZE (1..maxNrofQuantityConfig)) OF QuantityConfigNR { | 1 entry | | |
| QuantityConfigNR[1] SEQUENCE { | | entry 1 | |
| quantityConfigCell SEQUENCE { | | | |
| ssb-FilterConfig SEQUENCE { | | | |
| filterCoefficientRSRP | fc4 | | |
| filterCoefficientRSRQ | fc4 | | |
| filterCoefficientRS-SINR | fc4 | | |
| } | | | |
| } | | | |
| } | | | |
| } | | | |
| } | | | |

Table 8.2.3.11.2.3.3-8: ULInformationTransferMRDC (step1, Table 8.2.3.11.2.3.2-3)

| Derivation Path: 36.508 [7], Table 4.6.1-27 | | | |
|---|--|---------|-----------|
| Information Element | Value/remark | Comment | Condition |
| ULInformationTransferMRDC ::= SEQUENCE { | | | |
| ul-DCCH-MessageNR-r15 | OCTET STRING including the MeasurementReport message according to Table 8.2.3.11.2.3.3-9 | | |
| } | | | |

Table 8.2.3.11.2.3.3-9: MeasurementReport (Table 8.2.3.11.2.3.3-8)

| Derivation Path: TS 38.508-1 [4], clause 4.6.1-5A | | | |
|---|----------------------------------|---------|-----------|
| Information Element | Value/remark | Comment | Condition |
| MeasurementReport ::= SEQUENCE { | | | |
| criticalExtensions CHOICE { | | | |
| c1 CHOICE { | | | |
| measurementReport SEQUENCE { | | | |
| measResults SEQUENCE { | | | |
| measId | 1 | | |
| measResultServingMOList SEQUENCE { | 1 entry | | |
| servCellId | ServCellIndex of NR Cell 1 | | |
| measResultServingCell SEQUENCE { | | | |
| physCellId | Physical CellID of the NR Cell 1 | | |
| measResult SEQUENCE { | | | |
| cellResults SEQUENCE { | | | |
| resultsSSB-Cell SEQUENCE { | | | |
| rsrp | (0..127) | | |
| rsrq | (0..127) | | |
| } | | | |
| } | | | |
| } | | | |
| } | | | |
| measResultNeighCells CHOICE { | | | |
| measResultListNR SEQUENCE { | 1 entry | | |
| physCellId | Physical CellID of the NR Cell 3 | | |
| measResult SEQUENCE { | | | |
| cellResults SEQUENCE { | | | |
| resultsSSB-Cell SEQUENCE { | | | |
| rsrp | (0..127) | | |
| rsrq | (0..127) | | |
| } | | | |
| resultsCSI-RS-Cell | Not present | | |
| } | | | |
| rsIndexResults | Not present | | |
| } | | | |
| cgi-Info | Not present | | |
| } | | | |
| } | | | |
| } | | | |

Table 8.2.3.11.2.3.3-10: RRCConnectionReconfiguration (step 5, Table 8.2.3.11.2.3.2-2)

| |
|--|
| Derivation Path: 36.508 [7], Table 4.6.1-8 with condition EN-DC_EmbedNR_RRCRecon |
|--|

Table 8.2.3.11.2.3.3-11: RRCReconfiguration (Table 8.2.3.11.2.3.3-10)

| |
|--|
| Derivation Path: TS 38.508-1 [4], Table 4.6.1-13 with condition EN-DC_MEAS |
|--|

Table 8.2.3.11.2.3.3-12: MeasConfig (Table 8.2.3.11.2.3.3-11)

| Derivation path: 38.508-1[4] Table 4.6.3-69 | | | |
|---|---------------|----------------------------|-----------------------------|
| Information Element | Value/Remark | Comment | Condition |
| measConfig ::= SEQUENCE { | | | |
| measObjectToAddModList | Not present | | |
| reportConfigToAddModList | Not present | | |
| measIdToAddModList | Not present | | |
| quantityConfig | Not present | | |
| measGapConfig SEQUENCE { | MeasGapConfig | | |
| gapFR2 CHOICE { | | | |
| Setup SEQUENCE{ | | | |
| gapOffset | 9 | | k=13-23 |
| mgl | ms5dot5 | Gap Pattern #12,
5.5ms | k=13
pc_gp12_n
r=True |
| mgl | ms5dot5 | Gap Pattern #14,
5.5ms | k=14 |
| mgl | ms5dot5 | Gap Pattern #15,
5.5ms | k=15
pc_gp15_n
r=True |
| mgl | ms3dot5 | Gap Pattern #16,
3.5ms | k=16
pc_gp16_n
r=True |
| mgl | ms3dot5 | Gap Pattern #17,
3.5ms | k=17
pc_gp17_n
r=True |
| mgl | ms3dot5 | Gap Pattern #18,
3.5ms | k=18
pc_gp18_n
r=True |
| mgl | ms3dot5 | Gap Pattern #19,
3.5ms | k=19
pc_gp19_n
r=True |
| mgl | ms1dot5 | Gap Pattern #20,
1.5ms | k=20
pc_gp20_n
r=True |
| mgl | ms1dot5 | Gap Pattern #21,
1.5ms | k=21
pc_gp21_n
r=True |
| mgl | ms1dot5 | Gap Pattern #22,
1.5ms | k=22
pc_gp22_n
r=True |
| mgl | ms1dot5 | Gap Pattern #23,
1.5ms | k=23
pc_gp23_n
r=True |
| mgrp | ms20 | Gap Pattern #12,
20ms | k=13
pc_gp12_n
r=True |
| mgrp | ms80 | Gap Pattern #14,
80ms | k=14 |
| mgrp | ms160 | Gap Pattern #15,
160ms, | k=15
pc_gp15_n
r=True |
| mgrp | ms20 | Gap Pattern #16,
20ms | k=16
pc_gp16_n
r=True |
| mgrp | ms40 | Gap Pattern #17,
40ms | k=17
pc_gp17_n
r=True |
| mgrp | ms80 | Gap Pattern #18,
80ms | k=18
pc_gp18_n
r=True |
| mgrp | ms160 | Gap Pattern #19,
160ms | k=19
pc_gp19_n
r=True |
| mgrp | ms20 | Gap Pattern #20,
20ms | k=20
pc_gp20_n |

| | | | |
|------|----------|---------------------------|-----------------------------|
| | | | r=True |
| mgrp | ms40 | Gap Pattern #21,
40ms | k=21
pc_gp21_n
r=True |
| mgrp | ms80 | Gap Pattern #22,
80ms | k=22
pc_gp22_n
r=True |
| mgrp | ms160 | Gap Pattern #23,
160ms | k=23
pc_gp23_n
r=True |
| mgta | ms0dot25 | 0.25ms | k=18-23 |
| mgta | ms0 | 0 ms | k=13-17 |
| } | | | |
| } | | | |
| } | | | |
| } | | | |

Table 8.2.3.11.2.3.3-13: RRCConnectionReconfiguration (step 8, Table 8.2.3.11.2.3.2-2)

Derivation Path: 36.508 [7], Table 4.6.1-8 with condition EN-DC_EmbedNR_RRCRecon

Table 8.2.3.11.2.3.3-14: RRCReconfiguration (Table 8.2.3.11.2.3.3-13)

Derivation Path: TS 38.508-1 [4], Table 4.6.1-13 with condition EN-DC_MEAS

Table 8.2.3.11.2.3.3-15: MeasConfig (Table 8.2.3.11.2.3.3-14)

| Derivation path: 38.508-1[4] Table 4.6.3-69 | | | |
|---|---------------|---------|-----------|
| Information Element | Value/Remark | Comment | Condition |
| measConfig ::= SEQUENCE { | | | |
| measObjectToAddModList | Not present | | |
| reportConfigToAddModList | Not present | | |
| MeasIdToRemoveList SEQUENCE (SIZE (1..maxNrofMeasId)) OF MeasId { | 1 entry | | |
| MeasId[1] | 1 | entry 1 | |
| } | | | |
| measIdToAddModList | Not present | | |
| quantityConfig | Not present | | |
| measGapConfig SEQUENCE { | MeasGapConfig | | |
| gapFR2 CHOICE { | | | |
| release | NULL | | |
| } | | | |
| } | | | |
| } | | | |

8.2.3.12 Measurement configuration control and reporting / Inter-RAT measurements / Event B2 / Measurement of NR cells

8.2.3.12.1 Measurement configuration control and reporting / Inter-RAT measurements / Event B2 / Measurement of NR cells / EN-DC

8.2.3.12.1.1 Test Purpose (TP)

(1)

```
with { UE in RRC_CONNECTED state with EN-DC, and, MCG(s) (E-UTRA PDCP) only having completed the
radio bearer establishment and performed the inter RAT measurement for NR cell and not detected
entering condition for the event B2 is met }
ensure that {
  when { UE detects entering condition for the event B2 is not met }
```



```

then { UE does not transmit any MeasurementReport }
}

```

(2)

```

with { UE in RRC_CONNECTED state with EN-DC, and, MCG(s) (E-UTRA PDCP) only having completed the
radio bearer establishment and performed the inter RAT measurement for NR cell and not detected
entering condition for the event B2 is met }
ensure that {
  when { UE detects entering condition for the event B2 is met }
  then { UE transmits a MeasurementReport }
}

```

(3)

```

with { UE in RRC_CONNECTED state with EN-DC, and, MCG(s) (E-UTRA PDCP) only having completed the
radio bearer establishment and performed the inter RAT measurement for NR cell and detected entering
condition for the event B2 is met }
ensure that {
  when { UE detects leaving condition for the event B2 is met }
  then { UE does not transmit any MeasurementReport }
}

```

8.2.3.12.1.2 Conformance requirements

References: The conformance requirements covered in the present TC are specified in: TS 36.331, clauses 5.5.1, 5.5.4.1, 5.5.4.8, 5.5.5 and 5.5.5.3. Unless otherwise stated these are Rel-15 requirements.

[TS 36.331, clause 5.5.1]

The UE reports measurement information in accordance with the measurement configuration and performs conditional reconfiguration evaluation in accordance with conditional reconfiguration as provided by E-UTRAN. E-UTRAN provides the measurement configuration or the conditional reconfiguration applicable for a UE in RRC_CONNECTED by means of dedicated signalling, i.e. using the *RRCCConnectionReconfiguration* or *RRCCConnectionResume* message.

The UE can be requested to perform the following types of measurements:

- Intra-frequency measurements: measurements at the downlink carrier frequency(ies) of the serving cell(s).
- Inter-frequency measurements: measurements at frequencies that differ from any of the downlink carrier frequency(ies) of the serving cell(s).
- Inter-RAT measurements of NR frequencies.

...

The measurement configuration includes the following parameters:

1. **Measurement objects:** The objects on which the UE shall perform the measurements.

- For intra-frequency and inter-frequency measurements a measurement object is a single E-UTRA carrier frequency. Associated with this carrier frequency, E-UTRAN can configure a list of cell specific offsets, a list of 'blacklisted' cells and a list of 'whitelisted' cells. Blacklisted cells are not considered in event evaluation or measurement reporting.
- For inter-RAT NR measurements a measurement object is a single NR carrier frequency. Associated with this carrier frequency, E-UTRAN can configure a list of 'blacklisted' cells. Blacklisted cells are not considered in event evaluation or measurement reporting.

...

NOTE 1: Some measurements using the above mentioned measurement objects, only concern a single cell, e.g. measurements used to report neighbouring cell system information, PCell UE Rx-Tx time difference, or a pair of cells, e.g. SSTD measurements between the PCell and the PSCell.

2. **Reporting configurations:** A list of measurement reporting configurations where each measurement reporting configuration consists of the following:

- Reporting criterion: The criterion that triggers the UE to send a measurement report. This can either be periodical or a single event description.
- Reporting format: The quantities that the UE includes in the measurement report and associated information (e.g. number of cells to report).

In case of conditional handover triggering configuration, each configuration consists of the following:

- Execution criteria: The criteria that triggers the UE to perform conditional handover.
3. **Measurement identities:** A list of measurement identities where each measurement identity links one measurement object with one measurement reporting configuration. By configuring multiple measurement identities it is possible to link more than one measurement object to the same reporting configuration, as well as to link more than one reporting configuration to the same measurement object. The measurement identity is used as a reference number in the measurement report. For conditional reconfiguration triggering, one measurement identity links to exactly one conditional reconfiguration trigger configuration. And up to two measurement identities can be linked to one conditional reconfiguration execution condition.
 4. **Quantity configurations:** One quantity configuration is configured per RAT type. The quantity configuration defines the measurement quantities and associated filtering used for all event evaluation and related reporting of that measurement type. One filter can be configured per measurement quantity, except for NR where the network may configure up to 2 sets of quantity configurations each comprising per measurement quantity separate filters for cell and RS index measurement results. The quantity configuration set that applies for a given measurement is indicated within the NR measurement object.

[TS 36.331, clause 5.5.4.1]

If security has been activated successfully, the UE shall:

- 1> for each *measId* included in the *measIdList* within *VarMeasConfig*:
 - ...
 - 2> else:
 - ...
 - 3> else if the corresponding *measObject* concerns NR:
 - 4> if the *reportSFTD-Meas* is set to *pSCell* in the corresponding *reportConfigInterRAT*:
 - 5> consider the PSCell to be applicable;
 - 4> else if the *reportSFTD-Meas* is set to *neighborCells* in the corresponding *reportConfigInterRAT*:
 - 5> if *cellsForWhichToReportSFTD* is configured in the corresponding *measObjectNR*:
 - 6> consider any neighbouring NR cell on the associated frequency that is included in *cellsForWhichToReportSFTD* to be applicable;
 - 5> else:
 - 6> consider up to 3 strongest neighbouring NR cells detected on the associated frequency to be applicable when the concerned cells are not included in the *blackCellsToAddModList* defined within the *VarMeasConfig* for this *measId*;
 - 4> else:
 - 5> if the *eventB1* or *eventB2* is configured in the corresponding *reportConfig*:
 - 6> consider a serving cell, if any, on the associated NR frequency as neighbouring cell;
 - 5> consider any neighbouring cell detected on the associated frequency to be applicable when the concerned cell is not included in the *blackCellsToAddModList* defined within the *VarMeasConfig* for this *measId*;

[TS 36.331, clause 5.5.4.8]

The UE shall:

- 1> for UTRA and CDMA2000, only trigger the event for cells included in the corresponding measurement object;
- 1> consider the entering condition for this event to be satisfied when both condition B2-1 and condition B2-2, as specified below, are fulfilled;
- 1> consider the leaving condition for this event to be satisfied when condition B2-3 or condition B2-4, i.e. at least one of the two, as specified below, is fulfilled;

Inequality B2-1 (Entering condition 1)

$$M_p + H_{ys} < Thresh1$$

Inequality B2-2 (Entering condition 2)

$$M_n + Ofn - H_{ys} > Thresh2$$

Inequality B2-3 (Leaving condition 1)

$$M_p - H_{ys} > Thresh1$$

Inequality B2-4 (Leaving condition 2)

$$M_n + Ofn + H_{ys} < Thresh2$$

The variables in the formula are defined as follows:

M_p is the measurement result of the PCell, not taking into account any offsets.

M_n is the measurement result of the inter-RAT neighbour cell, not taking into account any offsets. For CDMA2000 measurement result, *pilotStrength* is divided by -2.

Ofn is the frequency specific offset of the frequency of the inter-RAT neighbour cell (i.e. *offsetFreq* as defined within the *measObject* corresponding to the frequency of the inter-RAT neighbour cell).

H_{ys} is the hysteresis parameter for this event (i.e. *hysteresis* as defined within *reportConfigInterRAT* for this event).

Thresh1 is the threshold parameter for this event (i.e. *b2-Threshold1* as defined within *reportConfigInterRAT* for this event).

Thresh2 is the threshold parameter for this event (i.e. *b2-Threshold2* as defined within *reportConfigInterRAT* for this event). For CDMA2000, *b2-Threshold2* is divided by -2.

M_p is expressed in dBm in case of RSRP, or in dB in case of RSRQ.

M_n is expressed in dBm or dB, depending on the measurement quantity of the inter-RAT neighbour cell.

Ofn, ***H_{ys}*** are expressed in dB.

Thresh1 is expressed in the same unit as ***M_p***.

Thresh2 is expressed in the same unit as ***M_n***.

[TS 36.331, clause 5.5.5]

The purpose of this procedure is to transfer measurement results from the UE to E-UTRAN. The UE shall initiate this procedure only after successful security activation.

For the *measId* for which the measurement reporting procedure was triggered, the UE shall set the *measResults* within the *MeasurementReport* message as follows:

- 1> set the *measId* to the measurement identity that triggered the measurement reporting;
- 1> set the *measResultPCell* to include the quantities of the PCell;
- 1> set the *measResultServFreqList* to include for each E-UTRA SCell that is configured, if any, within *measResultSCell* the quantities of the concerned SCell, if available according to performance requirements in TS

36.133 [16], except if *purpose* for the *reportConfig* associated with the *measId* that triggered the measurement reporting is set to *reportLocation*;

- 1> if the *reportConfig* associated with the *measId* that triggered the measurement reporting includes *reportAddNeighMeas*:
 - 2> for each E-UTRA serving frequency for which *measObjectId* is referenced in the *measIdList*, other than the frequency corresponding with the *measId* that triggered the measurement reporting:
 - 3> set the *measResultServFreqList* to include within *measResultBestNeighCell* the *physCellId* and the quantities of the best non-serving cell, based on RSRP, on the concerned serving frequency;
 - 1> if the *triggerType* is set to *event*; and if the corresponding *measObject* concerns NR; and if *eventId* is set to *eventB1-NR* or *eventB2-NR*; or
 - ...
 - 2> if *purpose* for the *reportConfig* or *reportConfigInterRAT* associated with the *measId* that triggered the measurement reporting is set to a value other than *reportLocation*:
 - 3> set the *measResultServFreqListNR* to include for each NR serving frequency that the UE is configured to measure according to TS 38.331 [82], if any, the following:
 - 4> set *measResultSCell* to include the available results of the NR serving cell, as specified in 5.5.5.2;
 - 4> if the *reportConfig* associated with the *measId* that triggered the measurement reporting includes *reportAddNeighMeas* and if *eventId* is set to *eventA3* or *eventA4* or *eventA5*:
 - 5> set *measResultBestNeighCell* to include the available results, as specified in 5.5.5.2, of the non-serving cell with the highest sorting quantity determined as specified in 5.5.5.3;
 - 3> for each (serving or neighbouring) cell for which the UE reports results according to the previous, additionally include available beam results according to the following:
 - 4> if *maxReportRS-Index* is configured, set *measResultCellRS-Index* to include available results, as specified in 5.5.5.2, of up to *maxReportRS-Index* beams, ordered based on the quantity determined as specified in 5.5.5.3;
 - 1> if there is at least one applicable neighbouring cell to report:
 - 2> set the *measResultNeighCells* to include the best neighbouring cells up to *maxReportCells* in accordance with the following:
 - 3> if the *triggerType* is set to *event*:
 - 4> include the cells included in the *cellsTriggeredList* as defined within the *VarMeasReportList* for this *measId*;
 - 3> else:
 - 4> include the applicable cells for which the new measurement results became available since the last periodical reporting or since the measurement was initiated or reset;
- NOTE 1: The reliability of the report (i.e. the certainty it contains the strongest cells on the concerned frequency) depends on the measurement configuration i.e. the *reportInterval*. The related performance requirements are specified in TS 36.133 [16].
- 3> for each cell that is included in the *measResultNeighCells*, include the *physCellId*;
 - 3> if the *triggerType* is set to *event*; or the *purpose* is set to *reportStrongestCells* or to *reportStrongestCellsForSON*:
 - 4> for each included cell, include the layer 3 filtered measured results in accordance with the *reportConfig* for this *measId*, ordered as follows:
 - 5> if the *measObject* associated with this *measId* concerns E-UTRA:

- 6> set the *measResult* to include the quantity(ies) indicated in the *reportQuantity* within the concerned *reportConfig*;
- 6> sort the included cells in order of decreasing *triggerQuantity*, i.e. the best cell is included first;
- 5> if the *measObject* associated with this *measId* concerns NR:
 - 6> set the *measResultCell* to include the quantity(ies) indicated in the *reportQuantityCellNR* within the concerned *reportConfig*;
 - 6> if *maxReportRS-Index* and *reportQuantityRS-IndexNR* are configured, set *measResultRS-IndexList* to include the result of the best beam if *threshRS-Index* is included in the *VarMeasConfig* for the corresponding *measObject*, and the remaining beams whose quantity is above *threshRS-Index*, up to *maxReportRS-Index* beams in total:
 - 7> order beams based on the sorting quantity determined as specified in 5.5.5.3;
 - 7> for each included beam:
 - 8> include *ssbIndex*;
 - 8> if *reportRS-IndexResultsNR* is set to TRUE, for each quantity indicated, include the corresponding measurement result in *measResultSSB-Index* for each *ssb-Index*;

[TS 36.331, clause 5.5.5.3]

When configured to report the best cells or beams, the UE shall determine the quantity that is used to order and select as follows:

- 1> for cells on the frequency associated with the *measId* that triggered the measurement reporting, if the *reportTrigger* is set to *event*, consider the quantity used in *bN-ThresholdYNR* to be the sorting quantity;
- 1> for other cases, determine the sorting quantity as follows:
 - 2> consider the following quantities as candidate sorting quantities:
 - 3> for cells on the frequency associated with the *measId* that triggered the measurement reporting (for a *triggerType* set to *periodical*):
 - 4> the quantities defined by *reportQuantityCellNR*, when used for sorting cells;
 - 4> the quantities defined by *reportQuantityRS-IndexNR*, when used for sorting beams;
 - 3> for cells, serving or non-serving (i.e. within *reportAddNeighMeas*), on NR serving frequencies other than the one associated with the *measId* triggering reporting:
 - 4> the available quantities of available NR measurement results as specified in 5.5.5.2;
 - 2> if there is a single candidate sorting quantity;
 - 3> consider the concerned quantity to be the sorting quantity;
 - 2> else:
 - 3> if RSRP is one of the candidate sorting quantities;
 - 4> consider RSRP to be the sorting quantity;
 - 3> else:
 - 4> consider RSRQ to be the sorting quantity;

8.2.3.12.1.3 Test description

8.2.3.12.1.3.1 Pre-test conditions

System Simulator:

- E-UTRA Cell 1 and NR Cell 1.

UE:

- None.

Preamble:

- The UE is in state RRC_CONNECTED using generic procedure parameter Connectivity (*EN-DC*) with MCG(s) only established according to [4].

8.2.3.12.1.3.2 Test procedure sequence

Table 8.2.3.12.1.3.2-1 and Table 8.2.3.12.1.3.2-1A illustrates the downlink power levels and other changing parameters to be applied for the cells at various time instants of the test execution. Row marked "T0" denotes the initial conditions after preamble, while columns marked "T1", "T2", "T3", "T4" and "T5" are to be applied subsequently. The exact instants on which these values shall be applied are described in the texts in this clause.

Table 8.2.3.12.1.3.2-1: Time instances of cell power level and parameter changes for FR1

| | Parameter | Unit | E-UTRA Cell 1 | NR Cell 1 | Remark |
|----|-----------------------|------------|---------------|-----------|--|
| T0 | Cell-specific RS EPRE | dBm/15 kHz | -84 | - | The power level values are such that entering conditions for event B2 are not satisfied, i.e. condition B2-1($Mp + Hys < Thresh1$) is fulfilled but condition B2-2($Mn + Ofn - Hys > Thresh2$) is not fulfilled. |
| | SS/PBCH SSS EPRE | dBm/SC S | - | -91 | |
| T1 | Cell-specific RS EPRE | dBm/15 kHz | -60 | - | The power level values are such that entering conditions for event B2 are not satisfied, i.e. condition B2-1($Mp + Hys < Thresh1$) is not fulfilled but condition B2-2($Mn + Ofn - Hys > Thresh2$) is fulfilled. |
| | SS/PBCH SSS EPRE | dBm/SC S | - | -79 | |
| T2 | Cell-specific RS EPRE | dBm/15 kHz | -84 | - | The power level values are such that entering conditions for event B2 are satisfied, i.e. condition B2-1($Mp + Hys < Thresh1$) and B2-2($Mn + Ofn - Hys > Thresh2$) are fulfilled. |
| | SS/PBCH SSS EPRE | dBm/SC S | - | -79 | |
| T3 | Cell-specific RS EPRE | dBm/15 kHz | -60 | - | The power level values are such that leaving conditions for event B2 are satisfied, i.e. condition B2-3($Mp - Hys > Thresh1$) is fulfilled but condition B2-4($Mn + Ofn + Hys < Thresh2$) is not fulfilled. |
| | SS/PBCH SSS EPRE | dBm/SC S | - | -79 | |
| T4 | Cell-specific RS EPRE | dBm/15 kHz | -84 | - | The power level values are such that entering conditions for event B2 are satisfied, i.e. condition B2-1($Mp + Hys < Thresh1$) and B2-2($Mn + Ofn - Hys > Thresh2$) are fulfilled. |
| | SS/PBCH SSS EPRE | dBm/SC S | - | -79 | |
| T5 | Cell-specific RS EPRE | dBm/15 kHz | -84 | - | The power level values are such that leaving conditions for event B2 are satisfied, i.e. condition B2-3($Mp - Hys > Thresh1$) is not fulfilled but condition B2-4($Mn + Ofn + Hys < Thresh2$) is fulfilled. |
| | SS/PBCH SSS EPRE | dBm/SS C | - | -91 | |

Table 8.2.3.12.1.3.2-1A: Time instances of cell power level and parameter changes for FR2

| | Parameter | Unit | E-UTRA Cell 1 | NR Cell 1 | Remark |
|----|-----------------------|------------|---------------|-----------|--|
| T0 | Cell-specific RS EPRE | dBm/15 kHz | FFS | - | The power level values are such that entering conditions for event B2 are not satisfied, i.e. condition B2-1($Mp + Hys < Thresh1$) is fulfilled but condition B2-2($Mn + Ofn - Hys > Thresh2$) is not fulfilled. |
| | SS/PBCH SSS EPRE | dBm/SC S | - | FFS | |
| T1 | Cell-specific RS EPRE | dBm/15 kHz | FFS | - | The power level values are such that entering conditions for event B2 are not satisfied, i.e. condition B2-1($Mp + Hys < Thresh1$) is not fulfilled but condition B2-2($Mn + Ofn - Hys > Thresh2$) is fulfilled. |
| | SS/PBCH SSS EPRE | dBm/SC S | - | FFS | |
| T2 | Cell-specific RS EPRE | dBm/15 kHz | FFS | - | The power level values are such that entering conditions for event B2 are satisfied, i.e. condition B2-1($Mp + Hys < Thresh1$) and B2-2($Mn + Ofn - Hys > Thresh2$) are fulfilled. |
| | SS/PBCH SSS EPRE | dBm/SC S | - | FFS | |
| T3 | Cell-specific RS EPRE | dBm/15 kHz | FFS | - | The power level values are such that leaving conditions for event B2 are satisfied, i.e. condition B2-3($Mp - Hys > Thresh1$) is fulfilled but condition B2-4($Mn + Ofn + Hys < Thresh2$) is not fulfilled. |
| | SS/PBCH SSS EPRE | dBm/SC S | - | FFS | |
| T4 | Cell-specific RS EPRE | dBm/15 kHz | FFS | - | The power level values are such that entering conditions for event B2 are satisfied, i.e. condition B2-1($Mp + Hys < Thresh1$) and B2-2($Mn + Ofn - Hys > Thresh2$) are fulfilled. |
| | SS/PBCH SSS EPRE | dBm/SC S | - | FFS | |
| T5 | Cell-specific RS EPRE | dBm/15 kHz | FFS | - | The power level values are such that leaving conditions for event B2 are satisfied, i.e. condition B2-3($Mp - Hys > Thresh1$) is not fulfilled but condition B2-4($Mn + Ofn + Hys < Thresh2$) is fulfilled. |
| | SS/PBCH SSS EPRE | dBm/SC S | - | FFS | |

Table 8.2.3.12.1.3.2-2: Main behaviour

| St | Procedure | Message Sequence | | TP | Verdict |
|----|--|------------------|---|----|---------|
| | | U – S | Message | | |
| 1 | The SS transmits an <i>RRCConnectionReconfiguration</i> including <i>measConfig</i> to setup inter RAT measurements and reporting for NR Cell 1. | <- | <i>RRCConnectionReconfiguration</i> | - | - |
| 2 | The UE transmits an <i>RRCConnectionReconfigurationComplete</i> message to confirm the setup of inter RAT measurements for NR Cell 1. | --> | <i>RRCConnectionReconfigurationComplete</i> | - | - |
| 3 | Check: Does the UE transmit a <i>MeasurementReport</i> message on E-UTRA Cell 1 to report the event B2 during the next 10s? | --> | <i>MeasurementReport</i> | 1 | F |
| 4 | The SS changes NR Cell 1 and E-UTRA Cell 1 parameters according to the row "T1". | - | - | - | - |
| 5 | Check: Does the UE transmit a <i>MeasurementReport</i> message on E-UTRA Cell 1 to report the event B2 during the next 10s? | --> | <i>MeasurementReport</i> | 1 | F |
| 6 | The SS changes NR Cell 1 and E-UTRA Cell 1 parameters according to the row "T2". | - | - | - | - |
| 7 | Check: Does the UE transmit a <i>MeasurementReport</i> message to report the event B2 for NR Cell 1? | --> | <i>MeasurementReport</i> | 2 | P |
| 8 | The SS changes NR Cell 1 and E-UTRA Cell 1 parameters according to the row "T3". | - | - | - | - |
| 9 | Wait and ignore <i>MeasurementReport</i> messages for 57s if NR Cell 1 is on FR2 frequency else wait for 15 s to allow change of power levels and UE measurements for NR Cell 1 and E-UTRA Cell 1. | - | - | - | - |
| 10 | Check: Does the UE transmit a <i>MeasurementReport</i> message on E-UTRA Cell 1 to report the event B2 during the next 10s? | --> | <i>MeasurementReport</i> | 3 | F |
| 11 | The SS changes NR Cell 1 and E-UTRA Cell 1 parameters according to the row "T4" in table 8.2.3.12.1.3.2-1. | - | - | - | - |
| 12 | Void | | | | |
| 13 | Check: Does the UE transmit a <i>MeasurementReport</i> message to report the event B2 for NR Cell 1? | --> | <i>MeasurementReport</i> | 2 | P |
| 14 | The SS changes NR Cell 1 and E-UTRA Cell 1 parameters according to the row "T5" in table 8.2.3.12.1.3.2-1. | - | - | - | - |
| 15 | Wait and ignore <i>MeasurementReport</i> messages for 57s if NR Cell 1 is on FR2 frequency else wait for 15 s to allow change of power levels and UE measurements for NR Cell 1 and E-UTRA Cell 1. | - | - | - | - |
| 16 | Check: Does the UE transmit a <i>MeasurementReport</i> message on E-UTRA Cell 1 to report the event B2 during the next 10s? | --> | <i>MeasurementReport</i> | 3 | F |

8.2.3.12.1.3.3 Specific message contents

Table 8.2.3.12.1.3.3-1: *RRCConnectionReconfiguration* (step 1, Table 8.2.3.12.1.3.2-2)

| |
|--|
| Derivation Path: 36.508 [7], Table 4.6.1-8, condition MEAS |
|--|

Table 8.2.3.12.1.3.3-2: *MeasConfig* (Table 8.2.3.12.1.3.3-1)

| Derivation Path: 36.508 [7], Table 4.6.6-1 | | | |
|---|--|---------|-----------|
| Information Element | Value/remark | Comment | Condition |
| MeasConfig ::= SEQUENCE { | | | |
| measObjectToAddModList SEQUENCE (SIZE (1..maxObjectId)) OF MeasObjectToAddMod { | 2 entries | | |
| MeasObjectToAddMod[1] SEQUENCE { | | entry 1 | |
| measObjectId | 1 | | |
| measObject | MeasObjectEUTRA-GENERIC(f1) | | |
| measObject | MeasObjectEUTRA-GENERIC(maxEARFCN) | | Band > 64 |
| } | | | |
| MeasObjectToAddMod[2] SEQUENCE { | | entry 2 | |
| measObjectId | IdMeasObject-NRf1 | | |
| measObject | MeasObjectNR-GENERIC (NRf1) | | |
| } | | | |
| } | | | |
| reportConfigToAddModList SEQUENCE (SIZE (1..maxReportConfigId)) OF ReportConfigToAddMod { | 1 entry | | |
| ReportConfigToAddMod[1] SEQUENCE { | | entry 1 | |
| reportConfigId | IdReportConfig-B2-NR | | |
| reportConfig | ReportConfigInterRAT-B2-NR-r15(-72, -85) | | FR1 |
| | ReportConfigInterRAT-B2-NR-r15(FFS, FFS) | | FR2 |
| } | | | |
| } | | | |
| measIdToAddModList SEQUENCE (SIZE (1..maxMeasId)) OF MeasIdToAddMod { | 1 entry | | |
| MeasIdToAddMod[1] SEQUENCE { | | entry 1 | |
| measId | 1 | | |
| measObjectId | IdMeasObject-NRf1 | | |
| reportConfigId | IdReportConfig-B2-NR | | |
| } | | | |
| } | | | |
| quantityConfig | QuantityConfig-DEFAULT | | |
| measGapConfig | MeasGapConfig | | |
| measObjectToAddModList-v9e0 SEQUENCE (SIZE (1..maxObjectId)) OF MeasObjectToAddMod-v9e0 { | 1 entry | | Band > 64 |
| MeasObjectToAddMod-v9e0[1] SEQUENCE { | | entry 1 | |
| measObjectEUTRA-v9e0 SEQUENCE { | | | |
| carrierFreq-v9e0 | Same downlink EARFCN as used for f1 | | |
| } | | | |
| } | | | |
| } | | | |
| } | | | |
| } | | | |
| } | | | |
| } | | | |

Table 8.2.3.12.1.3.3-3: QuantityConfig-DEFAULT (Table 8.2.3.12.1.3.3-2)

| Derivation Path: 36.508 [7], Table 4.6.6-3A | | | |
|---|--------------|---------|-----------|
| Information Element | Value/remark | Comment | Condition |
| QuantityConfig-DEFAULT ::= SEQUENCE { | | | |
| quantityConfigNRList-r15 SEQUENCE ((SIZE (1..maxQuantSetsNR-r15)) OF QuantityConfigNR-r15 { | 1 entry | | |
| QuantityConfigNR-r15[1] SEQUENCE { | | entry 1 | |
| measQuantityCellNR-r15 SEQUENCE { | | | |
| filterCoeff-RSRP-r15 | fc0 | | |
| filterCoeff-RSRQ-r15 | fc0 | | |
| filterCoefficient-SINR-r13 | fc0 | | |
| } | | | |
| } | | | |
| } | | | |
| } | | | |

Table 8.2.3.12.1.3.3-4: MeasObjectNR-GENERIC (NRf1) (Table 8.2.3.12.1.3.3-2)

| Derivation Path: 36.508 [7], Table 4.6.6-2B | | | |
|---|---|---------|-----------|
| Information Element | Value/remark | Comment | Condition |
| MeasObjectNR-GENERIC(Freq) ::= SEQUENCE { | | | |
| carrierFreq-r15 | Downlink carrier frequency of NR cell 1 | | |
| } | | | |

Table 8.2.3.12.1.3.3-5: ReportConfigInterRAT-B2-NR-r15 (Table 8.2.3.12.1.3.3-2)

| Derivation Path: 36.508 [7], Table 4.6.6-8A | | | |
|---|--------------|---------|-----------------|
| Information Element | Value/remark | Comment | Condition |
| ReportConfig-B2-NR ::= SEQUENCE { | | | |
| reportQuantityCellNR-r15 SEQUENCE { | | | |
| ss-rsrp | true | | |
| ss-rsrq | true | | |
| ss-sinr | true | | pc_ss_SINR_Meas |
| | false | | |
| } | | | |
| } | | | |

Table 8.2.3.12.1.3.3-6: MeasurementReport (step 3, 5, 7, 10, 13, 16, Table 8.2.3.12.1.3.2-2)

| Derivation Path: 36.508 [7], Table 4.6.1-5 | | | |
|--|-----------------------------------|---------|-----------------|
| Information Element | Value/remark | Comment | Condition |
| MeasurementReport ::= SEQUENCE { | | | |
| criticalExtensions CHOICE { | | | |
| c1 CHOICE{ | | | |
| measurementReport-r8 SEQUENCE { | | | |
| measResults SEQUENCE { | | | |
| measId | 1 | | |
| measResultPCell SEQUENCE { | | | |
| rsrpResult | (0..97) | | |
| rsrqResult | (0..34) | | |
| } | | | |
| measResultNeighCells CHOICE { | | | |
| measResultNeighCellListNR-r15 SEQUENCE (SIZE (1..maxCellReport)) OF MeasResultCellNR-r15 { | 1 entry | | |
| MeasResultCellNR-r15[1] SEQUENCE { | | entry 1 | |
| pci-r15 | PhysicalCellIdentity of NR Cell 1 | | |
| measResultCell-r15 SEQUENCE { | | | |
| rsrpResult-r15 | (0..127) | | |
| rsrqResult-r15 | (0..127) | | |
| rs-sinr-Result-r15 | (0..127) | | pc_ss_SINR_Meas |
| } | Not present | | |
| } | | | |
| cgi-Info-r15 | Not present | | |
| } | | | |
| } | | | |
| } | | | |
| } | | | |
| } | | | |
| } | | | |

Table 8.2.3.12.1.3.3-7: MeasGapConfig(Table 8.2.3.12.1.3.3-2)

| Derivation Path: 36.331, clause 6.3.5 | | | |
|---------------------------------------|--------------|--------------|-----------|
| Information Element | Value/remark | Comment | Condition |
| MeasGapConfig ::= CHOICE { | | | |
| setup SEQUENCE { | | | |
| gapOffset CHOICE { | | | |
| gp1 | 19 | TGRP = 80 ms | |
| } | | | |
| } | | | |
| } | | | |

8.2.3.13 PCell Handover with SCG change / Reconfiguration with sync / SCG DRB**8.2.3.13.1 PCell Handover with SCG change / Reconfiguration with sync / SCG DRB / EN-DC****8.2.3.13.1.1 Test Purpose (TP)**

(1)

with { UE in RRC_CONNECTED state in EN-DC mode, and, MCG(s) (E-UTRA PDCP) and SCG DRB established }
ensure that {

```

when { UE receives an RRCConnectionReconfiguration message containing mobilityControlInfo to
handover to target E-UTRAN PCell involving SCG change with reconfigurationWithSync on the same
PSCell }
  then { UE sends an RRCConnectionReconfigurationComplete message }
  }

```

8.2.3.13.1.2 Conformance requirements

References: The conformance requirements covered in the present TC are specified in: TS 36.331, clause 5.3.5.4, TS 38.331, clauses 5.3.5.3, 5.3.5.5.1 and 5.3.5.5.2. Unless otherwise stated these are Rel-15 requirements.

[TS 36.331, clause 5.3.5.4]

If the *RRCConnectionReconfiguration* message includes the *mobilityControlInfo* and the UE is able to comply with the configuration included in this message, the UE shall:

- 1> stop timer T310, if running;
- 1> stop timer T312, if running;
- 1> start timer T304 with the timer value set to *t304*, as included in the *mobilityControlInfo*;
- 1> stop timer T370, if running;
- 1> if the *carrierFreq* is included:
 - 2> consider the target PCell to be one on the frequency indicated by the *carrierFreq* with a physical cell identity indicated by the *targetPhysCellId*;
- 1> else:
 - 2> consider the target PCell to be one on the frequency of the source PCell with a physical cell identity indicated by the *targetPhysCellId*;
- 1> stop timer T309, if running, for all access categories;
- 1> start synchronising to the DL of the target PCell;

NOTE 1: The UE should perform the handover as soon as possible following the reception of the RRC message triggering the handover, which could be before confirming successful reception (HARQ and ARQ) of this message.

...

- 1> if the received *RRCConnectionReconfiguration* includes the *nr-SecondaryCellGroupConfig*:
 - 2> perform NR RRC Reconfiguration as specified in TS 38.331 [82], clause 5.3.5.3.

...

- 1> set the content of *RRCConnectionReconfigurationComplete* message as follows:

...

- 2> if the received *RRCConnectionReconfiguration* message included *nr-SecondaryCellGroupConfig*:
 - 3> perform NR RRC Reconfiguration as specified in TS 38.331 [82], clause 5.3.5.3.

[TS 38.331, clause 5.3.5.3]

The UE shall perform the following actions upon reception of the *RRCReconfiguration*:

...

- 1> if the *RRCReconfiguration* includes the *secondaryCellGroup*:
 - 2> perform the cell group configuration for the SCG according to 5.3.5.5;

...

1> set the content of *RRCReconfigurationComplete* message as follows:

- 2> if the *RRCReconfiguration* includes the *masterCellGroup* containing the *reportUplinkTxDirectCurrent*, or;
- 2> if the *RRCReconfiguration* includes the *secondaryCellGroup* containing the *reportUplinkTxDirectCurrent*:
 - 3> include the *uplinkTxDirectCurrentList*;

1> if the UE is configured with E-UTRA *nr-SecondaryCellGroupConfig* (MCG is E-UTRA):

- 2> if *RRCReconfiguration* was received via SRB1:
 - 3> submit the *RRCReconfigurationComplete* via the EUTRA MCG embedded in E-UTRA RRC message *RRCConnectionReconfigurationComplete* as specified in TS 36.331 [10];
 - 3> if *reconfigurationWithSync* was included in *spCellConfig* of an SCG:
 - 4> initiate the random access procedure on the SpCell, as specified in TS 38.321 [3];
- 3> else:
 - 4> the procedure ends;

NOTE: The order the UE sends the *RRCConnectionReconfigurationComplete* message and performs the Random Access procedure towards the SCG is left to UE implementation.

- 2> else (*RRCReconfiguration* was received via SRB3):
 - 3> submit the *RRCReconfigurationComplete* message via SRB3 to lower layers for transmission using the new configuration;

NOTE: For EN-DC, in the case of SRB1, the random access is triggered by RRC layer itself as there is not necessarily other UL transmission. In the case of SRB3, the random access is triggered by the MAC layer due to arrival of *RRCReconfigurationComplete*.

1> else:

- 2> submit the *RRCReconfigurationComplete* message via SRB1 to lower layers for transmission using the new configuration;

...

1> if *reconfigurationWithSync* was included in *spCellConfig* of an MCG or SCG, and when MAC of an NR cell group successfully completes a random access procedure triggered above;

- 2> stop timer T304 for that cell group;
- 2> apply the parts of the CQI reporting configuration, the scheduling request configuration and the sounding RS configuration that do not require the UE to know the SFN of the respective target SpCell, if any;
- 2> apply the parts of the measurement and the radio resource configuration that require the UE to know the SFN of the respective target SpCell (e.g. measurement gaps, periodic CQI reporting, scheduling request configuration, sounding RS configuration), if any, upon acquiring the SFN of that target SpCell;
- 2> if the *reconfigurationWithSync* was included in *spCellConfig* of an MCG:
 - 3> if T390 is running:
 - 4> stop timer T390 for all access categories;
 - 4> perform the actions as specified in 5.3.14.4.

...

[TS 38.331, clause 5.3.5.5.1]

The network configures the UE with Master Cell Group (MCG), and zero or one Secondary Cell Group (SCG). For EN-DC, the MCG is configured as specified in TS 36.331 [10]. The network provides the configuration parameters for a cell group in the *CellGroupConfig* IE.

The UE performs the following actions based on a received *CellGroupConfig* IE:

- 1> if the *CellGroupConfig* contains the *spCellConfig* with *reconfigurationWithSync*:
 - 2> perform Reconfiguration with sync according to 5.3.5.5.2;
 - 2> resume all suspended radio bearers and resume SCG transmission for all radio bearers, if suspended;
- 1> if the *CellGroupConfig* contains the *rlc-BearerToReleaseList*:
 - 2> perform RLC bearer release as specified in 5.3.5.5.3;
- 1> if the *CellGroupConfig* contains the *rlc-BearerToAddModList*:
 - 2> perform the RLC bearer addition/modification as specified in 5.3.5.5.4;
- 1> if the *CellGroupConfig* contains the *mac-CellGroupConfig*:
 - 2> configure the MAC entity of this cell group as specified in 5.3.5.5.5;
- 1> if the *CellGroupConfig* contains the *sCellToReleaseList*:
 - 2> perform SCell release as specified in 5.3.5.5.8;
- 1> if the *CellGroupConfig* contains the *spCellConfig*:
 - 2> configure the SpCell as specified in 5.3.5.5.7;
- 1> if the *CellGroupConfig* contains the *sCellToAddModList*:
 - 2> perform SCell addition/modification as specified in 5.3.5.5.9.

[TS 38.331, clause 5.3.5.5.2]

The UE shall perform the following actions to execute a reconfiguration with sync.

- 1> if the security is not activated, perform the actions upon going to RRC_IDLE as specified in 5.3.11 with the release cause 'other' upon which the procedure ends;
- 1> stop timer T310 for the corresponding SpCell, if running;
- 1> start timer T304 for the corresponding SpCell with the timer value set to *t304*, as included in the *reconfigurationWithSync*;
- 1> if the *frequencyInfoDL* is included:
 - 2> consider the target SpCell to be one on the frequency indicated by the *frequencyInfoDL* with a physical cell identity indicated by the *physCellId*;
- 1> else:
 - 2> consider the target SpCell to be one on the SSB frequency of the source SpCell with a physical cell identity indicated by the *physCellId*;
- 1> start synchronising to the DL of the target SpCell;
- 1> apply the specified BCCH configuration defined in 9.1.1.1;
- 1> acquire the *MIB*, which is scheduled as specified in TS 38.213 [13];
- 1> perform the actions specified in clause 5.2.2.4.1;

NOTE 1: The UE should perform the reconfiguration with sync as soon as possible following the reception of the RRC message triggering the reconfiguration with sync, which could be before confirming successful reception (HARQ and ARQ) of this message.

NOTE 2: The UE may omit reading the MIB if the UE already has the required timing information, or the timing information is not needed for random access.

1> reset the MAC entity of this cell group;

1> consider the SCell(s) of this cell group, if configured, to be in deactivated state;

1> apply the value of the *newUE-Identity* as the C-RNTI for this cell group;

Editor's Note: Verify that this does not configure some common parameters which are later discarded due to e.g. SCell release or due to LCH release.

1> configure lower layers in accordance with the received *spCellConfigCommon*;

1> configure lower layers in accordance with any additional fields, not covered in the previous, if included in the received *reconfigurationWithSync*.

8.2.3.13.1.3 Test description

8.2.3.13.1.3.1 Pre-test conditions

System Simulator:

- E-UTRA Cell 1 is the PCell, E-UTRA Cell 2 is the target PCell and NR Cell 1 is the PSCell.

UE:

- None.

Preamble:

- If *pc_IP_Ping* is set to TRUE then, the UE is in state RRC_CONNECTED using generic procedure parameter Connectivity (EN-DC), Bearers (MCG(s) and SCG) established according to TS 38.508-1 [4], clause 4.5.4.2-1.
- Else, the UE is in state RRC_CONNECTED using generic procedure parameter Connectivity (EN-DC), Bearers (MCG(s) and SCG) and Test Loop Function (On) with UE test loop mode B activated according to TS 38.508-1 [4], table 4.5.4.2-1.

8.2.3.13.1.3.2 Test procedure sequence

Tables 8.2.3.13.1.3.2-1 and 8.2.3.13.1.3.2-2 and Table 8.2.3.13.1.3.2-1A illustrate the downlink power levels and other changing parameters to be applied for the cells, with NR cells configured with FR1 and FR2 bands respectively, at various time instants of the test execution. Row marked "T0" denotes the initial conditions after preamble, while columns marked "T1" is to be applied subsequently. The exact instants on which these values shall be applied are described in the texts in this clause.

Table 8.2.3.13.1.3.2-1: Time instances of cell power level and parameter changes for FR1

| | Parameter | Unit | E-UTRA Cell 1 | E-UTRA Cell 2 | NR Cell 1 | Remark |
|----|-----------------------|-----------|---------------|---------------|-----------|--------|
| T0 | Cell-specific RS EPRE | dBm/15kHz | -85 | -91 | - | |
| | SS/PBCH SSS EPRE | dBm/SCS | - | - | -88 | |
| T1 | Cell-specific RS EPRE | dBm/15kHz | -85 | -79 | - | |
| | SS/PBCH SSS EPRE | dBm/SCS | - | - | -88 | |

Table 8.2.3.13.1.3.2-2: Time instances of cell power level and parameter changes for FR2

| | Parameter | Unit | E-UTRA Cell 1 | E-UTRA Cell 2 | NR Cell 1 | Remark |
|----|-----------------------|-----------|---------------|---------------|-----------|--------|
| T0 | Cell-specific RS EPRE | dBm/15kHz | FFS | FFS | - | |
| | SS/PBCH SSS EPRE | [dBm/SCS] | - | - | FFS | |
| T1 | Cell-specific RS EPRE | dBm/15kHz | FFS | FFS | - | |
| | SS/PBCH SSS EPRE | [dBm/SCS] | - | - | FFS | |

Table 8.2.3.13.1.3.2-3: Main behaviour

| St | Procedure | Message Sequence | | TP | Verdict |
|----|---|------------------|--|----|---------|
| | | U - S | Message | | |
| 1 | SS re-adjusts the cell-specific reference signal level according to row "T1" 8.2.3.13.1.3.2-1 or 8.2.3.13.1.3.2-1A depending upon whether NR cell is configured on FR1 or FR2 band respectively. | - | - | - | - |
| 2 | The SS transmits an <i>RRCConnectionReconfiguration</i> message containing <i>mobilityControlInfo</i> to handover to E-UTRA Cell 2 and NR <i>RRCReconfiguration</i> message to perform SCG change with <i>reconfigurationWithSync</i> with the same PSCell. | <- | <i>RRCConnectionReconfiguration (RRCReconfiguration)</i> | - | - |
| 3 | Check: Does the UE transmit an <i>RRCConnectionReconfigurationComplete</i> message containing NR <i>RRCReconfigurationComplete</i> message on E-UTRA Cell 2? | -> | <i>RRCConnectionReconfigurationComplete (RRCReconfigurationComplete)</i> | 1 | P |
| 4 | Void | - | - | - | - |
| 5 | Check: Does the test result of generic test procedure in TS 38.508-1 subclause 4.9.1 indicate that the UE is capable of exchanging IP data on SCG DRB using NR radio path? | - | - | 1 | P |

8.2.3.13.1.3.3 Specific message contents

Table 8.2.3.13.1.3.3-1: RRCConnectionReconfiguration (step 2, Table 8.2.3.13.1.3.2-2)

| Derivation Path: 36.508 [7], Table 4.6.1-8 with condition EN-DC_EmbedNR_RRCRecon and EN-DC_PSCell_HO AND RBConfig_KeyChange | | | |
|---|---|---------|-----------|
| Information Element | Value/remark | Comment | Condition |
| RRCConnectionReconfiguration ::= SEQUENCE { | | | |
| criticalExtensions CHOICE { | | | |
| c1 CHOICE { | | | |
| rrcConnectionReconfiguration-r8 SEQUENCE { | | | |
| mobilityControlInfo SEQUENCE { | MobilityControlInfo-HO | | |
| targetPhysCellId | PhysicalCellIdentity of E-UTRA Cell 2 | | |
| carrierFreq SEQUENCE { | | | |
| dl-CarrierFreq | Same downlink EARFCN as used for E-UTRA Cell 2 | | |
| } | | | |
| carrierFreq SEQUENCE { } | Not present | | Band > 64 |
| carrierFreq-v9e0 SEQUENCE { | | | Band > 64 |
| dl-CarrierFreq-v9e0 | Same downlink EARFCN as used for E-UTRA Cell 2 | | |
| } | | | |
| } | | | |
| nonCriticalExtension SEQUENCE { | | | |
| nonCriticalExtension SEQUENCE { | | | |
| nonCriticalExtension SEQUENCE { | | | |
| nonCriticalExtension SEQUENCE { | | | |
| nonCriticalExtension SEQUENCE { | | | |
| nonCriticalExtension SEQUENCE { | | | |
| nonCriticalExtension SEQUENCE { | | | |
| nonCriticalExtension SEQUENCE { | | | |
| sk-Counter-r15 | Different counter value used before Handover than what was used for initial Split bearer configuration. | | |
| } | | | |
| } | | | |
| } | | | |
| } | | | |
| } | | | |
| } | | | |
| } | | | |
| } | | | |
| } | | | |
| } | | | |
| } | | | |
| } | | | |
| } | | | |
| } | | | |
| } | | | |
| } | | | |

| Condition | Explanation |
|-----------|--------------------------|
| Band > 64 | If band > 64 is selected |

Table 8.2.3.13.1.3.3-2: MobilityControlInfo-HO (Table 8.2.3.13.1.3.3-1)

| |
|--|
| Derivation Path: 36.508 [7], Table 4.6.5-1 |
|--|

8.2.3.14 SCG change / Reconfiguration with sync / Split DRB

8.2.3.14.1 SCG change / Reconfiguration with sync / Split DRB / EN-DC

8.2.3.14.1.1 Test Purpose (TP)

(1)

```
with { UE in RRC_CONNECTED state with EN-DC, and, MCG(s) (E-UTRA PDCP) and Split }
ensure that {
  when { UE receives an RRCConnectionReconfiguration message to handover from NR PSCell involving
  SCG change with reconfigurationWithSync to the target NR cell with Split DRB }
  then { UE sends an RRCConnectionReconfigurationComplete message }
}
```

8.2.3.14.1.2 Conformance requirements

References: The conformance requirements covered in the present TC are specified in: TS 36.331, clause 5.3.5.3, TS 38.331, clauses 5.3.5.3, 5.3.5.5.1 and 5.3.5.5.2. Unless otherwise stated these are Rel-15 requirements.

[TS 36.331, clause 5.3.5.3]

If the *RRCConnectionReconfiguration* message does not include the *mobilityControlInfo* and the UE is able to comply with the configuration included in this message, the UE shall:

...

1> if the received *RRCConnectionReconfiguration* includes the *sk-Counter*:

2> perform key update procedure as specified in TS 38.331 [82], clause 5.3.5.7;

1> if the received *RRCConnectionReconfiguration* includes the *nr-SecondaryCellGroupConfig*:

2> perform NR RRC Reconfiguration as specified in TS 38.331 [82], clause 5.3.5.3;

...

1> set the content of *RRCConnectionReconfigurationComplete* message as follows:

...

2> if the received *RRCConnectionReconfiguration* message included *nr-SecondaryCellGroupConfig*:

3> include *scg-ConfigResponseNR* in accordance with TS 38.331 [82], clause 5.3.5.3;

1> submit the *RRCConnectionReconfigurationComplete* message to lower layers for transmission using the new configuration, upon which the procedure ends;

[TS 38.331, clause 5.3.5.3]

The UE shall perform the following actions upon reception of the *RRCReconfiguration*:

...

1> if the *RRCReconfiguration* includes the *secondaryCellGroup*:

2> perform the cell group configuration for the SCG according to 5.3.5.5;

...

1> set the content of *RRCReconfigurationComplete* message as follows:

2> if the *RRCReconfiguration* includes the *masterCellGroup* containing the *reportUplinkTxDirectCurrent*, or;

2> if the *RRCReconfiguration* includes the *secondaryCellGroup* containing the *reportUplinkTxDirectCurrent*:

3> include the *uplinkTxDirectCurrentList*;

- 1> if the UE is configured with E-UTRA *nr-SecondaryCellGroupConfig* (MCG is E-UTRA):
 - 2> if *RRCReconfiguration* was received via SRB1:
 - 3> submit the *RRCReconfigurationComplete* via the EUTRA MCG embedded in E-UTRA RRC message *RRCConnectionReconfigurationComplete* as specified in TS 36.331 [10];
 - 3> if *reconfigurationWithSync* was included in *spCellConfig* of an SCG:
 - 4> initiate the random access procedure on the SpCell, as specified in TS 38.321 [3];
 - 3> else:
 - 4> the procedure ends;

NOTE: The order the UE sends the *RRCConnectionReconfigurationComplete* message and performs the Random Access procedure towards the SCG is left to UE implementation.

- 2> else (*RRCReconfiguration* was received via SRB3):
 - 3> submit the *RRCReconfigurationComplete* message via SRB3 to lower layers for transmission using the new configuration;

NOTE: For EN-DC, in the case of SRB1, the random access is triggered by RRC layer itself as there is not necessarily other UL transmission. In the case of SRB3, the random access is triggered by the MAC layer due to arrival of *RRCReconfigurationComplete*.

1> else:

...

- 1> if *reconfigurationWithSync* was included in *spCellConfig* of an MCG or SCG, and when MAC of an NR cell group successfully completes a random access procedure triggered above:
 - 2> stop timer T304 for that cell group;
 - 2> apply the parts of the CQI reporting configuration, the scheduling request configuration and the sounding RS configuration that do not require the UE to know the SFN of the respective target SpCell, if any;
 - 2> apply the parts of the measurement and the radio resource configuration that require the UE to know the SFN of the respective target SpCell (e.g. measurement gaps, periodic CQI reporting, scheduling request configuration, sounding RS configuration), if any, upon acquiring the SFN of that target SpCell;
 - 2> if the *reconfigurationWithSync* was included in *spCellConfig* of an MCG:
 - 3> if T390 is running:
 - 4> stop timer T390 for all access categories;
 - 4> perform the actions as specified in 5.3.14.4.

[TS 38.331, clause 5.3.5.5.1]

The network configures the UE with Master Cell Group (MCG), and zero or one Secondary Cell Group (SCG). For EN-DC, the MCG is configured as specified in TS 36.331 [10]. The network provides the configuration parameters for a cell group in the *CellGroupConfig* IE.

The UE performs the following actions based on a received *CellGroupConfig* IE:

- 1> if the *CellGroupConfig* contains the *spCellConfig* with *reconfigurationWithSync*:
 - 2> perform Reconfiguration with sync according to 5.3.5.5.2;
 - 2> resume all suspended radio bearers and resume SCG transmission for all radio bearers, if suspended;
- 1> if the *CellGroupConfig* contains the *rlc-BearerToReleaseList*:
 - 2> perform RLC bearer release as specified in 5.3.5.5.3;

- 1> if the *CellGroupConfig* contains the *rlc-BearerToAddModList*:
 - 2> perform the RLC bearer addition/modification as specified in 5.3.5.5.4;
- 1> if the *CellGroupConfig* contains the *mac-CellGroupConfig*:
 - 2> configure the MAC entity of this cell group as specified in 5.3.5.5.5;
- 1> if the *CellGroupConfig* contains the *sCellToReleaseList*:
 - 2> perform SCell release as specified in 5.3.5.5.8;
- 1> if the *CellGroupConfig* contains the *spCellConfig*:
 - 2> configure the SpCell as specified in 5.3.5.5.7;
- 1> if the *CellGroupConfig* contains the *sCellToAddModList*:
 - 2> perform SCell addition/modification as specified in 5.3.5.5.9.

[TS 38.331, clause 5.3.5.5.2]

The UE shall perform the following actions to execute a reconfiguration with sync.

- 1> if the security is not activated, perform the actions upon going to RRC_IDLE as specified in 5.3.11 with the release cause 'other' upon which the procedure ends;
- 1> stop timer T310 for the corresponding SpCell, if running;
- 1> start timer T304 for the corresponding SpCell with the timer value set to *t304*, as included in the *reconfigurationWithSync*;
- 1> if the *frequencyInfoDL* is included:
 - 2> consider the target SpCell to be one on the frequency indicated by the *frequencyInfoDL* with a physical cell identity indicated by the *physCellId*;
- 1> else:
 - 2> consider the target SpCell to be one on the SSB frequency of the source SpCell with a physical cell identity indicated by the *physCellId*;
- 1> start synchronising to the DL of the target SpCell;
- 1> apply the specified BCCH configuration defined in 9.1.1.1;
- 1> acquire the *MIB*, which is scheduled as specified in TS 38.213 [13];
- 1> perform the actions specified in clause 5.2.2.4.1;

NOTE 1: The UE should perform the reconfiguration with sync as soon as possible following the reception of the RRC message triggering the reconfiguration with sync, which could be before confirming successful reception (HARQ and ARQ) of this message.

NOTE 2: The UE may omit reading the MIB if the UE already has the required timing information, or the timing information is not needed for random access.

- 1> reset the MAC entity of this cell group;
- 1> consider the SCell(s) of this cell group, if configured, to be in deactivated state;
- 1> apply the value of the *newUE-Identity* as the C-RNTI for this cell group;

Editor's Note: Verify that this does not configure some common parameters which are later discarded due to e.g. SCell release or due to LCH release.

l> configure lower layers in accordance with the received *spCellConfigCommon*;

l> configure lower layers in accordance with any additional fields, not covered in the previous, if included in the received *reconfigurationWithSync*.

8.2.3.14.1.3 Test description

8.2.3.14.1.3.1 Pre-test conditions

System Simulator:

- E-UTRA Cell 1 is the PCell, NR Cell 1 is the source PSCell and NR Cell 2 is the target PSCell.

UE:

- None.

Preamble:

- If *pc_IP_Ping* is set to TRUE then, the UE is in state RRC_CONNECTED using generic procedure parameter Connectivity (*EN-DC*), Bearers (*MCG(s) and Split*) established according to TS 38.508-1 [4], clause 4.5.4.2-1.
- Else, the UE is in state RRC_CONNECTED using generic procedure parameter Connectivity (*EN-DC*), Bearers (*MCG(s) and Split*) and Test Loop Function (On) with UE test loop mode B activated according to TS 38.508-1 [4], table 4.5.4.2-1.

8.2.3.14.1.3.2 Test procedure sequence

Table 8.2.3.14.1.3.2-1 and 8.2.3.14.1.3.2-2 illustrate the downlink power levels and other changing parameters to be applied for the cells, with NR cell configured with FR1 and FR2 band respectively, at various time instants of the test execution. Row marked "T0" denotes the initial conditions after preamble, while columns marked "T1" is to be applied subsequently. The exact instants on which these values shall be applied are described in the texts in this clause.

Table 8.2.3.14.1.3.2-1: Time instances of cell power level and parameter changes for FR1

| | Parameter | Unit | E-UTRA Cell 1 | NR Cell 1 | NR Cell 2 | Remark |
|----|-----------------------|-----------|---------------|-----------|-----------|--------|
| T0 | Cell-specific RS EPRE | dBm/15kHz | -85 | - | - | |
| | SS/PBCH SSS EPRE | dBm/SCS | - | -88 | "Off" | |
| T1 | Cell-specific RS EPRE | dBm/15kHz | -85 | - | - | |
| | SS/PBCH SSS EPRE | dBm/SCS | - | -88 | -82 | |

Table 8.2.3.14.1.3.2-2: Time instances of cell power level and parameter changes for FR2

| | Parameter | Unit | E-UTRA Cell 1 | NR Cell 1 | NR Cell 2 | Remark |
|----|-----------------------|-----------|---------------|-----------|-----------|--------|
| T0 | Cell-specific RS EPRE | dBm/15kHz | -96 | - | - | |
| | SS/PBCH SSS EPRE | dBm/SCS | - | -91 | "Off" | |
| T1 | Cell-specific RS EPRE | dBm/15kHz | -96 | - | - | |
| | SS/PBCH SSS EPRE | dBm/SCS | - | -91 | -82 | |

Table 8.2.3.14.1.3.2-3: Main behaviour

| St | Procedure | Message Sequence | | TP | Verdict |
|----|---|------------------|---|----|---------|
| | | U - S | Message | | |
| 1 | SS re-adjusts the cell-specific reference signal level according to row "T1" in table 8.2.3.14.1.3.2-1 or 8.2.3.14.1.3.2-2 depending upon whether NR cells are configured on FR1 or FR2 bands respectively. | - | - | - | - |
| 2 | The SS transmits an <i>RRCConnectionReconfiguration</i> message containing NR <i>RRCReconfiguration</i> message including <i>reconfigurewithsync</i> to handover source PSCell NR Cell 1 to target NR Cell 2 with Split DRB | <-- | <i>RRCConnectionReconfiguration</i>
(<i>RRCReconfiguration</i>) | - | - |
| 3 | Check: Does the UE transmit an <i>RRCConnectionReconfigurationComplete</i> message containing NR <i>RRCReconfigurationComplete</i> message? | --> | <i>RRCConnectionReconfigurationC</i>
<i>omplete</i>
(<i>RRCReconfigurationComplete</i>) | 1 | P |
| 4 | Void. | - | - | - | - |
| 5 | Check: Does the test result of generic test procedure in TS 38.508-1 subclause 4.9.1 indicate that the UE is capable of exchanging IP data on Split DRB using NR radio path on NR Cell 2? | - | - | 1 | P |

Table 8.2.3.14.1.3.3-3 *CellGroupConfig* (Table 8.2.3.14.1.3.3-2)

| Derivation Path: 38.508-1 [4], Table 4.6.3-19 with condition PSCell_change | | | |
|--|-------------------------------------|---------|-----------|
| Information Element | Value/remark | Comment | Condition |
| CellGroupConfig ::= SEQUENCE { | | | |
| spCellConfig SEQUENCE { | | | |
| reconfigurationWithSync SEQUENCE { | | | |
| spCellConfigCommon SEQUENCE { | | | |
| physCellId | Physical Cell Identity of NR Cell 2 | | |
| } | | | |
| newUE-Identity | '4148'H | | |
| } | | | |
| } | | | |

8.2.3.14.2 SCG change / Reconfiguration with sync / Split DRB / NR-DC

8.2.3.14.2.1 Test Purpose (TP)

(1)

```
with { UE in NR RRC_CONNECTED state }
ensure that {
  when { UE receives an RRCReconfiguration message to handover from NR PSCell involving SCG change
with reconfigurationWithSync to the target NR cell with Split DRB }
  then { UE sends an RRCReconfigurationComplete message }
}
```

8.2.3.14.2.2 Conformance requirements

References: The conformance requirements covered in the present TC are specified in: TS 38.331, clauses 5.3.5.3, 5.3.5.5.1 and 5.3.5.5.2. Unless otherwise stated these are Rel-15 requirements.

[TS 38.331, clause 5.3.5.3]

The UE shall perform the following actions upon reception of the *RRCReconfiguration*:

...

1> if the *RRCReconfiguration* includes the *secondaryCellGroup*:

2> perform the cell group configuration for the SCG according to 5.3.5.5;

...

1> set the content of *RRCReconfigurationComplete* message as follows:

2> if the *RRCReconfiguration* includes the *masterCellGroup* containing the *reportUplinkTxDirectCurrent*, or;

2> if the *RRCReconfiguration* includes the *secondaryCellGroup* containing the *reportUplinkTxDirectCurrent*:

3> include the *uplinkTxDirectCurrentList*;

1> if the UE is configured with E-UTRA *nr-SecondaryCellGroupConfig* (MCG is E-UTRA):

2> if *RRCReconfiguration* was received via SRB1:

3> submit the *RRCReconfigurationComplete* via the EUTRA MCG embedded in E-UTRA RRC message *RRCConnectionReconfigurationComplete* as specified in TS 36.331 [10];

3> if *reconfigurationWithSync* was included in *spCellConfig* of an SCG:

4> initiate the random access procedure on the SpCell, as specified in TS 38.321 [3];

3> else:

4> the procedure ends;

NOTE: The order the UE sends the *RRCConnectionReconfigurationComplete* message and performs the Random Access procedure towards the SCG is left to UE implementation.

2> else (*RRCReconfiguration* was received via SRB3):

3> submit the *RRCReconfigurationComplete* message via SRB3 to lower layers for transmission using the new configuration;

NOTE: For EN-DC, in the case of SRB1, the random access is triggered by RRC layer itself as there is not necessarily other UL transmission. In the case of SRB3, the random access is triggered by the MAC layer due to arrival of *RRCReconfigurationComplete*.

1> else:

...

1> if *reconfigurationWithSync* was included in *spCellConfig* of an MCG or SCG, and when MAC of an NR cell group successfully completes a random access procedure triggered above;

2> stop timer T304 for that cell group;

2> apply the parts of the CQI reporting configuration, the scheduling request configuration and the sounding RS configuration that do not require the UE to know the SFN of the respective target SpCell, if any;

2> apply the parts of the measurement and the radio resource configuration that require the UE to know the SFN of the respective target SpCell (e.g. measurement gaps, periodic CQI reporting, scheduling request configuration, sounding RS configuration), if any, upon acquiring the SFN of that target SpCell;

2> if the *reconfigurationWithSync* was included in *spCellConfig* of an MCG:

3> if T390 is running:

4> stop timer T390 for all access categories;

4> perform the actions as specified in 5.3.14.4.

[TS 38.331, clause 5.3.5.5.1]

The network configures the UE with Master Cell Group (MCG), and zero or one Secondary Cell Group (SCG). For EN-DC, the MCG is configured as specified in TS 36.331 [10]. The network provides the configuration parameters for a cell group in the *CellGroupConfig* IE.

The UE performs the following actions based on a received *CellGroupConfig* IE:

1> if the *CellGroupConfig* contains the *spCellConfig* with *reconfigurationWithSync*:

2> perform Reconfiguration with sync according to 5.3.5.5.2;

2> resume all suspended radio bearers and resume SCG transmission for all radio bearers, if suspended;

1> if the *CellGroupConfig* contains the *rlc-BearerToReleaseList*:

2> perform RLC bearer release as specified in 5.3.5.5.3;

1> if the *CellGroupConfig* contains the *rlc-BearerToAddModList*:

2> perform the RLC bearer addition/modification as specified in 5.3.5.5.4;

1> if the *CellGroupConfig* contains the *mac-CellGroupConfig*:

2> configure the MAC entity of this cell group as specified in 5.3.5.5.5;

1> if the *CellGroupConfig* contains the *sCellToReleaseList*:

- 2> perform SCell release as specified in 5.3.5.5.8;
- 1> if the *CellGroupConfig* contains the *spCellConfig*:
 - 2> configure the SpCell as specified in 5.3.5.5.7;
- 1> if the *CellGroupConfig* contains the *sCellToAddModList*:
 - 2> perform SCell addition/modification as specified in 5.3.5.5.9.

[TS 38.331, clause 5.3.5.5.2]

The UE shall perform the following actions to execute a reconfiguration with sync.

- 1> if the security is not activated, perform the actions upon going to RRC_IDLE as specified in 5.3.11 with the release cause 'other' upon which the procedure ends;
- 1> stop timer T310 for the corresponding SpCell, if running;
- 1> start timer T304 for the corresponding SpCell with the timer value set to *t304*, as included in the *reconfigurationWithSync*;
- 1> if the *frequencyInfoDL* is included:
 - 2> consider the target SpCell to be one on the frequency indicated by the *frequencyInfoDL* with a physical cell identity indicated by the *physCellId*;
- 1> else:
 - 2> consider the target SpCell to be one on the SSB frequency of the source SpCell with a physical cell identity indicated by the *physCellId*;
- 1> start synchronising to the DL of the target SpCell;
- 1> apply the specified BCCH configuration defined in 9.1.1.1;
- 1> acquire the *MIB*, which is scheduled as specified in TS 38.213 [13];
- 1> perform the actions specified in clause 5.2.2.4.1;

NOTE 1: The UE should perform the reconfiguration with sync as soon as possible following the reception of the RRC message triggering the reconfiguration with sync, which could be before confirming successful reception (HARQ and ARQ) of this message.

NOTE 2: The UE may omit reading the MIB if the UE already has the required timing information, or the timing information is not needed for random access.

- 1> reset the MAC entity of this cell group;
- 1> consider the SCell(s) of this cell group, if configured, to be in deactivated state;
- 1> apply the value of the *newUE-Identity* as the C-RNTI for this cell group;

Editor's Note: Verify that this does not configure some common parameters which are later discarded due to e.g. SCell release or due to LCH release.

- 1> configure lower layers in accordance with the received *spCellConfigCommon*;
- 1> configure lower layers in accordance with any additional fields, not covered in the previous, if included in the received *reconfigurationWithSync*.

8.2.3.14.2.3 Test description

8.2.3.14.2.3.1 Pre-test conditions

System Simulator:

- NR Cell 1 is the PCell, NR Cell 10 is the source PSCell and NR Cell 30 is the target PSCell.

UE:

- None.

Preamble:

- If `pc_IP_Ping` is set to TRUE then, the UE is in state NR RRC_CONNECTED using generic procedure parameter Connectivity (NR-DC), Bearers (MCG(s) and Split) established according to TS 38.508-1 [4], clause 4.5.4.2-1.
- Else, the UE is in state NR RRC_CONNECTED using generic procedure parameter Connectivity (NR-DC), Bearers (MCG(s) and Split) and Test Loop Function (On) with UE test loop mode B activated according to TS 38.508-1 [4], table 4.5.4.2-1.

8.2.3.14.2.3.2 Test procedure sequence

Table 8.2.3.14.2.3.2-1 and 8.2.3.14.2.3.2-2 illustrate the downlink power levels and other changing parameters to be applied for the cells, with NR cell configured with FR1 and FR2 band respectively, at various time instants of the test execution. Row marked "T0" denotes the initial conditions after preamble, while columns marked "T1" is to be applied subsequently. The exact instants on which these values shall be applied are described in the texts in this clause.

Table 8.2.3.14.2.3.2-1: Time instances of cell power level and parameter changes for FR1

| | Parameter | Unit | NR Cell 1 | NR Cell 10 | NR Cell 30 | Remark |
|----|---------------------|-------------|-----------|------------|------------|--------|
| T0 | SS/PBCH
SSS EPRE | dBm/
SCS | -85 | -88 | "Off" | |
| T1 | SS/PBCH
SSS EPRE | dBm/
SCS | -85 | -88 | -82 | |

Table 8.2.3.14.2.3.2-2: Time instances of cell power level and parameter changes for FR2

| | Parameter | Unit | NR Cell 1 | NR Cell 10 | NR Cell 30 | Remark |
|----|---------------------|-------------|-----------|------------|------------|--------|
| T0 | SS/PBCH
SSS EPRE | dBm/
SCS | -82 | -91 | "Off" | |
| T1 | SS/PBCH
SSS EPRE | dBm/
SCS | -82 | -91 | -82 | |

Table 8.2.3.14.2.3.2-3: Main behaviour

| St | Procedure | Message Sequence | | TP | Verdict |
|----|---|------------------|-----------------------------------|----|---------|
| | | U - S | Message | | |
| 1 | SS re-adjusts the cell-specific reference signal level according to row "T1" in table 8.2.3.14.2.3.2-1 or 8.2.3.14.2.3.2-2 depending upon whether NR cells are configured on FR1 or FR2 bands respectively. | - | - | - | - |
| 2 | The SS transmits an <i>RRCReconfiguration</i> message including reconfigurewithsync to handover source PSCell NR Cell 10 to target NR Cell 30 with Split DRB | <-- | <i>RRCReconfiguration</i> | - | - |
| 3 | Check: Does the UE transmit an <i>RRCReconfigurationComplete</i> message? | --> | <i>RRCReconfigurationComplete</i> | 1 | P |
| 4 | Check: Does the test result of generic test procedure in TS 38.508-1 subclause 4.9.1 indicate that the UE is capable of exchanging IP data on Split DRB using NR radio path on NR Cell 30? | - | - | 1 | P |

8.2.3.14.2.3.3 Specific message contents

Table 8.2.3.14.2.3.3-1: *RRCReconfiguration* (step 2, Table 8.2.3.14.2.3.2-3)

| Derivation Path: 38.508-1 [4], Table 4.6.1-13 | | | |
|---|---|---------|-----------|
| Information Element | Value/remark | Comment | Condition |
| <i>RRCReconfiguration</i> ::= SEQUENCE { | | | |
| criticalExtensions CHOICE { | | | |
| rrcReconfiguration SEQUENCE { | | | |
| nonCriticalExtension SEQUENCE { | | | |
| masterCellGroup | OCTET STRING
(CONTAINING
<i>CellGroupConfig</i> -Add) | | |
| nonCriticalExtension SEQUENCE { | | | |
| nonCriticalExtension SEQUENCE { | | | |
| mrdc-SecondaryCellGroupConfig CHOICE { | | | |
| setup SEQUENCE { | | | |
| mrdc-SecondaryCellGroup CHOICE { | | | |
| nr-SCG | OCTET STRING
(CONTAINING
<i>RRCReconfiguration</i> -
Mod) | | |
| } | | | |
| } | | | |
| } | | | |
| radioBearerConfig2 | OCTET STRING
(CONTAINING
<i>RadioBearerConfig</i> _SCG
-Mod) | | |
| sk-Counter | Increment the value by 1
from the previous value | | |
| } | | | |
| } | | | |
| } | | | |
| } | | | |
| } | | | |
| } | | | |

Table 8.2.3.14.2.3.3-2: CellGroupConfig-Add (Table 8.2.3.14.2.3.3-1)

| Derivation Path: 38.508-1 [4], Table 4.6.3-19 | | | |
|---|--|---------|-----------|
| Information Element | Value/remark | Comment | Condition |
| CellGroupConfig ::= SEQUENCE { | | | |
| rlc-BearerToAddModList SEQUENCE (SIZE(1..maxLCH)) OF RLC-BearerConfig { | 3 entry | | |
| RLC-BearerConfig[1] | RLC-BearerConfig with conditions SRB1 and Re-establish_RLC | entry 1 | |
| RLC-BearerConfig[2] | RLC-BearerConfig with conditions SRB2 and Re-establish_RLC | entry 2 | |
| RLC-BearerConfig[3] | RLC-BearerConfig with conditions AM, DRBn and Re-establish_RLC | entry 3 | |
| } | | | |
| } | | | |

Table 8.2.3.14.2.3.3-3: RRCReconfiguration-Mod (Table 8.2.3.14.2.3.3-1)

| Derivation Path: 38.508-1 [4], Table 4.6.1-13 with condition NR-DC_SCG | | | |
|--|-----------------|---------|-----------|
| Information Element | Value/remark | Comment | Condition |
| RRCReconfiguration ::= SEQUENCE { | | | |
| criticalExtensions CHOICE { | | | |
| rrcReconfiguration SEQUENCE { | | | |
| secondaryCellGroup | CellGroupConfig | | |
| } | | | |
| } | | | |
| } | | | |

Table 8.2.3.14.2.3.3-4: RadioBearerConfig_SCG-Mod (Table 8.2.3.14.2.3.3-2)

| Derivation Path: 38.508-1 [4], Table 4.6.3-132 | | | |
|--|--------------|-------------------------------------|-----------|
| Information Element | Value/remark | Comment | Condition |
| RadioBearerConfig ::= SEQUENCE { | | | |
| drb-ToAddModList SEQUENCE (SIZE (1..maxDRB)) OF SEQUENCE { | 1 entry | | |
| drb-Identity | DRBn | n set to the Split SCG DRB identity | |
| reestablishPDCP | true | | |
| pdcpc-Config | Not present | | |
| } | | | |
| } | | | |

Table 8.2.3.14.2.3.3-5: *CellGroupConfig* (Table 8.2.3.14.2.3.3-2)

| Derivation Path: 38.508-1 [4], Table 4.6.3-19 | | | |
|---|--|--|-------------------------------------|
| Information Element | Value/remark | Comment | Condition |
| CellGroupConfig ::= SEQUENCE { | | | |
| cellGroupId | CellGroupId condition NR-DC_SCG | | |
| rlc-BearerToAddModList SEQUENCE (SIZE(1..maxLC-ID)) OF RLC-BearerConfig { | 1 entry | | n set to the Split SCG DRB identity |
| RLC-BearerConfig[1] | RLC-BearerConfig as per TS 38.508-1[4] Table 4.6.3-148: <i>RLC-BearerConfig</i> with conditions AM and DRBn and Re-establish_RLC | entry 1
n set to the Split SCG DRB identity | |
| } | | | |
| spCellConfig SEQUENCE { | | | |
| servCellIndex | ServCellIndex with condition NR-DC_SCG | | |
| reconfigurationWithSync SEQUENCE { | | | |
| spCellConfigCommon SEQUENCE { | | | |
| physCellId | Physical Cell Identity of NR Cell 30 | | |
| } | | | |
| newUE-Identity | '4148'H | | |
| } | | | |
| spCellConfigDedicated | ServingCellConfig | | |
| } | | | |
| } | | | |

8.2.3.15 Measurement configuration control and reporting / Two simultaneous events A2 and A3 (intra-frequency measurements) / Measurement of Neighbour NR cells

8.2.3.15.1 Measurement configuration control and reporting / Two simultaneous events A2 and A3 (intra-frequency measurements) / Measurement of Neighbour NR cells / EN-DC

8.2.3.15.1.1 Test Purpose (TP)

(1)

```
with { UE in RRC_CONNECTED state with EN-DC, and, MCG(s) (E-UTRA PDCP) and SCG and measurements
configured for event A2 and event A3 }
ensure that {
  when { Serving NR cell becomes worse than absolute threshold minus hysteresis }
  then { UE sends MeasurementReport for event A2 }
}
```

(2)

```
with { UE in RRC_CONNECTED state with EN-DC, and, MCG(s) (E-UTRA PDCP) and SCG and measurements
configured for event A2 and event A3 }
ensure that {
  when { Neighbour NR cell becomes offset better than serving NR PSCell }
  then { UE sends MeasurementReport for event A3 }
}
```

8.2.3.15.1.2 Conformance requirements

References: The conformance requirements covered in the present TC are specified in: TS 36.331, clause 5.3.5.3, TS 38.331, clauses 5.3.5.3, 5.5.2, 5.5.4.1, 5.5.4.3, 5.5.4.4 and 5.5.5. Unless otherwise stated these are Rel-15 requirements.

[TS 36.331, clause 5.3.5.3]

If the *RRCCConnectionReconfiguration* message does not include the *mobilityControlInfo* and the UE is able to comply with the configuration included in this message, the UE shall:

...

1> else:

2> if the *RRCCConnectionReconfiguration* message includes the *radioResourceConfigDedicated*:

3> perform the radio resource configuration procedure as specified in 5.3.10;

NOTE 3: If the *RRCCConnectionReconfiguration* message includes the establishment of radio bearers other than SRB1, the UE may start using these radio bearers immediately, i.e. there is no need to wait for an outstanding acknowledgment of the *SecurityModeComplete* message.

...

...

1> set the content of *RRCCConnectionReconfigurationComplete* message as follows:

...

2> if the received *RRCCConnectionReconfiguration* message included *nr-SecondaryCellGroupConfig*:

3> include *scg-ConfigResponseNR* in accordance with TS 38.331 [82], clause 5.3.5.3;

1> submit the *RRCCConnectionReconfigurationComplete* message to lower layers for transmission using the new configuration, upon which the procedure ends;

[TS 38.331, clause 5.3.5.3]

The UE shall perform the following actions upon reception of the *RRCCReconfiguration*:

...

1> if the *RRCCReconfiguration* message includes the *measConfig*:

2> perform the measurement configuration procedure as specified in 5.5.2;

...

1> if the UE is configured with E-UTRA *nr-SecondaryCellGroupConfig* (MCG is E-UTRA):

2> if *RRCCReconfiguration* was received via SRB1:

3> submit the *RRCCReconfigurationComplete* via the EUTRA MCG embedded in E-UTRA RRC message *RRCCConnectionReconfigurationComplete* as specified in TS 36.331 [10];

3> if *reconfigurationWithSync* was included in *spCellConfig* of an SCG:

4> initiate the random access procedure on the SpCell, as specified in TS 38.321 [3];

3> else:

4> the procedure ends;

NOTE: The order the UE sends the *RRCCConnectionReconfigurationComplete* message and performs the Random Access procedure towards the SCG is left to UE implementation.

2> else (*RRCCReconfiguration* was received via SRB3):

...

NOTE: For EN-DC, in the case of SRB1, the random access is triggered by RRC layer itself as there is not necessarily other UL transmission. In the case of SRB3, the random access is triggered by the MAC layer due to arrival of *RRCReconfigurationComplete*.

1> else:

...

[TS 38.331, clause 5.5.2]

The UE shall:

...

1> if the received *measConfig* includes the *measObjectToAddModList*:

2> perform the measurement object addition/modification procedure as specified in 5.5.2.5;

...

1> if the received *measConfig* includes the *reportConfigToAddModList*:

2> perform the reporting configuration addition/modification procedure as specified in 5.5.2.7;

...

1> if the received *measConfig* includes the *measIdToAddModList*:

2> perform the measurement identity addition/modification procedure as specified in 5.5.2.3;

[TS 38.331, clause 5.5.4.1]

If security has been activated successfully, the UE shall:

1> for each *measId* included in the *measIdList* within *VarMeasConfig*:

2> if the corresponding *reportConfig* includes a *reportType* set to *eventTriggered* or *periodical*;

3> if the corresponding *measObject* concerns NR;

4> if the *eventA1* or *eventA2* is configured in the corresponding *reportConfig*:

5> consider only the serving cell to be applicable;

4> else:

5> for events involving a serving cell associated with a *measObjectNR* and neighbours associated with another *measObjectNR*, consider any serving cell associated with the other *measObjectNR* to be a neighbouring cell as well;

...

2> if the *reportType* is set to *eventTriggered* and if the entry condition applicable for this event, i.e. the event corresponding with the *eventId* of the corresponding *reportConfig* within *VarMeasConfig*, is fulfilled for one or more applicable cells for all measurements after layer 3 filtering taken during *timeToTrigger* defined for this event within the *VarMeasConfig*, while the *VarMeasReportList* does not include a measurement reporting entry for this *measId* (a first cell triggers the event):

3> include a measurement reporting entry within the *VarMeasReportList* for this *measId*;

3> set the *numberOfReportsSent* defined within the *VarMeasReportList* for this *measId* to 0;

3> include the concerned cell(s) in the *cellsTriggeredList* defined within the *VarMeasReportList* for this *measId*;

3> initiate the measurement reporting procedure, as specified in 5.5.5;

...

- 2> if the *reportType* is set to *eventTriggered* and if the entry condition applicable for this event, i.e. the event corresponding with the *eventId* of the corresponding *reportConfig* within *VarMeasConfig*, is fulfilled for one or more applicable cells not included in the *cellsTriggeredList* for all measurements after layer 3 filtering taken during *timeToTrigger* defined for this event within the *VarMeasConfig* (a subsequent cell triggers the event):
 - 3> set the *numberOfReportsSent* defined within the *VarMeasReportList* for this *measId* to 0;
 - 3> include the concerned cell(s) in the *cellsTriggeredList* defined within the *VarMeasReportList* for this *measId*;
 - 3> initiate the measurement reporting procedure, as specified in 5.5.5;

[TS 38.331, clause 5.5.4.3]

The UE shall:

- 1> consider the entering condition for this event to be satisfied when condition A2-1, as specified below, is fulfilled;
- 1> consider the leaving condition for this event to be satisfied when condition A2-2, as specified below, is fulfilled;
- 1> for this measurement, consider the serving cell indicated by the *measObjectNR* associated to this event.

Inequality A2-1 (Entering condition)

$$Ms + Hys < Thresh$$

Inequality A2-2 (Leaving condition)

$$Ms - Hys > Thresh$$

The variables in the formula are defined as follows:

Ms is the measurement result of the serving cell, not taking into account any offsets.

Hys is the hysteresis parameter for this event (i.e. *hysteresis* as defined within *reportConfigNR* for this event).

Thresh is the threshold parameter for this event (i.e. *a2-Threshold* as defined within *reportConfigNR* for this event).

Ms is expressed in dBm in case of RSRP, or in dB in case of RSRQ and RS-SINR.

Hys is expressed in dB.

Thresh is expressed in the same unit as ***Ms***.

[TS 38.331, clause 5.5.4.4]

The UE shall:

- 1> consider the entering condition for this event to be satisfied when condition A3-1, as specified below, is fulfilled;
- 1> consider the leaving condition for this event to be satisfied when condition A3-2, as specified below, is fulfilled;
- 1> use the SpCell for *Mp*, *Ofp* and *Ocp*.

NOTE The cell(s) that triggers the event has reference signals indicated in the *measObjectNR* associated to this event which may be different from the NR SpCell*measObjectNR*.

Inequality A3-1 (Entering condition)

$$Mn + Ofn + Ocn - Hys > Mp + Ofp + Ocp + Off$$

Inequality A3-2 (Leaving condition)

$$Mn + Ofn + Ocn + Hys < Mp + Ofp + Ocp + Off$$

The variables in the formula are defined as follows:

Mn is the measurement result of the neighbouring cell, not taking into account any offsets.

Ofn is the measurement object specific offset of the reference signal of the neighbour cell (i.e. *offsetMO* as defined within *measObjectNR* corresponding to the neighbour cell).

Ocn is the cell specific offset of the neighbour cell (i.e. *cellIndividualOffset* as defined within *measObjectNR* corresponding to the frequency of the neighbour cell), and set to zero if not configured for the neighbour cell.

Mp is the measurement result of the SpCell, not taking into account any offsets.

Ofp is the measurement object specific offset of the SpCell (i.e. *offsetMO* as defined within *measObjectNR* corresponding to the SpCell).

Ocp is the cell specific offset of the SpCell (i.e. *cellIndividualOffset* as defined within *measObjectNR* corresponding to the SpCell), and is set to zero if not configured for the SpCell.

Hys is the hysteresis parameter for this event (i.e. *hysteresis* as defined within *reportConfigNR* for this event).

Off is the offset parameter for this event (i.e. *a3-Offset* as defined within *reportConfigNR* for this event).

Mn, Mp are expressed in dBm in case of RSRP, or in dB in case of RSRQ and RS-SINR.

Ofn, Ocn, Ofp, Ocp, Hys, Off are expressed in dB.

[TS 38.331, clause 5.5.5]

For the *measId* for which the measurement reporting procedure was triggered, the UE shall set the *measResults* within the *MeasurementReport* message as follows:

- 1> set the *measId* to the measurement identity that triggered the measurement reporting;
- 1> for each serving cell configured with *servingCellMO*:
 - 2> if the *reportConfig* associated with the *measId* that triggered the measurement reporting includes *rsType*:
 - 3> if the serving cell measurements based on the *rsType* included in the *reportConfig* that triggered the measurement report are available:
 - 4> set the *measResultServingCell* within *measResultServingMOList* to include RSRP, RSRQ and the available SINR of the serving cell, derived based on the *rsType* included in the *reportConfig* that triggered the measurement report;
- 1> set the *servCellId* within *measResultServingMOList* to include each NR serving cell that is configured with *servingCellMO*, if any;
- ...
- 1> if there is at least one applicable neighbouring cell to report:
 - 2> if the *reportType* is set to *eventTriggered* or *periodical*:
 - 3> set the *measResultNeighCells* to include the best neighbouring cells up to *maxReportCells* in accordance with the following:
 - 4> if the *reportType* is set to *eventTriggered*:
 - 5> include the cells included in the *cellsTriggeredList* as defined within the *VarMeasReportList* for this *measId*;
 - 4> for each cell that is included in the *measResultNeighCells*, include the *physCellId*;
 - 4> if the *reportType* is set to *eventTriggered* or *periodical*:
 - 5> for each included cell, include the layer 3 filtered measured results in accordance with the *reportConfig* for this *measId*, ordered as follows:
 - 6> if the *measObject* associated with this *measId* concerns NR:

7> if *rsType* in the associated *reportConfig* is set to *ssb*:

8> set *resultsSSB-Cell* within the *measResult* to include the SS/PBCH block based quantity(ies) indicated in the *reportQuantityCell* within the concerned *reportConfig*, in decreasing order of the sorting quantity, determined as specified in 5.5.5.3, i.e. the best cell is included first;

...

1> if the UE is configured with EN-DC:

2> if SRB3 is configured:

3> submit the *MeasurementReport* message via SRB3 to lower layers for transmission, upon which the procedure ends;

2> else:

3> submit the *MeasurementReport* message via the EUTRA MCG embedded in E-UTRA RRC message *ULInformationTransferMRDC* as specified in TS 36.331 [10].

1> else:

2> submit the *MeasurementReport* message to lower layers for transmission, upon which the procedure ends.

8.2.3.15.1.3 Test description

8.2.3.15.1.3.1 Pre-test conditions

System Simulator:

- EUTRA Cell 1 is the PCell and NR Cell 1 is the PS Cell.
- NR Cell 2 is the intra-frequency neighbour cell.

UE:

- None

Preamble:

- The UE is in state RRC_CONNECTED using generic procedure parameter Connectivity (EN-DC) and DC Bearers (MCG(s) and SCG) on E-UTRA Cell 1 according to TS 38.508-1, clause 4.5.4 [4].

8.2.3.15.1.3.2 Test procedure sequence

Table 8.2.3.15.1.3.2-1 and Table 8.2.3.15.1.3.2-1A illustrates the downlink power levels to be applied for NR Cell 1 and NR Cell 2 at various time instants of the test execution. Row marked "T0" denotes the conditions after the preamble, while rows marked "T1" and "T2" are to be applied subsequently. The exact instants on which these values shall be applied are described in the texts in this clause.

Table 8.2.3.15.1.3.2-1: Time instances of cell power level and parameter changes for FR1

| | Parameter | Unit | EUTRA Cell 1 | NR Cell 1 | NR Cell 2 | Remark |
|----|-----------------------|------------|--------------|-----------|-----------|--|
| T0 | Cell-specific RS EPRE | dBm/15 kHz | -85 | - | - | Power levels are such that entry condition for event A2 and event A3 is not satisfied: |
| | SS/PBCH SSS EPRE | dBm/S CS | - | -85 | -103 | $M_s - H_{ys} > Thresh$
AND
$M_n + Of_n + Ocn + H_{ys} < M_s + Of_s + Ocs + Off$ |
| T1 | Cell-specific RS EPRE | dBm/15 kHz | -85 | - | - | Power level of Cell 1 is such that entry condition for event A2 is satisfied for the serving cell: |
| | SS/PBCH SSS EPRE | dBm/S CS | - | -103 | -113 | $M_s + H_{ys} < Thresh$
AND
Power levels of Cell 1 and Cell 2 are such that entry condition for event A3 is not satisfied for any of the neighbour NR cells:
$M_n + Of_n + Ocn + H_{ys} < M_s + Of_s + Ocs + Off$ |
| T2 | Cell-specific RS EPRE | dBm/15 kHz | -85 | - | - | Power levels are such that entry condition for event A2 is not satisfied:
$M_s - H_{ys} > Thresh$ |
| | SS/PBCH SSS EPRE | dBm/S CS | - | -85 | -78 | Power levels of Cell 1 and Cell 2 are such that entry condition for event A3 is satisfied for intra-frequency neighbour NR cell:
$M_n + Of_n + Ocn - H_{ys} > M_s + Of_s + Ocs + Off$ |

Table 8.2.3.15.1.3.2-1A: Time instances of cell power level and parameter changes for FR2

| | Parameter | Unit | EUTRA Cell 1 | NR Cell 1 | NR Cell 2 | Remark |
|----|-----------------------|------------|--------------|-----------|-----------|--|
| T0 | Cell-specific RS EPRE | dBm/15 kHz | FFS | - | - | Power levels are such that entry condition for event A2 and event A3 is not satisfied: |
| | SS/PBCH SSS EPRE | dBm/S CS | - | FFS | FFS | $M_s - H_{ys} > Thresh$
AND
$M_n + Of_n + Ocn + H_{ys} < M_s + Of_s + Ocs + Off$ |
| T1 | Cell-specific RS EPRE | dBm/15 kHz | FFS | - | - | Power level of Cell 1 is such that entry condition for event A2 is satisfied for the serving cell: |
| | SS/PBCH SSS EPRE | dBm/S CS | - | FFS | FFS | $M_s + H_{ys} < Thresh$
AND
Power levels of Cell 1 and Cell 2 are such that entry condition for event A3 is not satisfied for any of the neighbour NR cells:
$M_n + Of_n + Ocn + H_{ys} < M_s + Of_s + Ocs + Off$ |
| T2 | Cell-specific RS EPRE | dBm/15 kHz | FFS | - | - | Power levels are such that entry condition for event A2 is not satisfied:
$M_s - H_{ys} > Thresh$ |
| | SS/PBCH SSS EPRE | dBm/S CS | - | FFS | FFS | Power levels of Cell 1 and Cell 2 are such that entry condition for event A3 is satisfied for intra-frequency neighbour NR cell:
$M_n + Of_n + Ocn - H_{ys} > M_s + Of_s + Ocs + Off$ |

Table 8.2.3.15.1.3.2-2: Main behaviour

| St | Procedure | Message Sequence | | TP | Verdict |
|----|--|------------------|--|----|---------|
| | | U - S | Message | | |
| 1 | The SS transmits an <i>RRCConnectionReconfiguration</i> message containing NR <i>RRCReconfiguration</i> to setup measurement for PSCell and reporting for event A2, and measurement for neighbour NR Cell and reporting for event A3 (intra-frequency measurement) | <-- | <i>RRCConnectionReconfiguration (RRCReconfiguration)</i> | - | - |
| 2 | Check: Does the UE transmit an <i>RRCConnectionReconfigurationComplete</i> message containing NR <i>RRCReconfigurationComplete</i> message? | --> | <i>RRCConnectionReconfigurationComplete (RRCReconfigurationComplete)</i> | - | - |
| 3 | Check: Does the UE transmit an <i>ULInformationTransferMRDC</i> message containing NR <i>MeasurementReport</i> message within the next 10s to report event A2 or A3? | --> | <i>ULInformationTransferMRDC (MeasurementReport)</i> | 1 | F |
| 4 | The SS re-adjusts the cell-specific reference signal level according to row "T1". | - | - | - | - |
| 5 | Check: Does the UE transmit an <i>ULInformationTransferMRDC</i> message containing NR <i>MeasurementReport</i> message to report event A2 (<i>measId 1</i>) with the measured value for NR Cell 1? | --> | <i>ULInformationTransferMRDC (MeasurementReport)</i> | 1 | P |
| 6 | The SS re-adjusts the cell-specific reference signal level according to row "T2". | - | - | - | - |
| 7 | Check: Does the UE transmit an <i>ULInformationTransferMRDC</i> message containing NR <i>MeasurementReport</i> message to report event A3 (<i>measId 2</i>) with the measured value for NR Cell 2? | --> | <i>ULInformationTransferMRDC (MeasurementReport)</i> | 2 | P |

8.2.3.15.1.3.3 Specific message contents

Table 8.2.3.15.1.3.3-1: *RRCConnectionReconfiguration* (step 1, Table 8.2.3.15.1.3.2-2)

| |
|--|
| Derivation Path: 36.508 [7], Table 4.6.1-8 with condition EN-DC_EmbedNR_RRCRecon |
|--|

Table 8.2.3.15.1.3.3-2: *RRCReconfiguration* (Table 8.2.3.15.1.3.3-1)

| |
|---|
| Derivation Path: 38.508-1 [4], Table 4.6.1-13 with condition EN-DC_MEAS |
|---|

Table 8.2.3.15.1.3.3-3: *MeasConfig* (Table 8.2.3.15.1.3.3-2)

| Derivation Path: 38.508-1 [4], Table 4.6.3-69 | | | |
|--|--------------------|---|-----------|
| Information Element | Value/remark | Comment | Condition |
| MeasConfig ::= SEQUENCE { | | | |
| measObjectToAddModList SEQUENCE (SIZE (1..maxNrofObjectId)) OF MeasObjectToAddMod { | 1 entry | | |
| MeasObjectToAddMod[1] SEQUENCE { | | entry 1 | |
| measObjectId | 1 | | |
| measObject CHOICE { | | | |
| measObjectNR | MeasObjectNR(54) | ssbFrequency IE equals the ARFCN for NR Cell 1
Thresh value set to -103dBm | |
| } | | | |
| } | | | |
| } | | | |
| ReportConfigToAddModList SEQUENCE(SIZE (1..maxReportConfigId)) OF ReportConfigToAddMod { | 2 entries | | |
| ReportConfigToAddMod[1] SEQUENCE { | | entry 1 | |
| reportConfigId | 1 | | |
| reportConfig CHOICE { | | | |
| reportConfigNR | ReportConfigNR(63) | Thresh value set to -94dBm | EVENT_A2 |
| } | | | |
| } | | | |
| ReportConfigToAddMod[2] SEQUENCE { | | entry 2 | |
| reportConfigId | 2 | | |
| reportConfig CHOICE { | | | |
| reportConfigNR | ReportConfigNR(0) | Offset value set to 0dBm | EVENT_A3 |
| } | | | |
| } | | | |
| } | | | |
| MeasIdToAddModList SEQUENCE (SIZE (1..maxNrofMeasId)) OF MeasIdToAddMod { | 2 entries | | |
| MeasIdToAddMod[1] SEQUENCE { | | entry 1 | |
| measId | 1 | | |
| measObjectId | 1 | | |
| reportConfigId | 1 | | |
| } | | | |
| MeasIdToAddMod[2] SEQUENCE { | | entry 2 | |
| measId | 2 | | |
| measObjectId | 1 | | |
| reportConfigId | 2 | | |
| } | | | |
| } | | | |
| } | | | |

Table 8.2.3.15.1.3.3-3a: *ReportConfigNR(Thres)* (Table 8.2.3.15.1.3.3-3)

| Derivation Path: 38.508-1 [4], Table 4.6.3-142 | | | |
|--|--------------|---------|-----------|
| Information Element | Value/remark | Comment | Condition |
| ReportConfigNR ::= SEQUENCE { | | | |
| reportType CHOICE { | | | |
| eventTriggered SEQUENCE { | | | |
| reportAmount | r1 | | |
| } | | | |
| } | | | |
| } | | | |

Table 8.2.3.15.1.3.3-4: RRCConnectionReconfigurationComplete (step 2, Table 8.2.3.15.1.3.2-2)

Derivation Path: 36.508 [7], Table 4.6.1-9 with condition MCG_and_SCG

Table 8.2.3.15.1.3.3-5: ULInformationTransferMRDC (step 5, Table 8.2.3.15.1.3.2-2)

| Derivation Path: 36.508 [7], Table 4.6.1-27 | | | |
|---|--|---------|-----------|
| Information Element | Value/remark | Comment | Condition |
| ULInformationTransferMRDC ::= SEQUENCE { | | | |
| ul-DCCH-MessageNR-r15 | OCTET STRING including the MeasurementReport message according to Table 8.2.3.15.1.3.3-6 | | |
| } | | | |

Table 8.2.3.15.1.3.3-6: MeasurementReport (Table 8.2.3.15.1.3.3-5)

| Derivation Path: 38.508-1 [4], Table 4.6.1-5A | | | |
|--|---------------------------------------|---------|-----------------|
| Information Element | Value/remark | Comment | Condition |
| measurementReport ::= SEQUENCE { | | | |
| measResults SEQUENCE { | | | |
| measId | 1 | | |
| measResultServingMOList SEQUENCE (SIZE (1..maxNrofServingCells)) { | 1 entry | | |
| servCellId | Cell index corresponding to NR Cell 1 | | |
| measResultServingCell SEQUENCE { | | | |
| physCellId | Physical CellID of the NR Cell 1 | | |
| measResult SEQUENCE { | | | |
| cellResults SEQUENCE { | | | |
| resultsSSB-Cell SEQUENCE { | | | |
| rsrp | (0..127) | | |
| rsrq | (0..127) | | |
| sinr | Not present | | |
| | (0..127) | | pc_ss_SINR Meas |
| } | | | |
| } | | | |
| } | | | |
| } | | | |
| } | | | |

Table 8.2.3.15.1.3.3-7: ULInformationTransferMRDC (step 7, Table 8.2.3.15.1.3.2-2)

| Derivation Path: 36.508 [7], Table 4.6.1-27 | | | |
|---|--|---------|-----------|
| Information Element | Value/remark | Comment | Condition |
| ULInformationTransferMRDC ::= SEQUENCE { | | | |
| ul-DCCH-MessageNR-r15 | OCTET STRING including the MeasurementReport message according to Table 8.2.3.15.1.3.3-8 | | |
| } | | | |

```

when { UE receives RRCReconfiguration on SRB3 including MeasConfig to setup periodical measurement
reporting }
then { UE sends RRCReconfigurationComplete and starts sending periodic measurement reports over
SRB3 }
}

```

8.2.3.16.1.2 Conformance requirements

References: The conformance requirements covered in the present TC are specified in: TS 36.331, clauses 5.3.5.3, TS 38.331, clause 5.5.4.1, 5.5.4.7 and 5.5.5.1. Unless otherwise stated these are Rel-15 requirements.

[TS 36.331, clause 5.3.5.3]

If the *RRCConnectionReconfiguration* message does not include the *mobilityControlInfo* and the UE is able to comply with the configuration included in this message, the UE shall:

...

1> if the received *RRCConnectionReconfiguration* includes the *nr-RadioBearerConfig1*:

2> perform radio bearer configuration as specified in TS 38.331 [82], clause 5.3.5.6;

...

1> else:

2> submit the *RRCConnectionReconfigurationComplete* message to lower layers for transmission using the new configuration, upon which the procedure ends;

[TS 38.331, clause 5.3.5.3]

The UE shall perform the following actions upon reception of the *RRCReconfiguration*:

...

1> if the *RRCReconfiguration* message includes the *measConfig*:

2> perform the measurement configuration procedure as specified in 5.5.2;

...

1> if the UE is configured with E-UTRA *nr-SecondaryCellGroupConfig* (UE in (NG)EN-DC):

...

2> else (*RRCReconfiguration* was received via SRB3):

3> submit the *RRCReconfigurationComplete* message via SRB3 to lower layers for transmission using the new configuration;

...

[TS 38.331, clause 5.5.2.1]

The UE shall:

...

1> if the received *measConfig* includes the *measObjectToAddModList*:

2> perform the measurement object addition/modification procedure as specified in 5.5.2.5;

...

1> if the received *measConfig* includes the *reportConfigToAddModList*:

2> perform the reporting configuration addition/modification procedure as specified in 5.5.2.7;

...

- 1> if the received *measConfig* includes the *measIdToAddModList*:
- 2> perform the measurement identity addition/modification procedure as specified in 5.5.2.3;
- ...

[TS 38.331, clause 5.5.3.1]

The UE shall:

- 1> whenever the UE has a *measConfig*, perform RSRP and RSRQ measurements for each serving cell for which *servingCellMO* is configured as follows:
 - 2> if the *reportConfig* associated with at least one *measId* included in the *measIdList* within *VarMeasConfig* contains an *rsType* set to *ssb* and *ssb-ConfigMobility* is configured in the *measObject* indicated by the *servingCellMO*:
 - ...
 - 3> derive serving cell measurement results based on SS/PBCH block, as described in 5.5.3.3;
 - ...
 - 1> for each serving cell for which *servingCellMO* is configured, if the *reportConfig* associated with at least one *measId* included in the *measIdList* within *VarMeasConfig* contains SINR as trigger quantity and/or reporting quantity:
 - 2> if the *reportConfig* contains *rsType* set to *ssb* and *ssb-ConfigMobility* is configured in the *servingCellMO*:
 - ...
 - 3> derive serving cell SINR based on SS/PBCH block, as described in 5.5.3.3;
 - ...

[TS 38.331, clause 5.5.4.1]

If AS security has been activated successfully, the UE shall:

- 1> for each *measId* included in the *measIdList* within *VarMeasConfig*:
 - ...
 - 2> if *reportType* is set to *periodical* and if a (first) measurement result is available:
 - 3> include a measurement reporting entry within the *VarMeasReportList* for this *measId*;
 - 3> set the *numberOfReportsSent* defined within the *VarMeasReportList* for this *measId* to 0;
 - 3> if the *reportAmount* exceeds 1:
 - 4> initiate the measurement reporting procedure, as specified in 5.5.5, immediately after the quantity to be reported becomes available for the NR SpCell;
 - ...
 - 2> upon expiry of the periodical reporting timer for this *measId*:
 - 3> initiate the measurement reporting procedure, as specified in 5.5.5.
 - ...

[TS 38.331, clause 5.5.5.1]



Figure 5.5.5.1-1: Measurement reporting

The purpose of this procedure is to transfer measurement results from the UE to the network. The UE shall initiate this procedure only after successful AS security activation.

For the *measId* for which the measurement reporting procedure was triggered, the UE shall set the *measResults* within the *MeasurementReport* message as follows:

- 1> set the *measId* to the measurement identity that triggered the measurement reporting;
- 1> for each serving cell configured with *servingCellMO*:
 - 2> if the *reportConfig* associated with the *measId* that triggered the measurement reporting includes *rsType*:
 - 3> if the serving cell measurements based on the *rsType* included in the *reportConfig* that triggered the measurement report are available:
 - 4> set the *measResultServingCell* within *measResultServingMOList* to include RSRP, RSRQ and the available SINR of the serving cell, derived based on the *rsType* included in the *reportConfig* that triggered the measurement report;
 - ...
- 1> set the *servCellId* within *measResultServingMOList* to include each NR serving cell that is configured with *servingCellMO*, if any;
- ...
- 1> increment the *numberOfReportsSent* as defined within the *VarMeasReportList* for this *measId* by 1;
- 1> stop the periodical reporting timer, if running;
- 1> if the *numberOfReportsSent* as defined within the *VarMeasReportList* for this *measId* is less than the *reportAmount* as defined within the corresponding *reportConfig* for this *measId*:
 - 2> start the periodical reporting timer with the value of *reportInterval* as defined within the corresponding *reportConfig* for this *measId*;
- 1> else:
 - 2> if the *reportType* is set to *periodical*:
 - 3> remove the entry within the *VarMeasReportList* for this *measId*;
 - 3> remove this *measId* from the *measIdList* within *VarMeasConfig*;
- 1> if the UE is in (NG)EN-DC:
 - 2> if SRB3 is configured:
 - 3> submit the *MeasurementReport* message via SRB3 to lower layers for transmission, upon which the procedure ends;
 - ...

8.2.3.16.1.3 Test description

8.2.3.16.1.3.1 Pre-test conditions

System Simulator:

- E-UTRA Cell 1, NR Cell 1

UE:

- None.

Preamble:

- The UE is in state RRC_CONNECTED using generic procedure parameter Connectivity (*EN-DC*), Bearers (*MCG(s) and SCG*) established according to TS 38.508-1 [4], clause 4.5.4.

8.2.3.16.1.3.2 Test procedure sequence

Table 8.2.3.16.1.3.2-1: Main behaviour

| St | Procedure | Message Sequence | | TP | Verdict |
|----|---|------------------|---|----|---------|
| | | U - S | Message | | |
| 1 | The SS transmits an <i>RRCConnectionReconfiguration</i> to establish SRB3 | <- | EUTRA RRC:
<i>RRCConnectionReconfiguration</i> | - | - |
| 2 | The UE transmits an <i>RRCConnectionReconfigurationComplete</i> message | --> | EUTRA RRC:
<i>RRCConnectionReconfigurationComplete</i> | - | - |
| 3 | The SS transmits an <i>RRCReconfiguration</i> to setup periodical intra-NR measurements and reporting on NR Cell 1 via SRB3 | <- | NR RRC: <i>RRCReconfiguration</i> | - | - |
| 4 | Check: Does the UE transmits an <i>RRCReconfigurationComplete</i> message via SRB3? | --> | NR RRC:
<i>RRCReconfigurationComplete</i> | 1 | P |
| 5 | Check: Does the UE transmits at least 10 <i>MeasurementReport</i> message to periodically report the measured RSRP value for NR Cell 1 via SRB3 within the next 30 seconds? | --> | NR RRC: <i>MeasurementReport</i> | 1 | P |

8.2.3.16.1.3.3 Specific message contents

Table 8.2.3.16.1.3.3-1: RRCConnectionReconfiguration (step 1, Table 8.2.3.16.1.3.2-1)

| Derivation Path: 36.508 [7] Table 4.6.1-8 with Condition EN-DC_Embed_RBConfig | | | |
|---|---|---------|-----------|
| Information Element | Value/remark | Comment | Condition |
| RRCConnectionReconfiguration ::= SEQUENCE { | | | |
| criticalExtensions CHOICE { | | | |
| c1 CHOICE{ | | | |
| rrcConnectionReconfiguration-r8 SEQUENCE { | | | |
| nonCriticalExtension SEQUENCE { | | | |
| nonCriticalExtension SEQUENCE { | | | |
| nonCriticalExtension SEQUENCE { | | | |
| nonCriticalExtension SEQUENCE { | | | |
| nonCriticalExtension SEQUENCE { | | | |
| nonCriticalExtension SEQUENCE { | | | |
| nonCriticalExtension SEQUENCE { | | | |
| nr-RadioBearerConfig1-r15 | OCTET STRING
including
RadioBearerConfig
according to 38.508-1 [4]
table 4.6.3.132 with
Condition SRB3 | | |
| } | | | |
| } | | | |
| } | | | |
| } | | | |
| } | | | |
| } | | | |
| } | | | |
| } | | | |
| } | | | |
| } | | | |

Table 8.2.3.16.1.3.3-2: RRCReconfiguration (Step 3, Table 8.2.3.16.1.3.2-1)

| |
|---|
| Derivation Path: 38.508-1 [4], Table 4.6.1-13 with Condition EN-DC_MEAS |
|---|

Table 8.2.3.16.1.3.3-3: MeasConfig (Table 8.2.3.16.1.3.3-2)

| Derivation Path: TS 38.508-1 [4], Table 4.6.3-69 | | | |
|---|--|---------|-----------|
| Information Element | Value/remark | Comment | Condition |
| MeasConfig ::= SEQUENCE { | | | |
| measObjectToAddModList SEQUENCE (SIZE (1..maxNrofObjectId)) OF MeasObjectToAddMod { | 1 entry | | |
| MeasObjectToAddMod[1] SEQUENCE { | | entry 1 | |
| measObject CHOICE { | | | |
| measObjectNR SEQUENCE { | | | |
| ssbFrequency | ARFCN-ValueNR of NR Cell 1 | | |
| absThreshSS-BlocksConsolidation | Not present | | |
| nrofSS-BlocksToAverage | Not present | | |
| } | | | |
| } | | | |
| } | | | |
| reportConfigToAddModList SEQUENCE (SIZE (1..maxReportConfigId)) OF ReportConfigToAddMod { | 1 entry | | |
| ReportConfigToAddMod[1] SEQUENCE { | | entry 1 | |
| reportConfig CHOICE { | | | |
| reportConfigNR | ReportConfigNR with Condition PERIODICAL | | |
| } | | | |
| } | | | |
| } | | | |
| } | | | |

Table 8.2.3.16.1.3.3-4: MeasurementReport (step 5, Table 8.2.3.16.1.3.2-1)

| Derivation Path: TS 38.508-1 [4], Table 4.6.1-5A | | | |
|--|--------------|------------------------|-----------|
| Information Element | Value/remark | Comment | Condition |
| MeasurementReport ::= SEQUENCE { | | | |
| criticalExtensions CHOICE { | | | |
| measurementReport SEQUENCE { | | | |
| measResults | MeasResults | Table 8.2.3.16.1.3.3-5 | |
| } | | | |
| } | | | |
| } | | | |

Table 8.2.3.16.1.3.3-5: MeasResults (Table 8.2.3.16.1.3.3-4)

| Derivation Path: TS 38.331 [6], clause 6.3.2 | | | |
|---|-------------------------|---------|-----------------|
| Information Element | Value/remark | Comment | Condition |
| MeasResults ::= SEQUENCE { | | | |
| measResultServingMOList ::= SEQUENCE (SIZE (1.. maxNrofServingCells)) OF MeasResultServMO { | 1 entry | | |
| MeasResultServMO[1] SEQUENCE { | | entry 1 | |
| measResultServingCell SEQUENCE { | | | |
| physCellId | PhysCellId of NR Cell 1 | | |
| measResult SEQUENCE { | | | |
| cellResults SEQUENCE { | | | |
| resultsSSB-Cell SEQUENCE { | | | |
| rsrp | (0..127) | | |
| rsrq | (0..127) | | |
| sinr | (0..127) | | pc_ss_SINR_Meas |
| } | | | |
| } | | | |
| } | | | |
| } | | | |
| } | | | |
| } | | | |

8.2.3.16.2 Measurement configuration control and reporting / SRB3 / Intra NR measurements / NR-DC

8.2.3.16.2.1 Test Purpose (TP)

(1)

```
with { UE in NR RRC_CONNECTED state with NR-DC and SCG with SRB3 configured }
ensure that {
  when { UE receives RRCReconfiguration on SRB3 including MeasConfig to setup periodical measurement reporting }
  then { UE sends RRCReconfigurationComplete and starts sending periodic measurement reports over SRB3 }
}
```

8.2.3.16.2.2 Conformance requirements

References: The conformance requirements covered in the present TC are specified in: TS 36.331, clauses 5.3.5.3, TS 38.331, clause 5.5.4.1, 5.5.4.7 and 5.5.5.1. Unless otherwise stated these are Rel-15 requirements.

[TS 38.331, 5.3.5.3]

The UE shall perform the following actions upon reception of the *RRCReconfiguration*:

...

- 1> if the *RRCReconfiguration* includes the *secondaryCellGroup*:
 - 2> perform the cell group configuration for the SCG according to 5.3.5.5;
- 1> if the *RRCReconfiguration* includes the *mrdc-SecondaryCellGroupConfig*:
 - 2> if the *mrdc-SecondaryCellGroupConfig* is set to *setup*:
 - 3> if the *mrdc-SecondaryCellGroupConfig* includes *mrdc-ReleaseAndAdd*:
 - 4> perform MR-DC release as specified in clause 5.3.5.10;
 - 3> if the received *mrdc-SecondaryCellGroup* is set to *nr-SCG*:

4> perform the RRC reconfiguration according to 5.3.5.3 for the *RRCReconfiguration* message included in *nr-SCG*;

...

1> if the *RRCReconfiguration* message includes the *radioBearerConfig*:

2> perform the radio bearer configuration according to 5.3.5.6;

...

1> set the content of the *RRCReconfigurationComplete* message as follows:

...

2> if the *RRCReconfiguration* message includes the *mrdc-SecondaryCellGroupConfig* with *mrdc-SecondaryCellGroup* set to *nr-SCG*:

3> include in the *nr-SCG-Response* the *RRCReconfigurationComplete* message;

...

1> else if the *RRCReconfiguration* message was received within the *nr-SCG* within *mrdc-SecondaryCellGroup* (UE in NR-DC, *mrdc-SecondaryCellGroup* was received in *RRCReconfiguration* via SRB1):

2> if *reconfigurationWithSync* was included in *spCellConfig* in *nr-SCG*:

3> initiate the Random Access procedure on the PSCell, as specified in TS 38.321 [3];

2> else

3> the procedure ends;

NOTE 2a: The order in which the UE sends the *RRCReconfigurationComplete* message and performs the Random Access procedure towards the SCG is left to UE implementation.

1> else if the *RRCReconfiguration* message was received via SRB3 (UE in NR-DC):

2> submit the *RRCReconfigurationComplete* message via SRB3 to lower layers for transmission using the new configuration;

1> else (*RRCReconfiguration* was received via SRB1):

2> submit the *RRCReconfigurationComplete* message via SRB1 to lower layers for transmission using the new configuration;

...

1> if *reconfigurationWithSync* was included in *spCellConfig* of an MCG or SCG, and when MAC of an NR cell group successfully completes a Random Access procedure triggered above;

2> stop timer T304 for that cell group;

2> apply the parts of the CSI reporting configuration, the scheduling request configuration and the sounding RS configuration that do not require the UE to know the SFN of the respective target SpCell, if any;

2> apply the parts of the measurement and the radio resource configuration that require the UE to know the SFN of the respective target SpCell (e.g. measurement gaps, periodic CQI reporting, scheduling request configuration, sounding RS configuration), if any, upon acquiring the SFN of that target SpCell;

...

[TS 38.331, clause 5.5.2.1]

The UE shall:

...

- 1> if the received *measConfig* includes the *measObjectToAddModList*:
 - 2> perform the measurement object addition/modification procedure as specified in 5.5.2.5;
- ...
- 1> if the received *measConfig* includes the *reportConfigToAddModList*:
 - 2> perform the reporting configuration addition/modification procedure as specified in 5.5.2.7;
- ...
- 1> if the received *measConfig* includes the *measIdToAddModList*:
 - 2> perform the measurement identity addition/modification procedure as specified in 5.5.2.3;
- ...

[TS 38.331, clause 5.5.3.1]

The UE shall:

- 1> whenever the UE has a *measConfig*, perform RSRP and RSRQ measurements for each serving cell for which *servingCellMO* is configured as follows:
 - 2> if the *reportConfig* associated with at least one *measId* included in the *measIdList* within *VarMeasConfig* contains an *rsType* set to *ssb* and *ssb-ConfigMobility* is configured in the *measObject* indicated by the *servingCellMO*:
 - ...
 - 3> derive serving cell measurement results based on SS/PBCH block, as described in 5.5.3.3;
 - ...
- 1> for each serving cell for which *servingCellMO* is configured, if the *reportConfig* associated with at least one *measId* included in the *measIdList* within *VarMeasConfig* contains SINR as trigger quantity and/or reporting quantity:
 - 2> if the *reportConfig* contains *rsType* set to *ssb* and *ssb-ConfigMobility* is configured in the *servingCellMO*:
 - ...
 - 3> derive serving cell SINR based on SS/PBCH block, as described in 5.5.3.3;
 - ...

[TS 38.331, clause 5.5.4.1]

If AS security has been activated successfully, the UE shall:

- 1> for each *measId* included in the *measIdList* within *VarMeasConfig*:
 - ...
 - 2> if *reportType* is set to *periodical* and if a (first) measurement result is available:
 - 3> include a measurement reporting entry within the *VarMeasReportList* for this *measId*;
 - 3> set the *numberOfReportsSent* defined within the *VarMeasReportList* for this *measId* to 0;
 - 3> if the *reportAmount* exceeds 1:
 - 4> initiate the measurement reporting procedure, as specified in 5.5.5, immediately after the quantity to be reported becomes available for the NR SpCell;
 - ...

- 2> upon expiry of the periodical reporting timer for this *measId*:
- 3> initiate the measurement reporting procedure, as specified in 5.5.5.
- ...

[TS 38.331, clause 5.5.5.1]



Figure 5.5.5.1-1: Measurement reporting

The purpose of this procedure is to transfer measurement results from the UE to the network. The UE shall initiate this procedure only after successful AS security activation.

For the *measId* for which the measurement reporting procedure was triggered, the UE shall set the *measResults* within the *MeasurementReport* message as follows:

- 1> set the *measId* to the measurement identity that triggered the measurement reporting;
- 1> for each serving cell configured with *servingCellMO*:
 - 2> if the *reportConfig* associated with the *measId* that triggered the measurement reporting includes *rsType*:
 - 3> if the serving cell measurements based on the *rsType* included in the *reportConfig* that triggered the measurement report are available:
 - 4> set the *measResultServingCell* within *measResultServingMOList* to include RSRP, RSRQ and the available SINR of the serving cell, derived based on the *rsType* included in the *reportConfig* that triggered the measurement report;
 - ...
- 1> set the *servCellId* within *measResultServingMOList* to include each NR serving cell that is configured with *servingCellMO*, if any;
- ...
- 1> increment the *numberOfReportsSent* as defined within the *VarMeasReportList* for this *measId* by 1;
- 1> stop the periodical reporting timer, if running;
- 1> if the *numberOfReportsSent* as defined within the *VarMeasReportList* for this *measId* is less than the *reportAmount* as defined within the corresponding *reportConfig* for this *measId*:
 - 2> start the periodical reporting timer with the value of *reportInterval* as defined within the corresponding *reportConfig* for this *measId*;
- 1> else:
 - 2> if the *reportType* is set to *periodical*:
 - 3> remove the entry within the *VarMeasReportList* for this *measId*;
 - 3> remove this *measId* from the *measIdList* within *VarMeasConfig*;
- 1> if the UE is in (NG)EN-DC:
 - 2> if SRB3 is configured:

3> submit the *MeasurementReport* message via SRB3 to lower layers for transmission, upon which the procedure ends;

...

8.2.3.16.2.3 Test description

8.2.3.16.2.3.1 Pre-test conditions

System Simulator:

- NR Cell 1 is the PCell and NR Cell 10 is the PSCell
- System information combination NR-4 as defined in TS 38.508-1 [4] clause 4.4.3.1.2 is used in NR cells.

UE:

- None.

Preamble:

- The UE is in state RRC_CONNECTED using generic procedure parameter Connectivity (*NR-DC*) according to TS 38.508-1 [4], Table 4.5.1-1.

8.2.3.16.2.3.2 Test procedure sequence

Table 8.2.3.16.2.3.2-1: Main behaviour

| St | Procedure | Message Sequence | | TP | Verdict |
|----|---|------------------|--|----|---------|
| | | U - S | Message | | |
| 1 | The SS transmits an <i>RRCReconfiguration</i> message via SRB1 to establish SRB3 | <- | NR RRC: <i>RRCReconfiguration</i> | - | - |
| 2 | The UE transmits an <i>RRCReconfigurationComplete</i> message via SRB 1. | --> | NR RRC:
<i>RRCReconfigurationComplete</i> | - | - |
| 3 | The SS transmits an <i>RRCReconfiguration</i> message from Cell 10 to setup periodical intra-NR measurements and reporting via SRB3 | <- | NR RRC: <i>RRCReconfiguration</i> | - | - |
| 4 | Check: Does the UE transmits an <i>RRCReconfigurationComplete</i> message via SRB3? | --> | NR RRC:
<i>RRCReconfigurationComplete</i> | 1 | P |
| 5 | Check: Does the UE transmits at least 10 <i>MeasurementReport</i> message to periodically report the measured RSRP value for Cell 10 via SRB3 within the next 30 seconds? | --> | NR RRC: <i>MeasurementReport</i> | 1 | P |

8.2.3.16.2.3.3 Specific message contents

Table 8.2.3.16.2.3.3-1: RRCReconfiguration (step 1, Table 8.2.3.16.2.3.2-1)

| Derivation Path: TS 38.508-1 [4], Table 4.6.1-13 with condition NR-DC | | | |
|---|--|------------------------|-----------|
| Information Element | Value/remark | Comment | Condition |
| RRCReconfiguration ::= SEQUENCE { | | | |
| criticalExtensions CHOICE { | | | |
| rrcReconfiguration SEQUENCE { | | | |
| radioBearerConfig | Not present | | |
| nonCriticalExtension SEQUENCE { | | | |
| masterCellGroup | Not present | | |
| nonCriticalExtension SEQUENCE { | | | |
| nonCriticalExtension SEQUENCE { | | | |
| mrdc-SecondaryCellGroupConfig CHOICE { | | | |
| setup SEQUENCE { | | | |
| mrdc-SecondaryCellGroup CHOICE { | | | |
| nr-SCG | RRCReconfiguration-SCG | Table 8.2.3.16.2.3.3-2 | |
| } | | | |
| } | | | |
| } | | | |
| radioBearerConfig2 | OCTET STRING (CONTAINING RadioBearerConfig specified in TS 38.508-1 [4] Table 4.6.3-132 with condition SRB3) | | |
| } | | | |
| } | | | |
| } | | | |
| } | | | |
| } | | | |

Table 8.2.3.16.2.3.3-2: RRCReconfiguration-SCG (Table 8.2.3.16.2.3.3-1)

| Derivation Path: TS 38.508-1 [4], Table 4.6.1-13 with condition NR-DC_SCG | | | |
|---|-----------------|------------------------|-----------|
| Information Element | Value/remark | Comment | Condition |
| RRCReconfiguration ::= SEQUENCE { | | | |
| criticalExtensions CHOICE { | | | |
| rrcReconfiguration SEQUENCE { | | | |
| secondaryCellGroup | CellGroupConfig | Table 8.2.3.16.2.3.3-3 | |
| } | | | |
| } | | | |
| } | | | |

Table 8.2.3.16.2.3.3-3: CellGroupConfig (Table 8.2.3.16.2.3.3-2)

| Derivation Path: 38.508-1 [4], Table 4.6.3-19 | | | |
|---|--------------------------------------|---------|-----------|
| Information Element | Value/remark | Comment | Condition |
| CellGroupConfig ::= SEQUENCE { | | | |
| cellGroupId | CellGroupId condition NR-DC_SCG | | |
| rlc-BearerToAddModList SEQUENCE (SIZE(1..maxLC-ID)) OF RLC-BearerConfig { | 1 entry | | |
| RLC-BearerConfig[1] | RLC-BearerConfig with condition SRB3 | entry 1 | |
| } | | | |
| mac-CellGroupConfig | Not Present | | |
| physicalCellGroupConfig | Not Present | | |
| spCellConfig | Not Present | | |
| } | | | |

Table 8.2.3.16.2.3.3-4: RRCReconfiguration (Step 3, Table 8.2.3.16.2.3.2-1)

Derivation Path: 38.508-1 [4], Table 4.6.1-13 with Condition NR_MEAS

Table 8.2.3.16.2.3.3-5: MeasConfig (Table 8.2.3.16.2.3.3-4)

| Derivation Path: TS 38.508-1 [4], Table 4.6.3-69 | | | |
|---|--|---------|-----------|
| Information Element | Value/remark | Comment | Condition |
| MeasConfig ::= SEQUENCE { | | | |
| measObjectToAddModList SEQUENCE (SIZE (1..maxNrofObjectId)) OF MeasObjectToAddMod { | 1 entry | | |
| MeasObjectToAddMod[1] SEQUENCE { | | entry 1 | |
| measObject CHOICE { | | | |
| measObjectNR SEQUENCE { | | | |
| ssbFrequency | ARFCN-ValueNR of NR Cell 10 | | |
| absThreshSS-BlocksConsolidation | Not present | | |
| nrofSS-BlocksToAverage | Not present | | |
| } | | | |
| } | | | |
| } | | | |
| reportConfigToAddModList SEQUENCE (SIZE (1..maxReportConfigId)) OF ReportConfigToAddMod { | 1 entry | | |
| ReportConfigToAddMod[1] SEQUENCE { | | entry 1 | |
| reportConfig CHOICE { | | | |
| reportConfigNR | ReportConfigNR with Condition PERIODICAL | | |
| } | | | |
| } | | | |
| } | | | |
| } | | | |

Table 8.2.3.16.2.3.3-6: MeasurementReport (step 5, Table 8.2.3.16.2.3.2-1)

| Derivation Path: TS 38.508-1 [4], Table 4.6.1-5A | | | |
|--|--------------|---------------------------|-----------|
| Information Element | Value/remark | Comment | Condition |
| MeasurementReport ::= SEQUENCE { | | | |
| criticalExtensions CHOICE { | | | |
| measurementReport SEQUENCE { | | | |
| measResults | MeasResults | Table
8.2.3.16.2.3.3-7 | |
| } | | | |
| } | | | |
| } | | | |

Table 8.2.3.16.2.3.3-7: MeasResults (Table 8.2.3.16.2.3.3-6)

| Derivation Path: TS 38.508-1 [4], Table 4.6.3-79 | | | |
|--|--------------------------|---------|--------------------|
| Information Element | Value/remark | Comment | Condition |
| MeasResults ::= SEQUENCE { | | | |
| measResultServingMOList SEQUENCE (SIZE (1..maxNrofServingCells)) OF MeasResultServMO { | 1 entry | | |
| MeasResultServMO[1] SEQUENCE { | | entry 1 | |
| measResultServingCell SEQUENCE { | | | |
| physCellId | PhysCellId of NR Cell 10 | | |
| measResult SEQUENCE { | | | |
| cellResults SEQUENCE { | | | |
| resultsSSB-Cell SEQUENCE { | | | |
| rsrp | (0..127) | | |
| rsrq | (0..127) | | |
| sinr | (0..127) | | pc_ss_SINR
Meas |
| } | | | |
| } | | | |
| } | | | |
| } | | | |
| } | | | |
| } | | | |

8.2.4 Carrier Aggregation

8.2.4.1 NR CA / NR SCell addition / modification / release / Success

8.2.4.1.1 NR CA / NR SCell addition / modification / release / Success / EN-DC

8.2.4.1.1.1 NR CA / NR SCell addition / modification / release / Success / EN-DC / Intra-band Contiguous CA

8.2.4.1.1.1.1 Test Purpose (TP)

(1)

```

with { UE in RRC_CONNECTED state with EN-DC, and, MCG(s) (E-UTRA PDCP) and SCG with initial AS
security activated }
ensure that {
  when { UE receives an RRCConnectionReconfiguration message with nr-Config IE including NR
RRCReconfiguration message containing sCellToAddModList with an sCellIndex set to the configured
Scell }
  then { UE adds the new SCell, configures lower layers to consider the SCell to be in deactivated
state and sends an RRCConnectionReconfigurationComplete message }
}

```

(2)

```

with { UE in RRC_CONNECTED state with EN-DC, and, MCG(s) (E-UTRA PDCP) and SCG with SCell(s)
configured }
ensure that {
  when { UE receives an RRCConnectionReconfiguration message with nr-Config IE including NR
RRCReconfiguration message containing sCellToAddModList with an sCellIndex matching one of the
current UE SCell configuration }
  then { UE modifies the affected SCell dedicated configurations and sends an
RRCConnectionReconfigurationComplete message }
}

```

(3)

```

with { UE in RRC_CONNECTED state with EN-DC, and, MCG(s) (E-UTRA PDCP) and SCG with SCell(s)
configured }
ensure that {
  when { UE receives an RRCConnectionReconfiguration message with nr-Config IE including NR
RRCReconfiguration message containing sCellToReleaseList with an sCellIndex matching one of the
current UE SCell configuration }
  then { UE releases the SCell and sends an RRCConnectionReconfigurationComplete message }
}

```

8.2.4.1.1.1.2 Conformance requirements

References: The conformance requirements covered in the present TC are specified in: TS 36.331: 5.3.5.3; TS 38.331: 5.3.5.3, 5.3.5.5.8, 5.3.5.5.9. Unless otherwise stated these are Rel-15 requirements.

[TS 36.331, clause 5.3.5.3]

If the *RRCConnectionReconfiguration* message does not include the *mobilityControlInfo* and the UE is able to comply with the configuration included in this message, the UE shall:

- 1> if this is the first *RRCConnectionReconfiguration* message after successful completion of the RRC connection re-establishment procedure:
 - 2> re-establish PDCP for SRB2 configured with E-UTRA PDCP entity and for all DRBs that are established and configured with E-UTRA PDCP, if any;
 - 2> re-establish RLC for SRB2 and for all DRBs that are established and configured with E-UTRA RLC, if any;
 - 2> if the *RRCConnectionReconfiguration* message includes the *fullConfig*:
 - 3> perform the radio configuration procedure as specified in 5.3.5.8;
 - 2> if the *RRCConnectionReconfiguration* message includes the *radioResourceConfigDedicated*:
 - 3> perform the radio resource configuration procedure as specified in 5.3.10;

NOTE 1: Void

NOTE 2: Void

1> else:

- 2> if the *RRCConnectionReconfiguration* message includes the *radioResourceConfigDedicated*:
 - 3> perform the radio resource configuration procedure as specified in 5.3.10;

NOTE 3: If the *RRCConnectionReconfiguration* message includes the establishment of radio bearers other than SRB1, the UE may start using these radio bearers immediately, i.e. there is no need to wait for an outstanding acknowledgment of the *SecurityModeComplete* message.

- 1> if the received *RRCConnectionReconfiguration* includes the *sCellToReleaseList*:
 - 2> perform SCell release as specified in 5.3.10.3a;
- 1> if the received *RRCConnectionReconfiguration* includes the *sCellToAddModList*:

- 2> perform SCell addition or modification as specified in 5.3.10.3b;
- 1> if the received *RRCCConnectionReconfiguration* includes the *scg-Configuration*; or
- 1> if the current UE configuration includes one or more split DRBs configured with *pdcp-Config* and the received *RRCCConnectionReconfiguration* includes *radioResourceConfigDedicated* including *drb-ToAddModList*:
 - 2> perform SCG reconfiguration as specified in 5.3.10.10;
- 1> if the received *RRCCConnectionReconfiguration* includes the *nr-Config* and it is set to *release*: or
- 1> if the received *RRCCConnectionReconfiguration* includes *endc-ReleaseAndAdd* and it is set to *TRUE*:
 - 2> perform EN-DC release as specified in TS 38.331 [82], clause 5.3.5.10;
- 1> if the received *RRCCConnectionReconfiguration* includes the *sk-Counter*:
 - 2> perform key update procedure as specified in TS 38.331 [82], clause 5.3.5.7;
- 1> if the received *RRCCConnectionReconfiguration* includes the *nr-SecondaryCellGroupConfig*:
 - 2> perform NR RRC Reconfiguration as specified in TS 38.331 [82], clause 5.3.5.3;
- 1> if the received *RRCCConnectionReconfiguration* includes the *nr-RadioBearerConfig1*:
 - 2> perform radio bearer configuration as specified in TS 38.331 [82], clause 5.3.5.6;
- 1> if the received *RRCCConnectionReconfiguration* includes the *nr-RadioBearerConfig2*:
 - 2> perform radio bearer configuration as specified in TS 38.331 [82], clause 5.3.5.6;
- 1> if this is the first *RRCCConnectionReconfiguration* message after successful completion of the RRC connection re-establishment procedure:
 - 2> resume SRB2 and all DRBs that are suspended, if any, including RBs configured with NR PDCP;

NOTE 4: The handling of the radio bearers after the successful completion of the PDCP re-establishment, e.g. the re-transmission of unacknowledged PDCP SDUs (as well as the associated status reporting), the handling of the SN and the HFN, is specified in TS 36.323 [8].

NOTE 5: The UE may discard SRB2 messages and data that it receives prior to completing the reconfiguration used to resume these bearers.

- 1> if the received *RRCCConnectionReconfiguration* includes the *systemInformationBlockType1Dedicated*:
 - 2> perform the actions upon reception of the *SystemInformationBlockType1* message as specified in 5.2.2.7;
- 1> if the *RRCCConnectionReconfiguration* message includes the *dedicatedInfoNASList*:
 - 2> forward each element of the *dedicatedInfoNASList* to upper layers in the same order as listed;
- 1> if the *RRCCConnectionReconfiguration* message includes the *measConfig*:
 - 2> perform the measurement configuration procedure as specified in 5.5.2;
- 1> perform the measurement identity autonomous removal as specified in 5.5.2.2a;
- 1> if the *RRCCConnectionReconfiguration* message includes the *otherConfig*:
 - 2> perform the other configuration procedure as specified in 5.3.10.9;
- 1> upon RRC connection establishment, if UE does not need UL gaps during continuous uplink transmission:
 - 2> configure lower layers to stop using UL gaps during continuous uplink transmission in FDD for *RRCCConnectionReconfigurationComplete* message and subsequent uplink transmission in RRC_CONNECTED except for UL transmissions as specified in TS36.211 [21];
- 1> set the content of *RRCCConnectionReconfigurationComplete* message as follows:

- 2> if the *RRCCONNECTIONRECONFIGURATION* message includes *perCC-GapIndicationRequest*:
 - 3> include *perCC-GapIndicationList* and *numFreqEffective*;
- 2> if the frequencies are configured for reduced measurement performance:
 - 3> include *numFreqEffectiveReduced*;
- 2> if the received *RRCCONNECTIONRECONFIGURATION* message included *nr-SecondaryCellGroupConfig*:
 - 3> include *scg-ConfigResponseNR* in accordance with TS 38.331 [82, 5.3.5.3];
- 1> submit the *RRCCONNECTIONRECONFIGURATIONCOMPLETE* message to lower layers for transmission using the new configuration, upon which the procedure ends;

[TS 38.331, clause 5.3.5.3]

The UE shall perform the following actions upon reception of the *RRCRECONFIGURATION*:

- 1> if the *RRCRECONFIGURATION* includes the *fullConfig*:
 - 2> perform the radio configuration procedure as specified in 5.3.5.11;
- 1> if the *RRCRECONFIGURATION* includes the *masterCellGroup*:
 - 2> perform the cell group configuration for the received *masterCellGroup* according to 5.3.5.5;
- 1> if the *RRCRECONFIGURATION* includes the *masterKeyUpdate*:
 - 2> perform security key update procedure as specified in 5.3.5.7;
- 1> if the *RRCRECONFIGURATION* includes the *secondaryCellGroup*:
 - 2> perform the cell group configuration for the SCG according to 5.3.5.5;
- 1> if the *RRCRECONFIGURATION* message contains the *radioBearerConfig*:
 - 2> perform the radio bearer configuration according to 5.3.5.6;
- 1> if the *RRCRECONFIGURATION* message includes the *measConfig*:
 - 2> perform the measurement configuration procedure as specified in 5.5.2;
- 1> if the *RRCRECONFIGURATION* message includes the *dedicatedNAS-MessageList*:
 - 2> forward each element of the *dedicatedNAS-MessageList* to upper layers in the same order as listed;
- 1> if the *RRCRECONFIGURATION* message includes the *dedicatedSIB1-Delivery*:
 - 2> perform the action upon reception of *SIB1* as specified in 5.2.2.4.2;
- 1> if the *RRCRECONFIGURATION* message includes the *dedicatedSystemInformationDelivery*:
 - 2> perform the action upon reception of System Information as specified in 5.2.2.4;
- 1> set the content of *RRCRECONFIGURATIONCOMPLETE* message as follows:
 - 2> if the *RRCRECONFIGURATION* includes the *masterCellGroup* containing the *reportUplinkTxDirectCurrent*, or;
 - 2> if the *RRCRECONFIGURATION* includes the *secondaryCellGroup* containing the *reportUplinkTxDirectCurrent*:
 - 3> include the *uplinkTxDirectCurrentList*;
- 1> if the UE is configured with E-UTRA *nr-SecondaryCellGroupConfig* (MCG is E-UTRA):
 - 2> if *RRCRECONFIGURATION* was received via SRB1:
 - 3> submit the *RRCRECONFIGURATIONCOMPLETE* via the EUTRA MCG embedded in E-UTRA RRC message *RRCCONNECTIONRECONFIGURATIONCOMPLETE* as specified in TS 36.331 [10];

3> if *reconfigurationWithSync* was included in *spCellConfig* of an SCG:

4> initiate the random access procedure on the SpCell, as specified in TS 38.321 [3];

3> else:

4> the procedure ends;

NOTE: The order the UE sends the *RRCConnectionReconfigurationComplete* message and performs the Random Access procedure towards the SCG is left to UE implementation.

2> else (*RRCReconfiguration* was received via SRB3):

3> submit the *RRCReconfigurationComplete* message via SRB3 to lower layers for transmission using the new configuration;

NOTE: For EN-DC, in the case *RRCReconfiguration* is received via SRB1, the random access is triggered by RRC layer itself as there is not necessarily other UL transmission. In the case *RRCReconfiguration* is received via SRB3, the random access is triggered by the MAC layer due to arrival of *RRCReconfigurationComplete*.

1 > else:

2> submit the *RRCReconfigurationComplete* message via SRB1 to lower layers for transmission using the new configuration;

2> if this is the first *RRCReconfiguration* message after successful completion of the RRC re-establishment procedure:

3> resume SRB2 and DRBs that are suspended;

1> if *reconfigurationWithSync* was included in *spCellConfig* of an MCG or SCG, and when MAC of an NR cell group successfully completes a random access procedure triggered above;

2> stop timer T304 for that cell group;

2> apply the parts of the CQI reporting configuration, the scheduling request configuration and the sounding RS configuration that do not require the UE to know the SFN of the respective target SpCell, if any;

2> apply the parts of the measurement and the radio resource configuration that require the UE to know the SFN of the respective target SpCell (e.g. measurement gaps, periodic CQI reporting, scheduling request configuration, sounding RS configuration), if any, upon acquiring the SFN of that target SpCell;

2> if the *reconfigurationWithSync* was included in *spCellConfig* of an MCG:

3> if T390 is running:

4> stop timer T390 for all access categories;

4> perform the actions as specified in 5.3.14.4.

3> if *RRCReconfiguration* does not include *dedicatedSIB1-Delivery* and

3> if the active downlink BWP, which is indicated by the *firstActiveDownlinkBWP-Id* for the target SpCell of the MCG, has a common search space configured by *searchSpaceSIB1*:

4> acquire the *SIB1*, which is scheduled as specified in TS 38.213 [13], of the target SpCell of the MCG;

4> upon acquiring *SIB1*, perform the actions specified in clause 5.2.2.4.2;

2> the procedure ends.

NOTE: The UE is only required to acquire broadcasted *SIB1* if the UE can acquire it without disrupting unicast data reception, i.e. the broadcast and unicast beams are quasi co-located.

[TS 38.331, clause 5.3.5.5.8]

The UE shall:

- 1> if the release is triggered by reception of the *sCellToReleaseList*:
- 2> for each *sCellIndex* value included in the *sCellToReleaseList*:
- 3> if the current UE configuration includes an SCell with value *sCellIndex*:
- 4> release the SCell.

[TS 38.331, clause 5.3.5.5.9]

The UE shall:

- 1> for each *sCellIndex* value included in the *sCellToAddModList* that is not part of the current UE configuration (SCell addition):
- 2> add the SCell, corresponding to the *sCellIndex*, in accordance with the *sCellConfigCommon* and *sCellConfigDedicated*;
- 2> configure lower layers to consider the SCell to be in deactivated state;

Editor's Note: FFS Check automatic measurement handling for SCells.

- 2> for each *measId* included in the *measIdList* within *VarMeasConfig*:
 - 3> if SCells are not applicable for the associated measurement; and
 - 3> if the concerned SCell is included in *cellsTriggeredList* defined within the *VarMeasReportList* for this *measId*:
 - 4> remove the concerned SCell from *cellsTriggeredList* defined within the *VarMeasReportList* for this *measId*;
- 1> for each *sCellIndex* value included in the *sCellToAddModList* that is part of the current UE configuration (SCell modification):
 - 1> modify the SCell configuration in accordance with the *sCellConfigDedicated*.

8.2.4.1.1.1.3 Test description

8.2.4.1.1.1.3.1 Pre-test conditions

System Simulator:

- E-UTRA Cell 1 is the PCell. NR Cell 1 is the PSCell and NR Cell 3 is the SCell.

UE:

- None.

Preamble:

- If *pc_IP_Ping* is set to TRUE then, the UE is in state RRC_CONNECTED using generic procedure parameter Connectivity (*EN-DC*), Bearers (*MCG(s)* and *SCG*) established according to TS 38.508-1 [4], clause 4.5.4.
- Else, the UE is in state RRC_CONNECTED using generic procedure parameter Connectivity (*EN-DC*), Bearers (*MCG(s)* and *SCG*) established and Test Loop Function (On) with UE test loop mode B according to TS 38.508-1 [4], clause 4.5.4.

8.2.4.1.1.3.2 Test procedure sequence

Table 8.2.4.1.1.3.2-1: Main behaviour

| St | Procedure | Message Sequence | | TP | Verdict |
|----|---|------------------|--|----|---------|
| | | U - S | Message | | |
| 1 | The SS transmits a <i>RRCConnectionReconfiguration</i> message including NR <i>RRCReconfiguration</i> message to configure the NR SCell | <-- | <i>RRCConnectionReconfiguration</i>
(<i>RRCReconfiguration</i>) | - | - |
| 2 | Check: Does the UE transmit a <i>RRCConnectionReconfigurationComplete</i> message containing <i>RRCReconfigurationComplete</i> message? | --> | <i>RRCConnectionReconfigurationComplete</i>
(<i>RRCReconfigurationComplete</i>) | 1 | P |
| 2A | Check: Does the test result of generic test procedure in TS 38.508-1 Table 4.9.1-1A indicate that the UE is capable of exchanging IP data on DRB #n associated with the first PDU session on NR Cell 3? | | | | |
| 3 | The SS transmits a <i>RRCConnectionReconfiguration</i> message including NR <i>RRCReconfiguration</i> message to modify the <i>startingBitOfFormat2-3</i> of the NR SCell | <-- | <i>RRCConnectionReconfiguration</i>
(<i>RRCReconfiguration</i>) | - | - |
| 4 | Check: Does the UE transmit a <i>RRCConnectionReconfigurationComplete</i> message containing NR <i>RRCReconfigurationComplete</i> message? | --> | <i>RRCConnectionReconfigurationComplete</i>
(<i>RRCReconfigurationComplete</i>) | 2 | P |
| 4A | Check: Does the test result of generic test procedure in TS 38.508-1 Table 4.9.1-1A indicate that the UE is capable of exchanging IP data on DRB #n associated with the first PDU session on NR Cell 3? | | | | |
| 5 | The SS transmits a <i>RRCConnectionReconfiguration</i> message including NR <i>RRCReconfiguration</i> message to release the NR SCell | <-- | <i>RRCConnectionReconfiguration</i>
(<i>RRCReconfiguration</i>) | - | - |
| 6 | Check: Does the UE release SCell and sends a <i>RRCConnectionReconfigurationComplete</i> message containing NR <i>RRCReconfigurationComplete</i> message? | --> | <i>RRCConnectionReconfigurationComplete</i>
(<i>RRCReconfigurationComplete</i>) | 3 | P |

8.2.4.1.1.1.3.3 Specific message contents

Table 8.2.4.1.1.1.3.3-1: RRCConnectionReconfiguration (step 1, Table 8.2.4.1.1.1.3.2-1)

| Derivation Path: 36.508 [7], Table 4.6.1-8 with condition EN-DC_NR_CA | | | |
|---|---|---------|-----------|
| Information Element | Value/remark | Comment | Condition |
| RRCConnectionReconfiguration ::= SEQUENCE { | | | |
| criticalExtensions CHOICE { | | | |
| c1 CHOICE{ | | | |
| rrcConnectionReconfiguration-r8 SEQUENCE { | | | |
| nonCriticalExtension SEQUENCE { | | | |
| nonCriticalExtension SEQUENCE { | | | |
| nonCriticalExtension SEQUENCE { | | | |
| nonCriticalExtension SEQUENCE { | | | |
| nonCriticalExtension SEQUENCE { | | | |
| nonCriticalExtension SEQUENCE { | | | |
| nonCriticalExtension SEQUENCE { | | | |
| nr-Config-r15 CHOICE { | | | |
| setup SEQUENCE { | | | |
| nr-SecondaryCellGroupConfig-r15 | OCTET STRING including the <i>RRCReconfiguration</i> message and the IE <i>secondaryCellGroup</i> . | | |
| } | | | |
| } | | | |
| } | | | |
| } | | | |
| } | | | |
| } | | | |
| } | | | |
| } | | | |

Table 8.2.4.1.1.1.3.3-2: RRCReconfiguration (Table 8.2.4.1.1.1.3.3-1)

| Derivation Path: 38.508-1 [4], Table 4.6.1-13 | | | |
|---|-----------------|---------|-----------|
| Information Element | Value/remark | Comment | Condition |
| RRCReconfiguration ::= SEQUENCE { | | | |
| criticalExtensions CHOICE { | | | |
| rrcReconfiguration SEQUENCE { | | | |
| secondaryCellGroup | CellGroupConfig | | |
| } | | | |
| } | | | |

Table 8.2.4.1.1.1.3.3-3: CellGroupConfig (Table 8.2.4.1.1.1.3.3-2)

| Derivation Path: TS 38.508-1 [4], Table 4.6.3-19 With condition SCell_Add | | | |
|---|-------------------------|---------------------------------|-----------|
| Information Element | Value/remark | Comment | Condition |
| CellGroupConfig ::= SEQUENCE { | | | |
| sCellToAddModList SEQUENCE (SIZE (1..maxMeasId)) OF SCellConfig { | 1 entry | | |
| SCellConfig[1] SEQUENCE { | | entry 1 | |
| sCellIndex | 1 | | |
| sCellConfigCommon | ServingCellConfigCommon | | |
| sCellConfigDedicated | ServingCellConfig | TS 38.508-1 [4] table 4.6.3-167 | |
| } | | | |
| } | | | |
| } | | | |

Table 8.2.4.1.1.1.3.3-4: ServingCellConfigCommon (Table 8.2.4.1.1.1.3.3-3)

| Derivation Path: TS 38.508-1 [4], Table 4.6.3-168. | | | |
|--|-------------------------------------|---------|-----------|
| Information Element | Value/remark | Comment | Condition |
| ServingCellConfigCommon ::= SEQUENCE { | | | |
| PhysCellId | Physical Cell Identity of NR Cell 3 | | |
| } | | | |

Table 8.2.4.1.1.1.3.3-5: RRCConnectionReconfiguration (step 3, Table 8.2.4.1.1.1.3.2-1)

| Derivation Path: 36.508 [7], Table 4.6.1-8 with condition EN-DC_NR_CA | | | |
|---|--|---------|-----------|
| Information Element | Value/remark | Comment | Condition |
| RRCConnectionReconfiguration ::= SEQUENCE { | | | |
| criticalExtensions CHOICE { | | | |
| c1 CHOICE { | | | |
| rrcConnectionReconfiguration-r8 SEQUENCE { | | | |
| nonCriticalExtension SEQUENCE { | | | |
| nonCriticalExtension SEQUENCE { | | | |
| nonCriticalExtension SEQUENCE { | | | |
| nonCriticalExtension SEQUENCE { | | | |
| nonCriticalExtension SEQUENCE { | | | |
| nonCriticalExtension SEQUENCE { | | | |
| nonCriticalExtension SEQUENCE { | | | |
| nr-Config-r15 CHOICE { | | | |
| setup SEQUENCE { | | | |
| nr-SecondaryCellGroupConfig-r15 | OCTET STRING including the RRCReconfiguration message and the IE secondaryCellGroup. | | |
| } | | | |
| } | | | |
| } | | | |
| } | | | |
| } | | | |
| } | | | |
| } | | | |
| } | | | |
| } | | | |
| } | | | |
| } | | | |

Table 8.2.4.1.1.1.3.3-6: RRCReconfiguration (Table 8.2.4.1.1.1.3.3-5)

| Derivation Path: 38.508-1 [4], Table 4.6.1-13 | | | |
|---|-----------------|---------|-----------|
| Information Element | Value/remark | Comment | Condition |
| RRCReconfiguration ::= SEQUENCE { | | | |
| criticalExtensions CHOICE { | | | |
| rrcReconfiguration SEQUENCE { | | | |
| secondaryCellGroup | CellGroupConfig | | |
| } | | | |
| } | | | |
| } | | | |

Table 8.2.4.1.1.1.3.3-7: CellGroupConfig (Table 8.2.4.1.1.1.3.3-6)

| Derivation Path: 38.508-1 [4], Table 4.6.3-19 with condition SCell_Add | | | |
|--|-------------------|---------|-----------|
| Information Element | Value/remark | Comment | Condition |
| CellGroupConfig ::= SEQUENCE { | | | |
| sCellToAddModList SEQUENCE (SIZE(1..maxNrofSCells)) OF SCellConfig { | 1 entry | | |
| SCellConfig[1] SEQUENCE { | | entry 1 | |
| sCellConfigDedicated | ServingCellConfig | | |
| } | | | |
| } | | | |
| } | | | |

Table 8.2.4.1.1.1.3.3-8: ServingCellConfig (Table 8.2.4.1.1.1.3.3-7)

| Derivation Path: TS 38.508-1 [4], Table 4.6.3-167 | | | |
|---|-----------------------|---------|-----------|
| Information Element | Value/remark | Comment | Condition |
| ServingCellConfig ::= SEQUENCE { | | | |
| initialDownlinkBWP | BWP-DownlinkDedicated | | |
| } | | | |

Table 8.2.4.1.1.1.3.3-9: BWP-DownlinkDedicated (Table 8.2.4.1.1.1.3.3-8)

| Derivation Path: TS 38.508-1 [4], Table 4.6.3-10 | | | |
|--|--------------|---------|-----------|
| Information Element | Value/remark | Comment | Condition |
| BWP-DownlinkDedicated ::= SEQUENCE { | | | |
| pdccch-Config CHOICE { | | | |
| setup | PDCCH-Config | | |
| } | | | |
| } | | | |

Table 8.2.4.1.1.1.3.3-10: PDCCH-Config (Table 8.2.4.1.1.1.3.3-9)

| Derivation Path: TS 38.508-1 [4], Table 4.6.3-100 | | | |
|---|-----------------------|---------|-----------|
| Information Element | Value/remark | Comment | Condition |
| PDCCH-Config ::= SEQUENCE { | | | |
| tpc-SRS SetupRelease { | | | |
| setup | SRS-TPC-CommandConfig | | |
| } | | | |
| } | | | |

Table 8.2.4.1.1.1.3.3-11: SRS-TPC-CommandConfig (Table 8.2.4.1.1.1.3.3-10)

| Derivation Path: TS 38.508-1 [4], Table 4.6.3-183 | | | |
|---|--------------|---------|-----------|
| Information Element | Value/remark | Comment | Condition |
| SRS-TPC-CommandConfig ::= SEQUENCE { | | | |
| startingBitOfFormat2-3 | 1 | | |
| fieldTypeFormat2-3 | 1 | | |
| } | | | |

Table 8.2.4.1.1.1.3.3-12: RRCConnectionReconfiguration (step 5, Table 8.2.4.1.1.1.3.2-1)

| Derivation Path: 36.508 [7], Table 4.6.1-8 with condition EN-DC_NR_CA | | | |
|---|---|---------|-----------|
| Information Element | Value/remark | Comment | Condition |
| RRCConnectionReconfiguration ::= SEQUENCE { | | | |
| criticalExtensions CHOICE { | | | |
| c1 CHOICE{ | | | |
| rrcConnectionReconfiguration-r8 SEQUENCE { | | | |
| nonCriticalExtension SEQUENCE { | | | |
| nonCriticalExtension SEQUENCE { | | | |
| nonCriticalExtension SEQUENCE { | | | |
| nonCriticalExtension SEQUENCE { | | | |
| nonCriticalExtension SEQUENCE { | | | |
| nonCriticalExtension SEQUENCE { | | | |
| nonCriticalExtension SEQUENCE { | | | |
| nr-Config-r15 CHOICE { | | | |
| setup SEQUENCE { | | | |
| nr-SecondaryCellGroupConfig-r15 | OCTET STRING including the <i>RRCReconfiguration</i> message and the IE <i>secondaryCellGroup</i> . | | |
| } | | | |
| } | | | |
| } | | | |
| } | | | |
| } | | | |
| } | | | |
| } | | | |

Table 8.2.4.1.1.1.3.3-13: RRCReconfiguration (Table 8.2.4.1.1.1.3.3-12)

| Derivation Path: 38.508-1 [4], Table 4.6.1-13 | | | |
|---|-----------------|---------|-----------|
| Information Element | Value/remark | Comment | Condition |
| RRCReconfiguration ::= SEQUENCE { | | | |
| criticalExtensions CHOICE { | | | |
| rrcReconfiguration SEQUENCE { | | | |
| secondaryCellGroup | CellGroupConfig | | |
| } | | | |
| } | | | |
| } | | | |

Table 8.2.4.1.1.3.3-14: CellGroupConfig (Table 8.2.4.1.1.3.3-13)

| Derivation Path: 38.508-1 [4], Table 4.6.3-19 | | | |
|---|--------------|---------|-----------|
| Information Element | Value/remark | Comment | Condition |
| CellGroupConfig ::= SEQUENCE { | | | |
| sCellToReleaseList SEQUENCE | 1 entry | | |
| (SIZE(1..maxNrofSCells)) OF SCellIndex { | | | |
| SCellIndex[1] | 2 | entry 1 | |
| } | | | |
| } | | | |

8.2.4.1.1.2 NR CA / NR SCell addition / modification / release / Success / EN-DC / Intra-band non-Contiguous CA

8.2.4.1.1.2.1 Test Purpose (TP)

Same as TC 8.2.4.1.1.1 but applied to Intra-band non-Contiguous CA.

8.2.4.1.1.2.2 Conformance requirements

Same as TC 8.2.4.1.1.1 but applied to Intra-band non-Contiguous CA.

8.2.4.1.1.2.3 Test description

8.2.4.1.1.2.3.1 Pre-test conditions

Same as TC 8.2.4.1.1.1 with the following differences:

- CA configuration: Intra-band non-Contiguous CA replaces Intra-band Contiguous CA

8.2.4.1.1.2.3.2 Test procedure sequence

Same as TC 8.2.4.1.1.1 with the following differences:

- CA configuration: Intra-band non-Contiguous CA replaces Intra-band Contiguous CA

8.2.4.1.1.3 NR CA / NR SCell addition / modification / release / Success / EN-DC / Inter-band CA

8.2.4.1.1.3.1 Test Purpose (TP)

Same as TC 8.2.4.1.1.1 but applied to Inter-band CA

8.2.4.1.1.3.2 Conformance requirements

Same as TC 8.2.4.1.1.1 but applied to Inter-band CA

8.2.4.1.1.3.3 Test description

8.2.4.1.1.3.3.1 Pre-test conditions

Same as TC 8.2.4.1.1.1 with the following differences:

- CA configuration: Inter-band CA replaces Intra-band Contiguous CA
- Cells configuration: NR Cell 10 replaces NR Cell 3

8.2.4.1.1.3.3.2 Test procedure sequence

Same as TC 8.2.4.1.1.1 with the following differences:

- CA configuration: Inter-band CA replaces Intra-band Contiguous CA
- Cells configuration: NR Cell 10 replaces NR Cell 3

8.2.4.2 NR CA / Simultaneous PSCell and SCell addition / PSCell and SCell change / CA Release

8.2.4.2.1 NR CA / Simultaneous PSCell and SCell addition / PSCell and SCell change / CA Release/ EN-DC

8.2.4.2.1.1 NR CA / Simultaneous PSCell and SCell addition / PSCell and SCell change / CA Release / EN-DC / Intra-band Contiguous CA

8.2.4.2.1.1.1 Test Purpose (TP)

(1)

```
with { UE in RRC_CONNECTED state with E-UTRA }
ensure that {
  when { UE receives an RRCConnectionReconfiguration message with nr-Config IE including NR
RRCReconfiguration message to configure NR PSCell and sCellToAddModList with an sCellIndex set to
the configured SCell }
  then { UE sends an RRCConnectionReconfigurationComplete message indicating the addition of
PSCell and configures lower layers to consider the SCell to be in deactivated state }
}
```

(2)

```
with { UE in RRC_CONNECTED state with EN-DC, and, MCG(s) (E-UTRA PDCP) and SCG with SCell(s)
configured }
ensure that {
  when { UE receives an RRCConnectionReconfiguration message with nr-Config IE including NR
RRCReconfiguration message to perform both PSCell and SCell change to the configured target PSCell
and SCell }
  then { UE sends an RRCConnectionReconfigurationComplete message and configures new PSCell and
configures lower layers to consider the SCell to be in deactivated state }
}
```

(3)

```
with { UE in RRC_CONNECTED state with EN-DC, and, MCG(s) (E-UTRA PDCP) and SCG with SCell(s)
configured }
ensure that {
  when { UE receives an RRCConnectionReconfiguration message with nr-Config IE including NR
RRCReconfiguration message to perform PSCell change to one of the SCell equaling to one of the
current UE SCell configuration }
  then { UE sends an RRCConnectionReconfigurationComplete message and reconfigures the current NR
Scell to PSCell }
}
```

8.2.4.2.1.1.2 Conformance requirements

References: The conformance requirements covered in the present TC are specified in: TS 36.331: 5.3.5.3; TS 38.331: 5.3.5.3, 5.3.5.5.7, 5.3.5.5.8, 5.3.5.5.9, 5.3.5.6.4 and 5.3.5.6.5. Unless otherwise stated these are Rel-15 requirements.

[TS 36.331, clause 5.3.5.3]

If the *RRCConnectionReconfiguration* message does not include the *mobilityControlInfo* and the UE is able to comply with the configuration included in this message, the UE shall:

- 1> if this is the first *RRCConnectionReconfiguration* message after successful completion of the RRC connection re-establishment procedure:
- 2> re-establish PDCP for SRB2 configured with E-UTRA PDCP entity and for all DRBs that are established and configured with E-UTRA PDCP, if any;

- 2> re-establish RLC for SRB2 and for all DRBs that are established and configured with E-UTRA RLC, if any;
- 2> if the *RRCCConnectionReconfiguration* message includes the *fullConfig*:
 - 3> perform the radio configuration procedure as specified in 5.3.5.8;
- 2> if the *RRCCConnectionReconfiguration* message includes the *radioResourceConfigDedicated*:
 - 3> perform the radio resource configuration procedure as specified in 5.3.10;

NOTE 1: Void

NOTE 2: Void

1> else:

- 2> if the *RRCCConnectionReconfiguration* message includes the *radioResourceConfigDedicated*:
 - 3> perform the radio resource configuration procedure as specified in 5.3.10;

NOTE 3: If the *RRCCConnectionReconfiguration* message includes the establishment of radio bearers other than SRB1, the UE may start using these radio bearers immediately, i.e. there is no need to wait for an outstanding acknowledgment of the *SecurityModeComplete* message.

- 1> if the received *RRCCConnectionReconfiguration* includes the *sCellToReleaseList*:
 - 2> perform SCell release as specified in 5.3.10.3a;
- 1> if the received *RRCCConnectionReconfiguration* includes the *sCellToAddModList*:
 - 2> perform SCell addition or modification as specified in 5.3.10.3b;
- 1> if the received *RRCCConnectionReconfiguration* includes the *scg-Configuration*; or
- 1> if the current UE configuration includes one or more split DRBs configured with *pdcp-Config* and the received *RRCCConnectionReconfiguration* includes *radioResourceConfigDedicated* including *drb-ToAddModList*:
 - 2> perform SCG reconfiguration as specified in 5.3.10.10;
- 1> if the received *RRCCConnectionReconfiguration* includes the *nr-Config* and it is set to *release*: or
- 1> if the received *RRCCConnectionReconfiguration* includes *endc-ReleaseAndAdd* and it is set to *TRUE*:
 - 2> perform EN-DC release as specified in TS 38.331 [82], clause 5.3.5.10;
- 1> if the received *RRCCConnectionReconfiguration* includes the *sk-Counter*:
 - 2> perform key update procedure as specified in TS 38.331 [82], clause 5.3.5.7;
- 1> if the received *RRCCConnectionReconfiguration* includes the *nr-SecondaryCellGroupConfig*:
 - 2> perform NR RRC Reconfiguration as specified in TS 38.331 [82], clause 5.3.5.3;
- 1> if the received *RRCCConnectionReconfiguration* includes the *nr-RadioBearerConfig1*:
 - 2> perform radio bearer configuration as specified in TS 38.331 [82], clause 5.3.5.6;
- 1> if the received *RRCCConnectionReconfiguration* includes the *nr-RadioBearerConfig2*:
 - 2> perform radio bearer configuration as specified in TS 38.331 [82], clause 5.3.5.6;
- 1> if this is the first *RRCCConnectionReconfiguration* message after successful completion of the RRC connection re-establishment procedure:
 - 2> resume SRB2 and all DRBs that are suspended, if any, including RBs configured with NR PDCP;

NOTE 4: The handling of the radio bearers after the successful completion of the PDCP re-establishment, e.g. the re-transmission of unacknowledged PDCP SDUs (as well as the associated status reporting), the handling of the SN and the HFN, is specified in TS 36.323 [8].

NOTE 5: The UE may discard SRB2 messages and data that it receives prior to completing the reconfiguration used to resume these bearers.

- 1> if the received *RRCCConnectionReconfiguration* includes the *systemInformationBlockType1Dedicated*:
 - 2> perform the actions upon reception of the *SystemInformationBlockType1* message as specified in 5.2.2.7;
- 1> if the *RRCCConnectionReconfiguration* message includes the *dedicatedInfoNASList*:
 - 2> forward each element of the *dedicatedInfoNASList* to upper layers in the same order as listed;
- 1> if the *RRCCConnectionReconfiguration* message includes the *measConfig*:
 - 2> perform the measurement configuration procedure as specified in 5.5.2;
- 1> perform the measurement identity autonomous removal as specified in 5.5.2.2a;
- 1> if the *RRCCConnectionReconfiguration* message includes the *otherConfig*:
 - 2> perform the other configuration procedure as specified in 5.3.10.9;
- 1> if the *RRCCConnectionReconfiguration* message includes the *sl-DiscConfig* or *sl-CommConfig*:
 - 2> perform the sidelink dedicated configuration procedure as specified in 5.3.10.15;
- 1> if the *RRCCConnectionReconfiguration* message includes the *sl-V2X-ConfigDedicated*:
 - 2> perform the V2X sidelink communication dedicated configuration procedure as specified in 5.3.10.15a;
- 1> if the *RRCCConnectionReconfiguration* message includes *wlan-OffloadInfo*:
 - 2> perform the dedicated WLAN offload configuration procedure as specified in 5.6.12.2;
- 1> if the *RRCCConnectionReconfiguration* message includes *rclwi-Configuration*:
 - 2> perform the WLAN traffic steering command procedure as specified in 5.6.16.2;
- 1> if the *RRCCConnectionReconfiguration* message includes *lwa-Configuration*:
 - 2> perform the LWA configuration procedure as specified in 5.6.14.2;
- 1> if the *RRCCConnectionReconfiguration* message includes *lwip-Configuration*:
 - 2> perform the LWIP reconfiguration procedure as specified in 5.6.17.2;
- 1> upon RRC connection establishment, if UE does not need UL gaps during continuous uplink transmission:
 - 2> configure lower layers to stop using UL gaps during continuous uplink transmission in FDD for *RRCCConnectionReconfigurationComplete* message and subsequent uplink transmission in RRC_CONNECTED except for UL transmissions as specified in TS36.211 [21];
- 1> set the content of *RRCCConnectionReconfigurationComplete* message as follows:
 - 2> if the *RRCCConnectionReconfiguration* message includes *perCC-GapIndicationRequest*:
 - 3> include *perCC-GapIndicationList* and *numFreqEffective*;
 - 2> if the frequencies are configured for reduced measurement performance:
 - 3> include *numFreqEffectiveReduced*;
 - 2> if the received *RRCCConnectionReconfiguration* message included *nr-SecondaryCellGroupConfig*:
 - 3> include *scg-ConfigResponseNR* in accordance with TS 38.331 [82, 5.3.5.3];

- 1> submit the *RRCConnectionReconfigurationComplete* message to lower layers for transmission using the new configuration, upon which the procedure ends;

[TS 38.331, clause 5.3.5.3]

The UE shall perform the following actions upon reception of the *RRCReconfiguration*:

- 1> if the *RRCReconfiguration* includes the *fullConfig*:
 - 2> perform the radio configuration procedure as specified in 5.3.5.11;
- 1> if the *RRCReconfiguration* includes the *masterCellGroup*:
 - 2> perform the cell group configuration for the received *masterCellGroup* according to 5.3.5.5;
- 1> if the *RRCReconfiguration* includes the *masterKeyUpdate*:
 - 2> perform security key update procedure as specified in 5.3.5.7;
- 1> if the *RRCReconfiguration* includes the *secondaryCellGroup*:
 - 2> perform the cell group configuration for the SCG according to 5.3.5.5;
- 1> if the *RRCReconfiguration* message contains the *radioBearerConfig*:
 - 2> perform the radio bearer configuration according to 5.3.5.6;
- 1> if the *RRCReconfiguration* message includes the *measConfig*:
 - 2> perform the measurement configuration procedure as specified in 5.5.2;
- 1> if the *RRCReconfiguration* message includes the *dedicatedSIB1-Delivery*:
 - 2> perform the action upon reception of *SIB1* as specified in 5.2.2.4.2;
- 1> if the *RRCReconfiguration* message includes the *dedicatedSystemInformationDelivery*:
 - 2> perform the action upon reception of System Information as specified in 5.2.2.4;
- 1> set the content of *RRCReconfigurationComplete* message as follows:
 - 2> if the *RRCReconfiguration* includes the *masterCellGroup* containing the *reportUplinkTxDirectCurrent*, or;
 - 2> if the *RRCReconfiguration* includes the *secondaryCellGroup* containing the *reportUplinkTxDirectCurrent*:
 - 3> include the *uplinkTxDirectCurrentList*;
- 1> if the UE is configured with E-UTRA *nr-SecondaryCellGroupConfig* (MCG is E-UTRA):
 - 2> if *RRCReconfiguration* was received via SRB1:
 - 3> submit the *RRCReconfigurationComplete* via the EUTRA MCG embedded in E-UTRA RRC message *RRCConnectionReconfigurationComplete* as specified in TS 36.331 [10];
 - 3> if *reconfigurationWithSync* was included in *spCellConfig* of an SCG:
 - 4> initiate the random access procedure on the SpCell, as specified in TS 38.321 [3];
 - 3> else:
 - 4> the procedure ends;

NOTE: The order the UE sends the *RRCConnectionReconfigurationComplete* message and performs the Random Access procedure towards the SCG is left to UE implementation.

- 2> else (*RRCReconfiguration* was received via SRB3):
 - 3> submit the *RRCReconfigurationComplete* message via SRB3 to lower layers for transmission using the new configuration;

NOTE: For EN-DC, in the case of SRB1, the random access is triggered by RRC layer itself as there is not necessarily other UL transmission. In the case of SRB3, the random access is triggered by the MAC layer due to arrival of *RRCReconfigurationComplete*.

1> else:

2> submit the *RRCReconfigurationComplete* message via SRB1 to lower layers for transmission using the new configuration;

1> if *reconfigurationWithSync* was included in *spCellConfig* of an MCG or SCG, and when MAC of an NR cell group successfully completes a random access procedure triggered above;

2> stop timer T304 for that cell group;

2> apply the parts of the CQI reporting configuration, the scheduling request configuration and the sounding RS configuration that do not require the UE to know the SFN of the respective target SpCell, if any;

2> apply the parts of the measurement and the radio resource configuration that require the UE to know the SFN of the respective target SpCell (e.g. measurement gaps, periodic CQI reporting, scheduling request configuration, sounding RS configuration), if any, upon acquiring the SFN of that target SpCell;

2> if the *reconfigurationWithSync* was included in *spCellConfig* of an MCG:

3> if the active downlink BWP, which is indicated by the *firstActiveDownlinkBWP-Id* for the target SpCell of the MCG, has a common search space configured:

4> acquire the *SIB1* of the target SpCell of the MCG, as specified in 5.2.2.3.1;

2> the procedure ends.

NOTE: The UE is only required to acquire broadcasted *SIB1* if the UE can acquire it without disrupting unicast data reception, i.e. the broadcast and unicast beams are quasi co-located.

[TS 38.331, clause 5.3.5.5.7]

The UE shall:

1> if the *SpCellConfig* contains the *rlf-TimersAndConstants*:

2> configure the RLF timers and constants for this cell group as specified in 5.3.5.5.6.

1> else if *rlf-TimersAndConstants* is not configured for this cell group:

2> use values for timers T301, T310, T311 and constants N310, N311, as included in *ue-TimersAndConstants* received in *SIB1*;

1> if the *SpCellConfig* contains *spCellConfigDedicated*:

2> configure the SpCell in accordance with the *spCellConfigDedicated*;

2> consider the bandwidth part indicated in *firstActiveUplinkBWP-Id* if configured to be the active uplink bandwidth part;

2> consider the bandwidth part indicated in *firstActiveDownlinkBWP-Id* if configured to be the active downlink bandwidth part;

2> if the any of the reference signal(s) that are used for radio link monitoring are reconfigured by the received *spCellConfigDedicated*:

3> stop timer T310 for the corresponding SpCell, if running;

3> reset the counters N310 and N311.

[TS 38.331, clause 5.3.5.5.8]

The UE shall:

- 1> if the release is triggered by reception of the *sCellToReleaseList*:
 - 2> for each *sCellIndex* value included in the *sCellToReleaseList*:
 - 3> if the current UE configuration includes an SCell with value *sCellIndex*:
 - 4> release the SCell.

[TS 38.331, clause 5.3.5.5.9]

The UE shall:

- 1> for each *sCellIndex* value included in the *sCellToAddModList* that is not part of the current UE configuration (SCell addition):
 - 2> add the SCell, corresponding to the *sCellIndex*, in accordance with the *sCellConfigCommon* and *sCellConfigDedicated*;
 - 2> configure lower layers to consider the SCell to be in deactivated state;

Editor's Note: FFS Check automatic measurement handling for SCells.

- 2> for each *measId* included in the *measIdList* within *VarMeasConfig*:
 - 3> if SCells are not applicable for the associated measurement; and
 - 3> if the concerned SCell is included in *cellsTriggeredList* defined within the *VarMeasReportList* for this *measId*:
 - 4> remove the concerned SCell from *cellsTriggeredList* defined within the *VarMeasReportList* for this *measId*;
- 1> for each *sCellIndex* value included in the *sCellToAddModList* that is part of the current UE configuration (SCell modification):
 - 2> modify the SCell configuration in accordance with the *sCellConfigDedicated*.

[TS 38.331, clause 5.3.5.6.4]

Editor's Note: FFS / TODO: Add handling for the new QoS concept (mapping of flows; configuration of QFI-to-DRB mapping; reflective QoS...) but keep also EPS-Bearer handling for the EN-DC case

The UE shall:

- 1> for each *drb-Identity* value included in the *drb-ToReleaseList* that is part of the current UE configuration (DRB release):
 - 2> release the PDCP entity;
 - 2> if SDAP entity associated with this DRB is configured:
 - 3> indicate the release of the DRB to SDAP entity associated with this DRB (TS 37.324 [xx] section 5.3.3);
 - 2> if the UE is operating in EN-DC:
 - 3> if a new bearer is not added either with NR or E-UTRA with same *eps-BearerIdentity*:
 - 4> indicate the release of the DRB and the *eps-BearerIdentity* of the released DRB to upper layers.

NOTE 1: The UE does not consider the message as erroneous if the *drb-ToReleaseList* includes any *drb-Identity* value that is not part of the current UE configuration.

NOTE 2: Whether or not the RLC and MAC entities associated with this PDCP entity are reset or released is determined by the *CellGroupConfig*.

[TS 38.331, clause 5.3.5.6.5]

The UE shall:

- 1> for each *drb-Identity* value included in the *drb-ToAddModList* that is not part of the current UE configuration (DRB establishment including the case when full configuration option is used):
 - 2> if an *sdap-Config* is included:
 - 3> if an SDAP entity with the received *pdu-Session* does not exist:
 - 4> establish an SDAP entity as specified in TS 37.324 [xx] section 5.1.1;
 - 3> configure the SDAP entity in accordance with the received *sdap-Config* as specified in TS 37.324 [xx] and associate the DRB with the SDAP entity;
 - 2> establish a PDCP entity and configure it in accordance with the received *pdcp-Config*;
 - 2> if the PDCP entity of this DRB is not configured with *cipheringDisabled*:
 - 3> configure the PDCP entity with the ciphering algorithms according to *securityConfig* and apply the K_{UPenc} key associated with the master key (K_{eNB}/K_{gNB}) or the secondary key ($S-K_{gNB}$) as indicated in *keyToUse*;
 - 2> if the PDCP entity of this DRB is configured with *integrityProtection*:
 - 3> configure the PDCP entity with the integrity algorithms according to *securityConfig* and apply the K_{UPint} key associated with the master (K_{eNB}/K_{gNB}) or the secondary key ($S-K_{gNB}$) as indicated in *keyToUse*;
 - 2> if the UE is operating in EN-DC:
 - 3> if the DRB was configured with the same *eps-BearerIdentity* either by NR or E-UTRA prior to receiving this reconfiguration:
 - 4> associate the established DRB with the corresponding *eps-BearerIdentity*;
 - 3> else:
 - 4> indicate the establishment of the DRB(s) and the *eps-BearerIdentity* of the established DRB(s) to upper layers;
- 1> for each *drb-Identity* value included in the *drb-ToAddModList* that is part of the current UE configuration:
 - 2> if an *sdap-Config* is included, reconfigure the SDAP entity in accordance with the received *sdap-Config* as specified in TS 37.324 [xx];
 - 2> if the reestablishPDCP is set:
 - 3> if target RAT is E-UTRA/5GC:
 - 4> if the PDCP entity of this DRB is not configured with *cipheringDisabled*:
 - 5> configure the PDCP entity with the ciphering algorithm and K_{UPenc} key configured/derived as specified in TS 36.331 [10, 5.4.2.3], i.e. the ciphering configuration shall be applied to all subsequent PDCP PDUs received and sent by the UE;
 - 3> else:
 - 4> if the PDCP entity of this DRB is not configured with *cipheringDisabled*:
 - 5> configure the PDCP entity with the ciphering algorithm and K_{UPenc} key associated with the master or secondary key ($K_{eNB}/S-K_{gNB}/K_{gNB}$) as indicated in *keyToUse*, i.e. the ciphering configuration shall be applied to all subsequent PDCP PDUs received and sent by the UE;
 - 4> if the PDCP entity of this DRB is configured with *integrityProtection*:
 - 5> configure the PDCP entity with the integrity algorithms according to *securityConfig* and apply the K_{UPint} key associated with the master (K_{eNB}/K_{gNB}) or the secondary key ($S-K_{gNB}$) as indicated in *keyToUse*;
 - 3> re-establish the PDCP entity of this DRB as specified in 38.323 [5], section 5.1.2;

- 2> else, if the *recoverPDCP* is set:
 - 3> trigger the PDCP entity of this DRB to perform data recovery as specified in 38.323;
- 2> if the *pdcp-Config* is included:
 - 3> reconfigure the PDCP entity in accordance with the received *pdcp-Config*.

NOTE 1: Removal and addition of the same *drb-Identity* in a single *radioResourceConfig* is not supported. In case *drb-Identity* is removed and added due to reconfiguration with sync or re-establishment with the full configuration option, the network can use the same value of *drb-Identity*.

NOTE 2: When determining whether a *drb-Identity* value is part of the current UE configuration, the UE does not distinguish which *RadioBearerConfig* and *DRB-ToAddModList* that DRB was originally configured in. To re-associate a DRB with a different key (KeNB to S-KeNB or vice versa), the network provides the *drb-Identity* value in the (target) *drb-ToAddModList* and sets the *reestablishPDCP* flag. The network does not list the *drb-Identity* in the (source) *drb-ToReleaseList*.

NOTE 3: When setting the *reestablishPDCP* flag for a radio bearer, the network ensures that the RLC receiver entities do not deliver old PDCP PDUs to the re-established PDCP entity. It does that e.g. by triggering a reconfiguration with sync of the cell group hosting the old RLC entity or by releasing the old RLC entity.

NOTE 4: In this specification, UE configuration refers to the parameters configured by NR RRC unless otherwise stated.

NOTE 5: Ciphering and integrity protection can be enabled or disabled for a DRB. The enabling/disabling of ciphering or integrity protection can be changed only by releasing and adding the DRB.

8.2.4.2.1.1.3 Test description

8.2.4.2.1.1.3.1 Pre-test conditions

System Simulator:

- E-UTRA Cell 1 is the PCell, NR Cell 1 is the PSCell to be added, and NR Cell 3 is Scell to be added. NR Cell 2 and NR Cell 12 are the target PSCell and SCell.
- NR Cell 1 and NR Cell 3 are Intra-band Contiguous. NR Cell 2 and NR Cell 12 are Intra-band Contiguous.

UE:

None

Preamble:

- The UE is in state RRC_CONNECTED using generic procedure parameter Connectivity (*EN-DC*) and Bearers (*MCG(s) only*) established according to TS 38.508-1 [4].

8.2.4.2.1.1.3.2 Test procedure sequence

Table 8.2.4.2.1.1.3.2-1 illustrates the downlink power levels to be applied for EUTRA Cell 1, NR Cell 1, NR Cell 3, NR Cell 2 and NR Cell 12 at various time instants of the test execution. Row marked "T0" denotes the conditions after the preamble, while rows marked "T1" are to be applied subsequently. The exact instants on which these values shall be applied are described in the texts in this clause.

Table 8.2.4.2.1.1.3.2-1: Power levels for FR1

| | Parameter | Unit | E-UTRA Cell 1 | NR Cell 1 | NR Cell 3 | NR Cell 2 | NR Cell 12 | Remark |
|----|-----------------------|------------|---------------|-----------|-----------|-----------|------------|--|
| T0 | Cell-specific RS EPRE | dBm/1 5kHz | -85 | - | - | - | - | EUTRA Cell 1, NR Cell 1 and NR Cell 3 are available. NR Cell 2 and NR Cell 12 are not available. |
| | SS/PBCH SSS EPRE | dBm/SCS | - | -88 | -88 | off | off | |
| T1 | Cell-specific RS EPRE | dBm/1 5kHz | -85 | - | - | - | - | EUTRA Cell 1, NR Cell 1, NR Cell 3, NR Cell 2 and NR Cell 12 are available. |
| | SS/PBCH SSS EPRE | dBm/SCS | - | -88 | -88 | -88 | -88 | |

Table 8.2.4.2.1.1.3.2-1A: Power levels for FR2

| | Parameter | Unit | E-UTRA Cell 1 | NR Cell 1 | NR Cell 3 | NR Cell 2 | NR Cell 12 | Remark |
|----|-----------------------|------------|---------------|-----------|-----------|-----------|------------|--|
| T0 | Cell-specific RS EPRE | dBm/1 5kHz | -96 | - | - | - | - | EUTRA Cell 1, NR Cell 1 and NR Cell 3 are available. NR Cell 2 and NR Cell 12 are not available. |
| | SS/PBCH SSS EPRE | dBm/SCS | - | -91 | -91 | off | off | |
| T1 | Cell-specific RS EPRE | dBm/1 5kHz | -96 | - | - | - | - | EUTRA Cell 1, NR Cell 1, NR Cell 3, NR Cell 2 and NR Cell 12 are available. |
| | SS/PBCH SSS EPRE | dBm/SCS | - | -91 | -91 | -91 | -91 | |

Table 8.2.4.2.1.1.3.2-2: Main behaviour

| St | Procedure | Message Sequence | | TP | Verdict |
|----|---|------------------|---|----|---------|
| | | U – S | Message | | |
| 1 | The SS changes Cell parameters according to the row "T0" in table 8.2.4.2.1.1.3.2-1. | - | - | - | - |
| 2 | The SS transmits an <i>RRCCONNECTIONRECONFIGURATION</i> message with nr-Config IE including NR RRCReconfiguration message to configure NR Cell 1 as the NR PSCell and sCellToAddModList with a sCellIndex set to NR Cell 3 as the configured SCell. | <- | <i>RRCCONNECTIONRECONFIGURATION</i> | - | - |
| 3 | Check: Does the UE transmit an <i>RRCCONNECTIONRECONFIGURATIONCOMPLETE</i> message? | --> | <i>RRCCONNECTIONRECONFIGURATIONCOMPLETE</i> | 1 | P |
| 3A | Check: Does the test result of generic test procedure in TS 38.508-1 Table 4.9.1-1A indicate that the UE is capable of exchanging IP data on DRB #n associated with the first PDU session on NR Cell 3? | - | - | - | - |
| 4 | The SS changes NR Cell 2 and NR Cell 12 parameters according to the row "T1" in table 8.2.4.2.1.1.3.2-1. | - | - | - | - |
| 5 | The SS transmits an <i>RRCCONNECTIONRECONFIGURATION</i> message with nr-Config IE including NR RRCReconfiguration message to perform both NR Cell 1 and NR Cell 3 changed to the configured target NR Cell 2 and NR Cell 12. | <- | <i>RRCCONNECTIONRECONFIGURATION</i> | - | - |
| 6 | Check: Does the UE transmit an <i>RRCCONNECTIONRECONFIGURATIONCOMPLETE</i> message configuring the new PSCell and SCell and configure lower layers to consider the SCell to be in deactivated state? | --> | <i>RRCCONNECTIONRECONFIGURATIONCOMPLETE</i> | 2 | P |
| 6A | Check: Does the test result of generic test procedure in TS 38.508-1 Table 4.9.1-1A indicate that the UE is capable of exchanging IP data on DRB #n associated with the first PDU session on NR Cell 12? | - | - | - | - |
| 7 | The SS transmits an <i>RRCCONNECTIONRECONFIGURATION</i> message with nr-Config IE including NR RRCReconfiguration message to change the current PSCell (NR Cell 2) to NR Cell 12 equaling to one of the current UE SCell configuration. | <- | <i>RRCCONNECTIONRECONFIGURATION</i> | - | - |
| 8 | Check: Does the UE send an <i>RRCCONNECTIONRECONFIGURATIONCOMPLETE</i> message and reconfigure the current NR SCell to PSCell? | --> | <i>RRCCONNECTIONRECONFIGURATIONCOMPLETE</i> | 3 | P |

8.2.4.2.1.1.3.3 Specific message contents

Table 8.2.4.2.1.1.3.3-1: RRCConnectionReconfiguration (step 2, Table 8.2.4.2.1.1.3.2-2)

| Derivation Path: 36.508 [7], Table 4.6.1-8 with condition MCG_and_SCG | | | |
|---|--------------------|---|-----------|
| Information Element | Value/remark | Comment | Condition |
| RRCConnectionReconfiguration ::= SEQUENCE { | | | |
| criticalExtensions CHOICE { | | | |
| c1 CHOICE{ | | | |
| rrcConnectionReconfiguration-r8 SEQUENCE { | | | |
| nonCriticalExtension SEQUENCE { | | | |
| nonCriticalExtension SEQUENCE { | | | |
| nonCriticalExtension SEQUENCE { | | | |
| nonCriticalExtension SEQUENCE { | | | |
| nonCriticalExtension SEQUENCE { | | | |
| nonCriticalExtension SEQUENCE { | | | |
| nonCriticalExtension SEQUENCE { | | | |
| nr-Config-r15 CHOICE { | | | |
| setup SEQUENCE { | | | |
| nr-SecondaryCellGroupConfig-r15 | RRCReconfiguration | OCTET STRING including the RRCReconfiguration | |
| } | | | |
| } | | | |
| } | | | |
| } | | | |
| } | | | |
| } | | | |
| } | | | |
| } | | | |
| } | | | |
| } | | | |
| } | | | |
| } | | | |

Table 8.2.4.2.1.1.3.3-2: RRCReconfiguration (Table 8.2.4.2.1.1.3.3-1: RRCConnectionReconfiguration)

| Derivation Path: 38.508-1 [4], Table 4.6.1-13 with Condition EN-DC | | | |
|--|-----------------|---|-----------|
| Information Element | Value/remark | Comment | Condition |
| RRCReconfiguration ::= SEQUENCE { | | | |
| criticalExtensions CHOICE { | | | |
| rrcReconfiguration SEQUENCE { | | | |
| secondaryCellGroup | CellGroupConfig | OCTET STRING (CONTAINING CellGroupConfig) | |
| } | | | |
| } | | | |

Table 8.2.4.2.1.1.3.3-3: CellGroupConfig (Table 8.2.4.2.1.1.3.3-2: RRCReconfiguration)

| Derivation Path: 38.508-1 [4], Table 4.6.3-19 with condition EN-DC and SCell_add | | | |
|--|-------------------------------------|---------|-----------|
| Information Element | Value/remark | Comment | Condition |
| CellGroupConfig ::= SEQUENCE { | | | |
| spCellConfig SEQUENCE { | | | |
| servCellIndex | 1 | | |
| reconfigurationWithSync SEQUENCE { | | | |
| spCellConfigCommon SEQUENCE { | | | |
| physCellId | Physical Cell Identity of NR Cell 1 | | |
| } | | | |
| } | | | |
| } | | | |
| sCellToAddModList SEQUENCE (SIZE (1..maxNrofSCells)) OF SCellConfig { | 1 entry | | |
| SCellConfig[1] SEQUENCE { | | entry 1 | |
| sCellIndex | 2 | | |
| sCellConfigCommon SEQUENCE { | | | |
| physCellId | Physical Cell Identity of NR Cell 3 | | |
| } | | | |
| } | | | |
| } | | | |
| } | | | |

Table 8.2.4.2.1.1.3.3-4: RRCConnectionReconfigurationComplete (step 3, step 6 and step 8, Table 8.2.4.2.1.1.3.2-2)

| Derivation Path: 36.508 [7], Table 4.6.1-9 with condition MCG_and_SCG |
|---|
|---|

Table 8.2.4.2.1.1.3.3-5: RRCConnectionReconfiguration (step 5, Table 8.2.4.2.1.1.3.2-2)

| Derivation Path: 36.508 [7], Table 4.6.1-8 with condition EN-DC_PSCell_HO AND RBConfig_NoKeyChange | | | |
|--|---------------------------|--|-----------|
| Information Element | Value/remark | Comment | Condition |
| RRCConnectionReconfiguration ::= SEQUENCE { | | | |
| criticalExtensions CHOICE { | | | |
| c1 CHOICE{ | | | |
| rrcConnectionReconfiguration-r8 SEQUENCE { | | | |
| nonCriticalExtension SEQUENCE { | | | |
| nonCriticalExtension SEQUENCE { | | | |
| nonCriticalExtension SEQUENCE { | | | |
| nonCriticalExtension SEQUENCE { | | | |
| nonCriticalExtension SEQUENCE { | | | |
| nonCriticalExtension SEQUENCE { | | | |
| nonCriticalExtension SEQUENCE { | | | |
| nr-Config-r15 CHOICE { | | | |
| setup SEQUENCE { | | | |
| nr-SecondaryCellGroupConfig-r15 | <i>RRCReconfiguration</i> | OCTET STRING including the <i>RRCReconfiguration</i> | |
| } | | | |
| } | | | |
| } | | | |
| } | | | |
| } | | | |
| } | | | |
| } | | | |
| } | | | |
| } | | | |
| } | | | |
| } | | | |
| } | | | |

Table 8.2.4.2.1.1.3.3-6: RRCReconfiguration (Table 8.2.4.2.1.1.3.3-5: RRCConnectionReconfiguration)

| Derivation Path: 38.508-1 [4], Table 4.6.1-13 with Condition EN-DC | | | |
|--|-----------------|---|-----------|
| Information Element | Value/remark | Comment | Condition |
| RRCReconfiguration ::= SEQUENCE { | | | |
| criticalExtensions CHOICE { | | | |
| rrcReconfiguration SEQUENCE { | | | |
| secondaryCellGroup | CellGroupConfig | OCTET STRING (CONTAINING CellGroupConfig) | |
| } | | | |
| } | | | |

Table 8.2.4.2.1.1.3.3-7: CellGroupConfig (Table 8.2.4.2.1.1.3.3-6: RRCReconfiguration)

| Derivation Path: 38.508-1 [4], Table 4.6.3-19 with Condition PSCell_change and SCell_add | | | |
|--|--------------------------------------|---------|-----------|
| Information Element | Value/remark | Comment | Condition |
| CellGroupConfig ::= SEQUENCE { | | | |
| spCellConfig SEQUENCE { | | | |
| servCellIndex | 1 | | |
| reconfigurationWithSync SEQUENCE { | | | |
| spCellConfigCommon SEQUENCE { | | | |
| physCellId | Physical Cell Identity of NR Cell 2 | | |
| } | | | |
| } | | | |
| } | | | |
| sCellToAddModList SEQUENCE (SIZE (1..maxNrofSCells)) OF SCellConfig { | 1 entry | | |
| SCellConfig[1] SEQUENCE { | | entry 1 | |
| sCellIndex | 2 | | |
| sCellConfigCommon SEQUENCE { | | | |
| physCellId | Physical Cell Identity of NR Cell 12 | | |
| } | | | |
| } | | | |
| } | | | |
| sCellToReleaseList | Not present | | |
| } | | | |

Table 8.2.4.2.1.1.3.3-8: RRCConnectionReconfiguration (step 7, Table 8.2.4.2.1.1.3.2-2)

| Derivation Path: 36.508 [7], Table 4.6.1-8 with Condition EN-DC_PSCell_HO AND RBConfig_NoKeyChange | | | |
|--|--------------------|---|-----------|
| Information Element | Value/remark | Comment | Condition |
| RRCConnectionReconfiguration ::= SEQUENCE { | | | |
| criticalExtensions CHOICE { | | | |
| c1 CHOICE{ | | | |
| rrcConnectionReconfiguration-r8 SEQUENCE { | | | |
| nonCriticalExtension SEQUENCE { | | | |
| nonCriticalExtension SEQUENCE { | | | |
| nonCriticalExtension SEQUENCE { | | | |
| nonCriticalExtension SEQUENCE { | | | |
| nonCriticalExtension SEQUENCE { | | | |
| nonCriticalExtension SEQUENCE { | | | |
| nonCriticalExtension SEQUENCE { | | | |
| nonCriticalExtension SEQUENCE { | | | |
| nr-Config-r15 CHOICE { | | | |
| setup SEQUENCE { | | | |
| nr-SecondaryCellGroupConfig-r15 | RRCReconfiguration | OCTET STRING including the RRCReconfiguration | |
| } | | | |
| } | | | |
| } | | | |
| } | | | |
| } | | | |
| } | | | |
| } | | | |
| } | | | |
| } | | | |
| } | | | |
| } | | | |
| } | | | |
| } | | | |
| } | | | |

Table 8.2.4.2.1.1.3.3-9: RRCReconfiguration (Table 8.2.4.2.1.1.3.3-8: RRCConnectionReconfiguration)

| Derivation Path: 38.508-1 [4], Table 4.6.1-13 with Condition EN-DC | | | |
|--|-----------------|---|-----------|
| Information Element | Value/remark | Comment | Condition |
| RRCReconfiguration ::= SEQUENCE { | | | |
| criticalExtensions CHOICE { | | | |
| rrcReconfiguration SEQUENCE { | | | |
| secondaryCellGroup | CellGroupConfig | OCTET STRING
(CONTAINING
CellGroupConfig) | |
| } | | | |
| } | | | |
| } | | | |

Table 8.2.4.2.1.1.3.3-10: CellGroupConfig (Table 8.2.4.2.1.1.3.3-10: RRCReconfiguration)

| Derivation Path: 38.508-1 [4], Table 4.6.3-19 with condition PSCell_change and SCell_Add | | | |
|--|---|---------|-----------|
| Information Element | Value/remark | Comment | Condition |
| CellGroupConfig ::= SEQUENCE { | | | |
| spCellConfig SEQUENCE { | | | |
| servCellIndex | 1 | | |
| reconfigurationWithSync SEQUENCE { | | | |
| spCellConfigCommon SEQUENCE { | | | |
| physCellId | Physical Cell Identity of NR
Cell 12 | | |
| } | | | |
| } | | | |
| } | | | |
| sCellToAddModList | Not present | | |
| sCellToReleaseList | Not present | | |
| } | | | |

8.2.4.2.1.2 NR CA / Simultaneous PSCell and SCell addition / PSCell and SCell change / CA Release / EN-DC / Intra-band non-Contiguous CA

8.2.4.2.1.2.1 Test Purpose (TP)

Same as TC 8.2.4.2.1.1 but applied to Intra-band non-Contiguous CA.

8.2.4.2.1.2.2 Conformance requirements

Same as TC 8.2.4.2.1.1 but applied to Intra-band non-Contiguous CA.

8.2.4.2.1.2.3 Test description

8.2.4.2.1.2.3.1 Pre-test conditions

Same as TC 8.2.4.2.1.1 with the following differences:

- CA configuration: Intra-band non-Contiguous CA replaces Intra-band Contiguous CA

8.2.4.2.1.2.3.2 Test procedure sequence

Same as TC 8.2.4.2.1.1 with the following differences:

- CA configuration: Intra-band non-Contiguous CA replaces Intra-band Contiguous CA

8.2.4.2.1.3 NR CA / Simultaneous PSCell and SCell addition / PSCell and SCell change / CA Release / EN-DC / Inter-band CA

8.2.4.2.1.3.1 Test Purpose (TP)

Same as TC 8.2.4.2.1.1 but applied to Inter-band CA.

8.2.4.2.1.3.2 Conformance requirements

Same as TC 8.2.4.2.1.1 but applied to Inter-band CA.

8.2.4.2.1.3.3 Test description

8.2.4.2.1.3.3.1 Pre-test conditions

Same as TC 8.2.4.2.1.1 with the following differences:

- CA configuration: Inter-band CA replaces Intra-band Contiguous CA

8.2.4.2.1.3.3.2 Test procedure sequence

Same as TC 8.2.4.2.1.1 with the following differences:

- CA configuration: Inter-band CA replaces Intra-band Contiguous CA
- Cells configuration: NR Cell 10 replaces NR Cell 3, NR Cell 30 replaces NR Cell 12

8.2.4.3 NR CA / SCell change / Intra-NR measurement event A6 / SRB3

8.2.4.3.1 NR CA / SCell change / Intra-NR measurement event A6 / SRB3 / EN-DC

8.2.4.3.1.1 NR CA / SCell change / Intra-NR measurement event A6 / SRB3 / EN-DC / Intra-band Contiguous CA

8.2.4.3.1.1.1 Test Purpose (TP)

(1)

```
with { UE in RRC_CONNECTED state with EN-DC, and MCG(s) (E-UTRA PDCP) and SCG with SCell(s)
configured and SRB3 configured and Intra-NR measurement configured for event A6 }
ensure that {
  when { Neighbour becomes offset better than NR SCell }
  then { UE sends a Measurement Report message on SRB3 While entering condition for event A6 is
satisfied }
}
```

(2)

```
with { UE in RRC_CONNECTED state with EN-DC, and MCG(s) (E-UTRA PDCP) and SCG with SCell(s)
configured and Intra-NR measurement is configured for event A6 }
ensure that {
  when { UE receives an RRCReconfiguration message containing sCellToReleaseList with an sCellIndex
equalling to one of the current UE SCell configuration and sCellToAddModList with an sCellIndex set
to the configured target SCell and servingCellMO equalling to one of the released SCell }
  then { UE sends an RRCReconfigurationComplete message and changes the SCell and continues
performing measurements on that SCell }
}
```

8.2.4.3.1.1.2 Conformance requirements

References: The conformance requirements covered in the present test case are specified in: TS 36.331, clause 5.3.5.3, TS 38.331, clauses 5.3.5.3, 5.3.5.5.8, 5.3.5.5.9, 5.5.4.7 and 5.5.5. Unless otherwise stated these are Rel-15 requirements.

[TS 36.331, clause 5.3.5.3]

If the *RRCCONNECTIONRECONFIGURATION* message does not include the *mobilityControlInfo* and the UE is able to comply with the configuration included in this message, the UE shall:

...

- 1> if the received *RRCCONNECTIONRECONFIGURATION* includes the *nr-Config* and it is set to *release*: or
- 1> if the received *RRCCONNECTIONRECONFIGURATION* includes *endc-ReleaseAndAdd* and it is set to *TRUE*:
 - 2> perform ENDC release as specified in TS38.331 [82], clause 5.3.5.10;

...

- 1> if the received *RRCCONNECTIONRECONFIGURATION* includes the *nr-SecondaryCellGroupConfig*:
 - 2> perform NR RRC Reconfiguration as specified in TS 38.331 [82], clause 5.3.5.5;

...

- 1> set the content of *RRCCONNECTIONRECONFIGURATIONCOMPLETE* message as follows:

...

- 2> if the received *RRCCONNECTIONRECONFIGURATION* message included *nr-SecondaryCellGroupConfig*:
 - 3> include *scg-ConfigResponseNR* in accordance with TS 38.331 [82, 5.3.5.3];
- 1> submit the *RRCCONNECTIONRECONFIGURATIONCOMPLETE* message to lower layers for transmission using the new configuration, upon which the procedure ends;

[TS 38.331, clause 5.3.5.3]

The UE shall perform the following actions upon reception of the *RRCRECONFIGURATION*:

- 1> if the *RRCRECONFIGURATION* includes the *secondaryCellGroup*:
 - 2> perform the cell group configuration for the SCG according to 5.3.5.5;
- 1> if the *RRCRECONFIGURATION* message contains the *radioBearerConfig*:
 - 2> perform the radio bearer configuration according to 5.3.5.6;
- 1> if the *RRCRECONFIGURATION* message includes the *measConfig*:
 - 2> perform the measurement configuration procedure as specified in 5.5.2;
- 1> if the UE is configured with E-UTRA *nr-SecondaryCellGroupConfig* (MCG is E-UTRA):
 - 2> if *RRCRECONFIGURATION* was received via SRB1:
 - 2> else (*RRCRECONFIGURATION* was received via SRB3):
 - 3> submit the *RRCRECONFIGURATIONCOMPLETE* message via SRB3 to lower layers for transmission using the new configuration;

NOTE: For EN-DC, in the case of SRB1, the random access is triggered by RRC layer itself as there is not necessarily other UL transmission. In the case of SRB3, the random access is triggered by the MAC layer due to arrival of *RRCRECONFIGURATIONCOMPLETE*.

- 1> else:

- 2> submit the *RRCRECONFIGURATIONCOMPLETE* message via SRB1 to lower layers for transmission using the new configuration;

...

[TS 38.331, clause 5.3.5.5.8]

The UE shall:

- 1> if the release is triggered by reception of the *sCellToReleaseList*:
 - 2> for each *sCellIndex* value included in the *sCellToReleaseList*:
 - 3> if the current UE configuration includes an SCell with value *sCellIndex*:
 - 4> release the SCell;

[TS 38.331, clause 5.3.5.5.9]

The UE shall:

- 1> for each *sCellIndex* value included in the *sCellToAddModList* that is not part of the current UE configuration (SCell addition):
 - 2> add the SCell, corresponding to the *sCellIndex*, in accordance with the *sCellConfigCommon* and *sCellConfigDedicated*;
 - 2> configure lower layers to consider the SCell to be in deactivated state;
 - 2> for each *measId* included in the *measIdList* within *VarMeasConfig*:
 - 3> if SCells are not applicable for the associated measurement; and
 - 3> if the concerned SCell is included in *cellsTriggeredList* defined within the *VarMeasReportList* for this *measId*:
 - 4> remove the concerned SCell from *cellsTriggeredList* defined within the *VarMeasReportList* for this *measId*;
- 1> for each *sCellIndex* value included in the *sCellToAddModList* that is part of the current UE configuration (SCell modification):
 - 2> modify the SCell configuration in accordance with the *sCellConfigDedicated*;

[TS 38.331, clause 5.5.4.7]

The UE shall:

- 1> consider the entering condition for this event to be satisfied when condition A6-1, as specified below, is fulfilled;
- 1> consider the leaving condition for this event to be satisfied when condition A6-2, as specified below, is fulfilled;
- 1> for this measurement, consider the (secondary) cell corresponding to the *measObjectNR* associated to this event to be the serving cell.

NOTE: The reference signal(s) of the neighbour(s) and the reference signal(s) of the SCell are both indicated in the associated *measObjectNR*.

Inequality A6-1 (Entering condition)

$$Mn + Ocn - Hys > Ms + Ocs + Off$$

Inequality A6-2 (Leaving condition)

$$Mn + Ocn + Hys < Ms + Ocs + Off$$

The variables in the formula are defined as follows:

Mn is the measurement result of the neighbouring cell, not taking into account any offsets.

Ocn is the cell specific offset of the neighbour cell (i.e. *cellIndividualOffset* as defined within the associated *measObjectNR*), and set to zero if not configured for the neighbour cell.

M_{s} is the measurement result of the serving cell, not taking into account any offsets.

O_{cs} is the cell specific offset of the serving cell (i.e. *cellIndividualOffset* as defined within the associated *measObjectNR*), and is set to zero if not configured for the serving cell.

H_{ys} is the hysteresis parameter for this event (i.e. *hysteresis* as defined within *reportConfigNR* for this event).

Off is the offset parameter for this event (i.e. *a6-Offset* as defined within *reportConfigNR* for this event).

M_n, M_s are expressed in dBm in case of RSRP, or in dB in case of RSRQ and RS-SINR.

$O_{cn}, O_{cs}, H_{ys}, Off$ are expressed in dB.

[TS 38.331, clause 5.5.5]



Figure 5.5.5.1-1: Measurement reporting

The purpose of this procedure is to transfer measurement results from the UE to the network. The UE shall initiate this procedure only after successful security activation.

For the *measId* for which the measurement reporting procedure was triggered, the UE shall set the *measResults* within the *MeasurementReport* message as follows:

- 1> set the *measId* to the measurement identity that triggered the measurement reporting;
- 1> set the *measResultServingCell* within *measResultServingMOList* to include RSRP, RSRQ and the available SINR for each configured serving cell derived based on the *rsType* indicated in the associated *reportConfig*;
- 1> set the *measResultServingCell* within *measResultServingMOList* to include for each NR serving cell that is configured with *servingCellMO*, if any, the *servCellId*;
- 1> if the *reportConfig* associated with the *measId* that triggered the measurement reporting includes *reportQuantityRsIndexes* and *maxNrofRSIndexesToReport*:
 - 2> for each serving cell configured with *servingCellMO*, include beam measurement information according to the associated *reportConfig* as described in 5.5.5.2;
 - ...
- 1> if there is at least one applicable neighbouring cell to report:
 - 2> set the *measResultNeighCells* to include the best neighbouring cells up to *maxReportCells* in accordance with the following:
 - 3> if the *reportType* is set to *eventTriggered*:
 - 4> include the cells included in the *cellsTriggeredList* as defined within the *VarMeasReportList* for this *measId*;
 - 3> else:

- 4> include the applicable cells for which the new measurement results became available since the last periodical reporting or since the measurement was initiated or reset;
- 4> if *reportQuantityRsIndexes* and *maxNrofRSIndexesToReport* are configured, include beam measurement information as described in 5.5.5.2;
- 3> for each cell that is included in the *measResultNeighCells*, include the *physCellId*;
- 3> if the *reportType* is set to *eventTriggered*:
 - 4> for each included cell, include the layer 3 filtered measured results in accordance with the *reportConfig* for this *measId*, ordered as follows:
 - 5> if the *measObject* associated with this *measId* concerns NR:
 - 6> if *rsType* in the associated *reportConfig* is set to *ssb*:
 - 7> set *resultsSSB-Cell* within the *measResult* to include the SS/PBCH block based quantity(ies) indicated in the *reportQuantityCell* within the concerned *reportConfig*, in order of decreasing trigger quantity, i.e. the best cell is included first:
 - 8> if *reportQuantityRsIndexes* and *maxNrofRSIndexesToReport* are configured, include beam measurement information as described in 5.5.5.2;
 - 6> else if *rsType* in the associated *reportConfig* is set to *csi-rs*:
 - 7> set *resultsCSI-RS-Cell* within the *measResult* to include the CSI-RS based quantity(ies) indicated in the *reportQuantityCell* within the concerned *reportConfig*, in order of decreasing trigger quantity, i.e. the best cell is included first:
 - 8> if *reportQuantityRsIndexes* and *maxNrofRSIndexesToReport* are, include beam measurement information as described in 5.5.5.2;
 - 5> if the *measObject* associated with this *measId* concerns E-UTRA:
 - 6> set the *measResult* to include the quantity(ies) indicated in the *reportQuantity* within the concerned *reportConfigInterRAT* in order of decreasing E-UTRA trigger quantity, i.e. the best cell is included first;
- 1> increment the *numberOfReportsSent* as defined within the *VarMeasReportList* for this *measId* by 1;
- 1> stop the periodical reporting timer, if running;
- 1> if the *numberOfReportsSent* as defined within the *VarMeasReportList* for this *measId* is less than the *reportAmount* as defined within the corresponding *reportConfig* for this *measId*:
 - 2> start the periodical reporting timer with the value of *reportInterval* as defined within the corresponding *reportConfig* for this *measId*;
- ...
- 1> if the UE is configured with EN-DC:
 - 2> if SRB3 is configured:
 - 3> submit the *MeasurementReport* message via SRB3 to lower layers for transmission, upon which the procedure ends;
 - 2> else:
 - 3> submit the *MeasurementReport* message via the EUTRA MCG embedded in E-UTRA RRC message *ULInformationTransferMRDC* as specified in TS 36.331 [10].

8.2.4.3.1.1.3 Test description

8.2.4.3.1.1.3.1 Pre-test conditions

System Simulator:

- E-UTRA Cell 1 is the PCell. NR Cell 1 is the PSCell and NR Cell 3 is the SCell to be added, NR Cell 12 is the intra-frequency neighbour cell of NR Cell 3.

UE:

None.

Preamble:

- The UE is in state RRC_CONNECTED using generic procedure parameter Connectivity (*EN-DC*) and DC bearers (*MCG(s)* and *SCG*) according to TS 38.508-1 [4], table 4.5.4.

8.2.4.3.1.1.3.2 Test procedure sequence

Table 8.2.4.3.1.1.3.2-1 and table 8.2.4.3.1.1.3.2-1A illustrates the downlink power levels to be applied for E-UTRA Cell 1, NR Cell 1, NR Cell 3 and NR Cell 12 at various time instants of the test execution. Row marked "T0" denotes the conditions after the preamble, while the configuration marked "T1" is applied at the point indicated in the Main behaviour description in Table 8.2.4.3.1.1.3.2-2.

Table 8.2.4.3.1.1.3.2-1: Power levels for FR1

| | Parameter | Unit | E-UTRA Cell 1 | NR Cell 1 | NR Cell 3 | NR Cell 12 | Remark |
|----|-----------------------|------------|---------------|-----------|-----------|------------|--|
| T0 | Cell-specific RS EPRE | dBm/15 kHz | -79 | - | - | - | Power levels are such that entry condition for event A6 is not satisfied for NR Cell 3 when being an SCell:
$Mn + Ocn + Hys < Ms + Ocs + Off$
but satisfied for NR Cell 12 when being an SCell:
$Mn + Ocn - Hys > Ms + Ocs + Off$ |
| | SS/PBCH SSS EPRE | dBm/S CS | - | -79 | -85 | -97 | |
| T1 | Cell-specific RS EPRE | dBm/15 kHz | -79 | - | - | - | Power levels are such that entry condition for event A6 is satisfied for NR Cell 3 when being an SCell:
$Mn + Ocn - Hys > Ms + Ocs + Off$
but not satisfied for NR Cell 12 when being an SCell:
$Mn + Ocn + Hys < Ms + Ocs + Off$ |
| | SS/PBCH SSS EPRE | dBm/S CS | - | -79 | -97 | -85 | |

Table 8.2.4.3.1.1.3.2-1A: Power levels for FR2

| | Parameter | Unit | E-UTRA Cell 1 | NR Cell 1 | NR Cell 3 | NR Cell 12 | Remark |
|----|-----------------------|------------|---------------|-----------|-----------|------------|--|
| T0 | Cell-specific RS EPRE | dBm/15 kHz | -96 | - | - | - | Power levels are such that entry condition for event A6 is not satisfied for NR Cell 3 when being an SCell:
$Mn + Ocn + Hys < Ms + Ocs + Off$
but satisfied for NR Cell 12 when being an SCell:
$Mn + Ocn - Hys > Ms + Ocs + Off$ |
| | SS/PBCH SSS EPRE | dBm/S CS | - | -91 | -91 | -100 | |
| T1 | Cell-specific RS EPRE | dBm/15 kHz | -96 | - | - | - | Power levels are such that entry condition for event A6 is satisfied for NR Cell 3 when being an SCell:
$Mn + Ocn - Hys > Ms + Ocs + Off$
but not satisfied for NR Cell 12 when being an SCell:
$Mn + Ocn + Hys < Ms + Ocs + Off$ |
| | SS/PBCH SSS EPRE | dBm/S CS | - | -91 | -100 | -91 | |

Table 8.2.4.3.1.1.3.2-2: Main behaviour

| St | Procedure | Message Sequence | | TP | Verdict |
|----|--|------------------|---|----|---------|
| | | U – S | Message | | |
| 1 | SS transmits an <i>RRCConnectionReconfiguration</i> message containing <i>RRCReconfiguration</i> message to configure SCell (NR Cell 3) and SRB3. | <-- | <i>RRCConnectionReconfiguration(RRCReconfiguration)</i> | - | - |
| 2 | The UE transmits an <i>RRCConnectionReconfigurationComplete</i> message containing <i>RRCReconfigurationComplete</i> message. | --> | <i>RRCConnectionReconfigurationComplete(RRCReconfigurationComplete)</i> | - | - |
| 3 | SS transmits an <i>RRCConnectionReconfiguration</i> message containing <i>RRCReconfiguration</i> message including <i>measConfig</i> to setup intra NR measurement and reporting for event A6 | <-- | <i>RRCConnectionReconfiguration(RRCReconfiguration)</i> | - | - |
| 4 | The UE transmits an <i>RRCConnectionReconfigurationComplete</i> message containing <i>RRCReconfigurationComplete</i> message. | --> | <i>RRCConnectionReconfigurationComplete(RRCReconfigurationComplete)</i> | - | - |
| 5 | SS re-adjusts the cell-specific reference signal level according to row "T1" in table 8.2.4.3.1.1.3.2-1/1A. | - | - | - | - |
| 6 | Check: Does the UE transmit a <i>MeasurementReport</i> message via SRB3 to report event A6 with the measured RSRP and RSRQ value for NR Cell 12? | --> | <i>MeasurementReport</i> | 1 | P |
| 7 | The SS transmits an <i>RRCReconfiguration</i> message including <i>sCellToReleaseList</i> with NR Cell 3 as SCell release and <i>sCellToAddModList</i> with NR Cell 12 as SCell addition via SRB3. | <-- | <i>RRCReconfiguration</i> | - | - |
| 8 | The UE transmits an <i>RRCReconfigurationComplete</i> message on NR Cell 1. | --> | <i>RRCReconfigurationComplete</i> | - | - |
| 9 | Check: Does the UE transmit a <i>MeasurementReport</i> message via SRB3 within the next 10s to report event A6? | --> | <i>MeasurementReport</i> | 2 | F |
| 10 | SS re-adjusts the cell-specific reference signal level according to row "T0" in table 8.2.4.3.1.1.3.2-1/1A. | - | - | - | - |
| 11 | Check: Does the UE transmit a <i>MeasurementReport</i> message via SRB3 to report event A6 with the measured RSRP and RSRQ value for NR Cell 3? | --> | <i>MeasurementReport</i> | 2 | P |

8.2.4.3.1.1.3.3 Specific message contents

Table 8.2.4.3.1.1.3.3-1: RRCConnectionReconfiguration (step 1, Table 8.2.4.3.1.1.3.2-2)

| |
|--|
| Derivation Path: TS 36.508 [7], Table 4.6.1-8 condition MCG_and_SCG. |
|--|

Table 8.2.4.3.1.1.3.3-2: RRCReconfiguration (step 1, Table 8.2.4.3.1.1.3.2-2)

| Derivation Path: TS 38.508-1 [4], Table 4.6.1-13. | | | |
|---|----------------------|---------|-----------|
| Information Element | Value/remark | Comment | Condition |
| RRCReconfiguration ::= SEQUENCE { | | | |
| criticalExtensions CHOICE { | | | |
| rrcReconfiguration SEQUENCE { | | | |
| secondaryCellGroup | CellGroupConfig-SRB3 | | |
| } | | | |
| } | | | |
| } | | | |

Table 8.2.4.3.1.1.3.3-3: CellGroupConfig-SRB3 (Table 8.2.4.3.1.1.3.3-2)

| Derivation Path: TS 38.508-1 [4], Table 4.8.1-2A. | | | |
|---|--|---------------------------------|-----------|
| Information Element | Value/remark | Comment | Condition |
| CellGroupConfig ::= SEQUENCE { | | | |
| rlc-BearerToAddModList SEQUENCE (SIZE(1..maxLC-ID)) OF RLC-BearerConfig { | 2 entries | | |
| RLC-BearerConfig[1] | RLC-BearerConfig with conditions AM and DRB2 | entry 1 | |
| RLC-BearerConfig[2] | RLC-BearerConfig with condition SRB3 | entry 2 | |
| } | | | |
| sCellToAddModList SEQUENCE (SIZE(1..maxMeasId)) OF SCellConfig { | 1 entry | | |
| SCellConfig[1] SEQUENCE { | | entry 1 | |
| sCellIndex | 2 | | |
| sCellConfigCommon | ServingCellConfigCommon | | |
| sCellConfigDedicated | ServingCellConfig | TS 38.508-1 [4] table 4.6.3-167 | |
| } | | | |
| } | | | |
| } | | | |

Table 8.2.4.3.1.1.3.3-4: ServingCellConfigCommon (Table 8.2.4.3.1.1.3.3-3)

| Derivation Path: TS 38.508-1 [4], Table 4.6.3-168. | | | |
|--|-------------------------------------|---------|-----------|
| Information Element | Value/remark | Comment | Condition |
| ServingCellConfigCommon ::= SEQUENCE { | | | |
| PhysCellId | Physical Cell Identity of NR Cell 3 | | |
| } | | | |

Table 8.2.4.3.1.1.3.3-5: RRCReconfiguration (step 3, Table 8.2.4.3.1.1.3.2-2)

| |
|---|
| Derivation Path: TS 38.508-1 [4], Table 4.6.1-13 with condition EN-DC_MEAS. |
|---|

Table 8.2.4.3.1.1.3.3-6: *MeasConfig* (Table 8.2.4.3.1.1.3.3-5)

| Derivation path: TS 38.508-1 [4], Table 4.6.3-69. | | | |
|---|---|--|-----------|
| Information Element | Value/Remark | Comment | Condition |
| measConfig ::= SEQUENCE { | | | |
| measObjectToAddModList SEQUENCE (SIZE (1..maxNrofObjectId)) OF MeasObjectToAddMod { | 2 entries | | |
| MeasObjectToAddMod[1] SEQUENCE { | | entry 1 | |
| measObjectId | 1 | NR Cell 1 | |
| measObject CHOICE { | | | |
| measObjectNR | MeasObjectNR(60) | ssbFrequency IE equals the ARFCN for NR Cell 1
Thresh value set to -97dBm | |
| } | | | |
| } | | | |
| MeasObjectToAddMod[2] SEQUENCE { | | entry 2 | |
| measObjectId | 2 | NR Cell 3 | |
| measObject CHOICE { | | | |
| measObjectNR | MeasObjectNR(67) | ssbFrequency IE equals the ARFCN for NR Cell 3
Thresh value set to -90dBm | FR1 |
| | MeasObjectNR(62) | ssbFrequency IE equals the ARFCN for NR Cell 3
Thresh value set to -95dBm | FR2 |
| } | | | |
| } | | | |
| } | | | |
| reportConfigToAddModList SEQUENCE (SIZE (1..maxReportConfigId)) OF ReportConfigToAddMod { | 1 entry | | |
| ReportConfigToAddMod[1] SEQUENCE { | | entry 1 | |
| reportConfigId | 1 | | |
| reportConfig CHOICE { | | | |
| reportConfigNR | ReportConfigNR(Delta(NRf2) – Delta(NRf1)) | See Table 8.2.4.3.1.1.3.3-6A | |
| } | | | |
| } | | | |
| measIdToAddModList SEQUENCE (SIZE (1..maxMeasId)) OF MeasIdToAddMod { | 1 entry | | |
| MeasIdToAddMod[1] SEQUENCE { | | entry 1 | |
| measId | 1 | | |
| measObjectId | 2 | | |
| reportConfigId | 1 | | |
| } | | | |
| } | | | |
| } | | | |

NOTE 1: Delta(NRf1) and Delta(NRf2) is derived based on calibration procedure defined in the TS 38.508-1 [4], clause 6.1.3.3

Table 8.2.4.3.1.1.3.3-6A: ReportConfigNR (Table 8.2.4.3.1.1.3.3-6)

| Derivation path: TS 38.508-1 [4], Table 4.6.3-142 condition EVENT_A6 | | | |
|--|--------------|---------|-----------|
| Information Element | Value/remark | Comment | Condition |
| ReportConfigNR ::= SEQUENCE { | | | |
| reportType CHOICE { | | | |
| eventTriggered SEQUENCE { | | | |
| reportAmount | r1 | | |
| } | | | |
| } | | | |
| } | | | |

Table 8.2.4.3.1.1.3.3-7: *MeasurementReport* (step 6, Table 8.2.4.3.1.1.3.2-2)

| Derivation Path: TS 38.508-1 [4], Table 4.6.1-5A. | | | |
|--|----------------------------|-------------------|-----------------|
| Information Element | Value/remark | Comment | Condition |
| MeasurementReport ::= SEQUENCE { | | | |
| criticalExtensions CHOICE { | | | |
| measurementReport SEQUENCE { | | | |
| measResults SEQUENCE { | | | |
| measId | 1 | | |
| measResultServingMOListSEQUENCE(SIZE (1..maxNrofServingCells)) OF MeasResultServMO { | 2 entries | | |
| MeasResultServMO[1] SEQUENCE { | | entry 1 | |
| servCellId | ServCellIndex of NR Cell 1 | | |
| measResultServingCell SEQUENCE { | | Report NR Cell 1 | |
| physCellId | physCellId of NR Cell 1 | | |
| measResult SEQUENCE { | | | |
| cellResults SEQUENCE { | | | |
| resultsSSB-Cell SEQUENCE { | | | |
| rsrp | (0..127) | | |
| rsrq | (0..127) | | |
| sinr | (0..127) | | pc_ss_SINR Meas |
| Not present | | | |
| } | | | |
| } | | | |
| } | | | |
| } | | | |
| MeasResultServMO[2] SEQUENCE { | | entry 2 | |
| servCellId | ServCellIndex of NR Cell 3 | | |
| measResultServingCell SEQUENCE { | | Report NR Cell 3 | |
| physCellId | physCellId of NR Cell 3 | | |
| measResult SEQUENCE { | | | |
| cellResults SEQUENCE { | | | |
| resultsSSB-Cell SEQUENCE { | | | |
| rsrp | (0..127) | | |
| rsrq | (0..127) | | |
| sinr | (0..127) | | pc_ss_SINR Meas |
| Not present | | | |
| } | | | |
| } | | | |
| } | | | |
| } | | | |
| measResultNeighCells CHOICE { | | | |
| measResultListNR[1] SEQUENCE { | | Report NR Cell 12 | |
| physCellId | physCellId of NR Cell 12 | | |
| measResult SEQUENCE { | | | |
| cellResults SEQUENCE { | | | |
| resultsSSB-Cell SEQUENCE { | | | |
| rsrp | (0..127) | | |
| rsrq | (0..127) | | |
| sinr | (0..127) | | pc_ss_SINR Meas |
| Not present | | | |
| } | | | |
| } | | | |
| } | | | |
| } | | | |
| resultsCSI-RS-Cell | Not present | | |
| } | | | |
| rsIndexResults | Not present | | |
| } | | | |
| cgi-Info | Not present | | |
| } | | | |

| | | | |
|---|--|--|--|
| } | | | |
| } | | | |
| } | | | |
| } | | | |
| } | | | |

Table 8.2.4.3.1.1.3.3-8: RRCReconfiguration (step 7, Table 8.2.4.3.1.1.3.2-2)

| Derivation Path: 38.508-1 [4], Table 4.6.1-13. | | | |
|--|----------------------|---------|-----------|
| Information Element | Value/remark | Comment | Condition |
| RRCReconfiguration ::= SEQUENCE { | | | |
| criticalExtensions CHOICE { | | | |
| rrcReconfiguration SEQUENCE { | | | |
| SecondaryCellGroup | CellGroupConfig-SRB3 | | |
| } | | | |
| } | | | |
| } | | | |

Table 8.2.4.3.1.1.3.3-9: CellGroupConfig-SRB3 (Table 8.2.4.3.1.1.3.3-8)

| Derivation Path: 38.508-1 [4], Table 4.8.1-2A. | | | |
|---|-------------------------|------------------------------------|-----------|
| Information Element | Value/remark | Comment | Condition |
| CellGroupConfig ::= SEQUENCE { | | | |
| sCellToAddModList SEQUENCE (SIZE (1..maxNrofSCells)) OF SCellConfig { | 1 entry | | |
| SCellConfig[1] SEQUENCE { | | entry 1 | |
| sCellIndex | 3 | | |
| sCellConfigCommon | ServingCellConfigCommon | | |
| sCellConfigDedicated | ServingCellConfig | TS 38.508-1 [4]
table 4.6.3-167 | |
| } | | | |
| sCellToReleaseList SEQUENCE (SIZE (1..maxNrofSCells)) OF SCellIndex { | 1 entry | | |
| SCellIndex[1] | 2 | entry 1 | |
| } | | | |
| } | | | |
| Note: ServingCellIMO equal to the released SCell NR Cell 3. | | | |

Table 8.2.4.3.1.1.3.3-10: ServingCellConfigCommon (Table 8.2.4.3.1.1.3.3-9)

| Derivation Path: TS 38.508-1 [4], Table 4.6.3-168. | | | |
|--|--------------------------------------|---------|-----------|
| Information Element | Value/remark | Comment | Condition |
| ServingCellConfigCommon ::= SEQUENCE { | | | |
| PhysCellId | Physical Cell Identity of NR Cell 12 | | |
| } | | | |

Table 8.2.4.3.1.1.3.3-11: *MeasurementReport* (step 11, Table 8.2.4.3.1.1.3.2-2)

| Derivation Path: TS 38.508-1 [4], Table 4.6.1-5A. | | | |
|---|-----------------------------|-------------------|-----------------|
| Information Element | Value/remark | Comment | Condition |
| MeasurementReport ::= SEQUENCE { | | | |
| criticalExtensions CHOICE { | | | |
| measurementReport SEQUENCE { | | | |
| measResults SEQUENCE { | | | |
| measId | 1 | | |
| measResultServingMOList SEQUENCE(SIZE (1..maxNrofServingCells)) OF MeasResultServMO { | 2 entries | | |
| MeasResultServMO[1] SEQUENCE { | | entry 1 | |
| servCellId | ServCellIndex of NR Cell 1 | | |
| measResultServingCell SEQUENCE { | | Report NR Cell 1 | |
| physCellId | physCellId of NR Cell 1 | | |
| measResult SEQUENCE { | | | |
| cellResults SEQUENCE { | | | |
| resultsSSB-Cell SEQUENCE { | | | |
| rsrp | (0..127) | | |
| rsrq | (0..127) | | |
| sinr | (0..127) | | pc_ss_SINR Meas |
| Not present | | | |
| } | | | |
| } | | | |
| } | | | |
| MeasResultServMO[2] SEQUENCE { | | entry 2 | |
| servCellId | ServCellIndex of NR Cell 12 | | |
| measResultServingCell SEQUENCE { | | Report NR Cell 12 | |
| physCellId | physCellId of NR Cell 12 | | |
| measResult SEQUENCE { | | | |
| cellResults SEQUENCE { | | | |
| resultsSSB-Cell SEQUENCE { | | | |
| rsrp | (0..127) | | |
| rsrq | (0..127) | | |
| sinr | (0..127) | | pc_ss_SINR Meas |
| Not present | | | |
| } | | | |
| } | | | |
| } | | | |
| } | | | |
| } | | | |
| } | | | |
| } | | | |
| measResultNeighCells CHOICE { | | | |
| measResultListNR SEQUENCE (SIZE (1..maxCellReport)) OF MeasResultNR { | 1 entry | Report NR Cell 3 | |
| MeasResultNR[1] SEQUENCE { | | entry 1 | |
| physCellId | physCellId of NR Cell 3 | | |
| measResult SEQUENCE { | | | |
| cellResults SEQUENCE { | | | |
| resultsSSB-Cell SEQUENCE { | | | |
| rsrp | (0..127) | | |
| rsrq | (0..127) | | |
| sinr | (0..127) | | pc_ss_SINR Meas |
| Not present | | | |
| } | | | |
| } | | | |
| } | | | |
| resultsCSI-RS-Cell | Not present | | |
| } | | | |
| rsIndexResults | Not present | | |

| | | | |
|----------|-------------|--|--|
| } | | | |
| cgi-Info | Not present | | |
| } | | | |
| } | | | |
| } | | | |
| } | | | |
| } | | | |
| } | | | |
| } | | | |

8.2.4.3.1.2 NR CA / SCell change / Intra-NR measurement event A6 / SRB3 / EN-DC / Intra-band non-Contiguous CA

The scope and description of the present TC is the same as test case 8.2.4.3.1.1 with the following differences:

- CA configuration: Intra-band non-contiguous CA replaces Intra-band Contiguous CA

8.2.4.3.1.3 NR CA / SCell change / Intra-NR measurement event A6 / SRB3 / EN-DC / Inter-band CA

8.2.4.3.1.3.1 Test Purpose (TP)

Same as TC 8.2.4.3.1.1 but applied to Inter-band CA case.

8.2.4.3.1.3.2 Conformance requirements

Same as TC 8.2.4.3.1.1.

8.2.4.3.1.3.3 Test description

8.2.4.3.1.3.3.1 Pre-test conditions

Same as test case 8.2.4.3.1.1 with the following differences:

- Cells configuration: NR Cell 10 replaces NR Cell 3, NR Cell 30 replaces NR Cell 12

8.2.4.3.1.3.3.2 Test procedure sequence

Same as test case 8.2.4.3.1.1 with the following differences:

- Cells configuration: NR Cell 10 replaces NR Cell 3, NR Cell 30 replaces NR Cell 12

8.2.4.3.1.3.3.3 Specific message contents

Table 8.2.4.3.1.3.3-1: *MeasConfig* (Table 8.2.4.3.1.1.3.3-6)

| Derivation path: TS 38.508-1 [4], Table 4.6.3-69. | | | |
|---|---|---|-----------|
| Information Element | Value/Remark | Comment | Condition |
| measConfig ::= SEQUENCE { | | | |
| measObjectToAddModList SEQUENCE (SIZE (1..maxNrofObjectId)) OF MeasObjectToAddMod { | 2 entries | | |
| MeasObjectToAddMod[1] SEQUENCE { | | entry 1 | |
| measObjectId | 1 | NR Cell 1 | |
| measObject CHOICE { | | | |
| measObjectNR | MeasObjectNR(60) | ssbFrequency IE equals the ARFCN for NR Cell 1
Thresh value set to -97dBm | |
| } | | | |
| } | | | |
| MeasObjectToAddMod[2] SEQUENCE { | | entry 2 | |
| measObjectId | 2 | NR Cell 10 | |
| measObject CHOICE { | | | |
| measObjectNR | MeasObjectNR(67) | ssbFrequency IE equals the ARFCN for NR Cell 10
Thresh value set to -90dBm | FR1 |
| | MeasObjectNR(62) | ssbFrequency IE equals the ARFCN for NR Cell 10
Thresh value set to -95dBm | FR2 |
| } | | | |
| } | | | |
| reportConfigToAddModList SEQUENCE (SIZE (1..maxReportConfigId)) OF ReportConfigToAddMod { | 1 entry | | |
| ReportConfigToAddMod[1] SEQUENCE { | | entry 1 | |
| reportConfigId | 1 | | |
| reportConfig CHOICE { | | | |
| reportConfigNR | ReportConfigNR(2) | TS 38.508-1 [4] table 4.6.3-142 condition EVENT_A6 | FR1 |
| reportConfigNR | ReportConfigNR(Delta(NRf2) – Delta(NRf1)) | TS 38.508-1 [4] table 4.6.3-142 condition EVENT_A6 | FR2 |
| } | | | |
| } | | | |
| measIdToAddModList SEQUENCE (SIZE (1..maxMeasId)) OF MeasIdToAddMod { | 1 entry | | |
| MeasIdToAddMod[1] SEQUENCE { | | entry 1 | |
| measId | 1 | | |
| measObjectId | 2 | | |
| reportConfigId | 1 | | |
| } | | | |
| } | | | |
| } | | | |

8.2.5 Reconfiguration Failure / Radio link failure

8.2.5.1 Radio link failure / PSCell addition failure

8.2.5.1.1 Radio link failure / Random access problem / EN-DC

8.2.5.1.1.1 Test Purpose (TP)

(1)

```
with { UE in RRC_CONNECTED state with EN-DC, and, MCG(s) (E-UTRA PDCP) and SCG }
ensure that {
  when { UE receives an IP Packet to loopback on SCG DRB and the SS does not respond to the
Scheduling Requests from UE }
  then { UE encounters random access problem and initiates the NR SCG failure information
procedure to report SCGFailureInformationNR with failure type randomAccessProblem }
}
```

8.2.5.1.1.2 Conformance requirements

References: The conformance requirements covered in the present TC are specified in: TS 36.331, clauses 5.6.13a.3, TS 38.331, clauses 5.3.10.3, 5.7.3.2, 5.7.3.3. Unless otherwise stated these are Rel-15 requirements.

[TS 36.331, clause 5.6.13a.3]

The UE shall set the contents of the *SCGFailureInformationNR* message as follows:

- 1> include *failureType* within *failureReportSCG-NR* and set it to indicate the SCG failure in accordance with TS 38.331 [82], clause 5.7.3.3;

...

The UE shall submit the *SCGFailureInformationNR* message to lower layers for transmission.

[TS 38.331, clause 5.3.10.3]

The UE shall:

...

- 1> upon random access problem indication from SCG MAC; or

...

- 3> consider radio link failure to be detected for the SCG i.e. SCG-RLF;

- 3> initiate the SCG failure information procedure as specified in 5.7.3 to report SCG radio link failure.

[TS 38.331, clause 5.7.3.2]

A UE initiates the procedure to report SCG failures when SCG transmission is not suspended and when one of the following conditions is met:

...

- 1> upon SCG configuration failure, in accordance with subclause 5.3.5.8.2;

...

Upon initiating the procedure, the UE shall:

- 1> suspend SCG transmission for all SRBs and DRBs;

- 1> reset SCG-MAC;

- 1> stop T304, if running;

1> if the UE is operating in EN-DC:

2> initiate transmission of the *SCGFailureInformationNR* message as specified in TS 36.331 [10], clause 5.6.13a.

[TS 38.331, clause 5.7.3.3]

The UE shall set the SCG failure type as follows:

...

1> else if the UE initiates transmission of the *SCGFailureInformationNR* message to provide random access problem indication from SCG MAC:

2> set the failureType as randomAccessProblem;

8.2.5.1.1.3 Test description

8.2.5.1.1.3.1 Pre-test conditions

System Simulator:

- E-UTRA Cell 1 is the PCell and NR Cell 1 is the PSCell.

UE:

- None.

Preamble:

- The UE is in state RRC_CONNECTED using generic procedure parameter Connectivity (*EN-DC*) and Bearers (*MCG(s) and SCG*) established and Test Loop Function (On) with UE test loop mode B according to TS 38.508-1 [4], clause 4.5.4.

8.2.5.1.1.3.2 Test procedure sequence

Table 8.2.5.1.1.3.2-1: Main behaviour

| St | Procedure | Message Sequence | | TP | Verdict |
|--|---|------------------|--------------------------------|----|---------|
| | | U - S | Message | | |
| 1 | The SS shall not respond to the Scheduling Requests for the IP Packet transmitted at next step (Note) | - | - | - | - |
| 2 | The SS transmits one IP Packet on SCG DRB | - | - | - | - |
| 3 | The SS shall not respond to the PRACH Preambles thereby simulating a random access problem. | - | - | - | - |
| 4 | Check: Does the UE transmit in the next 5 sec (arbitrary value) a <i>SCGFailureInformationNR</i> message with <i>failureType</i> set to ' <i>randomAccessProblem</i> '? | --> | <i>SCGFailureInformationNR</i> | 1 | P |
| Note: The UE initiates random access procedure once SR number of attempts reach sr-transMax. | | | | | |

Table 8.2.5.1.1.3.2-2: Void

Table 8.2.5.1.1.3.2-3: Void

8.2.5.1.1.3.3 Specific message contents

Table 8.2.5.1.1.3.3-1: Void

Table 8.2.5.1.1.3.3-2: Void

Table 8.2.5.1.1.3.3-3: Void

Table 8.2.5.1.1.3.3-4: Void

Table 8.2.5.1.1.3.3-5: SCGFailureInformationNR (step 4, Table 8.2.5.1.1.3.2-1)

| Derivation Path: 36.508 [7], Table 4.6.1-18AA | | | |
|---|---------------------|---------|-----------|
| Information Element | Value/remark | Comment | Condition |
| SCGFailureInformationNR-r15 ::= SEQUENCE { | | | |
| criticalExtensions CHOICE { | | | |
| c1 CHOICE { | | | |
| scgFailureInformationNR-r15 SEQUENCE { | | | |
| failureReportSCG-NR-r15 SEQUENCE { | | | |
| failureType-r15 | randomAccessProblem | | |
| measResultFreqListNR-r15 | Not checked | | |
| measResultSCG-r15 | Not checked | | |
| } | | | |
| nonCriticalExtension SEQUENCE {} | | | |
| } | | | |
| } | | | |
| } | | | |

8.2.5.1.2 Radio link failure / Random access problem / NR-DC

8.2.5.1.2.1 Test Purpose (TP)

(1)

```
with { UE in NR RRC_CONNECTED state with NR-DC }
ensure that {
  when { UE receives an IP Packet to loopback on SCG DRB and the SS stops transmitting Timing
Advance Command and does not respond to the Scheduling Requests from UE }
  then { UE encounters random access problem and initiates the SCG failure information procedure
to report SCGFailureInformationNR with failure type randomAccessProblem }
}
```

8.2.5.1.2.2 Conformance requirements

References: The conformance requirements covered in the present TC are specified in: TS 38.331, clauses 5.7.3.2, 5.3.10.3, 5.7.3.3. Unless otherwise stated these are Rel-15 requirements.

[TS 38.331, clauses 5.7.3.2]

A UE initiates the procedure to report SCG failures when neither MCG nor SCG transmission is suspended and when one of the following conditions is met:

1> upon detecting radio link failure for the SCG, in accordance with subclause 5.3.10.3;

...

Upon initiating the procedure, the UE shall:

1> suspend SCG transmission for all SRBs and DRBs;

1> reset SCG MAC;

- 1> stop T304 for the SCG, if running;
- 1> stop conditional reconfiguration evaluation for CPC, if configured;
- 1> if the UE is in (NG)EN-DC:
 - 2> initiate transmission of the *SCGFailureInformationNR* message as specified in TS 36.331 [10], clause 5.6.13a.
- 1> else:
 - 2> initiate transmission of the *SCGFailureInformation* message in accordance with 5.7.3.5.

[TS 38.331, clause 5.3.10.3]

The UE shall:

- ...
- 1> upon consistent uplink LBT failure indication from SCG MAC:
 - ...
 - 3> consider radio link failure to be detected for the SCG, i.e. SCG RLF;
 - 3> if MCG transmission is not suspended:
 - 4> initiate the SCG failure information procedure as specified in 5.7.3 to report SCG radio link failure.

[TS 38.331, clause 5.7.3.3]

The UE shall set the SCG failure type as follows:

- 1...
- 1> else if the UE initiates transmission of the *SCGFailureInformationNR* message to provide random access problem indication from SCG MAC:
 - 2> if the random access procedure was initiated for beam failure recovery:
 - 3> set the *failureType* as *other* and set the *failureType-v1610* as *beamFailureRecoveryFailure*;
 - 2> else:
 - 3> set the *failureType* as *randomAccessProblem*;

8.2.5.1.2.3 Test description

8.2.5.1.2.3.1 Pre-test conditions

System Simulator:

- NR Cell 1 is the PCell, NR Cell 10 is the PSCell
- System information combination NR-4 as defined in TS 38.508-1 [4] clause 4.4.3.1.2 is used in NR cells.

UE:

- None.

Preamble:

- The UE is in state NR RRC_CONNECTED using generic procedure parameter Connectivity (NR-DC) according to TS 38.508-1 [4], Table 4.5.1-1, and with UE test loop mode B prepared, as defined in TS 38.508-1 [4], subclause 4.4A.

8.2.5.1.2.3.2 Test procedure sequence

Table 8.2.5.1.2.3.2-1: Main behaviour

| St | Procedure | Message Sequence | | TP | Verdict |
|----|---|------------------|--------------------------------|----|---------|
| | | U - S | Message | | |
| 1 | The SS shall not respond to the Scheduling Requests for the IP Packet transmitted at next step (Note) | - | - | - | - |
| 2 | The SS transmits one IP Packet on SCG DRB | - | - | - | - |
| 3 | The SS shall not respond to the PRACH Preambles thereby simulating a random access problem. | - | - | - | - |
| 4 | Check: Does the UE transmit in the next 5 sec (arbitrary value) a <i>SCGFailureInformationNR</i> message with <i>failureType</i> set to ' <i>randomAccessProblem</i> '? | --> | <i>SCGFailureInformationNR</i> | 1 | P |

Note: The UE initiates random access procedure once SR number of attempts reach sr-transMax.

8.2.5.1.2.3.3 Specific message contents

Table 8.2.5.1.2.3.3-1: *SCGFailureInformationNR* (step 4, Table 8.2.5.1.2.3.2-1)

| Derivation Path: TS 38.508-1 [4], Table 4.6.1-24A | | | |
|---|------------------|-----------------------|-----------|
| Information Element | Value/remark | Comment | Condition |
| SCGFailureInformation ::= SEQUENCE { | | | |
| criticalExtensions CHOICE { | | | |
| scgFailureInformation SEQUENCE { | | | |
| failureReportSCG | FailureReportSCG | Table 8.2.5.1.2.3.3-2 | |
| nonCriticalExtension | Not checked | | |
| } | | | |
| } | | | |
| } | | | |

Table 8.2.5.1.2.3.3-2: FailureReportSCG (Table 8.2.5.1.2.3.3-1)

| Derivation Path: TS 38.331[4], clause 6.2.2 | | | |
|---|---------------------|---------|-----------|
| Information Element | Value/remark | Comment | Condition |
| FailureReportSCG-NR-r15 ::= SEQUENCE { | | | |
| failureType-r15 | randomAccessProblem | | |
| measResultFreqListNR-r15 | Not checked | | |
| measResultSCG-r15 | Not checked | | |
| } | | | |

8.2.5.2 Radio link failure / PSCell out of sync indication

8.2.5.2.1 Radio link failure / PSCell out of sync indication / EN-DC

8.2.5.2.1.1 Test Purpose (TP)

(1)

```

with { UE in RRC_CONNECTED state with EN-DC, and, MCG(s) (E-UTRA PDCP) and SCG DRB established }
ensure that {
  when { UE receives N310 consecutive "out-of-sync" indications for the SpCell from lower layers due
to radio link failure }
  then { UE starts timer T310 for the corresponding SpCell, and, upon timer expiry initiates the
NR SCG failure information procedure to report SCGFailureInformationNR with failure type set to
't310-Expiry' }
}

```

8.2.5.2.1.2 Conformance requirements

References: The conformance requirements covered in the present test case are specified in: TS 36.331, clause 5.6.13a.3, TS 38.331, clauses 5.3.10.1, 5.3.10.3, 5.7.3.2, 5.7.3.3. Unless otherwise stated these are Rel-15 requirements.

[TS 36.331, clause 5.6.13a.3]

The UE shall set the contents of the *SCGFailureInformationNR* message as follows:

- 1> include *failureType* within *failureReportSCG-NR* and set it to indicate the SCG failure in accordance with TS 38.331 [82, 5.7.3.3];

...

The UE shall submit the *SCGFailureInformationNR* message to lower layers for transmission.

[TS 38.331, clause 5.3.10.1]

The UE shall:

- 1> upon receiving N310 consecutive "out-of-sync" indications for the SpCell from lower layers while T311 is not running;
- 2> start timer T310 for the corresponding SpCell.

[TS 38.331, clause 5.3.10.3]

The UE shall:

- 1> upon T310 expiry in PSCell; or
- ...
- 2> initiate the SCG failure information procedure as specified in 5.7.3 to report SCG radio link failure.

[TS 38.331, clause 5.7.3.2]

A UE initiates the procedure to report SCG failures when SCG transmission is not suspended and when one of the following conditions is met:

- 1> upon detecting radio link failure for the SCG, in accordance with subclause 5.3.10.3;

...

Upon initiating the procedure, the UE shall:

- 1> suspend SCG transmission for all SRBs and DRBs;
- 1> reset SCG-MAC;
- 1> stop T304, if running;
- 1> if the UE is operating in EN-DC:
 - 2> initiate transmission of the *SCGFailureInformationNR* message as specified in TS 36.331 [10, 5.6.13a].

[TS 38.331, clause 5.7.3.3]

The UE shall set the SCG failure type as follows:

- 1> if the UE initiates transmission of the *SCGFailureInformationNR* message due to T310 expiry:
 - 2> set the *failureType* as t310-Expiry;

8.2.5.2.1.3 Test description

8.2.5.2.1.3.1 Pre-test conditions

System Simulator:

- E-UTRA Cell 1 is the PCell and NR Cell 1 is the PSCell.

UE:

- None.

Preamble:

- The UE is in state RRC_CONNECTED using generic procedure parameter Connectivity (EN-DC) and DC Bearers (MCG(s) and SCG) on E-UTRA Cell 1 according to TS 38.508-1 [4], clause 4.5.4.

8.2.5.2.1.3.2 Test procedure sequence

Table 8.2.5.2.1.3.3-0A: RRCReconfiguration (Preamble)

| Derivation path: 38.508-1 [4], Table 4.6.1-13 | | | |
|---|-----------------|--------------|-----------|
| Information Element | Value/remark | Comment | Condition |
| RRCReconfiguration ::= SEQUENCE { | | | |
| criticalExtensions CHOICE { | | | |
| rrcReconfiguration SEQUENCE { | | | |
| secondaryCellGroup | CellGroupConfig | OCTET STRING | |
| } | | | |
| } | | | |
| } | | | |

Table 8.2.5.2.1.3.3-0B: CellGroupConfig (Table 8.2.5.2.1.3.3-0A: RRCReconfiguration)

| Derivation Path: TS 38.508-1 [4], Table 4.6.3-19 | | | |
|--|-------------------|---------|-----------|
| Information Element | Value/remark | Comment | Condition |
| CellGroupConfig ::= SEQUENCE { | | | |
| spCellConfig SEQUENCE { | | | |
| spCellConfigDedicated | ServingCellConfig | | |
| } | | | |
| } | | | |

Table 8.2.5.2.1.3.3-0E: RadioLinkMonitoringConfig (Table 8.2.5.2.1.3.3-0D: BWP-DownlinkDedicated)

| Derivation Path: TS 38.508-1 [4], Table 4.6.3-133 | | | |
|---|--------------|---------|-----------|
| Information Element | Value/remark | Comment | Condition |
| RadioLinkMonitoringConfig ::= SEQUENCE { | | | |
| failureDetectionResourcesToAddModList | 1 entry | | |
| SEQUENCE | | | |
| (SIZE(1..maxNrofFailureDetectionResources)) OF | | | |
| RadioLinkMonitoringRS { | | | |
| RadioLinkMonitoringRS[1] SEQUENCE { | | entry 1 | |
| radioLinkMonitoringRS-Id | 0 | | |
| purpose | rif | | |
| detectionResource CHOICE { | | | |
| ssb-Index | 1 | | |
| } | | | |
| } | | | |
| failureDetectionResourcesToReleaseList | Not present | | |
| beamFailureInstanceMaxCount | Not present | | |
| beamFailureDetectionTimer | Not present | | |
| } | | | |

Table 8.2.5.2.1.3.2-1: Main behaviour

| St | Procedure | Message Sequence | | TP | Verdict |
|---|---|------------------|--------------------------------|----|---------|
| | | U - S | Message | | |
| 1 | The SS changes NR Cell 1 parameter to non-suitable "Off" in order to simulate radio link failure. | - | - | - | - |
| 2 | Void. | - | - | - | - |
| 3 | Check: Does the UE transmit in the next 5 sec (NOTE 1) a <i>SCGFailureInformationNR</i> message with <i>failureType</i> set to 't310-Expiry'? | --> | <i>SCGFailureInformationNR</i> | 1 | P |
| NOTE 1: The time of 5 sec is chosen arbitrary. When the UE will send the Failure report depends on (1) the values pre-set for N310 and T310 (see TS 38.508-1 [4], <i>RLF-TimersAndConstants</i> - set at the moment to 'n1' and 'ms1000' respectively), and, (2) the time it will take for the SS to complete step 1 and the UE to notice the change and perform internally all relevant to it actions. Because of the uncertainties associated with (2), and, the lower values used in typical network setting for (1), testing if the UE obeys the exact values of (1) is unreliable. | | | | | |

Table 8.2.5.2.1.3.3-3: ServingCellConfig (Table 8.2.5.2.1.3.3-0B: CellGroupConfig)

| Derivation Path: TS 38.508-1 [4], Table 4.6.3-167 | | | |
|---|-----------------------|---------|-----------|
| Information Element | Value/remark | Comment | Condition |
| ServingCellConfig ::= SEQUENCE { | | | |
| initialDownlinkBWP | BWP-DownlinkDedicated | | |
| } | | | |

Table 8.2.5.2.1.3.3-4: BWP-DownlinkDedicated (Table 8.2.5.2.1.3.3-0C: ServingCellConfig)

| Derivation Path: TS 38.508-1 [4], Table 4.6.3-11 | | | |
|--|---------------------------|---------|-----------|
| Information Element | Value/remark | Comment | Condition |
| BWP-DownlinkDedicated ::= SEQUENCE { | | | |
| radioLinkMonitoringConfig | RadioLinkMonitoringConfig | | |
| } | | | |

8.2.5.2.1.3.3 Specific message contents

Table 8.2.5.2.1.3.3-1: SCGFailureInformationNR (step 3, Table 8.2.5.2.1.3.2-1)

| Derivation Path: 36.508 [7], Table 4.6.1-18AA | | | |
|---|--------------|---------|-----------|
| Information Element | Value/remark | Comment | Condition |
| SCGFailureInformationNR-r15 ::= SEQUENCE { | | | |
| criticalExtensions CHOICE { | | | |
| c1 CHOICE { | | | |
| scgFailureInformationNR-r15 SEQUENCE { | | | |
| failureReportSCG-NR-r15 SEQUENCE { | | | |
| failureType-r15 | t310-Expiry | | |
| measResultFreqListNR-r15 | Not checked | | |
| measResultSCG-r15 | Not present | | |
| } | | | |
| nonCriticalExtension SEQUENCE {} | | | |
| } | | | |
| } | | | |
| } | | | |
| } | | | |

8.2.5.2.2 Radio link failure / PSCell out of sync indication / NR-DC

8.2.5.2.2.1 Test Purpose (TP)

(1)

```

with { UE in NR RRC_CONNECTED state with NR-DC }
ensure that {
  when { UE detects out of sync on PSCell }
  then { UE initiates the NR SCG failure information procedure to report SCGFailureInformation
with failure type t310-Expiry }
}

```

8.2.5.2.2.2 Conformance requirements

References: The conformance requirements covered in the present TC are specified in: TS 38.331, clause 5.3.10.3, 5.7.3.2, 5.7.3.3, 5.7.3.4 and 5.7.3.5. Unless otherwise stated these are Rel-15 requirements.

[TS 38.331, 5.3.10.3]

The UE shall:

1> upon T310 expiry in PSCell; or

...

2> else:

3> consider radio link failure to be detected for the SCG, i.e. SCG RLF;

3> if MCG transmission is not suspended:

4> initiate the SCG failure information procedure as specified in 5.7.3 to report SCG radio link failure.

3> else:

4> if the UE is in NR-DC:

5> initiate the connection re-establishment procedure as specified in 5.3.7;

4> else (the UE is in (NG)EN-DC):

5> initiate the connection re-establishment procedure as specified in TS 36.331 [10], clause 5.3.7;

[TS 38.331, clause 5.7.3.2]

A UE initiates the procedure to report SCG failures when neither MCG nor SCG transmission is suspended and when one of the following conditions is met:

1> upon detecting radio link failure for the SCG, in accordance with subclause 5.3.10.3;

...

Upon initiating the procedure, the UE shall:

...

1> if the UE is in (NG)EN-DC:

2> initiate transmission of the *SCGFailureInformationNR* message as specified in TS 36.331 [10], clause 5.6.13a.

1> else:

2> initiate transmission of the *SCGFailureInformation* message in accordance with 5.7.3.5.

[TS 38.331, clause 5.7.3.3]

The UE shall set the SCG failure type as follows:

1> if the UE initiates transmission of the *SCGFailureInformationNR* message due to T310 expiry:

2> set the *failureType* as t310-Expiry;

[TS 38.331, clause 5.7.3.4]

The UE shall set the contents of the *MeasResultSCG-Failure* as follows:

1> for each *MeasObjectNR* configured on NR SCG for which a *measId* is configured and measurement results are available:

2> include an entry in *measResultPerMOList*;

2> if there is a *measId* configured with the *MeasObjectNR* and a *reportConfig* which has *rsType* set to *ssb*:

3> set *ssbFrequency* to the value indicated by *ssbFrequency* as included in the *MeasObjectNR*;

2> if there is a *measId* configured with the *MeasObjectNR* and a *reportConfig* which has *rsType* set to *csi-rs*:

3> set *refFreqCSI-RS* to the value indicated by *refFreqCSI-RS* as included in the associated measurement object;

2> if a serving cell is associated with the *MeasObjectNR*:

3> set *measResultServingCell* to include the available quantities of the concerned cell and in accordance with the performance requirements in TS 38.133 [14];

2> set the *measResultNeighCellList* to include the best measured cells, ordered such that the best cell is listed first, and based on measurements collected up to the moment the UE detected the failure, and set its fields as follows;

3> ordering the cells with sorting as follows:

4> based on SS/PBCH block if SS/PBCH block measurement results are available and otherwise based on CSI-RS;

4> using RSRP if RSRP measurement results are available, otherwise using RSRQ if RSRQ measurement results are available, otherwise using SINR;

3> for each neighbour cell included:

4> include the optional fields that are available.

NOTE: The measured quantities are filtered by the L3 filter as configured in the mobility measurement configuration. The measurements are based on the time domain measurement resource restriction, if configured. Blacklisted cells are not required to be reported.

2> if available, set the *locationInfo* as in 5.3.3.7.:

[TS 38.331, clause 5.7.3.5]

The UE shall set the contents of the *SCGFailureInformation* message as follows:

1> if the UE initiates transmission of the *SCGFailureInformation* message due to T310 expiry:

2> set the *failureType* as *t310-Expiry*;

...

1> include and set *MeasResultSCG-Failure* in accordance with 5.7.3.4;

8.2.5.2.2.3 Test description

8.2.5.2.2.3.1 Pre-test conditions

System Simulator:

- NR Cell 1 is the PCell and NR Cell 10 is the PSCell

UE:

- None.

Preamble:

- The UE is in state RRC_CONNECTED using generic procedure parameter Connectivity (*NR-DC*) with DC bearer(MCG and SCG) according to TS 38.508-1 [4], Table 4.5.1-1.

8.2.5.2.2.3.2 Test procedure sequence

Table 8.2.5.2.2.3.2-1: Main behaviour

| St | Procedure | Message Sequence | | TP | Verdict |
|---|--|------------------|------------------------------|----|---------|
| | | U - S | Message | | |
| 1 | The SS changes NR Cell 10 power level to non-suitable "Off" in order to simulate radio link failure. | - | - | - | - |
| 2 | Check: Does the UE transmit in the next 5 sec (NOTE 1) a <i>SCGFailureInformation</i> message with <i>failureType</i> set to ' <i>t310-Expiry</i> '? | --> | <i>SCGFailureInformation</i> | 1 | P |
| NOTE 1: The time of 5 sec is chosen arbitrary. When the UE will send the Failure report depends on (1) the values pre-set for N310 and T310 (see TS 38.508-1 [4], <i>RLF-TimersAndConstants</i> - set at the moment to 'n1' and 'ms1000' respectively), and, (2) the time it will take for the SS to complete step 1 and the UE to notice the change and perform internally all relevant to it actions. Because of the uncertainties associated with (2), and, the lower values used in typical network setting for (1), testing if the UE obeys the exact values of (1) is unreliable. | | | | | |

8.2.5.2.2.3.3 Specific message contents

Table 8.2.5.2.2.3.3-1: RRCSetup(Preamble)

| Derivation path: 38.508-1 [4] table 4.6.1-21 | | | |
|--|-------------------------------------|---|-----------|
| Information Element | Value/remark | Comment | Condition |
| RRCSetup ::= SEQUENCE { | | | |
| criticalExtensions CHOICE { | | | |
| rrcSetup SEQUENCE { | | | |
| masterCellGroup | CellGroupConfig with condition SRB1 | OCTET STRING (CONTAINING CellGroupConfig) | |
| } | | | |
| } | | | |
| } | | | |

Table 8.2.5.2.2.3.3-2: CellGroupConfig (Table 8.2.5.2.2.3.3-1)

| Derivation Path: 38.508-1 [4], Table 4.6.3-19 | | | |
|---|-------------------|---------|-----------|
| Information Element | Value/remark | Comment | Condition |
| CellGroupConfig ::= SEQUENCE { | | | |
| rlf-TimersAndConstants SEQUENCE { | | | |
| t311-v1530 | ms10000 | | |
| } | | | |
| spCellConfigDedicated | ServingCellConfig | | |
| } | | | |

Table 8.2.5.2.2.3.3-3: ServingCellConfig (Table 8.2.5.2.2.3.3-2: CellGroupConfig)

| Derivation Path: TS 38.508-1 [4], Table 4.6.3-167 | | | |
|---|-----------------------|---------|-----------|
| Information Element | Value/remark | Comment | Condition |
| ServingCellConfig ::= SEQUENCE { | | | |
| initialDownlinkBWP | BWP-DownlinkDedicated | | |
| } | | | |

Table 8.2.5.2.2.3.3-4: BWP-DownlinkDedicated (Table 8.2.5.2.2.3.3-3: ServingCellConfig)

| Derivation Path: TS 38.508-1 [4], Table 4.6.3-11 | | | |
|--|---------------------------|---------|-----------|
| Information Element | Value/remark | Comment | Condition |
| BWP-DownlinkDedicated ::= SEQUENCE { | | | |
| radioLinkMonitoringConfig | RadioLinkMonitoringConfig | | |
| } | | | |

Table 8.2.5.2.2.3.3-5: RadioLinkMonitoringConfig (Table 8.2.5.2.2.3.3-4: *BWP-DownlinkDedicated*)

| Derivation Path: TS 38.508-1 [4], Table 4.6.3-133 | | | |
|---|--------------|-------------------------|-----------|
| Information Element | Value/remark | Comment | Condition |
| RadioLinkMonitoringConfig ::= SEQUENCE { | | | |
| failureDetectionResourcesToAddModList | 1 entry | | |
| SEQUENCE (SIZE(1..maxNrofFailureDetectionResources)) OF | | | |
| RadioLinkMonitoringRS { | | | |
| RadioLinkMonitoringRS[1] SEQUENCE { | | entry 1 | |
| radioLinkMonitoringRS-Id | 0 | | |
| purpose | rif | | |
| detectionResource CHOICE { | | | |
| ssb-Index | SSB Index#n | SSB Index of NR Cell 10 | |
| } | | | |
| } | | | |
| } | | | |
| failureDetectionResourcesToReleaseList | Not present | | |
| beamFailureInstanceMaxCount | Not present | | |
| beamFailureDetectionTimer | Not present | | |
| } | | | |

Table 8.2.5.2.2.3.3-6: *MeasResultSCG-Failure*

FFS

8.2.5.3 Radio link failure / rlc-MaxNumRetx failure

8.2.5.3.1 Radio link failure / rlc-MaxNumRetx failure / EN-DC

8.2.5.3.1.1 Test Purpose (TP)

(1)

```

with { UE in RRC_CONNECTED state with EN-DC MCG(s) (E-UTRA PDCP) and SCG DRB established }
ensure that {
  when { the transmitting side of the UE's AM RLC entity for the SCG DRB has retransmitted an RLC
SDU until RETX_COUNT = maxRetxThreshold }
  then { the UE shall transmit a SCGFailureInformationNR message with failureType set to 'rlc-
MaxNumRetx' }
}

```

8.2.5.3.1.2 Conformance requirements

References: The conformance requirements covered in the present test case are specified in: TS 38.322, clause 5.3.2, TS 36.331, clause 5.6.13a.3, TS 38.331, clauses 5.3.10.3, 5.7.3.2, 5.7.3.3. Unless otherwise stated these are Rel-15 requirements.

[TS 38.322, clause 5.3.2]

When an RLC SDU or an RLC SDU segment is considered for retransmission, the transmitting side of the AM RLC entity shall:

- if the RLC SDU or RLC SDU segment is considered for retransmission for the first time:
 - set the RETX_COUNT associated with the RLC SDU to zero.
- else, if it (the RLC SDU or the RLC SDU segment that is considered for retransmission) is not pending for retransmission already and the RETX_COUNT associated with the RLC SDU has not been incremented due to another negative acknowledgment in the same STATUS PDU:
 - increment the RETX_COUNT.

- if RETX_COUNT = *maxRetxThreshold*:
- indicate to upper layers that max retransmission has been reached.

...

[TS 36.331, clause 5.6.13a.3]

The UE shall set the contents of the *SCGFailureInformationNR* message as follows:

- 1> include *failureType* within *failureReportSCG-NR* and set it to indicate the SCG failure in accordance with TS 38.331 [182] clause 5.7.3.3;

...

The UE shall submit the *SCGFailureInformationNR* message to lower layers for transmission.

[TS 38.331, clause 5.3.10.3]

The UE shall:

...

- 1> upon indication from SCG RLC that the maximum number of retransmissions has been reached:
 - 2> if CA duplication is configured and activated; and for the corresponding logical channel *allowedServingCells* only includes SCell(s):
 - 3> initiate the failure information procedure as specified in 5.7.5 to report RLC failure.
 - 2> else:
 - 3> consider radio link failure to be detected for the SCG i.e. SCG-RLF;
 - 3> initiate the SCG failure information procedure as specified in 5.7.3 to report SCG radio link failure.

...

else3> consider radio link failure to be detected for the SCG i.e. SCG-RLF;

3[TS 38.331, clause 5.7.3.2]

A UE initiates the procedure to report SCG failures when SCG transmission is not suspended and when one of the following conditions is met:

- 1> upon detecting radio link failure for the SCG, in accordance with subclause 5.3.10.3;

...

Upon initiating the procedure, the UE shall:

- 1> suspend SCG transmission for all SRBs and DRBs;
- 1> reset SCG-MAC;
- 1> stop T304, if running;
- 1> if the UE is operating in EN-DC:
 - 2> initiate transmission of the *SCGFailureInformationNR* message as specified in TS 36.331 [10], clause 5.6.13a.

Editor's Note: The section for transmission of *SCGFailureInformation* in NR RRC entity for SA is *FFS_Standalone*.

[TS 38.331, clause 5.7.3.3]

Editor's Note: *FFS / TODO:* Either use this section also for NR-DC or change section title (add "for EN-DC").

The UE shall set the SCG failure type as follows:

...

1> else if the UE initiates transmission of the *SCGFailureInformationNR* message to provide indication from SCG RLC that the maximum number of retransmissions has been reached:

2> set the failureType as rlc-MaxNumRetx;

8.2.5.3.1.3 Test description

8.2.5.3.1.3.1 Pre-test conditions

System Simulator:

- E-UTRA Cell 1 is the PCell and NR Cell 1 is the PSCell.

UE:

- None.

Preamble:

- The UE is in state RRC_CONNECTED using generic procedure parameter Connectivity (*EN-DC*), Bearers (*MCG(s) and SCG*) established and Test Loop Function (*On*) with UE test loop mode A (message condition UE TEST LOOP MODE A to return one UL PDCP SDU per DL PDCP SDU) according to TS 38.508-1 [4] the exception that ciphering algorithm 'nea0 (NULL)' is configured.
- The RLC Acknowledged Mode is enabled

8.2.5.3.1.3.2 Test procedure sequence

Table 8.2.5.3.1.3.2-1: Main behaviour

| St | Procedure | Message Sequence | | TP | Verdict |
|----|--|------------------|--------------------------------|----|---------|
| | | U - S | Message | | |
| 1 | The SS transmits AMD PDU#1 containing a complete RLC SDU#1 (on the SCG bearer). | <-- | AMD PDU#1 | - | - |
| 1A | Void | - | - | - | - |
| 1B | The UE transmits one AMD PDU#1 containing a complete RLC SDU#1 (on the SCG bearer). | --> | AMD PDU#1 (SN=0) | - | - |
| - | EXCEPTION: Steps 1C-3 are repeated maxRetxThreshold times
NOTE: maxRetxThreshold is configured by RLC-Config. | - | - | - | - |
| 1C | The SS transmits an RLC STATUS PDU. ACK_SN =1 and NACK_SN =0. | <-- | STATUS PDU | - | - |
| 2 | Void | - | - | - | - |
| 3 | The UE transmits one AMD PDU#1 containing a complete RLC SDU#1 (on the SCG bearer). | --> | AMD PDU#1 (SN=0) | - | - |
| 3A | The SS transmits an RLC STATUS PDU. ACK_SN =1 and NACK_SN =0. | <-- | STATUS PDU | - | - |
| 4 | Check: Does the UE transmit in the next 5 sec (arbitrary value) a <i>SCGFailureInformationNR</i> message with failureType set to 'rlc-MaxNumRetx'? | --> | <i>SCGFailureInformationNR</i> | 1 | P |

8.2.5.3.1.3.3 Specific message contents

Table 8.2.5.3.1.3.3-1: SCGFailureInformationNR (step 4, Table 8.2.5.3.1.3.2-1)

| Derivation Path: 36.508 [7], Table 4.6.1-18AA | | | |
|---|----------------|---------|-----------|
| Information Element | Value/remark | Comment | Condition |
| SCGFailureInformationNR-r15 ::= SEQUENCE { | | | |
| criticalExtensions CHOICE { | | | |
| c1 CHOICE { | | | |
| scgFailureInformationNR-r15 SEQUENCE { | | | |
| failureReportSCG-NR-r15 SEQUENCE { | | | |
| failureType-r15 | rlc-MaxNumRetx | | |
| measResultFreqListNR-r15 | Not checked | | |
| measResultSCG-r15 | Not checked | | |
| } | | | |
| nonCriticalExtension SEQUENCE {} | | | |
| } | | | |
| } | | | |
| } | | | |
| } | | | |

8.2.5.4 Reconfiguration failure / SCG change failure

8.2.5.4.1 Reconfiguration failure / SCG change failure / EN-DC

8.2.5.4.1.1 Test Purpose (TP)

(1)

```

with { UE in RRC_CONNECTED state with EN-DC, and, MCG(s) (E-UTRA PDCP) and SCG DRB established }
ensure that {
  when { UE receives an RRCConnectionReconfiguration message with nr-Config IE containing NR
  RRCReconfiguration message with reconfigurationWithSync for configured PSCell and if T304 of a
  secondary cell group expires }
  then { UE initiates the NR SCG failure information procedure to report SCGFailureInformationNR
  with failure type set to 'synchReconfigFailure-SCG' }
}

```

8.2.5.4.1.2 Conformance requirements

References: The conformance requirements covered in the present test case are specified in: TS 36.331, clause 5.6.13a.3, TS 38.331, clauses 5.3.5.3, 5.3.5.5.1, 5.3.5.5.2, 5.3.5.8.3, 5.7.3.2 and 5.7.3.3. Unless otherwise stated these are Rel-15 requirements.

[TS 36.331, clause 5.6.13a.3]

The UE shall set the contents of the *SCGFailureInformationNR* message as follows:

- 1> include *failureType* within *failureReportSCG-NR* and set it to indicate the SCG failure in accordance with TS 38.331 [82, 5.7.3.3];

...

The UE shall submit the *SCGFailureInformationNR* message to lower layers for transmission.

[TS 38.331, clause 5.3.5.3]

The UE shall perform the following actions upon reception of the *RRCReconfiguration*:

- 1> if the *RRCReconfiguration* includes the *secondaryCellGroup*:
- 2> perform the cell group configuration for the SCG according to 5.3.5.5;

...

- 1> if the UE is configured with E-UTRA *nr-SecondaryCellGroupConfig* (MCG is E-UTRA):
 - 2> if *RRCReconfiguration* was received via SRB1:
 - 3> construct *RRCReconfigurationComplete* message and submit it via the EUTRA MCG embedded in E-UTRA RRC message *RRCConnectionReconfigurationComplete* as specified in TS 36.331 [10];
 - 3> if *reconfigurationWithSync* was included in *spCellConfig* of an SCG:
 - 4> initiate the random access procedure on the SpCell, as specified in TS 38.321 [3];
- ...

[TS 38.331, clause 5.3.5.5.1]

The network configures the UE with Master Cell Group (MCG), and zero or one Secondary Cell Group (SCG). For EN-DC, the MCG is configured as specified in TS 36.331 [10]. The network provides the configuration parameters for a cell group in the *CellGroupConfig* IE.

The UE performs the following actions based on a received *CellGroupConfig* IE:

- 1> if the *CellGroupConfig* contains the *spCellConfig* with *reconfigurationWithSync*:
 - 2> perform Reconfiguration with sync according to 5.3.5.5.2;

[TS 38.331, clause 5.3.5.5.2]

The UE shall perform the following actions to execute a reconfiguration with sync.

- 1> stop timer T310 for the corresponding SpCell, if running;
- 1> start timer T304 for the corresponding SpCell with the timer value set to *t304*, as included in the *reconfigurationWithSync*;

[TS 38.331, clause 5.3.5.8.3]

The UE shall:

- 1> else if T304 of a secondary cell group expires:
 - 2> release dedicated preambles provided in *rach-ConfigDedicated*, if configured;
 - 2> initiate the SCG failure information procedure as specified in subclause 5.7.3 to report SCG reconfiguration with sync failure, upon which the RRC reconfiguration procedure ends.

[TS 38.331, clause 5.7.3.2]

A UE initiates the procedure to report SCG failures when SCG transmission is not suspended and when one of the following conditions is met:

- ...
- 1> upon reconfiguration with sync failure of the SCG, in accordance with subclause 5.3.5.8.3;
- ...

Upon initiating the procedure, the UE shall:

- 1> suspend SCG transmission for all SRBs and DRBs;
- 1> reset SCG-MAC;
- 1> stop T304, if running;
- 1> if the UE is operating in EN-DC:
 - 2> initiate transmission of the *SCGFailureInformationNR* message as specified in TS 36.331 [10], clause 5.6.13a.

[TS 38.331, clause 5.7.3.3]

The UE shall set the SCG failure type as follows:

...

1> else if the UE initiates transmission of the *SCGFailureInformationNR* message to provide reconfiguration with sync failure information for an SCG:

2> set the failureType as *synchReconfigFailure-SCG*;

8.2.5.4.1.3 Test description

8.2.5.4.1.3.1 Pre-test conditions

System Simulator:

- E-UTRA Cell 1 is the PCell and NR Cell 1 is the PSCell.

UE:

- None.

Preamble:

- The UE is in state RRC_CONNECTED using generic procedure parameter Connectivity (EN-DC) and DC Bearers (MCG(s) and SCG) on E-UTRA Cell 1 according to TS 38.508-1 [4], clause 4.5.4.

8.2.5.4.1.3.2 Test procedure sequence

Table 8.2.5.4.1.3.2-1: Main behaviour

| St | Procedure | Message Sequence | | TP | Verdict |
|----|---|------------------|--|----|---------|
| | | U - S | Message | | |
| 1 | The SS transmits an <i>RRCConnectionReconfiguration</i> message containing NR <i>RRCReconfiguration</i> message to perform SCG change with <i>reconfigurationWithSync</i> with the same PSCell. | <-- | <i>RRCConnectionReconfiguration</i>
(<i>RRCReconfiguration</i>) | - | - |
| - | EXCEPTION: In parallel to the event described in step 2 the event described in Table 8.2.5.4.1.3.2-2 takes place. | - | - | - | - |
| 2 | Wait for t304 ms to ensure that T304 expires (the value is defined in <i>CellGroupConfig</i>).
NOTE: SS does not respond to the UE transmitted RACH preambles on NR Cell 1 | - | - | - | - |
| 3 | Check: Does the UE transmit on PCell (E-UTRA Cell 1) in the next 5 sec (arbitrary value) a <i>SCGFailureInformationNR</i> message with <i>failureType</i> set to ' <i>synchReconfigFailure-SCG</i> '? | --> | <i>SCGFailureInformationNR</i> | 1 | P |

Table 8.2.5.4.1.3.2-2: Parallel behaviour

| St | Procedure | Message Sequence | | TP | Verdict |
|----|---|------------------|--|----|---------|
| | | U - S | Message | | |
| 1 | The UE transmits an <i>RRCConnectionReconfigurationComplete</i> message containing NR <i>RRCReconfigurationComplete</i> message on E-UTRA Cell 1. | --> | <i>RRCConnectionReconfigurationComplete</i>
(<i>RRCReconfigurationComplete</i>) | - | - |

8.2.5.4.1.3.3 Specific message contents

Table 8.2.5.4.1.3.3-1: RRCConnectionReconfiguration (step 1, Table 8.2.5.4.1.3.2-1)

Derivation Path: 36.508 [7], Table 4.6.1-8, with condition EN-DC_EmbedNR_RRCRecon

Table 8.2.5.4.1.3.3-1A: RRCReconfiguration (Table 8.2.5.4.1.3.3-1)

| Derivation Path: 38.508-1 [4], Table 4.6.1-13 with condition EN-DC | | | |
|--|-----------------|---------|-----------|
| Information Element | Value/remark | Comment | Condition |
| RRCReconfiguration ::= SEQUENCE { | | | |
| rrc-TransactionIdentifier | | | |
| criticalExtensions CHOICE { | | | |
| rrcReconfiguration SEQUENCE { | | | |
| secondaryCellGroup | CellGroupConfig | | EN-DC |
| } | | | |
| } | | | |
| } | | | |

Table 8.2.5.4.1.3.3-1B: CellGroupConfig (Table 8.2.5.4.1.3.3-1A)

| Derivation Path: TS 38.508-1 [4], Table 4.6.3-19 with condition EN-DC | | | |
|---|-------------------------|---------|-----------|
| Information Element | Value/remark | Comment | Condition |
| CellGroupConfig ::= SEQUENCE { | | | |
| spCellConfig SEQUENCE { | | | |
| reconfigurationWithSync SEQUENCE { | | | |
| spCellConfigCommon | ServingCellConfigCommon | | |
| } | | | |
| } | | | |
| } | | | |

Table 8.2.5.4.1.3.3-1C: ServingCellConfigCommon (Table 8.2.5.4.1.3.3-1B)

| Derivation Path: TS 38.508-1 [4], Table 4.6.3-168 | | | |
|---|------------------|---------|-----------|
| Information Element | Value/remark | Comment | Condition |
| ServingCellConfigCommon ::= SEQUENCE { | | | |
| uplinkConfigCommon SEQUENCE { | | | |
| initialUplinkBWP | BWP-UplinkCommon | | |
| } | | | |
| } | | | |

Table 8.2.5.4.1.3.3-1D: BWP-UplinkCommon (Table 8.2.5.4.1.3.3-1C)

| Derivation Path: TS 38.508-1 [4], Table 4.6.3-14 | | | |
|--|-------------------|---------|-----------|
| Information Element | Value/remark | Comment | Condition |
| BWP-UplinkCommon ::= SEQUENCE { | | | |
| rach-ConfigCommon CHOICE { | | | |
| setup | RACH-ConfigCommon | | |
| } | | | |
| } | | | |

Table 8.2.5.4.1.3.3-1E: RACH-ConfigCommon (Table 8.2.5.4.1.3.3-1D)

| Derivation Path: TS 38.508-1 [4], Table 4.6.3-128 | | | |
|---|--------------------|---------|-----------|
| Information Element | Value/remark | Comment | Condition |
| RACH-ConfigCommon ::= SEQUENCE { | | | |
| rach-ConfigGeneric | RACH-ConfigGeneric | | |
| } | | | |

Table 8.2.5.4.1.3.3-1F: RACH-ConfigGeneric (Table 8.2.5.4.1.3.3-1E)

| Derivation Path: TS 38.508-1 [4], Table 4.6.3-130 | | | |
|---|--------------|---------|-----------|
| Information Element | Value/remark | Comment | Condition |
| RACH-ConfigGeneric ::= SEQUENCE { | | | |
| preambleTransMax | n200 | | |
| } | | | |

Table 8.2.5.4.1.3.3-2: SCGFailureInformationNR (step 3, Table 8.2.5.4.1.3.2-1)

| Derivation Path: 36.508 [7], Table 4.6.1-18AA | | | |
|---|--------------------------|---------|-----------|
| Information Element | Value/remark | Comment | Condition |
| SCGFailureInformationNR-r15 ::= SEQUENCE { | | | |
| criticalExtensions CHOICE { | | | |
| c1 CHOICE { | | | |
| scgFailureInformationNR-r15 SEQUENCE { | | | |
| failureReportSCG-NR-r15 SEQUENCE { | | | |
| failureType-r15 | synchReconfigFailure-SCG | | |
| measResultFreqListNR-r15 | Not checked | | |
| measResultSCG-r15 | Not checked | | |
| } | | | |
| nonCriticalExtension SEQUENCE {} | | | |
| } | | | |
| } | | | |

8.2.5.5 Reconfiguration failure / SCG Reconfiguration failure / SRB3

Note: Core specs requirements cannot be simulated and verified as conformance test.

8.2.5.5.1 Void

8.2.5.6 Reconfiguration failure / SCG Reconfiguration failure / SRB1

Note: Core specs requirements cannot be simulated and verified as conformance test.

8.2.5.6.1 Void

8.2.6 MR-DC RRC others

8.2.6.1 Failure information / RLC failure / SCG

8.2.6.1.1 Failure information / RLC failure / SCG / EN-DC

8.2.6.1.1.1 Failure information / RLC failure / SCG / EN-DC / Intra-band Contiguous CA

8.2.6.1.1.1.1 Test Purpose (TP)

(1)

```
with { UE in RRC_CONNECTED state with EN-DC, and, MCG(s) (E-UTRA PDCP) and SCG }
ensure that {
  when { an indication from SCG RLC that the maximum number of retransmissions has been reached and
when CA duplication is configured and activated and for the corresponding logical channel
allowedServingCells only includes SCell(s) }
  then { UE sends the FailureInformation message embedded in E-UTRA RRC message
ULInformationTransferMRDC to report RLC failure }
```

```

}

```

(2)

```

with { UE in RRC_CONNECTED state with EN-DC, and, MCG(s) (E-UTRA PDCP) and SCG and SRB3 configured }
ensure that {
  when { an indication from SCG RLC that the maximum number of retransmissions has been reached and
when CA duplication is configured and activated and for the corresponding logical channel
allowedServingCells only includes SCell(s) }
  then { UE initiates the failure information procedure to report RLC failure via SRB3 }
}

```

8.2.6.1.1.1.2 Conformance requirements

References: The conformance requirements covered in the current TC are specified in: TS 36.331, clause 5.3.5.3, TS 38.331, clauses 5.3.10.3, 5.7.5.2 and 5.7.5.3. Unless otherwise stated these are Rel-15 requirements.

[TS 36.331, clause 5.3.5.3]

If the *RRCCConnectionReconfiguration* message does not include the *mobilityControlInfo* and the UE is able to comply with the configuration included in this message, the UE shall:

...

1> if the received *RRCCConnectionReconfiguration* includes the *nr-RadioBearerConfig1*:

2> perform radio bearer configuration as specified in TS 38.331 [82], clause 5.3.5.6;

...

1> else:

2> submit the *RRCCConnectionReconfigurationComplete* message to lower layers for transmission using the new configuration, upon which the procedure ends;

[TS 38.331, clause 5.3.10.3]

The UE shall:

...

1> upon indication from SCG RLC that the maximum number of retransmissions has been reached:

2> if the indication is from SCG RLC and CA duplication is configured and activated; and for the corresponding logical channel *allowedServingCells* only includes SCell(s):

3> initiate the failure information procedure as specified in 5.7.5 to report RLC failure.

...

[TS 38.331, clause 5.7.5.2]

A UE initiates the procedure when there is a need inform the network about a failure detected by the UE. In particular, the UE initiates the procedure when the following condition is met:

1> upon detecting failure for an RLC bearer, in accordance with 5.3.10.3;

Upon initiating the procedure, the UE shall:

1> initiate transmission of the *FailureInformation* message as specified in 5.7.5.3;

[TS 38.331, clause 5.7.5.3]

The UE shall:

1> if initiated to provide RLC failure information, set *FailureInfoRLC-Bearer* as follows:

2> set *logicalChannelIdentity* to the logical channel identity of the failing RLC bearer;

2> set *cellGroupId* to the cell group identity of the failing RLC bearer;

2> set the *failureType* as *rlc-failure*;

...

1> else if used to inform the network about a failure for an SCG RLC bearer:

2> if SRB3 is configured;

3> submit the *FailureInformation* message to lower layers for transmission via SRB3;

2> else;

3> if the UE is in (NG)EN-DC:

4> submit the *FailureInformation* message via E-UTRA embedded in E-UTRA RRC message *ULInformationTransferMRDC* as specified in TS 36.331 [10].

...

8.2.6.1.1.1.3 Test description

8.2.6.1.1.1.3.1 Pre-test conditions

System Simulator:

- EUTRA Cell 1 is the PCell, NR Cell 1 is the PSCell, NR Cell 3 is the SCell.

UE:

- None.

Preamble:

- The UE is in state RRC_CONNECTED using generic procedure parameter Connectivity (*EN-DC*), Bearers (*MCG(s)* and *SCG*) established according to TS 38.508-1 [4], clause 4.5.4, and with *UE test loop mode A prepared*, as defined in TS 38.508-1 [4], subclause 4.4A.

8.2.6.1.1.3.2 Test procedure sequence

Table 8.2.6.1.1.3.2-1: Main behaviour

| St | Procedure | Message Sequence | | TP | Verdict |
|------|--|------------------|---|----|---------|
| | | U - S | Message | | |
| 1 | The SS transmits an <i>RRCCONNECTIONRECONFIGURATION</i> message to add SCell (NR Cell 3) and DRB #j for the UE. | <-- | EUTRA RRC:
<i>RRCCONNECTIONRECONFIGURATION</i> | - | - |
| 2 | The UE transmits an <i>RRCCONNECTIONRECONFIGURATIONCOMPLETE</i> message | --> | EUTRA RRC:
<i>RRCCONNECTIONRECONFIGURATIONCOMPLETE</i> | - | - |
| 2A | The SS transmits a SCell Activation/Deactivation MAC-CE to activate SCell (NR Cell 3). | <-- | MAC PDU (SCell Activation/Deactivation MAC CE of one octet (C ₁ =1)) | - | - |
| 3 | The SS transmits a CLOSE UE TEST LOOP message | <-- | CLOSE UE TEST LOOP | - | - |
| 4 | The UE transmits a CLOSE UE TEST LOOP COMPLETE message. | --> | CLOSE UE TEST LOOP COMPLETE | - | - |
| 5 | The SS stops sending SCG RLC acknowledgments for the next RLC PDU on PSCell (NR Cell 1) and SCell (NR Cell 3) | - | - | - | - |
| 6 | The SS transmits one PDCP PDU to the UE on DRB #j. | <-- | PDCP PDU | - | - |
| - | EXCEPTION: Steps 7-7A occur in any sequence. | - | - | - | - |
| 7 | The UE loops back the PDCP PDU on PSCell (NR Cell 1) on DRB #j | --> | PDCP PDU | - | - |
| 7A | The UE loops back the PDCP PDU on SCell (NR Cell 3) on DRB #j | --> | PDCP PDU | - | - |
| 8 | Check: Does the UE transmit an <i>ULINFORMATIONTRANSFERMRDC</i> message including <i>FAILUREINFORMATION</i> with failureType set to 'rlc-failure'? | --> | EUTRA RRC:
<i>ULINFORMATIONTRANSFERMRDC (FAILUREINFORMATION)</i> | 1 | P |
| 9 | Void | | | | |
| 10 | The SS transmits an OPEN UE TEST LOOP message | <-- | OPEN UE TEST LOOP | - | - |
| 11 | The UE transmits an OPEN UE TEST LOOP COMPLETE message. | --> | OPEN UE TEST LOOP COMPLETE | - | - |
| 12 | The SS transmits an <i>RRCCONNECTIONRECONFIGURATION</i> message to add SRB3 for the UE | <-- | EUTRA RRC:
<i>RRCCONNECTIONRECONFIGURATION</i> | - | - |
| 13 | The UE transmits an <i>RRCCONNECTIONRECONFIGURATIONCOMPLETE</i> message | --> | EUTRA RRC:
<i>RRCCONNECTIONRECONFIGURATIONCOMPLETE</i> | - | - |
| 14 | The SS transmits a CLOSE UE TEST LOOP message | <-- | CLOSE UE TEST LOOP | - | - |
| 15 | The UE transmits a CLOSE UE TEST LOOP COMPLETE message. | --> | CLOSE UE TEST LOOP COMPLETE | - | - |
| 16 | The SS stops sending SCG RLC acknowledgments for the next RLC PDU on PSCell (NR Cell 1) and SCell (NR Cell 3) | - | - | - | - |
| 17 | The SS transmits one PDCP PDU to the UE on DRB #j. | <-- | PDCP PDU | - | - |
| - | EXCEPTION: Steps 18-18A occur in any sequence. | - | - | - | - |
| 18 | The UE loops back the PDCP PDU on PSCell (NR Cell 1) on DRB #j | --> | PDCP PDU | - | - |
| 18 A | The UE loops back the PDCP PDU on SCell (NR Cell 3) on DRB #j | --> | PDCP PDU | - | - |
| 19 | Check: Does the UE transmit a <i>FAILUREINFORMATION</i> with failureType set to 'rlc-failure'? | --> | NR RRC: <i>FAILUREINFORMATION</i> | 2 | P |

8.2.6.1.1.3.3 Specific message contents

Table 8.2.6.1.1.3.3-1: RRCConnectionReconfiguration (Step 1, Table 8.2.6.1.1.3.2-1)

| Derivation Path: 36.508 [7] Table 4.6.1-8 with Condition EN-DC_EmbedNR_RRCRecon and EN-DC_EmbedNR_RBConfig | | | |
|--|---|-----------------------|-----------|
| Information Element | Value/remark | Comment | Condition |
| RRCConnectionReconfiguration ::= SEQUENCE { | | | |
| criticalExtensions CHOICE { | | | |
| c1 CHOICE{ | | | |
| rrcConnectionReconfiguration-r8 SEQUENCE { | | | |
| nonCriticalExtension SEQUENCE { | | | |
| nonCriticalExtension SEQUENCE { | | | |
| nonCriticalExtension SEQUENCE { | | | |
| nonCriticalExtension SEQUENCE { | | | |
| nonCriticalExtension SEQUENCE { | | | |
| nonCriticalExtension SEQUENCE { | | | |
| nonCriticalExtension SEQUENCE { | | | |
| nr-Config-r15 CHOICE { | | | |
| setup SEQUENCE { | | | |
| nr-SecondaryCellGroupConfig-r15 | OCTET STRING including RRCReconfiguration | Table 8.2.6.1.1.3.3-2 | |
| } | | | |
| } | | | |
| } | | | |
| } | | | |
| } | | | |
| } | | | |
| } | | | |
| } | | | |
| } | | | |
| } | | | |
| } | | | |
| } | | | |
| } | | | |
| } | | | |

Table 8.2.6.1.1.1.3.3-2: RRCReconfiguration (Table 8.2.6.1.1.1.3.3-1)

| Derivation Path: TS 38.508-1 [4], Table 4.6.1-13 with condition EN-DC_SCell_add | | | |
|---|--|--|-----------|
| Information Element | Value/remark | Comment | Condition |
| RRCReconfiguration ::= SEQUENCE { | | | |
| criticalExtensions CHOICE { | | | |
| rrcReconfiguration SEQUENCE { | | | |
| secondaryCellGroup SEQUENCE { | | | |
| rlc-BearerToAddModList SEQUENCE (SIZE(1..maxLC-ID)) OF RLC-BearerConfig { | 2 entries | | |
| RLC-BearerConfig[1] | RLC-BearerConfig-1 | entry 1
Table
8.2.6.1.1.1.3.3-5
Primary RLC | |
| RLC-BearerConfig[2] | RLC-BearerConfig-2 | entry 2
Table
8.2.6.1.1.1.3.3-6
Secondary RLC | |
| } | | | |
| sCellToAddModList SEQUENCE (SIZE(1..maxNrofSCells)) OF SCellConfig { | 1 entry | | |
| SCellConfig[1] SEQUENCE { | | entry 1 | |
| sCellIndex | SCellIndex for NR Cell 3 | | |
| sCellConfigCommon | ServingCellConfigCommon as per TS 38.508-1 [4] Table 4.6.3-168 | | |
| sCellConfigDedicated | ServingCellConfig as per TS 38.508-1 [4] Table 4.6.3-167 | | |
| } | | | |
| } | | | |
| } | | | |
| } | | | |
| } | | | |
| } | | | |

Table 8.2.6.1.1.1.3.3-3: RadioBearerConfig-DRB(1, 0) (Table 8.2.6.1.1.1.3.3-1)

| Derivation Path: TS 38.508-1 [4], Table 4.8.1-3 | | | |
|---|--------------|---------|-----------|
| Information Element | Value/remark | Comment | Condition |
| RadioBearerConfig ::= SEQUENCE { | | | |
| drb-ToAddModList SEQUENCE (SIZE(1..maxDRB)) OF DRB-ToAddMod { | 1 entry | | |
| DRB-ToAddMod[1] SEQUENCE { | | entry 1 | |
| pdcp-Config | PDCCP-Config | | |
| } | | | |
| } | | | |
| } | | | |

Table 8.2.6.1.1.1.3.3-4: *PDCP-Config* (Table 8.2.6.1.1.1.3.3-3)

| Derivation Path: TS 38.508-1 [4], Table 4.6.3-99 with condition Split | | | |
|---|---|--|-----------|
| Information Element | Value/remark | Comment | Condition |
| PDCP-Config ::= SEQUENCE { | | | |
| moreThanOneRLC SEQUENCE { | | | |
| primaryPath SEQUENCE { | | | |
| logicalChannel | LogicalChannelIdentity with Condition DRB j | j is the ID of the DRB added in Table 8.2.6.1.1.1.3.3-3, which is allocated according to internal TTCN mapping | |
| } | | | |
| } | | | |
| pdcp-Duplication | True | | |
| } | | | |
| } | | | |

Table 8.2.6.1.1.1.3.3-5: *RLC-BearerConfig-1* (Table 8.2.6.1.1.1.3.3-2)

| Derivation Path: TS 38.508-1 [4], Table 4.6.3-148 with Condition AM | | | |
|---|---|--|-----------|
| Information Element | Value/remark | Comment | Condition |
| RLC-BearerConfig ::= SEQUENCE { | | | |
| logicalChannelIdentity | LogicalChannelIdentity with condition DRB j | ID of primary logical channel | |
| servedRadioBearer CHOICE { | | | |
| drb-Identity | DRB-Identity with condition DRB j | | |
| } | | | |
| rlc-Config CHOICE { | | | |
| am SEQUENCE { | | | |
| ul-AM-RLC SEQUENCE { | | | |
| maxRetxThreshold | t32 | To ensure RLC failure happens before RLF | |
| } | | | |
| } | | | |
| } | | | |
| mac-LogicalChannelConfig SEQUENCE { | | | |
| ul-SpecificParameters SEQUENCE { | | | |
| allowedServingCells SEQUENCE (SIZE (1..maxNrofServingCells-1)) OF ServCellIndex { | 1 entry | | |
| ServCellIndex[1] | ServCellIndex of NR Cell 1 | entry 1 | |
| } | | | |
| } | | | |
| } | | | |
| } | | | |

Table 8.2.6.1.1.1.3.3-6: RLC-BearerConfig-2 (Table 8.2.6.1.1.1.3.3-2)

| Derivation Path: TS 38.508-1 [4], Table 4.6.3-148 with Condition AM | | | |
|---|---|---|-----------|
| Information Element | Value/remark | Comment | Condition |
| RLC-BearerConfig ::= SEQUENCE { | | | |
| logicalChannelIdentity | LogicalChannelIdentity with condition DRB j+1 | To ensure ID of secondary logical channel ID is different with existing logical channel and the primary logical channel | |
| servedRadioBearer CHOICE { | | | |
| drb-Identity | DRB-Identity with condition DRB j | | |
| } | | | |
| rlc-Config CHOICE { | | | |
| am SEQUENCE { | | | |
| ul-AM-RLC SEQUENCE { | | | |
| maxRetxThreshold | t1 | To ensure RLC failure happens before RLF | |
| } | | | |
| } | | | |
| } | | | |
| mac-LogicalChannelConfig SEQUENCE { | | | |
| ul-SpecificParameters SEQUENCE { | | | |
| allowedServingCells SEQUENCE (SIZE (1..maxNrofServingCells-1)) OF ServCellIndex { | 1 entry | | |
| ServCellIndex[1] | ServCellIndex of NR Cell 3 | entry 1 | |
| } | | | |
| } | | | |
| } | | | |
| } | | | |

Table 8.2.6.1.1.1.3.3-7: ULInformationTransferMRDC (Step 8, Table 8.2.6.1.1.1.3.2-1)

| Derivation Path: 36.508 [7], Table 4.6.1-27 | | | |
|--|--|-------------------------|-----------|
| Information Element | Value/remark | Comment | Condition |
| ULInformationTransferMRDC-r15 ::= SEQUENCE { | | | |
| criticalExtensions CHOICE { | | | |
| c1 CHOICE { | | | |
| ulInformationTransferMRDC-r15 SEQUENCE { | | | |
| ul-DCCH-MessageNR-r15 | OCTET STRING including the <i>FailureInformation</i> . | Table 8.2.6.1.1.1.3.3-7 | |
| } | | | |
| } | | | |
| } | | | |
| } | | | |

Table 8.2.6.1.1.1.3.3-8: FailureInformation (Table 8.2.6.1.1.1.3.3-7 and Step 19, Table 8.2.6.1.1.1.3.2-1)

| Derivation Path: TS 38.508-1 [4], Table 4.6.1-4 | | | |
|---|--|---------|-----------|
| Information Element | Value/remark | Comment | Condition |
| FailureInformation ::= SEQUENCE { | | | |
| criticalExtensions CHOICE { | | | |
| failureInformation SEQUENCE { | | | |
| failureInfoRLC-Bearer SEQUENCE { | | | |
| cellGroupld | CellGroupld as per TS 38.508-1 [4] Table 4.6.3-20 with condition EN-DC | | |
| failureType | rlc-failure | | |
| } | | | |
| } | | | |
| } | | | |
| } | | | |

Table 8.2.6.1.1.1.3.3-9: RRCConnectionReconfiguration (Step 12, Table 8.2.6.1.1.1.3.2-1)

| Derivation Path: 36.508 [7] Table 4.6.1-8 with Condition and EN-DC_EMBEDNR_RBConfig | | | |
|---|--|--------------------------|-----------|
| Information Element | Value/remark | Comment | Condition |
| RRCConnectionReconfiguration ::= SEQUENCE { | | | |
| criticalExtensions CHOICE { | | | |
| c1 CHOICE{ | | | |
| rrcConnectionReconfiguration-r8 SEQUENCE { | | | |
| nonCriticalExtension SEQUENCE { | | | |
| nonCriticalExtension SEQUENCE { | | | |
| nonCriticalExtension SEQUENCE { | | | |
| nonCriticalExtension SEQUENCE { | | | |
| nonCriticalExtension SEQUENCE { | | | |
| nonCriticalExtension SEQUENCE { | | | |
| nonCriticalExtension SEQUENCE { | | | |
| nr-Config-r15 CHOICE { | | | |
| setup SEQUENCE { | | | |
| nr-SecondaryCellGroupConfig-r15 | OCTET STRING including RRCReconfiguration | Table 8.2.6.1.1.1.3.3-10 | |
| } | | | |
| } | | | |
| nr-RadioBearerConfig1-r15 | OCTET STRING including RadioBearerConfig according to 38.508 [4] Table 4.6.3-132 with Condition SRB3 | | |
| } | | | |
| } | | | |
| } | | | |
| } | | | |
| } | | | |
| } | | | |
| } | | | |
| } | | | |
| } | | | |

Table 8.2.6.1.1.1.3.3-10: RRCReconfiguration (Table 8.2.6.1.1.1.3.3-9)

| Derivation Path: TS 38.508-1 [4], Table 4.6.1-13 with condition EN-DC | | | |
|---|-----------------|--------------------------|-----------|
| Information Element | Value/remark | Comment | Condition |
| RRCReconfiguration ::= SEQUENCE { | | | |
| criticalExtensions CHOICE { | | | |
| rrcReconfiguration SEQUENCE { | | | |
| secondaryCellGroup | CellGroupConfig | Table 8.2.6.1.1.1.3.3-11 | |
| } | | | |
| } | | | |
| } | | | |

Table 8.2.6.1.1.1.3.3-11: CellGroupConfig (Table 8.2.6.1.1.1.3.3-10)

| Derivation Path: TS 38.508-1 [4], Table 4.6.3-19 | | | |
|---|--|---------|-----------|
| Information Element | Value/remark | Comment | Condition |
| CellGroupConfig ::= SEQUENCE { | | | |
| cellGroupId | CellGroupId as per TS 38.508-1 [4] Table 4.6.3-20 with condition EN-DC | | |
| rlc-BearerToAddModList SEQUENCE (SIZE(1..maxLCH)) OF RLC-BearerConfig { | 1 entry | | |
| RLC-BearerConfig[1] | RLC-BearerConfig with conditions SRB3 | entry 1 | |
| } | | | |
| mac-CellGroupConfig | Not present | | |
| physicalCellGroupConfig | Not present | | |
| spCellConfig | Not present | | |
| } | | | |

8.2.6.1.1.2 Failure information / RLC failure / SCG / EN-DC / Inter-band CA

8.2.6.1.1.2.1 Test Purpose (TP)

Same as TC 8.2.6.1.1.1 but applied to Inter-band CA case.

8.2.6.1.1.2.2 Conformance requirements

Same as TC 8.2.6.1.1.1 but applied to Inter-band CA case.

8.2.6.1.1.2.3 Test description

8.2.6.1.1.2.3.1 Pre-test conditions

Same as test case 8.2.6.1.1.1 with the following differences:

- CA configuration: Inter-band CA replaces Intra-band Contiguous CA.
- Cells configuration: NR Cell 10 replaces NR Cell 3.

8.2.6.1.1.2.3.2 Test procedure sequence

Same as test case 8.2.6.1.1.1 with the following differences:

- CA configuration: Inter-band CA replaces Intra-band Contiguous CA.
- Cells configuration: NR Cell 10 replaces NR Cell 3.

8.2.6.1.1.2.3.3 Specific message contents

Same as test case 8.2.6.1.1.1 with the following differences.

- CA configuration: Inter-band CA replaces Intra-band Contiguous CA.
- Cells configuration: NR Cell 10 replaces NR Cell 3.

8.2.6.1.1.3 Failure information / RLC failure / SCG / EN-DC / Intra-band non Contiguous CA

8.2.6.1.1.3.1 Test Purpose (TP)

Same as TC 8.2.6.1.1.1 but applied to Intra-band non Contiguous CA case.

8.2.6.1.1.3.2 Conformance requirements

Same as TC 8.2.6.1.1.1 but applied to Intra-band non Contiguous CA case.

8.2.6.1.1.3.3 Test description

8.2.6.1.1.3.3.1 Pre-test conditions

Same as test case 8.2.6.1.1.1 with the following differences:

- CA configuration: Intra-band non Contiguous CA replaces Intra-band Contiguous CA.

8.2.6.1.1.3.3.2 Test procedure sequence

Same as test case 8.2.6.1.1.1 with the following differences:

- CA configuration: Intra-band non Contiguous CA replaces Intra-band Contiguous CA.

8.2.6.1.1.3.3.3 Specific message contents

Same as test case 8.2.6.1.1.1 but applied to Intra-band non Contiguous CA case.

8.2.6.1.2 Failure information / RLC failure / SCG / NR-DC

8.2.6.1.2.1 Failure information / RLC failure / SCG / NR-DC / Intra-band Contiguous CA

8.2.6.1.2.1.1 Test Purpose (TP)

(1)

```
with { UE in NR RRC_CONNECTED state with NR-DC, and SCG }
ensure that {
  when { an indication from SCG RLC that the maximum number of retransmissions has been reached and
  when CA duplication is configured and activated and for the corresponding logical channel
  allowedServingCells only includes SCell(s) }
  then { UE sends the FailureInformation message embedded in ULInformationTransferMRDC to report
  RLC failure for the SCG }
}
```

(2)

```
with { UE in NR RRC_CONNECTED state with NR-DC, and SRB3 configured }
ensure that {
  when { an indication from SCG RLC that the maximum number of retransmissions has been reached and
  when CA duplication is configured and activated and for the corresponding logical channel
  allowedServingCells only includes SCell(s) }
  then { UE sends the FailureInformation message over SRB3 to report RLC failure for the SCG }
}
```

8.2.6.1.2.1.2 Conformance requirements

References: The conformance requirements covered in the current TC are specified in: TS 36.331, clause 5.3.5.3, TS 38.331, clauses 5.3.10.3, 5.7.5.2 and 5.7.5.3. Unless otherwise stated these are Rel-15 requirements.

[TS 38.331, 5.3.5.3]

The UE shall perform the following actions upon reception of the *RRCReconfiguration*:

...

1> if the *RRCReconfiguration* includes the *secondaryCellGroup*:

2> perform the cell group configuration for the SCG according to 5.3.5.5;

1> if the *RRCReconfiguration* includes the *mrdc-SecondaryCellGroupConfig*:

2> if the *mrdc-SecondaryCellGroupConfig* is set to *setup*:

3> if the *mrdc-SecondaryCellGroupConfig* includes *mrdc-ReleaseAndAdd*:

4> perform MR-DC release as specified in clause 5.3.5.10;

3> if the received *mrdc-SecondaryCellGroup* is set to *nr-SCG*:

4> perform the RRC reconfiguration according to 5.3.5.3 for the *RRCReconfiguration* message included in *nr-SCG*;

...

1> if the *RRCReconfiguration* message includes the *radioBearerConfig*:

2> perform the radio bearer configuration according to 5.3.5.6;

...

1> set the content of the *RRCReconfigurationComplete* message as follows:

...

2> if the *RRCReconfiguration* message includes the *mrdc-SecondaryCellGroupConfig* with *mrdc-SecondaryCellGroup* set to *nr-SCG*:

3> include in the *nr-SCG-Response* the *RRCReconfigurationComplete* message;

...

1> else if the *RRCReconfiguration* message was received within the *nr-SCG* within *mrdc-SecondaryCellGroup* (UE in NR-DC, *mrdc-SecondaryCellGroup* was received in *RRCReconfiguration* via SRB1):

2> if *reconfigurationWithSync* was included in *spCellConfig* in *nr-SCG*:

3> initiate the Random Access procedure on the PSCell, as specified in TS 38.321 [3];

2> else

3> the procedure ends;

NOTE 2a: The order in which the UE sends the *RRCReconfigurationComplete* message and performs the Random Access procedure towards the SCG is left to UE implementation.

1> else if the *RRCReconfiguration* message was received via SRB3 (UE in NR-DC):

2> submit the *RRCReconfigurationComplete* message via SRB3 to lower layers for transmission using the new configuration;

1> else (*RRCReconfiguration* was received via SRB1):

2> submit the *RRCReconfigurationComplete* message via SRB1 to lower layers for transmission using the new configuration;

...

1> if *reconfigurationWithSync* was included in *spCellConfig* of an MCG or SCG, and when MAC of an NR cell group successfully completes a Random Access procedure triggered above;

2> stop timer T304 for that cell group;

2> apply the parts of the CSI reporting configuration, the scheduling request configuration and the sounding RS configuration that do not require the UE to know the SFN of the respective target SpCell, if any;

2> apply the parts of the measurement and the radio resource configuration that require the UE to know the SFN of the respective target SpCell (e.g. measurement gaps, periodic CQI reporting, scheduling request configuration, sounding RS configuration), if any, upon acquiring the SFN of that target SpCell;

...

[TS 38.331, clause 5.3.10.3]

The UE shall:

...

1> upon indication from SCG RLC that the maximum number of retransmissions has been reached:

2> if the indication is from SCG RLC and CA duplication is configured and activated; and for the corresponding logical channel *allowedServingCells* only includes SCell(s):

3> initiate the failure information procedure as specified in 5.7.5 to report RLC failure.

...

[TS 38.331, clause 5.7.5.2]

A UE initiates the procedure when there is a need inform the network about a failure detected by the UE. In particular, the UE initiates the procedure when the following condition is met:

1> upon detecting failure for an RLC bearer, in accordance with 5.3.10.3;

Upon initiating the procedure, the UE shall:

1> initiate transmission of the *FailureInformation* message as specified in 5.7.5.3;

[TS 38.331, clause 5.7.5.3]

The UE shall:

1> if initiated to provide RLC failure information, set *FailureInfoRLC-Bearer* as follows:

2> set *logicalChannelIdentity* to the logical channel identity of the failing RLC bearer;

2> set *cellGroupId* to the cell group identity of the failing RLC bearer;

2> set the *failureType* as *rlc-failure*;

...

1> else if used to inform the network about a failure for an SCG RLC bearer:

2> if SRB3 is configured;

3> submit the *FailureInformation* message to lower layers for transmission via SRB3;

2> else;

...

3> else if the UE is in NR-DC:

4> submit the *FailureInformation* message via SRB1 embedded in NR RRC message *ULInformationTransferMRDC* as specified in clause 5.7.2a.3.

...

8.2.6.1.2.1.3 Test description

8.2.6.1.2.1.3.1 Pre-test conditions

System Simulator:

- NR Cell 1 is the PCell, NR Cell 10 is the PSCell, NR Cell 28 is the SCG SCell.
- System information combination NR-4 as defined in TS 38.508-1 [4] clause 4.4.3.1.2 is used in NR cells.

UE:

- None.

Preamble:

- The UE is in state RRC_CONNECTED using generic procedure parameter Connectivity (*NR-DC*) according to TS 38.508-1 [4], Table 4.5.1-1, and with *UE test loop mode A prepared*, as defined in TS 38.508-1 [4], subclause 4.4A.

8.2.6.1.2.1.3.2 Test procedure sequence

Table 8.2.6.1.2.1.3.2-1: Main behaviour

| St | Procedure | Message Sequence | | TP | Verdict |
|----|--|------------------|---|----|---------|
| | | U - S | Message | | |
| 1 | The SS transmits an <i>RRCReconfiguration</i> message to add SCG SCell (NR Cell 28) and establish SCG DRB #j for the UE. | <- | NR RRC: <i>RRCReconfiguration</i> | - | - |
| 2 | The UE transmits an <i>RRCReconfigurationComplete</i> message | --> | NR RRC: <i>RRCReconfigurationComplete</i> | - | - |
| 3 | The SS transmits a SCell Activation/Deactivation MAC-CE on PSCell (NR Cell 10) to activate SCG SCell (NR Cell 28). | <- | MAC PDU (SCell Activation/Deactivation MAC CE of one octet (C ₁ =1)) | - | - |
| 4 | The SS transmits a CLOSE UE TEST LOOP message | <- | CLOSE UE TEST LOOP | - | - |
| 5 | The UE transmits a CLOSE UE TEST LOOP COMPLETE message. | --> | CLOSE UE TEST LOOP COMPLETE | - | - |
| 6 | The SS stops sending SCG RLC acknowledgments for the next RLC PDU on PSCell (NR Cell 10) and SCell (NR Cell 28) | - | - | - | - |
| 7 | The SS transmits one PDCP PDU to the UE on DRB #j. | <- | PDCP PDU | - | - |
| - | EXCEPTION: Steps 8-9 occur in any sequence. | - | - | - | - |
| 8 | The UE loops back the PDCP PDU on PSCell (NR Cell 10) on DRB #j | --> | PDCP PDU | - | - |
| 9 | The UE loops back the PDCP PDU on SCell (NR Cell 28) on DRB #j | --> | PDCP PDU | - | - |
| 10 | Check: Does the UE transmit an <i>ULInformationTransferMRDC</i> message including <i>FailureInformation</i> with failureType set to 'rlc-failure'? | --> | NR RRC: <i>ULInformationTransferMRDC (FailureInformation)</i> | 1 | P |
| 11 | The SS transmits an OPEN UE TEST LOOP message | <- | OPEN UE TEST LOOP | - | - |
| 12 | The UE transmits an OPEN UE TEST LOOP COMPLETE message. | --> | OPEN UE TEST LOOP COMPLETE | - | - |
| 13 | The SS transmits an <i>RRCReconfiguration</i> message to establish SRB3 for the UE | <- | NR RRC: <i>RRCReconfiguration</i> | - | - |
| 14 | The UE transmits an <i>RRCReconfigurationComplete</i> message | --> | NR RRC: <i>RRCReconfigurationComplete</i> | - | - |
| 15 | The SS transmits a CLOSE UE TEST LOOP message | <- | CLOSE UE TEST LOOP | - | - |
| 16 | The UE transmits a CLOSE UE TEST LOOP COMPLETE message. | --> | CLOSE UE TEST LOOP COMPLETE | - | - |
| 17 | The SS stops sending SCG RLC acknowledgments for the next RLC PDU on PSCell (NR Cell 10) and SCell (NR Cell 28) | - | - | - | - |
| 18 | The SS transmits one PDCP PDU to the UE on DRB #j. | <- | PDCP PDU | - | - |
| - | EXCEPTION: Steps 19-20 occur in any sequence. | - | - | - | - |
| 19 | The UE loops back the PDCP PDU on PSCell (NR Cell 10) on DRB #j | --> | PDCP PDU | - | - |
| 20 | The UE loops back the PDCP PDU on SCell (NR Cell 28) on DRB #j | --> | PDCP PDU | - | - |
| 21 | Check: Does the UE transmit a <i>FailureInformation</i> with failureType set to 'rlc-failure'? | --> | NR RRC: <i>FailureInformation</i> | 2 | P |

Table 8.2.6.1.2.1.3.3-4: CellGroupConfig (Table 8.2.6.1.2.1.3.3-2)

| Derivation Path: TS 38.508-1 [4], Table 4.6.3-19 with condition SCell_add | | | |
|--|---|--|-----------|
| Information Element | Value/remark | Comment | Condition |
| CellGroupConfig ::= SEQUENCE { | | | |
| cellGroupId | CellGroupId as per TS 38.508-1 [4] Table 4.6.3-20 condition NR-DC_SCG | | |
| rlc-BearerToAddModList SEQUENCE (SIZE(1..max LC-ID)) OF RLC-BearerConfig { | 2 entries | | |
| RLC-BearerConfig[1] | RLC-BearerConfig-1 | entry 1
Table
8.2.6.1.2.1.3.3-6
Primary RLC | |
| RLC-BearerConfig[2] | RLC-BearerConfig-2 | entry 2
Table
8.2.6.1.2.1.3.3-7
Secondary RLC | |
| } | | | |
| sCellToAddModList SEQUENCE (SIZE (1..maxNrofSCells)) OF SCellConfig { | 1 entry | | |
| SCellConfig[1] SEQUENCE { | | entry 1 | |
| sCellIndex | SCellIndex for NR Cell 28 | | |
| sCellConfigCommon | ServingCellConfigCommon as per TS 38.508-1 [4] Table 4.6.3-168 | | |
| sCellConfigDedicated | ServingCellConfig as per TS 38.508-1 [4] Table 4.6.3-167 | | |
| } | | | |
| } | | | |
| } | | | |

Table 8.2.6.1.2.1.3.3-5: PDCP-Config (Table 8.2.6.1.2.1.3.3-3)

| Derivation Path: TS 38.508-1 [4], Table 4.6.3-99 with condition Split | | | |
|---|---|--|-----------|
| Information Element | Value/remark | Comment | Condition |
| PDCP-Config ::= SEQUENCE { | | | |
| moreThanOneRLC SEQUENCE { | | | |
| primaryPath SEQUENCE { | | | |
| logicalChannel | LogicalChannelIdentity with Condition DRB j | j is the ID of the DRB added in Table 8.2.6.1.2.1.3.3-3, which is allocated according to internal TTCN mapping | |
| } | | | |
| pdcp-Duplication | True | | |
| } | | | |
| } | | | |

Table 8.2.6.1.2.1.3.3-6: RLC-BearerConfig-1 (Table 8.2.6.1.2.1.3.3-4)

| Derivation Path: TS 38.508-1 [4], Table 4.6.3-148 with Condition AM | | | |
|---|---|--|-----------|
| Information Element | Value/remark | Comment | Condition |
| RLC-BearerConfig ::= SEQUENCE { | | | |
| logicalChannelIdentity | LogicalChannelIdentity with condition DRB j | ID of primary logical channel | |
| servedRadioBearer CHOICE { | | | |
| drb-Identity | DRB-Identity with condition DRB j | | |
| } | | | |
| rlc-Config CHOICE { | | | |
| am SEQUENCE { | | | |
| ul-AM-RLC SEQUENCE { | | | |
| maxRetxThreshold | t32 | To ensure RLC failure happens before RLF | |
| } | | | |
| } | | | |
| } | | | |
| mac-LogicalChannelConfig SEQUENCE { | | | |
| ul-SpecificParameters SEQUENCE { | | | |
| allowedServingCells SEQUENCE (SIZE (1..maxNrofServingCells-1)) OF ServCellIndex { | 1 entry | | |
| ServCellIndex[1] | ServCellIndex of NR Cell 10 | entry 1 | |
| } | | | |
| } | | | |
| } | | | |
| } | | | |

Table 8.2.6.1.2.1.3.3-7: RLC-BearerConfig-2 (Table 8.2.6.1.2.1.3.3-4)

| Derivation Path: TS 38.508-1 [4], Table 4.6.3-148 with Condition AM | | | |
|---|---|---|-----------|
| Information Element | Value/remark | Comment | Condition |
| RLC-BearerConfig ::= SEQUENCE { | | | |
| logicalChannelIdentity | LogicalChannelIdentity with condition DRB j+1 | To ensure ID of secondary logical channel ID is different with existing logical channel and the primary logical channel | |
| servedRadioBearer CHOICE { | | | |
| drb-Identity | DRB-Identity with condition DRB j | | |
| } | | | |
| rlc-Config CHOICE { | | | |
| am SEQUENCE { | | | |
| ul-AM-RLC SEQUENCE { | | | |
| maxRetxThreshold | t1 | To ensure RLC failure happens before RLF | |
| } | | | |
| } | | | |
| } | | | |
| mac-LogicalChannelConfig SEQUENCE { | | | |
| ul-SpecificParameters SEQUENCE { | | | |
| allowedServingCells SEQUENCE (SIZE (1..maxNrofServingCells-1)) OF ServCellIndex { | 1 entry | | |
| ServCellIndex[1] | ServCellIndex of NR Cell 28 | entry 1 | |
| } | | | |
| } | | | |
| } | | | |
| } | | | |

Table 8.2.6.1.2.1.3.3-8: ULInformationTransferMRDC (Step 10, Table 8.2.6.1.2.1.3.2-1)

| Derivation Path: TS 38.508-1 [4], Table 4.6.1-34 | | | |
|--|--|-------------------------|-----------|
| Information Element | Value/remark | Comment | Condition |
| ULInformationTransferMRDC ::= SEQUENCE { | | | |
| criticalExtensions CHOICE { | | | |
| c1 CHOICE { | | | |
| ulInformationTransferMRDC SEQUENCE { | | | |
| ul-DCCH-MessageNR | OCTET STRING including the <i>FailureInformation</i> . | Table 8.2.6.1.2.1.3.3-9 | |
| } | | | |
| } | | | |
| } | | | |
| } | | | |

Table 8.2.6.1.2.1.3.3-9: FailureInformation (Table 8.2.6.1.2.1.3.3-8 and Step 21, Table 8.2.6.1.2.1.3.2-1)

| Derivation Path: TS 38.508-1 [4], Table 4.6.1-4 | | | |
|---|--|---------|-----------|
| Information Element | Value/remark | Comment | Condition |
| FailureInformation ::= SEQUENCE { | | | |
| criticalExtensions CHOICE { | | | |
| failureInformation SEQUENCE { | | | |
| failureInfoRLC-Bearer SEQUENCE { | | | |
| cellGroupId | CellGroupId as per TS 38.508-1 [4] Table 4.6.3-20 with condition NR-DC_SCG | | |
| failureType | rlc-failure | | |
| } | | | |
| } | | | |
| } | | | |
| } | | | |

Table 8.2.6.1.2.1.3.3-10: RRCReconfiguration (step 13, Table 8.2.6.1.2.1.3.2-1)

| Derivation Path: TS 38.508-1 [4], Table 4.6.1-13 with condition NR-DC | | | |
|---|--|--------------------------|-----------|
| Information Element | Value/remark | Comment | Condition |
| RRCReconfiguration ::= SEQUENCE { | | | |
| criticalExtensions CHOICE { | | | |
| rrcReconfiguration SEQUENCE { | | | |
| radioBearerConfig | Not present | | |
| nonCriticalExtension SEQUENCE { | | | |
| masterCellGroup | Not present | | |
| nonCriticalExtension SEQUENCE { | | | |
| nonCriticalExtension SEQUENCE { | | | |
| mrdc-SecondaryCellGroupConfig CHOICE { | | | |
| setup SEQUENCE { | | | |
| mrdc-SecondaryCellGroup CHOICE { | | | |
| nr-SCG | RRCReconfiguration-SCG | Table 8.2.6.1.2.1.3.3-11 | |
| } | | | |
| } | | | |
| } | | | |
| radioBearerConfig2 | RadioBearerConfig as per TS 38.508-1 [4] Table 4.6.3-132 with condition SRB3 | | |
| } | | | |
| } | | | |
| } | | | |
| } | | | |
| } | | | |

Table 8.2.6.1.2.1.3.3-11: RRCReconfiguration-SCG (Table 8.2.6.1.2.1.3.3-10)

| Derivation Path: TS 38.508-1 [4], Table 4.6.1-13 with condition NR-DC_SCG | | | |
|---|-----------------|--------------------------|-----------|
| Information Element | Value/remark | Comment | Condition |
| RRCReconfiguration ::= SEQUENCE { | | | |
| criticalExtensions CHOICE { | | | |
| rrcReconfiguration SEQUENCE { | | | |
| radioBearerConfig | Not present | | |
| secondaryCellGroup | CellGroupConfig | Table 8.2.6.1.2.1.3.3-12 | |
| } | | | |
| } | | | |
| } | | | |

Table 8.2.6.1.2.1.3.3-12: CellGroupConfig (Table 8.2.6.1.2.1.3.3-12)

| Derivation Path: 38.508-1 [4], Table 4.6.3-19 | | | |
|--|---|---------|-----------|
| Information Element | Value/remark | Comment | Condition |
| CellGroupConfig ::= SEQUENCE { | | | |
| cellGroupId | CellGroupId as per TS 38.508-1 [4] Table 4.6.3-20 condition NR-DC_SCG | | |
| rlc-BearerToAddModList SEQUENCE (SIZE(1..max LC-ID)) OF RLC-BearerConfig { | 1 entry | | |
| RLC-Bearer-Config[1] | RLC-BearerConfig as per TS 38.508-1 [4] Table 4.6.3-148 with condition SRB3 | entry 1 | |
| } | | | |
| mac-CellGroupConfig | Not Present | | |
| physicalCellGroupConfig | Not Present | | |
| spCellConfig | Not Present | | |
| } | | | |

8.2.6.1.2.2 Failure information / RLC failure / SCG / NR-DC / Inter-band CA

8.2.6.1.2.2.1 Test Purpose (TP)

Same as TC 8.2.6.1.2.1 but applied to Inter-band CA case.

8.2.6.1.2.2.2 Conformance requirements

Same as TC 8.2.6.1.2.1 but applied to Inter-band CA case.

8.2.6.1.2.2.3 Test description

8.2.6.1.2.2.3.1 Pre-test conditions

Same as test case 8.2.6.1.2.1 with the following differences:

- CA configuration: Inter-band CA replaces Intra-band Contiguous CA.
- Cells configuration: NR Cell 10 and NR Cell 28 are in the different band.

8.2.6.1.2.2.3.2 Test procedure sequence

Same as test case 8.2.6.1.2.1 with the following differences:

- CA configuration: Inter-band CA replaces Intra-band Contiguous CA.
- Cells configuration: NR Cell 10 and NR Cell 28 are in the different band.

8.2.6.1.2.2.3.3 Specific message contents

Same as test case 8.2.6.1.2.1 with the following differences.

- CA configuration: Inter-band CA replaces Intra-band Contiguous CA.
- Cells configuration: NR Cell 10 and NR Cell 28 are in the different band.

8.2.6.1.2.3 Failure information / RLC failure / SCG / NR-DC / Intra-band non Contiguous CA

8.2.6.1.2.3.1 Test Purpose (TP)

Same as TC 8.2.6.1.2.1 but applied to Intra-band non Contiguous CA case.

8.2.6.1.2.3.2 Conformance requirements

Same as TC 8.2.6.1.2.1 but applied to Intra-band non Contiguous CA case.

8.2.6.1.2.3.3 Test description

8.2.6.1.2.3.3.1 Pre-test conditions

Same as test case 8.2.6.1.2.1 with the following differences:

- CA configuration: Intra-band non Contiguous CA replaces Intra-band Contiguous CA.

8.2.6.1.2.3.3.2 Test procedure sequence

Same as test case 8.2.6.1.2.1 with the following differences:

- CA configuration: Intra-band non Contiguous CA replaces Intra-band Contiguous CA.

8.2.6.1.2.3.3.3 Specific message contents

Same as test case 8.2.6.1.2.1 but applied to Intra-band non Contiguous CA case.

8.2.6.2 Processing delay

8.2.6.2.1 Processing delay / PSCell addition / SCG DRB / Success / Latency check / EN-DC

8.2.6.2.1.1 Test Purpose (TP)

(1)

```
with { UE in RRC_CONNECTED state with EN-DC, and, MCG(s) (E-UTRA PDCP) only }
ensure that {
  when { UE receives an RRCConnectionReconfiguration message to add PSCell with SCG DRB and after 20
subframes receives an UL grant }
  then { UE successfully configures the PSCell with SCG DRB and sends an
RRCConnectionReconfigurationComplete message }
}
```

(2)

```
with { UE in RRC_CONNECTED state with EN-DC, and, MCG(s) (E-UTRA PDCP) only }
ensure that {
  when { UE receives an UECapabilityEnquiry message requesting eutra-nr capabilities and after 80
subframes receives an UL grant }
  then { UE successfully transmits an UECapabilityInformation message }
}
```

8.2.6.2.1.2 Conformance requirements

References: The conformance requirements covered in the present TC are specified in: TS 36.331, clauses 5.3.5.3, , TS 38.331, clauses 5.3.10.3, 5.7.3.2, 5.7.3.3. Unless otherwise stated these are Rel-15 requirements.

[TS 36.331, clause 5.3.5.3]

If the *RRCCConnectionReconfiguration* message does not include the *mobilityControlInfo* and the UE is able to comply with the configuration included in this message, the UE shall:

...

- 1> if the received *RRCCConnectionReconfiguration* includes the *nr-SecondaryCellGroupConfig*:
- 2> perform NR RRC Reconfiguration as specified in TS 38.331 [82], clause 5.3.5.3;

- 1> if the received *RRCCONNECTIONRECONFIGURATION* includes the *nr-RadioBearerConfig1*:
 - 2> perform radio bearer configuration as specified in TS 38.331 [82], clause 5.3.5.6;
- ...
- 1> set the content of *RRCCONNECTIONRECONFIGURATIONCOMPLETE* message as follows:
 - ...
 - 2> if the received *RRCCONNECTIONRECONFIGURATION* message included *nr-SecondaryCellGroupConfig*:
 - 3> include *scg-ConfigResponseNR* in accordance with TS 38.331 [82], clause 5.3.5.3;
 - ...
- 1> else:
 - 2> submit the *RRCCONNECTIONRECONFIGURATIONCOMPLETE* message to lower layers for transmission using the new configuration, upon which the procedure ends;

[TS 36.331, clause 5.6.3.3]

The UE shall:

- ...
- 1> else, set the contents of *UECAPABILITYINFORMATION* message as follows:
 - ...
 - 2> if the *ue-CapabilityRequest* includes *eutra-nr* and if the UE supports (NG)EN-DC or NE-DC:
 - 3> include the UE radio access capabilities for EUTRA-NR within a *ue-CapabilityRAT-Container*, with the *rat-Type* set to *eutra-nr*;
 - 3> include band combinations as specified in TS 38.331 [82], clause 5.6.1.4, considering the included *requestedFreqBandsNR-MRDC*, *requestedCapabilityNR* (if present) and *requestedCapabilityCommon* (if included);
 - 1> submit the *UECAPABILITYINFORMATION* message to lower layers for transmission, upon which the procedure ends;

[TS 36.331, clause 11.2]

The UE performance requirements for RRC procedures are specified in the following tables, by means of a value N:

N = the number of 1ms subframes from the end of reception of the E-UTRAN -> UE message on the UE physical layer up to when the UE shall be ready for the reception of uplink grant for the UE -> E-UTRAN response message with no access delay other than the TTI-alignment (e.g. excluding delays caused by scheduling, the random access procedure or physical layer synchronisation).

NOTE: No processing delay requirements are specified for RN-specific procedures.

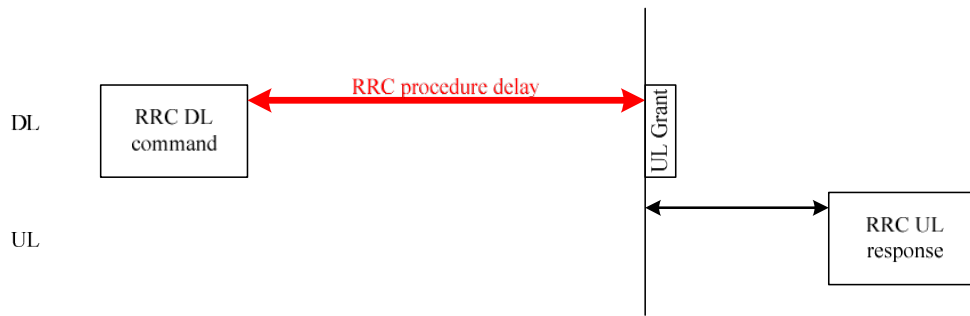

Figure 11.2-1: Illustration of RRC procedure delay

Table 11.2-1: UE performance requirements for RRC procedures for UEs other than NB-IoT UEs

| Procedure title | E-UTRAN -> UE | UE -> E-UTRAN | N | Notes |
|--|-------------------------------------|---|--------|--|
| RRC Connection Control Procedures | | | | |
| RRC connection reconfiguration (NR SCG establishment/ /modification/release) | <i>RRCConnectionReconfiguration</i> | <i>RRCConnectionReconfigurationComplete</i> | 20 | |
| Other procedures | | | | |
| UE capability transfer | <i>UECapabilityEnquiry</i> | <i>UECapabilityInformation</i> | 10/ 80 | N = 80 applies in case the UE has to report at least one of the following UE capabilities.
- MR-DC band combinations.
- NR band combinations
- EUTRA feature sets |

8.2.6.2.1.3 Test description

8.2.6.2.1.3.1 Pre-test conditions

System Simulator:

- E-UTRA Cell 1 is the PCell and NR Cell 1 is the PSCell.

UE:

- None.

Preamble:

- The UE is in state RRC_CONNECTED using generic procedure parameter Connectivity (*EN-DC*) and Bearers (*MCG(s) only*) established and Test Loop Function (On) with UE test loop mode B according to TS 38.508-1 [4], clause 4.5.4.

8.2.6.2.1.3.2 Test procedure sequence

Table 8.2.6.2.1.3.2-1: Main behaviour

| St | Procedure | Message Sequence | | TP | Verdict |
|---|---|------------------|--|----|---------|
| | | U - S | Message | | |
| 1 | The SS transmits an <i>RRCConnectionReconfiguration</i> message to add PSCell with SCG DRB | <-- | E-UTRA RRC:
<i>RRCConnectionReconfiguration</i> | - | - |
| 2 | Check: Does the UE transmit an <i>RRCConnectionReconfigurationComplete</i> message within 25 (FDD)/28 (TDD) subframes after successful completion of step 1? (Note 2) | --> | E-UTRA RRC:
<i>RRCConnectionReconfigurationComplete</i> | 1 | P |
| 2A | Void | - | - | - | - |
| 3 | The SS sends E-UTRA RRC <i>UECapabilityEnquiry</i> message including <i>RAT-Type eutra-nr</i> . | <-- | E-UTRA RRC:
<i>UECapabilityEnquiry</i> | | |
| 4 | Check: Does the UE transmit an E-UTRA RRC <i>UECapabilityInformation</i> message within 85 (FDD)/88 (TDD) subframes after successful completion of step 3? (Note 2) | --> | E-UTRA RRC:
<i>UECapabilityInformation</i> | 2 | P |
| Note 1: The SS is configured for RRC procedure delay testing according to TS 36.523-3 clause 7.12.1.
Note 2: 5 (FDD) / 8 (TDD) subframes is added on top of RRC processing delay requirement, because UL grant is allocated for the next subframe after RRC procedure delay and because of transmission delay after UL grant. For TDD, consider the max 7 TTI transmission delay after UL grant. | | | | | |

8.2.6.2.1.3.3 Specific message contents

Table 8.2.6.2.1.3.3-1: *RRCConnectionReconfiguration* (step 1, Table 8.2.6.2.1.3.2-1)

| |
|---|
| Derivation Path: TS 36.508 [7], Table 4.6.1-8 with Condition SCG-DRB(1,1) |
|---|

Table 8.2.6.2.1.3.3-2: *UECapabilityEnquiry* (step 3, Table 8.2.6.2.1.3.2-1)

| Derivation Path: TS 36.508 [7], Table 4.6.1-22 with Condition EN-DC | | | |
|--|-----------------|---------|-----------|
| Information Element | Value/remark | Comment | Condition |
| <i>UECapabilityEnquiry</i> ::= SEQUENCE { | | | |
| <i>criticalExtensions</i> CHOICE { | | | |
| c1 CHOICE { | | | |
| <i>ueCapabilityEnquiry-r8</i> SEQUENCE { | | | |
| <i>ue-CapabilityRequest</i> SEQUENCE (SIZE (1..maxRAT-Capabilities)) OF RAT-Type { | 1 entry | | |
| RAT-Type[1] | <i>eutra-nr</i> | | |
| } | | | |
| } | | | |
| } | | | |
| } | | | |
| } | | | |

9 Mobility management

Editor's note: Intended to capture tests of
5G Core Network behaviour defined in TS 24.301, TS 24.501 et.al.

Multi-RAT Dual Connectivity behaviour defined in TS 37.340.

Possible configurations may be handled in the following sub-structure:

- a) E-UTRA–NR DC via EPC with E-UTRA as master (also referred to EN-DC, option 3, 3a, 3x)
- b) E-UTRA–NR DC via 5GC
 - with E-UTRA as master (also referred to NGEN-DC, option 7, 7a, 7x)
 - with NR as master (also referred to NE-DC, option 4, 4A)

9.1 5GS Mobility Management

9.1.1 Primary authentication and key agreement

9.1.1.1 EAP based primary authentication and key agreement / EAP-AKA' related procedures

9.1.1.1.1 Test Purpose (TP)

(1)

```
with { the UE in 5GMM-REGISTERED-INITIATED state }
ensure that {
  when { the SS sends an EAP-Request/AKA'-Identity message within AUTHENTICATION REQUEST }
  then { the UE sends an EAP-Response/AKA'-Identity message within AUTHENTICATION RESPONSE }
}
```

(2)

```
with { the UE in 5GMM-REGISTERED-INITIATED state }
ensure that {
  when { the SS sends the EAP-request/AKA'-challenge message within AUTHENTICATION REQUEST with the
sequence number in AUTN is not correct }
  then { the UE sends an EAP-response/AKA'-synchronization-failure message within AUTHENTICATION
RESPONSE }
}
```

(3)

```
with { the UE in 5GMM-REGISTERED-INITIATED state }
ensure that {
  when { the SS sends an EAP-request/AKA'-challenge message within AUTHENTICATION REQUEST }
  then { the UE sends an EAP-response/AKA'-challenge message within AUTHENTICATION RESPONSE }
}
```

(4)

```
with { the UE in 5GMM-REGISTERED-INITIATED state and SS initiates an EAP based primary
authentication and key agreement procedure }
ensure that {
  when { the SS sends an EAP-success message within AUTHENTICATION RESULT }
  then { the UE considers the procedure complete and authentication procedure succeed }
}
```

9.1.1.1.2 Conformance requirements

References: The conformance requirements covered in the present TC are specified in: TS 24.501 clauses 5.4.1.2.2.3, 5.4.1.2.2.4, 5.4.1.2.2.6B, 5.4.1.2.2.8.

[TS 24.501, clause 5.4.1.2.2.6B (TP1)]

Upon receipt of the AUTHENTICATION REQUEST message with EAP-Request/Identity message the UE shall send an AUTHENTICATION RESPONSE message with EAP-Response/Identity to the network. In the EAP-Response/Identity message, the UE shall provide the requested identity according to 3GPP TS 33.501 [24] annex F.2, in the UE identity in the EAP-Response/Identity message as specified in IETF RFC 5448 [40].

Upon receipt of the AUTHENTICATION REQUEST message with EAP-Request/AKA'-Identity message the UE shall send an AUTHENTICATION RESPONSE message with EAP-Response/AKA'-Identity to the network. Based on the attribute received in the EAP-Request/AKA'-Identity, the UE shall provide the requested identity according to 3GPP TS 33.501 [24] annex F.2, in the EAP-Response/AKA'-Identity message, as specified in IETF RFC 5448 [40].

If the EAP-Request/AKA'-Identity carries the AT_PERMANENT_REQ, the UE shall respond with EAP-Response/AKA'-Client-Error with the error code "unable to process packet".

[TS 24.501, clause 5.4.1.2.2.4 (TP2)]

If a USIM is present, the SNN check fails or the UE does not accept AUTN during handling of the EAP-request/AKA'-challenge message as specified in IETF RFC 5448 [40], the UE shall send an EAP-response/AKA'-authentication-reject message as specified in IETF RFC 5448 [40].

If a USIM is present, the SNN check is successful but the UE detects that the sequence number in AUTN is not correct during handling of the EAP-request/AKA'-challenge message as specified in IETF RFC 5448 [40], the UE shall send an EAP-response/AKA'-synchronization-failure message as specified in IETF RFC 5448 [40].

If a USIM is present, the SNN check is successful, the sequence number in AUTN is correct and the UE detects another error during handling of the EAP-request/AKA'-challenge message as specified in IETF RFC 5448 [40], the UE shall send an EAP-response/AKA'-client-error message as specified in IETF RFC 5448 [40].

If a USIM is not present, the UE shall send an EAP-response/AKA'-client-error message as specified in IETF RFC 5448 [40].

For any of the above, the UE shall start timer T3520 when the AUTHENTICATION RESPONSE message containing the EAP-response message is sent. Furthermore, the UE shall stop any of the retransmission timers that are running (e.g. T3510, T3517 or T3521). Upon receiving an AUTHENTICATION REQUEST message with the EAP message IE containing an EAP-request/AKA'-challenge from the network, the UE shall stop timer T3520, if running, and then process the EAP-request/AKA'-challenge information as normal.

[TS 24.501, clause 5.4.1.2.2.3 (TP3)]

If a USIM is present and the SNN check is successful, the UE shall handle the EAP-request/AKA'-challenge message as specified in IETF RFC 5448 [40]. The USIM shall derive CK and IK and compute the authentication response (RES) using the 5G authentication challenge data received from the ME, and pass RES to the ME. The ME shall derive CK' and IK' from CK and IK, and EMSK from CK' and IK'. Furthermore, the ME may generate K_{AUSF} from the EMSK, the K_{SEAF} from the K_{AUSF} , and the K_{AMF} from the ABBA received together with the EAP-request/AKA'-challenge message, and the K_{SEAF} as described in 3GPP TS 33.501 [24], and create a partial native 5G NAS security context identified by the ngKSI value received together with the EAP-request/AKA'-challenge message in clause 5.4.1.2.4.2 in the volatile memory of the ME. If the K_{AMF} and the partial native 5G NAS security context are created, the ME shall store the K_{AMF} in the created partial native 5G NAS security context, and shall send an EAP-response/AKA'-challenge message as specified in IETF RFC 5448 [40].

If the EAP-request/AKA'-challenge message contains AT_RESULT_IND attribute, the UE may include AT_RESULT_IND attribute in the EAP-response/AKA'-challenge message as specified in IETF RFC 5448 [40].

[TS 24.501, clause 5.4.1.2.2.8 (TP4)]

Upon receiving an EAP-success message, if the ME has not generated a partial native 5G NAS security context as described in subclause 5.4.1.2.2.3, the ME shall:

- a) generate the K_{AUSF} from the EMSK, the K_{SEAF} from the K_{AUSF} , and the K_{AMF} from the ABBA that was received with the EAP-success message, and the K_{SEAF} as described in 3GPP TS 33.501 [24];
- b) create a partial native 5G NAS security context identified by the ngKSI value in the volatile memory of the ME;
and

- c) store the K_{AMF} in the created partial native 5G NAS security context.

The UE shall consider the procedure complete.

9.1.1.1.3 Test description

9.1.1.1.3.1 Pre-test conditions

System Simulator:

- NGC Cell A is configured according to table 6.3.2.2-1 in TS 38.508-1 [4].

UE:

- None

Preamble:

- The UE is in state Switched OFF Mode (state ON-B) according to TS 38.508-1 [4].

9.1.1.1.3.2 Test procedure sequence

Table 9.1.1.1.3.2-1: Main behaviour

| St | Procedure | Message Sequence | | TP | Verdict |
|-------|---|------------------|-------------------------------|----|---------|
| | | U - S | Message | | |
| 1 | The UE is switched on. | - | - | - | - |
| 2-4 | The UE establishes RRC connection and initiates registration procedure by executing steps 2-4 of Table 4.5.2.2-2 in TS 38.508-1 [4]. | - | - | - | - |
| 5 | SS transmits an AUTHENTICATION REQUEST message with an EAP-Request/AKA'-Identity message. | <- | 5GMM: AUTHENTICATION REQUEST | | |
| 6 | Check: Does the UE respond with an AUTHENTICATION RESPONSE message, with an EAP-Response/AKA'-Identity message? | --> | 5GMM: AUTHENTICATION RESPONSE | 1 | P |
| 7 | SS transmits an AUTHENTICATION REQUEST message with an EAP-Request/AKA'-challenge message which contains a not correct sequence number. | <- | 5GMM: AUTHENTICATION REQUEST | - | - |
| 8 | Check: Does the UE respond with an AUTHENTICATION RESPONSE message, with an EAP-Response/AKA'-synchronization-failure? | --> | 5GMM: AUTHENTICATION RESPONSE | 2 | P |
| 9 | SS transmits a correct AUTHENTICATION REQUEST message with an EAP-Request/AKA'-challenge message. | <- | 5GMM: AUTHENTICATION REQUEST | - | - |
| 10 | Check: Does the UE respond with a correct AUTHENTICATION RESPONSE message, with an EAP-Response/AKA'-challenge message? | --> | 5GMM: AUTHENTICATION RESPONSE | 3 | P |
| 11 | SS transmits an AUTHENTICATION RESULT message with an EAP-success message. | <- | 5GMM: AUTHENTICATION RESULT | - | - |
| 12-18 | The registration procedure is performed by executing steps 8-14 of Table 4.5.2.2-2 in TS 38.508-1 [4]. | - | - | - | - |
| 19 | Check: Does the UE transmits a REGISTRATION COMPLETE message? | --> | 5GMM: REGISTRATION COMPLETE | 4 | P |
| 20 | Steps 19a1 of Table 4.5.2.2-2 in TS 38.508-1 [4] are performed | - | - | - | - |

9.1.1.1.3.3 Specific message contents

Table 9.1.1.1.3.3-1: Message AUTHENTICATION REQUEST (step 5, Table 9.1.1.1.3.2-1)

| Derivation path: TS 38.508-1 [4], table 4.7.1-1 | | | |
|---|---------------------------|-------------------------|-----------|
| Information Element | Value/Remark | Comment | Condition |
| EAP message | EAP-request/AKA'-Identity | See Table 9.1.1.1.3.3-7 | EAP-AKA |

Table 9.1.1.1.3.3-2: Message AUTHENTICATION RESPONSE (step 6, Table 9.1.1.1.3.2-1)

| Derivation path: TS 38.508-1 [4], table 4.7.1-2 | | | |
|---|----------------------------|-------------------------|-----------|
| Information Element | Value/Remark | Comment | Condition |
| EAP message | EAP-response/AKA'-Identity | See Table 9.1.1.1.3.3-8 | EAP-AKA |

Table 9.1.1.1.3.3-3: Message AUTHENTICATION REQUEST (step 7, Table 9.1.1.1.3.2-1)

| Derivation path: TS 38.508-1 [4], table 4.7.1-1 | | | |
|---|----------------------------|--|-----------|
| Information Element | Value/Remark | Comment | Condition |
| EAP message | EAP-request/AKA'-challenge | The sequence number in AUTN is not correct | EAP-AKA |

Table 9.1.1.1.3.3-4: Message AUTHENTICATION RESPONSE (step 8, Table 9.1.1.1.3.2-1)

| Derivation path: TS 38.508-1 [4], table 4.7.1-2 | | | |
|---|---|---------|-----------|
| Information Element | Value/Remark | Comment | Condition |
| EAP message | EAP-response/AKA'-synchronization-failure | | EAP-AKA |

Table 9.1.1.1.3.3-5: Message AUTHENTICATION RESPONSE (step 10, Table 9.1.1.1.3.2-1)

| Derivation path: TS 38.508-1 [4], table 4.7.1-2 | | | |
|---|-----------------------------|---|-----------|
| Information Element | Value/Remark | Comment | Condition |
| EAP message | EAP-Response/AKA'-Challenge | RES* equal to the XRES* calculated in the SS with the parameters provided/indicated in the AUTHENTICATION REQUEST | EAP-AKA |

Table 9.1.1.1.3.3-6: Message AUTHENTICATION RESULT (step 11, Table 9.1.1.1.3.2-1)

| Derivation path: TS 38.508-1 [4], table 4.7.1-3 | | | |
|---|--------------|---------|-----------|
| Information Element | Value/Remark | Comment | Condition |
| EAP message | EAP-Success | | EAP-AKA |

Table 9.1.1.1.3.3-7: Message EAP-Request/AKA'-Identity (Table 9.1.1.1.3.3-1)

| Derivation Path: IETF RFC 4187 [30] clause 9.1, RFC 3748 [32] clause 4 | | | |
|--|-----------------------------|-------------------------|-----------|
| Information Element | Value/Remark | Comment | Condition |
| Code | 1 | Request | |
| Length | Set to length of EAP packet | | |
| Data | | | |
| AT_ANY_ID_REQ | AT_ANY_ID_REQ_Def | See Table 9.1.1.1.3.3-9 | |

Table 9.1.1.1.3.3-8: Message EAP-Response/AKA'-Identity (Table 9.1.1.1.3.3-2)

| Derivation Path: IETF RFC 4187 [30] clause 9.2, RFC 3748 [32] clause 4 | | | |
|--|-----------------------------|--------------------------|-----------|
| Information Element | Value/Remark | Comment | Condition |
| Code | 2 | Response | |
| Length | Set to length of EAP packet | | |
| Data | | | |
| AT_IDENTITY | AT_IDENTITY_Def | See Table 9.1.1.1.3.3-10 | |

Table 9.1.1.1.3.3-9: AT_ANY_ID_REQ_Def (Table 9.1.1.1.3.3-7)

| Derivation Path: IETF RFC 4187 [30] clause 10.3 | | | |
|---|------------------------|---------|-----------|
| Information Element | Value/remark | Comment | Condition |
| AT_ANY_ID_REQ | '0000 1101'B | 13 | |
| Length | '0000 0001'B | 1 | |
| Reserved | '0000 0000 0000 0000'B | | |

Table 9.1.1.1.3.3-10: AT_IDENTITY_Def (Table 9.1.1.1.3.3-8)

| Derivation Path: IETF RFC 4187 [30] clause 10.5 | | | |
|---|---|----------------|-----------|
| Information Element | Value/remark | Comment | Condition |
| AT_IDENTITY | '0000 1110'B | 14 | |
| Length | Set to the Length of AT_IDENTITY attribute in 4 bytes | | |
| Actual Identity Length | Set to the actual length of 'identity' in bytes excluding any appended all zero bytes at end | | |
| Identity | Value generated according to TS 24.501 [28] clause 9.11.3.4 and shall be a multiple of 4 bytes (appended with 1,2 or 3 bytes of all zero bits when necessary) | SUCI of the UE | |

9.1.1.2 EAP based primary authentication and key agreement / Reject

9.1.1.2.1 Test Purpose (TP)

(1)

```
with {the UE in 5GMM-REGISTERED-INITIATED state }
ensure that {
  when { the SS sends the EAP-request/AKA'-challenge message within AUTHENTICATION REQUEST with
incorrect SNN }

```

```

    then { the UE sends an EAP-response/AKA'-authentication-reject message within AUTHENTICATION
RESPONSE}
    }

```

(2)

```

with {the UE in 5GMM-REGISTERED-INITIATED state }
ensure that {
    when { the SS sends an EAP-Request/AKA'-notification message within AUTHENTICATION REQUEST }
        then { the UE sends an EAP-Response/AKA'-notification message within AUTHENTICATION RESPONSE }
    }

```

(3)

```

with {the UE in 5GMM-REGISTERED-INITIATED state and SS initiates an EAP based primary authentication
and key agreement procedure}
ensure that {
    when { the SS sends an EAP-failure message within AUTHENTICATION REJECT }
        then { the UE deletes the stored 5G-GUTI, TAI list, last visited registered TAI and ngKSI and
enter state 5GMM-DEREGISTERED, the USIM is considered invalid until switching off the UE }
    }

```

9.1.1.2.2 Conformance requirements

References: The conformance requirements covered in the current TC are specified in: TS 24.501, clauses 5.4.1.2.2.4, 5.4.1.2.2.6, and 5.4.1.2.2.11.

[TS 24.501, clause 5.4.1.2.2.4]

If a USIM is present, the SNN check fails or the UE does not accept AUTN during handling of the EAP-request/AKA'-challenge message as specified in IETF RFC 5448 [40], the UE shall send an EAP-response/AKA'-authentication-reject message as specified in IETF RFC 5448 [40].

If a USIM is present, the SNN check is successful but the UE detects that the sequence number in AUTN is not correct during handling of the EAP-request/AKA'-challenge message as specified in IETF RFC 5448 [40], the UE shall send an EAP-response/AKA'-synchronization-failure message as specified in IETF RFC 5448 [40].

If a USIM is present, the SNN check is successful, the sequence number in AUTN is correct and the UE detects another error during handling of the EAP-request/AKA'-challenge message as specified in IETF RFC 5448 [40], the UE shall send an EAP-response/AKA'-client-error message as specified in IETF RFC 5448 [40].

If a USIM is not present, the UE shall send an EAP-response/AKA'-client-error message as specified in IETF RFC 5448 [40].

For any of the above, the UE shall start timer T3520 when the AUTHENTICATION RESPONSE message containing the EAP-response message is sent. Furthermore, the UE shall stop any of the retransmission timers that are running (e.g. T3510, T3517 or T3521). Upon receiving an AUTHENTICATION REQUEST message with the EAP message IE containing an EAP-request/AKA'-challenge from the network, the UE shall stop timer T3520, if running, and then process the EAP-request/AKA'-challenge information as normal.

[TS 24.501, clause 5.4.1.2.2.6]

Upon receiving an EAP-request/AKA'-notification message, the UE shall send an EAP-response/AKA'-notification message as specified in IETF RFC 5448 [40].

[TS 24.501, clause 5.4.1.2.2.11]

Upon receiving an EAP-failure message, the UE shall delete the partial native 5G NAS security context if any was created as described in subclause 5.4.1.2.2.3.

The UE shall consider the procedure complete.

If the EAP-failure message is received in an AUTHENTICATION REJECT message:

- the UE shall set the update status to 5U3 ROAMING NOT ALLOWED, delete the stored 5G-GUTI, TAI list, last visited registered TAI and ngKSI. The USIM shall be considered invalid until switching off the UE or the UICC containing the USIM is removed; and

- if the UE is operating in single-registration mode, the UE shall handle 4G-GUTI, last visited registered TAI, TAI list and eKSI as specified in 3GPP TS 24.301 [15] for the case when the authentication procedure is not accepted by the network. The USIM shall be considered as invalid also for non-EPS services until switching off or the UICC containing the USIM is removed.

If the AUTHENTICATION REJECT message is received by the UE, the UE shall abort any 5GMM signalling procedure, stop any of the timers T3510, T3517 or T3521 (if they were running) and enter state 5GMM-DEREGISTERED.

9.1.1.2.3 Test description

9.1.1.2.3.1 Pre-test conditions

System Simulator:

- NGC Cell A "Serving cell" TS 38.508-1 [4] Table 6.2.2.1-3

UE:

- None

Preamble:

- The UE is in state Switched OFF (state 0N-B) according to TS 38.508-1 [4].

9.1.1.2.3.2 Test procedure sequence

Table 9.1.1.2.3.2-1: Main behaviour

| St | Procedure | Message Sequence | | TP | Verdict |
|-----|---|------------------|--------------------------------|----|---------|
| | | U – S | Message | | |
| 1 | The UE is switched on. | - | - | - | - |
| 2-4 | The UE executes steps 2-4 of Table 4.5.2.2-2 in TS38.508-1 [4]. | - | - | - | - |
| 5 | The SS transmits "EAP-request/AKA'-challenge" message in AUTHENTICATION REQUEST with incorrect SNN. | | 5GMM: AUTHENTICATION REQUEST | - | - |
| 6 | Check: Does the UE transmit an "EAP-response/AKA'-authentication-reject" message in AUTHENTICATION RESPONSE? | | 5GMM: AUTHENTICATION RESPONSE | 1 | P |
| 6A | The SS transmits "EAP-failure" message within AUTHENTICATION RESULT message. | <-- | 5GMM: AUTHENTICATION RESULT | - | - |
| 7 | The SS transmits "EAP-request/AKA'-challenge" message in AUTHENTICATION REQUEST. | | 5GMM: AUTHENTICATION REQUEST | - | - |
| 8 | The UE transmit an "EAP-response/AKA'-challenge" message in AUTHENTICATION RESPONSE. | | 5GMM: AUTHENTICATION RESPONSE | - | - |
| 9 | The SS transmits "EAP- request /AKA'-notification" message in AUTHENTICATION REQUEST. | | 5GMM: AUTHENTICATION REQUEST | - | - |
| 10 | Check: Does the UE transmit an "EAP-response/AKA'-notification" message in AUTHENTICATION RESPONSE? | | 5GMM: AUTHENTICATION RESPONSE | 2 | P |
| 11 | The SS transmits an "EAP-failure" message within AUTHENTICATION REJECT | <-- | 5GMM: AUTHENTICATION REJECT | - | - |
| 12 | SS releases the RRC connection | - | - | - | - |
| 13 | Check: Does the UE transmit an RRCSetupRequest message for initial registration procedure within the next 30 seconds? | --> | NR RRC: <i>RRCSetupRequest</i> | 3 | F |
| 14 | The UE is switched off by executing generic procedure in Table 4.9.6.4-1 in TS 38.508-1 [4]. | - | - | - | - |
| 15 | The UE is switched on. | - | - | - | - |
| 16 | Check: Does the UE transmit a REGISTRATION REQUEST message? | --> | 5GMM: REGISTRATION REQUEST | 3 | P |
| 17 | The UE executes steps 5-20a1 of Table 4.5.2.2-2 in TS38.508-1 [4] complete registration procedure. | - | - | - | - |

9.1.1.2.3.3 Specific message contents

Table 9.1.1.2.3.3-1: AUTHENTICATION REQUEST (step 5, Table 9.1.1.2.3.2-1)

| Derivation path: TS 38.508-1 [4], table 4.7.1-1 | | | |
|---|------------------------------|---|-----------|
| Information Element | Value/Remark | Comment | Condition |
| Extended protocol discriminator | 5GMM | | |
| Security header type | '0000'B | Plain 5GS NAS message, not security protected | |
| Spare half octet | '0000'B | | |
| EAP message | "EAP-request/AKA'-challenge" | SNN in EAP message is incorrect or does not match with the PLMN identity saved in the UE. | |
| NOTE: This message is sent within SECURITY PROTECTED 5GS NAS MESSAGE message with Integrity protected and ciphered. | | | |

Table 9.1.1.2.3.3-2: AUTHENTICATION RESPONSE (step 6, Table 9.1.1.2.3.2-1)

| Derivation path: TS 38.508-1 [4], table 4.7.1-2 | | | |
|---|--|---|-----------|
| Information Element | Value/Remark | Comment | Condition |
| Extended protocol discriminator | 5GMM | | |
| Security header type | '0000'B | Plain 5GS NAS message, not security protected | |
| Spare half octet | '0000'B | | |
| EAP message | "EAP-response/AKA'-authentication-reject " | | |
| NOTE: This message is sent within SECURITY PROTECTED 5GS NAS MESSAGE message with Integrity protected and ciphered. | | | |

Table 9.1.1.2.3.3-2A: AUTHENTICATION RESULT (step 6A, Table 9.1.1.2.3.2-1)

| Derivation path: TS 38.508-1 [4], table 4.7.1-3 | | | |
|---|---|---|-----------|
| Information Element | Value/Remark | Comment | Condition |
| Extended protocol discriminator | 5GMM | | |
| Security header type | '0000'B | Plain 5GS NAS message, not security protected | |
| Spare half octet | '0000'B | | |
| ngKSI | The same value as the last AUTHENTICATION REQUEST message | | |
| Spare half octet | '0000'B | | |
| EAP message | EAP-failure | EAP-failure | |
| ABBA | '0000 0000 0000 0000'B | | |
| NOTE: This message is sent within SECURITY PROTECTED 5GS NAS MESSAGE message with Integrity protected and ciphered. | | | |

Table 9.1.1.2.3.3-3: AUTHENTICATION RESPONSE (step 8, Table 9.1.1.2.3.2-1)

| Derivation path: TS 38.508-1 [4], table 4.7.1-2 | | | |
|---|------------------------------|---|-----------|
| Information Element | Value/Remark | Comment | Condition |
| Extended protocol discriminator | 5GMM | | |
| Security header type | '0000'B | Plain 5GS NAS message, not security protected | |
| Spare half octet | '0000'B | | |
| EAP message | "EAP-request/AKA'-challenge" | | |
| NOTE: This message is sent within SECURITY PROTECTED 5GS NAS MESSAGE message with Integrity protected and ciphered. | | | |

Table 9.1.1.2.3.3-4: AUTHENTICATION REQUEST (step 9, Table 9.1.1.2.3.2-1)

| Derivation path: TS 38.508-1 [4], table 4.7.1-1 | | | |
|---|----------------------------------|---|-----------|
| Information Element | Value/Remark | Comment | Condition |
| Extended protocol discriminator | 5GMM | | |
| Security header type | '0000'B | Plain 5GS NAS message, not security protected | |
| Spare half octet | '0000'B | | |
| EAP message | "EAP-request /AKA'-notification" | See Table 9.1.1.2.3.3-8 | |
| NOTE: This message is sent within SECURITY PROTECTED 5GS NAS MESSAGE message with Integrity protected and ciphered. | | | |

Table 9.1.1.2.3.3-5: AUTHENTICATION RESPONSE (step 10, Table 9.1.1.2.3.2-1)

| Derivation path: TS 38.508-1 [4], table 4.7.1-2 | | | |
|---|----------------------------------|---|-----------|
| Information Element | Value/Remark | Comment | Condition |
| Extended protocol discriminator | 5GMM | | |
| Security header type | '0000'B | Plain 5GS NAS message, not security protected | |
| Spare half octet | '0000'B | | |
| EAP message | "EAP-response/AKA'-notification" | See Table 9.1.1.2.3.3-9 | |
| NOTE: This message is sent within SECURITY PROTECTED 5GS NAS MESSAGE message with Integrity protected and ciphered. | | | |

Table 9.1.1.2.3.3-6: AUTHENTICATION REJECT (step 11, Table 9.1.1.2.3.2-1)

| Derivation path: TS 38.508-1 [4], table 4.7.1-5 | | | |
|---|--------------|---|-----------|
| Information Element | Value/Remark | Comment | Condition |
| Extended protocol discriminator | 5GMM | | |
| Security header type | '0000'B | Plain 5GS NAS message, not security protected | |
| Spare half octet | '0000'B | | |
| EAP message | EAP-failure | EAP-failure | |
| NOTE: This message is sent within SECURITY PROTECTED 5GS NAS MESSAGE message with Integrity protected and ciphered. | | | |

Table 9.1.1.2.3.3-7: REGISTRATION REQUEST (step16, Table 9.1.1.2.3.2-1)

| Derivation path: TS 38.508-1 [4], table 4.7.1-6 | | | |
|---|-------------------|---|-----------|
| Information Element | Value/Remark | Comment | Condition |
| 5GS registration type | '0000 0010'B | Initial registration | |
| ngKSI | | | |
| NAS key set identifier | '111'B | no key is available | |
| TSC | Any allowed value | TSC does not apply for NAS key set identifier value "111" | |
| Last visited registered TAI | Not present | | |
| 5GS mobile identity | SUCI of the UE | | |

Table 9.1.1.2.3.3-8: EAP-Request/AKA'-Notification (Table 9.1.1.2.3.3-4)

| Derivation Path: IETF RFC 4187 [30] clause 9.10, RFC 3748 [32] clause 4 | | | |
|---|-----------------------------|--------------------------|-----------|
| Information Element | Value/Remark | Comment | Condition |
| Code | 1 | Request | |
| Length | Set to length of EAP packet | | |
| Data | | | |
| AT_NOTIFICATION | AT_NOTIFICATION_Def | See Table 9.1.1.2.3.3-10 | |

Table 9.1.1.2.3.3-9: EAP-Response/AKA'-Notification (Table 9.1.1.2.3.2-5)

| Derivation Path: IETF RFC 4187 [30] clause 9.11, RFC 3748 [32] clause 4 | | | |
|---|-----------------------------|----------|-----------|
| Information Element | Value/Remark | Comment | Condition |
| Code | 2 | Response | |
| Length | Set to length of EAP packet | | |
| Data | Not present | | |

Table 9.1.1.2.3.3-10: AT_NOTIFICATION_Def (Table 9.1.1.2.3.3-8)

| Derivation Path: IETF RFC 4187 [30] clause 10.19 | | | |
|--|------------------------|--------------------------|-----------|
| Information Element | Value/remark | Comment | Condition |
| AT_NOTIFICATION | '0000 1100'B | 12 | |
| Length | '0000 0001'B | 1 | |
| Notification Code | '0100 0000 0000 0000'B | Set to "General failure" | |

9.1.1.3 EAP based primary authentication and key agreement / EAP message transport / Abnormal

9.1.1.3.1 Test Purpose (TP)

(1)

```
with { the UE in 5GMM-REGISTERED-INITIATED state }
ensure that {
  when { the SS sends the EAP-request/AKA'-challenge message within AUTHENTICATION REQUEST with
ngKSI is already in use }
  then { the UE sends an AUTHENTICATION FAILURE message with 5GMM cause #71 "ngKSI already in use"
}
}
```

(2)

```
with { the UE in 5GMM-REGISTERED-INITIATED state }
```

```

ensure that {
  when { the third time SS sends the EAP-request/AKA'-challenge message within AUTHENTICATION
  REQUEST with ngKSI is already in use }
  then { the UE locally releases the RRC connection and treats the active cell as barred }
}

```

(3)

```

with { the UE in 5GMM-REGISTERED-INITIATED state, the SS sends the EAP-request/AKA'-challenge
message within AUTHENTICATION REQUEST with ngKSI is already in use and the UE sends an
AUTHENTICATION FAILURE message }
ensure that {
  when { T3520 times out }
  then { the UE locally releases the RRC connection and treats the active cell as barred }
}

```

(4)

Void

(5)

```

with { the UE in 5GMM-REGISTERED state and initiates a mobility registration update procedure }
ensure that {
  when { the SS sends the EAP-request/AKA'-challenge message within AUTHENTICATION REQUEST and the
  UE fails on transmission of AUTHENTICATION RESPONSE message with the indication from lower layers }
  then { the UE re-initiate the mobility registration update procedure }
}

```

9.1.1.3.2 Conformance requirements

References: The conformance requirements covered in the present TC are specified in: TS 24.501 clauses 5.4.1.2.4.5. Unless otherwise stated these are Rel-15 requirements.

[TS 24.501, clause 5.4.1.2.4.5 (TP1, TP2, TP3, TP4, TP5)]

The following abnormal cases can be identified:

- a) Authentication failure (5GMM cause #71 "ngKSI already in use").

The UE shall send an AUTHENTICATION FAILURE message, with 5GMM cause #71 "ngKSI already in use", to the network and start the timer T3520 (see example in figure 5.4.1.3.7.1). Furthermore, the UE shall stop any of the retransmission timers that are running (e.g. T3510, T3517 or T3521). Upon the first receipt of an AUTHENTICATION FAILURE message from the UE with 5GMM cause #71 "ngKSI already in use", the network performs necessary actions to select a new ngKSI and send the same EAP-request message to the UE.

- NOTE 1: Upon receipt of an AUTHENTICATION FAILURE message from the UE with 5GMM cause #71 "ngKSI already in use", the network can also re-initiate the EAP based primary authentication and key agreement procedure (see subclause 5.4.1.2.2.2).

Upon receiving a new AUTHENTICATION REQUEST message with the EAP message IE containing an EAP-request message from the network, the UE shall stop timer T3520, if running, process the EAP-request message as normal.

If the network is validated successfully (an AUTHENTICATION REQUEST message that contains a valid ngKSI and EAP-request message is received), the UE shall send the AUTHENTICATION RESPONSE message to the network and shall start any retransmission timers (e.g. T3510, T3517 or T3521) if they were running and stopped when the UE received the first failed AUTHENTICATION REQUEST message.

- b) Transmission failure of AUTHENTICATION RESPONSE message or AUTHENTICATION FAILURE message indication from lower layers (if the EAP based primary authentication and key agreement procedure is triggered by a registration procedure for mobility and periodic registration update).

The UE shall stop the timer T3520, if running, and re-initiate the registration procedure for mobility and periodic registration update.

- c) Transmission failure of AUTHENTICATION RESPONSE message or AUTHENTICATION FAILURE message indication with TAI change from lower layers (if the EAP based primary authentication and key agreement procedure is triggered by a service request procedure).

The UE shall stop the timer T3520, if running.

If the current TAI is not in the TAI list, the EAP based primary authentication and key agreement procedure shall be aborted and a registration procedure for mobility and periodic registration update shall be initiated.

If the current TAI is still part of the TAI list, it is up to the UE implementation how to re-run the ongoing procedure that triggered the EAP based primary authentication and key agreement procedure.

...

- e) Network failing the authentication check.

If the UE deems that the network has failed the authentication check, then it shall request RRC to locally release the RRC connection and treat the active cell as barred (see 3GPP TS 38.304 [28]). The UE shall start any retransmission timers (e.g. T3510, T3517 or T3521), if they were running and stopped when the UE received the first AUTHENTICATION REQUEST message containing an ngKSI that was already in use.

For item e, whether or not the UE is registered for emergency services:

The UE shall stop timer T3520, if the timer is running and the UE enters 5GMM-IDLE mode, e.g. upon detection of a lower layer failure, release of the N1 NAS signalling connection, or as the result of an inter-system change in 5GMM-CONNECTED mode from N1 mode to S1 mode.

The UE shall deem that the network has failed the authentication check or assume that the authentication is not genuine and proceed as described in item e above if any of the following occurs:

- the timer T3520 expires;
- the UE detects any combination of the EAP-based authentication failures: transmission of AUTHENTICATION FAILURE message with 5GMM cause #71 "ngKSI already in use", transmission of AUTHENTICATION RESPONSE message with an EAP-response message after detecting an error as described in subclause 5.4.1.2.2.4 or with an EAP-response message after not accepting of the server certificate as described in subclause 5.4.1.2.3.1, during three consecutive authentication challenges. The EAP-request/AKA'-challenge challenges shall be considered as consecutive only, if the EAP-request/AKA'-challenge challenges causing the second and third EAP-based authentication failure are received by the UE, while the timer T3520 started after the previous EAP-based authentication failure is running. Not accepting of the server certificate shall be considered as consecutive only, if the EAP-request messages causing the second and third not accepting of the server certificate are received by the UE, while the timer T3520 started after the previous EAP request message causing the previous not accepting of the server certificate is running.

NOTE 2: Reception of an EAP-failure message is not considered when determining the three consecutive authentication challenges or three consecutive not accepting of the server certificate.

...

9.1.1.3.3 Test description

9.1.1.3.3.1 Pre-test conditions

System Simulator:

- NGC Cell A, NGC Cell B, NGC Cell C and NGC Cell D are configured according to table 6.3.2.2-1 in TS 38.508-1 [4].
- System information combination NR-2 as defined in TS 38.508-1 [4] clause 4.4.3.1.2 is used.

UE:

- None

Preamble:

- The UE is in state Switched OFF Mode (state ON-B) according to TS 38.508-1 [4].

9.1.1.3.3.2 Test procedure sequence

Table 9.1.1.3.3.2-1: Main behaviour

| St | Procedure | Message Sequence | | TP | Verdict |
|-----------|---|------------------|------------------------------|----|---------|
| | | U - S | Message | | |
| 1 | The SS configures:
- NGC Cell A as the "Serving cell".
- NGC Cell B, NGC Cell C and NGC Cell D as a "Non-suitable 'Off' cell". | - | - | - | - |
| - | The following messages are to be observed on NGC Cell A unless explicitly stated otherwise. | - | - | - | - |
| 2 | The UE is switched on. | - | - | - | - |
| 3-5 | The UE establishes RRC connection by executing steps 2-4 of Table 4.5.2.2-2 in TS 38.508-1 [4] and transmits a REGISTRATION REQUEST message. | --> | 5GMM: REGISTRATION REQUEST | - | - |
| 6 | SS transmits the EAP-request/AKA'-challenge message within an AUTHENTICATION REQUEST message, with ngKSI is already in use in the UE to initiate an EAP-AKA' procedure. | <-- | 5GMM: AUTHENTICATION REQUEST | - | - |
| 7 | Check: Does the UE respond with an AUTHENTICATION FAILURE message, with 5GMM cause "ngKSI already in use"? | --> | 5GMM: AUTHENTICATION FAILURE | 1 | P |
| 8 | SS transmits the EAP-request/AKA'-challenge message within an AUTHENTICATION REQUEST message, with ngKSI is already in use in the UE to initiate an EAP-AKA' procedure. | <-- | 5GMM: AUTHENTICATION REQUEST | - | - |
| 9 | Check: Does the UE respond with an AUTHENTICATION FAILURE message, with 5GMM cause "ngKSI already in use"? | --> | 5GMM: AUTHENTICATION FAILURE | 1 | P |
| 10 | The SS configures:
- NGC Cell B as the "Serving cell".
- NGC Cell A as a "Suitable neighbour intra-frequency cell". | - | - | - | - |
| 11 | SS transmits the EAP-request/AKA'-challenge message within an AUTHENTICATION REQUEST message, with ngKSI is already in use in the UE to initiate an EAP-AKA' procedure. | <-- | 5GMM: AUTHENTICATION REQUEST | - | - |
| 11a
1 | EXCEPTION: The UE may send an AUTHENTICATION FAILURE before locally releasing the RRC Connection | --> | 5GMM: AUTHENTICATION FAILURE | - | - |
| - | The following messages are to be observed on NGC Cell B unless explicitly stated otherwise. | - | - | - | - |
| 12-
14 | The UE establishes RRC connection by executing steps 2-4 of Table 4.5.2.2-2 in TS 38.508-1 [4]. | - | - | - | - |
| 15 | Check: Does the UE transmit a REGISTRATION REQUEST message with the 5GS registration type IE setting as Initial registration? | --> | 5GMM: REGISTRATION REQUEST | 2 | P |
| 16 | SS transmits the EAP-request/AKA'-challenge message within an AUTHENTICATION REQUEST message, with ngKSI is already in use in the UE to initiate an EAP-AKA' procedure. | <-- | 5GMM: AUTHENTICATION REQUEST | - | - |
| 17 | The UE responds with an AUTHENTICATION FAILURE message, with 5GMM cause "ngKSI already in use". | --> | 5GMM: AUTHENTICATION FAILURE | - | - |

| | | | | | |
|-----------------|---|-----|------------------------------|---|---|
| 17
A | The SS starts timer of t_Waits=T3520. | - | - | - | - |
| 18 | The SS configures:
- NGC Cell C as the "Serving cell".
- NGC Cell B as a "Suitable neighbour intra-frequency cell".
- NGC Cell A as the "Non-suitable 'Off' cell". | - | - | - | - |
| 19 | SS responds nothing and waits for the expiration of t_Waits. | - | - | - | - |
| - | The following messages are to be observed on NGC Cell C unless explicitly stated otherwise. | - | - | - | - |
| 20-
22 | The UE establishes RRC connection by executing steps 2-4 of Table 4.5.2.2-2 in TS 38.508-1 [4]. | - | - | - | - |
| 23 | Check: Does the UE transmit a REGISTRATION REQUEST message with the 5GS registration type IE setting as Initial registration? | --> | 5GMM: REGISTRATION REQUEST | 3 | P |
| 24-
39a
1 | The registration procedure is successfully completed by executing steps 5 to 20a1 of the generic procedure in TS 38.508-1 [4] Table 4.5.2.2-2. | - | - | - | - |
| - | The UE is in end state Registered, Idle Mode (1N-A) on NGC Cell C according to TS 38.508-1 [4]. | - | - | - | - |
| 40-
44 | Void | - | - | - | - |
| 45 | The SS configures:
- NGC Cell D as the "Serving cell", and the tracking area of NGC Cell D is not in the list of tracking areas that the UE previously registered.
- NGC Cell C as the "Suitable neighbour intra-frequency cell".
- NGC Cell B as the "Non-suitable 'Off' cell". | - | - | - | - |
| 46-
47 | Void | - | - | - | - |
| - | The following messages are to be observed on Cell D unless explicitly stated otherwise. | - | - | - | - |
| 48-
50 | The UE establishes RRC connection by executing steps 2-4 of Table 4.5.2.2-2 in TS 38.508-1 [4]. | - | - | - | - |
| 51 | The UE transmit a REGISTRATION REQUEST message with the 5GS registration type IE setting as Mobility registration updating. | --> | 5GMM: REGISTRATION REQUEST | - | - |
| 52 | The SS cuts off the UL grant and RA Response.
(Note 1) | - | - | - | - |
| 53 | SS transmits the EAP-request/AKA'-challenge message within a correct AUTHENTICATION REQUEST message to initiate an EAP-AKA' procedure. | <-- | 5GMM: AUTHENTICATION REQUEST | - | - |
| 54 | SS starts a timer t_Delay = 10s.
(Note 2) | - | - | - | - |
| 55 | SS locally releases the RRC connection and waits for the expiration of t_Delay. | - | - | - | - |
| 56 | The SS turn on the UL grant and RA Response. | - | - | - | - |
| 57-
59 | The UE establishes RRC connection by executing steps 1-3 of Table 4.9.5.2.2-1 in TS 38.508-1 [4]. | - | - | - | - |
| 60 | Check: Does the UE transmit a REGISTRATION REQUEST message with the 5GS registration type IE setting as mobility registration updating? | --> | 5GMM: REGISTRATION REQUEST | 5 | P |
| 61- | The registration procedure is successfully | - | - | - | - |

| | | | | | |
|----------|--|--|--|--|--|
| 63a
1 | completed by executing steps 4 to 6a1 of the generic procedure in TS 38.508-1 [4] Table 4.9.5.2.2-1. | | | | |
| Note 1: | For transmission of the AUTHENTICATION RESPONSE message, the UE needs to initiate RACH to get UL grant. Since not RA Response, registration failure due to lower layer failure will occur, then timer T3511 will be started. | | | | |
| Note 2: | Timer t_Delay is derived from timer T3511. During timer t_Delay, UE fails on transmission of the AUTHENTICATION RESPONSE message with the indication from lower layers. | | | | |

9.1.1.3.3.3 Specific message contents

Table 9.1.1.3.3.3-1: AUTHENTICATION REQUEST (step 6, 8, 11 and 16, Table 9.1.1.3.3.2-1)

| Derivation path: TS 38.508-1 [4], table 4.7.1-1 | | | |
|---|--------------|--|-----------|
| Information Element | Value/Remark | Comment | Condition |
| ngKSI | ngKSI | SS shall use the ngKSI is already in use in the UE | |

Table 9.1.1.3.3.3-2: AUTHENTICATION FAILURE (step 7, 9, 11a1 and 17, Table 9.1.1.3.3.2-1)

| Derivation path: TS 38.508-1 [4], table 4.7.1-4 | | | |
|---|--------------|----------------------|-----------|
| Information Element | Value/Remark | Comment | Condition |
| 5GMM cause | '0100 0111'B | ngKSI already in use | |

Table 9.1.1.3.3.3-3: REGISTRATION REQUEST (step 15 and step 23, Table 9.1.1.3.3.2-1)

| Derivation path: TS 38.508-1 [4], table 4.7.1-6 | | | |
|---|--------------|----------------------|-----------|
| Information Element | Value/Remark | Comment | Condition |
| 5GS registration type | '001'B | Initial registration | |

Table 9.1.1.3.3.3-4: REGISTRATION REQUEST (step 51 and step 60, Table 9.1.1.3.3.2-1)

| Derivation path: TS 38.508-1 [4], table 4.7.1-6 | | | |
|---|--------------|--------------------------------|-----------|
| Information Element | Value/Remark | Comment | Condition |
| 5GS registration type | '010'B | Mobility registration updating | |

Table 9.1.1.3.3.3-5: AUTHENTICATION REQUEST (step 53, Table 9.1.1.3.3.2-1)

| Derivation path: TS 38.508-1 [4], table 4.7.1-1 | | | |
|---|--------------|---|-----------|
| Information Element | Value/Remark | Comment | Condition |
| ngKSI | ngKSI | Different from the ngKSI assigned in step 24. | |

9.1.1.4 5G AKA based primary authentication and key agreement / 5G-AKA related procedures

9.1.1.4.1 Test Purpose (TP)

(1)

with { the UE in 5GMM-REGISTERED-INITIATED state }
ensure that {

```

when { the SS initiates a 5G AKA based primary authentication and key agreement procedure by
sending AUTHENTICATION REQUEST with invalid MAC code }
then { the UE sends an AUTHENTICATION FAILURE message to the network, with the 5GMM cause #20
"MAC failure" }
}

```

(2)

```

with { the UE in 5GMM-REGISTERED-INITIATED state }
ensure that {
when { the SS initiates a 5G AKA based primary authentication and key agreement procedure by
sending AUTHENTICATION REQUEST with the "separation bit" in the AMF field of AUTN supplied by the
core network is set to 0 }
then { the UE sends an AUTHENTICATION FAILURE message to the network, with the 5GMM cause #26
"non-5G authentication unacceptable" }
}

```

(3)

```

with { the UE in 5GMM-REGISTERED-INITIATED state }
ensure that {
when { the SS initiates a 5G AKA based primary authentication and key agreement procedure by
sending AUTHENTICATION REQUEST with the sequence number SQN to be out of range }
then { the UE sends an AUTHENTICATION FAILURE message to the network, with the 5GMM cause #21
"synch failure" and a re-synchronization token AUTS provided by the USIM }
}

```

(4)

```

with { the UE in 5GMM-REGISTERED-INITIATED state }
ensure that {
when { the SS initiates a 5G AKA based primary authentication and key agreement procedure by
sending AUTHENTICATION REQUEST }
then { the UE process the 5G authentication challenge data and respond with an AUTHENTICATION
RESPONSE message }
}

```

(5)

```

with { the UE in 5GMM-REGISTERED-INITIATED state and sends out an AUTHENTICATION RESPONSE message }
ensure that {
when { the SS proceeds with the registration procedure }
then { the UE consider the authentication procedure complete and succeed }
}

```

9.1.1.4.2 Conformance requirements

References: The conformance requirements covered in the present TC are specified in: TS 24.501 clauses 5.4.1.3.3, 5.4.1.3.6, 5.4.1.3.7. Unless otherwise stated these are Rel-15 requirements.

[TS 24.501, clause 5.4.1.3.3]

The UE shall respond to an AUTHENTICATION REQUEST message. With the exception of the cases described in subclause 5.4.1.3.5, the UE shall process the 5G authentication challenge data and respond with an AUTHENTICATION RESPONSE message to the network.

Upon a successful 5G authentication challenge, the new K_{AMF} calculated from the 5G authentication challenge data shall be stored in a new 5G NAS security context in the volatile memory of the ME.

[TS 24.501, clause 5.4.1.3.6]

In the 5G authentication challenge, the UE shall check the 5G authentication challenge data (RAND, AUTN and ngKSI) received in the AUTHENTICATION REQUEST message to verify authenticity of the 5G core network.

The ME shall check that ngKSI received in the AUTHENTICATION REQUEST message is not already in use. The ME shall forward the RAND and AUTN to the USIM to check.

The UE may reject the core network due to an incorrect AUTN or ngKSI parameter. If the UE has to reject the 5G authentication challenge, the UE shall return AUTHENTICATION FAILURE message to the network with a cause value indicating the reason for the failure (see 3GPP TS 33.501 [24]).

Incorrect 5G authentication challenge data contains four possible causes for authentication failure:

a) MAC code failure:

If the UE finds the MAC code (supplied by the core network in the AUTN parameter) to be invalid, the UE shall send an AUTHENTICATION FAILURE message to the network, with the 5GMM cause #20 "MAC failure". The UE shall then follow the procedure described in subclause 5.4.1.3.7, item c.

b) Non-5G authentication unacceptable:

If the UE finds that the "separation bit" in the AMF field of AUTN supplied by the core network is set to 0, the UE shall send an AUTHENTICATION FAILURE message to the network, with the 5GMM cause #26 "non-5G authentication unacceptable" (see subclause 6.1.3 in 3GPP TS 33.501 [24]). The UE shall then follow the procedure described in subclause 5.4.1.3.7, item d.

...

d) SQN failure:

If the UE finds the sequence number SQN (supplied by the core network in the AUTN parameter) to be out of range, the UE shall send an AUTHENTICATION FAILURE message to the network, with the 5GMM cause #21 "synch failure" and a re-synchronization token AUTS provided by the USIM (see 3GPP TS 33.102 [23]). The UE shall then follow the procedure described in subclause 5.4.1.3.7, item f.

[TS 24.501, clause 5.4.1.3.7]

c) Authentication failure (5GMM cause #20 "MAC failure").

The UE shall send an AUTHENTICATION FAILURE message, with 5GMM cause #20 "MAC failure" according to subclause 5.4.1.3.6, to the network and start timer T3520 (see example in figure 5.4.1.3.7.1). Furthermore, the UE shall stop any of the retransmission timers that are running (e.g. T3510, T3517 or T3521). Upon the first receipt of an AUTHENTICATION FAILURE message from the UE with 5GMM cause #20 "MAC failure", the network may initiate the identification procedure described in subclause 5.4.3. This is to allow the network to obtain the SUCI from the UE. The network may then check that the 5G-GUTI originally used in the 5G authentication challenge corresponded to the correct SUPI. Upon receipt of the IDENTITY REQUEST message from the network, the UE shall proceed as specified in subclause 5.4.3.3.

NOTE 1: Upon receipt of an AUTHENTICATION FAILURE message from the UE with 5GMM cause #20 "MAC failure", the network may also terminate the 5G AKA based primary authentication and key agreement procedure (see subclause 5.4.1.3.5).

If the mapping of 5G-GUTI to SUPI in the network was incorrect, the network should respond by sending a new AUTHENTICATION REQUEST message to the UE. Upon receiving the new AUTHENTICATION REQUEST message from the network, the UE shall stop the timer T3520, if running, and then process the 5G challenge information as normal. If the mapping of 5G-GUTI to SUPI in the network was correct, the network should terminate the 5G AKA based primary authentication and key agreement procedure by sending an AUTHENTICATION REJECT message (see subclause 5.4.1.3.5).

If the network is validated successfully (an AUTHENTICATION REQUEST message that contains a valid SQN and MAC is received), the UE shall send the AUTHENTICATION RESPONSE message to the network and shall start any retransmission timers (e.g. T3510, T3517 or T3521) if they were running and stopped when the UE received the first failed AUTHENTICATION REQUEST message.

If the UE receives the second AUTHENTICATION REQUEST message, and the MAC value cannot be resolved, the UE shall follow the procedure specified in this subclause, item c, starting again from the beginning, or if the message contains a UMTS authentication challenge, the UE shall follow the procedure specified in item d. If the SQN is invalid, the UE shall proceed as specified in item f.

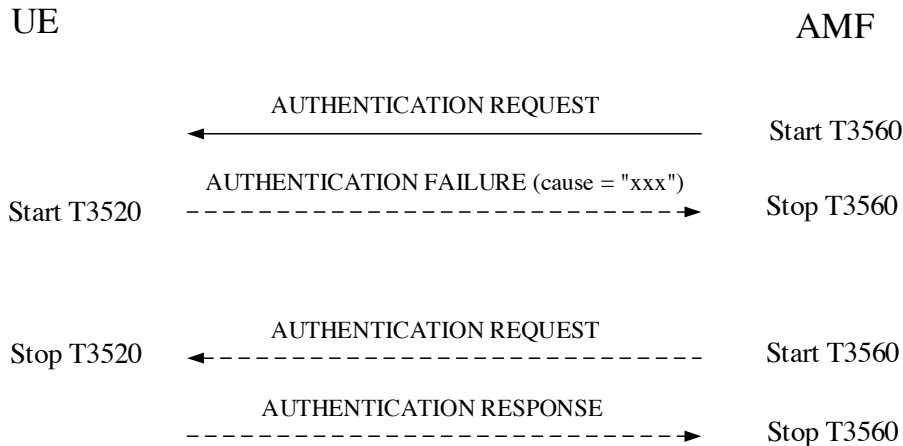

Figure 5.4.1.3.7.1: Authentication failure during 5G AKA based primary authentication and key agreement procedure

- d) Authentication failure (5GMM cause #26 "non-5G authentication unacceptable").

The UE shall send an AUTHENTICATION FAILURE message, with 5GMM cause #26 "non-5G authentication unacceptable", to the network and start the timer T3520 (see example in figure 5.4.1.3.7.1). Furthermore, the UE shall stop any of the retransmission timers that are running (e.g. T3510, T3517 or T3521). Upon the first receipt of an AUTHENTICATION FAILURE message from the UE with 5GMM cause #26 "non-5G authentication unacceptable", the network may initiate the identification procedure described in subclause 5.4.3. This is to allow the network to obtain the SUCI from the UE. The network may then check that the 5G-GUTI originally used in the 5G authentication challenge corresponded to the correct SUPI. Upon receipt of the IDENTITY REQUEST message from the network, the UE shall proceed as specified in subclause 5.4.3.3.

- NOTE 2: Upon receipt of an AUTHENTICATION FAILURE message from the UE with 5GMM cause #26 "non-5G authentication unacceptable", the network may also terminate the 5G AKA based primary authentication and key agreement procedure (see subclause 5.4.1.3.5).

If the mapping of 5G-GUTI to SUPI in the network was incorrect, the network should respond by sending a new AUTHENTICATION REQUEST message to the UE. Upon receiving the new AUTHENTICATION REQUEST message from the network, the UE shall stop the timer T3520, if running, and then process the 5G challenge information as normal. If the mapping of 5G-GUTI to SUPI in the network was correct, the network should terminate the 5G AKA based primary authentication and key agreement authentication procedure by sending an AUTHENTICATION REJECT message (see subclause 5.4.1.3.5).

...

- f) Authentication failure (5GMM cause #21 "synch failure").

The UE shall send an AUTHENTICATION FAILURE message, with 5GMM cause #21 "synch failure", to the network and start the timer T3520 (see example in figure 5.4.1.3.7.1). Furthermore, the UE shall stop any of the retransmission timers that are running (e.g. T3510, T3517 or T3521). Upon the first receipt of an AUTHENTICATION FAILURE message from the UE with the 5GMM cause #21 "synch failure", the network shall use the returned AUTS parameter from the authentication failure parameter IE in the AUTHENTICATION FAILURE message, to re-synchronise. The re-synchronisation procedure requires the AMF to delete all unused authentication vectors for that SUPI and obtain new vectors from the UDM/AUSF. When re-synchronisation is complete, the network shall initiate the 5G AKA based primary authentication and key agreement procedure. Upon receipt of the AUTHENTICATION REQUEST message, the UE shall stop the timer T3520, if running.

- NOTE 4: Upon receipt of two consecutive AUTHENTICATION FAILURE messages from the UE with 5GMM cause #21 "synch failure", the network may terminate the 5G AKA based primary authentication and key agreement procedure by sending an AUTHENTICATION REJECT message.

If the network is validated successfully (a new AUTHENTICATION REQUEST message is received which contains a valid SQN and MAC) while T3520 is running, the UE shall send the AUTHENTICATION RESPONSE message to the network and shall start any retransmission timers (e.g. T3510, T3517 or T3521), if they were running and stopped when the UE received the first failed AUTHENTICATION REQUEST message.

Upon receipt of an AUTHENTICATION REJECT message, the UE shall perform the actions as specified in subclause 5.4.1.3.5.

9.1.1.4.3 Test description

9.1.1.4.3.1 Pre-test conditions

System Simulator:

- NR cell A.

UE:

- None.

Preamble:

- the UE is in state Switched OFF (state ON-B) according to TS 38.508-1 [4].

9.1.1.4.3.2 Test procedure sequence

Table 9.1.1.4.3.2-1: Main behaviour

| St | Procedure | Message Sequence | | TP | Verdict |
|-------------|---|------------------|-------------------------|----|---------|
| | | U - S | Message | | |
| 1 | Switch the UE on | - | - | - | - |
| 2-4 | The UE establishes RRC connection and initiates registration procedure by executing steps 2-4 of Table 4.5.2.2-2 in TS 38.508-1 [4]. | - | - | - | - |
| 5 | The SS transmits an AUTHENTICATION REQUEST message which contains an invalid MAC code. | <-- | AUTHENTICATION REQUEST | - | - |
| 6 | Check: Does the UE respond with an AUTHENTICATION FAILURE message with 5GMM cause "MAC failure"? | --> | AUTHENTICATION FAILURE | 1 | P |
| 7 | SS transmits a correct AUTHENTICATION REQUEST message with RAND different to the one send in Step 5 | <-- | AUTHENTICATION REQUEST | - | - |
| 8 | Check: Does the UE respond with a correct AUTHENTICATION RESPONSE message with RES* that is equal to the XRES* calculated in the SS? | --> | AUTHENTICATION RESPONSE | 4 | P |
| 9 | SS transmits a NAS SECURITY MODE COMMAND message including the ngKSI of the new 5G NAS security context (as provided in step 7), to proceed with the registration procedure. | <-- | SECURITY MODE COMMAND | - | - |
| 10 | Check: Does the UE respond with NAS SECURITY MODE COMPLETE message integrity protected and ciphered with the new 5G NAS security context identified by the ngKSI received in the SECURITY MODE COMMAND message in step 9. | --> | SECURITY MODE COMPLETE | 5 | P |
| 11-20a
1 | Steps 10-19a1 of the generic procedure (TS 38.508-1 Table 4.5.2.2-2 [4]) are executed to successfully complete the registration procedure. | - | - | - | - |
| 21 | Switch off UE in RRC_CONNECTED as described in TS 38.508-1 [4] subclause 4.9.6.3 | - | - | - | - |
| 22-25 | Steps 1-4 above are repeated | - | - | - | - |
| 26 | SS transmits an AUTHENTICATION REQUEST message with "separation bit" in the AMF field is 0. | <-- | AUTHENTICATION REQUEST | - | - |
| 27 | Check: Does the UE respond with an AUTHENTICATION FAILURE message, with 5GMM cause " Non-5G authentication unacceptable "? | --> | AUTHENTICATION FAILURE | 2 | P |
| 28 | SS transmits a correct AUTHENTICATION REQUEST message with RAND different to the one send in Step 26 | <-- | AUTHENTICATION REQUEST | - | - |
| 29 | Check: Does the UE respond with a correct AUTHENTICATION RESPONSE message with RES* that is equal to the XRES* calculated in the SS? | --> | AUTHENTICATION RESPONSE | 4 | P |
| 30-41a
1 | Steps 8-19a1 of the generic procedure (TS 38.508-1 Table 4.5.2.2-2 [4]) are executed to successfully complete the registration procedure. | - | - | - | - |
| 42 | Switch off UE in RRC_CONNECTED as described in TS 38.508-1 [4] subclause 4.9.6.3 | - | - | - | - |
| 43-46 | Steps 1-4 above are repeated | - | - | - | - |
| 47 | SS transmits AUTHENTICATION REQUEST message with the AMF field in the IE "Authentication parameter AUTN" set to | <-- | AUTHENTICATION REQUEST | - | - |

| | | | | | |
|-------------|---|-----|-------------------------|---|---|
| | "AMF _{RESYNCH} " value to trigger SQN re-synchronisation procedure in test USIM | | | | |
| 48 | Check: Does the UE respond with an AUTHENTICATION FAILURE message, with 5GMM cause "Synch failure" and Authentication failure parameter? | --> | AUTHENTICATION FAILURE | 3 | P |
| 49 | SS transmits a correct AUTHENTICATION REQUEST message with RAND different to the one send in Step 47. | <-- | AUTHENTICATION REQUEST | - | - |
| 50 | Check: Does the UE respond with a correct AUTHENTICATION RESPONSE message with RES* that is equal to the XRES* calculated in the SS? | --> | AUTHENTICATION RESPONSE | 4 | P |
| 51-62a
1 | Steps 8-19a1 of the generic procedure (TS 38.508-1 Table 4.5.2.2-2 [4]) are executed to successfully complete the registration procedure. | - | - | - | - |

9.1.1.4.3.3 Specific message contents

Table 9.1.1.4.3.3-1: AUTHENTICATION RESPONSE (step 8, step 29 and step 50, Table 9.1.1.4.3.2-1)

| Derivation path: TS 38.508, Table 4.7.1-2 | | | |
|---|---|---------|-----------|
| Information Element | Value/remark | Comment | Condition |
| Authentication response parameter | RES* equal to the XRES* calculated in the SS with the parameters provided/indicated in the AUTHENTICATION REQUEST | | |

Table 9.1.1.4.3.3-2: AUTHENTICATION REQUEST (step 5, Table 9.1.1.4.3.2-1)

| Derivation path: TS 38.508, Table 4.7.1-1 | | | |
|---|--------------|---|-----------|
| Information Element | Value/remark | Comment | Condition |
| Authentication parameter AUTN | Invalid MAC | SS shall calculate the correct MAC value as specified in TS 33.102 and use any different value, e.g. correct_MAC+5. | |

Table 9.1.1.4.3.3-3: AUTHENTICATION FAILURE (step 6, Table 9.1.1.4.3.2-1)

| Derivation path: TS 38.508, Table 4.7.1-4 | | | |
|---|--------------|-------------|-----------|
| Information Element | Value/remark | Comment | Condition |
| 5GMM cause | '0001 0100'B | MAC failure | |

Table 9.1.1.4.3.3-4: AUTHENTICATION REQUEST (step 26, Table 9.1.1.4.3.2-1)

| Derivation path: TS 38.508, Table 4.7.1-1 | | | |
|---|--------------------|--|-----------|
| Information Element | Value/remark | Comment | Condition |
| Authentication parameter AUTN | "separation bit"=0 | The "separation bit" in the AMF field of AUTN supplied by the core network is 0. | |

Table 9.1.1.4.3.3-5: AUTHENTICATION FAILURE (step 27, Table 9.1.1.4.3.2-1)

| Derivation path: TS 38.508, Table 4.7.1-4 | | | |
|---|--------------|------------------------------------|-----------|
| Information Element | Value/remark | Comment | Condition |
| 5GMM cause | '0001 1010'B | Non-5G authentication unacceptable | |

Table 9.1.1.4.3.3-6: AUTHENTICATION REQUEST (step 47, Table 9.1.1.4.3.2-1)

| Derivation path: TS 38.508, Table 4.7.1-1 | | | |
|---|--|--|-----------|
| Information Element | Value/remark | Comment | Condition |
| Authentication parameter AUTN | AMF field set to "AMF _{FRESYNCH} ",
AMF _{FRESYNCH} = '1111 1111 1111 1111'B | AMF _{FRESYNCH} see TS 34.108, 8.1.2.2 | |

Table 9.1.1.4.3.3-7: AUTHENTICATION FAILURE (step 48, Table 9.1.1.4.3.2-1)

| Derivation path: TS 38.508, Table 4.7.1-4 | | | |
|---|--------------|-----------------------------|-----------|
| Information Element | Value/remark | Comment | Condition |
| 5GMM cause | '0001 0101'B | Synch failure | |
| Authentication failure parameter | AUTS | AUTS see TS 34.108, 8.1.2.2 | |

9.1.1.5 5G AKA based primary authentication and key agreement / Reject

9.1.1.5 Test Purpose (TP)

(1)

```
with { the UE in 5GMM-REGISTERED-INITIATED state and SS initiates a 5G AKA based primary authentication and key agreement procedure }
ensure that {
  when { the SS sends an a AUTHENTICATION REJECT message }
  then { the UE deletes the stored 5G-GUTI, last visited registered TAI and ngKSI and enter state 5GMM-DEREGISTERED, the USIM is considered invalid until switching off the UE. }
}
```

9.1.1.5.2 Conformance requirements

References: The conformance requirements covered in the current TC are specified in: TS 24.501 clauses 5.4.1.3.5. Unless otherwise stated these are Rel-15 requirements.

[TS 24.501, clause 5.4.1.3.5]

If the authentication response (RES) returned by the UE is not valid, the network response depends upon the type of identity used by the UE in the initial NAS message, that is:

- if the 5G-GUTI was used; or
- if the SUCI was used.

If the 5G-GUTI was used, the network should initiate an identification procedure to retrieve SUCI from the UE and restart the 5G AKA based primary authentication and key agreement procedure with the received SUCI.

If the SUCI was used for identification in the initial NAS message or in a restarted 5G AKA based primary authentication and key agreement procedure, or the network decides not to initiate the identification procedure to retrieve SUCI from the UE after an unsuccessful 5G AKA based primary authentication and key agreement procedure, the network should send an AUTHENTICATION REJECT message to the UE.

Upon receipt of an AUTHENTICATION REJECT message,

- 1) if the message has been successfully integrity checked by the NAS, the UE shall set the update status to 5U3 ROAMING NOT ALLOWED, delete the stored 5G-GUTI, TAI list, last visited registered TAI and ngKSI.

In case of PLMN, the USIM shall be considered invalid until switching off the UE or the UICC containing the USIM is removed. In case of SNPN, the entry of the "list of subscriber data" with the SNPN identity of the current SNPN shall be considered invalid until the UE is switched off or the entry is updated.

- The UE shall set:

- i) the counter for "SIM/USIM considered invalid for GPRS services" events and the counter for "SIM/USIM considered invalid for 5GS services over non-3GPP access" events in case of PLMN; or
- ii) the counter for "the entry for the current SNPN considered invalid for 3GPP access" events in case of SNPN;

to UE implementation-specific maximum value. If the UE maintains a counter for "SIM/USIM considered invalid for non-GPRS services", then the UE shall set this counter to UE implementation-specific maximum value; and

- if the UE is operating in single-registration mode, the UE shall handle 4G-GUTI, TAI list and eKSI as specified in 3GPP TS 24.301 [15] for the case when the authentication procedure is not accepted by the network. The USIM shall be considered as invalid also for non-EPS services until switching off or the UICC containing the USIM is removed.

- 2) if the message is received without integrity protection, the UE shall start timer T3247 with a random value uniformly drawn from the range between 30 minutes and 60 minutes, if the timer is not running (see subclause 5.3.20). Additionally, the UE shall:

- a) if the message is received over 3GPP access, and the counter for "SIM/USIM considered invalid for GPRS services" events or the counter for "the entry for the current SNPN considered invalid for 3GPP access" events has a value less than a UE implementation-specific maximum value, proceed as specified in subclause 5.3.20, list item 1)-a) of clause 5.3.20.2 (if the UE is not SNPN enabled or is not operating in SNPN access mode) or list item a) of clause 5.30.20.3 (if the UE is operating in SNPN access mode) for the case that the 5GMM cause value received is #3;
- b) if the message is received over non-3GPP access, and the counter for "SIM/USIM considered invalid for 5GS services over non-3GPP access" events has a value less than a UE implementation-specific maximum value, proceed as specified in subclause 5.3.20, list item 1)-b) of clause 5.3.20.2 for the case that the 5GMM cause value received is #3.

c) otherwise

- i) if the 5GMM cause value is received over 3GPP access, the UE shall:

- set the update status for 3GPP access to 5U3 ROAMING NOT ALLOWED, delete for 3GPP access only the stored 5G-GUTI, TAI list, last visited registered TAI and ngKSI. The USIM shall be considered invalid for 5GS services via 3GPP access and non-EPS service until switching off the UE or the UICC containing the USIM is removed or the entry of the "list of subscriber data" with the SNPN identity of the current SNPN shall be considered invalid for 3GPP access until the UE is switched off or the entry is updated.

- The UE shall set the counter for "SIM/USIM considered invalid for GPRS services" events or the counter for "the entry for the current SNPN considered invalid for 3GPP access" events to UE implementation-specific maximum value. If the UE maintains a counter for "SIM/USIM considered invalid for non-GPRS services", then the UE shall set this counter to UE implementation-specific maximum value.

- If the UE is operating in single-registration mode, the UE shall handle 4G-GUTI, TAI list and eKSI as specified in 3GPP TS 24.301 [15] for the case when the authentication procedure is not accepted by the network. The USIM shall be considered as invalid also for non-EPS services until switching off or the UICC containing the USIM is removed; and

- ii) if the 5GMM cause value is received over non-3GPP access, the UE shall:

- set the update status for non-3GPP access to 5U3 ROAMING NOT ALLOWED, delete for non-3GPP access only the stored 5G-GUTI, TAI list, last visited registered TAI and ngKSI. The USIM shall be considered invalid for 5GS services via non-3GPP access until switching off the UE or the UICC containing the USIM is removed.

The UE shall set the counter for "SIM/USIM considered invalid for 5GS services over non-3GPP access" events to UE implementation-specific maximum value.

If the AUTHENTICATION REJECT message is received by the UE, the UE shall abort any 5GMM signalling procedure, stop any of the timers T3510, T3516, T3517, T3519 or T3521 (if they were running), enter state 5GMM-DEREGISTERED and delete any stored SUCI.

Depending on local requirements or operator preference for emergency services, if the UE initiates a registration procedure with 5GS registration type IE set to "emergency registration" and the AMF is configured to allow emergency registration without user identity, the AMF needs not follow the procedures specified for the authentication failure in the present subclause. The AMF may continue a current 5GMM specific procedure.

9.1.1.5.3 Test description

9.1.1.5.3.1 Pre-test conditions

System Simulator:

- NGC Cell A "Serving cell" TS 38.508-1 [4] Table 6.2.2.1-3

UE:

-None

Preamble:

- The UE is in state Switched OFF (state 0N-B) according to TS 38.508-1 [4].

9.1.1.5.3.2 Test procedure sequence

Table 9.1.1.5.3.2-1: Main behaviour

| St | Procedure | Message Sequence | | TP | Verdict |
|-------------|---|------------------|--------------------------------|----|---------|
| | | U - S | Message | | |
| 1 | The UE is switched on. | - | - | - | - |
| 2-4 | The UE executes steps 2-4 of Table 4.5.2.2-2 in TS38.508-1 [4]. | - | - | - | - |
| 5 | The SS transmits an AUTHENTICATION REQUEST message | | 5GMM: AUTHENTICATION REQUEST | - | - |
| 6 | The UE transmits an AUTHENTICATION RESPONSE | | 5GMM: AUTHENTICATION RESPONSE | - | - |
| 7 | The SS transmits an AUTHENTICATION REJECT message | <- | 5GMM: AUTHENTICATION REJECT | - | - |
| 8 | SS releases the RRC connection | - | - | - | - |
| 9 | Check: Does the UE transmit an RRCSetupRequest message for initial registration procedure within the next 30 seconds? | --> | NR RRC: <i>RRCSetupRequest</i> | 1 | F |
| 10 | The UE is switched off by executing generic procedure in Table 4.9.6.4-1 in TS 38.508-1 [4]. | - | - | - | - |
| 11 | The UE is switched on. | - | - | - | - |
| 12 | Check: Does the UE transmit a REGISTRATION REQUEST message? | --> | 5GMM: REGISTRATION REQUEST | 1 | P |
| 13-28a
1 | The UE executes steps 5-20a1 of Table 4.5.2.2-2 in TS 38.508-1 [4] complete registration procedure. | - | - | - | - |

9.1.1.5.3.3 Specific message contents

Table 9.1.1.5.3.3-1: REGISTRATION REQUEST (step 4, Table 9.1.1.5.3.2-1)

| Derivation path: TS 38.508-1 [4], table 4.7.1-6 | | | |
|---|--------------|----------------------|-----------|
| Information Element | Value/Remark | Comment | Condition |
| 5GS registration type | | | |
| 5GS registration type value | '001'B | initial registration | |

Table 9.1.1.5.3.3-2: REGISTRATION REQUEST (step 12, Table 9.1.1.5.3.2-1)

| Derivation path: TS 38.508-1 [4], table 4.7.1-6 | | | |
|---|----------------|--------------------------|-----------|
| Information Element | Value/Remark | Comment | Condition |
| 5GS registration type | | | |
| 5GS registration type value | '001'B | initial registration | |
| ngKSI | '111' | no key is available | |
| 5GS mobile identity | SUCI of the UE | a freshly generated SUCI | |
| Last visited registered TAI | Not present | | |

9.1.1.6 5G AKA based primary authentication and key agreement / Abnormal

9.1.1.6 Test Purpose (TP)

(1)

```
with { the UE in 5GMM-REGISTERED-INITIATED state }
ensure that {
  when { the SS initiates a 5G AKA based primary authentication and key agreement procedure by
  sending AUTHENTICATION REQUEST with ngKSI is already in use }
  then { the UE sends an AUTHENTICATION FAILURE message to the network, with the 5GMM cause #71
  "ngKSI already in use" }
}
```

(2)

```
with { the UE in 5GMM-REGISTERED-INITIATED state }
ensure that {
  when { the third time SS initiates 5G AKA based primary authentication and key agreement procedure
  by sending AUTHENTICATION REQUEST with ngKSI is already in use }
  then { the UE locally releases the RRC connection and treats the active cell as barred }
}
```

(3)

```
with { the UE in 5GMM-REGISTERED-INITIATED state, the SS sends an AUTHENTICATION REQUEST with ngKSI
is already in use and the UE sends an AUTHENTICATION FAILURE message }
ensure that {
  when { T3520 times out }
  then { the UE locally releases the RRC connection and treats the active cell as barred }
}
```

(4)

Void

(5)

```
with { the UE in 5GMM-REGISTERED state and initiates a mobility registration update procedure }
ensure that {
  when { the SS initiates a 5G AKA based primary authentication and key agreement procedure by
  sending AUTHENTICATION REQUEST and the UE fails on transmission of AUTHENTICATION RESPONSE message
  with the indication from lower layers }
  then { the UE re-initiate the mobility registration update procedure }
}
```

9.1.1.6.2 Conformance requirements

References: The conformance requirements covered in the current TC are specified in: TS 24.501 clauses 5.4.1.3.7. Unless otherwise stated these are Rel-15 requirements.

[TS 24.501, clause 5.4.1.3.7]

- e) Authentication failure (5GMM cause #71 "ngKSI already in use").

The UE shall send an AUTHENTICATION FAILURE message, with 5GMM cause #71 "ngKSI already in use", to the network and start the timer T3520 (see example in figure 5.4.1.3.7.1). Furthermore, the UE shall stop any of the retransmission timers that are running (e.g. T3510, T3517 or T3521). Upon the first receipt of an AUTHENTICATION FAILURE message from the UE with 5GMM cause #71 "ngKSI already in use", the network performs necessary actions to select a new ngKSI and send the same 5G authentication challenge to the UE.

...

- g) Network failing the authentication check.

If the UE deems that the network has failed the authentication check, then it shall request RRC to locally release the RRC connection and treat the active cell as barred (see 3GPP TS 38.304 [28]). The UE shall start any retransmission timers (e.g. T3510, T3517 or T3521), if they were running and stopped when the UE received the first AUTHENTICATION REQUEST message containing an incorrect authentication challenge data causing authentication failure.

- h) Transmission failure of AUTHENTICATION RESPONSE message or AUTHENTICATION FAILURE message indication from lower layers (if the 5G AKA based primary authentication and key agreement procedure is triggered by a registration procedure for mobility and periodic registration update).

The UE shall stop the timer T3520, if running, and re-initiate the registration procedure for mobility and periodic registration update.

...

- i) Transmission failure of AUTHENTICATION RESPONSE message or AUTHENTICATION FAILURE message indication with TAI change from lower layers (if the 5G AKA based primary authentication and key agreement procedure is triggered by a service request procedure).

The UE shall stop the timer T3520, if running.

If the current TAI is not in the TAI list, the 5G AKA based primary authentication and key agreement procedure shall be aborted and a registration procedure for mobility and periodic registration update shall be initiated.

If the current TAI is still part of the TAI list, it is up to the UE implementation how to re-run the ongoing procedure that triggered the 5G AKA based primary authentication and key agreement procedure.

...

For items c, d, e, and f whether or not the UE is registered for emergency services:

...

The UE shall deem that the network has failed the authentication check or assume that the authentication is not genuine and proceed as described in item g above if any of the following occurs:

- the timer T3520 expires;
- the UE detects any combination of the 5G authentication failures: 5GMM causes #20 "MAC failure", #21 "synch failure", #26 "non-5G authentication unacceptable" or #71 "ngKSI already in use", during three consecutive authentication challenges. The 5G authentication challenges shall be considered as consecutive only, if the 5G authentication challenges causing the second and third 5G authentication failure are received by the UE, while the timer T3520 started after the previous 5G authentication failure is running.

9.1.1.6.3 Test description

9.1.1.6.3.1 Pre-test conditions

System Simulator:

- NGC Cell A, NGC Cell B, NGC Cell C and NGC Cell D are configured according to table 6.3.2.2-1 in TS 38.508-1 [4].
- The SS configures the NGC Cell A as the "Serving cell" and other NGC Cells as "Non-suitable "Off" cell".
- System information combination NR-2 as defined in TS 38.508-1 [4] clause 4.4.3.1.2 is used.

UE:

- None.

Preamble:

- The UE is in test state 0N-B on NGC Cell A according to TS 38.508-1 [4]. The ngKSI-1 has been assigned and security context has been established.

9.1.1.6.3.2 Test procedure sequence

Table 9.1.1.6.3.2-1: Main behaviour

| St | Procedure | Message Sequence | | TP | Verdict |
|------|--|------------------|------------------------------|----|---------|
| | | U - S | Message | | |
| - | The following messages are to be observed on NGC Cell A unless explicitly stated otherwise. | - | - | - | - |
| 0 | The UE is switched on. | - | - | - | - |
| 0A | The UE establishes RRC connection by executing steps 2-4 of Table 4.5.2.2-2 in TS 38.508-1 [4] and transmits a REGISTRATION REQUEST message. | --> | 5GMM: REGISTRATION REQUEST | - | - |
| 1 | The SS initiates a 5G AKA based primary authentication and key agreement procedure by sending AUTHENTICATION REQUEST with ngKSI is already in use (ngKSI-1). | <-- | 5GMM: AUTHENTICATION REQUEST | - | - |
| 2 | Check: Does the UE send an AUTHENTICATION FAILURE message to the network, with the 5GMM cause #71 "ngKSI already in use"? | --> | 5GMM: AUTHENTICATION FAILURE | 1 | P |
| 3 | The SS initiates a 5G AKA based primary authentication and key agreement procedure by sending AUTHENTICATION REQUEST with ngKSI is already in use (ngKSI-1). | <-- | 5GMM: AUTHENTICATION REQUEST | - | - |
| 4 | Check: Does the UE send an AUTHENTICATION FAILURE message to the network, with the 5GMM cause #71 "ngKSI already in use"? | --> | 5GMM: AUTHENTICATION FAILURE | 1 | P |
| 5 | Void | - | - | - | - |
| 6 | The SS initiates a 5G AKA based primary authentication and key agreement procedure by sending AUTHENTICATION REQUEST with ngKSI is already in use (ngKSI-1). | <-- | 5GMM: AUTHENTICATION REQUEST | - | - |
| 6a1 | EXCEPTION: The UE may send an AUTHENTICATION FAILURE before locally releasing the RRC Connection. | --> | 5GMM: AUTHENTICATION FAILURE | - | - |
| 6A | Check: Does the UE transmit a RRCSetupRequest on NGC Cell A in the next 30 seconds? (Note 1) | --> | 5G RRC: RRCSetupRequest | 2 | F |
| 6B | The SS configures:
-NGC Cell B as the "Serving cell".
-NGC Cell A as a "Suitable neighbour intra-frequency cell". | - | - | - | - |
| - | The following messages are to be observed on NGC Cell B unless explicitly stated otherwise. | - | - | - | - |
| 7-9 | The UE establishes RRC connection by executing steps 2-4 of Table 4.5.2.2-2 in TS 38.508-1 [4]. | - | - | - | - |
| 10 | Check: Does the UE transmit a REGISTRATION REQUEST message with the 5GS registration type IE setting as initial registration? | --> | 5GMM: REGISTRATION REQUEST | 2 | P |
| 11 | The SS initiates a 5G AKA based primary authentication and key agreement procedure by sending AUTHENTICATION REQUEST with ngKSI is already in use (ngKSI-1). | <-- | 5GMM: AUTHENTICATION REQUEST | - | - |
| 12 | The UE sends an AUTHENTICATION FAILURE message to the network, with the 5GMM cause #71 "ngKSI already in use". | --> | 5GMM: AUTHENTICATION FAILURE | - | - |
| 12 A | SS starts timer of t_Waits=T3520. | - | - | - | - |
| 13 | Void | - | - | - | - |
| 14 | SS waits for the expiration of t_Waits. | - | - | - | - |
| 14 A | Check: Does the UE transmit a RRCSetupRequest on NGC Cell B in the next 30 seconds? (Note 1) | --> | 5G RRC: RRCSetupRequest | 2 | F |

| | | | | | |
|--|--|-----|------------------------------|---|---|
| 14
B | The SS configures:
-NGC Cell C as the "Serving cell".
-NGC Cell B as a "Suitable neighbour intra-frequency cell".
-NGC Cell A as a "Non-suitable "Off" cell" | - | - | - | - |
| - | The following messages are to be observed on NGC Cell C unless explicitly stated otherwise. | - | - | - | - |
| 15-
17 | The UE establishes RRC connection by executing steps 2-4 of Table 4.5.2.2-2 in TS38.508-1 [4]. | - | - | - | - |
| 18 | Check: Does the UE transmit a REGISTRATION REQUEST message with the 5GS registration type IE setting as initial registration? | --> | 5GMM: REGISTRATION REQUEST | 3 | P |
| 19-
34a
1 | Steps 5-20a1 of Table 4.5.2.2-2 of the generic procedure in TS 38.508-1 [4] are performed. | - | - | - | - |
| 35-
39 | Void | | | | |
| 40 | The SS configures:
- NGC Cell D as the "Serving cell".
- NGC Cell C as a "Non-suitable "Off" cell ".
- NGC Cell B as a "Non-suitable "Off" cell ". | - | - | - | - |
| 41-
42 | Void | | | | |
| - | The following messages are to be observed on NGC Cell D unless explicitly stated otherwise. | - | - | - | - |
| 43-
45 | The UE establishes RRC connection by executing steps 2-4 of Table 4.5.2.2-2 in TS 38.508-1 [4]. | - | - | - | - |
| 46 | The UE transmit a REGISTRATION REQUEST message with the 5GS registration type IE setting as Mobility registration updating. | --> | 5GMM: REGISTRATION REQUEST | - | - |
| 47 | The SS cuts off the UL grant and RA Response, so that the UE cannot send the AUTHENTICATION RESPONSE to SS. | - | - | - | - |
| 48 | SS transmits an AUTHENTICATION REQUEST message with ngKSI-2 to initiate the 5G-AKA procedure. | <-- | 5GMM: AUTHENTICATION REQUEST | - | - |
| 49 | SS starts timer of t_Delay =10s. (Note2). | - | - | - | - |
| 50 | SS performs local release. | - | - | - | - |
| 51 | Check whether t_Delay is still running, if it's running, then waiting for timeout. | - | - | - | - |
| 52 | SS configures the RA Response. | - | - | - | - |
| 53 | Check: Does the test result of generic test procedure in TS 38.508-1 [4] subclause 4.9.5 indicate that the UE is camped on NGC Cell D, with 'connected without release'? | - | - | 5 | P |
| <p>Note 1: If the cell is not barred, after the transmission of REGISTRATION REQUEST, the UE will start T3510 and T3511. After 25s (T3510+T3511), the UE shall send REGISTRATION REQUEST.</p> <p>Note 2: To send the AUTHENTICATION RESPONSE, the UE will initiate RACH to get UL grant. Since there is no RA Response, registration failure due to lower layer failure will occur, then T3511 will start. Timer t_Delay is derived from T3511. During timer t_Delay, UE fails on transmission of AUTHENTICATION RESPONSE message with the indication from lower layers.</p> | | | | | |

9.1.1.6.3.3 Specific message contents

Table 9.1.1.6.3.3-1: AUTHENTICATION REQUEST (step 1, step 3, step 6 and step 11, Table 9.1.1.6.3.2-1)

| Derivation path: TS 38.508-1 [4], table 4.7.1-1 | | | |
|---|--------------|--|-----------|
| Information Element | Value/Remark | Comment | Condition |
| ngKSI | ngKSI-1 | The same with the ng-KSI assigned in Preamble. | |

Table 9.1.1.6.3.3-2: AUTHENTICATION FAILURE (step 2, step 4, step 6a1 and step 12, Table 9.1.1.6.3.2-1)

| Derivation path: TS 38.508-1 [4], table 4.7.1-4 | | | |
|---|--------------|----------------------|-----------|
| Information Element | Value/Remark | Comment | Condition |
| 5GMM cause | '0100 0111'B | ngKSI already in use | |

Table 9.1.1.6.3.3-3: AUTHENTICATION REQUEST (step 48, Table 9.1.1.6.3.2-1)

| Derivation path: TS 38.508-1 [4], table 4.7.1-1 | | | |
|---|--------------|---|-----------|
| Information Element | Value/Remark | Comment | Condition |
| ngKSI | ngKSI-2 | Different from the ng-KSI assigned in step 19 | |

Table 9.1.1.6.3.3-4: REGISTRATION REQUEST (step 10 and step 18, Table 9.1.1.6.3.2-1)

| Derivation path: TS 38.508-1 [4], table 4.7.1-6 | | | |
|---|--------------|----------------------|-----------|
| Information Element | Value/Remark | Comment | Condition |
| 5GS registration type | | | |
| 5GS registration type value | '001'B | initial registration | |

Table 9.1.1.6.3.3-5: REGISTRATION REQUEST (step 46, Table 9.1.1.6.3.2-1)

| Derivation path: TS 38.508-1 [4], table 4.7.1-6 | | | |
|---|--------------|--------------------------------|-----------|
| Information Element | Value/Remark | Comment | Condition |
| 5GS registration type | | | |
| 5GS registration type value | '010'B | mobility registration updating | |

9.1.2 Security mode control

9.1.2.1 NAS security mode command

9.1.2.1.1 Test Purpose (TP)

(1)

```

with { the UE is in 5GMM-REGISTERED-INITIATED state and the SS initiates the NAS security mode
control procedure by sending a SECURITY MODE COMMAND message during initial registration procedure }
ensure that {
  when { the UE receives an integrity protected SECURITY MODE COMMAND message including not matching
replayed security capabilities }
  then { the UE send a SECURITY MODE REJECT message and does not start applying the NAS security
in both UL and DL }
}

```

(2)

```

with { the UE is in 5GMM-REGISTERED-INITIATED state and the SS initiates the NAS security mode
control procedure by sending a SECURITY MODE COMMAND message during initial registration procedure }
ensure that {
  when { the UE receives an integrity protected SECURITY MODE COMMAND message including IMEISV
request }
  then { the UE send an integrity protected and ciphered SECURITY MODE COMPLETE message including
IMEISV and starts applying the NAS Security in both UL and DL }
}

```

9.1.2.1.2 Conformance requirements

References: The conformance requirements covered in the present test case are specified in: TS 24.501, clauses 5.4.2.1, 5.4.2.3 and 5.4.2.5. Unless otherwise stated these are Rel-15 requirements.

[TS 24.501, clause 5.4.2.1]

The purpose of the NAS security mode control procedure is to take a 5G NAS security context into use, and initialise and start NAS signalling security between the UE and the AMF with the corresponding 5G NAS keys and 5G NAS security algorithms.

Furthermore, the network may also initiate the security mode control procedure in the following cases:

- a) in order to change the 5G NAS security algorithms for a current 5G NAS security context already in use;
- b) in order to change the value of uplink NAS COUNT used in the latest SECURITY MODE COMPLETE message as described in 3GPP TS 33.501 [24], subclause 6.9.4.4.
- c) in order to provide the Selected EPS NAS security algorithms to the UE.

For restrictions concerning the concurrent running of a security mode control procedure with other security related procedures in the AS or inside the core network see 3GPP TS 33.501 [24], subclause 6.9.5.

[TS 24.501, clause 5.4.2.3]

Upon receipt of the SECURITY MODE COMMAND message, the UE shall check whether the security mode command can be accepted or not. This is done by performing the integrity check of the message, and by checking that the received Replayed UE security capabilities IE has not been altered compared to the latest values that the UE sent to the network.

When the SECURITY MODE COMMAND message includes an EAP-success message the UE handles the EAP-success message and the ABBA as described in subclause 5.4.1.2.2.8 and 5.4.1.2.3.1.

If:

- a) the UE is registered for emergency services, performing initial registration for emergency services or establishing an emergency PDU session; or
- b) the W-AGF acts on behalf of the FN-RG;

and the SECURITY MODE COMMAND message is received with ngKSI value "000" and 5G-IA0 and 5G-EA0 as selected 5G NAS security algorithms, the UE shall locally derive and take in use 5G NAS security context. The UE shall delete existing current 5G NAS security context.

The UE shall accept a SECURITY MODE COMMAND message indicating the "null integrity protection algorithm" 5G-IA0 as the selected 5G NAS integrity algorithm only if the message is received when the UE is registered for emergency services, performing initial registration for emergency services or establishing an emergency PDU session or when the W-AGF acts on behalf of the FN-RG.

If the type of security context flag included in the SECURITY MODE COMMAND message is set to "native security context" and if the ngKSI matches a valid non-current native 5G NAS security context held in the UE while the UE has a mapped 5G NAS security context as the current 5G NAS security context, the UE shall take the non-current native 5G NAS security context into use which then becomes the current native 5G NAS security context and delete the mapped 5G NAS security context.

The UE shall ignore the Replayed S1 UE security capabilities IE if this IE is included in the SECURITY MODE COMMAND message.

If the SECURITY MODE COMMAND message can be accepted, the UE shall take the 5G NAS security context indicated in the message into use. The UE shall in addition reset the uplink NAS COUNT counter if:

- a) the SECURITY MODE COMMAND message is received in order to take a 5G NAS security context into use created after a successful execution of the 5G AKA based primary authentication and key agreement procedure or the EAP based primary authentication and key agreement procedure; or
- b) the SECURITY MODE COMMAND message received includes the type of security context flag set to "mapped security context" in the NAS key set identifier IE the ngKSI does not match the current 5G NAS security context, if it is a mapped 5G NAS security context.

If the SECURITY MODE COMMAND message can be accepted and a new 5G NAS security context is taken into use and SECURITY MODE COMMAND message does not indicate the "null integrity protection algorithm" 5G-IA0 as the selected NAS integrity algorithm, the UE shall:

- if the SECURITY MODE COMMAND message has been successfully integrity checked using an estimated downlink NAS COUNT equal to 0, then the UE shall set the downlink NAS COUNT of this new 5G NAS security context to 0;
- otherwise the UE shall set the downlink NAS COUNT of this new 5G NAS security context to the downlink NAS COUNT that has been used for the successful integrity checking of the SECURITY MODE COMMAND message.

If the SECURITY MODE COMMAND message includes the horizontal derivation parameter indicating "K_{AMF} derivation is required", the UE shall derive a new K'_{AMF}, as specified in 3GPP TS 33.501 [24] for K_{AMF} to K'_{AMF} derivation in mobility, and set both uplink and downlink NAS COUNTs to zero. When the new 5G NAS security context is taken into use for current access and the UE is registered with the same PLMN over the 3GPP access and the non-3GPP access:

- a) the UE is in 5GMM-IDLE mode over the non-current access, the AMF and the UE shall activate the new 5G NAS security context over the non-current access as described in 3GPP TS 33.501 [24]. The AMF and the UE shall set the downlink NAS COUNT and uplink NAS COUNT to zero for the non-current access; or
- b) the UE is in 5GMM-CONNECTED mode over the non-current access, the AMF shall send the SECURITY MODE COMMAND message over the non-current access to activate the new 5G NAS security context that was activated over the current access as described in 3GPP TS 33.501 [24]. The AMF shall include the same ngKSI in the SECURITY MODE COMMAND message to identify the new 5G NAS security context.

If the SECURITY MODE COMMAND message includes the horizontal derivation parameter indicating "K_{AMF} derivation is not required" or the Additional 5G security parameters IE is not included in the message, the UE is registered with the same PLMN over the 3GPP access and non-3GPP access, then after the completion of a security mode control procedure over the current access:

- a) the UE is in 5GMM-IDLE mode over the non-current access, the AMF and the UE shall activate the new 5G NAS security context for the non-current access. If a primary authentication and key agreement procedure was completed before the security mode control procedure, the AMF and the UE shall set the downlink NAS COUNT and uplink NAS COUNT to zero for the non-current access, otherwise the downlink NAS COUNT and uplink NAS COUNT for the non-3GPP access are not changed; or
- b) the UE is in 5GMM-CONNECTED mode over the non-current access, the AMF shall send the SECURITY MODE COMMAND message over the non-current access to activate the new 5G NAS security context that was activated over the current access as described in 3GPP TS 33.501 [24]. The AMF shall include the same ngKSI in the SECURITY MODE COMMAND message to identify the new 5G NAS security context.

If the SECURITY MODE COMMAND message can be accepted, the UE shall send a SECURITY MODE COMPLETE message integrity protected with the selected 5GS integrity algorithm and the 5G NAS integrity key based on the K_{AMF} or mapped K'_{AMF} if the type of security context flag is set to "mapped security context" indicated by the ngKSI. When the SECURITY MODE COMMAND message includes the type of security context flag set to "mapped security context" in the NAS key set identifier IE, then the UE shall check whether the SECURITY MODE COMMAND message indicates the ngKSI of the current 5GS security context, if it is a mapped 5G NAS security context, in order not to re-generate the K'_{AMF}.

Furthermore, if the SECURITY MODE COMMAND message can be accepted, the UE shall cipher the SECURITY MODE COMPLETE message with the selected 5GS ciphering algorithm and the 5GS NAS ciphering key based on the K_{AMF} or mapped K'_{AMF} indicated by the ngKSI. The UE shall set the security header type of the message to "integrity protected and ciphered with new 5G NAS security context".

From this time onward the UE shall cipher and integrity protect all NAS signalling messages with the selected 5GS integrity and ciphering algorithms.

If the AMF indicated in the SECURITY MODE COMMAND message that the IMEISV is requested:

- 1) if the UE has an IMEISV, the UE shall include its IMEISV in the SECURITY MODE COMPLETE message; or
- 2) if the 5G-CRG or the W-AGF acting on behalf of the FN-CRG do not have an IMEISV, the 5G-CRG or the W-AGF acting on behalf of the FN-CRG shall include the 5G-CRG's cable modem MAC address or the FN-CRG's cable modem MAC address in the SECURITY MODE COMPLETE message.

If, during an ongoing registration procedure or service request procedure, the SECURITY MODE COMMAND message includes the Additional 5G security information IE with the RINMR bit set to "Retransmission of the initial NAS message requested", the UE shall include the entire unciphered REGISTRATION REQUEST message or SERVICE REQUEST message, which the UE had previously included in the NAS message container IE of the initial NAS message (i.e. REGISTRATION REQUEST message or SERVICE REQUEST message, respectively), in the NAS message container IE of the SECURITY MODE COMPLETE message.

If, prior to receiving the SECURITY MODE COMMAND message, the UE without a valid 5G NAS security context had sent a REGISTRATION REQUEST message the UE shall include the entire REGISTRATION REQUEST message in the NAS message container IE of the SECURITY MODE COMPLETE message as described in subclause 4.4.6.

If the UE operating in the single-registration mode receives the Selected EPS NAS security algorithms IE, the UE shall use the IE according to 3GPP TS 33.501 [24].

For a UE operating in single-registration mode with N26 interface supported in the network, after an inter-system change from S1 mode to N1 mode in 5GMM-CONNECTED mode, the UE shall set the value of the Selected EPS NAS security algorithms IE in the 5G NAS security context to the NAS security algorithms that were received from the source MME when the UE was in S1 mode.

[TS 24.501, clause 5.4.2.5]

If the security mode command cannot be accepted, the UE shall send a SECURITY MODE REJECT message. The SECURITY MODE REJECT message contains a 5GMM cause that typically indicates one of the following cause values:

- #23 UE security capabilities mismatch.
- #24 security mode rejected, unspecified.

If the UE detects that the received Replayed UE security capabilities IE has been altered compared to the latest values that the UE sent to the network, the UE shall set the cause value to #23 "UE security capabilities mismatch".

Upon receipt of the SECURITY MODE REJECT message, the AMF shall stop timer T3560. The AMF shall also abort the ongoing procedure that triggered the initiation of the NAS security mode control procedure.

Both the UE and the AMF shall apply the 5G NAS security context in use before the initiation of the security mode control procedure, if any, to protect the SECURITY MODE REJECT message and any other subsequent messages according to the rules in subclause 4.4.4 and 4.4.5.

9.1.2.1.3 Test description

9.1.2.1.3.1 Pre-test conditions

System Simulator:

- NGC Cell A.

UE:

- None.

Preamble:

- The procedure defined in subclause 4.9.8 in 38.508-1 [4] has been performed to ensure that the UE does not have a valid 5G NAS security context
- The UE is in state 0-A on NGC Cell A according to TS 38.508-1 [4].

9.1.2.1.3.2 Test procedure sequence

Table 9.1.2.1.3.2-1: Main behaviour

| St | Procedure | Message Sequence | | TP | Verdict |
|----------|---|------------------|------------------------|----|---------|
| | | U - S | Message | | |
| 1 | The UE is switched on. | - | - | - | - |
| 2-2E | Steps 1-6 of the generic procedure for UE registration specified in TS 38.508-1 [4] table 4.5.2.2-2 are performed. | - | - | - | - |
| 3 | The SS transmits a SECURITY MODE COMMAND message to activate NAS security. It is integrity protected and includes unmatched replayed security capabilities. | <- | SECURITY MODE COMMAND | - | - |
| 4 | Check: Does the UE transmit a SECURITY MODE REJECT message with cause'#23: UE security capabilities mismatch'? | --> | SECURITY MODE REJECT | 1 | P |
| 5 | The SS transmits an IDENTITY REQUEST message (Security not applied). | <- | IDENTITY REQUEST | - | - |
| 6 | Check: Does the UE transmit a non security protected IDENTITY RESPONSE message? | --> | IDENTITY RESPONSE | 1 | P |
| 7 | The SS transmits a SECURITY MODE COMMAND message to activate NAS security. It is integrity protected and includes IMEISV. | <- | SECURITY MODE COMMAND | - | - |
| 8 | Check: Does the UE transmit a SECURITY MODE COMPLETE message and does it establish the initial security configuration? | --> | SECURITY MODE COMPLETE | 2 | P |
| 9a1-9Ja1 | Steps 9a1-19a1 of the generic procedure for UE registration specified in TS 38.508-1 [4] table 4.5.2.2-2 are performed. | - | - | - | - |
| 10 | The SS transmits an IDENTITY REQUEST message (Security protected as per the algorithms specified in step 7). | <- | IDENTITY REQUEST | - | - |
| 11 | Check: Does the UE transmit an IDENTITY RESPONSE message (Security Protected as per the algorithms specified in step 7)? | --> | IDENTITY RESPONSE | 2 | P |

9.1.2.1.3.3 Specific message contents

Table 9.1.2.1.3.3-1: SECURITY MODE COMMAND (Step 3, Table 9.1.2.1.3.2-1)

| Derivation path: TS 38.508-1 [4], table 4.7.1-25 | | | |
|--|--|---------|-----------|
| Information Element | Value/Remark | Comment | Condition |
| Replayed UE security capabilities | Set to mismatch the security capability of UE under test | | |

Table 9.1.2.1.3.3-2: SECURITY MODE REJECT (Step 4, Table 9.1.2.1.3.2-1)

| Derivation path: TS 38.508-1 [4], table 4.7.1-27 | | | |
|--|--------------|---------|-----------|
| Information Element | Value/Remark | Comment | Condition |
| 5GMM cause | #23 | | |

Table 9.1.2.1.3.3-3: IDENTITY REQUEST (Step 5, Table 9.1.2.1.3.2-1)

| Derivation path: TS 38.508-1 [4], table 4.7.1-21 | | | |
|--|--------------|---------|-----------|
| Information Element | Value/Remark | Comment | Condition |
| Identity type | '0001'B | SUCI | |

Table 9.1.2.1.3.3-4: IDENTITY RESPONSE (Step 6, Table 9.1.2.1.3.2-1)

| Derivation path: TS 38.508-1 [4], table 4.7.1-22 | | | |
|--|--------------|---------|-----------|
| Information Element | Value/Remark | Comment | Condition |
| Mobile identity | | | |
| Type of identity | '001'B | SUCI | |

Table 9.1.2.1.3.3-5: SECURITY MODE COMMAND (Step 7, Table 9.1.2.1.3.2-1)

| Derivation path: TS 38.508-1 [4], table 4.7.1-25 | | | |
|--|--|------------------------------|-----------|
| Information Element | Value/Remark | Comment | Condition |
| Selected NAS security algorithms | | | |
| Type of ciphering algorithm | Set according to PIXIT parameter for default ciphering algorithm if it is set to a value different to 5G-EA0, or, set to any value different to 5G-EA0 otherwise | Non-zero ciphering algorithm | |
| IMEISV request | Present | | |

Table 9.1.2.1.3.3-6: SECURITY MODE COMPLETE (Step 8, Table 9.1.2.1.3.2-1)

| Derivation path: TS 38.508-1 [4], table 4.7.1-26 | | | |
|--|--------------|---------|-----------|
| Information Element | Value/Remark | Comment | Condition |
| IMEISV | Present | | |

Table 9.1.2.1.3.3-7: IDENTITY REQUEST (Step 10, Table 9.1.2.1.3.2-1)

| Derivation path: TS 38.508-1 [4], table 4.7.1-21 | | | |
|--|--------------|---------|-----------|
| Information Element | Value/Remark | Comment | Condition |
| Identity type | '0011'B | IMEI | |

Table 9.1.2.1.3.3-8: IDENTITY RESPONSE (Step 11, Table 9.1.2.1.3.2-1)

| Derivation path: TS 38.508-1 [4], table 4.7.1-22 | | | |
|--|--------------|---------|-----------|
| Information Element | Value/Remark | Comment | Condition |
| Mobile identity | | | |
| Type of identity | '011'B | IMEI | |

9.1.2.2 Protection of initial NAS signalling messages

9.1.2.2.1 Test Purpose (TP)

(1)

```
with { the UE is switched-off with no valid 5G NAS security context }
ensure that {
  when { the UE is switched on }
  then {the UE sends a REGISTRATION REQUEST message including cleartext IEs only }
}
```

(2)

```
with { the UE is in 5GMM-REGISTERED-INITIATED state }
ensure that {
  when { the UE is activating a 5G NAS security context resulting from a security mode control
  procedure }
  then {the UE sends SECURITY MODE COMPLETE message with the entire REGISTRATION REQUEST message }
}
```

9.1.2.2.2 Conformance requirements

References: The conformance requirements covered in the present test case are specified in: TS 24.501, clauses 4.4.6 and 5.5.1. Unless otherwise stated these are Rel-15 requirements.

[TS 24.501, clause 4.4.6]

The 5GS supports protection of initial NAS messages as specified in 3GPP TS 33.501 [24]. The protection of initial NAS messages applies to the REGISTRATION REQUEST and SERVICE REQUEST message, and is achieved as follows:

- a) If the UE does not have a valid 5G NAS security context, the UE sends a REGISTRATION REQUEST message including cleartext IEs only. After activating a 5G NAS security context resulting from a security mode control procedure:
 - 1) if the UE needs to send non-cleartext IEs, the UE shall include the entire REGISTRATION REQUEST message (i.e. containing both cleartext IEs and non-cleartext IEs) in the NAS message container IE and shall include the NAS message container IE in the SECURITY MODE COMPLETE message;
 - 2) if the UE does not need to send non-cleartext IEs, the UE shall include the entire REGISTRATION REQUEST message (i.e. containing cleartext IEs only) in the NAS message container IE and shall include the NAS message container IE in the SECURITY MODE COMPLETE message.
- b) If the UE has a valid 5G NAS security context and the UE needs to send non-cleartext IEs in a REGISTRATION REQUEST or SERVICE REQUEST message, the UE includes the entire REGISTRATION REQUEST or SERVICE REQUEST message (i.e. containing both cleartext IEs and non-cleartext IEs) in the NAS message container IE and shall cipher the value part of the NAS message container IE. The UE shall then send a REGISTRATION REQUEST or SERVICE REQUEST message containing the cleartext IEs and the NAS message container IE.

When the initial NAS message is a REGISTRATION REQUEST message, the cleartext IEs are:

- Extended protocol discriminator;
- Security header type;
- Spare half octet;
- Registration request message identity;
- 5GS registration type;
- ngKSI;
- 5GS mobile identity;

- UE security capability;
- Additional GUTI;
- UE status; and
- EPS NAS message container.

...

When the UE sends a REGISTRATION REQUEST or SERVICE REQUEST message that includes a NAS message container IE, the UE shall set the security header type of the initial NAS message to "integrity protected".

If the UE does not need to send non-plaintext IEs in the initial NAS message, the UE shall send the initial NAS message i.e. REGISTRATION REQUEST or SERVICE REQUEST message with plaintext IEs only i.e. without including the NAS message container IE in the initial NAS message.

[TS 24.501, clause 5.5.1]

...

If the UE does not have a valid 5G NAS security context, the UE shall send the REGISTRATION REQUEST message without including the NAS message container IE. The UE shall include the entire REGISTRATION REQUEST message (i.e. containing plaintext IEs and non-plaintext IEs) in the NAS message container IE that is sent as part of the SECURITY MODE COMPLETE message as described in subclauses 4.4.6 and 5.2.4.

9.1.2.2.3 Test description

9.1.2.2.3.1 Pre-test conditions

System Simulator:

- NGC Cell A.

UE:

- None.

Preamble:

- The UE is in state 0-A on NGC Cell A according to TS 38.508-1 [4].
- The procedure defined in subclause 4.9.8 in TS 38.508-1 [4] has been performed to ensure that the UE does not have a valid 5G NAS security context.

9.1.2.2.3.2 Test procedure sequence

Table 9.1.2.2.3.2-1: Main behaviour

| St | Procedure | Message Sequence | | TP | Verdict |
|-------|--|------------------|-------------------------|----|---------|
| | | U - S | Message | | |
| 1 | The UE is switched on. | - | - | - | - |
| 2-4 | Steps 1-3 of the generic procedure for UE registration specified in TS 38.508-1 [4] table 4.5.2.2-2 are performed. | - | - | - | - |
| 5 | Check: Does the UE transmit an <i>RRCSetsUpComplete</i> message and a REGISTRATION REQUEST message? | --> | REGISTRATION REQUEST | 1 | P |
| 6 | The SS transmits a <i>DLInformationTransfer</i> message and an AUTHENTICATION REQUEST message. | <-- | AUTHENTICATION REQUEST | | |
| 7 | The UE transmits an <i>ULInformationTransfer</i> message and an AUTHENTICATION RESPONSE message. | --> | AUTHENTICATION RESPONSE | | |
| 8 | The SS transmits a <i>DLInformationTransfer</i> message and a SECURITY MODE COMMAND message. | <-- | SECURITY MODE COMMAND | | |
| 9 | Check: Does the UE transmit an <i>ULInformationTransfer</i> message and a SECURITY MODE COMPLETE message? | --> | SECURITY MODE COMPLETE | 2 | P |
| 10-20 | Steps 10-20a1 of the generic procedure for UE registration specified in TS 38.508-1 [4] table 4.5.2.2-2 are performed. | - | - | - | - |

9.1.2.2.3.3 Specific message contents

Table 9.1.2.2.3.3-1: REGISTRATION REQUEST (Step 5, Table 9.1.2.2.3.2-1)

| |
|--|
| Derivation path: TS 38.508-1 [4], table 4.7.1-6 using condition NON_CLEARTEXT_IE = FALSE |
|--|

Table 9.1.2.2.3.3-2: REGISTRATION REQUEST (Step 9, Table 9.1.2.2.3.2-1)

| |
|--|
| Derivation path: TS 38.508-1 [4], table 4.7.1-6 using condition CIPHERED_MESSAGE |
|--|

Table 9.1.2.2.3.3-3: SECURITY MODE COMPLETE (Step 9, Table 9.1.2.2.3.2-1)

| Derivation path: TS 38.508-1 [4], table 4.7.1-26 | | | |
|--|---------------------------------|--|-----------|
| Information Element | Value/Remark | Comment | Condition |
| NAS message container | Contents of Table 9.1.2.2.3.3-2 | The entire REGISTRATION REQUEST message. | |

9.1.2.3 Integrity protection / Correct functionality of 5G NAS integrity algorithm / SNOW3G

9.1.2.3.1 Test Purpose (TP)

(1)

```

with { successful completion of 5G authentication and key agreement (AKA) procedure }
ensure that {
  when { UE receives a an integrity protected SECURITY MODE COMMAND message instructing to start
integrity protection using algorithm SNOW3G }

```

```

    then { UE transmits an integrity protected SECURITY MODE COMPLETE using SNOW3G and starts
    applying the NAS Integrity protection in both UL and DL }
  }

```

(2)

```

with { Integrity protection successful started by executing Security Mode Procedure }
ensure that {
  when { UE receives an IDENTITY REQUEST message (requested identification parameter is not SUCI),
  without integrity protected }
  then { UE does not transmit IDENTITY Response }
}

```

9.1.2.3.2 Conformance requirements

References: The conformance requirements covered in the current TC are specified in: TS 24.501 clause 4.4.4.1, 4.4.4.2, 5.4.2.1, 5.4.2.2 and 5.4.2.3. Unless otherwise stated these are Rel-15 requirements.

[TS 24.501, clause 4.4.4.1]

For the UE, integrity protected signalling is mandatory for the 5GMM NAS messages once a valid 5G NAS security context exists and has been taken into use. For the network, integrity protected signalling is mandatory for the 5GMM NAS messages once a secure exchange of 5GS NAS messages has been established for the NAS signalling connection. Integrity protection of all NAS signalling messages is the responsibility of the NAS. It is the network which activates integrity protection.

[TS 24.501, clause 4.4.4.2]

Once the secure exchange of NAS messages has been established, the receiving 5GMM entity in the UE shall not process any NAS signalling messages unless they have been successfully integrity checked by the NAS. If NAS signalling messages, having not successfully passed the integrity check, are received, then the NAS in the UE shall discard that message. The processing of the SECURITY MODE COMMAND message that has not successfully passed the integrity check is specified in subclause 5.4.2.5. If any NAS signalling message is received as not integrity protected even though the secure exchange of NAS messages has been established by the network, then the NAS shall discard this message.

[TS 24.501, clause 5.4.2.1]

The purpose of the NAS security mode control procedure is to take a 5G NAS security context into use, and initialise and start NAS signalling security between the UE and the AMF with the corresponding 5G NAS keys and 5G NAS security algorithms.

[TS 24.501, clause 5.4.2.2]

The AMF initiates the NAS security mode control procedure by sending a SECURITY MODE COMMAND message to the UE and starting timer T3560 (see example in figure 5.4.2.2).

The AMF shall reset the downlink NAS COUNT counter and use it to integrity protect the initial SECURITY MODE COMMAND message if the security mode control procedure is initiated:

- a) to take into use the security context created after a successful execution of the 5G AKA based primary authentication and key agreement procedure or the EAP based primary authentication and key agreement procedure;
- or

...

The AMF shall send the SECURITY MODE COMMAND message uncyphered, but shall integrity protect the message with the 5G NAS integrity key based on K_{AMF} or mapped K'_{AMF} indicated by the ngKSI included in the message. The AMF shall set the security header type of the message to "integrity protected with new 5G NAS security context".

...

The AMF shall include the replayed security capabilities of the UE (including the security capabilities with regard to NAS, RRC and UP (user plane) ciphering as well as NAS and RRC integrity, and other possible target network security capabilities, i.e. E-UTRAN if the UE included them in the message to network), the selected 5GS ciphering and integrity algorithms and the ngKSI.

[TS 24.501, clause 5.4.2.3]

Upon receipt of the SECURITY MODE COMMAND message, the UE shall check whether the security mode command can be accepted or not. This is done by performing the integrity check of the message, and by checking that the received Replayed UE security capabilities IE has not been altered compared to the latest values that the UE sent to the network.

...

If the type of security context flag included in the SECURITY MODE COMMAND message is set to "native security context" and if the ngKSI matches a valid non-current native 5G NAS security context held in the UE while the UE has a mapped 5G NAS security context as the current 5G NAS security context, the UE shall take the non-current native 5G NAS security context into use which then becomes the current native 5G NAS security context and delete the mapped 5G NAS security context.

...

If the SECURITY MODE COMMAND message can be accepted, the UE shall take the 5G NAS security context indicated in the message into use. The UE shall in addition reset the uplink NAS COUNT counter if:

- a) the SECURITY MODE COMMAND message is received in order to take a 5G NAS security context into use created after a successful execution of the 5G AKA based primary authentication and key agreement procedure or the EAP based primary authentication and key agreement procedure; or
- b) the SECURITY MODE COMMAND message received includes the type of security context flag set to "mapped security context" in the NAS key set identifier IE the ngKSI does not match the current 5G NAS security context, if it is a mapped 5G NAS security context.

...

If the SECURITY MODE COMMAND message can be accepted, the UE shall send a SECURITY MODE COMPLETE message integrity protected with the selected 5GS integrity algorithm and the 5G NAS integrity key based on the K_{AMF} or mapped K'_{AMF} if the type of security context flag is set to "mapped security context" indicated by the ngKSI. When the SECURITY MODE COMMAND message includes the type of security context flag set to "mapped security context" in the NAS key set identifier IE, then the UE shall check whether the SECURITY MODE COMMAND message indicates the ngKSI of the current 5GS security context, if it is a mapped 5G NAS security context, in order not to re-generate the K'_{AMF} .

...

From this time onward the UE shall cipher and integrity protect all NAS signalling messages with the selected 5GS integrity and ciphering algorithms.

9.1.2.3.3 Test description

9.1.2.3.3.1 Pre-test conditions

System Simulator:

- NGC Cell A.

UE:

- None.

Preamble:

- The UE is in state Switched OFF (state 0N-B) according to TS 38.508-1 [4].

9.1.2.3.3.2 Test procedure sequence

Table 9.1.2.3.3.2-1: Main behaviour

| St | Procedure | Message Sequence | | TP | Verdict |
|-------|--|------------------|------------------------|----|---------|
| | | U - S | Message | | |
| 1 | The UE is switched on. | - | - | - | - |
| 2-6 | Steps 2-6 of the generic procedure for UE registration specified in TS 38.508-1 [4] table 4.5.2.2-2 are performed. | - | - | - | - |
| 7 | The SS transmits a SECURITY MODE COMMAND message to activate NAS security. It is integrity protected. | <-- | SECURITY MODE COMMAND | - | - |
| 8 | Check: Does the UE transmit a SECURITY MODE COMPLETE message and starts applying the NAS Integrity protection in both UL and DL? | --> | SECURITY MODE COMPLETE | 1 | P |
| 9-18a | Steps 10-19a1 of the generic procedure for UE registration specified in TS 38.508-1 [4] table 4.5.2.2-2 are performed. | - | - | - | - |
| 19 | The SS transmits an IDENTITY REQUEST message with Integrity protected and with default ciphering | <-- | IDENTITY REQUEST | - | - |
| 20 | Check: Does the UE transmit an IDENTITY RESPONSE message with Integrity Protected and with default ciphering? | --> | IDENTITY RESPONSE | 1 | P |
| 21 | The SS transmits an IDENTITY REQUEST message (not Integrity protected) | <-- | IDENTITY REQUEST | - | - |
| 22 | Check: Does the UE transmit an IDENTITY RESPONSE message within the next 5 seconds? | --> | IDENTITY RESPONSE | 2 | F |

9.1.2.3.3.3 Specific message contents

Table 9.1.2.3.3.3-1: SECURITY MODE COMMAND (Step 7, Table 9.1.2.3.3.2-1)

| Derivation path: TS 38.508-1 [4], table 4.7.1-25 | | | |
|--|--------------|---|-----------|
| Information Element | Value/Remark | Comment | Condition |
| Selected NAS security algorithms | | | |
| Type of integrity protection algorithm | '0001'B | 5G integrity algorithm 128-5G-IA1[SNOW3G] | |

9.1.2.4 Integrity protection / Correct functionality of 5G NAS integrity algorithm / AES

9.1.2.4.1 Test Purpose (TP)

(1)

```

with { successful completion of 5G authentication and key agreement (AKA) procedure }
ensure that {
  when { UE receives a an integrity protected SECURITY MODE COMMAND message instructing to start
integrity protection using algorithm AES }
  then { UE transmits an integrity protected SECURITY MODE COMPLETE using AES and starts applying
the NAS Integrity protection in both UL and DL }
}

```

(2)

```

with { Integrity protection successful started by executing Security Mode Procedure }
ensure that {
  when { UE receives an IDENTITY REQUEST message (requested identification parameter is not SUCI),
without integrity protected }
  then { UE does not transmit IDENTITY Response }
}

```

}

9.1.2.4.2 Conformance requirements

Same Conformance requirements as in clause 9.1.2.3.2.

9.1.2.4.3 Test description

9.1.2.4.3.1 Pre-test conditions

Same Pre-test conditions as in clause 9.1.2.3.3.1.

9.1.2.4.3.2 Test procedure sequence

Same Test procedure sequence as in table 9.1.2.3.3.2-1, except the integrity protection algorithm is AES.

9.1.2.4.3.3 Specific message contents

Table 9.1.2.4.3.3-1: SECURITY MODE COMMAND (Step 7)

| Derivation path: TS 38.508-1 [4], table 4.7.1-25 | | | |
|--|--------------|---|-----------|
| Information Element | Value/Remark | Comment | Condition |
| Selected NAS security algorithms | | | |
| Type of integrity protection algorithm | '0010'B | 5G integrity algorithm 128-5G-IA2 [AES] | |

9.1.2.5 Integrity protection / Correct functionality of 5G NAS integrity algorithm / ZUC

9.1.2.5.1 Test Purpose (TP)

(1)

```
with { successful completion of 5G authentication and key agreement (AKA) procedure }
ensure that {
  when { UE receives a an integrity protected SECURITY MODE COMMAND message instructing to start
integrity protection using algorithm ZUC }
  then { UE transmits an integrity protected SECURITY MODE COMPLETE using ZUC and starts applying
the NAS Integrity protection in both UL and DL }
}
```

(2)

```
with { Integrity protection successful started by executing Security Mode Procedure }
ensure that {
  when { UE receives an IDENTITY REQUEST message (requested identification parameter is not SUCI),
without integrity protected }
  then { UE does not transmit IDENTITY Response }
}
```

9.1.2.5.2 Conformance requirements

Same Conformance requirements as in clause 9.1.2.3.2.

9.1.2.5.3 Test description

9.1.2.5.3.1 Pre-test conditions

Same Pre-test conditions as in clause 9.1.2.3.3.1.

9.1.2.5.3.2 Test procedure sequence

Same Test procedure sequence as in table 9.1.2.3.3.2-1, except the integrity protection algorithm is ZUC.

9.1.2.5.3.3 Specific message contents

Table 9.1.2.5.3.3-1: SECURITY MODE COMMAND (Step 7)

| Derivation path: TS 38.508-1 [4], table 4.7.1-25 | | | |
|--|--------------|---|-----------|
| Information Element | Value/Remark | Comment | Condition |
| Selected NAS security algorithms | | | |
| Type of integrity protection algorithm | '0011'B | 5G integrity algorithm 128-5G-IA3 [ZUC] | |

9.1.2.6 Ciphering and deciphering / Correct functionality of 5G NAS encryption algorithm / SNOW3G

9.1.2.6.1 Test Purpose (TP)

(1)

```
with { successful completion of 5G authentication and key agreement (AKA) procedure }
ensure that {
  when { UE receives a SECURITY MODE COMMAND instructing to start ciphering using algorithm SNOW3G }
  then { UE sends a SECURITY MODE COMPLETE message ciphered with SNOW3G and starts applying the
  NAS ciphering in both UL and DL }
}
```

9.1.2.6.2 Conformance requirements

References: The conformance requirements covered in the current TC are specified in: TS 24.501 clause 5.4.3.1, 5.4.3.2 and 5.4.3.3. Unless otherwise stated these are Rel-15 requirements.

[TS 24.501, clause 5.4.2.1]

The purpose of the NAS security mode control procedure is to take a 5G NAS security context into use, and initialise and start NAS signalling security between the UE and the AMF with the corresponding 5G NAS keys and 5G NAS security algorithms.

[TS 24.501, clause 5.4.2.2]

The AMF initiates the NAS security mode control procedure by sending a SECURITY MODE COMMAND message to the UE and starting timer T3560 (see example in figure 5.4.2.2).

The AMF shall reset the downlink NAS COUNT counter and use it to integrity protect the initial SECURITY MODE COMMAND message if the security mode control procedure is initiated:

- a) to take into use the security context created after a successful execution of the 5G AKA based primary authentication and key agreement procedure or the EAP based primary authentication and key agreement procedure; or

...

The AMF shall send the SECURITY MODE COMMAND message uncyphered, but shall integrity protect the message with the 5G NAS integrity key based on K_{AMF} or mapped K'_{AMF} indicated by the ngKSI included in the message. The AMF shall set the security header type of the message to "integrity protected with new 5G NAS security context".

...

The AMF shall include the replayed security capabilities of the UE (including the security capabilities with regard to NAS, RRC and UP (user plane) ciphering as well as NAS and RRC integrity, and other possible target network security

capabilities, i.e. E-UTRAN if the UE included them in the message to network), the selected 5GS ciphering and integrity algorithms and the ngKSI.

[TS 24.501, clause 5.4.2.3]

Upon receipt of the SECURITY MODE COMMAND message, the UE shall check whether the security mode command can be accepted or not. This is done by performing the integrity check of the message, and by checking that the received Replayed UE security capabilities IE has not been altered compared to the latest values that the UE sent to the network.

...

If the type of security context flag included in the SECURITY MODE COMMAND message is set to "native security context" and if the ngKSI matches a valid non-current native 5G NAS security context held in the UE while the UE has a mapped 5G NAS security context as the current 5G NAS security context, the UE shall take the non-current native 5G NAS security context into use which then becomes the current native 5G NAS security context and delete the mapped 5G NAS security context.

...

If the SECURITY MODE COMMAND message can be accepted, the UE shall take the 5G NAS security context indicated in the message into use. The UE shall in addition reset the uplink NAS COUNT counter if:

- a) the SECURITY MODE COMMAND message is received in order to take a 5G NAS security context into use created after a successful execution of the 5G AKA based primary authentication and key agreement procedure or the EAP based primary authentication and key agreement procedure; or
- b) the SECURITY MODE COMMAND message received includes the type of security context flag set to "mapped security context" in the NAS key set identifier IE the ngKSI does not match the current 5G NAS security context, if it is a mapped 5G NAS security context.

...

If the SECURITY MODE COMMAND message can be accepted, the UE shall send a SECURITY MODE COMPLETE message integrity protected with the selected 5GS integrity algorithm and the 5G NAS integrity key based on the K_{AMF} or mapped K'_{AMF} if the type of security context flag is set to "mapped security context" indicated by the ngKSI. When the SECURITY MODE COMMAND message includes the type of security context flag set to "mapped security context" in the NAS key set identifier IE, then the UE shall check whether the SECURITY MODE COMMAND message indicates the ngKSI of the current 5GS security context, if it is a mapped 5G NAS security context, in order not to re-generate the K'_{AMF} .

Furthermore, if the SECURITY MODE COMMAND message can be accepted, the UE shall cipher the SECURITY MODE COMPLETE message with the selected 5GS ciphering algorithm and the 5GS NAS ciphering key based on the K_{AMF} or mapped K'_{AMF} indicated by the ngKSI. The UE shall set the security header type of the message to "integrity protected and ciphered with new 5G NAS security context".

From this time onward the UE shall cipher and integrity protect all NAS signalling messages with the selected 5GS integrity and ciphering algorithms

9.1.2.6.3 Test description

9.1.2.6.3.1 Pre-test conditions

System Simulator:

- NGC Cell A.

UE:

- None.

Preamble:

- The UE is in state Switched OFF (state 0N-B) according to TS 38.508-1 [4].

9.1.2.6.3.2 Test procedure sequence

Table 9.1.2.6.3.2-1: Main behaviour

| St | Procedure | Message Sequence | | TP | Verdict |
|--------|--|------------------|------------------------|----|---------|
| | | U - S | Message | | |
| 1 | The UE is switched on. | - | - | - | - |
| 2-6 | Steps 2-6 of the generic procedure for UE registration specified in TS 38.508-1 [4] subclause 4.5.2.3 are performed. | - | - | - | - |
| 7 | The SS transmits a SECURITY MODE COMMAND message to activate NAS security. | <-- | SECURITY MODE COMMAND | - | - |
| 8 | Check: Does the UE transmit a SECURITY MODE COMPLETE message ciphered and starts applying the NAS ciphering in both UL and DL? | --> | SECURITY MODE COMPLETE | 1 | P |
| 9-18a1 | Steps 10-19a1 of the generic procedure for UE registration specified in TS 38.508-1 [4] table 4.5.2.2-2 are performed. | - | - | - | - |
| 19 | The SS transmits an IDENTITY REQUEST message Ciphered | <-- | IDENTITY REQUEST | - | - |
| 20 | Check: Does the UE transmit an IDENTITY RESPONSE message Ciphered? | --> | IDENTITY RESPONSE | 1 | P |

9.1.2.6.3.3 Specific message contents

Table 9.1.2.6.3.3-1: SECURITY MODE COMMAND (Step 7, Table 9.1.2.6.3.2-1)

| Derivation path: TS 38.508-1 [4], table 4.7.1-25 | | | |
|--|--------------|---|-----------|
| Information Element | Value/Remark | Comment | Condition |
| Selected NAS security algorithms | | | |
| Type of ciphering algorithm | '0001'B | 5G encryption algorithm 128-5G-EA1 [SNOW3G] | |

9.1.2.7 Ciphering and deciphering / Correct functionality of 5G NAS encryption algorithm / AES

9.1.2.7.1 Test Purpose (TP)

(1)

```
with { successful completion of 5G authentication and key agreement (AKA) procedure }
ensure that {
  when { UE receives a SECURITY MODE COMMAND instructing to start ciphering using algorithm AES }
  then { UE sends a SECURITY MODE COMPLETE message ciphered with AES and starts applying the NAS
  ciphering in both UL and DL }
}
```

9.1.2.7.2 Conformance requirements

Same conformance requirement as in clause 9.1.2.6.2.

9.1.2.7.3 Test description

9.1.2.7.3.1 Pre-test conditions

Same Pre-test conditions as in clause 9.1.2.6.3.1.

9.1.2.7.3.2 Test procedure sequence

Same Test procedure sequence as in Table 9.1.2.6.3.2-1, except the ciphering algorithm is AES.

9.1.2.7.3.3 Specific message contents

Table 9.1.2.7.3.3-1: SECURITY MODE COMMAND (Step 7)

| Derivation path: TS 38.508-1 [4], table 4.7.1-25 | | | |
|--|--------------|--|-----------|
| Information Element | Value/Remark | Comment | Condition |
| Selected NAS security algorithms | | | |
| Type of ciphering algorithm | '0010'B | 5G encryption algorithm 128-5G-EA2 [AES] | |

9.1.2.8 Ciphering and deciphering / Correct functionality of 5G NAS encryption algorithm / ZUC

9.1.2.8.1 Test Purpose (TP)

(1)

```
with { successful completion of 5G authentication and key agreement (AKA) procedure }
ensure that {
  when { UE receives a SECURITY MODE COMMAND instructing to start ciphering using algorithm ZUC }
  then { UE sends a SECURITY MODE COMPLETE message ciphered with ZUC and starts applying the NAS
  ciphering in both UL and DL }
}
```

9.1.2.8.2 Conformance requirements

Same conformance requirement as in clause 9.1.2.6.2.

9.1.2.8.3 Test description

9.1.2.8.3.1 Pre-test conditions

Same Pre-test conditions as in clause 9.1.2.6.3.1.

9.1.2.8.3.2 Test procedure sequence

Same Test procedure sequence as in Table 9.1.2.6.3.2-1, except the ciphering algorithm is ZUC.

9.1.2.8.3.3 Specific message contents

Table 9.1.2.8.3.3-1: SECURITY MODE COMMAND (Step 7)

| Derivation path: TS 38.508-1 [4], table 4.7.1-25 | | | |
|--|--------------|--|-----------|
| Information Element | Value/Remark | Comment | Condition |
| Selected NAS security algorithms | | | |
| Type of ciphering algorithm | '0011'B | 5G encryption algorithm 128-5G-EA3 [ZUC] | |

9.1.3 Identification

9.1.3.1 Identification procedure

9.1.3.1.1 Test Purpose (TP)

(1)

```
with { The UE is in 5GMM-REGISTERED-INITIATED state and the SS sends an IDENTITY REQUEST message }
ensure that {
  when { UE detects transmission failure of IDENTITY RESPONSE message }
  then { The UE re-initiates the Initial registration procedure }
}
```

(2)

```
with { The UE is in 5GMM-CONNECTED mode and the SS sends an IDENTITY REQUEST message }
ensure that {
  when { The UE receives the unprotected IDENTITY REQUEST message with identity type as SUCI }
  then { UE transmits the IDENTITY RESPONSE message with identity type set to SUCI }
}
```

(3)

```
with { The UE is in 5GMM-CONNECTED mode and the SS sends an IDENTITY REQUEST message }
ensure that {
  when { the UE receives an IDENTITY REQUEST with identity type set as IMEISV }
  then { UE transmits an IDENTITY RESPONSE with identity type set as IMEISV }
}
```

(4)

```
with { The UE is in 5GMM-CONNECTED mode and the SS sends an IDENTITY REQUEST message }
ensure that {
  when { the UE receives an IDENTITY REQUEST with identity type set as "IMEI" }
  then { UE transmits an IDENTITY RESPONSE with identity type set as "IMEI" }
}
```

(5)

```
with { The UE is in 5GMM-CONNECTED mode and the SS sends an IDENTITY REQUEST message }
ensure that {
  when { the UE receives an IDENTITY REQUEST with identity type set as "5G-GUTI" and has no valid
5G-GUTI available }
  then { UE transmits an IDENTITY RESPONSE with identity type set as "No identity" }
}
```

9.1.3.1.2 Conformance requirements

References: The conformance requirements covered in the present TC are specified in: TS 24.501, clauses 5.4.3.3, 4.4.4.3 and 5.4.3.5. Unless otherwise stated these are Rel-15 requirements.

[TS 24.501, clause 5.4.3.3]

A UE shall be ready to respond to an IDENTITY REQUEST message at any time whilst in 5GMM-CONNECTED mode.

Upon receipt of the IDENTITY REQUEST message:

- a) if the Identity type IE in the IDENTITY REQUEST message is not set to "SUCI", the UE shall send an IDENTITY RESPONSE message to the network. The IDENTITY RESPONSE message shall contain the identification parameters as requested by the network; and
- b) if the Identity type IE in the IDENTITY REQUEST message is set to "SUCI", the UE shall:

- 1) if timer T3519 is not running, generate a fresh SUCI as specified in 3GPP TS 33.501 [24], send an IDENTITY RESPONSE message with the SUCI, start timer T3519 and store the value of the SUCI sent in the IDENTITY RESPONSE message; and
- 2) if timer T3519 is running, send an IDENTITY RESPONSE message with the stored SUCI.

[TS 24.501, clause 4.4.4.3]

Except the messages listed below, no NAS signalling messages shall be processed by the receiving 5GMM entity in the AMF or forwarded to the 5GSM entity, unless the secure exchange of NAS messages has been established for the NAS signalling connection:

- a) REGISTRATION REQUEST;
- b) IDENTITY RESPONSE (if requested identification parameter is SUCI);
- c) AUTHENTICATION RESPONSE;
- d) AUTHENTICATION FAILURE;
- e) SECURITY MODE REJECT;
- f) DEREGISTRATION REQUEST; and
- g) DEREGISTRATION ACCEPT;

NOTE 1: The REGISTRATION REQUEST message is sent by the UE without integrity protection, if the registration procedure is initiated due to an inter-system change in 5GMM-IDLE mode and no current 5G NAS security context is available in the UE. The other messages are accepted by the AMF without integrity protection, as in certain situations they are sent by the UE before security can be activated.

NOTE 2: The DEREGISTRATION REQUEST message can be sent by the UE without integrity protection, e.g. if the UE is registered for emergency services and there is no shared 5G NAS security context available, or if due to user interaction a registration procedure is cancelled before the secure exchange of NAS messages has been established. For these cases the network can attempt to use additional criteria (e.g. whether the UE is subsequently still performing periodic registration update or still responding to paging) before marking the UE as 5GMM-DEREGISTERED.

Integrity protection is never applied directly to 5GSM messages, but to the 5GMM message in which the 5GSM message is included.

Once a current 5G NAS security context exists, until the secure exchange of NAS messages has been established for the NAS signalling connection, the receiving 5GMM entity in the AMF shall process the following NAS signalling messages, even if the MAC included in the message fails the integrity check or cannot be verified, as the 5G NAS security context is not available in the network:

- a) REGISTRATION REQUEST;
- b) IDENTITY RESPONSE (if requested identification parameter is SUCI);
- c) AUTHENTICATION RESPONSE;
- d) AUTHENTICATION FAILURE;
- e) SECURITY MODE REJECT;
- f) DEREGISTRATION REQUEST;
- g) DEREGISTRATION ACCEPT; and
- h) SERVICE REQUEST;

...

[TS 24.501, clause 5.4.3.5]

The following abnormal cases can be identified:

- a) Transmission failure of the IDENTITY RESPONSE message (if the identification procedure is triggered by a registration procedure).

The UE shall re-initiate the registration procedure.

- b) Requested identity is not available

If the UE cannot encode the requested identity in the IDENTITY RESPONSE message, e.g. because no valid USIM is available, then it shall encode the identity type as "No identity".

9.1.3.1.3 Test description

9.1.3.1.3.1 Pre test conditions

System Simulator:

- NGC Cell A is configured as "Serving cell" according to TS 38.508-1 [4] Table 6.3.2.2-1.
- System information combination NR-1 as defined in TS 38.508-1 [4] clause 4.4.3.1.2 is used.

UE:

None.

Preamble:

- The UE is in state Switched OFF (State 0N-B) as per TS 38.508-1[4] Table 4.4A.2-0.

9.1.3.1.3.2 Test procedure sequence

Table 9.1.3.1.3.2-1: Main behaviour

| St | Procedure | Message Sequence | | TP | Verdict |
|---|--|------------------|---------------------|----|---------|
| | | U - S | Message | | |
| - | Void | - | - | - | - |
| 1 | The UE is switched on. | - | - | - | - |
| 2-4 | The UE establishes RRC connection by executing steps 2-4 of Table 4.5.2.2-2 in TS 38.508-1 [4]. | - | - | - | - |
| 5 | SS is configured to not allocate any UL grant and RA Response, so that the UE cannot send the IDENTITY RESPONSE to SS. | - | - | - | - |
| 6 | The SS transmits an IDENTITY REQUEST requesting SUCI in the IE identity type. | <-- | IDENTITY REQUEST | - | - |
| 6A | SS starts timer of T3511 (Note 1). | - | - | - | - |
| 6B | SS locally releases the RRC connection. | - | - | - | - |
| 6C | Wait for T3511 to time out. | - | - | - | - |
| 6D | SS configures the RA Response. | - | - | - | - |
| 7-9 | The UE establishes RRC connection by executing steps 2-4 of Table 4.5.2.2-2 in TS 38.508-1 [4]. (Note 2) | - | - | 1 | P |
| 10 | The SS transmits an unprotected IDENTITY REQUEST requesting SUCI in the IE identity type. | <-- | IDENTITY REQUEST | - | - |
| 11 | Check: Does the UE respond with an IDENTITY RESPONSE message with IE identity type set to "SUCI"? | --> | IDENTITY RESPONSE | 2 | P |
| 11 A | The SS transmits a REGISTRATION REJECT (Cause #3, illegal UE). | <-- | REGISTRATION REJECT | - | - |
| 11 B | The SS releases the RRC. | - | - | - | - |
| 11 C | The UE is Switched OFF. | - | - | - | - |
| 11 D | The UE is Switched ON. | - | - | - | - |
| 12-24 | Steps 1–13 of Table 4.5.2.2-2 in TS 38.508-1 [4] are performed. | - | - | - | - |
| 25 | The SS transmits an IDENTITY REQUEST requesting 5G-GUTI in the IE identity type. | <-- | IDENTITY REQUEST | - | - |
| 26 | Check: Does the UE respond with an IDENTITY RESPONSE message with IE identity type set to "No identity"? | --> | IDENTITY RESPONSE | 5 | P |
| 27-29 Ba 1 | Steps 14-19a1 of Table 4.5.2.2-2 in TS 38.508-1 [4] are performed. | - | - | - | - |
| 30 | The SS transmits an IDENTITY REQUEST requesting IMEISV in the IE identity type. | <-- | IDENTITY REQUEST | - | - |
| 31 | Check: Does the UE respond with an IDENTITY RESPONSE message with IE identity type set to IMEISV? | --> | IDENTITY RESPONSE | 3 | P |
| 32 | The SS transmits an IDENTITY REQUEST requesting IMEI in the IE identity type. | <-- | IDENTITY REQUEST | - | - |
| 33 | Check: Does the UE respond with an IDENTITY RESPONSE message with IE identity type set to IMEI? | --> | IDENTITY RESPONSE | 4 | P |
| 34-35 | Void | - | - | - | - |
| Note 1: To send the IDENTITY RESPONSE, the UE will initiate RACH to get UL grant. Since there is no RA Response, registration failure due to lower layer failure will occur, then T3511 will start. | | | | | |
| Note 2: The UL grant is restarted in step 8. | | | | | |

9.1.3.1.3.3 Specific message contents

Table 9.1.3.1.3.3-1: IDENTITY REQUEST (step 6, 10 Table 9.1.3.1.3.2-1)

| Derivation Path: TS 38.508-1 [4], Table 4.7.1-21 | | | |
|--|--------------|---------|-----------|
| Information Element | Value/remark | Comment | Condition |
| Identity type | '001'B | SUCI | |

Table 9.1.3.1.3.3-2: IDENTITY RESPONSE (step 11 Table 9.1.3.1.3.2-1)

| Derivation Path: TS 38.508-1 [4], Table 4.7.1-22 | | | |
|--|--------------|---------|-----------|
| Information Element | Value/remark | Comment | Condition |
| Identity type | '001'B | SUCI | |

Table 9.1.3.1.3.3-3: IDENTITY REQUEST (step 30 Table 9.1.3.1.3.2-1)

| Derivation Path: TS 38.508-1 [4], Table 4.7.1-21 | | | |
|--|--------------|---------|-----------|
| Information Element | Value/remark | Comment | Condition |
| Identity type | '101'B | IMEISV | |

Table 9.1.3.1.3.3-4: IDENTITY RESPONSE (step 31 Table 9.1.3.1.3.2-1)

| Derivation Path: TS 38.508-1 [4], Table 4.7.1-22 | | | |
|--|--------------|---------|-----------|
| Information Element | Value/remark | Comment | Condition |
| Identity type | '101'B | IMEISV | |

Table 9.1.3.1.3.3-5: IDENTITY REQUEST (step 32 Table 9.1.3.1.3.2-1)

| Derivation Path: TS 38.508-1 [4], Table 4.7.1-21 | | | |
|--|--------------|---------|-----------|
| Information Element | Value/remark | Comment | Condition |
| Identity type | '011'B | IMEI | |

Table 9.1.3.1.3.3-6: IDENTITY RESPONSE (step 33 Table 9.1.3.1.3.2-1)

| Derivation path: TS 38.508-1 [4], Table 4.7.1-22 | | | |
|--|--------------|---------|-----------|
| Information Element | Value/remark | Comment | Condition |
| Identity type | '011'B | IMEI | |

Table 9.1.3.1.3.3-7: IDENTITY REQUEST (step 25 Table 9.1.3.1.3.2-1)

| Derivation Path: TS 38.508-1 [4], Table 4.7.1-21 | | | |
|--|--------------|---------|-----------|
| Information Element | Value/remark | Comment | Condition |
| Identity type | '010'B | 5G-GUTI | |

Table 9.1.3.1.3.3-8: IDENTITY RESPONSE (step 26 Table 9.1.3.1.3.2-1)

| Derivation Path: TS 38.508-1 [4], Table 4.7.1-22 | | | |
|--|--------------|-------------|-----------|
| Information Element | Value/remark | Comment | Condition |
| Identity type | '000'B | No Identity | |

Table 9.1.3.1.3.3-9: Void

Table 9.1.3.1.3.3-10: REGISTRATION REJECT (step 11A Table 9.1.3.1.3.2-1)

| Derivation Path: TS 38.508-1 [4], Table 4.7.1-9 | | | |
|---|--------------|------------|-----------|
| Information Element | Value/remark | Comment | Condition |
| 5GMM cause | '00000011'B | Illegal UE | |

9.1.4 Generic UE configuration update

9.1.4.1 Generic UE configuration update / New 5G-GUTI, NITZ, registration requested, Network slicing indication, New Allowed NSSAI / acknowledgement from the UE

9.1.4.1.1 Test Purpose (TP)

(1)

```
with { UE in 5GMM-REGISTERED state }
ensure that {
  when { UE receives a new 5G-GUTI in the CONFIGURATION UPDATE COMMAND message and acknowledgement
from the UE is requested }
  then { UE sends a CONFIGURATION UPDATE COMPLETE message and UE shall consider new 5G-GUTI as
valid }
}
```

(2)

```
with { UE in 5GMM-REGISTERED state }
ensure that {
  when { UE receives a NITZ information in the CONFIGURATION UPDATE COMMAND message and
acknowledgement from the UE is not requested }
  then { UE updates NITZ information }
}
```

(3)

```
with { UE in 5GMM-REGISTERED state }
ensure that {
  when { UE receives CONFIGURATION UPDATE COMMAND message indicating "registration requested" and
contains no other parameters }
  then { UE deletes any stored allowed NSSAI for this PLMN and then release the existing N1 NAS
signalling connection, starts a mobility registration procedure }
}
```

(4)

```
with { UE in 5GMM-REGISTERED state }
ensure that {
  when { UE receives a new allowed NSSAI in the CONFIGURATION UPDATE COMMAND message and
registration is not requested }
  then { UE replaces any stored allowed NSSAI for this PLMN with new allowed NSSAI }
}
```

(5)

```
with { UE in 5GMM-REGISTERED state }
ensure that {
  when { UE receives a Network Slicing subscription change indication set to "Network slicing
subscription changed" in the CONFIGURATION UPDATE COMMAND message and registration is not requested
}
  then { UE deletes the network slicing information for each and every PLMN except for the current
PLMN and default configured NSSAI }
}
```

9.1.4.1.2 Conformance requirements

References: The conformance requirements covered in the present TC are specified in: TS 24.501, clause 4.6.2.2, 5.4.4.1, 5.4.4.2, 5.4.4.3, 5.5.1.2.2 and 5.5.1.3.2. Unless otherwise stated these are Rel-15 requirements.

[TS 24.501 clause 4.6.2.2]

If available, the configured NSSAI(s) shall be stored in a non-volatile memory in the ME as specified in annex C.

...

If the UE receives the CONFIGURATION UPDATE COMMAND message indicating "registration requested" and contains no other parameters (see subclauses 5.4.4.2 and 5.4.4.3), the UE shall delete any stored allowed NSSAI for this PLMN, and delete any stored mapping of each S-NSSAI of the allowed NSSAI to the S-NSSAI(s) of the HPLMN, if available;

...

d) When the UE receives the Network slicing indication IE with the Network slicing subscription change indication set to "Network slicing subscription changed" in the REGISTRATION ACCEPT message or in the CONFIGURATION UPDATE COMMAND message, the UE shall delete the network slicing information for each of the PLMNs that the UE has slicing information stored for (excluding the current PLMN). The UE shall not delete the default configured NSSAI. Additionally, the UE shall update the network slicing information for the current PLMN (if received) as specified above in bullets a), b) and c):

[TS 24.501 clause 5.4.4.1]

The purpose of this procedure is to:

- a) allow the AMF to update the UE configuration for access and mobility management-related parameters decided and provided by the AMF by providing new parameter information within the command; or
- b) request the UE to perform a registration procedure for mobility and periodic registration update towards the network to update access and mobility management-related parameters decided and provided by the AMF (see subclause 5.5.1.3).

This procedure is initiated by the network and can only be used when the UE has an established 5GMM context, and the UE is in 5GMM-CONNECTED mode. When the UE is in 5GMM-IDLE mode, the AMF may use the paging or notification procedure to initiate the generic UE configuration update procedure. The AMF can request a confirmation response in order to ensure that the parameter has been updated by the UE.

This procedure shall be initiated by the network to assign a new 5G-GUTI to the UE after a successful service request procedure invoked as a response to a paging request from the network and before the release of the N1 NAS signalling connection. If the service request procedure was triggered due to 5GSM downlink signalling pending, the procedure for assigning a new 5G-GUTI can be initiated by the network after the transport of the 5GSM downlink signalling.

The following parameters are supported by the generic UE configuration update procedure without the need to request the UE to perform the registration procedure for mobility and periodic registration update:

- a) 5G-GUTI;
- b) TAI list;
- c) Service area list;
- d) Network identity and time zone information (Full name for network, short name for network, local time zone, universal time and local time zone, network daylight saving time);
- e) LADN information;
- f) Rejected NSSAI;
- g) Network slicing indication;
- h) Operator-defined access category definitions; and
- i) SMS indication.

The following parameters can be sent to the UE with or without a request to perform the registration procedure for mobility and periodic registration update:

- a) Allowed NSSAI; or
- b) Configured NSSAI.

The following parameter is sent to the UE with a request to perform the registration procedure for mobility and periodic registration update:

- a) MICO indication.

The following parameters are sent over 3GPP access only:

- a) LADN information;
- b) MICO indication;
- c) TAI list; and
- d) Service area list.

The following parameters are managed and sent per access type i.e., independently over 3GPP access or non 3GPP access:

- a) Allowed NSSAI; and
- b) Rejected NSSAI (when the NSSAI is rejected for the current registration area).

The following parameters are managed commonly and sent over 3GPP access or non 3GPP access:

- a) 5G-GUTI;
- b) Network identity and time zone information;
- c) Rejected NSSAI (when the NSSAI is rejected for the current PLMN);
- d) Configured NSSAI; and
- e) SMS indication.

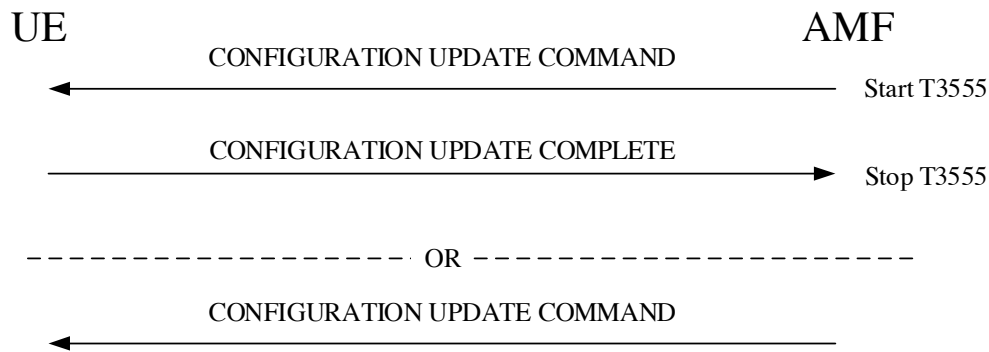

Figure 5.4.4.1.1: Generic UE configuration update procedure

[TS 24.501 clause 5.4.4.2]

The AMF shall initiate the generic UE configuration update procedure by sending the CONFIGURATION UPDATE COMMAND message to the UE.

The AMF shall in the CONFIGURATION UPDATE COMMAND message either:

- a) include one or more of the following parameters: 5G-GUTI, TAI list, allowed NSSAI that may include the mapped S-NSSAI(s), LADN information, service area list, MICO indication NITZ information, configured NSSAI that may include the mapped S-NSSAI(s), rejected NSSAI, network slicing indication, operator-defined access category definitions or SMS indication;
- b) include the Configuration update indication IE with the Registration requested bit set to "registration requested";
or
- c) include a combination of both a) and b).

If an acknowledgement from the UE is requested, the AMF shall indicate "acknowledgement requested" in the Acknowledgement bit of the Configuration update indication IE in the CONFIGURATION UPDATE COMMAND message and shall start timer T3555. Acknowledgement shall be requested for all parameters except when only NITZ is included.

To initiate parameter re-negotiation between the UE and network, the AMF shall indicate "registration requested" in the Registration requested bit of the Configuration update indication IE in the CONFIGURATION UPDATE COMMAND message.

If a new allowed NSSAI information or AMF re-configuration of supported S-NSSAIs requires an AMF relocation, the AMF shall indicate "registration requested" in the Registration requested bit of the Configuration update indication IE and include the Allowed NSSAI IE in the CONFIGURATION UPDATE COMMAND message.

If the AMF includes a new configured NSSAI in the CONFIGURATION UPDATE COMMAND message and the new configured NSSAI requires an AMF relocation as specified in 3GPP TS 23.501 [8], the AMF shall indicate "registration requested" in the Registration requested bit of the Configuration update indication IE in the message.

If the AMF indicates "registration requested" in the Registration requested bit of the Configuration update indication IE, acknowledgement shall be requested.

If changes to the allowed NSSAI require the UE to initiate a registration procedure, but the AMF is unable to determine an allowed NSSAI for the UE as specified in 3GPP TS 23.501 [8], the CONFIGURATION UPDATE COMMAND message shall indicate "registration requested" in the Registration requested bit of the Configuration update indication IE, and shall not contain any other parameters.

If the AMF needs to update the LADN information, the AMF shall include the LADN information in the LADN information IE of the CONFIGURATION UPDATE COMMAND message.

During an established 5GMM context, the network may send none, one, or more CONFIGURATION UPDATE COMMAND messages to the UE. If more than one CONFIGURATION UPDATE COMMAND message is sent, the messages need not have the same content.

[TS 24.501 clause 5.4.4.3]

Upon receiving the CONFIGURATION UPDATE COMMAND message, the UE shall stop timer T3346 if running and use the contents to update appropriate information stored within the UE.

If "acknowledgement requested" is indicated in the Acknowledgement bit of the Configuration update indication IE in the CONFIGURATION UPDATE COMMAND message, the UE shall send a CONFIGURATION UPDATE COMPLETE message.

If the UE receives a new 5G-GUTI in the CONFIGURATION UPDATE COMMAND message, the UE shall consider the new 5G-GUTI as valid, the old 5G-GUTI as invalid, stop timer T3519 if running, and delete any stored SUCI; otherwise, the UE shall consider the old 5G-GUTI as valid. The UE shall provide the 5G-GUTI to the lower layer of 3GPP access if the CONFIGURATION UPDATE COMMAND message is sent over the non-3GPP access, and the UE is in 5GMM-REGISTERED in both 3GPP access and non-3GPP access in the same PLMN.

If the UE receives a new TAI list in the CONFIGURATION UPDATE COMMAND message, the UE shall consider the new TAI list as valid and the old TAI list as invalid; otherwise, the UE shall consider the old TAI list as valid.

If the UE receives a new service area list in the CONFIGURATION UPDATE COMMAND message, the UE shall consider the new service area list as valid and the old service area list as invalid; otherwise, the UE shall consider the old service area list, if any, as valid.

If the UE receives new NITZ information in the CONFIGURATION UPDATE COMMAND message, the UE considers the new NITZ information as valid and the old NITZ information as invalid; otherwise, the UE shall consider the old NITZ information as valid.

If the UE receives a LADN information IE in the CONFIGURATION UPDATE COMMAND message, the UE shall consider the old LADN information as invalid and the new LADN information as valid, if any; otherwise, the UE shall consider the old LADN information as valid.

If the UE receives a new allowed NSSAI for the associated access type in the CONFIGURATION UPDATE COMMAND message, the UE shall consider the new allowed NSSAI as valid for the associated access type, store the allowed NSSAI for the associated access type as specified in subclause 4.6.2.2 and consider the old allowed NSSAI for the associated access type as invalid; otherwise, the UE shall consider the old Allowed NSSAI as valid for the associated access type.

If the UE receives a new configured NSSAI in the CONFIGURATION UPDATE COMMAND message, the UE shall consider the new configured NSSAI for the registered PLMN as valid and the old configured NSSAI for the registered PLMN as invalid; otherwise, the UE shall consider the old configured NSSAI for the registered PLMN as valid. The UE shall store the new configured NSSAI as specified in subclause 4.6.2.2.

If the UE receives the Network slicing indication IE in the CONFIGURATION UPDATE COMMAND message with the Network slicing subscription change indication set to "Network slicing subscription changed", the UE shall delete the network slicing information for each and every PLMN except for the current PLMN as specified in subclause 4.6.2.2.

If the UE receives Operator-defined access category definitions IE in the CONFIGURATION UPDATE COMMAND message and the Operator-defined access category definitions IE contains one or more operator-defined access category definitions, the UE shall delete any operator-defined access category definitions stored for the RPLMN and shall store the received operator-defined access category definitions for the RPLMN. If the UE receives the Operator-defined access category definitions IE in the CONFIGURATION UPDATE COMMAND message and the Operator-defined access category definitions IE contains no operator-defined access category definitions, the UE shall delete any operator-defined access category definitions stored for the RPLMN. If the CONFIGURATION UPDATE COMMAND message does not contain the Operator-defined access category definitions IE, the UE shall not delete the operator-defined access category definitions stored for the RPLMN.

If the UE receives the SMS indication IE in the CONFIGURATION UPDATE COMMAND message with the SMS availability indication set to:

- a) "SMS over NAS not available", the UE shall consider that SMS over NAS transport is not allowed by the network; and
- b) "SMS over NAS available", the UE may request the use of SMS over NAS transport by performing a registration procedure for mobility and periodic registration update as specified in subclause 5.5.1.3, after the completion of the generic UE configuration update procedure.

If the CONFIGURATION UPDATE COMMAND message indicates "registration requested" in the Registration requested bit of the Configuration update indication IE and:

- a) contains no other parameters or contains at least one of the following parameters: a new allowed NSSAI, a new configured NSSAI or the Network slicing subscription change indication, and:
 - 1) an emergency PDU session exists, the UE shall, after the completion of the generic UE configuration update procedure and the release of the emergency PDU session, release the existing N1 NAS signalling connection, and start a registration procedure for mobility and periodic registration update as specified in subclause 5.5.1.3; or
 - 2) no emergency PDU Session exists, the UE shall, after the completion of the generic UE configuration update procedure and the release of the existing N1 NAS signalling connection, start a registration procedure for mobility and periodic registration update as specified in subclause 5.5.1.3; or
- b) an MICO indication is included without a new allowed NSSAI or a new configured NSSAI, the UE shall, after the completion of the generic UE configuration update procedure, start a registration procedure for mobility and registration update as specified in subclause 5.5.1.3 to re-negotiate MICO mode with the network.

The UE receiving the rejected NSSAI in the CONFIGURATION UPDATE COMMAND message takes the following actions based on the rejection cause in the rejected NSSAI:

"S-NSSAI not available in the current PLMN"

The UE shall add the rejected S-NSSAI(s) in the rejected NSSAI for the current PLMN as specified in subclause 4.6.2.2 and not attempt to use this S-NSSAI in the current PLMN until switching off the UE or the UICC containing the USIM is removed.

"S-NSSAI not available in the current registration area"

The UE shall add the rejected S-NSSAI(s) in the rejected NSSAI for the current registration area as specified in subclause 4.6.2.2 and not attempt to use this S-NSSAI in the current registration area until switching off the UE, the UE moving out of the current registration area or the UICC containing the USIM is removed.

[TS 24.501 clause 5.5.1.2.2]

The subset of allowed NSSAI provided in the requested NSSAI consists of one or more S-NSSAIs in the allowed NSSAI for the current PLMN.

NOTE 3: How the UE selects the subset of configured NSSAI or allowed NSSAI to be provided in the requested NSSAI is implementation specific. The UE can take preferences indicated by the upper layers (e.g. policies, applications) into account.

NOTE 4: The number of S-NSSAI(s) included in the requested NSSAI cannot exceed eight.

If the UE initiates an initial registration for emergency services or needs to prolong the established NAS signalling connection after the completion of the initial registration procedure (e.g. due to uplink signalling pending), the UE shall set the Follow-on request indicator to 1.

[TS 24.501 clause 5.5.1.3.2]

For a REGISTRATION REQUEST message with a 5GS registration type IE indicating "mobility registration updating", UE shall include the requested NSSAI containing the S-NSSAI(s) corresponding to the slices to which the UE intends to register with and shall include the mapped S-NSSAI(s) for the requested NSSAI, if available, in the REGISTRATION REQUEST message. If the UE has allowed NSSAI or configured NSSAI for the current PLMN, the requested NSSAI shall be either:

- a) the configured NSSAI for the current PLMN, or a subset thereof as described below, if the UE has no allowed NSSAI for the current PLMN;
- b) the allowed NSSAI for the current PLMN, or a subset thereof as described below, if the UE has an allowed NSSAI for the current PLMN; or
- c) the allowed NSSAI for the current PLMN, or a subset thereof as described below, plus one or more S-NSSAIs from the configured NSSAI for which no corresponding S-NSSAI is present in the allowed NSSAI and those are neither in the rejected NSSAI for the current PLMN nor in the rejected NSSAI for the current registration area.

If the UE has neither allowed NSSAI for the current PLMN nor configured NSSAI for the current PLMN and has a default configured NSSAI, the UE shall:

- a) include the S-NSSAI(s) in the Requested NSSAI IE of the REGISTRATION REQUEST message using the default configured NSSAI; and
- b) include the Network slicing indication IE with the Default configured NSSAI indication bit set to "Requested NSSAI created from default configured NSSAI" in the REGISTRATION REQUEST message.

If the UE has no allowed NSSAI for the current PLMN, no configured NSSAI for the current PLMN, and no default configured NSSAI, the UE shall not include a requested NSSAI in the REGISTRATION REQUEST message.

The subset of configured NSSAI provided in the requested NSSAI consists of one or more S-NSSAIs in the configured NSSAI applicable to this PLMN, if the S-NSSAI is neither in the rejected NSSAIs for the current PLMN nor in the rejected NSSAI for the current registration area.

The subset of allowed NSSAI provided in the requested NSSAI consists of one or more S-NSSAIs in the allowed NSSAI for this PLMN.

NOTE 3: How the UE selects the subset of configured NSSAI or allowed NSSAI to be provided in the requested NSSAI is implementation specific. The UE can take preferences indicated by the upper layers (e.g. policies, applications) into account.

NOTE 4: The number of S-NSSAI(s) included in the requested NSSAI cannot exceed eight.

9.1.4.1.3 Test description

9.1.4.1.3.1 Pre-test conditions

System Simulator:

- NGC Cell A configured according to Table 6.3.2.2-1 and Table 6.3.2.2-3 in 38.508-1 [4] belongs to Home PLMN and set as serving cell;
- NGC Cell G configured according to Table 6.3.2.2-1 and Table 6.3.2.2-3 in 38.508-1 [4] and set as Non-Suitable "Off" cell.
- System information combination NR-4 as defined in TS 38.508[4] clause 4.4.3.1.2 is used.

UE:

- UE is configured with NSSAI associated with HPLMN and with 5G-GUTI assigned.
- The UE is equipped with a USIM configuration as defined in TS 38.508-1 [4] Table 6.4.1-22.

Preamble:

- The UE is in state 3N-A on NGC cell A according to TS 38.508-1 [4].

9.1.4.1.3.2 Test procedure sequence

Table 9.1.4.1.3.2-1: Main behaviour

| St | Procedure | Message Sequence | | TP | Verdict |
|-----------|---|------------------|-------------------------------|----|---------|
| | | U - S | Message | | |
| 1 | The SS transmits a CONFIGURATION UPDATE COMMAND message including a new 5G-GUTI. | <-- | CONFIGURATION UPDATE COMMAND | - | - |
| 2 | Check: Does UE transmit a CONFIGURATION UPDATE COMPLETE message? | --> | CONFIGURATION UPDATE COMPLETE | 1 | P |
| 3 | The SS transmits an <i>RRCRelease</i> message. | - | - | - | - |
| 4 | The SS transmits a <i>Paging</i> message with the new 5G-GUTI. | - | - | - | - |
| 5-11 | Steps 2 to 8 of the generic procedure for NR_RRC_CONNECTED specified in TS 38.508-1 [4] subclause 4.5.4.2-3 are performed. | - | - | 1 | P |
| 12 | The SS transmits a CONFIGURATION UPDATE COMMAND message including NITZ information. | <-- | CONFIGURATION UPDATE COMMAND | - | - |
| 13 | Check: Does the UE transmit a CONFIGURATION UPDATE COMPLETE message within the expiry of T3555? | --> | CONFIGURATION UPDATE COMPLETE | 2 | F |
| 14 | Check: Using MMI/AT command verify the NITZ update on the UE. | - | - | 2 | P |
| 15 | Switch off procedure in RRC_Connected specified in TS 38.508-1 [4] subclause 4.9.6.3 is performed. | - | - | - | - |
| 16 | The UE is switched On. | - | - | - | - |
| 17-30 | Steps 1 to 13 of the generic procedure for NR RRC_IDLE specified in TS 38.508-1 [4] subclause 4.5.2 are performed. | - | - | - | - |
| 31 | The SS transmits a REGISTRATION ACCEPT message including Configured NSSAI. | <-- | REGISTRATION ACCEPT | - | - |
| 31A – 31E | Steps 15 to 19a1 of the generic procedure for NR RRC_IDLE as specified in TS 38.508-1 [4] subclause 4.5.2.2-2 with 'connected without release' are performed. | - | - | - | - |
| 32 | The SS transmits a CONFIGURATION UPDATE COMMAND message including registration requested IE. | <-- | CONFIGURATION UPDATE COMMAND | - | - |
| 32A | The UE transmits a CONFIGURATION UPDATE COMPLETE message. | --> | CONFIGURATION UPDATE COMPLETE | - | - |
| 32B | SS releases the RRC connection. | - | - | - | - |
| 33 | Check: Does UE transmit a REGISTRATION REQUEST message with registration type value set to "Mobility" and including the Requested NSSAI? | --> | REGISTRATION REQUEST | 3 | P |
| 34-42 | Void. | - | - | - | - |
| 43 | The SS transmits a REGISTRATION ACCEPT message including Allowed NSSAI. | <-- | REGISTRATION ACCEPT | - | - |
| 44 | The UE transmits an <i>ULInformationTransfer</i> message and a REGISTRATION COMPLETE message. | --> | REGISTRATION COMPLETE | - | - |
| 44A | The SS transmits an <i>RRCRelease</i> message. | - | - | - | - |
| 45 | Check: Using MMI/AT command (+C5GNSSAIRDP) verify the update of allowed NSSAI. | - | - | 3 | P |
| 45A – 45H | Steps 1 to 8 of the generic procedure for NR RRC_CONNECTED specified in TS 38.508-1 [4] subclause 4.5.4.2-3 are performed. | - | - | - | - |
| 46 | The SS transmits a CONFIGURATION UPDATE COMMAND message including a new allowed NSSAI list. | <-- | CONFIGURATION UPDATE COMMAND | - | - |

| | | | | | |
|-------------|--|-----|-------------------------------|---|---|
| 47 | The UE transmits a CONFIGURATION UPDATE COMPLETE message. | --> | CONFIGURATION UPDATE COMPLETE | - | - |
| 48 | Check: Using MMI/AT command (+C5GNSSAIRDP) verify the update of allowed NSSAI. | - | - | 4 | P |
| 48A | SS releases the RRC connection. | - | - | - | - |
| 49 | The SS configures NGC Cell A as the "Non-suitable cell" and NGC Cell G as the "Serving cell". | - | - | - | - |
| 50-52 | Steps 2-4 of Table 4.5.2.2-2 of the generic procedure in TS 38.508-1 [4] are performed. | - | - | - | - |
| - | EXCEPTION: Steps 53A1 to 53A9 are performed if 5GS registration type is set as Initial Registration in step 52 | - | - | - | - |
| 53A1-53A9 | Steps 5 to 13 of the generic test procedure in TS 38.508-1 Table 4.5.2.2-2 are performed on NGC Cell G. | | | | |
| 53a1-63 | Void. | - | - | - | - |
| 64 | The SS transmits a REGISTRATION ACCEPT message including Allowed and Configured NSSAIs. | <-- | REGISTRATION ACCEPT | - | - |
| - | EXCEPTION: Steps 65a1 to 65b describe behaviour that depends on events happening prior to their execution; the "lower case letter" identifies a step sequence that take place if a specific prior event takes place. | - | - | - | - |
| 65a1-65a5a1 | .IF 5GS registration type is set as Initial Registration in step 52, THEN Steps 15 to 19a1 of the generic test procedure in TS 38.508-1 Table 4.5.2.2-2 are performed on NGC Cell G. | - | - | - | - |
| 65b | IF 5GS registration type is set as Mobility Registration in step 52, THEN UE transmits an ULInformationTransfer message and a REGISTRATION COMPLETE message on NGC Cell G. | --> | REGISTRATION COMPLETE | - | - |
| 65 | The UE transmits an <i>ULInformationTransfer</i> message and a REGISTRATION COMPLETE message. | --> | REGISTRATION COMPLETE | - | - |
| 66 | The SS transmits a CONFIGURATION UPDATE COMMAND message with Network slicing subscription changed. | <-- | CONFIGURATION UPDATE COMMAND | - | - |
| 67 | The UE transmits a CONFIGURATION UPDATE COMPLETE message. | --> | CONFIGURATION UPDATE COMPLETE | - | - |
| 67A | Void | - | - | - | - |
| 68 | Check: Using MMI/AT command (+C5GNSSAIRDP) verify the update of allowed NSSAI. | - | - | 5 | P |
| 69 | The SS transmits NSSAI DELETE REQUEST message to delete the Default Configured NSSAI list. | <-- | NSSAI DELETE REQUEST | - | - |
| 70 | UE transmits NSSAI DELETE RESPONSE message. | --> | NSSAI DELETE RESPONSE | - | - |
| 71 | The SS transmits an RRCRelease message. | <-- | - | - | - |

Table 9.1.4.1.3.3-10: NSSAI DELETE REQUEST (step 69, Table 9.1.4.1.3.2-1)

| Derivation path: TS 38.509 Table 6.7.1 | | | |
|--|--------------|-------------------------|-----------|
| Information Element | Value/remark | Comment | Condition |
| Protocol discriminator | 1111 | | |
| Skip indicator | 0000 | | |
| Message type | '10100110'B | | |
| Delete NSSAI type | '00000001'B | Delete Configured NSSAI | |
| Configured NSSAI | 00000000 | | |

Table 9.1.4.1.3.3-11: NSSAI DELETE RESPONSE (step 70, Table 9.1.4.1.3.2-1)

| Derivation path: TS 38.509 Table 6.7.1 | | | |
|--|--------------|---------|-----------|
| Information Element | Value/remark | Comment | Condition |
| Protocol discriminator | 1111 | | |
| Skip indicator | 0000 | | |
| Message type | '10100111'B | | |

9.1.4.1.3.3 Specific message contents

Table 9.1.4.1.3.3-1: CONFIGURATION UPDATE COMMAND (step 1, Table 9.1.4.1.3.2-1)

| Derivation path: TS 38.508-1 [4], Table 4.7.1-19 | | | |
|--|------------------------------|---------------------------------|-----------|
| Information Element | Value/remark | Comment | Condition |
| Configuration update indication | 0001 | Acknowledgement (ACK) requested | |
| 5G-GUTI | Other than the default value | | |

Table 9.1.4.1.3.3-2: CONFIGURATION UPDATE COMMAND (step 12, Table 9.1.4.1.3.2-1)

| Derivation path: TS 38.508-1 [4], Table 4.7.1-19 | | | |
|---|----------------------------------|---|-----------|
| Information Element | Value/remark | Comment | Condition |
| Full name for network | "C63A9BED0CB7CB31D98C56B3DD70" O | "FullName12345678", Note 1 | |
| Short name for network | "5367B85D8EC966" O | "SName123", Note 1 | |
| Local time zone | "40" O | "GMT+1", Note 1, Note 2 | |
| Universal time and local time zone | "01402131832540" O | "2010 12 April 13:38 52s GMT+1", Note 1, Note 2 | |
| Network daylight saving time | "01" O | "+1 hour adjustment for Daylight Saving Time", Note 1 | |
| Note 1: Hard coded values have been chosen to allow for consistent/comparable SS behaviour. | | | |
| Note 2: Daylight Saving Time is included in the Local Time Zone. | | | |

Table 9.1.4.1.3.3-3: REGISTRATION ACCEPT (step 31, Table 9.1.4.1.3.2-1)

| Derivation path: TS 38.508-1 [4], Table 4.7.1-7 | | | |
|---|--------------|-----------------|-----------|
| Information Element | Value/remark | Comment | Condition |
| 5GS registration result value | '001'B | 3GPP access | |
| Configured NSSAI | | | |
| S-NSSAI IEI | | S-NSSAI value 2 | |
| Length of S-NSSAI contents | '00000010'B | SST | |
| SST | '00000001'B | 2 | |
| SD | Not Present | | |
| Mapped configured SST | Not Present | | |
| Mapped configured SD | Not Present | | |
| S-NSSAI IEI | | S-NSSAI value 3 | |
| Length of S-NSSAI contents | '00000001'B | SST | |
| SST | '00000011'B | 3 | |
| SD | Not Present | | |
| Mapped configured SST | Not Present | | |
| Mapped configured SD | Not Present | | |

Table 9.1.4.1.3.3-4: CONFIGURATION UPDATE COMMAND (step 32, Table 9.1.4.1.3.2-1)

| Derivation path: TS 38.508-1 [4], Table 4.7.1-19 | | | |
|--|--------------|--|-----------|
| Information Element | Value/remark | Comment | Condition |
| Configuration update indication | 001 | Registration and Acknowledgement (ACK) requested | |

Table 9.1.4.1.3.3-5: REGISTRATION REQUEST (step 33, Table 9.1.4.1.3.2-1)

| Derivation path: TS 38.508-1 [4], Table 4.7.1-6 | | | |
|--|--------------|--------------------------|-----------|
| Information Element | Value/remark | Comment | Condition |
| 5GS registration type value | '010'B | | MOBILITY |
| Requested NSSAI | | | |
| S-NSSAI IEI | | S-NSSAI value 2 (Note 1) | |
| Length of S-NSSAI contents | '00000001'B | SST | |
| SST | '00000010'B | 2 | |
| SD | Not Present | | |
| Mapped configured SST | Not Present | | |
| Mapped configured SD | Not Present | | |
| S-NSSAI IEI | | S-NSSAI value 3 (Note 1) | |
| Length of S-NSSAI contents | '00000001'B | SST | |
| SST | '00000011'B | 3 | |
| SD | Not Present | | |
| Mapped configured SST | Not Present | | |
| Mapped configured SD | Not Present | | |
| Note 1: the Requested NSSAI IE may include either S-NSSAI value 2, or S-NSSAI value 3, or S-NSSAI value 2 and S-NSSAI value 3. | | | |

Table 9.1.4.1.3.3-6: REGISTRATION ACCEPT (step 43, Table 9.1.4.1.3.2-1)

| Derivation path: TS 38.508-1 [4], Table 4.7.1-7 | | | |
|---|--------------|-----------------|-----------|
| Information Element | Value/remark | Comment | Condition |
| 5GS registration result value | '001'B | 3GPP access | |
| Allowed NSSAI | | | |
| S-NSSAI IEI | | S-NSSAI value 1 | |
| Length of S-NSSAI contents | '00000001'B | SST | |
| SST | '00000001'B | 1 | |
| SD | Not Present | | |
| Mapped configured SST | Not Present | | |
| Mapped configured SD | Not Present | | |
| S-NSSAI IEI | | S-NSSAI value 2 | |
| Length of S-NSSAI contents | '00000001'B | SST | |
| SST | '00000010'B | 2 | |
| SD | Not Present | | |
| Mapped configured SST | Not Present | | |
| Mapped configured SD | Not Present | | |
| S-NSSAI IEI | | S-NSSAI value 3 | |
| Length of S-NSSAI contents | '00000001'B | SST | |
| SST | '00000011'B | 3 | |
| SD | Not Present | | |
| Mapped configured SST | Not Present | | |
| Mapped configured SD | Not Present | | |

Table 9.1.4.1.3.3-7: CONFIGURATION UPDATE COMMAND (step 46, Table 9.1.4.1.3.2-1)

| Derivation path: TS 38.508-1 [4], Table 4.7.1-19 | | | |
|--|--------------|---------------------------------|-----------|
| Information Element | Value/remark | Comment | Condition |
| Configuration update indication | 0001 | Acknowledgement (ACK) requested | |
| Allowed NSSAI | | | |
| S-NSSAI IEI | | S-NSSAI value 1 | |
| Length of S-NSSAI contents | '00000001'B | SST | |
| SST | '00000001'B | 1 | |
| SD | Not Present | | |
| Mapped configured SST | Not Present | | |
| Mapped configured SD | Not Present | | |
| S-NSSAI IEI | | S-NSSAI value 2 | |
| Length of S-NSSAI contents | '00000001'B | SST | |
| SST | '00000010'B | 2 | |
| SD | Not Present | | |
| Mapped configured SST | Not Present | | |
| Mapped configured SD | Not Present | | |

Table 9.1.4.1.3.3-8: REGISTRATION ACCEPT (step 64, Table 9.1.4.1.3.2-1)

| Derivation path: TS 38.508-1 [4], Table 4.7.1-7 | | | |
|---|--------------|-----------------|-----------|
| Information Element | Value/remark | Comment | Condition |
| 5GS registration result value | '001'B | 3GPP access | |
| Configured NSSAI | | | |
| S-NSSAI IEI | | S-NSSAI value 2 | |
| Length of S-NSSAI contents | '00000001'B | SST | |
| SST | '00000010'B | 2 | |
| SD | Not Present | | |
| Mapped configured SST | Not Present | | |
| Mapped configured SD | Not Present | | |
| S-NSSAI IEI | | S-NSSAI value 3 | |
| Length of S-NSSAI contents | '00000001'B | SST | |
| SST | '00000011'B | 3 | |
| SD | Not Present | | |
| Mapped configured SST | Not Present | | |
| Mapped configured SD | Not Present | | |

Table 9.1.4.1.3.3-9: CONFIGURATION UPDATE COMMAND (step 66, Table 9.1.4.1.3.2-1)

| Derivation path: TS 38.508-1 [4], Table 4.7.1-19 | | | |
|--|--------------|--------------------------------------|-----------|
| Information Element | Value/remark | Comment | Condition |
| Configuration update indication | 0001 | Acknowledgement (ACK) requested | |
| Network slicing indication | 0001 | Network slicing subscription changed | |

9.1.5 Registration

9.1.5.1 Initial Registration

9.1.5.1.1 Initial registration / Success / 5G-GUTI reallocation, Last visited TAI

9.1.5.1.1.1 Test Purpose (TP)

(1)

```
with { the UE is 5GMM-REGISTERED state with no valid 5G-GUTI but available SUCI }
ensure that {
  when { the UE is switched off and switched on }
  then { the UE sends a REGISTRATION REQUEST message including the SUCI in the 5GS mobile identity IE }
}
```

(2)

```
with { the UE is 5GMM-REGISTERED state with a cell belong to a non-equivalent PLMN with assigned 5G-GUTI and last visited registered TAI }
ensure that {
  when { the UE is switched off and switched on with a cell belong to another PLMN }
  then { the UE sends a REGISTRATION REQUEST message including the 5G-GUTI assigned by the last PLMN in the 5GS mobile identity IE and the last visited registered TAI }
}
```

(3)

```
with { the UE is 5GMM-REGISTERED state with a cell belong to an equivalent PLMN with assigned 5G-GUTI }
ensure that {
  when { the UE is switched off and switched on with a cell belong to another PLMN }
  then { the UE sends a REGISTRATION REQUEST message including the 5G-GUTI assigned by the equivalent PLMN in the 5GS mobile identity IE }
}
```

}

(4)

```
with { the UE is 5GMM-REGISTERED state with an assigned 5G-GUTI }
ensure that {
  when { the UE is switched off and switched on with a cell belong to the same PLMN }
  then { the UE sends a REGISTRATION REQUEST message including the 5G-GUTI assigned by the last
registered PLMN in the 5GS mobile identity IE }
}
```

9.1.5.1.1.2 Conformance requirements

References: The conformance requirements covered in the current TC are specified in: TS 24.501 clauses 5.5.1.2.2 and 5.5.1.2.4. Unless otherwise stated these are Rel-15 requirements.

[TS 24.501, clause 5.5.1.2.2]

The UE initiates the registration procedure for initial registration by sending a REGISTRATION REQUEST message to the AMF, starting timer T3510. If timer T3502 is currently running, the UE shall stop timer T3502. If timer T3511 is currently running, the UE shall stop timer T3511.

During initial registration the UE handles the 5GS mobile identity IE in the following order:

- b) if the UE holds a valid 5G-GUTI that was previously assigned, over 3GPP access or non-3GPP access, by the same PLMN with which the UE is performing the registration, the UE shall indicate the 5G-GUTI in the 5GS mobile identity IE;
- c) if the UE holds a valid 5G-GUTI that was previously assigned, over 3GPP access or non-3GPP access, by an equivalent PLMN, the UE shall indicate the 5G-GUTI in the 5GS mobile identity IE;
- d) if the UE holds a valid 5G-GUTI that was previously assigned, over 3GPP access or non-3GPP, by any other PLMN, the UE shall indicate the 5G-GUTI in the 5GS mobile identity IE;
- e) if a SUCI is available the UE shall include the SUCI in the 5GS mobile identity IE; and

...

If the SUCI is included in the 5GS mobile identity IE and the timer T3519 is not running, the UE shall start timer T3519 and store the value of the SUCI sent in the REGISTRATION REQUEST message. The UE shall include the stored SUCI in the REGISTRATION REQUEST message while timer T3519 is running.

...

If the last visited registered TAI is available, the UE shall include the last visited registered TAI in the REGISTRATION REQUEST message.

9.1.5.1.1.3 Test description

9.1.5.1.1.3.1 Pre-test conditions

System Simulator:

- NGC Cell A, NGC Cell C and NGC Cell H are configured according to Table 6.3.2.2-1 and Table 6.3.2.2-3 in 38.508-1 [4].

UE:

- None.

Preamble:

- The UE is in test state 0N-B according to TS 38.508-1 [4].

9.1.5.1.1.3.2 Test procedure sequence

Table 9.1.5.1.1.3.2-1: Main behaviour

| St | Procedure | Message Sequence | | TP | Verdict |
|---------|---|------------------|----------------------|----|---------|
| | | U – S | Message | | |
| 1 | The SS configures:
- NGC Cell A as the "Serving cell".
- NGC Cell H and NGC Cell C as the "Non-Suitable "off" cell". | - | - | - | - |
| 2 | The UE is switched on. | - | - | - | - |
| - | The following messages are to be observed on NGC Cell A unless explicitly stated otherwise. | - | - | - | - |
| 3-5 | The UE establishes RRC connection by executing steps 2-4 of Table 4.5.2.2-2 in TS38.508-1 [4]. | - | - | - | - |
| 6 | SS transmits an REGISTRATION REJECT message with the 5GMM cause IE setting as "Illegal UE".
NOTE1: 5G-GUTI-1 should be deleted, then UE has no valid 5G-GUTI but available SUCI now. | <-- | REGISTRATION REJECT | - | - |
| 7 | The generic test procedure in TS 38.508-1 Table 4.9.6.4-1 of Switch off procedure in State DEREGISTERED are performed. | | | | |
| 8 | The UE is brought back to operation or the USIM is inserted. | | | | |
| 9-11 | The UE establishes RRC connection by executing steps 2-4 of Table 4.5.2.2-2 in TS38.508-1 [4]. | - | - | - | - |
| 12 | Check: Does the UE transmit an REGISTRATION REQUEST message including the SUCI in the 5GS mobile identity IE? | --> | REGISTRATION REQUEST | 1 | P |
| 13-21 | Steps 5-13 of Table 4.5.2.2-2 of the generic procedure in TS 38.508-1 [4] are performed. | - | - | - | - |
| 22 | SS transmits an REGISTRATION ACCEPT message with a new assigned 5G-GUTI-2. | <-- | REGISTRATION ACCEPT | - | - |
| 23-27a1 | Steps 15-19a1 of Table 4.5.2.2-2 of the generic procedure in TS 38.508-1 [4] are performed. | - | - | - | - |
| 28 | The generic test procedure in TS 38.508-1 Table 4.9.6.3-1 of Switch off procedure in RRC_CONNECTED are performed. | - | - | - | - |
| 29 | The SS configures:
- NGC Cell H as the "Serving cell".
- NGC Cell A and NGC Cell C as a "Non-Suitable "off" cell". | - | - | - | - |
| 30 | The UE is brought back to operation or the USIM is inserted. | - | - | - | - |
| - | The following messages are to be observed on NGC Cell H unless explicitly stated otherwise. | - | - | - | - |
| 31-33 | The UE establishes RRC connection by executing steps 2-4 of Table 4.5.2.2-2 in TS38.508-1 [4]. | - | - | - | - |
| 34 | Check: Does the UE transmit an REGISTRATION REQUEST message including the 5G-GUTI-2 assigned by the last PLMN in the 5GS mobile identity IE and the last visited registered TAI? | --> | REGISTRATION REQUEST | 2 | P |
| 35-43 | Steps 5-13 of Table 4.5.2.2-2 of the generic procedure in TS 38.508-1 [4] are performed. | - | - | - | - |
| 44 | SS transmits an REGISTRATION ACCEPT message with a new assigned 5G-GUTI-3 and the PLMN of NGC Cell A as Equivalent PLMNs. | <-- | REGISTRATION ACCEPT | - | - |
| 45- | Steps 15-19a1 of Table 4.5.2.2-2 of the | - | - | - | - |

| | | | | | |
|-----------------|---|-----|----------------------|---|---|
| 49a
1 | generic procedure in TS 38.508-1 [4] are performed. | | | | |
| 50 | The generic test procedure in TS 38.508-1 Table 4.9.6.3-1 of Switch off procedure in RRC_CONNECTED is performed. | - | - | - | - |
| 51 | The SS configures:
- NGC Cell A as the "Serving cell".
- NGC Cell H and NGC Cell C as a "Non-Suitable "off" cell". | - | - | - | - |
| 52 | The UE is brought back to operation or the USIM is inserted. | - | - | - | - |
| - | The following messages are to be observed on NGC Cell A unless explicitly stated otherwise. | - | - | - | - |
| 53-
55 | The UE establishes an RRC connection by executing steps 2-4 of Table 4.5.2.2-2 in TS38.508-1 [4]. | - | - | - | - |
| 56 | Check: Does the UE transmit an REGISTRATION REQUEST message including the 5G-GUTI-3 assigned by the equivalent PLMN in the 5GS mobile identity IE? | --> | REGISTRATION REQUEST | 3 | P |
| 57-
65 | Steps 5-13 of Table 4.5.2.2-2 of the generic procedure in TS 38.508-1 [4] are performed. | - | - | - | - |
| 66 | SS transmits an REGISTRATION ACCEPT message with a new assigned 5G-GUTI-4. | <-- | REGISTRATION ACCEPT | - | - |
| 67-
71a
1 | Steps 15-19a1 of Table 4.5.2.2-2 of the generic procedure in TS 38.508-1 [4] are performed. | - | - | - | - |
| 72 | The generic test procedure in TS 38.508-1 Table 4.9.6.3-1 of Switch off procedure in RRC_CONNECTED is performed. | - | - | - | - |
| 73 | The SS configures:
- NGC Cell C as the "Serving cell".
- NGC Cell A and NGC Cell H as a "Non-Suitable off cell". | - | - | - | - |
| 74 | The UE is brought back to operation or the USIM is inserted. | - | - | - | - |
| - | The following messages are to be observed on NGC Cell C unless explicitly stated otherwise. | - | - | - | - |
| 75-
77 | The UE establishes an RRC connection by executing steps 2-4 of Table 4.5.2.2-2 in TS38.508-1 [4]. | - | - | - | - |
| 78 | Check: Does the UE transmit an REGISTRATION REQUEST message including the 5G-GUTI-4 assigned by last registered PLMN in the 5GS mobile identity IE? | --> | REGISTRATION REQUEST | 4 | P |
| 79-
94 | Steps 5-20 of Table 4.5.2.2-2 of the generic procedure in TS 38.508-1 [4] are performed. | - | - | - | - |

9.1.5.1.1.3.3 Specific message contents

Table 9.1.5.1.1.3.3-1: Message REGISTRATION REJECT (step 6, Table 9.1.5.1.1.3.2-1)

| Derivation path: TS 38.508-1 [4], table 4.7.1-9 | | | |
|---|--------------|------------|-----------|
| Information Element | Value/Remark | Comment | Condition |
| 5GMM cause | '0000 0011'B | Illegal UE | |

Table 9.1.5.1.1.3.3-2: Message REGISTRATION REQUEST (step 12, Table 9.1.5.1.1.3.2-1)

| Derivation path: TS 38.508-1 [4], table 4.7.1-6 | | | |
|---|--------------|----------------------|-----------|
| Information Element | Value/Remark | Comment | Condition |
| 5GS registration type | '0000 0001'B | Initial registration | |
| 5GS mobile identity | SUCI | The SUCI of UE | |

Table 9.1.5.1.1.3.3-3: Message REGISTRATION ACCEPT (step 22, Table 9.1.5.1.1.3.2-1)

| Derivation path: TS 38.508-1 [4], table 4.7.1-7 | | | |
|---|--------------|---------|-----------|
| Information Element | Value/Remark | Comment | Condition |
| 5G-GUTI | 5G-GUTI-2 | | |

Table 9.1.5.1.1.3.3-4: Message REGISTRATION REQUEST (step 34, Table 9.1.5.1.1.3.2-1)

| Derivation path: TS 38.508-1 [4], table 4.7.1-6 | | | |
|---|--------------|----------------------|-----------|
| Information Element | Value/Remark | Comment | Condition |
| 5GS registration type | '0000 0001'B | Initial registration | |
| 5GS mobile identity | 5G-GUTI-2 | | |
| Last visited registered TAI | TAI-1 | TAI of NGC Cell A | |

Table 9.1.5.1.1.3.3-5: Message REGISTRATION ACCEPT (step 44, Table 9.1.5.1.1.3.2-1)

| Derivation path: TS 38.508-1 [4], table 4.7.1-7 | | | |
|---|---------------------------|---------|-----------|
| Information Element | Value/Remark | Comment | Condition |
| 5G-GUTI | 5G-GUTI-3 | | |
| Equivalent PLMNs | The PLMN ID of NGC Cell A | | |

Table 9.1.5.1.1.3.3-6: Message REGISTRATION REQUEST (step 56, Table 9.1.5.1.1.3.2-1)

| Derivation path: TS 38.508-1 [4], table 4.7.1-6 | | | |
|---|--------------|----------------------|-----------|
| Information Element | Value/Remark | Comment | Condition |
| 5GS registration type | '0000 0001'B | Initial registration | |
| 5GS mobile identity | 5G-GUTI-3 | | |
| Last visited registered TAI | TAI-8 | TAI of NGC Cell H | |

Table 9.1.5.1.1.3.3-7: Message REGISTRATION ACCEPT (step 66, Table 9.1.5.1.1.3.2-1)

| Derivation path: TS 38.508-1 [4], table 4.7.1-7 | | | |
|---|--------------|---------|-----------|
| Information Element | Value/Remark | Comment | Condition |
| 5G-GUTI | 5G-GUTI-4 | | |

Table 9.1.5.1.1.3.3-8: Message REGISTRATION REQUEST (step 78, Table 9.1.5.1.1.3.2-1)

| Derivation path: TS 38.508-1 [4], table 4.7.1-6 | | | |
|---|--------------|----------------------|-----------|
| Information Element | Value/Remark | Comment | Condition |
| 5GS registration type | '0000 0001'B | Initial registration | |
| 5GS mobile identity | 5G-GUTI-4 | | |
| Last visited registered TAI | TAI-1 | TAI of NGC Cell A | |

9.1.5.1.2 Initial registration / 5GS services / Equivalent PLMN list handling

9.1.5.1.2.1 Test Purpose (TP)

(1)

```
with { The UE in 5GMM-REGISTERED-INITIATED state }
ensure that {
  when { UE receives a REGISTRATION ACCEPT with a new set of Equivalent PLMNs, then after Switch OFF
and Switch ON }
  then { The UE deletes the old equivalent PLMN list and uses the new equivalent PLMN list }
}
```

(2)

```
with { The UE in 5GMM-REGISTERED-INITIATED state }
ensure that {
  when { UE receives a REGISTRATION ACCEPT that does not include Equivalent PLMNs, then after Switch
OFF and Switch ON }
  then { UE deletes the old equivalent PLMN list }
}
```

(3)

```
with { The UE in 5GMM-REGISTERED-INITIATED state }
ensure that {
  when { the UE receives a REGISTRATION ACCEPT that includes equivalent PLMN list, and the UE
detects that an entry in the equivalent PLMN list is also present in forbidden PLMN list }
  then { UE deletes the entry in equivalent PLMN list that is also present in forbidden PLMN list
}
}
```

9.1.5.1.2.2 Conformance requirements

References: The conformance requirements covered in the present TC are specified in: TS 24.501, clauses 5.5.1.2.4 and 5.5.1.3.4. Unless otherwise stated these are Rel-15 requirements.

[TS 24.501, clause 5.5.1.2.4]

...

The AMF may also include a list of equivalent PLMNs in the REGISTRATION ACCEPT message. Each entry in the list contains a PLMN code (MCC+MNC). The UE shall store the list as provided by the network, and if the initial registration procedure is not for emergency services, the UE shall remove from the list any PLMN code that is already in the list of "forbidden PLMNs". In addition, the UE shall add to the stored list the PLMN code of the registered PLMN that sent the list. The UE shall replace the stored list on each receipt of the REGISTRATION ACCEPT message. If the REGISTRATION ACCEPT message does not contain a list, then the UE shall delete the stored list.

...

[TS 24.501, clause 5.5.1.3.4]

...

The AMF may also include a list of equivalent PLMNs in the REGISTRATION ACCEPT message. Each entry in the list contains a PLMN code (MCC+MNC). The UE shall store the list as provided by the network, and if there is no emergency PDU session established, the UE shall remove from the list any PLMN code that is already in the list of "forbidden PLMNs". If the UE is not registered for emergency services and there is an emergency PDU session established, the UE shall remove from the list of equivalent PLMNs any PLMN code present in the "forbidden PLMNs list" when the emergency PDU session is released. In addition, the UE shall add to the stored list the PLMN code of the registered PLMN that sent the list. The UE shall replace the stored list on each receipt of the REGISTRATION ACCEPT message. If the REGISTRATION ACCEPT message does not contain a list, then the UE shall delete the stored list.

...

9.1.5.1.2.3 Test description

9.1.5.1.2.3.1 Pre-test conditions

System Simulator:

- NGC Cell A and NGC Cell E and NGC Cell F are configured according to Table 6.3.2.2-1 and Table 6.3.2.2-3 in TS 38.508-1 [4].
- NGC Cell F is configured with NR frequency NRf3.
- System information combination NR-4 as defined in TS 38.508 [4] clause 4.4.3.1.2 is used.

UE:

None.

Preamble:

- The UE is in state Switched OFF (State 0-A) as per TS 38.508-1 [4] Table 4.4A.2-0.

9.1.5.1.2.3.2 Test procedure sequence

Table 9.1.5.1.2.3.2-1: Main behaviour

| St | Procedure | Message Sequence | | TP | Verdict |
|---------|---|------------------|---------------------|----|---------|
| | | U - S | Message | | |
| 1 | The SS configures:
- NGC Cell F as the "Serving cell".
- NGC Cell E as the "Non-Suitable "off" cell".
- NGC Cell A as the "Non-Suitable "off" cell". | - | - | - | - |
| 2 | The UE is Switched ON | - | - | - | - |
| - | The following messages are to be observed on NGC Cell F unless explicitly stated otherwise | - | - | - | - |
| 3-14 | Steps 2-13 of Table 4.5.2.2-2 of the generic procedure in TS 38.508-1 [4] are performed. | - | - | - | - |
| 15 | SS transmits a REGISTRATION ACCEPT message with PLMN ID of NGC Cell A included in the Equivalent PLMNs IE | <- | REGISTRATION ACCEPT | - | - |
| 16-20a1 | Steps 15-19a1 of Table 4.5.2.2-2 of the generic procedure in TS 38.508-1 [4] are performed. | - | - | - | - |
| 21 | The UE is switched off by executing generic procedure in Table 4.9.6.3-1 in TS 38.508-1 [4] | - | - | - | - |
| 22 | The UE is Switched ON | - | - | - | - |
| 23-34 | Steps 2-13 of Table 4.5.2.2-2 of the generic procedure in TS 38.508-1 [4] are performed. | - | - | - | - |
| 35 | SS transmits a REGISTRATION ACCEPT message with PLMN ID of NGC Cell E included in the Equivalent PLMNs IE | <- | REGISTRATION ACCEPT | - | - |
| 36-40a1 | Steps 15-19a1 of Table 4.5.2.2-2 of the generic procedure in TS 38.508-1 [4] are performed. | - | - | - | - |
| 41 | The UE is switched off by executing generic procedure in Table 4.9.6.3-1 in TS 38.508-1 [4]. | - | - | - | - |
| 42 | The SS configures:
- NGC Cell F as the "Non-Suitable "off" cell".
- NGC Cell E as the "Suitable neighbour cell".
- NGC Cell A as the "Serving cell". | - | - | - | - |
| 43 | The UE is Switched ON. | - | - | - | - |
| - | The following messages are to be observed on NGC Cell E unless explicitly stated otherwise | - | - | - | - |
| 44-62a1 | Steps 2-20a1 of Table 4.5.2.2-2 of the generic procedure in TS 38.508-1 [4] are performed. | - | - | 1 | P |
| 63 | The UE is switched off by executing generic procedure in Table 4.9.6.1-1 in TS 38.508-1 [4]. | - | - | - | - |
| 63 A | The SS configures:
- NGC Cell F as the "Serving cell".
- NGC Cell E as the "Non-Suitable "off" cell".
- NGC Cell A as the "Suitable neighbour cell". | - | - | - | - |
| 64 | The UE is Switched ON | - | - | - | - |
| - | The following messages are to be observed on NGC Cell A unless explicitly stated otherwise | - | - | - | - |
| 64 A | Steps 2-19a1 of Table 4.5.2.2-2 of the generic procedure in TS 38.508-1 [4] are performed. | - | - | 2 | P |
| 64 B | The UE is switched off by executing generic procedure in Table 4.9.6.3-1 in TS 38.508-1 [4]. | - | - | - | - |
| 64 C | The SS configures:
- NGC Cell A as the "Non-Suitable "off" cell". | - | - | - | - |
| 64 D | The UE is Switched ON. | - | - | - | - |
| 65-76 | Steps 2-13 of Table 4.5.2.2-2 of the generic procedure in TS 38.508-1 [4] are performed. | - | - | 2 | P |
| 76 | Void. | - | - | - | - |

| | | | | | |
|-----------|---|-----|---------------------|---|---|
| A | | | | | |
| 77 | SS transmits a REGISTRATION REJECT with cause #11 (PLMN not allowed) | <-- | REGISTRATION REJECT | - | - |
| 78 | The SS releases the RRC connection | - | - | - | - |
| 79 | The SS configures:
- NGC Cell A as the "Serving cell".
- NGC Cell E as the "Non-Suitable "off" cell ".
- NGC Cell F as the "Non-Suitable "off" cell ". | - | - | - | - |
| - | The following messages are to be observed on NGC Cell A unless explicitly stated otherwise | - | - | - | - |
| 80-93 | Steps 2-13 of Table 4.5.5.2.2- 2 of the generic procedure in TS 38.508-1 [4] are performed. | - | - | - | - |
| 94 | SS transmits a REGISTRATION ACCEPT message with PLMN ID of NGC Cell E and NGC Cell F included in the Equivalent PLMNs IE | <-- | REGISTRATION ACCEPT | - | - |
| 95-99a1 | Steps 15-19a1 of Table 4.5.2.2-2 of the generic procedure in TS 38.508-1 [4] are performed. | - | - | - | - |
| 100 | The UE is switched off by executing generic procedure in Table 4.9.6.3-1 in TS 38.508-1 [4]. | - | - | - | - |
| 101 | The SS configures:
- NGC Cell A as the "Non-Suitable "off" cell ".
- NGC Cell E as the "Suitable neighbour cell".
- NGC Cell F as the "Serving cell". | - | - | - | - |
| - | The following messages are to be observed on NGC Cell E unless explicitly stated otherwise | - | - | - | - |
| 102 | The UE is Switched ON | - | - | - | - |
| 103-121a1 | Steps 2-20a1 of Table 4.5.2.2-2 of the generic procedure in TS 38.508-1 [4] are performed. | - | - | 3 | P |
| 122 | The UE is switched off by executing generic procedure in Table 4.9.6.1-1 in TS 38.508-1 [4]. | - | - | - | - |
| 123 | The SS configures:
- NGC Cell A as the "Non-Suitable "off" cell ".
- NGC Cell E as the "Non-Suitable "off" cell ".
- NGC Cell F as the "Serving cell". | - | - | - | - |
| 124 | The UE is Switched ON | - | - | - | - |
| - | The user is prompted to manually select PLMN of NGC Cell F | - | - | - | - |
| - | The following messages are to be observed on NGC Cell F unless explicitly stated otherwise | - | - | - | - |
| 125-143a1 | Steps 2-20a1 of Table 4.5.2.2-2 of the generic procedure in TS 38.508-1 [4] are performed. | - | - | - | - |
| 144 | The user sets the UE in Automatic PLMN selection mode. | - | - | - | - |

9.1.5.1.2.3.3 Specific message contents

Table 9.1.5.1.2.3.3-1: REGISTRATION ACCEPT (step 15 Table 9.1.5.1.2.3.2-1)

| Derivation Path: TS 38.508-1 [4], Table 4.7.1-7 | | | |
|---|------------------|-----------------------|-----------|
| Information Element | Value/remark | Comment | Condition |
| Equivalent PLMNs | MCC=003, MNC=101 | PLMN ID of NGC Cell A | |

Table 9.1.5.1.2.3.3-2: REGISTRATION ACCEPT (step 35 Table 9.1.5.1.2.3.2-1)

| Derivation Path: TS 38.508-1 [4], Table 4.7.1-7 | | | |
|---|------------------|-----------------------|-----------|
| Information Element | Value/remark | Comment | Condition |
| Equivalent PLMNs | MCC=002, MNC=101 | PLMN ID of NGC Cell E | |

Table 9.1.5.1.2.3.3-3: REGISTRATION ACCEPT (step 94 Table 9.1.5.1.2.3.2-1)

| Derivation Path: TS 38.508-1 [4], Table 4.7.1-7 | | | |
|---|---------------------------------------|---|-----------|
| Information Element | Value/remark | Comment | Condition |
| Equivalent PLMNs | MCC=003, MNC=101 and MCC=002, MNC=101 | PLMN ID of NGC Cell F and PLMN ID of NGC Cell E | |

Table 9.1.5.1.2.3.3-4: REGISTRATION REJECT (step 77 Table 9.1.5.1.2.3.2-1)

| Derivation Path: TS 38.508-1 [4], Table 4.7.1-9 | | | |
|---|--------------|------------------|-----------|
| Information Element | Value/remark | Comment | Condition |
| 5GMM Cause | '0000 1011'B | PLMN not allowed | |

9.1.5.1.3 Initial registration / 5GS services / NSSAI handling

9.1.5.1.3.1 Test Purpose (TP)

(1)

```
with { UE has sent a REGISTRATION REQUEST message including Requested NSSAI}
ensure that {
  when { UE receives REGISTRATION ACCEPT message with Allowed NSSAI }
  then { UE shall replace any stored allowed NSSAI for the current PLMN with new allowed NSSAI for the current PLMN }
}
```

(2)

```
with { UE has sent a REGISTRATION REQUEST message including Requested NSSAI}
ensure that {
  when { UE receives REGISTRATION ACCEPT message with Rejected NSSAI with reject cause "S-NSSAI not available in the current PLMN" }
  then { UE shall add the rejected S-NSSAI(s) in the rejected NSSAI for the current PLMN and not attempt to use the Rejected NSSAI in the current PLMN until switching off the UE or the UICC containing the USIM is removed }
}
```

(3)

```
with { UE receives REGISTRATION ACCEPT message with Rejected NSSAI with reject cause "S-NSSAI not available in the current PLMN" }
ensure that {
  when { UE has been switched off, then switched on }
  then { UE shall delete the stored Rejected NSAAI and shall send the NSSAI in Requested NSSAI IE of the REGISTRATION REQUEST message as per the configured and Allowed NSSAI for current PLMN }
}
```

(4)

```
with { UE has sent a REGISTRATION REQUEST message including Requested NSSAI}
ensure that {
  when { UE receives REGISTRATION ACCEPT message with Rejected NSSAI with reject cause "S-NSSAI not available in the current registration area" }
  then { UE shall add the rejected S-NSSAI(s) in the rejected NSSAI for the current PLMN and registration area combination and not attempt to use the Rejected NSSAI in the current registration area until switching off the UE, the UE moving out of the current registration area or the UICC containing the USIM is removed }
}
```

}

(5)

```

with { UE receives REGISTRATION ACCEPT message with Rejected NSSAI with reject cause "S-NSSAI not
available in the current registration area" }
ensure that {
  when { UE has been moved out of the current registration area }
  then { UE shall delete the stored Rejected NSAAI for the current PLMN as well as registration
area combination and shall send the NSSAI in Requested NSSAI IE of the REGISTRATION REQUEST message
as per the configured and Allowed NSSAI for current PLMN }
}

```

9.1.5.1.3.2 Conformance requirements

References: The conformance requirements covered in the present TC are specified in: TS 24.501 [22], clause 5.5.1.2.2 and 5.5.1.2.4. Unless otherwise stated these are Rel-15 requirements.

[TS 24.501 clause 5.5.1.2.2]

The UE shall include the requested NSSAI containing the S-NSSAI(s) corresponding to the slice(s) to which the UE wants to register and shall include the mapping of the requested NSSAI which is the mapping of each S-NSSAI of the requested NSSAI to the S-NSSAI(s) of the HPLMN, if available, in the REGISTRATION REQUEST message. If the UE has allowed NSSAI or configured NSSAI for the current PLMN, the requested NSSAI shall be either:

- a) the configured NSSAI for the current PLMN, or a subset thereof as described below, if the UE has no allowed NSSAI for the current PLMN;
- b) the allowed NSSAI for the current PLMN, or a subset thereof as described below, if the UE has an allowed NSSAI for the current PLMN; or
- c) the allowed NSSAI for the current PLMN, or a subset thereof as described below, plus one or more S-NSSAIs from the configured NSSAI for which no corresponding S-NSSAI is present in the allowed NSSAI and those are neither in the rejected NSSAI for the current PLMN nor in the rejected NSSAI for the current PLMN and registration area combination.

If the UE has neither allowed NSSAI for the current PLMN nor configured NSSAI for the current PLMN and has a default configured NSSAI, the UE shall:

- a) include the S-NSSAI(s) in the Requested NSSAI IE of the REGISTRATION REQUEST message using the default configured NSSAI; and
- b) include the Network slicing indication IE with the Default configured NSSAI indication bit set to "Requested NSSAI created from default configured NSSAI" in the REGISTRATION REQUEST message.

If the UE has no allowed NSSAI for the current PLMN, no configured NSSAI for the current PLMN, and no default configured NSSAI, the UE shall not include a requested NSSAI in the REGISTRATION message.

The subset of configured NSSAI provided in the requested NSSAI consists of one or more S-NSSAIs in the configured NSSAI applicable to the current PLMN, if the S-NSSAI is neither in the rejected NSSAI for the current PLMN nor in the rejected NSSAI for the current PLMN and registration area combination.

The subset of allowed NSSAI provided in the requested NSSAI consists of one or more S-NSSAIs in the allowed NSSAI for the current PLMN.

NOTE 3: How the UE selects the subset of configured NSSAI or allowed NSSAI to be provided in the requested NSSAI is implementation.

NOTE 4: The number of S-NSSAI(s) included in the requested NSSAI cannot exceed eight.

[TS 24.501 clause 5.5.1.2.4]

The AMF shall include the allowed NSSAI for the current PLMN and shall include the mapping of each S-NSSAI of the allowed NSSAI to the S-NSSAI(s) of the HPLMN contained in the requested NSSAI from the UE if available, in the REGISTRATION ACCEPT message if the UE included the requested NSSAI in the REGISTRATION REQUEST message and the AMF allows one or more S-NSSAIs in the requested NSSAI. The AMF may also include rejected

NSSAI in the REGISTRATION ACCEPT message. Rejected NSSAI contains S-NSSAI(s) which was included in the requested NSSAI but rejected by the network associated with rejection cause(s).

The AMF may include a new configured NSSAI for the current PLMN in the REGISTRATION ACCEPT message if:

- a) the REGISTRATION REQUEST message did not include the requested NSSAI;
- b) the REGISTRATION REQUEST message included the requested NSSAI containing an S-NSSAI that is not valid in the serving PLMN; or
- c) the REGISTRATION REQUEST message included the Network slicing indication IE with the Default configured NSSAI indication bit set to "Requested NSSAI created from default configured NSSAI".

If a new configured NSSAI for the current PLMN is included in the REGISTRATION ACCEPT message, the AMF shall also include the mapping of the configured NSSAI for the current PLMN the S-NSSAI(s) of the to HPLMN if available in the REGISTRATION ACCEPT message. In this case the AMF shall start timer T3550 and enter state 5GMM-COMMON-PROCEDURE-INITIATED as described in subclause 5.1.3.2.3.3.

The AMF shall include the Network slicing indication IE with the Network slicing subscription change indication set to "Network slicing subscription changed" in the REGISTRATION ACCEPT message if the UDM has indicated that the subscription data for network slicing has changed. In this case the AMF shall start timer T3550 and enter state 5GMM-COMMON-PROCEDURE-INITIATED as described in subclause 5.1.3.2.3.3.

The UE receiving the rejected NSSAI in the REGISTRATION ACCEPT message takes the following actions based on the rejection cause in the rejected NSSAI:

"S-NSSAI not available in the current PLMN"

The UE shall add the rejected S-NSSAI(s) in the rejected NSSAI for the current PLMN as specified in subclause 4.6.2.2 and not attempt to use this S-NSSAI in the current PLMN until switching off the UE or the UICC containing the USIM is removed.

"S-NSSAI not available in the current registration area"

The UE shall add the rejected S-NSSAI(s) in the rejected NSSAI for the current PLMN and registration area combination as specified in subclause 4.6.2.2 and not attempt to use this S-NSSAI in the current registration area until switching off the UE, the UE moving out of the current registration area or the UICC containing the USIM is removed.

If the UE did not include the requested NSSAI in the REGISTRATION REQUEST message or none of the requested NSSAI are present in the subscribed S-NSSAIs, and one or more subscribed S-NSSAIs (containing one or more S-NSSAIs each of which may be associated with a new S-NSSAI) marked as default are available, the AMF shall put the subscribed S-NSSAIs marked as default in the allowed NSSAI of the REGISTRATION ACCEPT message. The AMF shall determine a registration area such that all S-NSSAIs of the allowed NSSAI are available in the registration area.

9.1.5.1.3.3 Test description

9.1.5.1.3.3.1 Pre-test conditions

System Simulator:

- NGC Cell A belongs to Home PLMN and TAI-1 and set as serving cell;
- NGC Cell B belongs to Home PLMN and TAI-2 and set as Non-Suitable "Off" cell.
- NGC Cell C belongs to Home PLMN and TAI-3 and set as Non-Suitable "Off" cell.

UE:

- UE is previously registered on NGC Cell A using default message contents according to TS 38.508-1 [4];
- Empty URSP Configuration.

Preamble:

- The UE is in state Switched OFF (state 0N-B) according to TS 38.508-1 [4].

9.1.5.1.3.3.2 Test procedure sequence

Table 9.1.5.1.3.3.2-1: Main behaviour

| St | Procedure | Message Sequence | | TP | Verdict |
|-------|--|------------------|-----------------------|----|---------|
| | | U - S | Message | | |
| 1 | The UE is switched on. | - | - | - | - |
| 2 | Check: Does UE transmit a REGISTRATION REQUEST message? | --> | REGISTRATION REQUEST | - | - |
| 3-11 | Steps 5 to 13 of the generic procedure for NR RRC_IDLE specified in TS 38.508-1 subclause 4.5.2 are performed. | - | - | - | - |
| 12 | The SS transmits a REGISTRATION ACCEPT message including Allowed NSSAI and Configured NSSAI. | <-- | REGISTRATION ACCEPT | - | - |
| 13-18 | Steps 15 to 20a1 of the generic procedure for NR RRC_IDLE specified in TS 38.508-1 subclause 4.5.2 are performed. | - | - | - | - |
| 19 | Switch off procedure in RRC_IDLE specified in TS 38.508-1 subclause 4.9.6.1 is performed. | - | - | - | - |
| 20 | The UE is brought back to operation or the USIM is inserted. | - | - | - | - |
| 21 | Check: Does UE transmit a REGISTRATION REQUEST message including Requested NSSAI? | --> | REGISTRATION REQUEST | 1 | P |
| 22-30 | Steps 5 to 13 of the generic procedure for NR RRC_IDLE specified in TS 38.508-1 subclause 4.5.2 are performed. | - | - | - | - |
| 31 | The SS transmits a REGISTRATION ACCEPT message including Allowed NSSAI and Rejected NSSAI. | <-- | REGISTRATION ACCEPT | - | - |
| 32-37 | Steps 15 to 20a1 of the generic procedure for NR RRC_IDLE specified in TS 38.508-1 subclause 4.5.2 are performed. | - | - | - | - |
| 38 | The SS configures NGC Cell A as a "Non-suitable cell" and NGC Cell C as the "Serving cell". | - | - | - | - |
| 39 | Check: Does UE transmit a REGISTRATION REQUEST message including Requested NSSAI on NGC Cell C? | --> | REGISTRATION REQUEST | 2 | P |
| 40-48 | Void. | - | - | - | - |
| 49 | The SS transmits a REGISTRATION ACCEPT message including Allowed NSSAI. | <-- | REGISTRATION ACCEPT | - | - |
| 50 | The UE transmits a REGISTRATION COMPLETE message. | --> | REGISTRATION COMPLETE | - | - |
| 51 | The SS transmits an <i>RRCRelease</i> message. | - | - | - | - |
| 52 | Check: Is S-NSSAI=2 in the Rejected NSSAI list with cause "S-NSSAI not available in the current PLMN" associated with current PLMN using AT/MMI? | - | - | 2 | P |
| 53 | Switch off procedure in RRC_IDLE specified in TS 38.508-1 subclause 4.9.6.1 is performed. | - | - | - | - |
| 54 | The UE is brought back to operation or the USIM is inserted. | - | - | - | - |
| 55 | Check: Does UE transmit a REGISTRATION REQUEST message including Requested NSSAI? | --> | REGISTRATION REQUEST | 3 | P |
| 56-64 | Steps 5 to 13 of the generic procedure for NR RRC_IDLE specified in TS 38.508-1 subclause 4.5.2 are performed. | - | - | - | - |
| 65 | The SS transmits a REGISTRATION ACCEPT message including Allowed NSSAI and Rejected NSSAI. | <-- | REGISTRATION ACCEPT | - | - |
| 66-71 | Steps 15 to 20a1 of the generic procedure for NR RRC_IDLE specified in TS 38.508-1 subclause 4.5.2 are performed. | - | - | - | - |

| | | | | | |
|--|---|-----|-----------------------|---|---|
| 72 | Check: Is S-NSSAI=2 removed from the Rejected NSSAI list associated with current PLMN? | - | - | 3 | P |
| 72A | Check: Is S-NSSAI=1 in the Rejected NSSAI list with cause "S-NSSAI not available in the current registration area" associated with current PLMN and registration area combination using AT/MMI? | - | - | 4 | P |
| 73 | The SS configures NGC Cell C as the "Non-suitable cell" and NGC Cell B as the "Serving cell". | - | - | - | - |
| 74 | Wait for 34s for FR1 or 130s for FR2 to allow UE to recognise the change, then the generic test procedure in TS 38.508-1 Table 4.9.4.2.2-1 is performed to indicate that UE camp on Cell B. (Note 1). | - | - | - | - |
| 75-86 | Void | - | - | - | - |
| 87 | Check: Is S-NSSAI=1 in the Rejected NSSAI list with cause "S-NSSAI not available in the current registration area" associated with current PLMN and registration area combination using AT/MMI? | - | - | 4 | P |
| 88 | The SS configures NGC Cell B as the "Non-suitable cell" and NGC Cell A as the "Serving cell". | - | - | - | - |
| 89 | Check: Does UE transmit a REGISTRATION REQUEST message including Requested NSSAI? | --> | REGISTRATION REQUEST | 5 | P |
| 90-98 | Void | - | - | - | - |
| 99 | The SS transmits a REGISTRATION ACCEPT message including Allowed NSSAI. | <-- | REGISTRATION ACCEPT | - | - |
| 100 | The UE transmits a REGISTRATION COMPLETE message. | --> | REGISTRATION COMPLETE | - | - |
| 101 | The SS transmits an <i>RRCRelease</i> message. | - | - | - | - |
| 102 | Check: Is S-NSSAI=1 removed from the Rejected NSSAI list associated with current PLMN and registration area combination? | - | - | 5 | P |
| <p>Note 1: The wait time for reselection to a newly detected intra frequency cell is selected to cover $T_{\text{detect,NR_Intra}}$ ($25 \times 1280\text{ms} = 32\text{s}$ for FR1 and $25 \times 4 \times 1280\text{ms} = 128\text{s}$ for FR2) + $T_{\text{SI-NR}}$ (1.28s for FR1 and FR2) = 33.28s rounded up to 34s for FR1 and 129.28s rounded up to 130s for FR2.</p> | | | | | |

9.1.5.1.3.3.3 Specific message contents

Table 9.1.5.1.3.3.3-1: REGISTRATION REQUEST (step 2, Table 9.1.5.1.3.3.2-1)

| Derivation path: TS 38.508-1 Table 4.7.1-6 | | | |
|--|--------------|----------------------|-----------|
| Information Element | Value/remark | Comment | Condition |
| 5GS registration type value | '001'B | Initial registration | |
| Requested NSSAI | | Note | |
| S-NSSAI IEI | | S-NSSAI value 1 | Note |
| Length of S-NSSAI contents | '00000001'B | SST | |
| SST | '00000001'B | 1 | |
| SD | Not Present | | |
| Mapped configured SST | Not Present | | |
| Mapped configured SD | Not Present | | |
| <p>Note: S-NSSAI =1 will be always included from the allowed NSSAI list associated with PLMN of NCG Cell A by the UE but may include other S-NSSAI from Configured NSSAI list associated with PLMN of NCG Cell A if configured in the UE. See TS 24.501 clause 5.5.1.2.1</p> | | | |

Table 9.1.5.1.3.3.2: REGISTRATION ACCEPT (step 12, Table 9.1.5.1.3.3.2-1)

| Derivation path: TS 38.508-1 Table 4.7.1-7 | | | |
|--|--------------|-----------------|-----------|
| Information Element | Value/remark | Comment | Condition |
| 5GS registration result value | '001'B | 3GPP access | |
| Allowed NSSAI | | | |
| S-NSSAI IEI | | S-NSSAI value 1 | |
| Length of S-NSSAI contents | '00000001'B | SST | |
| SST | '00000010'B | 2 | |
| SD | Not Present | | |
| Mapped configured SST | Not Present | | |
| Mapped configured SD | Not Present | | |
| Configured NSSAI | | | |
| S-NSSAI IEI | | S-NSSAI value 1 | |
| Length of S-NSSAI contents | '00000001'B | SST | |
| SST | '00000001'B | 1 | |
| SD | Not Present | | |
| Mapped configured SST | Not Present | | |
| Mapped configured SD | Not Present | | |
| S-NSSAI IEI | | S-NSSAI value 2 | |
| Length of S-NSSAI contents | '00000001'B | SST | |
| SST | '00000010'B | 2 | |
| SD | Not Present | | |
| Mapped configured SST | Not Present | | |
| Mapped configured SD | Not Present | | |

Table 9.1.5.1.3.3.3: PDU SESSION ESTABLISHMENT ACCEPT (step 14 , Table 9.1.5.1.3.3.2-1)

| Derivation path: TS 38.508-1 clause 4.7.2-2 | | | |
|---|--------------|-------------|-----------|
| Information Element | Value/remark | Comment | Condition |
| S-NSSAI | | | |
| Length of S-NSSAI contents | '0000 0001'B | SST | |
| SST | '0000 0010'B | SST value 2 | |

Table 9.1.5.1.3.3.4: REGISTRATION REQUEST (step 21, Table 9.1.5.1.3.3.2-1)

| Derivation path: TS 38.508-1 Table 4.7.1-6 | | | |
|--|--|----------------------|-----------|
| Information Element | Value/remark | Comment | Condition |
| 5GS registration type value | '001'B | Initial registration | |
| Requested NSSAI | | Note | |
| S-NSSAI IEI | | S-NSSAI value 1 | |
| Length of S-NSSAI contents | '00000001'B | SST | |
| SST | '00000010'B | 2 | |
| SD | Not Present | | |
| Mapped configured SST | Not Present | | |
| Mapped configured SD | Not Present | | |
| S-NSSAI IEI | | S-NSSAI value 2 | Note |
| Length of S-NSSAI contents | '00000001'B | SST | |
| SST | '00000001'B | 1 | |
| SD | Not Present | | |
| Mapped configured SST | Not Present | | |
| Mapped configured SD | Not Present | | |
| Note: | S-NSSAI =2 will be always included by the UE from the allowed NSSAI list associated with PLMN of NCG Cell A but may include S-NSSAI =1 from Configured NSSAI list associated with PLMN of NCG Cell A. See TS 24.501 sub-clause 5.5.1.2.1 | | |

Table 9.1.5.1.3.3.3-5: REGISTRATION ACCEPT (step 31, Table 9.1.5.1.3.3.2-1)

| Derivation path: TS 38.508-1 Table 4.7.1-7 | | | |
|--|--------------|---|-----------|
| Information Element | Value/remark | Comment | Condition |
| 5GS registration result value | '001'B | 3GPP access | |
| Allowed NSSAI | | Note | |
| S-NSSAI IEI | | S-NSSAI value 1 | Note |
| Length of S-NSSAI contents | '00000001'B | SST | |
| SST | '00000001'B | 1 | |
| SD | Not Present | | |
| Mapped configured SST | Not Present | | |
| Mapped configured SD | Not Present | | |
| Rejected NSSAI | | | |
| Rejected S-NSSAI-1 | | Rejected S-NSSAI value 1 | |
| Cause value | '0000'B | S-NSSAI not available in the current PLMN | |
| SST | '00000010'B | 2 | |
| SD | Not Present | | |
| Note: If UE has requested only S-NSSAI =2 in step 21 and S-NSSAI =2 is added in the Rejected NSSAI list by the SS then AMF/SS can include default subscribed S-NSSAIs in the allowed NSSAI of REGISTRATION ACCEPT message, see TS 24.501 sub-clause 5.5.1.2.4. | | | |

Table 9.1.5.1.3.3.3-6: REGISTRATION REQUEST (step 39, Table 9.1.5.1.3.3.2-1)

| Derivation path: TS 38.508-1 Table 4.7.1-6 | | | |
|--|--------------|--------------------------------|-----------|
| Information Element | Value/remark | Comment | Condition |
| 5GS registration type value | '010'B | mobility registration updating | |
| Requested NSSAI | | | |
| S-NSSAI IEI | | S-NSSAI value 1 | |
| Length of S-NSSAI contents | '00000001'B | SST | |
| SST | '00000001'B | 1 | |
| SD | Not Present | | |
| Mapped configured SST | Not Present | | |
| Mapped configured SD | Not Present | | |

Table 9.1.5.1.3.3.3-7: REGISTRATION ACCEPT (step 49, Table 9.1.5.1.3.3.2-1)

| Derivation path: TS 38.508-1 Table 4.7.1-7 | | | |
|--|--------------|-----------------|-----------|
| Information Element | Value/remark | Comment | Condition |
| 5GS registration result value | '001'B | 3GPP access | |
| Allowed NSSAI | | | |
| S-NSSAI IEI | | S-NSSAI value 1 | |
| Length of S-NSSAI contents | '00000001'B | SST | |
| SST | '00000001'B | 1 | |
| SD | Not Present | | |
| Mapped configured SST | Not Present | | |
| Mapped configured SD | Not Present | | |

Table 9.1.5.1.3.3.3-8: REGISTRATION REQUEST (step 55, Table 9.1.5.1.3.3.2-1)

| Derivation path: TS 38.508-1 Table 4.7.1-6 | | | |
|--|--|----------------------|-----------|
| Information Element | Value/remark | Comment | Condition |
| 5GS registration type value | '001'B | Initial registration | |
| Requested NSSAI | | Note | |
| S-NSSAI IEI | | S-NSSAI value 1 | Note |
| Length of S-NSSAI contents | '00000001'B | SST | |
| SST | '00000001'B | 1 | |
| SD | Not Present | | |
| Mapped configured SST | Not Present | | |
| Mapped configured SD | Not Present | | |
| S-NSSAI IEI | | S-NSSAI value 1 | |
| Length of S-NSSAI contents | '00000001'B | SST | |
| SST | '00000010'B | 2 | |
| SD | Not Present | | |
| Mapped configured SST | Not Present | | |
| Mapped configured SD | Not Present | | |
| Note: | S-NSSAI =1 will be always included by the UE from the allowed NSSAI list associated with PLMN of NCG Cell C but may include S-NSSAI =2 from Configured NSSAI list associated with PLMN of NCG Cell C. See TS 24.501 sub-clause 5.5.1.2.1 | | |

Table 9.1.5.1.3.3.3-9: REGISTRATION ACCEPT (step 65, Table 9.1.5.1.3.3.2-1)

| Derivation path: TS 38.508-1 Table 4.7.1-7 | | | |
|--|--|---|-----------|
| Information Element | Value/remark | Comment | Condition |
| 5GS registration result value | '001'B | 3GPP access | |
| TAI list | | | |
| Type of list | '01'B | list of TACs belonging to one PLMN, with consecutive TAC values | |
| Number of elements | '00001'B | 2 Elements | |
| TAC | PLMN =MCC/MNC stored in EF _{IMSI}
TAC 1 = 2 | TAI-2, TAI-3 | |
| Allowed NSSAI | | | |
| S-NSSAI IEI | | S-NSSAI value 1 | |
| Length of S-NSSAI contents | '00000001'B | SST | |
| SST | '00000010'B | 2 | |
| SD | Not Present | | |
| Mapped configured SST | Not Present | | |
| Mapped configured SD | Not Present | | |
| Rejected NSSAI | | | |
| Rejected S-NSSAI-1 | | Rejected S-NSSAI value 1 | |
| Cause value | '0001'B | S-NSSAI not available in the current registration area | |
| SST | '00000001'B | 1 | |
| SD | Not Present | | |
| Note: | If UE has requested only S-NSSAI =1 in step 55 and S-NSSAI =1 is added in the Rejected NSSAI list by the SS then AMF/SS can include default subscribed S-NSSAIs in the allowed NSSAI of REGISTRATION ACCEPT message, see TS 24.501 sub-clause 5.5.1.2.4. | | |

Table 9.1.5.1.3.3.3-10: PDU SESSION ESTABLISHMENT ACCEPT (step 67 , Table 9.1.5.1.3.3.2-1)

| Derivation path: TS 38.508-1 clause 4.7.2-2 | | | |
|---|--------------|-------------|-----------|
| Information Element | Value/remark | Comment | Condition |
| S-NSSAI | | | |
| Length of S-NSSAI contents | '0000 0001'B | SST | |
| SST | '0000 0010'B | SST value 2 | |

Table 9.1.5.1.3.3.3-11: Void**Table 9.1.5.1.3.3.3-12: Void****Table 9.1.5.1.3.3.3-13: REGISTRATION REQUEST (step 89, Table 9.1.5.1.3.3.2-1)**

| Derivation path: TS 38.508-1 Table 4.7.1-6 | | | |
|--|--|--------------------------------|-----------|
| Information Element | Value/remark | Comment | Condition |
| 5GS registration type value | '010'B | mobility registration updating | |
| Requested NSSAI | | Note | |
| S-NSSAI IEI | | S-NSSAI value 1 | |
| Length of S-NSSAI contents | '00000001'B | SST | |
| SST | '00000010'B | 2 | |
| SD | Not Present | | |
| Mapped configured SST | Not Present | | |
| Mapped configured SD | Not Present | | |
| S-NSSAI IEI | | S-NSSAI value 1 | |
| Length of S-NSSAI contents | '00000001'B | SST | |
| SST | '00000001'B | 1 | |
| SD | Not Present | | |
| Mapped configured SST | Not Present | | |
| Mapped configured SD | Not Present | | |
| Note: | S-NSSAI =2 will be always included by the UE from the allowed NSSAI list associated with PLMN of NCG Cell A but may include S-NSSAI =1 from Configured NSSAI list associated with PLMN of NCG Cell A. See TS 24.501 sub-clause 5.5.1.2.1 | | |

Table 9.1.5.1.3.3.3-14: REGISTRATION ACCEPT (step 99, Table 9.1.5.1.3.3.2-1)

| Derivation path: TS 38.508-1 Table 4.7.1-7 | | | |
|--|--|-----------------|-----------|
| Information Element | Value/remark | Comment | Condition |
| 5GS registration result value | '001'B | 3GPP access | |
| Allowed NSSAI | | | |
| S-NSSAI IEI | | S-NSSAI value 1 | |
| Length of S-NSSAI contents | '00000001'B | SST | |
| SST | '00000010'B | 2 | |
| SD | Not Present | | |
| Mapped configured SST | Not Present | | |
| Mapped configured SD | Not Present | | |
| S-NSSAI IEI | | S-NSSAI value 2 | Note |
| Length of S-NSSAI contents | '00000001'B | SST | |
| SST | '00000001'B | 1 | |
| SD | Not Present | | |
| Mapped configured SST | Not Present | | |
| Mapped configured SD | Not Present | | |
| Note: | SS will send allowed NSSAIs based on the Requested NSSAIs sent by UE in step 89. | | |

9.1.5.1.3a Initial registration / 5GS services / NSSAI handling / NSSAI Storage

9.1.5.1.3a.1 Test Purpose (TP)

(1)

```

with { UE is switched off with a valid USIM inserted }
ensure that {
  when { UE has configured NSSAI associated with HPLMN, configured NSSAI associated with a current
  PLMN with mapping to the Configured NSSAI for the HPLMN and UE is powered up or switched on }
  then { UE transmits REGISTRATION REQUEST message with Requested NSSAI using the configured NSSAI
  associated with current PLMN and mapping of each S-NSSAI of the requested NSSAI to the S-NSSAIs of
  the configured NSSAI for the HPLMN }
}

```

(2)

```

with { UE is switched off with a valid USIM inserted }
ensure that {
  when { UE has neither allowed NSSAI for the current PLMN nor configured NSSAI for the current PLMN
  and has a default configured NSSAI and UE is powered up or switched on }
  then { UE transmits REGISTRATION REQUEST message with Requested NSSAI using the default
  configured NSSAI and also includes Network slicing indication IE with the Default configured NSSAI
  indication bit set to "Requested NSSAI created from default configured NSSAI" }
}

```

(3)

```

with { UE is switched off with a valid USIM inserted }
ensure that {
  when { UE has no allowed NSSAI for the current PLMN, no configured NSSAI for the current PLMN, and
  no configured NSSAI not associated with a PLMN and UE is powered up or switched on }
  then { UE transmits REGISTRATION REQUEST message and does not include a Requested NSSAI }
}

```

9.1.5.1.3a.2 Conformance requirements

References: The conformance requirements covered in the present TC are specified in: TS 24.501, clause 5.5.1.2.2 and 5.5.1.2.4.

[TS 24.501 clause 5.5.1.2.2]

5.5.1.2.1 General

This procedure can be used by a UE for initial registration for 5GS services.

...

The UE shall include the requested NSSAI containing the S-NSSAI(s) corresponding to the slice(s) to which the UE wants to register and shall include the mapping of the requested NSSAI which is the mapping of each S-NSSAI of the requested NSSAI to the S-NSSAI(s) of the HPLMN, if available, in the REGISTRATION REQUEST message. If the UE has allowed NSSAI or configured NSSAI for the current PLMN, the requested NSSAI shall be either:

- a) the configured NSSAI for the current PLMN, or a subset thereof as described below, if the UE has no allowed NSSAI for the current PLMN;
- b) the allowed NSSAI for the current PLMN, or a subset thereof as described below, if the UE has an allowed NSSAI for the current PLMN; or
- c) the allowed NSSAI for the current PLMN, or a subset thereof as described below, plus one or more S-NSSAIs from the configured NSSAI for which no corresponding S-NSSAI is present in the allowed NSSAI and those are neither in the rejected NSSAI for the current PLMN nor in the rejected NSSAI for the current PLMN and registration area combination.

If the UE has neither allowed NSSAI for the current PLMN nor configured NSSAI for the current PLMN and has a default configured NSSAI, the UE shall:

- a) include the S-NSSAI(s) in the Requested NSSAI IE of the REGISTRATION REQUEST message using the default configured NSSAI; and
- b) include the Network slicing indication IE with the Default configured NSSAI indication bit set to "Requested NSSAI created from default configured NSSAI" in the REGISTRATION REQUEST message.

If the UE has no allowed NSSAI for the current PLMN, no configured NSSAI for the current PLMN, and no default configured NSSAI, the UE shall not include a requested NSSAI in the REGISTRATION message.

The subset of configured NSSAI provided in the requested NSSAI consists of one or more S-NSSAIs in the configured NSSAI applicable to the current PLMN, if the S-NSSAI is neither in the rejected NSSAI for the current PLMN nor in the rejected NSSAI for the current PLMN and registration area combination.

The subset of allowed NSSAI provided in the requested NSSAI consists of one or more S-NSSAIs in the allowed NSSAI for the current PLMN.

NOTE 3: How the UE selects the subset of configured NSSAI or allowed NSSAI to be provided in the requested NSSAI is implementation.

NOTE 4: The number of S-NSSAI(s) included in the requested NSSAI cannot exceed eight.

[TS 24.501 clause 5.5.1.2.4]

The AMF shall include the allowed NSSAI for the current PLMN and shall include the mapping of each S-NSSAI of the allowed NSSAI to the S-NSSAI(s) of the HPLMN contained in the requested NSSAI from the UE if available, in the REGISTRATION ACCEPT message if the UE included the requested NSSAI in the REGISTRATION REQUEST message and the AMF allows one or more S-NSSAIs in the requested NSSAI. The AMF may also include rejected NSSAI in the REGISTRATION ACCEPT message. Rejected NSSAI contains S-NSSAI(s) which was included in the requested NSSAI but rejected by the network associated with rejection cause(s).

The AMF may include a new configured NSSAI for the current PLMN in the REGISTRATION ACCEPT message if:

- a) the REGISTRATION REQUEST message did not include the requested NSSAI;
- b) the REGISTRATION REQUEST message included the requested NSSAI containing an S-NSSAI that is not valid in the serving PLMN; or
- c) the REGISTRATION REQUEST message included the Network slicing indication IE with the Default configured NSSAI indication bit set to "Requested NSSAI created from default configured NSSAI".

If a new configured NSSAI for the current PLMN is included in the REGISTRATION ACCEPT message, the AMF shall also include the mapping of the configured NSSAI for the current PLMN the S-NSSAI(s) of the to HPLMN if available in the REGISTRATION ACCEPT message. In this case the AMF shall start timer T3550 and enter state 5GMM-COMMON-PROCEDURE-INITIATED as described in subclause 5.1.3.2.3.3.

The AMF shall include the Network slicing indication IE with the Network slicing subscription change indication set to "Network slicing subscription changed" in the REGISTRATION ACCEPT message if the UDM has indicated that the subscription data for network slicing has changed. In this case the AMF shall start timer T3550 and enter state 5GMM-COMMON-PROCEDURE-INITIATED as described in subclause 5.1.3.2.3.3.

The UE receiving the rejected NSSAI in the REGISTRATION ACCEPT message takes the following actions based on the rejection cause in the rejected NSSAI:

"S-NSSAI not available in the current PLMN"

The UE shall add the rejected S-NSSAI(s) in the rejected NSSAI for the current PLMN as specified in subclause 4.6.2.2 and not attempt to use this S-NSSAI in the current PLMN until switching off the UE or the UICC containing the USIM is removed.

"S-NSSAI not available in the current registration area"

The UE shall add the rejected S-NSSAI(s) in the rejected NSSAI for the current PLMN and registration area combination as specified in subclause 4.6.2.2 and not attempt to use this S-NSSAI in the current registration area until switching off the UE, the UE moving out of the current registration area or the UICC containing the USIM is removed.

If the UE did not include the requested NSSAI in the REGISTRATION REQUEST message or none of the requested NSSAI are present in the subscribed S-NSSAIs, and one or more subscribed S-NSSAIs (containing one or more S-NSSAIs each of which may be associated with a new S-NSSAI) marked as default are available, the AMF shall put the subscribed S-NSSAIs marked as default in the allowed NSSAI of the REGISTRATION ACCEPT message. The AMF shall determine a registration area such that all S-NSSAIs of the allowed NSSAI are available in the registration area.

9.1.5.1.3a.3 Test description

9.1.5.1.3a.3.1 Pre-test conditions

System Simulator:

- NGC Cell G is configured according to Table 6.3.2.2-1 and Table 6.3.2.2-3 in 38.508-1 [4] except that frequency NRf1 replaces NRf2.
- NGC Cell G belongs to VPLMN, TAI-7 and set as serving cell.

UE:

- None

Preamble:

- The UE is in state Switched OFF (state 0N-B) according to TS 38.508-1 [4] and camped on NGC Cell A HPLMN.

9.1.5.1.3a.3.2 Test procedure sequence

Table 9.1.5.1.3a.3.2-1: Main behaviour

| St | Procedure | Message Sequence | | TP | Verdict |
|-------|--|------------------|-----------------------|----|---------|
| | | U - S | Message | | |
| 1 | The UE is switched on. | | | - | - |
| 2 | The UE transmits REGISTRATION REQUEST message on NGC Cell G. | --> | REGISTRATION REQUEST | - | - |
| 3-11 | Steps 5 to 13 of the generic procedure for NR RRC_IDLE specified in TS 38.508-1 subclause 4.5.2.2-2 are performed. | - | - | - | - |
| 12 | The SS transmits REGISTRATION ACCEPT message including Configured and Allowed NSSAI lists. | <<-- | REGISTRATION ACCEPT | - | - |
| 13-18 | Steps 15 to 20a1 of the generic procedure for NR RRC_IDLE specified in TS 38.508-1 subclause 4.5.2.2-2 are performed with 'connected without release'. | - | - | - | - |
| 19 | The SS transmits NSSAI DELETE REQUEST message to delete the Allowed NSSAI list for all PLMNs (MCC-MNC =000-000) and for 3GPP access so UE has only configured NSSAI. | <<-- | NSSAI DELETE REQUEST | - | - |
| 20 | UE transmits NSSAI DELETE RESPONSE message. | --> | NSSAI DELETE RESPONSE | - | - |
| 21 | The SS transmits an <i>RRCR</i> Release message. | - | - | - | - |
| 22 | Switch off procedure in RRC_Idle specified in TS 38.508-1 subclause 4.9.6.1 is performed. | - | - | - | - |
| 23 | The UE is brought back to operation or the USIM is inserted. | - | - | - | - |
| 24 | Check: Does UE transmit a REGISTRATION REQUEST message including Requested NSSAI? | --> | REGISTRATION REQUEST | 1 | P |
| 25-33 | Steps 5 to 13 of the generic procedure for NR RRC_IDLE specified in TS 38.508-1 subclause 4.5.2.2-2 are performed. | - | - | - | - |
| 34 | The SS transmits a REGISTRATION ACCEPT message including Allowed NSSAI. | <<-- | REGISTRATION ACCEPT | - | - |
| 35-40 | Steps 15 to 20a1 of the generic procedure for NR RRC_IDLE specified in TS 38.508-1 subclause 4.5.2.2-2 are performed with 'connected without release'. | - | - | - | - |
| 41 | The SS transmits NSSAI DELETE REQUEST message to delete the Default Configured NSSAI list. | <<-- | NSSAI DELETE REQUEST | - | - |
| 42 | UE transmits NSSAI DELETE RESPONSE message. | --> | NSSAI DELETE RESPONSE | - | - |
| 43 | Use AT command and set Default Configured NSSAI to 1 & 2. | - | - | - | - |
| 44 | The SS transmits NSSAI DELETE REQUEST message to delete the Configured NSSAI list for all PLMNs (MCC-MNC =000-000). | <<-- | NSSAI DELETE REQUEST | - | - |
| 45 | UE transmits NSSAI DELETE RESPONSE message. | --> | NSSAI DELETE RESPONSE | - | - |
| 46 | The SS transmits NSSAI DELETE REQUEST message to delete the Allowed NSSAI list for all PLMNs (MCC-MNC =000-000). | <<-- | NSSAI DELETE REQUEST | - | - |
| 47 | UE transmits NSSAI DELETE RESPONSE message. | --> | NSSAI DELETE RESPONSE | - | - |
| 48 | The SS transmits an <i>RRCR</i> Release message. | - | - | - | - |
| 49 | Switch off procedure in RRC_Idle specified in TS 38.508-1 subclause 4.9.6.1 is performed | - | - | - | - |
| 50 | The UE is brought back to operation or the USIM is inserted. | - | - | - | - |
| 51 | Check: Does UE transmit a REGISTRATION REQUEST message including Requested | --> | REGISTRATION REQUEST | 2 | P |

| | | | | | |
|-------|--|-----|-----------------------|---|---|
| | NSSAI? | | | | |
| 52-60 | Steps 5 to 13 of the generic procedure for NR RRC_IDLE specified in TS 38.508-1 subclause 4.5.2.2-2 are performed. | - | - | - | - |
| 61 | The SS transmits a REGISTRATION ACCEPT message including Allowed NSSAI. | <-- | REGISTRATION ACCEPT | - | - |
| 62-67 | Steps 15 to 20a1 of the generic procedure for NR RRC_IDLE specified in TS 38.508-1 subclause 4.5.2.2-2 are performed with 'connected without release'. | - | - | - | - |
| 68 | The SS transmits NSSAI DELETE REQUEST message to delete the Default Configured NSSAI list. | <-- | NSSAI DELETE REQUEST | - | - |
| 69 | UE transmits NSSAI DELETE RESPONSE message. | --> | NSSAI DELETE RESPONSE | - | - |
| 70 | The SS transmits NSSAI DELETE REQUEST message to delete the Configured NSSAI list for all PLMNs (MCC-MNC =000-000). | <-- | NSSAI DELETE REQUEST | - | - |
| 71 | UE transmits NSSAI DELETE RESPONSE message. | --> | NSSAI DELETE RESPONSE | - | - |
| 72 | The SS transmits NSSAI DELETE REQUEST message to delete the Allowed NSSAI list for all PLMNs (MCC-MNC =000-000). | <-- | NSSAI DELETE REQUEST | - | - |
| 73 | UE transmits NSSAI DELETE RESPONSE message. | --> | NSSAI DELETE RESPONSE | - | - |
| 74 | The SS transmits an <i>RRRelease</i> message. | - | - | - | - |
| 75 | Switch off procedure in RRC_Idle specified in TS 38.508-1 subclause 4.9.6.1 is performed. | - | - | - | - |
| 76 | The UE is brought back to operation or the USIM is inserted. | - | - | - | - |
| 77 | Check: Does UE transmit a REGISTRATION REQUEST message not including Requested NSSAI? | --> | REGISTRATION REQUEST | 3 | P |
| 78-93 | Steps 5 to 20a1 of the generic procedure for NR RRC_IDLE specified in TS 38.508-1 subclause 4.5.2.2-2 are performed. | - | - | - | - |

9.1.5.1.3a.3.3 Specific message contents

Table 9.1.5.1.3a.3.3-1: REGISTRATION ACCEPT (Preamble)

| Derivation path: TS 38.508-1 Table 4.7.1-7 | | | |
|--|--------------|-----------------|-----------|
| Information Element | Value/remark | Comment | Condition |
| 5GS registration result value | '001'B | 3GPP access | |
| Allowed NSSAI | | | |
| S-NSSAI IEI | | S-NSSAI value 1 | |
| Length of S-NSSAI contents | '00000001'B | SST | |
| SST | '00000001'B | 1 | |
| SD | Not Present | | |
| Mapped configured SST | Not Present | | |
| Mapped configured SD | Not Present | | |
| Configured NSSAI | | | |
| S-NSSAI IEI | | S-NSSAI value 1 | |
| Length of S-NSSAI contents | '00000001'B | SST | |
| SST | '00000001'B | 1 | |
| SD | Not Present | | |
| Mapped configured SST | Not Present | | |
| Mapped configured SD | Not Present | | |
| S-NSSAI IEI | | S-NSSAI value 2 | |
| Length of S-NSSAI contents | '00000001'B | SST | |
| SST | '00000010'B | 2 | |
| SD | Not Present | | |
| Mapped configured SST | Not Present | | |
| Mapped configured SD | Not Present | | |

Table 9.1.5.1.3a.3.3-2: REGISTRATION ACCEPT (step 12, Table 9.1.5.1.3a.3.2-1)

| Derivation path: TS 38.508-1 Table 4.7.1-7 | | | |
|--|--------------|-------------------------------|-----------|
| Information Element | Value/remark | Comment | Condition |
| 5GS registration result value | '001'B | 3GPP access | |
| Allowed NSSAI | | | |
| S-NSSAI IEI | | S-NSSAI value 1 | |
| Length of S-NSSAI contents | '00000001'B | SST | |
| SST | '00000100'B | 4 | |
| SD | Not Present | | |
| Mapped configured SST | Not Present | | |
| Mapped configured SD | Not Present | | |
| Configured NSSAI | | | |
| S-NSSAI IEI | | S-NSSAI value 1 | |
| Length of S-NSSAI contents | '00000010'B | SST and mapped configured SST | |
| SST | '00000100'B | 4 | |
| SD | Not Present | | |
| Mapped configured SST | '00000001'B | 1 | |
| Mapped configured SD | Not Present | | |
| S-NSSAI IEI | | S-NSSAI value 2 | |
| Length of S-NSSAI contents | '00000010'B | SST and mapped configured SST | |
| SST | '00000101'B | 5 | |
| SD | Not Present | | |
| Mapped configured SST | '00000010'B | 2 | |
| Mapped configured SD | Not Present | | |

Table 9.1.5.1.3a.3.3-3: NSSAI DELETE REQUEST (step 19, Table 9.1.5.1.3a.3.2-1)

| Derivation path: TS 38.509 Table 6.7.1 | | | |
|--|--------------|----------------------|-----------|
| Information Element | Value/remark | Comment | Condition |
| Protocol discriminator | 1111 | | |
| Skip indicator | 0000 | | |
| Message type | '10000110' | | |
| Delete NSSAI type | '00000010' | Delete Allowed NSSAI | |
| Allowed NSSAI | 000000 | All PLMNs (3 Octets) | |
| | 00 | 3GPP access | |

Table 9.1.5.1.3a.3.3-4: NSSAI DELETE RESPONSE (step 20, Table 9.1.5.1.3a.3.2-1)

| Derivation path: TS 38.509 Table 6.7.1 | | | |
|--|--------------|---------|-----------|
| Information Element | Value/remark | Comment | Condition |
| Protocol discriminator | 1111 | | |
| Skip indicator | 0000 | | |
| Message type | '10100111' | | |

Table 9.1.5.1.3a.3.3-5: REGISTRATION REQUEST (step 24, Table 9.1.5.1.3a.3.2-1)

| Derivation path: TS 38.508-1 Table 4.7.1-6 | | | |
|--|--------------|-------------------------------|-----------|
| Information Element | Value/remark | Comment | Condition |
| 5GS registration type value | '001'B | Initial registration | |
| Requested NSSAI | | Note | |
| S-NSSAI IEI | | S-NSSAI value 1 | |
| Length of S-NSSAI contents | '0000010'B | SST and mapped configured SST | |
| SST | '00000100'B | 4 | |
| SD | Not Present | | |
| Mapped configured SST | '00000001'B | 1 | |
| Mapped configured SD | Not Present | | |
| S-NSSAI IEI | | S-NSSAI value 2 | |
| Length of S-NSSAI contents | '0000010'B | SST and mapped configured SST | |
| SST | '00000101'B | 5 | |
| SD | Not Present | | |
| Mapped configured SST | '0000010'B | 2 | |
| Mapped configured SD | Not Present | | |

Note: UE may include S-NSSAI 4 or 5 or both 4 and 5 from the configured NSSAI list associated with NGC cell G.

Table 9.1.5.1.3a.3.3-6: REGISTRATION ACCEPT (step 34, Table 9.1.5.1.3a.3.2-1)

| Derivation path: TS 38.508-1 [4], Table 4.7.1-7 | | | |
|---|--------------|-------------------------------|-----------|
| Information Element | Value/remark | Comment | Condition |
| 5GS registration result value | '001'B | 3GPP access | |
| Allowed NSSAI | | Note | |
| S-NSSAI IEI | | S-NSSAI value 1 | |
| Length of S-NSSAI contents | '0000010'B | SST and mapped configured SST | |
| SST | '00000100'B | 4 | |
| SD | Not Present | | |
| Mapped configured SST | '00000001'B | 1 | |
| Mapped configured SD | Not Present | | |
| S-NSSAI IEI | | S-NSSAI value 2 | |
| Length of S-NSSAI contents | '0000010'B | SST and mapped configured SST | |
| SST | '00000101'B | 5 | |
| SD | Not Present | | |
| Mapped configured SST | '0000010'B | 2 | |
| Mapped configured SD | Not Present | | |

Note: SS will send Allowed NSSAIs based on the Requested NSSAI sent by UE in step 24.

Table 9.1.5.1.3a.3.3-7: NSSAI DELETE REQUEST (step 41, Table 9.1.5.1.3a.3.2-1)

| Derivation path: TS 38.509 Table 6.7.1 | | | |
|--|--------------|---------------------------------|-----------|
| Information Element | Value/remark | Comment | Condition |
| Protocol discriminator | 1111 | | |
| Skip indicator | 0000 | | |
| Message type | '10000110' | | |
| Delete NSSAI type | '00000000' | Delete Default Configured NSSAI | |

Table 9.1.5.1.3a.3.3-8: NSSAI DELETE RESPONSE (step 42, Table 9.1.5.1.3a.3.2-1)

| Derivation path: TS 38.509 Table 6.7.1 | | | |
|--|--------------|---------|-----------|
| Information Element | Value/remark | Comment | Condition |
| Protocol discriminator | 1111 | | |
| Skip indicator | 0000 | | |
| Message type | '10100111' | | |

Table 9.1.5.1.3a.3.3-9: NSSAI DELETE REQUEST (step 44, Table 9.1.5.1.3a.3.2-1)

| Derivation path: TS 38.509 Table 6.7.1 | | | |
|--|--------------|-------------------------|-----------|
| Information Element | Value/remark | Comment | Condition |
| Protocol discriminator | 1111 | | |
| Skip indicator | | | |
| Message type | '10000110' | | |
| Delete NSSAI type | '00000001' | Delete Configured NSSAI | |
| Configured NSSAI | 00000000 | All PLMNs | |

Table 9.1.5.1.3a.3.3-10: NSSAI DELETE RESPONSE (step 45, Table 9.1.5.1.3a.3.2-1)

| Derivation path: TS 38.509 Table 6.7.1 | | | |
|--|--------------|---------|-----------|
| Information Element | Value/remark | Comment | Condition |
| Protocol discriminator | 1111 | | |
| Skip indicator | 0000 | | |
| Message type | '10100111' | | |

Table 9.1.5.1.3a.3.3-11: NSSAI DELETE REQUEST (step 46, Table 9.1.5.1.3a.3.2-1)

| Derivation path: TS 38.509 Table 6.7.1 | | | |
|--|--------------|----------------------|-----------|
| Information Element | Value/remark | Comment | Condition |
| Protocol discriminator | 1111 | | |
| Skip indicator | 0000 | | |
| Message type | '10000110' | | |
| Delete NSSAI type | '00000010' | Delete Allowed NSSAI | |
| Allowed NSSAI | 000000 | All PLMNs (3 Octets) | |
| | 00 | 3GPP access | |

Table 9.1.5.1.3a.3.3-12: NSSAI DELETE RESPONSE (step 47, Table 9.1.5.1.3a.3.2-1)

| Derivation path: TS 38.509 Table 6.7.1 | | | |
|--|--------------|---------|-----------|
| Information Element | Value/remark | Comment | Condition |
| Protocol discriminator | 1111 | | |
| Skip indicator | 0000 | | |
| Message type | '10100111' | | |

Table 9.1.5.1.3a.3.3-13: REGISTRATION REQUEST (step 51, Table 9.1.5.1.3a.3.2-1)

| Derivation path: TS 38.508-1 Table 4.7.1-6 | | | |
|--|--------------|---|-----------|
| Information Element | Value/remark | Comment | Condition |
| 5GS registration type value | '001'B | Initial registration | |
| Requested NSSAI | | Note | |
| S-NSSAI IEI | | S-NSSAI value 1 | |
| Length of S-NSSAI contents | '00000001'B | SST | |
| SST | '00000001'B | 1 | |
| SD | Not Present | | |
| Mapped configured SST | Not Present | | |
| Mapped configured SD | Not Present | | |
| S-NSSAI IEI | | S-NSSAI value 2 | |
| Length of S-NSSAI contents | '00000001'B | SST | |
| SST | '00000010'B | 2 | |
| SD | Not Present | | |
| Mapped configured SST | Not Present | | |
| Mapped configured SD | Not Present | | |
| Network slicing indication | | | |
| Default configured NSSAI indication | 1 | Requested NSSAI created from default configured NSSAI | |

Note: UE may include either 1 or 2 or both 1 and 2 NSSAIs.

Table 9.1.5.1.3a.3.3-14: REGISTRATION ACCEPT (step 61, Table 9.1.5.1.3a.3.2-1)

| Derivation path: TS 38.508-1 [4], Table 4.7.1-7 | | | |
|---|--------------|-------------------------------|-----------|
| Information Element | Value/remark | Comment | Condition |
| 5GS registration result value | '001'B | 3GPP access | |
| Allowed NSSAI | | Note | |
| S-NSSAI IEI | | S-NSSAI value 1 | |
| Length of S-NSSAI contents | '00000010'B | SST and mapped configured SST | |
| SST | '00000001'B | 1 | |
| SD | Not Present | | |
| Mapped configured SST | '00000001'B | | |
| Mapped configured SD | Not Present | | |
| S-NSSAI IEI | | S-NSSAI value 2 | |
| Length of S-NSSAI contents | '00000010'B | SST and mapped configured SST | |
| SST | '00000010'B | 2 | |
| SD | Not Present | | |
| Mapped configured SST | '00000010'B | | |
| Mapped configured SD | Not Present | | |

Note: SS will send Allowed NSSAIs based on the Requested NSSAI sent by UE in Step 51

Table 9.1.5.1.3a.3.3-15: NSSAI DELETE REQUEST (step 68, Table 9.1.5.1.3a.3.2-1)

| Derivation path: TS 38.509 Table 6.7.1 | | | |
|--|--------------|---------------------------------|-----------|
| Information Element | Value/remark | Comment | Condition |
| Protocol discriminator | 1111 | | |
| Skip indicator | 0000 | | |
| Message type | '10000110' | | |
| Delete NSSAI type | '00000000' | Delete Default Configured NSSAI | |

Table 9.1.5.1.3a.3.3-16: NSSAI DELETE RESPONSE (step 69, Table 9.1.5.1.3a.3.2-1)

| Derivation path: TS 38.509 Table 6.7.1 | | | |
|--|--------------|---------|-----------|
| Information Element | Value/remark | Comment | Condition |
| Protocol discriminator | 1111 | | |
| Skip indicator | 0000 | | |
| Message type | '10100111' | | |

Table 9.1.5.1.3a.3.3-17: NSSAI DELETE REQUEST (step 70, Table 9.1.5.1.3a.3.2-1)

| Derivation path: TS 38.509 Table 6.7.1 | | | |
|--|--------------|-------------------------|-----------|
| Information Element | Value/remark | Comment | Condition |
| Protocol discriminator | 1111 | | |
| Skip indicator | 0000 | | |
| Message type | '10000110' | | |
| Delete NSSAI type | '00000001' | Delete Configured NSSAI | |
| Configured NSSAI | 000000 | All PLMNs (3 Octets) | |

Table 9.1.5.1.3a.3.3-18: NSSAI DELETE RESPONSE (step 71, Table 9.1.5.1.3a.3.2-1)

| Derivation path: TS 38.509 Table 6.7.1 | | | |
|--|--------------|---------|-----------|
| Information Element | Value/remark | Comment | Condition |
| Protocol discriminator | 1111 | | |
| Skip indicator | 0000 | | |
| Message type | '10100111' | | |

Table 9.1.5.1.3a.3.3-19: NSSAI DELETE REQUEST (step 72, Table 9.1.5.1.3a.3.2-1)

| Derivation path: TS 38.509 Table 6.7.1 | | | |
|--|--------------|----------------------|-----------|
| Information Element | Value/remark | Comment | Condition |
| Protocol discriminator | 1111 | | |
| Skip indicator | 0000 | | |
| Message type | '10000110' | | |
| Delete NSSAI type | '00000010' | Delete Allowed NSSAI | |
| Allowed NSSAI | 000000 | All PLMNs (3 Octets) | |
| | 00 | 3GPP access | |

Table 9.1.5.1.3a.3.3-20: NSSAI DELETE RESPONSE (step 73, Table 9.1.5.1.3a.3.2-1)

| Derivation path: TS 38.509 Table 6.7.1 | | | |
|--|--------------|---------|-----------|
| Information Element | Value/remark | Comment | Condition |
| Protocol discriminator | 1111 | | |
| Skip indicator | 0000 | | |
| Message type | '10100111' | | |

Table 9.1.5.1.3a.3.3-21: REGISTRATION REQUEST (step 77, Table 9.1.5.1.3a.3.2-1)

| Derivation path: TS 38.508-1 Table 4.7.1-6 | | | |
|--|--------------|----------------------|-----------|
| Information Element | Value/remark | Comment | Condition |
| 5GS registration type value | '001'B | Initial registration | |
| Requested NSSAI | Not Present | | |

9.1.5.1.4 Initial registration / 5GS services / MICO mode / TAI list handling

9.1.5.1.4.1 Test Purpose (TP)

(1)

```
with { The UE is in 5GMM-DEREGISTERED state and is switched off }
ensure that {
  when { the UE supports MICO mode and requests the use of MICO mode }
  then { the UE includes the MICO indication IE in the REGISTRATION REQUEST message }
}
```

(2)

```
with { The UE has received REGISTRATION ACCEPT message }
ensure that {
  when { the REGISTRATION ACCEPT message included MICO indication IE indicating "all PLMN
registration area allocated" }
  then { the UE treats all TAIs in the current PLMN as a registration area and deletes its old TAI
list }
}
```

(3)

```
with { The UE detecting a better NG cell in same PLMN }
ensure that {
  when { the UE treats all TAIs in the current PLMN as a registration area and has deleted its old
TAI list as a result of REGISTRATION ACCEPT message included MICO indication IE indicating "all PLMN
registration area allocated" }
  then { the UE does not perform the REGISTRATION procedure for mobility }
}
```

(4)

```
with { The UE detecting a better NG cell in a different PLMN }
ensure that {
  when { the UE transmits the REGISTRATION REQUEST }
  then { the UE sets the IE 5GS registration type to "mobility registration updating" and performs
a REGISTRATION procedure for Mobility }
}
```

9.1.5.1.4.2 Conformance requirements

References: The conformance requirements covered in the present TC are specified in: TS 24.501, clause 5.5.1.2.2 and 5.5.1.2.4. Unless otherwise stated these are Rel-15 requirements.

[TS 24.501, clause 5.5.1.2.2]

...

If the UE supports MICO mode and requests the use of MICO mode, then the UE shall include the MICO indication IE in the REGISTRATION REQUEST message.

...

[TS 24.501, clause 5.5.1.2.4]

...

The AMF shall include the MICO indication IE in the REGISTRATION ACCEPT message only if the MICO indication IE was included in the REGISTRATION REQUEST message, the AMF supports and accepts the use of MICO mode. If the AMF supports and accepts the use of MICO mode, the AMF may indicate "all PLMN registration area allocated" in the MICO indication IE in the REGISTRATION ACCEPT message. If "all PLMN registration area allocated" is indicated in the MICO indication IE, the AMF shall not assign and include the TAI list in the REGISTRATION ACCEPT message. If the REGISTRATION ACCEPT message included an MICO indication IE indicating "all PLMN registration area allocated", the UE shall treat all TAIs in the current PLMN as a registration area and delete its old TAI list.

...

9.1.5.1.4.3 Test description

9.1.5.1.4.3.1 Pre-test conditions

System Simulator:

- NGC Cell A, NGC Cell C and NGC Cell E are configured according to Table 6.3.2.2-1 and Table 6.3.2.2-3 in TS 38.508-1 [4].

UE:

None.

Preamble:

- The UE is in state Switched OFF (State 0-A) as per TS 38.508-1 [4] Table 4.4A.2-0.

9.1.5.1.4.3.2 Test procedure sequence

Table 9.1.5.1.4.3.2-1: Main behaviour

| St | Procedure | Message Sequence | | TP | Verdict |
|-------|--|------------------|--------------------------------|-----|---------|
| | | U - S | Message | | |
| 0 | The SS configures:
- NGC Cell A as the "Non-Suitable "off" cell".
- NGC Cell C as the "Non-Suitable "off" cell".
- NGC Cell E as the "Non-Suitable "off" cell". | | | | |
| 1 | The UE is switched ON | | | | |
| 2 | The user requests enabling of MICO mode by MMI or AT command | - | | - | - |
| 3 | The SS configures:
- NGC Cell A as the "Serving cell".
- NGC Cell C as the "Non-Suitable "off" cell".
- NGC Cell E as the "Non-Suitable "off" cell". | - | | - | - |
| 4-6 | The UE establishes an RRC connection by executing steps 2–4 of Table 4.5.2.2-2 in TS38.508-1 [4]. | - | | - | - |
| 7 | Check : Does the UE transmit a REGISTRATION REQUEST message including IE MICO indication | --> | REGISTRATION REQUEST | 1 | P |
| 8-16 | Steps 5-13 of Table 4.5.2.2-2 of the generic procedure in TS 38508-1 [4] are performed | - | | - | - |
| 17 | SS transmits a REGISTRATION ACCEPT message that includes IE MICO indication | <-- | REGISTRATION ACCEPT | - | - |
| 18 | The SS releases the RRC Connection | - | | - | - |
| 19 | The SS configures:
- NGC Cell A as the "Non-suitable cell".
- NGC Cell C as the "Serving cell".
- NGC Cell E as the "Non-suitable cell". | - | | | |
| 20 | Check : Does the UE transmit a RRCSetupRequest on NGC Cell C ? This is checked for 60s | --> | NR RRC: <i>RRCSetupRequest</i> | 2,3 | F |
| 21 | The SS configures:
- NGC Cell A as the "Non-suitable cell".
- NGC Cell C as the "Non-suitable cell".
- NGC Cell E as the "Serving cell". | - | | - | - |
| | The following messages are to be observed on NGC Cell E unless explicitly stated otherwise | | | | |
| 22-24 | The UE establishes an RRC connection by executing steps 2–4 of Table 4.5.2.2-2 in TS38.508-1 [4]. | - | | - | - |
| 25 | Check : Does the UE transmit a REGISTRATION REQUEST message with IE 5GS registration type set to "mobility registration updating" | --> | REGISTRATION REQUEST | 4 | P |
| 26-27 | Steps 4–5 of Table 4.9.5.2.2-1 in TS38.508-1 [4] are performed | | | | |

9.1.5.1.4.3.3 Specific message contents

Table 9.1.5.1.4.3.3-1: REGISTRATION REQUEST (step 6 Table 9.1.5.1.4.3.2-1)

| Derivation Path: TS 38.508-1 [4], Table 4.7.1-6 | | | |
|---|--------------|----------------------|-----------|
| Information Element | Value/remark | Comment | Condition |
| 5GS registration type | | | |
| 5GS registration type value | '001'B | Initial registration | INITIAL |
| MICO indication | '0000'B | | |

Table 9.1.5.1.4.3.3-2: REGISTRATION ACCEPT (step 16 Table 9.1.5.1.4.3.2-1)

| Derivation Path: TS 38.508 [4], Table 4.7.1-7 | | | |
|---|--------------|--------------------------------------|-----------|
| Information Element | Value/remark | Comment | Condition |
| MICO Indication | '0001'B | All PLMN registration area allocated | |
| TAI list | Not present | | |

Table 9.1.5.1.4.3.3-3: REGISTRATION REQUEST (step 23 Table 9.1.5.1.4.3.2-1)

| Derivation Path: TS 38.508-1 [4], Table 4.7.1-6 | | | |
|---|--------------|--------------------------------|-----------|
| Information Element | Value/remark | Comment | Condition |
| 5GS registration type | | | |
| 5GS registration type value | '010'B | Mobility registration updating | MOBILITY |

9.1.5.1.5 Initial registration / Abnormal / Failure after 5 attempts

9.1.5.1.5.1 Test Purpose (TP)

(1)

```
with { The UE in 5GMM-REGISTERED-INITIATED state and T3510 timer expired }
ensure that {
  when { T3511 timer expires and registration attempt counter is less than 5 }
  then { UE restarts the initial registration procedure }
}
```

(2)

```
with { The UE in 5GMM-REGISTERED-INITIATED state }
ensure that {
  when { The NAS signalling connection is released before the REGISTRATION ACCEPT or REGISTRATION
REJECT message is received }
  then { UE restarts the initial registration procedure }
}
```

(3)

```
with { The UE has sent initial REGISTRAION REQUEST message }
ensure that {
  when { UE receives a REGISTRATION REJECT message including 5GMM cause value #95 and the UE updates
the registration counter to 5 }
  then { UE deletes 5G-GUTI, last visited TAI and ngKSI, performs a PLMN selection after timer
T3502 timeout }
}
```

9.1.5.1.5.2 Conformance requirements

References: The conformance requirements covered in the present TC are specified in: TS 24.501, clauses 5.5.1.1, 5.5.1.2.7, and 10.2. Unless otherwise stated these are Rel-15 requirements.

[TS 24.501, clause 5.5.1.1]

Additionally, the registration attempt counter shall be reset when the UE is in sub state 5GMM-DEREGISTERED.ATTEMPTING-REGISTRATION or 5GMM-REGISTERED.ATTEMPTING-REGISTRATION-UPDATE, and:

- a new tracking area is entered;
- timer T3502 expires; or
- timer T3346 is started.

[TS 24.501, clause 5.5.1.2.7]

The following abnormal cases can be identified:

...

- c) T3510 timeout.

The UE shall abort the registration procedure for initial registration and the NAS signalling connection, if any, shall be released locally if the initial registration request is not for emergency services. The UE shall proceed as described below.

- d) REGISTRATION REJECT message, other 5GMM cause values than those treated in subclause 5.5.1.2.5, and cases of 5GMM cause value #22, if considered as abnormal cases according to subclause 5.5.1.2.5.

If the registration request is not an initial registration request for emergency services, upon reception of the 5GMM causes #95, #96, #97, #99 and #111 the UE should set the registration attempt counter to 5.

The UE shall proceed as described below.

- e) Lower layer failure or release of the NAS signalling connection received from lower layers before the REGISTRATION ACCEPT or REGISTRATION REJECT message is received.

The UE shall abort the registration procedure for initial registration and proceed as described below.

...

For the cases c, d and e, the UE shall proceed as follows:

Timer T3510 shall be stopped if still running.

If the registration procedure is neither an initial registration for emergency services nor for establishing an emergency PDU session with registration type not set to "emergency registration", the registration attempt counter shall be incremented, unless it was already set to 5.

If the registration attempt counter is less than 5:

- if the initial registration request is not for emergency services, timer T3511 is started and the state is changed to 5GMM-DEREGISTERED.ATTEMPTING-REGISTRATION. When timer T3511 expires the registration procedure for initial registration shall be restarted, if still required.

If the registration attempt counter is equal to 5

- the UE shall delete 5G-GUTI, TAI list, last visited TAI, list of equivalent PLMNs and ngKSI, start timer T3502 and shall set the 5GS update status to 5U2 NOT UPDATED. The state is changed to 5GMM-DEREGISTERED.ATTEMPTING-REGISTRATION or optionally to 5GMM-DEREGISTERED.PLMN-SEARCH in order to perform a PLMN selection according to 3GPP TS 23.122 [5].

[TS 24.501, clause 10.2]

Table 10.2.1: Timers of 5GS mobility management – UE side

| TIMER NUM. | TIMER VALUE | STATE | CAUSE OF START | NORMAL STOP | ON EXPIRY |
|------------|---------------------------|---|--|--|--|
| T3510 | 15s | 5GMM-REGISTERED-INITIATED | Transmission of REGISTRATION REQUEST message | REGISTRATION ACCEPT message received or REGISTRATION REJECT message received | Start T3511 or T3502 as specified in subclause 5.5.1.2.7 if T3510 expired during registration procedure for initial registration.

Start T3511 or T3502 as specified in subclause 5.5.1.3.7 if T3510 expired during the registration procedure for mobility and periodic registration update |
| T3502 | Default 12 min.
NOTE 1 | 5GMM-REGISTERED | At registration failure and the attempt counter is equal to 5 | Transmission of REGISTRATION REQUEST message | Initiation of the registration procedure, if still required |
| T3511 | 10s | 5GMM-DEREGISTERED.ATTEMPTING-REGISTRATION

5GMM-REGISTERED.ATTEMPTING-REGISTRATION-UPDATE

5GMM-REGISTERED.NORMAL-SERVICE | At registration failure due to lower layer failure, T3510 timeout or registration rejected with other 5GMM cause values than those treated in subclause 5.5.1.2.5 for initial registration or subclause 5.5.1.3.5 for mobility and periodic registration | Transmission of REGISTRATION REQUEST message

5GMM-CONNECTED mode entered (NOTE 5) | Retransmission of the REGISTRATION REQUEST, if still required |

9.1.5.1.5.3 Test description

9.1.5.1.5.3.1 Pre-test conditions

System Simulator:

- NGC Cell A is configured according to Table 6.3.2.2-1 in TS 38.508-1 [4].

UE:

None.

Preamble:

- The UE is in state 0-A according to TS 38.508-1 [4] Table 4.4A.2-0.

9.1.5.1.5.3.2 Test procedure sequence

Table 9.1.5.1.5.3.2-1: Main behaviour

| St | Procedure | Message Sequence | | TP | Verdict |
|---------|--|------------------|----------------------|----|---------|
| | | U - S | Message | | |
| 1 | The SS configures:
- NGC Cell A as the "Serving cell". | - | - | - | - |
| - | The following messages are to be observed on NGC Cell A unless explicitly stated otherwise. | - | - | - | - |
| 2 | The UE is switched on. | - | - | - | - |
| 3-5 | Steps 2-4 of Table 4.5.2.2-2 of the generic procedure in TS 38.508-1 [4] are performed and the UE transmits a REGISTRATION REQUEST with IE 5GS registration type set to "initial registration". | --> | REGISTRATION REQUEST | - | - |
| 6 | The SS waits 25 seconds (15 seconds T3510 and 10 seconds T3511). (UE's registration attempt counter = 1) | - | - | - | - |
| 7 | Check: Does the UE transmit a REGISTRATION REQUEST message with IE 5GS registration type set to "initial registration"? | --> | REGISTRATION REQUEST | 1 | P |
| 8 | The SS releases the RRC connection. | - | - | - | - |
| 8A | The SS waits 10 seconds (T3511). (UE's registration attempt counter = 2) | | | | |
| 9-11 | Steps 2-4 of Table 4.5.2.2-2 of the generic procedure in TS 38.508-1 [4] are performed. Check: Does the UE transmit a REGISTRATION REQUEST message with IE 5GS registration type set to "initial registration"? | --> | REGISTRATION REQUEST | 2 | P |
| 12-16 | Steps 5-9 of Table 4.5.2.2-2 of the generic procedure in TS 38.508-1 [4] are performed. | - | - | - | - |
| 17 | The SS transmits a REGISTRATION REJECT with cause #95 (Semantically incorrect message). (UE's registration attempt counter = 5) | <-- | REGISTRATION REJECT | - | - |
| 17 A | The SS releases the RRC connection. | - | - | - | - |
| | EXCEPTION: Steps 17Aa1 and 17Ab1 describes behaviour that depends on the UE capability; the "lower case letter" identifies a step sequence that take place if a capability is supported | | | | |
| 17 Aa 1 | IF the UE transmits a REGISTRATION REQUEST message with IE 5GS registration type set to "initial registration" 10s after step 17A. | --> | REGISTRATION REQUEST | - | - |
| 17 Ab 1 | ELSE Check: Does the UE transmit a REGISTRATION REQUEST message with IE 5GS registration type set to "initial registration" after 12 minutes after step 17A? (UE's registration attempt counter has been reset to 0 after expiry of T3502) | --> | REGISTRATION REQUEST | 3 | P |
| 18 | Void | - | - | - | - |
| 19-34 | Steps 5-20a1 of Table 4.5.2.2-2 of the generic procedure in TS 38.508-1 [4] are performed. | - | - | - | - |

9.1.5.1.5.3.3 Specific message contents

Table 9.1.5.1.5.3.3-1: REGISTRATION REJECT (step 17, Table 9.1.5.1.5.3.2-1)

| Derivation path: TS 38.508-1 [4], Table 4.7.1-9 | | | |
|---|--------------|---|-----------|
| Information Element | Value/remark | Comment | Condition |
| 5GMM cause | '01011111'B | Cause #95
(Semantically incorrect message) | |

Table 9.1.5.1.5.3.3-2: REGISTRATION REQUEST (step 18, Table 9.1.5.1.5.3.2-1)

| Derivation path: TS 38.508-1 [4], Table 4.7.1-6 | | | |
|---|-------------------|---|-----------|
| Information Element | Value/remark | Comment | Condition |
| ngKSI | | | |
| NAS key set identifier | '111'B | no key is available | |
| TSC | Any allowed value | TSC does not apply for NAS key set identifier value "111" | |
| 5GS mobile identity | SUCI | | |
| Last visited registered TAI | Not present | | |

Table 9.1.5.1.5.3.3-3: Void

9.1.5.1.6 Initial registration / Rejected / Illegal UE

9.1.5.1.6.1 Test Purpose (TP)

(1)

```

with { the UE in 5GMM-REGISTERED-INITIATED state }
ensure that {
  when { the SS sends a REGISTRATION REJECT message to the UE including an appropriate 5GMM cause value #3 (Illegal UE) }
  then { the UE deletes the stored 5G-GUTI, last visited registered TAI and ngKSI, deletes the list of equivalent PLMNs and enter state 5GMM-DEREGISTERED, the USIM is considered invalid until switching off the UE }
}

```

9.1.5.1.6.2 Conformance requirements

References: The conformance requirements covered in the present TC are specified in: TS 24.501 clause 5.5.1.2.5.

[TS 24.501, clause 5.5.1.2.5]

If the initial registration request cannot be accepted by the network, the AMF shall send a REGISTRATION REJECT message to the UE including an appropriate 5GMM cause value.

If the initial registration request is rejected due to general NAS level mobility management congestion control, the network shall set the 5GMM cause value to #22 "congestion" and assign a back-off timer T3346.

The UE shall take the following actions depending on the 5GMM cause value received in the REGISTRATION REJECT message.

#3 (Illegal UE); or

#6 (Illegal ME).

The UE shall set the 5GS update status to 5U3 ROAMING NOT ALLOWED (and shall store it according to subclause 5.1.3.2.2) and shall delete any 5G-GUTI, last visited registered TAI, TAI list and ngKSI. The UE shall consider the USIM as invalid for 5GS services until switching off or the UICC containing the USIM is removed. The UE shall delete the list of equivalent PLMNs and enter the state 5GMM-DEREGISTERED.

If the UE is operating in single-registration mode, the UE shall handle the EMM parameters EMM state, EPS update status, 4G-GUTI, TAI list and eKSI as specified in 3GPP TS 24.301 [15] for the case when the EPS attach request procedure is rejected with the EMM cause with the same value. The USIM shall be considered as invalid also for non-EPS services until switching off or the UICC containing the USIM is removed.

If the UE also supports the registration procedure over the other access, the UE shall in addition handle 5GMM parameters and 5GMM state for this access, as described for this 5GMM cause value.

9.1.5.1.6.3 Test description

9.1.5.1.6.3.1 Pre-test conditions

System Simulator:

- NGC Cell A is configured according to table 6.3.2.2-1 in TS 38.508-1 [4].

UE:

None.

Preamble:

- The UE is in state Switched OFF (state 0N-B) according to TS 38.508-1 [4].

9.1.5.1.6.3.2 Test procedure sequence

Table 9.1.5.1.6.3.2-1: Main behaviour

| St | Procedure | Message Sequence | | TP | Verdict |
|-------|--|------------------|----------------------------|----|---------|
| | | U - S | Message | | |
| 1 | The SS configures:
- NGC cell A as the "Serving cell". | - | - | - | - |
| - | The following messages are to be observed on NGC Cell A unless explicitly stated otherwise. | - | - | - | - |
| 2 | The UE is switched on. | - | - | - | - |
| 3-14 | Steps 2-13 of Table 4.5.2.2-2 of the generic procedure in TS 38.508-1 [4] are performed. | - | - | - | - |
| 15 | The SS transmits a REGISTRATION REJECT message with the 5GMM cause set to 'Illegal UE' as specified. | <-- | 5GMM: REGISTRATION REJECT | - | - |
| 16 | The SS releases the RRC connection. | - | - | - | - |
| 17 | Check: Does the UE transmit an REGISTRATION REQUEST message on NGC cell A in the next 30 seconds? | --> | 5GMM: REGISTRATION REQUEST | 1 | F |
| 18 | The user initiates Registration Request by MMI or by AT command. | - | - | - | - |
| 19 | Check: Does the UE transmit the REGISTRATION REQUEST message in the next 30 seconds? | --> | 5GMM: REGISTRATION REQUEST | 1 | F |
| 20 | If possible (see ICS) switch off is performed or the USIM is removed. Otherwise the power is removed. | - | - | - | - |
| 21 | The UE is brought back to operation or the USIM is inserted. The UE is powered on or switched on. | - | - | - | - |
| 22 | Check: Does the UE transmit an REGISTRATION REQUEST message on NGC Cell A? | --> | 5GMM: REGISTRATION REQUEST | 1 | P |
| 23-38 | Steps 5-20 of Table 4.5.2.2-2 of the generic procedure in TS 38.508-1 [4] are performed on NGC Cell A. | - | - | - | - |

9.1.5.1.6.3.3 Specific message contents

Table 9.1.5.1.6.3.3-1: REGISTRATION REJECT (step 15, Table 9.1.5.1.6.3.2-1)

| Derivation Path: TS 38.508-1 Table 4.7.1-9 | | | |
|--|--------------|------------|-----------|
| Information Element | Value/remark | Comment | Condition |
| 5GMM cause | '0000 0011'B | Illegal UE | |

Table 9.1.5.1.6.3.3-2: REGISTRATION REQUEST (step 22, Table 9.1.5.1.6.3.2-1)

| Derivation path: TS 38.508-1 [4], table 4.7.1-6 | | | |
|---|-------------------|---|-----------|
| Information Element | Value/Remark | Comment | Condition |
| ngKSI | | | |
| NAS key set identifier | '111'B | no key is available (UE to network) | |
| TSC | Any allowed value | TSC does not apply for NAS key set identifier value "111" | |
| 5GS mobile identity | The valid SUCI | . | |
| Last visited registered TAI | Not present | | |

9.1.5.1.7 Void

9.1.5.1.8 Initial registration / Rejected / Serving network not authorized

9.1.5.1.8.1 Test Purpose (TP)

(1)

```
with { The UE has sent initial REGISTRAION REQUEST message }
ensure that {
  when { the UE receives a REGISTRATION REJECT with cause #73 (Serving network not authorized) }
  then { the UE stores the PLMN identity in the "forbidden PLMN list" and does not attempt to
register on a cell belong to that PLMN }
}
```

9.1.5.1.8.2 Conformance requirements

References: The conformance requirements covered in the present TC are specified in: TS 24.501, clauses 5.5.1.2.5. Unless otherwise stated these are Rel-15 requirements.

[TS 24.501, clause 5.5.1.2.5]

If the initial registration request cannot be accepted by the network, the AMF shall send a REGISTRATION REJECT message to the UE including an appropriate 5GMM cause value.

If the initial registration request is rejected due to general NAS level mobility management congestion control, the network shall set the 5GMM cause value to #22 "congestion" and assign a back-off timer T3346.

The UE shall take the following actions depending on the 5GMM cause value received in the REGISTRATION REJECT message.

#3 (Illegal UE); or

#6 (Illegal ME).

....

#73 (Serving network not authorized).

The UE shall set the 5GS update status to 5U2 NOT UPDATED, reset the registration attempt counter, store the PLMN identity in the "forbidden PLMN list" and enter state 5GMM-DEREGISTERED.PLMN-SEARCH in order to perform a PLMN selection according to 3GPP TS 23.122 [5].

9.1.5.1.8.3 Test description

9.1.5.1.8.3.1 Pre-test conditions

System Simulator:

- 3 NGC Cells NGC Cell E, NGC Cell I and NGC Cell A are configured as specified in TS 38.508-1[4] table 6.3.2.2-1 and table 6.3.2.2-3.

UE:

- The UE is in Automatic PLMN selection mode.

Preamble:

- NGC Cell E is set to "Serving Cell".
- NGC Cell I is set to "Non-Suitable cell".
- NGC Cell A is set to "Non-Suitable cell".

- The UE is in state ON-B with a successful registration on NGC Cell E according to 38.508-1[4].

9.1.5.1.8.3.2 Test procedure sequence

Table 9.1.5.1.8.3.2-1: Main behaviour

| St | Procedure | Message Sequence | | TP | Verdict |
|---------|--|------------------|--------------------------------|----|---------|
| | | U - S | Message | | |
| 1 | The UE is switched on | - | - | - | - |
| 2-9 | Steps 2-9 of Table 4.5.2.2-2 in TS38.508-1 [4] are performed on NGC Cell E. | - | - | - | - |
| 10 | The SS transmits a REGISTRATION REJECT with cause #73 (Serving network not authorized). | <-- | REGISTRATION REJECT | - | - |
| 11 | The SS releases the RRC connection | - | - | - | - |
| 11
A | The SS configures
- NGC Cell I as "Suitable neighbour cell" | - | - | - | - |
| 12 | Check: Does the UE send in the next 30 sec a request for RRC connection establishment on Cell E or Cell I. | --> | NR RRC: <i>RRCSetupRequest</i> | 1 | F |
| 13 | The SS configures
- NGC Cell A as "Serving Cell" | - | - | - | - |
| 14 | Check: Does the UE perform Registration procedure on NGC Cell A as specified in TS 38.508-1 [4] subclause 4.5.2? | - | - | 1 | P |
| 14
A | Switch off procedure in RRC_IDLE specified in TS 38.508-1 subclause 4.9.6.1 is performed. | - | - | - | - |
| 15 | The SS configures
- NGC Cell A as "Non-Suitable "Off" cell" | - | - | - | - |
| 15
A | The UE is brought back to operation or the USIM is inserted. The UE is powered on or switched on. | - | - | - | - |
| 16 | Set the UE in manual PLMN selection mode or request a PLMN search. | - | - | - | - |
| 17 | The user selects the PLMN of NGC Cell E. | - | - | - | - |
| 18 | The UE performs Registration procedure on NGC Cell E as specified in TS 38.508-1 [4] subclause 4.5.2. | - | - | - | - |
| 19 | Set the UE in Automatic PLMN selection mode. | - | - | - | - |

9.1.5.1.8.3.3 Specific message contents

Table 9.1.5.1.8.3.3-1: REGISTRATION REJECT (step 10 Table 9.1.5.1.8.3.2-1)

| Derivation Path: TS 38.508-1 [4], Table 4.7.1-9 | | | |
|---|--------------|---|-----------|
| Information Element | Value/remark | Comment | Condition |
| 5GMM cause | '01001001'B | Cause #73
(Serving network not authorized) | |

9.1.5.1.9 Initial registration / Abnormal / Change of cell into a new tracking area

9.1.5.1.9.1 Test Purpose (TP)

(1)

```
with { the UE in 5GMM-REGISTERED-INITIATED state }
ensure that {
  when { the UE changes into a new tracking area before UE receives the REGISTRATION ACCEPT message }
  then { the UE shall abort the registration procedure for initial registration and re-initiate it immediately }
```

}

9.1.5.1.9.2 Conformance requirements

References: The conformance requirements covered in the present TC are specified in: TS 24.501, clause 5.5.1.2.7.

[TS 24.501, clause 5.5.1.2.7]

The following abnormal cases can be identified:

...

h) Change of cell into a new tracking area.

If a cell change into a new tracking area occurs before the registration procedure for initial registration is completed, the registration procedure for initial registration shall be aborted and re-initiated immediately. If a tracking area border is crossed when the REGISTRATION ACCEPT message has been received but before a REGISTRATION COMPLETE message is sent, the registration procedure for initial registration shall be re-initiated. If a 5G-GUTI was allocated during the registration procedure, this 5G-GUTI shall be used in the registration procedure.

9.1.5.1.9.3 Test description

9.1.5.1.9.3.1 Pre-test conditions

System Simulator:

- NGC Cell A is configured according to Table 6.3.2.2-1 in TS 38.508-1 [4].
- The defaultPagingCycle in SIB1 of NGC Cell A shall be set as rf32.

UE:

- the UE is previously registered on NGC, and when on NGC, the UE is last authenticated and registered on NGC cell A using default message contents according to TS 38.508-1 [4].

Preamble:

- The UE is in state Switched OFF (state 0N-B) according to TS 38.508-1 [4].

9.1.5.1.9.3.2 Test procedure sequence

Table 9.1.5.1.9.3.2-1: Main behaviour

| St | Procedure | Message Sequence | | TP | Verdict |
|--------|---|------------------|----------------------------|----|---------|
| | | U - S | Message | | |
| 1 | Void. | - | - | - | - |
| 2 | The UE is switched on. | - | - | - | - |
| 3-14 | Steps 2–13 of Table 4.5.2.2-2 in TS38.508-1 [4] are performed. | - | - | - | - |
| 15 | SS does not send REGISTRATION ACCEPT to the UE and update TAC value in SIB1. | - | - | - | - |
| 15A | Void. | - | - | - | - |
| 16 | The SS notifies the UE of change of System Information on NGC Cell A by sending Short Message on PDCCH using P-RNTI. | <- | NR RRC: <i>Paging</i> | - | - |
| 16A-28 | Void. | - | - | - | - |
| 29 | Check: Does the UE transmit an REGISTRATION REQUEST message before the 15 second timer (T3510) started in step 5 expires? | - | 5GMM: REGISTRATION REQUEST | 1 | P |
| 29A 1 | The SS transmits a REGISTRATION ACCEPT message. | <- | REGISTRATION ACCEPT | - | - |
| 29A 2 | The UE transmits a REGISTRATION COMPLETE message. | --> | REGISTRATION COMPLETE | - | - |
| 30-32 | Steps 19a1-19Aa2 of Table 4.5.2.2-2 of the generic procedure in TS 38.508-1 [4] are performed. | - | - | - | - |

9.1.5.1.9.3.3 Specific message contents

Table 9.1.5.1.9.3.3-0A: SIB1 of NGC Cell A (preamble)

| Derivation Path: TS 38.508-1 [4], Table 4.6.1-28 | | | |
|--|--------------|---------|-----------|
| Information Element | Value/remark | Comment | Condition |
| SIB1 ::= SEQUENCE { | | | |
| servingCellConfigCommon SEQUENCE { | | | |
| pccch-Config SEQUENCE { | | | |
| defaultPagingCycle | rf32 | | |
| } | | | |
| } | | | |
| } | | | |

Table 9.1.5.1.9.3.3-0: SIB1 of NGC Cell A (step 15, Table 9.1.5.1.9.3.2-1)

| Derivation Path: TS 38.508-1 [4], Table 4.6.1-28 | | | |
|--|--------------|---------|-----------|
| Information Element | Value/remark | Comment | Condition |
| SIB1 ::= SEQUENCE { | | | |
| cellAccessRelatedInfo SEQUENCE { | | | |
| PLMN-IdentityInfoList SEQUENCE { | | | |
| trackingAreaCode | 2 | | |
| } | | | |
| } | | | |
| } | | | |

Table 9.1.5.1.9.3.3-1: Void**Table 9.1.5.1.9.3.3-1A: Void****Table 9.1.5.1.9.3.3-2: REGISTRATION REQUEST (step 29, Table 9.1.5.1.9.3.2-1)**

| Derivation path: TS 38.508-1 [4], table 4.7.1-6 | | | |
|---|--------------|----------------------|-----------|
| Information Element | Value/Remark | Comment | Condition |
| 5GS registration type | | . | |
| 5GS registration type value | '001'B | Initial registration | |

9.1.5.1.10 Initial registration / Rejected / PLMN not allowed

9.1.5.1.10.1 Test Purpose (TP)

(1)

```

with { the UE in 5GMM-REGISTERED-INITIATED state }
ensure that {
  when { the SS sends a REGISTRATION REJECT message to the UE including an appropriate 5GMM cause
value #11 (PLMN not allowed) }
  then { the UE deletes any 5G-GUTI, last visited registered TAI and ngKSI, deletes the list of
equivalent PLMNs, stores the PLMN identity in the "forbidden PLMN list" and performs a PLMN
selection }
}

```

9.1.5.1.10.2 Conformance requirements

References: The conformance requirements covered in the current TC are specified in: TS 24.501 clauses 5.5.1.2.5. Unless otherwise stated these are Rel-15 requirements.

[TS 24.501, clause 5.5.1.2.5]

If the initial registration request cannot be accepted by the network, the AMF shall send a REGISTRATION REJECT message to the UE including an appropriate 5GMM cause value.

...

The UE shall take the following actions depending on the 5GMM cause value received in the REGISTRATION REJECT message.

...

#11 (PLMN not allowed).

The UE shall set the 5GS update status to 5U3 ROAMING NOT ALLOWED (and shall store it according to subclause 5.1.3.2.2) and shall delete any 5G-GUTI, last visited registered TAI, TAI list and ngKSI. The UE shall delete the list of equivalent PLMNs and reset the registration attempt counter and store the PLMN identity in the "forbidden PLMN list". The UE shall enter state 5GMM-DEREGISTERED.PLMN-SEARCH and perform a PLMN selection according to 3GPP TS 23.122 [5]. If the message has been successfully integrity checked by the NAS, the UE shall set the PLMN-specific attempt counter and the PLMN-specific attempt counter for non-3GPP access for that PLMN to the UE implementation-specific maximum value.

9.1.5.1.10.3 Test description

9.1.5.1.10.3.1 Pre-test conditions

System Simulator:

- NGC cell G and NGC cell I.
- The NGC cells are configured according to Table 6.3.2.2-1 and Table 6.3.2.2-3 in 38.508-1 [4], except replacing NRF3 with NRF1;

UE:

- the UE is previously registered on NGC, and when on NGC, the UE is last authenticated and registered on NGC cell G using default message contents according to TS 38.508-1 [4];

Preamble:

- The UE is in state ON-B according to TS 38.508-1 [4].

9.1.5.1.10.3.2 Test procedure sequence

Table 9.1.5.1.10.3.2-1: Main behaviour

| St | Procedure | Message Sequence | | TP | Verdict |
|---------|---|------------------|----------------------------|----|---------|
| | | U – S | Message | | |
| 1 | The SS configures:
- NGC Cell G as the "Serving cell".
- NGC Cell I as a "Non-Suitable Off cell". | - | - | - | - |
| 2 | Void | | | | |
| | The following messages are to be observed on Cell G unless explicitly stated otherwise. | - | - | - | - |
| 3 | The UE is switched on. | - | - | - | - |
| 4-11 | Steps 2-9 of Table 4.5.2.2-2 of the generic procedure in TS 38.508-1 [4] are performed. | - | - | - | - |
| 12 | The SS transmits an REGISTRATION REJECT message including an appropriate 5GMM cause value #11 (PLMN not allowed). | <- | 5GMM: REGISTRATION REJECT | - | - |
| 13 | The SS releases the RRC connection. | - | - | - | - |
| 14 | Check: Does the UE transmit an REGISTRATION REQUEST message on NGC cell G in the next 90 seconds? | --> | 5GMM: REGISTRATION REQUEST | 1 | F |
| 15 | The generic test procedure in TS 38.508-1 Table 4.9.6.4-1 of Switch off procedure in State DEREGISTERED are performed. | - | - | - | - |
| 16 | The UE is brought back to operation or the USIM is inserted. The UE is powered on or switched on. | - | - | - | - |
| 17 | Check: Does the UE transmit an REGISTRATION REQUEST message in the next 30 seconds? | --> | 5GMM: REGISTRATION REQUEST | 1 | F |
| 18 | The SS configures:
-NGC Cell G as the "Serving cell"
-NGC Cell I as a "Suitable neighbour cell". | - | - | - | - |
| 19 | Void | | | | |
| - | The following messages are to be observed on NGC Cell I unless explicitly stated otherwise. | - | - | - | - |
| 20-22 | The UE establishes RRC connection by executing steps 2-4 of Table 4.5.2.2-2 in TS 38.508-1 [4]. | - | - | - | - |
| 23 | Check: Does the UE transmit an REGISTRATION REQUEST message as specified? | --> | 5GMM: REGISTRATION REQUEST | 1 | P |
| 24-39a1 | Steps 5-19a1 of Table 4.5.2.2-2 of the generic procedure in TS 38.508-1 [4] are performed. | - | - | - | - |
| 40 | The generic test procedure in TS 38.508-1 Table 4.9.6.3-1 of Switch off procedure in RRC_CONNECTED are performed. | - | - | - | - |
| 40 A | The SS configures:
-NGC Cell G as the "Serving cell"
-NGC Cell I as a "Non-Suitable "off" cell ". | | | | |
| 40 B | The UE is brought back to operation or the USIM is inserted. The UE is powered on or switched on. | - | - | - | - |
| 40 C | The user sets the UE in manual PLMN selection mode or requests a PLMN search. | - | - | - | - |
| 41 | The user selects PLMN of NGC Cell I. | - | - | - | - |
| 42-60a1 | Steps 2 to 20a1 of the registration procedure described in TS 38.508-1 [4] subclause 4.5.2 are performed on NGC Cell G. | - | - | - | - |
| 61 | The user sets the UE in Automatic PLMN selection mode. | - | - | - | - |

9.1.5.1.10.3.3 Specific message contents

Table 9.1.5.1.10.3.3-1: Message REGISTRATION REJECT (step 12, Table 9.1.5.1.10.3.2-1)

| Derivation path: TS 38.508-1 [4], table 4.7.1-9 | | | |
|---|--------------|------------------------|-----------|
| Information Element | Value/Remark | Comment | Condition |
| 5GMM cause | '00001011'B | #11 "PLMN not allowed" | |

Table 9.1.5.1.10.3.3-2: Message REGISTRATION REQUEST (step 23, Table 9.1.5.1.10.3.2-1)

| Derivation path: TS 38.508-1 [4], table 4.7.1-6 | | | |
|---|-------------------|---|-----------|
| Information Element | Value/Remark | Comment | Condition |
| ngKSI | | | |
| NAS key set identifier | '111'B | no key is available (UE to network) | |
| TSC | Any allowed value | TSC does not apply for NAS key set identifier value "111" | |
| 5GS mobile identity | The valid SUCI | . | |
| Last visited registered TAI | Not present | | |

9.1.5.1.11 Initial registration / Rejected / Tracking area not allowed

9.1.5.1.11.1 Test Purpose (TP)

(1)

```
with { the UE in 5GMM-REGISTERED-INITIATED state }
ensure that {
  when { the SS sends a REGISTRATION REJECT message to the UE including an appropriate 5GMM cause value #12 (Tracking area not allowed) }
  then { the UE deletes any 5G-GUTI, last visited registered TAI and ngKSI, stores the current TAI in the list of "5GS forbidden tracking areas for regional provision of service". }
}
```

(2)

```
with { the UE is in 5GMM-DEREGISTERED.LIMITED-SERVICE state and the TAI of the current cell belongs to the list of "forbidden tracking areas for regional provision of service" }
ensure that {
  when { the UE enters a cell belonging to a tracking area not in the list of "forbidden tracking areas for regional provision of service" }
  then { the UE attempts to registration }
}
```

(3)

```
with { the UE is in 5GMM-DEREGISTERED.LIMITED-SERVICE state and the list of "forbidden tracking areas for regional provision of service" contains more than one TAI }
ensure that {
  when { the UE selects a cell belonging to one of the TAIs in the list of "forbidden tracking areas for regional provision of service" }
  then { the UE does not attempt to registration }
}
```

(4)

```
with { the UE is switched off or the UICC containing the USIM is removed }
ensure that {
  when { UE is powered on in the cell belonging to the TAI which was in the list of "forbidden tracking areas for regional provision of service" before the UE was switched off or the USIM is inserted again on that cell }
  then { UE performs registration on that cell }
}
```

9.1.5.1.11.2 Conformance requirements

References: The conformance requirements covered in the current TC are specified in: TS 24.501, clauses 5.5.1.2.5, 5.1.3.2.2.

[TS 24.501, clause 5.5.1.2.5]

If the initial registration request cannot be accepted by the network, the AMF shall send a REGISTRATION REJECT message to the UE including an appropriate 5GMM cause value.

If the initial registration request is rejected due to general NAS level mobility management congestion control, the network shall set the 5GMM cause value to #22 "congestion" and assign a back-off timer T3346.

The UE shall take the following actions depending on the 5GMM cause value received in the REGISTRATION REJECT message.

...

#12 (Tracking area not allowed).

The UE shall set the 5GS update status to 5U3 ROAMING NOT ALLOWED (and shall store it according to subclause 5.1.3.2.2) and shall delete 5G-GUTI, last visited registered TAI, TAI list and ngKSI. Additionally, the UE shall reset the registration attempt counter.

The UE shall store the current TAI in the list of "5GS forbidden tracking areas for regional provision of service" and enter the state 5GMM-DEREGISTERED.LIMITED-SERVICE.

[TS 24.501, clause 5.1.3.2.2]

In order to describe the detailed UE behaviour, the 5GS update (5U) status pertaining to a specific subscriber is defined.

If the UE is not SNPN enabled or the UE is not operating in SNPN access mode (see 3GPP TS 23.501 [8]), the 5GS update status is stored in a non-volatile memory in the USIM if the corresponding file is present in the USIM, else in the non-volatile memory in the ME, as described in annex C.

If the UE is operating in SNPN access mode, the 5GS update status for each SNPN whose SNPN identity is included in the "list of subscriber data" configured in the ME (see 3GPP TS 23.122 [5]) is stored in the non-volatile memory in the ME as described in annex C.

The 5GS update status value is changed only after the execution of a registration, network-initiated de-registration, 5GS based primary authentication and key agreement, service request or paging procedure.

5U1: UPDATED

The last registration attempt was successful.

5U2: NOT UPDATED

The last registration attempt failed procedurally, e.g. no response or reject message was received from the AMF.

5U3: ROAMING NOT ALLOWED

The last registration, service request, or registration for mobility or periodic registration update attempt was correctly performed, but the answer from the AMF was negative (because of roaming or subscription restrictions).

[TS 24.501, clause 5.3.13]

The UE shall store a list of "5GS forbidden tracking areas for roaming", as well as a list of "5GS forbidden tracking areas for regional provision of service". Within the 5GS, these lists are managed independently per access type, i.e., 3GPP access or non-3GPP access. These lists shall be erased when

- a) the UE is switched off or the UICC containing the USIM is removed or an entry of the "list of subscriber data" with the SNPN identity of the current SNPN is updated; and
- b) periodically (with a period in the range 12 to 24 hours).

Over 3GPP access, when the lists are erased, the UE performs cell selection according to 3GPP TS 38.304 [28]. A tracking area shall be removed from the list of "5GS forbidden tracking areas for roaming", as well as the list of "5GS forbidden tracking areas for regional provision of service", if the UE receives the tracking area in the TAI list or the Service area list of "allowed tracking areas" in REGISTRATION ACCEPT message or a CONFIGURATION UPDATE COMMAND message. The UE shall not remove the tracking area from "5GS forbidden tracking areas for roaming" or "5GS forbidden tracking areas for regional provision of service" if the UE is registered for emergency services.

In N1 mode, the UE shall update the suitable list whenever a REGISTRATION REJECT, SERVICE REJECT or DEREGISTRATION REQUEST message is received with the 5GMM cause #12 "tracking area not allowed", #13 "roaming not allowed in this tracking area", or #15 "no suitable cells in tracking area".

Each list shall accommodate 40 or more TAIs. When the list is full and a new entry has to be inserted, the oldest entry shall be deleted.

9.1.5.1.11.3 Test description

9.1.5.1.11.3.1 Pre-test conditions

System Simulator:

- NGC Cell A (home PLMN) and NGC Cell B (home PLMN, another TA) are configured according to Table 6.3.2.2-1 in TS 38.508-1 [4].
- System information combination NR-2 in accordance with TS 38.508-1[4] sub-clause 4.4.3.1.2 is used in NGC Cell A and NGC Cell B.
- The UE is last authenticated and registered on NGC Cell A.

Preamble:

- The UE is in state Switched OFF (state ON-B) according to TS 38.508-1 [4].

9.1.5.1.11.3.2 Test procedure sequence

Table 9.1.5.1.11.3.2-1: Main behaviour

| St | Procedure | Message Sequence | | TP | Verdict |
|---------|--|------------------|----------------------|-----|---------|
| | | U - S | Message | | |
| 1 | The SS configures:
- NGC Cell A as the "Serving cell".
- NGC Cell B as "Non-suitable cell". | - | - | - | - |
| 2 | The UE is switched on. | - | - | - | - |
| 3-14 | Steps 2-13 of Table 4.5.2.2-2 of the generic procedure in TS 38.508-1 [4] are performed. | - | - | - | - |
| 15 | The SS transmits a REGISTRATION REJECT message, 5GMM cause value = #12 "Tracking area not allowed". | <-- | REGISTRATION REJECT | - | - |
| 16 | The SS releases the RRC connection. | - | - | - | - |
| 17 | Check: Does the UE transmit the REGISTRATION REQUEST message on NGC Cell A in the next 30 seconds? | --> | REGISTRATION REQUEST | 1 | F |
| 18 | The SS reconfigures:
- NGC cell B as the "Serving cell".
- NGC cell A as a " Non-Suitable cell". | - | - | - | - |
| 19 | Check: Does the UE transmit the REGISTRATION REQUEST message on NGC Cell B? | --> | REGISTRATION REQUEST | 1,2 | P |
| 20-26 | Steps 5 to 11 from procedure in TS 38.508-1 [4] Table 4.5.2.2-2 are performed. | - | - | - | - |
| 27 | The SS transmits a REGISTRATION REJECT message, 5GMM cause value = #12 "Tracking area not allowed". | <-- | REGISTRATION REJECT | - | - |
| 28 | The SS releases the RRC connection. | - | - | - | - |
| 28 A | The SS reconfigures:
- NGC cell A as a "Suitable neighbour intra-frequency cell". | - | - | - | - |
| 29 | Check: Does the UE transmit the REGISTRATION REQUEST message in the next 30 seconds on NGC Cell A or NGC Cell B? | --> | REGISTRATION REQUEST | 1,3 | F |
| 30 | Switch off UE in State Deregistered as described in TS38.508-1 [4] subclause 4.9.6.4. | - | - | - | - |
| 31 | The SS reconfigures:
- NGC cell A as the "Serving cell".
- NGC cell B as "Non-suitable cell". | - | - | - | - |
| 32 | Switch on UE. | - | - | - | - |
| 33 | Check: Does the UE transmit a REGISTRATION REQUEST message on NGC Cell A? | --> | REGISTRATION REQUEST | 4 | P |
| 34-49a1 | Steps 5-20a1 of Table 4.5.2.2-2 in TS38.508-1 [4] are performed. | - | - | - | - |

9.1.5.1.11.3.3 Specific message contents

Table 9.1.5.1.11.3.3-1: REGISTRATION REJECT (step 15, step 27, Table 9.1.5.1.11.3.2-1)

| Derivation path: TS 38.508-1 [4] table 4.7.1-9 | | | |
|--|--------------|---------------------------------|-----------|
| Information Element | Value/remark | Comment | Condition |
| 5GMM cause | '00001100'B | #12 "Tracking area not allowed" | |

Table 9.1.5.1.11.3.3-2: REGISTRATION REQUEST (step 19, step33, Table 9.1.5.1.11.3.2-1)

| Derivation path: TS 38.508-1 [4] table 4.7.1-6 | | | |
|--|-------------------|---|-----------|
| Information Element | Value/Remark | Comment | Condition |
| ngKSI | | | |
| NAS key set identifier | '111'B | no key is available | |
| TSC | Any allowed value | TSC does not apply for NAS key set identifier value "111" | |
| 5GS mobile identity | The valid SUCI | Only SUCI is available. | |
| Last visited registered TAI | Not present | | |

9.1.5.1.12 Initial registration / Rejected / Roaming not allowed in this tracking area

9.1.5.1.12.1 Test Purpose (TP)

(1)

```
with { the UE in 5GMM-REGISTERED-INITIATED state }
ensure that {
  when { the SS sends a REGISTRATION REJECT message to the UE including an appropriate 5GMM cause value #13 (Roaming not allowed in this tracking area)
  then { the UE deletes any 5G-GUTI, last visited registered TAI and ngKSI, deletes the list of equivalent PLMNs, stores the current TAI in the list of "5GS forbidden tracking areas for roaming" }
}
```

(2)

```
with { the initial registration request cannot be accepted by the network }
ensure that {
  when { the SS sends a REGISTRATION REJECT message to the UE including an appropriate 5GMM cause value #13 (Roaming not allowed in this tracking area)}
  then { The UE performs a PLMN selection }
}
```

(3)

```
with { the UE is in 5GMM-DEREGISTERED.LIMITED-SERVICE or 5GMM-DEREGISTERED.PLMN-SEARCH state and the TAI of the current cell belongs to the list of "forbidden tracking areas for roaming"}
ensure that {
  when { the UE enters a cell belonging to a tracking area not in the list of "forbidden tracking areas for roaming"}
  then { the UE attempts to registration }
}
```

(4)

```
with { the UE is in 5GMM-DEREGISTERED.LIMITED-SERVICE or 5GMM-DEREGISTERED.PLMN-SEARCH state and the list of "forbidden tracking areas for roaming" contains more than one TAI}
ensure that {
  when { the UE selects a cell belonging to one of the TAIs in the list of "forbidden tracking areas for roaming" }
  then { the UE does not attempt to registration }
}
```

(5)

```
with { the UE is switched off or the UICC containing the USIM is removed }
ensure that {
  when { UE is powered on in the cell belonging to the TAI which was in the list of "forbidden tracking areas for roaming" before the UE was switched off or the USIM is inserted again on that cell }
  then { UE performs registration on that cell }
}
```

9.1.5.1.12.2 Conformance requirements

References: The conformance requirements covered in the current TC are specified in: TS 24.501 clauses 5.5.1.2.5, 5.1.3.2.1, 5.1.3.2.2, TS 23.122 clauses 3.1.

[TS 24.501, clause 5.5.1.2.5]

If the initial registration request cannot be accepted by the network, the AMF shall send a REGISTRATION REJECT message to the UE including an appropriate 5GMM cause value.

If the initial registration request is rejected due to general NAS level mobility management congestion control, the network shall set the 5GMM cause value to #22 "congestion" and assign a back-off timer T3346.

The UE shall take the following actions depending on the 5GMM cause value received in the REGISTRATION REJECT message.

...

#13 (Roaming not allowed in this tracking area).

The UE shall set the 5GS update status to 5U3 ROAMING NOT ALLOWED (and shall store it according to subclause 5.1.3.2.2) and shall delete 5G-GUTI, last visited registered TAI, TAI list and ngKSI. Additionally, the UE shall delete the list of equivalent PLMNs and reset the registration attempt counter.

The UE shall store the current TAI in the list of "5GS forbidden tracking areas for roaming" and enter the state 5GMM-DEREGISTERED.LIMITED-SERVICE or optionally 5GMM-DEREGISTERED.PLMN-SEARCH. The UE shall perform a PLMN selection according to 3GPP TS 23.122 [5].

...

[TS 24.501, clause 5.1.3.2.1.3.3]

The sub state 5GMM-DEREGISTERED.LIMITED-SERVICE is chosen in the UE, when it is known that a selected cell for 3GPP access or TA for non-3GPP access is unable to provide normal service (e.g. the selected cell over 3GPP access is in a forbidden PLMN or is in a forbidden tracking area or TA for non-3GPP access is forbidden).

[TS 24.501, clause 5.1.3.2.1.3.5]

The sub state 5GMM-DEREGISTERED.PLMN-SEARCH is chosen in the UE, if the UE is searching for PLMNs. This sub state is left either when a cell has been selected (the new sub state is NORMAL-SERVICE or LIMITED-SERVICE) or when it has been concluded that no cell is available at the moment (the new sub state is NO-CELL-AVAILABLE).

This sub state is not applicable to non-3GPP access.

[TS 24.501, clause 5.1.3.2.2]

In order to describe the detailed UE behaviour, the 5GS update (5U) status pertaining to a specific subscriber is defined.

If the UE is not SNPN enabled or the UE is not operating in SNPN access mode (see 3GPP TS 23.501 [8]), the 5GS update status is stored in a non-volatile memory in the USIM if the corresponding file is present in the USIM, else in the non-volatile memory in the ME, as described in annex C.

If the UE is operating in SNPN access mode, the 5GS update status for each SNPN whose SNPN identity is included in the "list of subscriber data" configured in the ME (see 3GPP TS 23.122 [5]) is stored in the non-volatile memory in the ME as described in annex C.

The 5GS update status value is changed only after the execution of a registration, network-initiated de-registration, 5GS based primary authentication and key agreement, service request or paging procedure.

5U1: UPDATED

The last registration attempt was successful.

5U2: NOT UPDATED

The last registration attempt failed procedurally, e.g. no response or reject message was received from the AMF.

5U3: ROAMING NOT ALLOWED

The last registration, service request, or registration for mobility or periodic registration update attempt was correctly performed, but the answer from the AMF was negative (because of roaming or subscription restrictions).

[TS 23.122, clause 3.1]

The tracking area is added to the list of "5GS forbidden tracking areas for roaming" which is stored in the MS. The MS shall then search for a suitable cell in the same PLMN but belonging to a tracking area which is not in the "5GS forbidden tracking areas for roaming" list.

9.1.5.1.12.3 Test description

9.1.5.1.12.3.1 Pre-test conditions

System Simulator:

- NGC cell C (MCC/MNC=MCC/MNC in USIM), NGC cell E (visited PLMN, mcc=002, mnc=101) and NGC cell I (visited PLMN, mcc=002, mnc=101, another TA) are configured according to Table 6.3.2.2-1 and Table 6.3.2.2-3 in TS 38.508-1 [4], except replacing NRF3 with NRF2.

UE:

- The UE is last authenticated and registered on NGC Cell E.

Preamble:

- The UE is in state Switched OFF (state 0N-B) according to TS 38.508-1 [4] Table 4.4A.2-0.

9.1.5.1.12.3.2 Test procedure sequence

Table 9.1.5.1.12.3.2-1: Main behaviour

| St | Procedure | Message Sequence | | TP | Verdict |
|-------------|---|------------------|----------------------|-----|---------|
| | | U - S | Message | | |
| 1 | The SS configures:
- NGCCell E as the "Serving cell".
- Other NGC cells as "Non-suitable cell". | - | - | - | - |
| 2 | The UE is switched on. | - | - | - | - |
| 3-14 | Steps 2-13 of Table 4.5.2.2-2 of the generic procedure in TS 38.508-1 [4] are performed. | - | - | - | - |
| 15 | The SS transmits a REGISTRATION REJECT message, 5GMM cause value = #13 " roaming not allowed in this tracking area ". | <-- | REGISTRATION REJECT | - | - |
| 16 | The SS releases the RRC connection. | - | - | - | - |
| 17 | Check: Does the UE transmit the REGISTRATION REQUEST message on NGC Cell E in the next 30 seconds? | --> | REGISTRATION REQUEST | 1 | F |
| 18 | The SS reconfigures:
- NGC cell I as the "Serving cell".
- NGC cell E as a "Suitable Neighbour cell",
- NGC cell C as "Non-suitable cell". | - | - | - | - |
| 19 | Check: Does the UE transmit the REGISTRATION REQUEST message on NGC Cell I? | --> | REGISTRATION REQUEST | 1,3 | P |
| 20-26 | Steps 5 to 11 from procedure in TS 38.508-1 [4] Table 4.5.2.2-2 are performed. | - | - | - | - |
| 27 | The SS transmits a REGISTRATION REJECT message, 5GMM cause value = #13 " roaming not allowed in this tracking area ". | <-- | REGISTRATION REJECT | - | - |
| 28 | The SS releases the RRC connection. | - | - | - | - |
| 29 | Check: Does the UE transmit the REGISTRATION REQUEST message in the next 30 seconds on NGC cell I or NGC cell E? | --> | REGISTRATION REQUEST | 1,4 | F |
| 30 | Switch off UE in State Deregistered as described in TS38.508-1 [4] subclause 4.9.6.4. | - | - | - | - |
| 31 | The SS reconfigures:
- NGC cell E as the "Serving cell".
- Other NGC cells as "Non-suitable cell". | - | - | - | - |
| 32 | Switch on UE. | - | - | - | - |
| 33 | Check: Does the UE transmit the REGISTRATION REQUEST message on NGC Cell E? | --> | REGISTRATION REQUEST | 5 | P |
| 34-42 | Steps 5 to 13 from procedure in TS 38.508-1 [4] Table 4.5.2.2-2 are performed. | - | - | - | - |
| 43 | The SS transmits a REGISTRATION REJECT message, 5GMM cause value = #13 " roaming not allowed in this tracking area ". | <-- | REGISTRATION REJECT | - | - |
| 44 | The SS releases the RRC connection. | - | - | - | - |
| 45 | The SS reconfigures:
- NGC Cell E as the "Serving cell",
- NGC Cell C as a "Suitable neighbour cell".
- NGC Cell I as "Non-suitable cell". | - | - | - | - |
| 46 | Check: Does the UE transmit the REGISTRATION REQUEST message on NGC Cell C? | --> | REGISTRATION REQUEST | 2 | P |
| 47-62a
1 | Steps 5–20a1 of Table 4.5.2.2-2 in TS38.508-1 [4] are performed. | - | - | - | - |

9.1.5.1.12.3.3 Specific message contents

Table 9.1.5.1.12.3.3-1: REGISTRATION REJECT (step 15, step 27, step 43, Table 9.1.5.1.12.3.2-1)

| Derivation path: TS 38.508-1 [4] table 4.7.1-9 | | | |
|--|--------------|---|-----------|
| Information Element | Value/remark | Comment | Condition |
| 5GMM cause | '00001101'B | #13 "roaming not allowed in this tracking area" | |

Table 9.1.5.1.12.3.3-2: REGISTRATION REQUEST (step 19, step 33, step 46, Table 9.1.5.1.12.3.2-1)

| Derivation path: TS 38.508-1 [4] table 4.7.1-6 | | | |
|--|-------------------|---|-----------|
| Information Element | Value/Remark | Comment | Condition |
| ngKSI | | | |
| NAS key set identifier | '111'B | no key is available | |
| TSC | Any allowed value | TSC does not apply for NAS key set identifier value "111" | |
| 5GS mobile identity | The valid SUCI | Only SUCI is available. | |
| Last visited registered TAI | Not present | | |

9.1.5.1.13 Initial registration / Rejected / No suitable cells in tracking area

9.1.5.1.13.1 Test Purpose (TP)

(1)

```

with { the UE has sent initial REGISTRAION REQUEST message }
ensure that {
  when { the UE receives a REGISTRATION REJECT with cause #15 (No suitable cells in tracking area)}
  then { the UE sets the 5GS update status to 5U3 ROAMING NOT ALLOWED and delete any 5G-GUTI, last visited registered TAI, TAI list and ngKSI }
}

```

(2)

```

with { the UE is in 5GMM-DEREGISTERED.LIMITED-SERVICE state and the current TAI in the list of "forbidden tracking areas for roaming"}
ensure that {
  when { the UE re-selects a cell that belongs to the TAI where UE was rejected }
  then { the UE does not attempt to perform registration}
}

```

(3)

```

with { the UE has sent initial REGISTRAION REQUEST message }
ensure that {
  when { the UE receives a REGISTRATION REJECT with cause #15 (No suitable cells in tracking area)}
  then { the UE searches for a suitable cell in another tracking area }
}

```

9.1.5.1.13.2 Conformance requirements

References: The conformance requirements covered in the present TC are specified in: TS 24.501, clauses 5.5.1.2.5. Unless otherwise stated these are Rel-15 requirements.

[TS 24.501, clause 5.5.1.2.5]

If the initial registration request cannot be accepted by the network, the AMF shall send a REGISTRATION REJECT message to the UE including an appropriate 5GMM cause value.

If the initial registration request is rejected due to general NAS level mobility management congestion control, the network shall set the 5GMM cause value to #22 "congestion" and assign a back-off timer T3346.

The UE shall take the following actions depending on the 5GMM cause value received in the REGISTRATION REJECT message.

#3 (Illegal UE); or

#6 (Illegal ME).

....

#15 (No suitable cells in tracking area);

The UE shall set the 5GS update status to 5U3 ROAMING NOT ALLOWED (and shall store it according to subclause 5.1.3.2.2) and shall delete any 5G-GUTI, TAI list and ngKSI. Additionally, the UE shall reset the registration attempt counter.

The UE shall store the current TAI in the list of "5GS forbidden tracking areas for roaming" and enter the state 5GMM-DEREGISTERED.LIMITED-SERVICE. The UE shall search for a suitable cell in another tracking area according to 3GPP TS 38.304 [15].

9.1.5.1.13.3 Test description

9.1.5.1.13.3.1 Pre-test conditions

System Simulator:

- 3 cells, NGC Cell A and NGC Cell B belonging to TAI-1, NGC Cell C is in TAI-2. All Cells in the same PLMN.

UE:

- None.

Preamble:

- The UE is switched OFF.
- NGC Cell A is set to "Serving Cell".
- NGC Cell B is set to "Suitable neighbour cell".
- NGC Cell C is set to "Non-Suitable cell".

9.1.5.1.13.3.2 Test procedure sequence

Table 9.1.5.1.13.3.2-1: Main behaviour

| St | Procedure | Message Sequence | | TP | Verdict |
|-------|---|------------------|----------------------|-----|---------|
| | | U - S | Message | | |
| 1 | The UE is switched on | - | - | - | - |
| 2-9 | Steps 2-9 of Table 4.5.2.2-2 in TS38.508-1 [4] are performed on NGC Cell A. | - | - | - | - |
| 10 | The SS transmits a REGISTRATION REJECT with cause #15 (No suitable cells in tracking area). | <-- | REGISTRATION REJECT | - | - |
| 11 | The SS releases the RRC connection | - | - | - | - |
| 12 | Check: Does the UE transmit a REGISTRATION REQUEST message on NGC Cell A or NGC Cell B in the next 300 seconds? | --> | REGISTRATION REQUEST | 1,2 | F |
| 13 | The SS configures
- NGC Cell C as "Serving Cell"
- NGC Cell A as "Non-Suitable cell" | - | - | - | - |
| 14 | Check: Does the UE transmit a REGISTRATION REQUEST message on NGC Cell C? | --> | REGISTRATION REQUEST | 3 | P |
| 15-29 | Steps 5-19a1 of Table 4.5.2.2-2 in TS38.508-1 [4] are performed. | - | - | - | - |

9.1.5.1.13.3.3 Specific message contents

Table 9.1.5.1.13.3.3-1: REGISTRATION REJECT (step 10 Table 9.1.5.1.13.3.2-1)

| Derivation Path: TS 38.508-1 [4], Table 4.7.1-9 | | | |
|---|--------------|---|-----------|
| Information Element | Value/remark | Comment | Condition |
| 5GMM cause | '00001111'B | Cause #15(No suitable cells in tracking area) | |

Table 9.1.5.1.13.3.3-2: REGISTRATION REQUEST (step 14 Table 9.1.5.1.13.3.2-1)

| Derivation Path: TS 38.508-1 [4], Table 4.7.1-6 | | | |
|---|--------------|---|-----------|
| Information Element | Value/remark | Comment | Condition |
| ngKSI | | | |
| NAS key set identifier | '111'B | "No key is available" | |
| 5GS mobile identity | | | |
| Type of identity | '001'B | 5GS mobile identity is SUCI, 5G-GUTI has been deleted after receiving REGISTRATION REJECT at step 10. | |
| Last visited registered TAI | Not present | TAI has been deleted after receiving REGISTRATION REJECT at step 10. | |

Table 9.1.5.1.13.3.3-3: Void

9.1.5.1.14 Initial registration / Rejected / Congestion / Abnormal cases / T3346

9.1.5.1.14.1 Test Purpose (TP)

(1)

```
with { The UE has sent initial REGISTRAION REQUEST message }
ensure that {
  when { UE receives a REGISTRATION REJECT with cause #22 (Congestion) with T3346 included and the
  UE is NOT configured for High Priority Access in the selected PLMN }
  then { UE does not start the Initial registration until T3346 expires }
}
```

(2)

```
with { The UE has received initial REGISTRATION REJECT with T3346 included }
ensure that {
  when { upon expiry of T3346 }
  then { UE starts the Initial registration procedure }
}
```

(3)

Void

(4)

```
with { The UE has received initial REGISTRATION REJECT with T3346 included }
ensure that {
  when { the timer T3346 is running and the UE detects a cell better than serving cell on a PLMN
  other than serving cells PLMN (S criterion for detected cell > S criterion for serving cell ) }
  then { UE starts the Initial registration procedure on the detected cell }
}
```

(5)

```
with { The UE has received initial REGISTRATION REJECT with T3346 included }
ensure that {
  when { the timer T3346 is running and the UE detects a cell better than serving cell on same PLMN
  as serving cell (S criterion for detected cell > S criterion for serving cell) }
  then { UE starts the Initial registration procedure on the detected cell after T3346 expiry }
}
```

9.1.5.1.14.2 Conformance requirements

References: The conformance requirements covered in the present TC are specified in: TS 24.501, clauses 5.2.2.3.3, 5.5.1.2.5 and 5.5.1.2.7. Unless otherwise stated these are Rel-15 requirements.

[TS 24.501, clause 5.5.1.2.5]

If the initial registration request cannot be accepted by the network, the AMF shall send a REGISTRATION REJECT message to the UE including an appropriate 5GMM cause value.

If the initial registration request is rejected due to general NAS level mobility management congestion control, the network shall set the 5GMM cause value to #22 "congestion" and assign a back-off timer T3346.

The UE shall take the following actions depending on the 5GMM cause value received in the REGISTRATION REJECT message.

#3 (Illegal UE);

#6 (Illegal ME); or

....

#22 (Congestion).

If the T3346 value IE is present in the REGISTRATION REJECT message and the value indicates that this timer is neither zero nor deactivated, the UE shall proceed as described below; otherwise it shall be considered as an abnormal case and the behaviour of the UE for this case is specified in subclause 5.5.1.2.7.

The UE shall abort the initial registration procedure, set the 5GS update status to 5U2 NOT UPDATED and enter state 5GMM-DEREGISTERED.ATTEMPTING-REGISTRATION.

The UE shall stop timer T3346 if it is running.

If the REGISTRATION REJECT message is integrity protected, the UE shall start timer T3346 with the value provided in the T3346 value IE.

If the REGISTRATION REJECT message is not integrity protected, the UE shall start timer T3346 with a random value from the default range specified in 3GPP TS 24.008 [12].

The UE stays in the current serving cell and applies the normal cell reselection process. The initial registration procedure is started if still needed when timer T3346 expires or is stopped.

#27 (N1 mode not allowed).

The UE capable of S1 mode shall disable the N1 mode capability for both 3GPP access and non-3GPP access (see subclause 4.9).

Other values are considered as abnormal cases. The behaviour of the UE in those cases is specified in subclause 5.5.1.2.7.

[TS 24.501, clause 5.5.1.2.7]

The following abnormal cases can be identified:

- a) Timer T3346 is running.

The UE shall not start the registration procedure for initial registration unless:

- 1) the UE is a UE configured for high priority access in selected PLMN; or
- 2) the UE needs to perform the registration procedure for initial registration for emergency services.

The UE stays in the current serving cell and applies the normal cell reselection process.

NOTE 1: It is considered an abnormal case if the UE needs to initiate a registration procedure for initial registration while timer T3346 is running independent on whether timer T3346 was started due to an abnormal case or a non-successful case.

[TS 24.501, clause 5.2.2.3.3]

The UE in 3GPP access:

- a) ...
- b) ...
- c) shall initiate an initial registration procedure when entering a new PLMN, if timer T3346 is running and the new PLMN is not equivalent to the PLMN where the UE started timer T3346, the PLMN identity of the new cell is not in the forbidden PLMN lists and the tracking area is not in one of the lists of 5GS forbidden tracking areas;

9.1.5.1.14.3 Test description

9.1.5.1.14.3.1 Pre-test conditions

System Simulator:

- NGC Cell A, NGC Cell B and NGC Cell E are configured according to Table 6.3.2.2-1 and Table 6.3.2.2-3 in TS 38.508-1 [4].
- System information combination NR-2 as defined in TS 38.508 [4] clause 4.4.3.1.2 is used.

UE:

None.

Preamble:

- The UE is in state Switched OFF (State 0-A) as per TS 38.508-1 [4] Table 4.4A.2-0.

9.1.5.1.14.3.2 Test procedure sequence

Table 9.1.5.1.14.3.2-1: Main behaviour

| St | Procedure | Message Sequence | | TP | Verdict |
|---------|---|------------------|--------------------------------|----|---------|
| | | U - S | Message | | |
| 0 | The SS configures:
- NGC Cell A as the "Non-Suitable "off" cell".
- NGC Cell B as the "Non-Suitable "off" cell".
- NGC Cell E as the "Serving cell". | - | | - | |
| 0A | The UE is Switched/Powerd ON | - | - | - | - |
| 1-12 | Steps 2-13 of Table 4.5.2.2-2 of the generic procedure in TS 38.508-1 [4] are performed. | - | | - | - |
| 13 | SS transmits a REGISTRATION REJECT message with cause #22 (Congestion) and T3346 set to 3 minutes.
(Note 1) | <-- | REGISTRATION REJECT | - | - |
| 14 | The SS releases the RRC connection | - | | - | - |
| 15 | Check : Does the UE transmit a RRCSetupRequest on NGC Cell E within T3346 minutes of Step 13?
(Note 1) | --> | NR RRC: <i>RRCSetupRequest</i> | 1 | F |
| 16 | Check : Does the UE transmit a REGISTRATION REQUEST on NGC Cell E | --> | 5GMM: REGISTRATION REQUEST | 2 | P |
| 17-25 | Void | | | | |
| 26 | SS transmits a REGISTRATION REJECT message with cause #22 (Congestion) and T3346 set to 3 minutes.
(Note 1) | <-- | REGISTRATION REJECT | - | - |
| 27 | The SS releases the RRC connection | - | | | |
| 28 | The SS configures:
- NGC Cell A as the "Non-suitable cell".
- NGC Cell B as the "Serving cell".
- NGC Cell E as the "Non-suitable cell". | | | | |
| 29 | Check : Does the UE transmit a REGISTRATION REQUEST on NGC Cell B within T3346 minutes of Step 26? (Note 1) | --> | 5GMM: REGISTRATION REQUEST | 4 | P |
| 30-31 | Void | - | - | - | - |
| 32-38 | Steps 5-11 of Table 4.5.2.2-2 of the generic procedure in TS 38.508-1 [4] are performed. | | | | |
| 39 | SS transmits a REGISTRATION REJECT message with cause #22 (Congestion) and T3346 set to 3 minutes.
(Note 1) | <-- | REGISTRATION REJECT | - | - |
| 40 | The SS releases the RRC connection | - | | - | - |
| 41 | The SS configures:
- NGC Cell A as the "Serving cell".
- NGC Cell B as the "Non-suitable cell".
- NGC Cell E as the "Non-suitable cell". | | | | |
| 42 | Check : Does the UE transmit a RRCSetupRequest on NGC Cell A within T3346 minutes of Step 39?
(Note 1) | --> | NR RRC: <i>RRCSetupRequest</i> | 5 | F |
| 43 | Check : Does the UE transmit a REGISTRATION REQUEST on NGC Cell A | --> | 5GMM: REGISTRATION REQUEST | 5 | P |
| 44-74b1 | Void | - | - | - | - |
| 75-90a1 | Steps 5-20a1 of Table 4.5.2.2-2 of the generic procedure in TS 38.508-1 [4] are performed. | - | - | - | - |

Note 1: T3346 is set to 3 minutes.This is checked for 3 minutes less tolerance.

9.1.5.1.14.3.3 Specific message contents

Table 9.1.5.1.14.3.3-1: REGISTRATION REJECT (steps 13, 26, 39 Table 9.1.5.1.14.3.2-1)

| Derivation Path: TS 38.508-1 [4], Table 4.7.1-9 | | | |
|---|--------------|---------------------------|-----------|
| Information Element | Value/remark | Comment | Condition |
| 5GMM cause | '00010110'B | Cause #22
(Congestion) | |
| T3346 Value | '00100011'B | 3 minutes | |

Table 9.1.5.1.14.3.3-2: Void

9.1.5.2 Mobility and periodic registration update

9.1.5.2.1 Mobility registration update / TAI list handling

9.1.5.2.1.1 Test Purpose (TP)

(1)

```

with { UE in state 5GMM-REGISTERED, and 5GMM-IDLE mode over 3GPP access }
ensure that {
  when { UE detects entering a tracking area which is not in the list of forbidden TAs and is not in
the list of tracking areas that the UE previously registered in the AMF }
  then { UE initiates and successfully completes the registration procedure for mobility
registration update }
}

```

(2)

```

with { UE in state 5GMM-REGISTERED, and 5GMM-IDLE mode over 3GPP access }
ensure that {
  when { UE detects entering a tracking area which is not in the list of forbidden TAs and is in the
list of tracking areas that the UE previously registered in the AMF }
  then { UE does not initiate the registration procedure for mobility registration update }
}

```

(3)

```

with { UE in state 5GMM-REGISTERED, and 5GMM-IDLE mode over 3GPP access }
ensure that {
  when { UE receives a new TAI list during a mobility registration update procedure }
  then { UE shall delete its old TAI list and store the received TAI list }
}

```

9.1.5.2.1.2 Conformance requirements

References: The conformance requirements covered in the present TC are specified in: TS 24.501, clauses 5.5.1.3.2, 5.5.1.3.4. Unless otherwise stated these are Rel-15 requirements.

[TS 24.501, clause 5.5.1.3.2]

The UE in state 5GMM-REGISTERED shall initiate the registration procedure for mobility and periodic registration update by sending a REGISTRATION REQUEST message to the AMF,

- a) when the UE detects entering a tracking area that is not in the list of tracking areas that the UE previously registered in the AMF;

...

If case b) is the only reason for initiating the registration procedure for mobility and periodic registration update, the UE shall indicate "periodic registration updating" in the 5GS registration type IE; otherwise the UE shall indicate "mobility registration updating".

...

After sending the REGISTRATION REQUEST message to the AMF the UE shall start timer T3510. If timer T3502 is currently running, the UE shall stop timer T3502. If timer T3511 is currently running, the UE shall stop timer T3511.

If the last visited registered TAI is available, the UE shall include the last visited registered TAI in the REGISTRATION REQUEST message.

The UE shall handle the 5GS mobility identity IE in the REGISTRATION REQUEST message as follows:

- ...
- b) for all other cases, if the UE holds a valid 5G-GUTI, the UE shall indicate the 5G-GUTI in the 5GS mobile identity IE.

...

When the registration procedure for mobility and periodic registration update is initiated in 5GMM-IDLE mode, the UE may include a PDU session status IE in the REGISTRATION REQUEST message, indicating which PDU sessions associated with the access type the REGISTRATION REQUEST message is sent over are active in the UE.

...

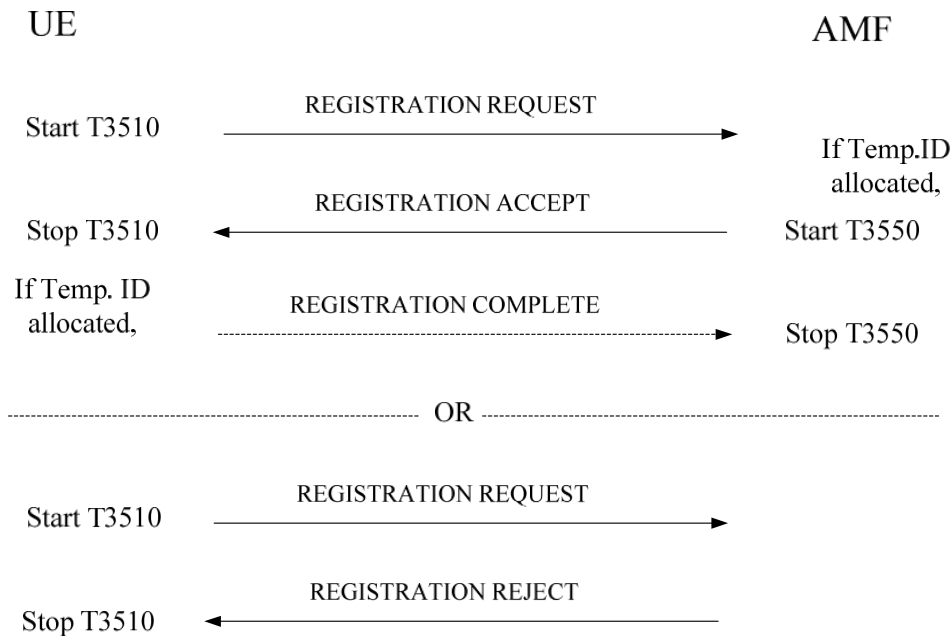

Figure 5.5.1.3.2.1: Registration procedure for mobility and periodic registration update

[TS 24.501, clause 5.5.1.3.4]

The AMF shall assign and include a TAI list as a registration area the UE is registered to in the REGISTRATION ACCEPT message. The UE, upon receiving a REGISTRATION ACCEPT message, shall delete its old TAI list and store the received TAI list. If the REGISTRATION REQUEST message was received over non-3GPP access, the AMF shall include only the N3GPP TAI in the TAI list.

...

Upon receipt of the REGISTRATION ACCEPT message, the UE shall reset the registration attempt counter, enter state 5GMM-REGISTERED and set the 5GS update status to 5U1 UPDATED.

...

If the REGISTRATION ACCEPT message contains a 5G-GUTI, the UE shall return a REGISTRATION COMPLETE message to the AMF to acknowledge the received 5G-GUTI, stop timer T3519 if running, and delete any stored SUCI.

9.1.5.2.1.3 Test description

9.1.5.2.1.3.1 Pre-test conditions

System Simulator:

- 3 cells, NGC Cell A, and NGC Cell B and NGC Cell D belonging to the same PLMN and different TA in accordance with TS 38.508-1 [4] Table 6.3.2.2-1
- System information combination NR-2 as defined in TS 38.508-1 [4], sub-clause 4.4.3.1.2 is used in all cells when active.

UE:

None.

Preamble:

- The UE is in test state 1N-A as defined in 38.508-1 [4], subclause 4.4A on NGC Cell A.
- During the initial registration:
 - In the list of tracking areas provided by the AMF (IE 'TAI list') contains only the TAI of NGC Cell A.

9.1.5.2.1.3.2 Test procedure sequence

Table 9.1.5.2.1.3.2-1: Main behaviour

| St | Procedure | Message Sequence | | TP | Verdict |
|----|---|------------------|--------------------------------|----|---------|
| | | U - S | Message | | |
| 1 | The SS configures:
- NGC Cell B as "Serving cell"
- NGC Cell A as "Non-Suitable cell". | - | - | - | - |
| 2 | Check: Does the UE perform on NGC Cell B the Registration procedure for mobility registration update by executing the Test procedure to check that UE is camped on a new cell belonging to a new TA as specified in TS 38.508-1 [4] subclause 4.9.5?

NOTE: During the procedure the SS assigns a TAI list containing the TAI of NGC Cell B and NGC Cell D. | - | - | 1 | - |
| 3 | The SS configures:
- NGC Cell D as "Serving cell"
- NGC Cell B as "Non-Suitable 'Off' cell". | - | - | - | - |
| 4 | Check: Does the UE send in the next 30 sec a request for RRC connection establishment. | --> | NR RRC: <i>RRCSetupRequest</i> | 2 | F |
| 5 | Check: Does the result of generic test procedure in TS 38.508-1 [4] subclause 4.9.4 indicate that the UE is in 5GC RRC_IDLE state on the NGC Cell D? | - | - | 2 | - |
| 6 | The SS configures:
- NGC Cell A as "Serving cell"
- NGC Cell D as "Non-Suitable cell". | - | - | - | - |
| 7 | Check: Does the UE perform on NGC Cell A the Registration procedure for mobility registration update as specified in TS 38.508-1 [4] subclause 4.9.5, 'connected without release'? | - | - | 3 | - |

9.1.5.2.1.3.3 Specific message contents

Table 9.1.5.2.1.3.3-1: REGISTRATION REQUEST (step 2, Table 9.1.5.2.1.3.2-1; step 3, TS 38.508-1 [4] Table 4.9.5.2.2-1)

| Derivation path: TS 38.508-1 [4], Table 4.7.1-6. | | | |
|--|--|---|-----------|
| Information Element | Value/remark | Comment | Condition |
| 5GS registration type | '00xxx010' | mobility registration updating
x - not checked | |
| 5GS mobile identity | Active 5G-GUTI assigned in the preamble | | |
| 5GMM capability | Any value | | |
| Last visited registered TAI | The TAI of the NGC Cell A, see TS 38.508-1 [4] Table 6.3.2.2-1 | | |
| S1 UE network capability | If included then Any value | Shall be included if S1 mode indicated as supported in the IE '5GMM capability' | |

Table 9.1.5.2.1.3.3-2: REGISTRATION ACCEPT (step 2, Table 9.1.5.2.1.3.2-1; step 4, TS 38.508-1 [4] Table 4.9.5.2.2-1)

| Derivation path: TS 38.508-1 [4], Table 4.7.1-7. | | | |
|--|---|---|-----------|
| Information Element | Value/remark | Comment | Condition |
| 5GS registration result | | | |
| 5GS registration result value | '001' | 3GPP access | |
| SMS allowed | '0' | SMS over NAS not allowed | |
| 5G-GUTI | A 5G-GUTI different to the one provided by the UE in the REGISTRATION REQUEST | | |
| TAI list | | | |
| Type of list | "00" | list of TACs belonging to one PLMN, with non-consecutive TAC values | |
| MCC | The MCC of the PLMN to which the NGC Cell A, NGC Cell B and NGC Cell D belong to, see TS 38.508-1 [4] Table 6.3.2.2-1 | | |
| MNC | The MNC of the PLMN to which the NGC Cell A, NGC Cell B and NGC Cell D belong to, see TS 38.508-1 [4] Table 6.3.2.2-1 | | |
| TAC 1 | The TAI of the NGC Cell B, see TS 38.508-1 [4] Table 6.3.2.2-1 | | |
| TAC 2 | The TAI of the NGC Cell D, see TS 38.508-1 [4] Table 6.3.2.2-1 | | |
| PDU session status | If PDU session status was included in the REGISTRATION REQUEST, the indicated as active PDN sessions shall be confirmed as active | | |

Table 9.1.5.2.1.3.3-3: REGISTRATION REQUEST (step 7, Table 9.1.5.2.1.3.2-1; step 3, TS 38.508-1 [4] Table 4.9.5.2.2-1)

| Derivation path: TS 38.508-1 [4], Table 4.7.1-6. | | | |
|--|---|---|-----------|
| Information Element | Value/remark | Comment | Condition |
| 5GS registration type | '00xxx010' | mobility registration updating

x - not checked | |
| 5GS mobile identity | Active 5G-GUTI assigned in Table 9.1.5.2.1.3.3-2: REGISTRATION ACCEPT | | |
| 5GMM capability | Any value | | |
| Last visited registered TAI | The TAI of the NGC Cell D, see TS 38.508-1 [4] Table 6.3.2.2-1 | | |
| S1 UE network capability | If included then Any value | Shall be included if S1 mode indicated as supported in the IE '5GMM capability' | |

Table 9.1.5.2.1.3.3-4: REGISTRATION ACCEPT (step 7, Table 9.1.5.2.1.3.2-1; step 4, TS 38.508-1 [4] Table 4.9.5.2.2-1)

| Derivation path: TS 38.508-1 [4], Table 4.7.1-7. | | | |
|--|---|---|-----------|
| Information Element | Value/remark | Comment | Condition |
| 5GS registration result | | | |
| 5GS registration result value | '001' | 3GPP access | |
| SMS allowed | '0' | SMS over NAS not allowed | |
| 5G-GUTI | Active 5G-GUTI assigned in the preamble | | |
| TAI list | | | |
| Type of list | "00" | list of TACs belonging to one PLMN, with non-consecutive TAC values | |
| MCC | The MCC of the PLMN to which the NGC Cell A, NGC Cell B and NGC Cell D belong to, see TS 38.508-1 [4] Table 6.3.2.2-1 | | |
| MNC | The MNC of the PLMN to which the NGC Cell A, NGC Cell B and NGC Cell D belong to, see TS 38.508-1 [4] Table 6.3.2.2-1 | | |
| TAC 1 | The TAI of the NGC Cell A, see TS 38.508-1 [4] Table 6.3.2.2-1 | | |
| PDU session status | If PDU session status was included in the REGISTRATION REQUEST, the indicated as active PDU sessions shall be confirmed as active | | |

9.1.5.2.2 Periodic registration update / Accepted

9.1.5.2.2.1 Test Purpose (TP)

(1)

```
with { the UE in 5GMM-REGISTERED state and 5GMM-IDLE mode over 3GPP access }
ensure that {
  when { the periodic registration updating timer T3512 expires }
  then { the UE initiates the registration procedure for mobility and periodic registration update
and indicates "periodic registration updating" in the 5GS registration type IE }
}
```

(2)

```
with { the UE in 5GMM-REGISTERED-INITIATED state }
ensure that {
  when { the UE receives an REGISTRATION ACCEPT message included a new T3512 value IE }
  then { the UE uses the new value in T3512 value IE as periodic registration update timer (T3512)
}
}
```

9.1.5.2.2.2 Conformance requirements

References: The conformance requirements covered in the present TC are specified in: TS 24.501, clauses 5.5.1.3.1, 5.5.1.3.2 and 5.5.1.3.4. Unless otherwise stated these are Rel-15 requirements.

[TS 24.501, clause 5.5.1.3.1]

This procedure is used by a UE for both mobility and periodic registration update of 5GS services. This procedure, when used for periodic registration update of 5GS services, is performed only in 3GPP access.

This procedure used for periodic registration update of 5GS services is controlled in the UE by timer T3512. When timer T3512 expires, the registration procedure for mobility and periodic registration area updating is started. Start and reset of timer T3512 is described in subclause 10.2.

[TS 24.501, clause 5.5.1.3.2]

The UE in state 5GMM-REGISTERED shall initiate the registration procedure for mobility and periodic registration update by sending a REGISTRATION REQUEST message to the AMF,

- a) when the UE detects entering a tracking area that is not in the list of tracking areas that the UE previously registered in the AMF;
- b) when the periodic registration updating timer T3512 expires;

...

If item b) is the only reason for initiating the registration procedure for mobility and periodic registration update, the UE shall indicate "periodic registration updating" in the 5GS registration type IE; otherwise the UE shall indicate "mobility registration updating".

...

[TS 24.501, clause 5.5.1.3.4]

...

If the REGISTRATION ACCEPT message included a T3512 value IE, the UE shall use the value in T3512 value IE as periodic registration update timer (T3512). If the T3512 value IE is not included, the UE shall use the value currently stored, e.g. from a prior REGISTRATION ACCEPT message.

...

9.1.5.2.2.3 Test description

9.1.5.2.2.3.1 Pre-test conditions

System Simulator:

- NGC Cell A.

UE:

- None.

Preamble:

- The UE is in state 0N-B on NGC Cell A according to TS 38.508-1[4].

9.1.5.2.2.3.2 Test procedure sequence

Table 9.1.5.2.2.3.2-1: Main behaviour

| St | Procedure | Message Sequence | | TP | Verdict |
|-------|---|------------------|-----------------------|----|---------|
| | | U - S | Message | | |
| 1 | The UE is switched on. | - | - | - | - |
| 2-14 | Steps 1-13 of the generic procedure for UE registration specified in TS 38.508-1 [4] table 4.5.2.2-2 are performed. | - | - | - | - |
| 15 | The SS transmits a REGISTRATION ACCEPT message. | <- | REGISTRATION ACCEPT | - | - |
| 16-21 | Steps 15-20 of the generic procedure for UE registration specified in TS 38.508-1 [4] table 4.5.2.2-2 are performed. | - | - | - | - |
| 22 | The SS waits 3 minutes. (Expire of T3512) | - | - | - | - |
| 23 | Check: Does the UE transmit a REGISTRATION REQUEST message with the 5GS registration type IE indicating "periodic registration updating"? | --> | REGISTRATION REQUEST | 1 | P |
| 24 | The SS transmits a REGISTRATION ACCEPT message including T3512 value IE. | <- | REGISTRATION ACCEPT | - | - |
| 25 | The SS releases the RRC connection. | - | - | - | - |
| 26 | The SS waits 1 minute. (Expire of T3512) | - | - | - | - |
| 27 | Check: Does the UE transmit a REGISTRATION REQUEST message? | --> | REGISTRATION REQUEST | 2 | P |
| 28 | The SS transmits a REGISTRATION ACCEPT message. | <- | REGISTRATION ACCEPT | - | - |
| 29 | The UE transmits a REGISTRATION COMPLETE message. | --> | REGISTRATION COMPLETE | - | - |

9.1.5.2.2.3.3 Specific message contents

Table 9.1.5.2.2.3.3-1: REGISTRATION ACCEPT (Step15 , Table 9.1.5.2.2.3.2-1)

| Derivation path: TS 38.508-1 [4], table 4.7.1-7 | | | |
|---|--------------|---|-----------|
| Information Element | Value/Remark | Comment | Condition |
| T3512 value | | | |
| Unit | '101'B | value is incremented in multiples of 1 minute | |
| Timer value | '0 0011'B | 3 minutes | |

Table 9.1.5.2.2.3.3-2: REGISTRATION REQUEST (Step 23 & 27, Table 9.1.5.2.2.3.2-1)

| Derivation path: TS 38.508-1 [4], table 4.7.1-6 | | | |
|---|--------------|--------------------------------|-----------|
| Information Element | Value/Remark | Comment | Condition |
| 5GS registration type | | | |
| 5GS registration type value | '011'B | periodic registration updating | |

Table 9.1.5.2.2.3.3-3: REGISTRATION ACCEPT (Step 24, Table 9.1.5.2.2.3.2-1)

| Derivation path: TS 38.508-1 [4], table 4.7.1-7 | | | |
|---|--------------|---|-----------|
| Information Element | Value/Remark | Comment | Condition |
| T3512 value | | | |
| Unit | '101'B | value is incremented in multiples of 1 minute | |
| Timer value | '0 0001'B | 1 minute | |

9.1.5.2.3

9.1.5.2.4 Mobility registration update / The lower layer requests NAS signalling connection recovery

9.1.5.2.4.1 Test Purpose (TP)

(1)

```
with { UE in state 5GMM-REGISTERED, and 5GMM-CONNECTED mode over 3GPP access and does not have
signalling or user uplink data pending }
ensure that {
  when { UE receives an indication of "RRC Connection failure" from the lower layers }
  then { UE initiates and successfully completes the registration procedure for mobility
registration update }
}
```

9.1.5.2.4.2 Conformance requirements

References: The conformance requirements covered in the present TC are specified in: TS 24.501, clauses 5.5.1.3.2, 5.5.1.3.4. Unless otherwise stated these are Rel-15 requirements.

[TS 24.501, clause 5.5.1.3.2]

The UE in state 5GMM-REGISTERED shall initiate the registration procedure for mobility and periodic registration update by sending a REGISTRATION REQUEST message to the AMF,

...

- f) when the UE receives an indication of "RRC Connection failure" from the lower layers and does not have signalling or user uplink data pending (i.e. when the lower layer requests NAS signalling connection recovery);

...

If case b) is the only reason for initiating the registration procedure for mobility and periodic registration update, the UE shall indicate "periodic registration updating" in the 5GS registration type IE; otherwise the UE shall indicate "mobility registration updating".

...

After sending the REGISTRATION REQUEST message to the AMF the UE shall start timer T3510. If timer T3502 is currently running, the UE shall stop timer T3502. If timer T3511 is currently running, the UE shall stop timer T3511.

If the last visited registered TAI is available, the UE shall include the last visited registered TAI in the REGISTRATION REQUEST message.

The UE shall handle the 5GS mobility identity IE in the REGISTRATION REQUEST message as follows:

...

- b) for all other cases, if the UE holds a valid 5G-GUTI, the UE shall indicate the 5G-GUTI in the 5GS mobile identity IE.

...

When the registration procedure for mobility and periodic registration update is initiated in 5GMM-IDLE mode, the UE may include a PDU session status IE in the REGISTRATION REQUEST message, indicating which PDU sessions associated with the access type the REGISTRATION REQUEST message is sent over are active in the UE.

...

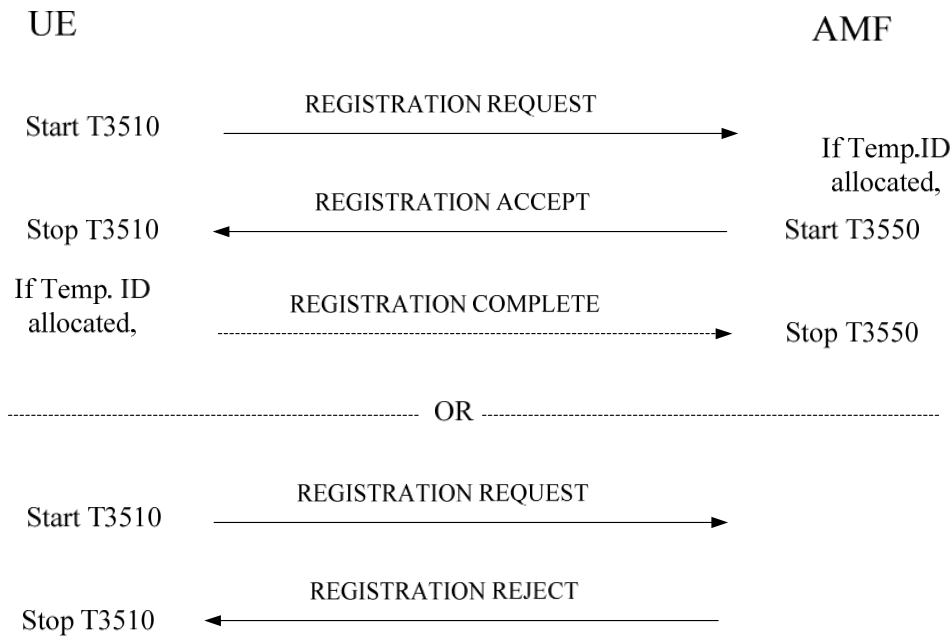

Figure 5.5.1.3.2.1: Registration procedure for mobility and periodic registration update

[TS 24.501, clause 5.5.1.3.4]

Upon receipt of the REGISTRATION ACCEPT message, the UE shall reset the registration attempt counter, enter state 5GMM-REGISTERED and set the 5GS update status to 5U1 UPDATED.

...

If the REGISTRATION ACCEPT message contains a 5G-GUTI, the UE shall return a REGISTRATION COMPLETE message to the AMF to acknowledge the received 5G-GUTI, stop timer T3519 if running, and delete any stored SUCI.

9.1.5.2.4.3 Test description

9.1.5.2.4.3.1 Pre-test conditions

System Simulator:

- NGC Cell A, default system information in accordance with TS 38.508-1 [4] sub-clause 4.4.3.1.2.

UE:

- None.

Preamble:

- Cell configuration in accordance with TS 38.508-1 [4] Table 6.3.2.2-1:
- NGC Cell A "Serving cell"
- The UE is in test state 3N-A as defined in TS 38.508-1 [4], subclause 4.4A.2 on NGC Cell A.

9.1.5.2.4.3.2 Test procedure sequence

Table 9.1.5.2.4.3.2-1: Main behaviour

| St | Procedure | Message Sequence | | TP | Verdict |
|---|---|------------------|---------|----|---------|
| | | U - S | Message | | |
| 1 | The SS configures:
- NGC Cell A as "Non-suitable "off" cell" in order to simulate radio link failure.
(NOTE 1) | - | - | - | - |
| 2 | Wait for $T=T310+T311+1.2$ sec.
(NOTE 1) | - | - | - | - |
| 3 | The SS configures:
- NGC Cell A as "Serving cell". | - | - | - | - |
| 4 | Check: Does the UE perform on NGC Cell A the Registration procedure for mobility registration update by executing the Test procedure to check that UE is camped on a new cell belonging to a new TA as specified in TS 38.508-1 [4] subclause 4.9.5.2.2-1, 'connected without release'? | - | - | 1 | - |
| NOTE 1: Steps 1-2 simulate the RRC connection failure needed in order for the UE "NAS layer" to receive an indication of "RRC Connection failure" from the lower layers. This is based on requirements specified in TS 38.331 [12], subclauses 5.3.10.1, 5.3.10.3, 5.3.11.
A 1s delay is added to allow for N310 consecutive "out-of-sync" indications and 0.2s is added for timer tolerance. Note that N310, T310, N311, T311 values are set in TS 38.508-1 [4], Table 4.6.3-150, <i>RLF-TimersAndConstants</i> . | | | | | |

9.1.5.2.4.3.3 Specific message contents

Table 9.1.5.2.4.3.3-1: REGISTRATION REQUEST (step 4, Table 9.1.5.2.4.3.2-1; step 3, TS 38.508-1 [4] Table 4.9.5.2.2-1)

| Derivation Path: TS 38.508-1 [4], Table 4.7.1-6. | | | |
|--|--|---|-----------|
| Information Element | Value/remark | Comment | Condition |
| 5GS registration type | '00xxx010' | mobility registration updating
x - not checked | |
| 5GS mobile identity | Active 5G-GUTI assigned in the preamble | | |
| 5GMM capability | Any value | | |
| Last visited registered TAI | The TAI of the NGC Cell A, see TS 38.508-1 [4] Table 6.3.2.2-1 | | |
| S1 UE network capability | If included then Any value | Shall be included if S1 mode indicated as supported in the IE '5GMM capability' | |

Table 9.1.5.2.4.3.3-2: REGISTRATION ACCEPT (step 4, Table 9.1.5.2.4.3.2-1; step 4, TS 38.508-1 [4] Table 4.9.5.2.2-1)

| Derivation Path: TS 38.508-1 [4], Table 4.7.1-7. | | | |
|--|---|---|-----------|
| Information Element | Value/remark | Comment | Condition |
| 5GS registration result | | | |
| 5GS registration result value | '001' | 3GPP access | |
| SMS allowed | '0' | SMS over NAS not allowed | |
| 5G-GUTI | Active 5G-GUTI assigned in the preamble | | |
| TAI list | | | |
| Type of list | "00" | list of TACs belonging to one PLMN, with non-consecutive TAC values | |
| MCC | The MCC of the PLMN to which the NGC Cell A, NGC Cell B and NGC Cell D belong to, see TS 38.508-1 [4] Table 6.3.2.2-1 | | |
| MNC | The MNC of the PLMN to which the NGC Cell A, NGC Cell B and NGC Cell D belong to, see TS 38.508-1 [4] Table 6.3.2.2-1 | | |
| TAC 1 | The TAI of the NGC Cell A, see TS 38.508-1 [4] Table 6.3.2.2-1 | | |
| PDU session status | If PDU session status was included in the REGISTRATION REQUEST, the indicated as active PDN sessions shall be confirmed as active | | |

9.1.5.2.6 Void

9.1.5.2.7 Mobility and periodic registration update / Rejected / UE identity cannot be derived by the network

9.1.5.2.7.1 Test Purpose (TP)

(1)

```
with { UE in state 5GMM-REGISTERED on an NGC cell }
ensure that {
  when { UE initiates a Mobility and periodic registration procedure on an NGC cell and receives a
REGISTRATION REJECT message including 5GMM cause value #9 (UE identity cannot be derived by the
network) }
  then { UE deletes any 5G-GUTI, last visited registered TAI and ngKSI, enters the state 5GMM-
DEREGISTERED 5U2 NOT UPDATED, and, subsequently automatically initiates the initial registration
procedure }
}
```

9.1.5.2.7.2 Conformance requirements

References: The conformance requirements covered in the present TC are specified in: TS 24.501, clause 5.5.1.3.5. Unless otherwise stated these are Rel-15 requirements.

[TS 24.501, clause 5.5.1.3.5]

If the mobility and periodic registration update request cannot be accepted by the network, the AMF shall send a REGISTRATION REJECT message to the UE including an appropriate 5GMM cause value.

The UE shall take the following actions depending on the 5GMM cause value received in the REGISTRATION REJECT message.

...

#9 (UE identity cannot be derived by the network).

The UE shall set the 5GS update status to 5U2 NOT UPDATED (and shall store it according to subclause 5.1.3.2.2) and shall delete any 5G-GUTI, last visited registered TAI, TAI list and ngKSI. The UE shall enter the state 5GMM-DEREGISTERED.

If the rejected request was not for initiating an emergency PDU session, the UE shall subsequently, automatically initiate the initial registration procedure.

9.1.5.2.7.3 Test description

9.1.5.2.7.3.1 Pre test conditions

System Simulator:

- 1 cell
- NGC Cell A as defined in TS 38.508-1 [4] Table 6.3.2.2-1. Default system information combination as defined in TS 38.508-1 [4], sub-clause 4.4.3.1.2.

UE:

None.

Preamble:

- The UE is brought to state 1N-A, RRC_IDLE Connectivity (NR), in accordance with the procedure described in TS 38.508-1 [4], Table 4.5.2.2-2. 5G-GUTI and ngKSI are assigned and security context established.

9.1.5.2.7.2 Test procedure sequence

Table 9.1.5.2.7.3.2-1: Main behaviour

| St | Procedure | Message Sequence | | TP | Verdict |
|----|--|------------------|----------------------|----|---------|
| | | U - S | Message | | |
| 1 | Wait for 25 seconds (expiry of T3512 periodic registration update timer, the value of 30 sec is provided during the initial registration in the Preamble). | - | - | - | - |
| 2 | The UE transmit a REGISTRATION REQUEST message with the 5GS registration type IE indicating "periodic registration updating". | --> | REGISTRATION REQUEST | - | - |
| 3 | The SS transmits a REGISTRATION REJECT message including 5GMM cause value #9 (UE identity cannot be derived by the network). | <-- | REGISTRATION REJECT | - | - |
| 4 | SS releases the RRC connection. | - | - | - | - |
| 5 | Check: Does the UE perform initial registration on NGC Cell A as specified in TS 38.508-1 [4], Table 4.5.2.2-2? The UE does not provide 5G-GUTI, last visited registered TAI or ngKSI. | - | - | 1 | P |

9.1.5.2.7.3.3 Specific message contents

Table 9.1.5.2.7.3.3-1: REGISTRATION ACCEPT (Preamble; TS 38.508-1 [4] Table 4.5.2.2-2)

| Derivation path: TS 38.508-1 [4], Table 4.7.1-7. | | | |
|--|--------------|---|-----------|
| Information Element | Value/remark | Comment | Condition |
| T3512 value | | | |
| Unit | '100'B | value is incremented in multiples of 30 seconds | |
| Timer value | '0 0001'B | 30 seconds | |

Table 9.1.5.2.7.3.3-2: REGISTRATION REQUEST (step 2, Table 9.1.5.2.7.3.2-1)

| Derivation Path: TS 38.508-1 [4], Table 4.7.1-6. | | | |
|--|--|---|-----------|
| Information Element | Value/remark | Comment | Condition |
| 5GS registration type | '00xxx011' | periodic registration updating
x - not checked | |
| ngKSI | Active ngKSI assigned in the Preamble | | |
| 5GS mobile identity | Active 5G-GUTI assigned in the Preamble | | |
| Last visited registered TAI | The TAI of the NGC Cell A, see TS 38.508-1 [4] Table 6.3.2.2-1 | | |

Table 9.1.5.2.7.3.3-3: REGISTRATION REJECT (step 3, Table 9.1.5.2.7.3.2-1)

| Derivation Path: TS 38.508-1 [4], Table 4.7.1-9. | | | |
|--|--------------|---|-----------|
| Information Element | Value/remark | Comment | Condition |
| 5GMM cause | '0000 1001'B | #9 - UE identity cannot be derived by the network | |

Table 9.1.5.2.7.3.3-4: REGISTRATION REQUEST (step 5, Table 9.1.5.2.7.3.2-1; step 4, TS 38.508-1 [4] Table 4.5.2.2-2)

| Derivation Path: TS 38.508-1 [4], Table 4.7.1-6, condition NON_CLEARTEXT_IE | | | |
|---|--------------|---|-----------|
| Information Element | Value/remark | Comment | Condition |
| 5GS registration type | '00xxx001' | Initial registration
x - not checked | |
| ngKSI | '111' | no key is available | |
| 5GS mobile identity | SUCI | | |
| Non-current native NAS key set identifier | Not present | | |
| Last visited registered TAI | Not present | | |
| Additional GUTI | Not present | | |
| NAS message container | Not included | | |

Table 9.1.5.2.7.3.3-5: SECURITY MODE COMPLETE (step 5, Table 9.1.5.2.7.3.2-1; step 9, TS 38.508-1 [4] Table 4.5.2.2-2)

| Derivation Path: TS 38.508-1 [4], Table 4.7.1-26, condition RINMR_INDICATED. |
|--|
|--|

9.1.5.2.8 Mobility and periodic registration update / Rejected / Implicitly de-registered

9.1.5.2.8.1 Test Purpose (TP)

(1)

```
with { UE in state 5GMM-REGISTERED on an NGC cell }
ensure that {
  when { UE initiates a Mobility and periodic registration procedure on an NGC cell and receives a
REGISTRATION REJECT message including 5GMM cause value #10 (implicitly de-registered) }
  then { UE deletes any partial native 5G security context, enters the state 5GMM-
DEREGISTERED.NORMAL-SERVICE, and, initiates a new registration procedure for initial registration }
}
```

9.1.5.2.8.2 Conformance requirements

References: The conformance requirements covered in the present TC are specified in: TS 24.501, clause 5.5.1.3.5. Unless otherwise stated these are Rel-15 requirements.

[TS 24.501, clause 5.5.1.3.5]

If the mobility and periodic registration update request cannot be accepted by the network, the AMF shall send a REGISTRATION REJECT message to the UE including an appropriate 5GMM cause value.

The UE shall take the following actions depending on the 5GMM cause value received in the REGISTRATION REJECT message.

...

#10 (implicitly de-registered).

The UE shall enter the state 5GMM-DEREGISTERED.NORMAL-SERVICE. The UE shall delete any mapped 5G security context or partial native 5G security context.

If the registration rejected request was not for initiating an emergency PDU session, the UE shall perform a new registration procedure for initial registration.

9.1.5.2.8.3 Test description

9.1.5.2.8.3.1 Pre test conditions

System Simulator:

- 2 cells, NGC Cell A, and NGC Cell B belonging to the same PLMN and different TA in accordance with TS 38.508-1 [4] Table 6.3.2.2-1. Default system information combination as defined in TS 38.508-1 [4], sub-clause 4.4.3.1.2 is used in all cells when active.

UE:

None.

Preamble:

- Cell configuration in accordance with TS 38.508-1 [4] Table 6.2.2.1-3:
 - NGC Cell A "Serving cell"
 - NGC Cell B "Non-suitable "Off" cell"
- The UE is in test state 1N-A as defined in 38.508-1 [4], subclause 4.4A.2 on NGC Cell A.
 - During the initial registration:
 - In the list of tracking areas provided by the AMF (IE 'TAI list') contains only the TAI of NGC Cell A.

9.1.5.2.8.2 Test procedure sequence

Table 9.1.5.2.8.3.2-1: Main behaviour

| St | Procedure | Message Sequence | | TP | Verdict |
|---|---|------------------|-------------------------------|----|---------|
| | | U - S | Message | | |
| 1 | The SS configures:
- NGC Cell B as "Serving cell"
- NGC Cell A as "Non-Suitable "Off" cell". | - | - | - | - |
| - | EXCEPTION: Unless otherwise stated the following messages are exchange on NGC Cell B. | - | - | - | - |
| 2 | The UE transmits an REGISTRATION REQUEST message indicating "mobility registration updating". | --> | 5GMM: REGISTRATION REQUEST | - | - |
| 3 | The SS transmits an AUTHENTICATION REQUEST message to establish a new security context. | <-- | 5GMM: AUTHENTICATION REQUEST | - | - |
| 4 | The UE transmits an AUTHENTICATION RESPONSE message. | --> | 5GMM: AUTHENTICATION RESPONSE | - | - |
| 5 | The SS transmits a REGISTRATION REJECT message including 5GMM cause value #10 (implicitly de-registered) prior to initiating a SMC to take into account the created during the steps 3-4 partial native 5G security context. (NOTE 1) | <-- | REGISTRATION REJECT | - | - |
| 6 | SS releases the RRC connection. | - | - | - | - |
| 7-9 | Steps 1-3 from the generic procedure for UE initial Registration as specified in TS 38.508-1 [4], subclause 4.5.2, Table 4.5.2.2-2 (connectivity <i>NR</i>) take place. | - | - | - | - |
| 10 | Check: Does the UE send a REGISTRATION REQUEST message, 5GS registration type IE set to Initial registration? | --> | 5GMM: REGISTRATION REQUEST | 1 | P |
| 11 | The SS transmits a SECURITY MODE COMMAND message indicating the ngKSI of the partial native 5G security context assigned in the AUTHENTICATION REQUEST message sent in step 3. | <-- | 5GMM: SECURITY MODE COMMAND | - | - |
| 12 | The UE transmits a SECURITY MODE REJECT message. | --> | 5GMM: SECURITY MODE REJECT | 1 | P |
| 13-27a | Steps 5-19a1 from the generic procedure for UE initial Registration as specified in TS 38.508-1 [4], subclause 4.5.2, Table 4.5.2.2-2 (connectivity <i>NR</i>) take place. | - | - | - | - |
| NOTE 1: This 5GMM cause is sent to the UE either if the network has implicitly de-registered the UE, e.g. after the implicit de-registration timer has expired, or if the 5GMM context data related to the subscription does not exist in the AMF e.g. because of a AMF restart, or because of a registration request for mobility or registration update is routed to a new AMF (see TS 24.301 [22], subclause A.1). The latter is an example when the serving AMF will not initiate a security mode control procedure after the primary authentication and key agreement procedure. | | | | | |

9.1.5.2.8.3.3 Specific message contents

Table 9.1.5.2.8.3.3-1: REGISTRATION REQUEST (step 2, Table 9.1.5.2.8.3.2-1)

| Derivation Path: TS 38.508-1 [4], Table 4.7.1-6. | | | |
|--|--|---|-----------|
| Information Element | Value/remark | Comment | Condition |
| 5GS registration type | '00xxx010' | mobility registration updating
x - not checked | |
| ngKSI | Active ngKSI assigned in the Preamble | | |
| 5GS mobile identity | Active 5G-GUTI assigned in the Preamble | | |
| Last visited registered TAI | The TAI of the NGC Cell A, see TS 38.508-1 [4] Table 6.3.2.2-1 | | |

Table 9.1.5.2.8.3.3-2: REGISTRATION REJECT (step 5, Table 9.1.5.2.8.3.2-1)

| Derivation Path: TS 38.508-1 [4], Table 4.7.1-9. | | | |
|--|--------------|--------------------------------|-----------|
| Information Element | Value/remark | Comment | Condition |
| 5GMM cause | '0000 1010'B | #10 - implicitly de-registered | |

Table 9.1.5.2.8.3.3-3: REGISTRATION REQUEST (step 10, Table 9.1.5.2.8.3.2-1)

| Derivation path: TS 38.508-1 [4], Table 4.7.1-6. | | | |
|--|--|---|-----------|
| Information Element | Value/remark | Comment | Condition |
| 5GS registration type | '00xxx001' | Initial registration
x - not checked | |
| ngKSI | ngKSI assigned in the preamble | Native current security context is still present | |
| 5GS mobile identity | Active 5G-GUTI assigned in the preamble | | |
| Non-current native NAS key set identifier | Not present | partial native 5G security context has been deleted | |
| Last visited registered TAI | The TAI of the NGC Cell A, see TS 38.508-1 [4] Table 6.3.2.2-1 | | |

Table 9.1.5.2.8.3.3-4: SECURITY MODE COMMAND (step 11, Table 9.1.5.2.8.3.2-1)

| Derivation Path: TS 38.508-1 [4], Table 4.7.1-25. | | | |
|---|---|---------|-----------|
| Information Element | Value/remark | Comment | Condition |
| ngKSI | The ngKSI of the partial native 5G security context assigned in the AUTHENTICATION REQUEST message sent in step 3 | | |

Table 9.1.5.2.8.3.3-5: SECURITY MODE REJECT (step 12, Table 9.1.5.2.8.3.2-1)

| Derivation Path: TS 38.508-1 [4], Table 4.7.1-25. | | | |
|---|--------------|---|-----------|
| Information Element | Value/remark | Comment | Condition |
| 5GMM cause | '0001 1000' | #24 - Security mode rejected, unspecified | |

9.1.5.2.9 Mobility and periodic registration update / Abnormal / Change of cell into a new tracking area, collision with generic UE configuration update procedure

9.1.5.2.9.1 Test Purpose (TP)

(1)

void

Editor's Note: TP1 will be reinstated if a reliable test method to verify conformance requirements can be established.

(2)

```
with { UE initiates a Mobility and periodic registration procedure in 5GMM-REGISTERED state }
ensure that {
  when { UE receives a CONFIGURATION UPDATE COMMAND message before the registration procedure for
mobility and periodic registration update has been completed }
  then { UE shall ignore the message and proceed with the mobility and periodic registration
update procedure }
}
```

9.1.5.2.9.2 Conformance requirements

References: The conformance requirements covered in the present TC are specified in: TS 24.501, clauses 5.5.1.3.7 and 5.4.4.5. Unless otherwise stated these are Rel-15 requirements.

[TS 24.501, clause 5.5.1.3.7]

The following abnormal cases can be identified:

...

f) Change of cell into a new tracking area.

If a cell change into a new tracking area occurs before the registration procedure for mobility and periodic registration update is completed, the registration procedure for mobility and periodic registration update shall be aborted and re-initiated immediately. The UE shall set the 5GS update status to 5U2 NOT UPDATED.

...

h) Registration procedure for mobility and periodic registration update and generic UE configuration update procedure collision.

If the UE receives a CONFIGURATION UPDATE COMMAND message before the registration procedure for mobility and periodic registration update has been completed, UE shall behave as specified in subclause 5.4.4.5.

[TS 24.501, clause 5.4.4.5]

The following abnormal cases can be identified:

...

d) Generic UE configuration update and registration procedure for mobility and periodic registration update collision

If the UE receives a CONFIGURATION UPDATE COMMAND message before the ongoing registration procedure for mobility and periodic registration update has been completed, and the Configuration update

indication IE in the CONFIGURATION UPDATE COMMAND message indicates that the acknowledgement is requested, then the UE shall ignore the CONFIGURATION UPDATE COMMAND message and proceed with registration procedure for mobility and periodic update procedure. Otherwise the UE shall proceed with both the procedures.

9.1.5.2.9.3 Test description

9.1.5.2.9.3.1 Pre-test conditions

System Simulator:

- 2 NGC cells with system information combination NR-2 in accordance with TS 38.508-1[4] sub-clause 4.4.3.1.2.
- NGC cell A configured as "Serving cell" according to TS 38.508-1 [4] Table 6.2.2.1-3 for FR1 or Table 6.2.2.2-2 for FR2, HPLMN, TAI-1
- NGC cell B configured as "Non-Suitable cell" according to TS 38.508-1 [4] Table 6.2.2.1-3 for FR1 or Table 6.2.2.2-2 for FR2, HPLMN, TAI-2

UE:

None.

Preamble:

- The UE is in state 1N-A on NGC cell A according to TS 38.508-1 [4] Table 4.4A.2-1.

9.1.5.2.9.3.2 Test procedure sequence

Table 9.1.5.2.9.3.2-1: Main behaviour

| St | Procedure | Message Sequence | | TP | Verdict |
|-------|---|------------------|-------------------------------|----|---------|
| | | U - S | Message | | |
| - | The following messages are to be observed on NGC cell B unless explicitly stated otherwise. | - | - | - | - |
| 1 | Change NGC cell A to "Non-Suitable "Off" cell".
Change NGC cell B to "Serving cell". | - | - | - | - |
| 2-4 | Steps 1-3 in TS 38.508-1 [4] Table 4.9.5.2.2-1 are performed. | - | - | - | - |
| 5 | The SS transmits a CONFIGURATION UPDATE COMMAND message with the Configuration update indication IE indicating that the acknowledgement is requested. | <-- | CONFIGURATION UPDATE COMMAND | - | - |
| 6 | Check: Does the UE transmit a CONFIGURATION UPDATE COMPLETE message within the expiry of T3555? | --> | CONFIGURATION UPDATE COMPLETE | 2 | F |
| 7 | Step 4 in TS 38.508-1 [4] Table 4.9.5.2.2-1 are performed with a new assigned 5G-GUTI in the REGISTRATION ACCEPT message. | - | - | - | - |
| 8 | Check: Does the UE transmit a REGISTRATION COMPLETE message? | --> | REGISTRATION COMPLETE | 2 | P |
| 9 | The SS releases the RRC connection. | - | - | - | - |
| 10-15 | Void | - | - | - | - |

9.1.5.2.9.3.3 Specific message contents

Table 9.1.5.2.9.3.3-1: REGISTRATION REQUEST (steps 4 Table 9.1.5.2.9.3.2-1)

| Derivation path: TS 38.508-1 [4], Table 4.7.1-6 | | | |
|---|--------------|--------------------------------|-----------|
| Information Element | Value/remark | Comment | Condition |
| 5GS registration type | | | |
| 5GS registration type value | '010'B | Mobility registration updating | |

Table 9.1.5.2.9.3.3-2: CONFIGURATION UPDATE COMMAND (step 5 Table 9.1.5.2.9.3.2-1)

| Derivation path: TS 38.508-1 [4], Table 4.7.1-19 | | | |
|--|--------------|---------------------------|-----------|
| Information Element | Value/remark | Comment | Condition |
| Configuration update indication | Not Present | | |
| ACK | '1'B | acknowledgement requested | |

Table 9.1.5.2.9.3.3-3: REGISTRATION ACCEPT (step 7 Table 9.1.5.2.9.3.2-1)

| Derivation path: TS 38.508-1 [4], Table 4.7.1-7 | | | |
|---|--------------|---|-----------|
| Information Element | Value/remark | Comment | Condition |
| T3512 value | | | |
| Timer value | '0 0010'B | 2 minutes | |
| Unit | '101'B | value is incremented in multiples of 1 minute | |

Table 9.1.5.2.9.3.3-4: Void)**Table 9.1.5.2.9.3.3-5: Void**

9.1.6 De-registration

9.1.6.1 UE-initiated de-registration

9.1.6.1.1 UE-initiated de-registration / Switch off / Abnormal / De-registration and 5GMM common procedure collision

9.1.6.1.1.1 Test Purpose (TP)

(1)

```

with { the UE in 5GMM-REGISTERED state }
ensure that {
  when { the UE is switched off }
  then { the UE shall send DEREGISTRATION REQUEST message with De-registration type IE indicated to "Switch off" }
}

```

(2)

```

with { the UE in 5GMM-DEREGISTERED-INITIATED state }
ensure that {
  when { the UE receives a DEREGISTRATION REQUEST message before the UE-initiated de-registration procedure has been completed }
}

```

```

    then { the UE ignores the message and shall continue de-registration procedure }
  }

```

(3)

```

with { the UE in 5GMM-DEREGISTERED-INITIATED state }
ensure that {
  when { the UE receives a 5GMM common procedure before the UE-initiated de-registration procedure
has been completed }
  then { the UE ignores the message and shall continue de-registration procedure }
}

```

(4)

```

with { the UE supports remove USIM without power down and in 5GMM-REGISTERED state }
ensure that {
  when { the USIM is removed from the UE }
  then { the UE shall send DEREGISTRATION REQUEST message with De-registration type IE indicated
to "Switch off" }
}

```

9.1.6.1.1.2 Conformance requirements

References: The conformance requirements covered in the present TC are specified in: TS 24.501, clauses 5.5.2.1, 5.5.2.2.1 and 5.5.2.2.6. Unless otherwise stated these are Rel-15 requirements.

[TS 24.501, clause 5.5.2.1]

The de-registration procedure is used:

- a) by the UE to de-register for 5GS services over 3GPP access when the UE is registered over 3GPP access;;
- b) by the UE to de-register for 5GS services over 3GPP access, non-3GPP access, or both when the UE is registered in the same PLMN over both accesses;
- c) by the network to inform the UE that it is deregistered for 5GS services over 3GPP access when the UE is registered over 3GPP access;
- d) by the network to inform the UE that it is deregistered for 5GS services over 3GPP access, non-3GPP access, or both when the UE is registered in the same PLMN over both accesses; and
- e) by the network to inform the UE to re-register to the network.

The de-registration procedure with appropriate de-registration type shall be invoked by the UE:

- a) if the UE is switched off; and
- b) as part of the eCall inactivity procedure defined in subclause 5.5.3.

The de-registration procedure with appropriate de-registration type shall be invoked by the network:

- a) if the network informs whether the UE should re-register to the network.

The de-registration procedure with appropriate access type shall be invoked by the UE:

- a) if the UE wants to de-register for 5GS services over 3GPP access when the UE is registered over 3GPP access;
or
- b) the UE wants to de-register for 5GS services over 3GPP access, non-3GPP access, or both when the UE is registered in the same PLMN over both accesses.

If the de-registration procedure is triggered due to USIM removal, the UE shall indicate "switch off" in the de-registration type IE.

If the de-registration procedure is requested by the UDM for a UE that has an emergency PDU session, the AMF shall not send a DEREGISTRATION REQUEST message to the UE.

If the de-registration procedure for 5GS services is performed, the PDU sessions, if any, for this particular UE are released locally without peer-to-peer signalling between the UE and the network.

The UE is allowed to initiate the de-registration procedure even if the timer T3346 is running.

NOTE: When the UE has no PDU sessions over non-3GPP access, or the UE moves all the PDU sessions over a non-3GPP access to a 3GPP access, the UE and the AMF need not initiate de-registration over the non-3GPP access.

The AMF shall provide the UE with a non-3GPP de-registration timer.

[TS 24.501, clause 5.5.2.2.1]

The de-registration procedure is initiated by the UE by sending a DEREGISTRATION REQUEST message (see example in figure 5.5.2.2.1). The De-registration type IE included in the message indicates whether the de-registration procedure is due to a "switch off" or not. The access type included in the message indicates whether the de-registration procedure is:

- a) for 5GS services over 3GPP access when the UE is registered over 3GPP access only;
- b) for 5GS services over non-3GPP access when the UE is registered over non-3GPP access only; or
- c) for 5GS services over 3GPP access, non-3GPP access or both 3GPP access and non-3GPP access when the UE is registered in the same PLMN over both accesses.

If the UE has a valid 5G-GUTI, the UE shall populate the 5GS mobile identity IE with the valid 5G-GUTI. If the UE does not have a valid 5G-GUTI, the UE shall populate the 5GS mobile identity IE with its SUCI.

If the UE does not have a valid 5G-GUTI and it does not have a valid SUCI, then the UE shall populate the 5GS mobile identity IE with its PEI.

If the de-registration request is not due to switch off and the UE is in the state 5GMM-REGISTERED or 5GMM-REGISTERED-INITIATED, timer T3521 shall be started in the UE after the DEREGISTRATION REQUEST message has been sent. The UE shall enter the state 5GMM-DEREGISTERED-INITIATED.

If the UE is to be switched off, the UE shall try for a period of 5 seconds to send the DEREGISTRATION REQUEST message. During this period, the UE may be switched off as soon as the DEREGISTRATION REQUEST message has been sent.

[TS 24.501, clause 5.5.2.2.6]

...

- d) De-registration procedure collision.

De-registration containing de-registration type "switch off":

- If the UE receives a DEREGISTRATION REQUEST message before the UE-initiated de-registration procedure has been completed, this message shall be ignored and the UE-initiated de-registration procedure shall continue.

Otherwise:

- If the UE receives a DEREGISTRATION REQUEST message before the UE-initiated de-registration procedure has been completed, it shall treat the message as specified in subclause 5.5.2.3.2 with the following modification:
 - If the DEREGISTRATION REQUEST message received by the UE contains de-registration type "re-registration required", and the UE-initiated de-registration procedure is with de-registration type "normal de-registration", the UE need not initiate the registration procedure for initial registration.

- e) De-registration and 5GMM common procedure collision.

De-registration containing de-registration type "switch off":

- If the UE receives a message used in a 5GMM common procedure before the de-registration procedure has been completed, this message shall be ignored and the de-registration procedure shall continue.

Otherwise:

- If the UE receives a message used in a 5GMM common procedure before the de-registration procedure has been completed, both the 5GMM common procedure and the de-registration procedure shall continue.

9.1.6.1.1.3 Test description

9.1.6.1.1.3.1 Pre-test conditions

System Simulator:

- NGC Cell A.

UE:

- None.

Preamble:

- The UE is in state 3N-A on NGC Cell A according to TS 38.508-1[4].

9.1.6.1.1.3.2 Test procedure sequence

Table 9.1.6.1.1.3.2-1: Main behaviour

| St | Procedure | Message Sequence | | TP | Verdict |
|------|---|------------------|------------------------|----|---------|
| | | U - S | Message | | |
| 0 | SS stops sending RLC acknowledgments. | - | - | - | - |
| 1 | Cause switch off | - | - | - | - |
| 2 | Check: Does the UE transmit a DEREGISTRATION REQUEST with the De-registration type IE indicating "switch off"? | --> | DEREGISTRATION REQUEST | 1 | P |
| 3 | The SS transmits a DEREGISTRATION REQUEST message. | <-- | DEREGISTRATION REQUEST | - | - |
| 3A | SS resumes sending RLC acknowledgments | - | - | - | - |
| 4 | Check: Does the UE transmit a DEREGISTRATION ACCEPT message within 6 seconds (T3522)? | --> | DEREGISTRATION ACCEPT | 2 | F |
| 5 | The SS releases the RRC connection. | - | - | - | - |
| 6 | Switch on the UE | - | - | - | - |
| 7 | The UE performs Registration procedure as specified in TS 38.508-1 [4] subclause 4.5.2 with 'connected without release'. | - | - | - | - |
| 7A | SS stops sending RLC acknowledgments. | - | - | - | - |
| 8 | Cause switch off. | - | - | - | - |
| 9 | The UE transmits a DEREGISTRATION REQUEST with the De-registration type IE indicating "switch off". | --> | DEREGISTRATION REQUEST | - | - |
| 10 | The SS transmits an IDENTITY REQUEST message. | <-- | IDENTITY REQUEST | - | - |
| 10A | SS resumes sending RLC acknowledgments | - | - | - | - |
| 11 | Check: Does the UE transmit an IDENTITY RESPONSE message within 6 seconds (T3570)? | --> | IDENTITY RESPONSE | 3 | F |
| 12 | The SS releases the RRC connection. | - | - | - | - |
| - | EXCEPTION: Steps 13a1 to 13a4 describe behaviour that depends on the UE capability; the "lower case letter" identifies a step sequence that take place if the UE supports remove USIM without power down: pc_USIM_Removal = TRUE [29] | - | - | - | - |
| 13a1 | Switch on the UE | - | - | - | - |
| 13a2 | The UE performs Registration procedure as specified in TS 38.508-1 [4] subclause 4.5.2 with 'connected without release'. | - | - | - | - |
| 13a3 | Cause removal of USIM from the UE without powering down. | - | - | - | - |
| 13a4 | Check: Does the UE transmit a DEREGISTRATION REQUEST with the De-registration type IE indicating "switch off"? | --> | DEREGISTRATION REQUEST | 4 | P |

9.1.6.1.1.3.3 Specific message contents

Table 9.1.6.1.1.3.3-1: DEREGISTRATION REQUEST (Steps 2, 9 and 13a4, Table 9.1.6.1.1.3.2-1)

| Derivation path: TS 38.508-1 [4], table 4.7.1-12 | | | |
|--|--------------|---------|-----------|
| Information Element | Value/Remark | Comment | Condition |
| De-registration type | | | |
| Switch off | '1'B | | |

9.1.6.1.2 UE-initiated de-registration / Normal de-registration / Abnormal / Transmission failure without TAI change from lower layers, De-registration and 5GMM common procedure collision, T3521 timeout

9.1.6.1.2.1 Test Purpose (TP)

(1)

```
with { the UE in 5GMM-REGISTERED state }
ensure that {
  when { the UE initiates "normal de-registration" type deregistration from 5GS services over 3GPP access }
  then { the UE sends DEREGISTRATION REQUEST message with De-registration type IE indicated to "Normal de-registration" and starts timer T3521 }
}
```

(2)

```
with { the UE in 5GMM-DEREGISTERED-INTIATED state }
ensure that {
  when { Transmission failure of DEREGISTRATION REQUEST message indication without TAI change from lower layers }
  then { the UE restarts the de-registration procedure }
}
```

(3)

```
with { the UE in 5GMM-DEREGISTERED-INTIATED state }
ensure that {
  when { the UE receives a message used in a 5GMM common procedure before the de-registration procedure has been completed }
  then { both the 5GMM common procedure and the de-registration procedure shall continue }
}
```

(4)

```
with { the UE in 5GMM-DEREGISTERED-INTIATED state }
ensure that {
  when { the first four expiries of the timer T3521 }
  then { the UE shall retransmit the DEREGISTRATION REQUEST message and shall reset and restart timer T3521 }
}
```

(5)

```
with { the UE in 5GMM-DEREGISTERED-INTIATED state }
ensure that {
  when { On the fifth expiry of timer T3521 }
  then { the detach procedure shall be aborted and the UE performs local detach }
}
```

9.1.6.1.2.2 Conformance requirements

References: The conformance requirements covered in the current TC are specified in: TS 24.501 clause 5.5.2.2.6 and TS 38.331 clause 5.7.2.4. Unless otherwise stated these are Rel-15 requirements.

[TS 24.501, clause 5.5.2.2.6]

c) T3521 timeout.

On the first four expiries of the timer, the UE shall retransmit the DEREGISTRATION REQUEST message and shall reset and restart timer T3521. On the fifth expiry of timer T3521, the de-registration procedure shall be aborted and the UE proceeds as follows:

- 1) if the de-registration procedure was performed due to disabling of 5GS services, the UE shall enter the 5GMM-NULL state; or

- 2) if the de-registration type "normal de-registration" was requested for reasons other than disabling of 5GS services, the UE shall enter the 5GMM-DEREGISTERED state.

...

- e) De-registration and 5GMM common procedure collision.

De-registration containing de-registration type "switch off":

- If the UE receives a message used in a 5GMM common procedure before the de-registration procedure has been completed, this message shall be ignored and the de-registration procedure shall continue.

Otherwise:

- If the UE receives a message used in a 5GMM common procedure before the de-registration procedure has been completed, both the 5GMM common procedure and the de-registration procedure shall continue.

- h) Transmission failure of DEREGISTRATION REQUEST message indication without TAI change from lower layers.

The UE shall restart the de-registration procedure.

[TS 38.331, clause 5.7.2.4]

The UE shall:

- 1> if AS security is not started and radio link failure occurs before the successful delivery of ULInformationTransfer messages has been confirmed by lower layers; or
- 1> if mobility (i.e. handover, RRC connection re-establishment) occurs before the successful delivery of ULInformationTransfer messages has been confirmed by lower layers:
 - 2> inform upper layers about the possible failure to deliver the information contained in the concerned ULInformationTransfer messages.

9.1.6.1.2.3 Test description

9.1.6.1.2.3.1 Pre-test conditions

System Simulator:

- NGC Cell A and NGC Cell B
- Both cells are configured as per table 6.3.2.2-1 TS 38.508-1 [4] with the below exceptions

Table 9.1.6.1.2.3.1–1: Cell configuration

| NGC Cell | TAC | TAI |
|----------|-----|-------|
| B | 1 | TAI-1 |

UE:

- None.

Preamble:

- the UE is in state 3N-A on NGC Cell A according to TS 38.508-1 [4].

9.1.6.1.2.3.2 Test procedure sequence

Table 9.1.6.1.2.3.2-1: Main behaviour

| St | Procedure | Message Sequence | | TP | Verdict |
|---------|--|------------------|---|----|---------|
| | | U - S | Message | | |
| 0 | The SS configures:
- NGC Cell B as "Suitable neighbour cell". | | | | |
| 0A | SS transmits NR RRCReconfiguration message to configure specific maxRetxThreshold for NGC Cell A. | <-- | NR RRC: <i>RRCReconfiguration</i> | - | - |
| 0B | The UE transmits NR RRCReconfigurationComplete message. | --> | NR RRC: <i>RRCReconfigurationComplete</i> | - | - |
| 1 | The SS is configured not send RLC ACK for the message sent in step 2. | - | - | - | - |
| 1A | AT or MMI command to cause UE to initiate de-registration. | - | - | - | - |
| - | The following messages are to be observed on Cell A unless explicitly stated otherwise. | - | - | - | - |
| 2 | Does the UE transmit a DEREGISTRATION REQUEST message with De-registration type IE indicating "Normal de-registration"? The UE starts timer T3521. | --> | 5GMM: DEREGISTRATION REQUEST | 1 | P |
| 3 | Void | - | - | - | - |
| 3A | The SS transmits an <i>RRCReconfiguration</i> message including reconfigurationWithSync with rach-ConfigDedicated to order the UE to perform intra-frequency handover to NGC Cell B. | <-- | NR RRC: <i>RRCReconfiguration</i> | - | - |
| - | The following messages are to be observed on Cell B unless explicitly stated otherwise. | - | - | - | - |
| 3B | The UE transmits an <i>RRCReconfigurationComplete</i> message. | --> | NR RRC: <i>RRCReconfigurationComplete</i> | - | - |
| 4 | Check: Does the UE restart the de-registration procedure by sending DEREGISTRATION REQUEST message? Timer T3521 is started. | --> | 5GMM: DEREGISTRATION REQUEST | 2 | P |
| 4A | The SS configures:
- NGC Cell A as "Non-suitable "Off" cell". | - | - | - | - |
| 5 | With T3521 still running the SS shall send AUTHENTICATION REQUEST. | <-- | 5GMM: AUTHENTICATION REQUEST | - | - |
| 6 | Check: Does the UE transmit an AUTHENTICATION RESPONSE message? | --> | 5GMM: AUTHENTICATION RESPONSE | 3 | P |
| 7 | SS responds with DEREGISTRATION ACCEPT message. | <-- | 5GMM: DEREGISTRATION ACCEPT | - | - |
| 8 | The SS releases the RRC connection. | - | - | - | - |
| 9 | AT or MMI command to cause UE to initiate registration. | - | - | - | - |
| 10-24a4 | Steps 2-19a1 of Table 4.5.2.2-2 of the generic procedure in TS 38.508-1 [4] are performed to complete the registration. | - | - | - | - |
| 25 | Cause UE to initiate de-registration. | - | - | - | - |
| 26 | Check: Does the UE transmit a DEREGISTRATION REQUEST message with De-registration type IE indicating "Normal de-registration"? The UE starts timer T3521. | --> | 5GMM: DEREGISTRATION REQUEST | 1 | P |
| 27 | SS does not respond to the DEREGISTRATION REQUEST message. | - | - | - | - |
| 28 | Check: When the timer T3521 expires does the UE re-transmit DEREGISTRATION REQUEST message? Timer T3521 is re-started (1 st expiry). | --> | 5GMM: DEREGISTRATION REQUEST | 4 | P |
| 29 | The SS does not respond to the DEREGISTRATION REQUEST message. | - | - | - | - |
| 30 | Check: When the timer T3521 expires does the UE re-transmit DEREGISTRATION REQUEST message? Timer T3521 is re-started (2 nd expiry). | --> | 5GMM: DEREGISTRATION REQUEST | 4 | P |

| | | | | | |
|--|---|-----|------------------------------|---|---|
| 31 | The SS does not respond to the DEREGISTRATION REQUEST message. | - | - | - | - |
| 32 | Check: When the timer T3521 expires does the UE re-transmit DEREGISTRATION REQUEST message? Timer T3521 is re-started (3 rd expiry). | --> | 5GMM: DEREGISTRATION REQUEST | 4 | P |
| 33 | The SS does not respond to the DEREGISTRATION REQUEST message. | - | - | - | - |
| 34 | Check: When the timer T3521 expires does the UE re-transmit DEREGISTRATION REQUEST message? Timer T3521 is re-started (4 th expiry). | --> | 5GMM: DEREGISTRATION REQUEST | 4 | P |
| 35 | The SS does not respond to the DEREGISTRATION REQUEST message. | - | - | - | - |
| 36 | Check: When the timer T3521 expires does the UE re-transmit DEREGISTRATION REQUEST message in 10s? The UE shall abort the de-registration procedure and enter the 5GMM-DEREGISTERED (5 th expiry). | --> | 5GMM: DEREGISTRATION REQUEST | 5 | F |
| Note: T3521 value is specified as 15s in TS 24.501 [22]. | | | | | |

9.1.6.1.2.3.3 Specific message contents

Table 9.1.6.1.2.3.3-0A: RRCReconfiguration (step 0A Table 9.1.6.1.2.3.2-1)

| Derivation Path: TS 38.508-1 [4], Table 4.6.1-13 | | | |
|--|---|---|-----------|
| Information Element | Value/remark | Comment | Condition |
| RRCReconfiguration ::= SEQUENCE { | | | |
| criticalExtensions CHOICE { | | | |
| rrcReconfiguration SEQUENCE { | | | |
| nonCriticalExtension SEQUENCE { | | | |
| masterCellGroup | CellGroupConfig with condition SRB2_DRB1 configured in the preamble | OCTET STRING (CONTAINING CellGroupConfig) | |
| } | | | |
| } | | | |
| } | | | |
| } | | | |

Table 9.1.6.1.2.3.3-0B: CellGroupConfig (Table 9.1.6.1.2.3.3-0A)

| Derivation Path: TS 38.508-1 [4], Table 4.6.1-19 | | | |
|---|--------------------------------------|---------|------------|
| Information Element | Value/remark | Comment | Condition |
| CellGroupConfig ::= SEQUENCE { | | | |
| rlc-BearerToAddModList SEQUENCE (SIZE(1..maxLCH)) OF RLC-BearerConfig { | 1 entry | | SRB2_DRB 1 |
| RLC-Bearer-Config[1] | RLC-BearerConfig with condition SRB2 | | |
| } | | | |
| } | | | |

Table 9.1.6.1.2.3.3-0C: RLC-BearerConfig (Table 9.1.6.1.2.3.3-0B)

| Derivation Path: TS 38.508-1 [4], Table 4.6.3-148 | | | |
|---|-------------------------------|---------|-----------|
| Information Element | Value/remark | Comment | Condition |
| RLC-BearerConfig ::= SEQUENCE { | | | |
| rlc-Config | RLC-Config using condition AM | | AM |
| } | | | |

Table 9.1.6.1.2.3.3-0D: RLC-Config (Table 9.1.6.1.2.3.3-0C)

| Derivation Path: TS 38.508-1 [4], Table 4.6.3-149 | | | |
|---|--------------|---------|-----------|
| Information Element | Value/remark | Comment | Condition |
| RLC-Config ::= CHOICE { | | | |
| am SEQUENCE { | | | AM |
| ul-AM-RLC SEQUENCE { | | | |
| maxRetxThreshold | t32 | | |
| } | | | |
| } | | | |
| } | | | |

Table 9.1.6.1.2.3.3-1: DEREGISTRATION REQUEST (steps 2, 4, 26, 28, 30, 32 and 34, Table 9.1.6.1.2.3.2-1)

| Derivation path: TS 38.508-1 [4], Table 4.7.1-12 | | | |
|--|--------------|------------------------|-----------|
| Information Element | Value/remark | Comment | Condition |
| De-registration type | | | |
| Switch off | '0'B | Normal de-registration | |
| Access type | '01'B | 3GPP access | |

Table 9.1.6.1.2.3.3-2: RRCReconfiguration-HO (step 3A Table 9.1.6.1.2.3.2-1)

| Derivation path: TS 38.508-1 [4] Table 4.8.1-1A with condition RBConfig_KeyChange |
|---|
|---|

9.1.6.1.3 UE-initiated de-registration / Abnormal / Change of cell into a new tracking area

9.1.6.1.3.1 Test Purpose (TP)

(1)

```
with { UE in 5GMM-DEREGISTERED-INITIATED state and de-registration request is not due to switch off }
ensure that {
  when { UE changes into a new tracking area that is not in the stored TAI list }
  then { UE aborts the de-registration procedure and initiates a mobility registration procedure }
}
```

(2)

```
with { UE in 5GMM-REGISTERED-INITIATED state for a mobility registration procedure due to change of cell into a new tracking area list during UE-initiated de-registration procedure }
ensure that {
  when { UE receives REGISTRATION ACCEPT message }
  then { UE re-initiates the de-registration procedure after completing the mobility registration procedure }
}
```

(3)

void

9.1.6.1.3.2 Conformance requirements

References: The conformance requirements covered in the present TC are specified in: TS 24.501, clause 5.2.2.6. Unless otherwise stated these are Rel-15 requirements.

[TS 24.501 clause 5.2.2.6]

The following abnormal cases can be identified:

...

- f) Change of cell into a new tracking area.

If a cell change into a new tracking area that is not in the stored TAI list occurs before the UE-initiated de-registration procedure is completed, the de-registration procedure shall be aborted and re-initiated after successfully performing a registration procedure for mobility or periodic update used for mobility (i.e. the 5GS registration type IE set to "mobility registration updating" in the REGISTRATION REQUEST message). If the de-registration procedure was initiated due to removal of the USIM or the UE is to be switched off, the UE shall abort the de-registration procedure and enter the state 5GMM-DEREGISTERED.

9.1.6.1.3.3 Test description

9.1.6.1.3.3.1 Pre-test conditions

System Simulator:

- NGC Cell A belongs to Home PLMN and TAI-1 and set as serving cell;
- NGC Cell B belongs to Home PLMN and TAI-2 and set as Non-Suitable cell.

UE:

- None;

Preamble:

- The UE is in state 3N-A on NGC cell A according to TS 38.508-1 [4].

9.1.6.1.3.3.2 Test procedure sequence

Table 9.1.6.1.3.3.2-1: Main behaviour

| St | Procedure | Message Sequence | | TP | Verdict |
|-------|--|------------------|------------------------|----|---------|
| | | U - S | Message | | |
| - | The following messages are to be observed on NGC Cell A unless explicitly stated otherwise. | - | - | - | - |
| 1 | Cause UE to de-register for non Switch off reason using MMI or AT commands. | - | - | - | - |
| 2 | The UE transmits DEREGISTRATION REQUEST message. (The UE starts timer T3521) | --> | DEREGISTRATION REQUEST | | |
| 3 | The SS does not respond to DEREGISTRATION REQUEST message. | - | - | - | - |
| 4 | The SS configures NGC Cell A as the "suitable cell" and NGC Cell B as the "Serving cell".
Note: T3521 value is specified as 15s in TS 24.501 [22] and it is assumed that SS can configure cells within this time. | - | - | - | - |
| 5 | The SS transmits an <i>RRReconfiguration</i> message on NGC Cell A to order the UE to perform intra-frequency handover to NGC Cell B. | - | - | - | - |
| 6 | The UE transmits a <i>RRReconfigurationComplete</i> message on NGC Cell B to confirm the successful completion of the intra frequency handover. | - | - | - | - |
| - | The following messages are to be observed on NGC Cell B unless explicitly stated otherwise. | - | - | - | - |
| 7 | Check: Does the UE transmit a REGISTRATION REQUEST message with registration type value set to "mobility registration updating" | --> | REGISTRATION REQUEST | 1 | P |
| 8 -9 | Steps 4 to 5 of the generic procedure in TS 38.508-1 [4] subclause 4.9.5.2.2 | - | - | - | - |
| 10-22 | Void | | | | |
| 23 | Check: Does the UE transmit DEREGISTRATION REQUEST message? | --> | DEREGISTRATION REQUEST | 2 | P |
| 24 | The SS transmits DEREGISTRATION ACCEPT message. | <-- | DEREGISTRATION ACCEPT | - | - |
| 25 | The SS transmits an <i>RRRelease</i> message. | - | - | - | - |
| 26 | Check: Does the test result of the generic procedure in TS 38.508-1 [4] subclause 4.9.13 indicates that the UE doesn't responds to paging when paged with NG-5G-S-TMSI? | - | - | 2 | P |
| 27-35 | Void | - | - | - | - |

9.1.6.1.3.3.3 Specific message contents

Table 9.1.6.1.3.3.3-1: DEREGISTRATION REQUEST (steps 2 and 23, Table 9.1.6.1.3.3.2-1)

| Derivation path: TS 38.508-1 [4], Table 4.7.1-12 | | | |
|--|--------------|---|-----------|
| Information Element | Value/remark | Comment | Condition |
| De-registration type | | | |
| Switch off | '0'B | Normal de-registration | |
| Re-registration required | '0'B | Spare bit | |
| Access type | '01'B | 3GPP access | |
| 5GS mobile identity | 5G-GUTI | Same value as assigned in REGISTRATION ACCEPT | |

Table 9.1.6.1.3.3.3-2: RRCReconfiguration-HO (step 5, Table 9.1.6.1.3.3.2-1)

| Derivation Path: TS 38.508-1 [4], Table 4.8.1-1A with condition RBConfig_KeyChange |
|--|
|--|

Table 9.1.6.1.3.3.3-3: Void**Table 9.1.6.1.3.3.3-4: Void****Table 9.1.6.1.3.3.3-5: Void****Table 9.1.6.1.3.3.3-6: Void****Table 9.1.6.1.3.3.3-7: REGISTRATION REQUEST (step 7, Table 9.1.6.1.3.3.2-1)**

| Derivation path: TS 38.508-1 [4], Table 4.7.1-6 | | | |
|---|--------------|---------|-----------|
| Information Element | Value/remark | Comment | Condition |
| 5GS registration type value | '010'B | | Mobility |

Table 9.1.6.1.3.3.3-8: Void

9.1.6.1.4 Void

9.1.6.2 Network-initiated de-registration

9.1.6.2.1 Network-initiated de-registration / De-registration for 3GPP access / Re-registration required

9.1.6.2.1.1 Test Purpose (TP)

(1)

```

with { the UE in 5GMM-REGISTERED state }
ensure that {
  when { the SS sends a DEREGISTRATION REQUEST message indicates "re-registration required" and the
de-registration request is for 3GPP access }
  then { the UE sends a DEREGISTRATION ACCEPT message to the network and releases the existing NAS
signalling connection, then initiates an initial registration and also re-establishes any previously
established PDU sessions. }
}

```

9.1.6.2.1.2 Conformance requirements

References: The conformance requirement covered in the present TC is specified in: 3GPP TS 24.501 clauses 5.5.2.3.2. Unless otherwise stated these are Rel-15 requirements.

[TS 24.501 clause 5.5.2.3.2]

NOTE 1: When the de-registration type indicates "re-registration required", user interaction is necessary in some cases when the UE cannot re-establish the PDU session (s), if any, automatically.

...

Upon sending a DEREGISTRATION ACCEPT message, the UE shall delete the rejected NSSAI as specified in subclause 4.6.2.2.

If the de-registration type indicates "re-registration required", then the UE shall ignore the 5GMM cause IE if received.

If the de-registration type indicates "re-registration not required", the UE shall take the actions depending on the received 5GMM cause value:

#3 (Illegal UE);

...

As an implementation option, the UE may enter the state 5GMM-DEREGISTERED.PLMN-SEARCH in order to perform a PLMN selection according to 3GPP TS 23.122 [5].

9.1.6.2.1.3 Test description

9.1.6.2.1.3.1 Pre-test conditions

System Simulator:

- NGC Cell A.

UE:

- None.

Preamble:

- the UE is in state 3N-A on NGC Cell A according to TS 38.508-1 [4].

9.1.6.2.1.3.2 Test procedure sequence

Table 9.1.6.2.1.3.2-1: Main behaviour

| St | Procedure | Message Sequence | | TP | Verdict |
|------|--|------------------|---|----|---------|
| | | U - S | Message/PDU/SDU | | |
| 1 | The SS transmits a DEREGISTRATION REQUEST with indicates "re-registration required". | <-- | DEREGISTRATION REQUEST | - | - |
| 2 | Check: Does the UE transmits a DEREGISTRATION ACCEPT message? | --> | DEREGISTRATION ACCEPT | 1 | P |
| 3 | The SS releases RRC connection. | - | - | - | - |
| 4 | The UE transmits an <i>RRCSetupRequest</i> message. | --> | NR RRC: <i>RRCSetupRequest</i> | - | - |
| 5 | The SS transmits an <i>RRCSetup</i> message. | <-- | NR RRC: <i>RRCSetup</i> | - | - |
| 6 | Check: Does the UE transmits an <i>RRCSetupComplete</i> message and REGISTRATION REQUEST message with registration type set to "initial registration". | --> | NR RRC: <i>RRCSetupComplete</i>
5GMM: REGISTRATION REQUEST | 1 | P |
| 7-23 | Steps 5-20 of Table 4.5.2.2-2 of the generic procedure in TS 38.508-1 [4] are performed. | - | - | - | - |

9.1.6.2.1.3.3 Specific message contents

Table 9.1.6.2.1.3.3-1: DEREGISTRATION REQUEST (step 1, Table 9.1.6.2.1.3.2-1)

| Derivation path: TS 38.508-1 [4] Table 4.7.1-14 | | | |
|---|--------------|--------------------------|-----------|
| Information Element | Value/Remark | Comment | Condition |
| DEREGISTRATION type | | | |
| Switch off | '0'B | Normal de-registration | |
| Re-registration required | '1'B | re-registration required | |
| Access type | '01'B | 3GPP access | |

9.1.6.2.2 Network-initiated de-registration / De-registration for 3GPP access / Re-registration not required

9.1.6.2.2.1 Test Purpose (TP)

(1)

```

with { the UE in 5GMM-REGISTERED state }
ensure that {
  when { the SS sends a DEREGISTRATION REQUEST message indicates no 5GMM cause IE, "re-registration not required" and the de-registration request is for 3GPP access) }
  then { the UE deletes 5G-GUTI, TAI list, last visited registered TAI, list of equivalent PLMNs, ngKSI, sends a DEREGISTRATION ACCEPT message enter the state 5GMM-DEREGISTERED for 3GPP access }
}

```

9.1.6.2.2.2 Conformance requirements

References: The conformance requirements covered in the current TC are specified in: TS 24.501 clauses 5.5.2.3.2 and 5.5.2.3.4. Unless otherwise stated these are Rel-15 requirements.

[TS 24.501, clause 5.5.2.3.2]

Upon receiving the DEREGISTRATION REQUEST message, if the DEREGISTRATION REQUEST message indicates "re-registration not required" and the de-registration request is for 3GPP access, the UE shall perform a local release of the PDU sessions over 3GPP access, if any. The UE shall send a DEREGISTRATION ACCEPT message to the network and enter the state 5GMM-DEREGISTERED for 3GPP access.

[TS 24.501, clause 5.5.2.3.4]

- b) DEREGISTRATION REQUEST, other 5GMM cause values than those treated in subclause 5.5.2.3.2, cases of 5GMM cause value #11, #22 and #72 that are considered as abnormal cases according to subclause 5.5.2.3.2 or no 5GMM cause IE is included, and the De-registration type IE indicates "re-registration not required".

The UE shall delete 5G-GUTI, TAI list, last visited registered TAI, list of equivalent PLMNs, ngKSI, shall set the 5GS update status to 5U2 NOT UPDATED and shall start timer T3502.

A UE not supporting S1 mode may enter the state 5GMM-DEREGISTERED.PLMN-SEARCH in order to perform a PLMN selection according to 3GPP TS 23.122 [5]; otherwise the UE shall enter the state 5GMM-DEREGISTERED.ATTEMPTING-REGISTRATION.

9.1.6.2.2.3 Test description

9.1.6.2.2.3.1 Pre-test conditions

System Simulator:

- NGC Cell A.

UE:

- the UE is previously registered on 5GC, and when on 5GC, the UE is last authenticated and registered on NGC cell A using default message contents according to TS 38.508-1 [4];

Preamble:

- The UE is in state 3N-A on NGC Cell A according to TS 38.508-1 [4].
- The T3502 in UE set to 2 minutes.

9.1.6.2.2.3.2 Test procedure sequence

Table 9.1.6.2.2.3.2-1: Main behaviour

| St | Procedure | Message Sequence | | TP | Verdict |
|------------|---|------------------|------------------------------|----|---------|
| | | U – S | Message | | |
| 1 | SS sends a DEREGISTRATION REQUEST message indicates no 5GMM cause IE, "re-registration not required" and the de-registration request is for 3GPP access | <-- | 5GMM: DEREGISTRATION REQUEST | - | - |
| 2 | Check: Does the UE transmit a DEREGISTRATION ACCEPT message?
Note: Now UE should start timer T3502. | --> | 5GMM: DEREGISTRATION ACCEPT | 1 | P |
| 3 | The SS releases the RRC connection. | - | - | - | - |
| 4 | The SS waits 2 mins for T3502 to expire. | - | - | - | - |
| 5-22a
1 | Does the UE performs Steps 2-19a1 of Table 4.5.2.2-2 of the generic procedure in TS 38.508-1 [4]? | - | - | 1 | P |

9.1.6.2.2.3.3 Specific message contents

Table 9.1.6.2.2.3.3-1: Message REGISTRATION ACCEPT (preamble)

| Derivation path: TS 38.508-1 [4], Table 4.7.1-7 | | | |
|---|--------------|---------------------------|-----------|
| Information Element | Value/remark | Comment | Condition |
| T3502 Value | 2mins | | |
| Timer value | '0 0010'B | The timer value is 2mins. | |
| Unit | '001'B | | |

Table 9.1.6.2.2.3.3-2: Message DEREGISTRATION REQUEST (step 1, Table 9.1.6.2.2.3.2-1)

| Derivation path: TS 38.508-1 [4], Table 4.7.1-12 | | | |
|--|--------------|------------------------------|-----------|
| Information Element | Value/remark | Comment | Condition |
| De-registration type | | | |
| Switch off | '0'B | Normal de-registration | |
| Re-registration required | '0'B | re-registration not required | |
| Access type | '01'B | 3GPP access | |
| 5GMM cause | Not Present | | |

Table 9.1.6.2.2.3.3-3: Message REGISTRATION REQUEST (step7, Table 9.1.6.2.2.3.2-1)

| Derivation path: TS 38.508-1 [4], table 4.7.1-6 | | | |
|---|-------------------|---|-----------|
| Information Element | Value/Remark | Comment | Condition |
| ngKSI | | | |
| NAS key set identifier | '111'B | no key is available (UE to network) | |
| TSC | Any allowed value | TSC does not apply for NAS key set identifier value "111" | |
| 5GS mobile identity | The valid SUCI | | |
| Last visited registered TAI | Not present | | |

9.1.7 Service request

9.1.7.1 Service request / IDLE mode uplink user data transport / Rejected / Restricted service area, Abnormal / T3517, T3525

9.1.7.1.1 Test Purpose (TP)

(1)

```
with { the UE is in 5GMM-REGISTERED state and 5GMM-IDLE mode over 3GPP access }
ensure that {
when { UE has uplink user data pending }
then { the UE sends a SERVICE REQUEST message }
}
```

(2)

```
with { the UE sent a SERVICE REQUEST message }
ensure that {
when { UE receives a SERVICE REJECT message including an appropriate 5GMM cause value #28(Restricted service area) }
then { the UE performs the mobility registration update procedure }
}
```

(3)

```
with { the UE is in 5GMM-REGISTERED state and the UE has triggered the SERVICE REQUEST in 5GMM-IDLE mode }
ensure that {
when { T3517 expired }
then { the UE increases the service request attempt counter, aborts the procedure and release locally any resources allocated for the service request procedure }
}
```

(4)

```
with { the UE is in 5GMM-REGISTERED state and 5GMM-IDLE mode }
ensure that {
when { the service request attempt counter is equal to 5 }
then { the UE starts timer T3525 and not attempts service request until expiry of T3525 }
}
```

9.1.7.1.2 Conformance requirements

References: The conformance requirements covered in the current TC are specified in: TS 24.501, clause 5.6.1.1, 5.6.1.5 and 5.6.1.7. Unless otherwise stated these are Rel-15 requirements.

[TS 24.501, clause 5.6.1.1]

The purpose of the service request procedure is to change the 5GMM mode from 5GMM-IDLE to 5GMM-CONNECTED mode, and/or to request the establishment of user-plane resources for PDU sessions which are

established without user-plane resources. In latter case, the 5GMM mode can be the 5GMM-IDLE mode or the 5GMM-CONNECTED mode if the UE requires to establish user-plane resources for PDU sessions.

...

The UE shall invoke the service request procedure when:

...

d) the UE, in 5GMM-IDLE mode over 3GPP access, has uplink user data pending;

...

If one of the above criteria to invoke the service request procedure is fulfilled, then the service request procedure shall only be initiated by the UE when the following conditions are fulfilled:

- its 5GS update status is 5U1 UPDATED, and the TAI of the current serving cell is included in the TAI list; and
- no 5GMM specific procedure is ongoing.

The UE shall not invoke the service request procedure when the UE is in the state 5GMM-SERVICE-REQUEST-INITIATED.

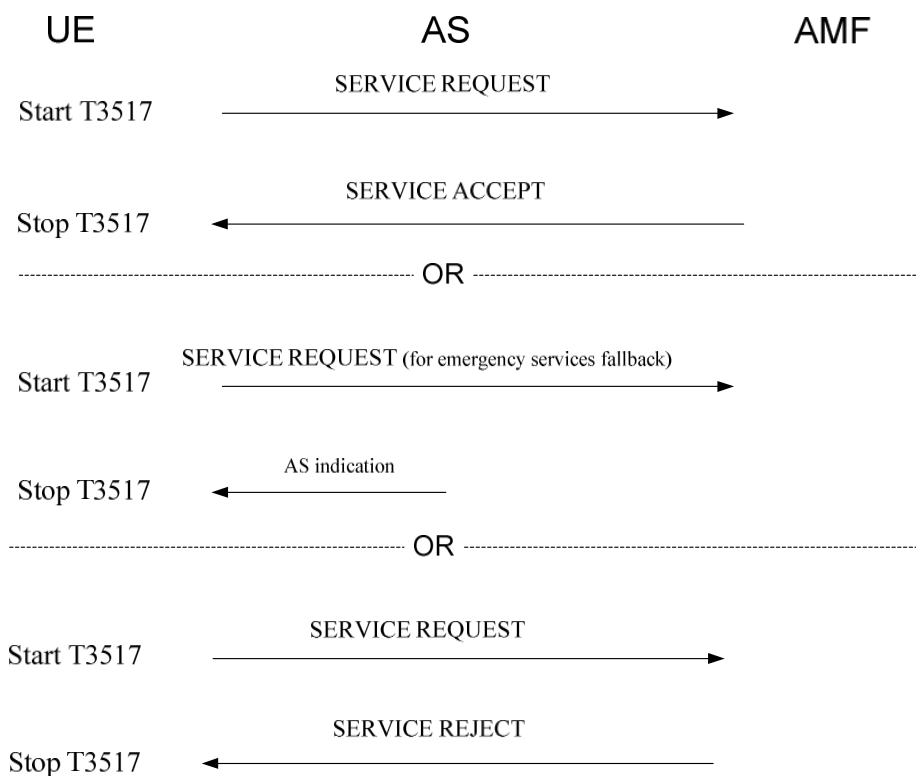

Figure 5.6.1.1.1: Service Request procedure

[TS 24.501, clause 5.6.1.5]

If the service request cannot be accepted, the network shall return a SERVICE REJECT message to the UE including an appropriate 5GMM cause value and stop timer T3517.

...

If the AMF determines that the UE is in a non-allowed area or is not in an allowed area as specified in subclause 5.3.5, then:

- a) if the service type IE in the SERVICE REQUEST message is set to "signalling" or "data", the AMF shall send a SERVICE REJECT message with the 5GMM cause value set to #28 "Restricted service area";

...

The UE shall take the following actions depending on the 5GMM cause value received in the SERVICE REJECT message.

#28 (Restricted service area).

The UE shall enter the state 5GMM-REGISTERED.NON-ALLOWED-SERVICE, and perform the registration procedure for mobility and periodic registration update unless the service type IE in the SERVICE REQUEST message was set to "elevated signalling" (see subclause 5.3.5 and 5.5.1.3).

If the service type IE in the SERVICE REQUEST message was set to "elevated signalling", the UE shall not re-initiate service request procedure until the UE enters an allowed area or leaves a non-allowed area, except for emergency services, high priority access or responding to paging or notification.

[TS 24.501, clause 5.6.1.7]

The following abnormal cases can be identified:

- a) T3517 expired.

The UE shall enter the state 5GMM-REGISTERED.

If the UE triggered the service request procedure in 5GMM-IDLE mode and the service type of the SERVICE REQUEST message was not set to "emergency services fallback", then the 5GMM sublayer shall increment the service request attempt counter, abort the procedure and release locally any resources allocated for the service request procedure. The service request attempt counter shall not be incremented, if:

- 1) the service request procedure is initiated to establish an emergency PDU session;
- 2) the UE has an emergency PDU session established;
- 3) the UE is a UE configured for high priority access in selected PLMN; or
- 4) the service request is initiated in response to paging or notification from the network.

If the service request attempt counter is greater than or equal to 5, the UE shall start timer T3525. Additionally, if the service request was initiated for an MO MMTTEL voice call, a notification that the service request was not accepted due to the UE having started timer T3525 shall be provided to the upper layers.

NOTE 1: This can result in the upper layers requesting implementation specific mechanisms, e.g. the MMTTEL voice call being attempted to another IP-CAN, or establishment of a CS voice call (if supported and not already attempted in the CS domain).

The UE shall not attempt service request until expiry of timer T3525 unless:

- 1) the service request is initiated in response to paging or notification from the network;
- 2) the UE is a UE configured for high priority access in selected PLMN;
- 3) the service request is initiated to establish an emergency PDU session;
- 4) the UE has an emergency PDU session established; or
- 5) the UE is registered in a new PLMN.

NOTE 2: The NAS signalling connection can also be released if the UE deems that the network has failed the authentication check as specified in subclause 5.4.1.3.7.

9.1.7.1.3 Test description

9.1.7.1.3.1 Pre-test conditions

System Simulator:

- NGC Cell A.

UE:

- None.

Preamble:

- The UE is in state 3N-A with UE test loop mode B active ($T_{\text{delay_modeB}} = 5$) according to TS 38.508-1 [4].

9.1.7.1.3.2 Test procedure sequence

Table 9.1.7.1.3.2-1: Main behaviour

| St | Procedure | Message Sequence | | TP | Verdict |
|--------|---|------------------|-----------------------|----|---------|
| | | U - S | Message | | |
| 1 | The SS configures:
- NGC Cell A as the "Serving cell". | - | - | - | - |
| 2 | The SS transmits one IP Packet to the UE. | <-- | IP packet | - | - |
| 3 | The SS waits 1 second after the IP packet has been transmitted in step 2 and then transmits an RRCRelease message. (Note 1) | - | - | - | - |
| 4 | Check: Does UE transmit a SERVICE REQUEST message with Service type IE set to 'data'? (Note 2) | --> | SERVICE REQUEST | 1 | P |
| 5 | The SS transmits a SERVICE REJECT message with 5GMM cause = "Restricted service area". | <-- | SERVICE REJECT | - | - |
| 6-7 | Void | - | - | - | - |
| 7AA | The SS starts timer 5 sec.
Note: An arbitrary chosen timer to avoid message crossing. | - | - | - | - |
| | EXCEPTION: Steps 7ABa1 to 7ABb3 describe behaviour that depends on the UE implementation; the "lower case letter" identifies a step sequence that take place if the UE is implemented in a certain way. | - | - | - | - |
| 7ABa 1 | UE transmit REGISTRATION REQUEST message.
NOTE: Allowed for Rel-15 UEs. | --> | REGISTRATION REQUEST | 2 | P |
| 7ABa 2 | Stop timer 5 sec. | - | - | - | - |
| 7ABb 1 | Timer 5 sec expires. | - | - | - | - |
| 7ABb 2 | The SS releases the RRC connection. | - | - | - | - |
| 7ABb 3 | Check: Does the UE transmit REGISTRATION REQUEST over a new signalling connection? | --> | REGISTRATION REQUEST | 2 | P |
| 7AC-7B | Void | - | - | - | - |
| 8A | SS stops transmitting UL grant. | - | - | - | - |
| 8B | The SS sends a REGISTRATION ACCEPT message | <-- | REGISTRATION ACCEPT | - | - |
| 8C | SS transmits one UL grant, for the UE to transmit the REGISTRATION COMPLETE message at step 8D. | - | - | - | - |
| 8D | The UE sends a REGISTRATION COMPLETE. | --> | REGISTRATION COMPLETE | - | - |
| 8E | The SS releases the RRC connection. | - | - | - | - |
| 8F | The SS resumes UL grant transmission. | - | - | - | - |
| 8G | The UE transmits a SERVICE REQUEST message over a new signalling connection. | --> | SERVICE REQUEST | - | - |
| 8H | The SS does not respond to SERVICE REQUEST message.
Note: The UE locally releases the signalling connection after T3517 expiry. | - | - | - | - |
| - | EXCEPTION: Steps 9 to 10 are repeated for 4 times. | - | - | - | - |
| 9 | Check: Does the UE transmits a SERVICE REQUEST message after T3517 expiry but before 60s over a new signalling connection? | --> | SERVICE REQUEST | 3 | P |
| 10 | The SS does not respond to SERVICE REQUEST message.
Note: The UE locally releases the signalling connection after T3517 expiry. | - | - | - | - |

| | | | | | |
|---|---|-----|------------------------------------|-----|---|
| 11 | Check: Does the UE transmits a SERVICE REQUEST message within 60 seconds (minimum value of T3525) over a new signalling connection? | --> | SERVICE REQUEST | 3,4 | F |
| 12A | The SS starts timer 10 sec after Step 11 to see if UE performs the optional Steps listed below. | - | - | - | - |
| | EXCEPTION: Steps 12Aa1 to 12Aa6 describe behaviour that depends on the UE implementation; the "lower case letter" identifies a step sequence that take place if the UE is implemented in a certain way. | - | - | - | - |
| 12Aa1 | The UE transmits a SERVICE REQUEST message after T3525 expiry over a new signalling connection. | --> | SERVICE REQUEST | - | - |
| 12Aa2-12Aa4 | Steps 5 to 7 of the NR RRC_CONNECTED procedure in TS 38.508-1 [4] Table 4.5.4.2-3 are executed. | - | - | - | - |
| - | EXCEPTION: Steps 12Aa5 and 12Aa6 can occur in any order. | - | - | - | - |
| 12Aa5 | The UE transmits an RRCReconfigurationComplete message. | --> | NR RRC: RRCReconfigurationComplete | - | - |
| 12Aa6 | The UE loop backs the IP packet received in step 2 on the DRB associated with the default PDU session. | - | - | - | - |
| <p>Note 1: The 1 second delay is used to secure that the UE have received and forwarded the IP Packet transmitted by the SS in step 2 to the UE test loop function before the RRCRelease message is sent by the SS in step 3.</p> <p>Note 2: Triggered when timer T_delay_modeB (IP PDU delay time) expires and pending uplink data exist in buffered PDCP SDUs according to TS 38.509 [6] clause 5.3.4.2.3 and TS 36.509 [8] clause 5.4.4.3.</p> | | | | | |

9.1.7.1.3.3

Specific message contents

Table 9.1.7.1.3.3-1: ACTIVATE TEST MODE (preamble)

| Derivation Path: TS 38.508-1 [4] | | | |
|----------------------------------|-----------------|---------------------|---------------------|
| Information Element | Value/remark | Comment | Condition |
| Protocol discriminator | 1 1 1 1 | | |
| Skip indicator | 0 0 0 0 | | |
| Message type | 1 0 0 0 0 1 0 0 | | |
| UE test loop mode | 0 0 0 0 0 0 1 | UE test loop mode B | UE TEST LOOP MODE B |

Table 9.1.7.1.3.3-2: CLOSE UE TEST LOOP (preamble)

| Derivation Path: TS 38.508-1 [4] | | | |
|----------------------------------|-----------------|---------------------|---------------------|
| Information Element | Value/remark | Comment | Condition |
| Protocol discriminator | 1 1 1 1 | | |
| Skip indicator | 0 0 0 0 | | |
| Message type | 1 0 0 0 0 0 0 0 | | |
| UE test loop mode | 0 0 0 0 0 0 1 | UE test loop mode B | UE TEST LOOP MODE B |
| UE test loop mode B LB setup | | | |
| IP PDU delay | 0 0 0 0 0 1 0 1 | 5 seconds | |

Table 9.1.7.1.3.3-3: SERVICE REQUEST (steps 4, 8G and 9, Table 9.1.7.1.3.2-1)

| Derivation Path: TS 38.508-1 [4] Table 4.7.1-16 | | | |
|---|--------------|---|---|
| Information Element | Value/remark | Comment | Condition |
| Service type | | | |
| Service type value | '0001'B | data | |
| Uplink data status | | Indicates data present for the PDU session with the DL IP packet looped back. The other bits are not checked. | Not allowed to be sent in cleartext and shall only be included in the complete SERVICE REQUEST message in the NAS message container IE. |

Table 9.1.7.1.3.3-4: SERVICE REJECT (step 5, Table 9.1.7.1.3.2-1)

| Derivation Path: TS 38.508-1 [4] Table 4.7.1-18 | | | |
|---|--------------|-------------------------|-----------|
| Information Element | Value/remark | Comment | Condition |
| 5GMM cause | '0001 1100'B | Restricted service area | |

Table 9.1.7.1.3.3-5: REGISTRATION REQUEST (steps 7ABa1 and 7ABb3, Table 9.1.7.1.3.2-1)

| Derivation Path: TS 38.508-1 [4] Table 4.7.1-6 | | | |
|--|--------------|--------------------------------|-----------|
| Information Element | Value/remark | Comment | Condition |
| 5GS registration type | '010'B | mobility registration updating | |

9.1.7.2 Service request / CONNECTED mode user data transport / Abnormal / T3517

9.1.7.2.1 Test Purpose (TP)

(1)

```
with { the UE is in 5GMM-REGISTERED state and 5GMM-CONNECTED mode over 3GPP access }
ensure that {
  when { the UE has user data pending due to no user-plane resources established for PDU session(s)
used for user data transport }
  then { the UE sends a SERVICE REQUEST message }
}
```

(2)

```
with { the UE sends a SERVICE REQUEST message in 5GMM-CONNECTED mode }
ensure that {
  when { T3517 expired }
  then { the UE stays in 5GMM-CONNECTED mode }
}
```

9.1.7.2.2 Conformance requirements

References: The conformance requirements covered in the current TC are specified in: TS 24.501 clauses 5.6.1.1, 5.6.1.2 and 5.6.1.7. Unless otherwise stated these are Rel-15 requirements.

[TS 24.501, clause 5.6.1.1]

The purpose of the service request procedure is to change the 5GMM mode from 5GMM-IDLE to 5GMM-CONNECTED mode, and/or to request the establishment of user-plane resources for PDU sessions which are established without user-plane resources. In latter case, the 5GMM mode can be the 5GMM-IDLE mode or the 5GMM-CONNECTED mode if the UE requires to establish user-plane resources for PDU sessions.

NOTE 1: The lower layer indicates when the user-plane resources for PDU sessions are successfully established or released.

This procedure is used when:

...

- the UE has user data pending over 3GPP access and the UE is in 5GMM-IDLE or 5GMM-CONNECTED mode over 3GPP access;

The UE shall invoke the service request procedure when:

...

- e) the UE, in 5GMM-CONNECTED mode or in 5GMM-CONNECTED mode with RRC inactive indication, has user data pending due to no user-plane resources established for PDU session(s) used for user data transport;

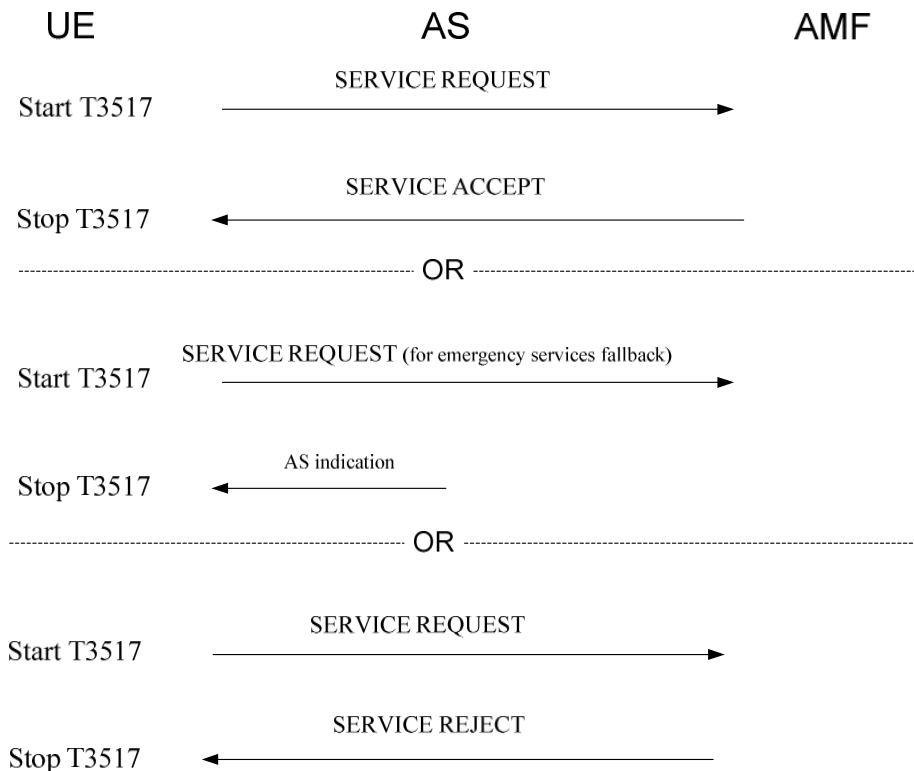

Figure 5.6.1.1.1: Service Request procedure

[TS 24.501, clause 5.6.1.2]

The UE initiates the service request procedure by sending a SERVICE REQUEST message to the AMF and starts timer T3517.

...

For cases d) and e) in subclause 5.6.1.1, the Uplink data status IE shall be included in the SERVICE REQUEST message to indicate the PDU session(s) the UE has pending user data to be sent. If the UE is not a UE configured for high priority access in selected PLMN:

- a) if there exists an emergency PDU session which is indicated in the Uplink data status IE the service type IE in the SERVICE REQUEST message shall be set to "emergency services"; or
- b) otherwise, the service type IE in the SERVICE REQUEST message shall be set to "data".

...

The Uplink data status IE may be included in the SERVICE REQUEST message to indicate which PDU session(s) associated with the access type the SERVICE REQUEST message is sent over have pending user data to be sent.

...

[TS 24.501, clause 5.6.1.7]

The following abnormal cases can be identified:

- a) T3517 expired.

The UE shall enter the state 5GMM-REGISTERED.

If the UE triggered the service request procedure in 5GMM-IDLE mode and the service type of the SERVICE REQUEST message was not set to "emergency services fallback", then the 5GMM sublayer shall increment the service request attempt counter, abort the procedure and release locally any resources allocated for the service request procedure. The service request attempt counter shall not be incremented, if:

- 1) the service request procedure is initiated to establish an emergency PDU session;
- 2) the UE has an emergency PDU session established;
- 3) the UE is a UE configured for high priority access in selected PLMN; or
- 4) the service request is initiated in response to paging or notification from the network.

If the service request attempt counter is greater than or equal to 5, the UE shall start timer T3525. Additionally, if the service request was initiated for an MO MMTEL voice call, a notification that the service request was not accepted due to the UE having started timer T3525 shall be provided to the upper layers.

NOTE 1: This can result in the upper layers requesting implementation specific mechanisms, e.g. the MMTEL voice call being attempted to another IP-CAN, or establishment of a CS voice call (if supported and not already attempted in the CS domain).

The UE shall not attempt service request until expiry of timer T3525 unless:

- 1) the service request is initiated in response to paging or notification from the network;
- 2) the UE is a UE configured for high priority access in selected PLMN;
- 3) the service request is initiated to establish an emergency PDU session;
- 4) the UE has an emergency PDU session established; or
- 5) the UE is registered in a new PLMN.

NOTE 2: The NAS signalling connection can also be released if the UE deems that the network has failed the authentication check as specified in subclause 5.4.1.3.7.

...

9.1.7.2.3 Test description

9.1.7.2.3.1 Pre-test conditions

System Simulator:

- NGC Cell A

UE:

- None.

Preamble:

- the UE is in 5GS state 3N-A with at least one PDU session (with PDU session ID X where $1 \leq X \leq 15$) active according to TS 38.508-1 [4], clause 4.4A.3 Table 4.4A.3-1, and using the message condition UE TEST LOOP MODE B prepared according to TS 38.508-1 [4]. DRB n is defined as default DRB for the PDU session X.

9.1.7.2.3.2 Test procedure sequence

Table 9.1.7.2.3.2-1: Main behaviour

| St | Procedure | Message Sequence | | TP | Verdict |
|---------|--|------------------|---|----|---------|
| | | U – S | Message | | |
| 1 | Void. | | | | |
| 1A | Cause the UE to request establishment of PDU session Y to the DN. (Note 1) | - | - | - | - |
| 1B | The UE transmits a PDU SESSION ESTABLISHMENT REQUEST message. (Note 2) | --> | NR 5GSM: PDU SESSION ESTABLISHMENT REQUEST | - | - |
| 1C | SS transmits a PDU SESSION ESTABLISHMENT ACCEPT message. (Note 2) | <-- | NR 5GSM: PDU SESSION ESTABLISHMENT ACCEPT | - | - |
| 1D | The SS transmits a CLOSE UE TEST LOOP message with IP PDU delay set to 1 second. | <-- | CLOSE UE TEST LOOP | - | - |
| 1E | The UE transmits a CLOSE UE TEST LOOP COMPLETE message. | --> | CLOSE UE TEST LOOP COMPLETE | - | - |
| 1F | The SS transmits one IP PDU on PDU session X. | <-- | - | - | - |
| 2 | The SS transmits an <i>RRCReconfiguration</i> message to release User-plane resources for the PDU session X. | <-- | NR RRC: <i>RRCReconfiguration</i> | - | - |
| 3 | The UE transmits an <i>RRCReconfigurationComplete</i> message. | --> | NR RRC: <i>RRCReconfigurationComplete</i> | - | - |
| 4 | Check: Does the UE transmit a <i>SERVICE REQUEST</i> message? | --> | NR 5GMM: <i>SERVICE REQUEST</i> | 1 | P |
| 5 | The SS does not respond to the <i>SERVICE REQUEST</i> message. | - | - | - | - |
| 6 | Wait for T3517 seconds (Note 3). | - | - | - | - |
| 7 | The UE transmit a <i>SERVICE REQUEST</i> message. | --> | NR 5GMM: <i>SERVICE REQUEST</i> | - | - |
| 8 | The SS sends an IDENTITY REQUEST message. | <-- | NR 5GMM: IDENTITY REQUEST | - | - |
| 9 | Check: Does the UE transmit an IDENTITY RESPONSE message?. | --> | NR 5GMM: IDENTITY RESPONSE | 2 | P |
| 10 | The SS transmits an <i>RRCReconfiguration</i> message Piggybacked with <i>SERVICE ACCEPT</i> message to setup User-plane resources for the PDU session X. | <-- | NR RRC: <i>RRCReconfiguration</i>
NR 5GMM: <i>SERVICE ACCEPT</i> | | |
| | EXCEPTION: Steps 11 and 13 can occur in any order | - | - | - | - |
| 11 | The UE transmits an <i>RRCReconfigurationComplete</i> message | --> | NR RRC: <i>RRCReconfigurationComplete</i> | - | - |
| 12 | Void. | - | - | - | - |
| 13 | The UE loop back the IP PDU on PDU session X. | - | - | - | - |
| Note 1: | The request to establish a PDU session may be performed by MMI or AT command. | | | | |
| Note 2: | The reason to establish PDU session Y is to avoid that, after release user-plane resource for PDU session X in step 2-3, the UE can still be in 5GMM-CONNECTED mode as TP1 said. Otherwise, if the UE has only PDU session X, then according to TS 38.331 clause 5.3.1.1, UE has to release both SRB2 and DRB of PDU session X, then go to 5GMM-IDLE mode which violate TP1. | | | | |
| Note 3: | T3517 expires after 15 seconds. | | | | |

9.1.7.2.3.3 Specific message contents

Table 9.1.7.2.3.3-1: RRCReconfiguration (step 2, Table 9.1.7.2.3.2-1)

| Derivation Path: TS 38.508-1 [4], Table 4.6.1-13 | | | |
|--|-------------------|---------|-----------|
| Information Element | Value/remark | Comment | Condition |
| RRCReconfiguration ::= SEQUENCE { | | | |
| criticalExtensions CHOICE { | | | |
| rrcReconfiguration SEQUENCE { | | | |
| radioBearerConfig | RadioBearerConfig | | |
| masterCellGroup | MasterCellGroup | | |
| } | | | |
| } | | | |
| } | | | |

Table 9.1.7.2.3.3-2a: RadioBearerConfig (Table 9.1.7.2.3.3-1)

| Derivation Path: TS 38.508-1 [4], Table 4.6.3-132 | | | |
|---|--------------------------------|---------|-----------|
| Information Element | Value/remark | Comment | Condition |
| RadioBearerConfig ::= SEQUENCE { | | | |
| drb-ToReleaseList SEQUENCE (SIZE (1..maxDRB)) OF DRB-Identity { | 1 entry | | |
| DRB-Identity[1] | DRB configured in the preamble | entry 1 | |
| } | | | |
| } | | | |

Table 9.1.7.2.3.3-2b: MasterCellGroup (Table 9.1.7.2.3.3-1)

| Derivation path: TS 38.508-1 [4], Table 4.6.3-19 | | | |
|--|--|---------|-----------|
| Information Element | Value/remark | Comment | Condition |
| CellGroupConfig ::= SEQUENCE { | | | |
| rlc-BearerToAddModList | Not present | | |
| rlc-BearerToReleaseList SEQUENCE (SIZE(1..maxLC-ID)) OF LogicalChannelIdentity { | 1 entry | | |
| logicalChannelIdentity[1] | Logical channel identity corresponding to DRB configured in the preamble | entry 1 | |
| } | | | |
| mac-CellGroupConfig | Not present | | |
| physicalCellGroupConfig | Not present | | |
| spCellConfig | Not present | | |
| } | | | |

Table 9.1.7.2.3.3-3: SERVICE REQUEST (step 4, 7, Table 9.1.7.2.3.2-1)

| Derivation path: TS 38.508-1 [4], table 4.7.1-16 | | | |
|--|--------------|--|-----------|
| Information Element | Value/Remark | Comment | Condition |
| Service type | '0001'B | data | |
| Uplink data status | | | |
| PSI(X) | '1'B | PSI(X) is set to 1 indicates that uplink data are pending for the PDU session X activated in preamble. | |

Table 9.1.7.2.3.3-4: IDENTITY REQUEST (step 8, Table 9.1.7.2.3.2-1)

| Derivation Path: TS 38.508-1 [4] table 4.7.1-21 | | | |
|---|--------------|---------|-----------|
| Information Element | Value/remark | Comment | Condition |
| Identity type | '0010'B | 5G-GUTI | |

Table 9.1.7.2.3.3-5: IDENTITY RESPONSE (step 9, Table 9.1.7.2.3.2-1)

| Derivation Path: TS 38.508-1 [4] table 4.7.1-22 | | | |
|---|--------------|---------|-----------|
| Information Element | Value/remark | Comment | Condition |
| Mobile identity | 5G-GUTI | | |

Table 9.1.7.2.3.3-6: RRCReconfiguration (step 10, Table 9.1.7.2.3.2-1)

| Derivation Path: TS 38.508-1 [4], Table 4.6.1-13 | | | |
|--|--|---|-----------|
| Information Element | Value/remark | Comment | Condition |
| RRCReconfiguration ::= SEQUENCE { | | | |
| criticalExtensions CHOICE { | | | |
| rrcReconfiguration SEQUENCE { | | | |
| radioBearerConfig | RadioBearerConfig with conditions DRB configured in the preamble | | |
| nonCriticalExtension SEQUENCE { | | | |
| masterCellGroup | CellGroupConfig with condition DRB configured in the preamble | OCTET STRING (CONTAINING CellGroupConfig) | |
| } | | | |
| } | | | |
| } | | | |

Table 9.1.7.2.3.3-7: SERVICE ACCEPT (step 10, Table 9.1.7.2.3.2-1)

| Derivation path: TS 38.508-1 [4], table 4.7.1-17 | | | |
|--|--------------|--|-----------|
| Information Element | Value/Remark | Comment | Condition |
| PDU session reactivation result | | | |
| PSI(X) | '0'B | PSI(X) is set to 0 indicates that establishment of user-plane resource of the PDU session X activated in preamble is successful. | |

9.1.8 SMS over NAS

9.1.8.1 SMS over NAS / MO and MT SMS over NAS - Idle mode

9.1.8.1.1 Test Purpose (TP)

(1)

```
with { the UE in switched off state with valid USIM inserted }
ensure that {
  when { the UE requests initial registration for SMS over NAS }
  then { the UE shall send REGISTRATION REQUEST message with SMS requested bit of the 5GS update
type IE "SMS over NAS supported" }
```

```

    }

```

(2)

```

with { the UE in 5GMM-REGISTERED state }
ensure that {
  when { the UE initiates a periodic registration update and the requirements to use SMS over NAS
transport have not changed in the UE}
  then { the UE sets the SMS requested bit of the 5GS updatetype IE in the REGISTRATION REQUEST
message to the same value as indicated by the UE in the last REGISTRATION REQUEST message }
}

```

(3)

```

with { the UE in 5GMM_Connected state with NR RRC_IDLE mode and the UE has sent a SERVICE REQUEST
message triggered by initiating MO SMS}
ensure that {
  when { UE receives a SERVICE ACCEPT message from SS }
  then { UE sends CP-DATA containing RP-DATA RPDU (SMS SUBMIT TPDU) encapsulated in an Uplink NAS
transport message }
}

```

(4)

```

with { UE has sent CP-DATA containing an RP-DATA RPDU (SMS SUBMIT TPDU) encapsulated in an Uplink
NAS transport message }
ensure that {
  when { UE receives a CP-DATA containing an RP-ACK RPDU encapsulated in a Downlink NAS transport
message }
  then { UE sends a CP-ACK encapsulated in an Uplink NAS Transport message }
}

```

(5)

```

with { the UE in 5GMM-REGISTERED state with NR RRC_IDLE mode, UE has received a paging request and
UE has completed a SERVICE REQUEST procedure}
ensure that {
  when { UE receives a CP-DATA containing an RP-DATA RPDU (SMS DELIVER TPDU) encapsulated in a
Downlink NAS transport message }
  then { UE sends a CP-ACK encapsulated in an Uplink NAS transport message followed by a CP-DATA
containing an RP-ACK RPDU encapsulated in an Uplink NAS transport message}
}

```

9.1.8.1.2 Conformance requirements

References: The conformance requirements covered in the present TC are specified in: TS 24.501, clause 5.5.1.2.2, 5.5.1.2.4, 5.5.1.3.2, 5.5.1.3.4, 9.11.3.6 and 9.11.3.9A. Unless otherwise stated these are Rel-15 requirements.

[TS 24.501 clause 5.5.1.2.2]

The UE in state 5GMM-DEREGISTERED shall initiate the registration procedure for initial registration by sending a REGISTRATION REQUEST message to the AMF,

- a) when the UE performs initial registration for 5GS services;
- b) when the UE performs initial registration for emergency services;
- c) when the UE performs initial registration for SMS over NAS; and
- d) when the UE moves from GERAN to NG-RAN coverage or the UE moves from a UTRAN to NG-RAN coverage.

...

The UE initiates the registration procedure for initial registration by sending a REGISTRATION REQUEST message to the AMF, starting timer T3510. If timer T3502 is currently running, the UE shall stop timer T3502. If timer T3511 is currently running, the UE shall stop timer T3511.

...

If the UE requests the use of SMS over NAS, the UE shall include the 5GS update type IE in the REGISTRATION REQUEST message with the SMS requested bit set to “SMS over NAS supported”. When the 5GS update type IE is included in the REGISTRATION REQUEST for reasons other than requesting the use of SMS over NAS, and the UE does not need to register for SMS over NAS, the UE shall set the SMS requested bit of the 5GS update type IE to “SMS over NAS not supported” in the REGISTRATION REQUEST message.

[TS 24.501 clause 5.5.1.2.4]

If the initial registration request is accepted by the network, the AMF shall send a REGISTRATION ACCEPT message to the UE.

...

If the 5GS update type IE was included in the REGISTRATION REQUEST message with the SMS requested bit set to “SMS over NAS supported”, and SMSF selection is successful, then the AMF shall send the REGISTRATION ACCEPT message after the SMSF has confirmed that the activation of the SMS service was successful. When sending the REGISTRATION ACCEPT message, the AMF shall:

- a) set the SMS allowed bit of the 5GS registration result IE to “SMS over NAS allowed” in the REGISTRATION ACCEPT message, if the UE has set the SMS requested bit of the 5GS registration type IE to “SMS over NAS supported” in the REGISTRATION REQUEST message and the network allows the use of SMS over NAS for the UE; and
- b) store the SMSF address and the value of the SMS allowed bit of the 5GS registration result IE in the UE 5GMM context and consider the UE available for SMS over NAS.

[TS 24.501 clause 5.5.1.3.2]

The UE in state 5GMM-REGISTERED shall initiate the registration procedure for mobility and periodic registration update by sending a REGISTRATION REQUEST message to the AMF,

- 1) when the UE needs to register for SMS over NAS, indicate a change in the requirements to use SMS over NAS, or de-register from SMS over NAS;

...

The UE in state 5GMM-REGISTERED shall initiate the registration procedure for mobility and periodic update by sending a REGISTRATION REQUEST message to the AMF when the UE needs to request the use of SMS over NAS transport or the current requirements to use SMS over NAS transport change in the UE. The UE shall set the SMS requested bit of the 5GS update type IE in the REGISTRATION REQUEST message as specified in subclause 5.5.1.2.2.

When initiating a registration procedure for mobility and periodic registration update and the UE needs to send the 5GS update type IE for a reason different than indicating a change in requirement to use SMS over NAS, the UE shall set the SMS requested bit of the 5GS update type IE in the REGISTRATION REQUEST message to the same value as indicated by the UE in the last REGISTRATION REQUEST message.

If the UE no longer requires the use of SMS over NAS, then the UE shall include the 5GS update type IE in the REGISTRATION REQUEST message with the SMS requested bit set to “SMS over NAS not supported”.

[TS 24.501 clause 5.5.1.3.4]

If the registration update request has been accepted by the network, the AMF shall send a REGISTRATION ACCEPT message to the UE.

...

If the 5GS update type IE was included in the REGISTRATION REQUEST message with the SMS requested bit set to “SMS over NAS not supported” and:

- a) the SMSF address is stored in the UE 5GMM context and:
 - 1) the UE is considered available for SMS over NAS; or
 - 2) the UE is considered not available for SMS over NAS and the SMSF has confirmed that the activation of the SMS service is successful; or

- b) the SMSF address is not stored in the UE 5GMM context, the SMSF selection is successful and the SMSF has confirmed that the activation of the SMS service is successful;

then the AMF shall set the SMS allowed bit of the 5GS registration result IE in the REGISTRATION ACCEPT message as specified in subclause 5.5.1.2.4. If the UE 5GMM context does not contain an SMSF address or the UE is not considered available for SMS over NAS, then the AMF shall:

- a) store the SMSF address in the UE 5GMM context if not stored already; and
- b) store the value of the SMS allowed bit of the 5GS registration result IE in the UE 5GMM context and consider the UE available for SMS over NAS.

If SMSF selection in the AMF or SMS activation via the SMSF is not successful, or the AMF does not allow the use of SMS over NAS, then the AMF shall set the SMS allowed bit of the 5GS registration result IE to "SMS over NAS not allowed" in the REGISTRATION ACCEPT message.

If the 5GS update type IE was included in the REGISTRATION REQUEST message with the SMS requested bit set to "SMS over NAS not supported", then the AMF shall:

- a) mark the 5GMM context to indicate that the UE is not available for SMS over NAS; and

NOTE 2: The AMF can notify the SMSF that the UE is deregistered from SMS over NAS based on local configuration.

- b) set the SMS allowed bit of the 5GS registration result IE to "SMS over NAS not supported" in the REGISTRATION ACCEPT message.

When the UE receives the REGISTRATION ACCEPT message, if the UE is also registered over another access to the same PLMN, the UE considers the value indicated by the SMS allowed bit of the 5GS registration result IE as applicable for both accesses over which the UE is registered.

[TS 24.501 clause 9.11.3.6]

The purpose of the 5GS registration result information element is to specify the result of a registration procedure.

The 5GS registration result information element is coded as shown in figure 9.11.3.6.1 and table 9.11.3.6.1.

The 5GS registration result is a type 4 information element with a length of 3 octets.

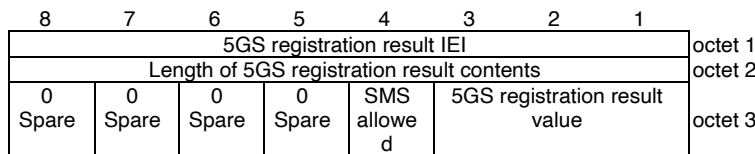

Figure 9.11.3.6.1: 5GS registration result information element

Table 9.11.3.6.1: 5GS registration result information element

| | | | |
|---|--------------------------|----------|---------------------------------|
| 5GS registration result value (octet 3, bits 1 to 3) | | | |
| Bits | | | |
| 3 | 2 | 1 | |
| 0 | 0 | 1 | 3GPP access |
| 0 | 1 | 0 | Non-3GPP access |
| 0 | 1 | 1 | 3GPP access and non-3GPP access |
| 1 | 1 | 1 | reserved |
| All other values are unused and shall be treated as "3GPP access", if received by the UE. | | | |
| SMS over NAS transport allowed (SMS allowed) (octet 3, bit 4) | | | |
| Bit | | | |
| 4 | | | |
| 0 | SMS over NAS not allowed | | |
| 1 | SMS over NAS allowed | | |
| Bits 5 to 8 of octet 3 are spare and shall be coded as zero. | | | |

[TS 24.501 clause 9.11.3.9A]

The purpose of the 5GS update type IE is to allow the UE to provide additional information to the network when performing a registration procedure.

The 5GS update type information element is coded as shown in figure 9.11.3.9A.1 and table 9.11.3.9A.1.

The 5GS update type is a type 4 information element.

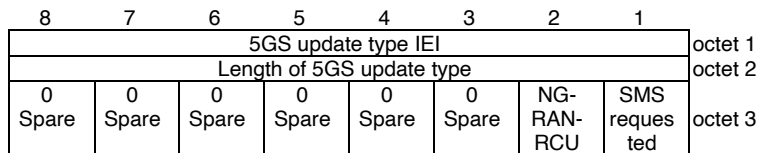

Figure 9.11.3.9A.1: 5GS update type information element

Table 9.11.3.9A.1: 5GS update type information element

| | |
|---|---|
| SMS over NAS transport requested (SMS requested) (octet 3, bit 1) | |
| Bit | |
| 1 | |
| 0 | SMS over NAS not supported |
| 1 | SMS over NAS supported |
| NG-RAN Radio Capability Update (NG-RAN-RCU) (octet 3, bit 2) | |
| Bits | |
| 2 | |
| 0 | NG-RAN radio capability update not needed |
| 1 | NG-RAN radio capability update needed |
| Bits 3 to 8 of octet 3 are spare and shall be coded as zero. | |

9.1.8.1.3 Test description

9.1.8.1.3.1 Pre-test conditions

System Simulator:

NGC Cell A belongs to Home PLMN and TAI1;

UE:

The UE does not have any stored SMS message.

Preamble:

The UE is in state Switched OFF (state 0N-B) according to TS 38.508-1 [4].

9.1.8.1.3.2 Test procedure sequence

Table 9.1.8.1.3.2-1: Main behaviour

| St | Procedure | Message Sequence | | TP | Verdict |
|---------|--|------------------|------------------------|----|---------|
| | | U - S | Message | | |
| 1 | The UE is switched ON | - | - | - | - |
| 2 - 4 | UE establishes RRC connection by executing steps 2-4 of Table 4.5.2.2-2 in TS 38.508-1 | - | - | - | - |
| 5 | Check: Does UE transmit a REGISTRATION REQUEST message including 5GS update type IE with SMS requested bit set to "SMS over NAS supported"? | --> | REGISTRATION REQUEST | 1 | P |
| 6 - 14 | Steps 5 to 13 of the generic procedure for NR RRC_IDLE specified in TS 38.508-1 subclause 4.5.2, Table 4.5.2.2-2: NR RRC_IDLE are performed. | - | - | - | - |
| 15 | SS transmits REGISTRATION ACCEPT message including 5GS registration result with SMS allowed bit set to "SMS over NAS allowed" and T3512 value set to 3 minutes. | <<- | REGISTRATION ACCEPT | - | - |
| 16 - 21 | Steps 15 to 20 of the generic procedure for NR RRC_IDLE specified in TS 38.508-1 subclause 4.5.2, Table 4.5.2.2-2: NR RRC_IDLE are performed. | - | - | - | - |
| 22 - 24 | UE establishes RRC connection by executing steps 2-4 of Table 4.5.2.2-2 in TS38.508-1 | - | - | - | - |
| 25 | Check: Does UE perform periodic Registration (Based on T3512 value indicated in the REGISTRATION ACCEPT message with timer starting in step-15) including 5GS update type IE with SMS requested bit set to "SMS over NAS supported"? | --> | REGISTRATION REQUEST | 2 | P |
| 26 - 34 | Void. | - | - | - | - |
| 35 | SS transmits REGISTRATION ACCEPT message including 5GS registration result with SMS allowed bit set to "SMS over NAS allowed" and T3512 value set to 3 minutes. | <<- | REGISTRATION ACCEPT | - | - |
| 35 A | The UE transmits a REGISTRATION COMPLETE message. | --> | REGISTRATION COMPLETE | - | - |
| 36 | The SS transmits an <i>RRCRelease</i> message | - | - | - | - |
| 37 | Sending of a 160 character MO SMS is initiated at the UE via MMI or AT command | - | - | - | - |
| 38 | The UE transmits a SERVICE REQUEST message. | --> | SERVICE REQUEST | | |
| 39 - 42 | Steps 5 to 8 of the generic procedure for NR RRC_CONNECTED specified in TS 38.508-1 subclause 4.5.4, Table 4.5.4.2-3: NR RRC_CONNECTED are performed. | - | - | - | - |
| 43 | The UE transmits a CP-DATA containing an RP-DATA RPDU (SMS SUBMIT TPDU) encapsulated in an Uplink NAS transport message. | --> | UPLINK NAS TRANSPORT | 3 | P |
| 44 | The SS transmits a CP-ACK encapsulated in a Downlink NAS Transport message. | <<- | DOWNLINK NAS TRANSPORT | - | - |
| 45 | The SS transmits a CP-DATA containing an RP-ACK RPDU encapsulated in a Downlink | <<- | DOWNLINK NAS TRANSPORT | - | - |

| NAS transport message | | | | | |
|-----------------------|---|-----|------------------------|---|---|
| 46 | Check: Does the UE transmit a CP-ACK encapsulated in an Uplink NAS Transport message? | --> | UPLINK NAS TRANSPORT | 4 | P |
| 47 | The SS transmits an <i>RRCRelease</i> message | - | - | - | - |
| 48 | The SS pages the UE using NG-5G-S-TMSI. | - | - | - | - |
| 49 | The UE transmits a SERVICE REQUEST message. | --> | SERVICE REQUEST | - | - |
| 50-53 | Steps 5 to 8 of the generic procedure for NR RRC CONNECTED specified in TS 38.508-1 subclause 4.5.4, Table 4.5.4.2-3: NR RRC_CONNECTED are performed. | - | - | - | - |
| 54 | The SS transmits a CP-DATA containing a RP-DATA RPDU (SMS DELIVER TPDU) encapsulated in a Downlink NAS transport message to the UE. | <-- | DOWNLINK NAS TRANSPORT | - | - |
| 55 | Check: Does the UE transmit a CP-ACK encapsulated in an Uplink NAS transport message? | --> | UPLINK NAS TRANSPORT | 5 | P |
| 56 | Check: Does the UE transmit a CP-DATA containing a RP-ACK RPDU encapsulated in an Uplink NAS transport message? | --> | UPLINK NAS TRANSPORT | 5 | P |
| 57 | The SS transmits a CP-ACK encapsulated in a Downlink NAS transport message to the UE. | <-- | DOWNLINK NAS TRANSPORT | - | - |

9.1.8.1.3.3 Specific message contents

Table 9.1.8.1.3.3-1: REGISTRATION REQUEST (step 5, Table 9.1.8.1.3.2-1)

| Derivation path: TS 38.508-1 [4], Table 4.7.1-6 | | | |
|---|------------------------|---------|-----------|
| Information Element | Value/remark | Comment | Condition |
| 5GS registration type | | | |
| 5GS registration type value | '001'B | | INITIAL |
| 5GS update type | | | |
| SMS requested | SMS over NAS supported | | |

Table 9.1.8.1.3.3-2: REGISTRATION ACCEPT (steps 15 and 35, Table 9.1.8.1.3.2-1)

| Derivation path: TS 38.508-1 [4], Table 4.7.1-7 | | | |
|---|----------------------|---------|-----------|
| Information Element | Value/remark | Comment | Condition |
| 5GS registration result | | | |
| SMS allowed | SMS over NAS allowed | | |
| T3512 value | | | |
| Timer value | '00011'B | | |
| Unit | '101'B | | |

Table 9.1.8.1.3.3-3: REGISTRATION REQUEST (step 25, Table 9.1.8.1.3.2-1)

| Derivation path: TS 38.508-1 [4], Table 4.7.1-6 | | | |
|---|------------------------|---------|-----------|
| Information Element | Value/remark | Comment | Condition |
| 5GS registration type | | | |
| 5GS registration type value | '011'B | | PERIODIC |
| 5GS update type | | | |
| SMS requested | SMS over NAS supported | | |

Table 9.1.8.1.3.3-3A: SERVICE REQUEST (step 38, Table 9.1.8.1.3.2-1)

| Derivation path: TS 38.508-1 [4], Table 4.7.1-16 | | | |
|--|--------------|------------|-----------|
| Information Element | Value/remark | Comment | Condition |
| Service type | | | |
| Service type value | '0000'B | signalling | |

Table 9.1.8.1.3.3-4: UL NAS TRANSPORT (step 43, Table 9.1.8.1.3.2-1)

| Derivation path: TS 38.508-1 [4], Table 4.7.1-10 | | | |
|--|--------------|--------------|-----------|
| Information Element | Value/remark | Comment | Condition |
| Payload container type | '0010'B | SMS | |
| Payload container | CP-DATA | RP-DATA RPDU | |

Table 9.1.8.1.3.3-5: DL NAS TRANSPORT (step 44, Table 9.1.8.1.3.2-1)

| Derivation path: TS 38.508-1 [4], Table 4.7.1-11 | | | |
|--|--------------|---------|-----------|
| Information Element | Value/remark | Comment | Condition |
| Payload container type | '0010'B | SMS | |
| Payload container | CP-ACK | | |

Table 9.1.8.1.3.3-6: DL NAS TRANSPORT (step 45, Table 9.1.8.1.3.2-1)

| Derivation path: TS 38.508-1 [4], Table 4.7.1-11 | | | |
|--|--------------|-------------|-----------|
| Information Element | Value/remark | Comment | Condition |
| Payload container type | '0010'B | SMS | |
| Payload container | CP-DATA | RP-ACK RPDU | |

Table 9.1.8.1.3.3-7: UL NAS TRANSPORT (step 46, Table 9.1.8.1.3.2-1)

| Derivation path: TS 38.508-1 [4], Table 4.7.1-10 | | | |
|--|--------------|---------|-----------|
| Information Element | Value/remark | Comment | Condition |
| Payload container type | '0010'B | SMS | |
| Payload container | CP-ACK | | |

Table 9.1.8.1.3.3-8: DL NAS TRANSPORT (step 54, Table 9.1.8.1.3.2-1)

| Derivation path: TS 38.508-1 [4], Table 4.7.1-11 | | | |
|--|--------------|---------|-----------|
| Information Element | Value/remark | Comment | Condition |
| Payload container type | '0010'B | SMS | |
| Payload container | CP-DATA | RP-DATA | |

Table 9.1.8.1.3.3-9: UL NAS TRANSPORT (step 55, Table 9.1.8.1.3.2-1)

| Derivation path: TS 38.508-1 [4], Table 4.7.1-10 | | | |
|--|--------------|---------|-----------|
| Information Element | Value/remark | Comment | Condition |
| Payload container type | '0010'B | SMS | |
| Payload container | CP-ACK | | |

Table 9.1.8.1.3.3-10: UL NAS TRANSPORT (step 56, Table 9.1.8.1.3.2-1)

| Derivation path: TS 38.508-1 [4], Table 4.7.1-10 | | | |
|--|--------------|---------|-----------|
| Information Element | Value/remark | Comment | Condition |
| Payload container type | '0010'B | SMS | |
| Payload container | CP-DATA | RP-ACK | |

Table 9.1.8.1.3.3-11: DL NAS TRANSPORT (step 57, Table 9.1.8.1.3.2-1)

| Derivation path: TS 38.508-1 [4], Table 4.7.1-11 | | | |
|--|--------------|---------|-----------|
| Information Element | Value/remark | Comment | Condition |
| Payload container type | '0010'B | SMS | |
| Payload container | CP-ACK | | |

9.1.8.2 SMS over NAS / Multiple MO and MT SMS over NAS - CONNECTED mode

9.1.8.2.1 Test Purpose (TP)

(1)

```
with { the UE is in 5GMM-REGISTERED state and 5GMM-CONNECTED mode over 3GPP access }
ensure that {
  when { a Multiple MO SMS is initiated at the UE }
  then { UE sends CP-DATA containing RP-DATA RPDU (SMS SUBMIT TPDU) encapsulated in an Uplink NAS
transport message }
}
```

(2)

```
with { UE has sent CP-DATA containing an RP-DATA RPDU (SMS SUBMIT TPDU) encapsulated in an Uplink
NAS transport message and has another MO SMS to send }
ensure that {
  when { UE receives a CP-DATA containing an RP-ACK RPDU encapsulated in a Downlink NAS transport
message }
  then { UE does not send a final CP-ACK before it sends a CP-DATA containing the successive RP-
DATA RPDU (SMS SUBMIT TPDU) encapsulated in an Uplink NAS transport message }
}
```

(3)

```
with { UE has sent CP-DATA containing an RP-DATA RPDU (SMS SUBMIT TPDU) encapsulated in an Uplink
NAS transport message and has no further MO SMS to send }
ensure that {
  when { UE receives a CP-DATA containing an RP-ACK RPDU encapsulated in a Downlink NAS transport
message }
  then { UE sends a CP-ACK encapsulated in an Uplink NAS transport message }
}
```

(4)

```
with { the UE is in 5GMM-REGISTERED state and 5GMM-CONNECTED mode over 3GPP access }
ensure that {
  when { UE receives a CP-DATA containing an RP-DATA RPDU (SMS DELIVER TPDU) encapsulated in a
Downlink NAS transport message, and subsequently a second CP-DATA containing an RP-DATA RPDU (SMS
DELIVER TPDU) encapsulated in a Downlink NAS transport message with different transaction identifier
}
  then { UE sends twice a CP-ACK encapsulated in an Uplink NAS transport message followed by a CP-
DATA containing an RP-ACK RPDU encapsulated in an Uplink NAS transport message}
}
```

9.1.8.2.2 Conformance requirements

References: The conformance requirements covered in the present TC are specified in: TS 24.501 clause 4.5.4.2, and TS 24.011 clause 9.11.3.9A. Unless otherwise stated these are Rel-15 requirements.

[TS 24.501 clause 4.5.4.2]

If the lower layers indicate that the access attempt is allowed, the NAS shall take the following action depending on the event which triggered the access attempt:

- a) if the event which triggered the access attempt was an MO-MMTEL-voice-call-started indication, an MO-MMTEL-video-call-started indication or an MO-SMSoIP-attempt-started indication, the NAS shall notify the upper layers that the access attempt is allowed;

- b) if the event which triggered the access attempt was a request from upper layers to send a mobile originated SMS over NAS, 5GMM shall initiate the NAS transport procedure as specified in subclause 5.4.5 to send the SMS in an UL NAS TRANSPORT message;

[TS 24.011 clause 5.4]

In the case of a SMS transfer via the PS domain, when the MS chooses to use the same PS signalling connection (in Iu mode and in S1 mode if packet-switched service is used); or in the case of a SMS transfer via the PS domain in A/Gb mode; or in the case of SMS transfer through the EPS, or in the case of SMS transfer in N1 mode, then:

- the MS shall transmit the CP-DATA for the successive RPDU and shall not transmit the final CP-ACK for the current SMS (i.e. the one that acknowledges the CP-DATA that carried the RP-ACK);
- the Transaction Identifier used for the successive RPDU shall be different to that used for the current RPDU; and
- the MS shall not transmit the CP-DATA for the successive RPDU before the final CP-DATA (i.e. the one that carried the RP-ACK) has been received.

NOTE: When an MS sends successive memory available notifications and/or mobile originated short messages on different RR connections (in A/Gb mode) or signalling connections (in Iu mode and S1 mode), the MS is strongly recommended to use different Transaction Identifiers for the old and new MM connections.

It is possible that the final CP-ACK of a short message transfer may not be received (e.g. due to transmission errors and/or hand overs).

For mobile terminated transfers, if the CP-ACK is lost, the reception of a CP-DATA with a different transaction identifier and carrying an RPDU shall be interpreted as the implicit reception of the awaited CP-ACK followed by the reception of the new CP-DATA message.

For mobile originated transfers, if the CP-ACK is lost or not sent by the MS, the following events shall be interpreted as the implicit reception of the awaited CP-ACK:

- in the case of a SMS transfer via the CS domain, the reception of a CM SERVICE REQUEST followed by a CP-DATA with a different transaction identifier and carrying an RPDU; or
- in the case of a SMS transfer via the PS domain, the reception of a CP-DATA with a different transaction identifier and carrying an RPDU.

9.1.8.2.3 Test description

9.1.8.2.3.1 Pre-test conditions

System Simulator:

NGC Cell A belongs to Home PLMN and TAI1.

UE:

The UE does not have any stored SMS message.

Preamble:

The UE is in state 3N-A, registered with "SMS over NAS supported".

9.1.8.2.3.2 Test procedure sequence

Table 9.1.8.2.3.2-1: Main behaviour

| St | Procedure | Message Sequence | | TP | Verdict |
|----|--|------------------|------------------------|----|---------|
| | | U - S | Message | | |
| 1 | Sending of 3 MO SMS as multiple SMS is initiated at the UE via MMI or AT command | - | - | - | - |
| 2 | Check: Does the UE transmit a CP-DATA containing an RP-DATA RPDU (SMS SUBMIT TPDU) encapsulated in an Uplink NAS transport message? | --> | UPLINK NAS TRANSPORT | 1 | P |
| 3 | The SS transmits a CP-ACK encapsulated in a Downlink NAS Transport message. | <-- | DOWNLINK NAS TRANSPORT | - | - |
| 4 | The SS transmits a CP-DATA containing an RP-ACK RPDU encapsulated in a Downlink NAS transport message | <-- | DOWNLINK NAS TRANSPORT | - | - |
| 5 | Check: Does the UE transmit a CP-ACK encapsulated in an Uplink NAS Transport message before the CP-DATA in step 6 is transmitted? | --> | UPLINK NAS TRANSPORT | 2 | F |
| 6 | Check: Does the UE transmit a CP-DATA containing an RP-DATA RPDU (SMS SUBMIT TPDU) encapsulated in an Uplink NAS transport message? | --> | UPLINK NAS TRANSPORT | 2 | P |
| 7 | The SS transmits a CP-ACK encapsulated in a Downlink NAS Transport message. | <-- | DOWNLINK NAS TRANSPORT | - | - |
| 8 | The SS transmits a CP-DATA containing an RP-ACK RPDU encapsulated in a Downlink NAS transport message | <-- | DOWNLINK NAS TRANSPORT | - | - |
| 9 | Check: Does the UE transmit a CP-ACK encapsulated in an Uplink NAS Transport message before the CP-DATA in step 10 is transmitted? | --> | UPLINK NAS TRANSPORT | 2 | F |
| 10 | Check: Does the UE transmit a CP-DATA containing an RP-DATA RPDU (SMS SUBMIT TPDU) encapsulated in an Uplink NAS transport message? | --> | UPLINK NAS TRANSPORT | 2 | P |
| 11 | The SS transmits a CP-ACK encapsulated in a Downlink NAS Transport message. | <-- | DOWNLINK NAS TRANSPORT | - | - |
| 12 | The SS transmits a CP-DATA containing an RP-ACK RPDU encapsulated in a Downlink NAS transport message | <-- | DOWNLINK NAS TRANSPORT | - | - |
| 13 | Check: Does the UE transmit a CP-ACK encapsulated in an Uplink NAS Transport message? | --> | UPLINK NAS TRANSPORT | 3 | P |
| 14 | The SS transmits a CP-DATA containing an RP-DATA RPDU (SMS DELIVER TPDU) encapsulated in a Downlink NAS transport message to the UE. | <-- | DOWNLINK NAS TRANSPORT | - | - |
| 15 | Check: Does the UE transmit a CP-ACK encapsulated in an Uplink NAS transport message? | --> | UPLINK NAS TRANSPORT | 4 | P |
| 16 | Check: Does the UE transmit a CP-DATA containing an RP-ACK RPDU encapsulated in an Uplink NAS transport message? | --> | UPLINK NAS TRANSPORT | 4 | P |
| 17 | The SS transmits a CP-DATA containing an RP-DATA RPDU (SMS DELIVER TPDU) encapsulated in a Downlink NAS transport message to the UE. | <-- | DOWNLINK NAS TRANSPORT | - | - |
| 18 | Check: Does the UE transmit a CP-ACK encapsulated in an Uplink NAS transport message? | --> | UPLINK NAS TRANSPORT | 4 | P |
| 19 | Check: Does the UE transmit a CP-DATA containing an RP-ACK RPDU encapsulated in an Uplink NAS transport message? | --> | UPLINK NAS TRANSPORT | 4 | P |
| 20 | The SS transmits a CP-ACK encapsulated in a | <-- | DOWNLINK NAS TRANSPORT | - | - |

| | | | |
|---|--|--|--|
| Downlink NAS transport message to the UE. | | | |
|---|--|--|--|

9.1.8.2.3.3 Specific message contents

Table 9.1.8.2.3.3-1: UL NAS TRANSPORT (step 2, Table 9.1.8.2.3.2-1)

| Derivation path: TS 38.508-1 [4], Table 4.7.1-10 | | | |
|--|--------------|--|-----------|
| Information Element | Value/remark | Comment | Condition |
| Payload container type | '0010'B | SMS | |
| Payload container | CP-DATA | RP-DATA RPDU
TI used in steps 2,
3 and 4 shall be
x1. | |

Table 9.1.8.2.3.3-2: DL NAS TRANSPORT (step 3, Table 9.1.8.2.3.2-1)

| Derivation path: TS 38.508-1 [4], Table 4.7.1-11 | | | |
|--|--------------|---------|-----------|
| Information Element | Value/remark | Comment | Condition |
| Payload container type | '0010'B | SMS | |
| Payload container | CP-ACK | | |

Table 9.1.8.2.3.3-3: DL NAS TRANSPORT (step 4, Table 9.1.8.2.3.2-1)

| Derivation path: TS 38.508-1 [4], Table 4.7.1-11 | | | |
|--|--------------|-------------|-----------|
| Information Element | Value/remark | Comment | Condition |
| Payload container type | '0010'B | SMS | |
| Payload container | CP-DATA | RP-ACK RPDU | |

Table 9.1.8.2.3.3-4: UL NAS TRANSPORT (step 6, Table 9.1.8.2.3.2-1)

| Derivation path: TS 38.508-1 [4], Table 4.7.1-10 | | | |
|--|--------------|---|-----------|
| Information Element | Value/remark | Comment | Condition |
| Payload container type | '0010'B | SMS | |
| Payload container | CP-DATA | RP-DATA RPDU
TI used in steps 6,
7 and 8 shall be
x2, with x1 \subset x2
(see step 2). | |

Table 9.1.8.2.3.3-5: DL NAS TRANSPORT (step 7, Table 9.1.8.2.3.2-1)

| Derivation path: TS 38.508-1 [4], Table 4.7.1-11 | | | |
|--|--------------|---------|-----------|
| Information Element | Value/remark | Comment | Condition |
| Payload container type | '0010'B | SMS | |
| Payload container | CP-ACK | | |

Table 9.1.8.2.3.3-6: DL NAS TRANSPORT (step 8, Table 9.1.8.2.3.2-1)

| Derivation path: TS 38.508-1 [4], Table 4.7.1-11 | | | |
|--|--------------|-------------|-----------|
| Information Element | Value/remark | Comment | Condition |
| Payload container type | '0010'B | SMS | |
| Payload container | CP-DATA | RP-ACK RPDU | |

Table 9.1.8.2.3.3-7: UL NAS TRANSPORT (step 10, Table 9.1.8.2.3.2-1)

| Derivation path: TS 38.508-1 [4], Table 4.7.1-10 | | | |
|--|--------------|---|-----------|
| Information Element | Value/remark | Comment | Condition |
| Payload container type | '0010'B | SMS | |
| Payload container | CP-DATA | RP-DATA RPDU TI used in steps 10, 11, 12 and 13 shall be x3, with x3 > x2 (see step 6). | |

Table 9.1.8.2.3.3-8: DL NAS TRANSPORT (step 11, Table 9.1.8.2.3.2-1)

| Derivation path: TS 38.508-1 [4], Table 4.7.1-11 | | | |
|--|--------------|---------|-----------|
| Information Element | Value/remark | Comment | Condition |
| Payload container type | '0010'B | SMS | |
| Payload container | CP-ACK | | |

Table 9.1.8.2.3.3-9: DL NAS TRANSPORT (step 12, Table 9.1.8.2.3.2-1)

| Derivation path: TS 38.508-1 [4], Table 4.7.1-11 | | | |
|--|--------------|-------------|-----------|
| Information Element | Value/remark | Comment | Condition |
| Payload container type | '0010'B | SMS | |
| Payload container | CP-DATA | RP-ACK RPDU | |

Table 9.1.8.2.3.3-10: UL NAS TRANSPORT (step 13, Table 9.1.8.2.3.2-1)

| Derivation path: TS 38.508-1 [4], Table 4.7.1-10 | | | |
|--|--------------|---------|-----------|
| Information Element | Value/remark | Comment | Condition |
| Payload container type | '0010'B | SMS | |
| Payload container | CP-ACK | | |

Table 9.1.8.2.3.3-11: DL NAS TRANSPORT (step 14, Table 9.1.8.2.3.2-1)

| Derivation path: TS 38.508-1 [4], Table 4.7.1-11 | | | |
|--|--------------|--|-----------|
| Information Element | Value/remark | Comment | Condition |
| Payload container type | '0010'B | SMS | |
| Payload container | CP-DATA | RP-DATA RPDU TI used in steps 14, 15 and 16 is y1. | |

Table 9.1.8.2.3.3-12: UL NAS TRANSPORT (step 15, Table 9.1.8.2.3.2-1)

| Derivation path: TS 38.508-1 [4], Table 4.7.1-10 | | | |
|--|--------------|---------|-----------|
| Information Element | Value/remark | Comment | Condition |
| Payload container type | '0010'B | SMS | |
| Payload container | CP-ACK | | |

Table 9.1.8.2.3.3-13: UL NAS TRANSPORT (step 16, Table 9.1.8.2.3.2-1)

| Derivation path: TS 38.508-1 [4], Table 4.7.1-10 | | | |
|--|--------------|-------------|-----------|
| Information Element | Value/remark | Comment | Condition |
| Payload container type | '0010'B | SMS | |
| Payload container | CP-DATA | RP-ACK RPDU | |

Table 9.1.8.2.3.3-14: DL NAS TRANSPORT (step 17, Table 9.1.8.2.3.2-1)

| Derivation path: TS 38.508-1 [4], Table 4.7.1-11 | | | |
|--|--------------|--|-----------|
| Information Element | Value/remark | Comment | Condition |
| Payload container type | '0010'B | SMS | |
| Payload container | CP-DATA | RP-DATA RPDU TI used in steps 17, 18, 19 and 20 is y2, with y2 < y1 (see step 14). | |

Table 9.1.8.2.3.3-15: UL NAS TRANSPORT (step 18, Table 9.1.8.2.3.2-1)

| Derivation path: TS 38.508-1 [4], Table 4.7.1-10 | | | |
|--|--------------|---------|-----------|
| Information Element | Value/remark | Comment | Condition |
| Payload container type | '0010'B | SMS | |
| Payload container | CP-ACK | | |

Table 9.1.8.2.3.3-16: UL NAS TRANSPORT (step 19, Table 9.1.8.2.3.2-1)

| Derivation path: TS 38.508-1 [4], Table 4.7.1-10 | | | |
|--|--------------|-------------|-----------|
| Information Element | Value/remark | Comment | Condition |
| Payload container type | '0010'B | SMS | |
| Payload container | CP-DATA | RP-ACK RPDU | |

Table 9.1.8.2.3.3-17: DL NAS TRANSPORT (step 20, Table 9.1.8.2.3.2-1)

| Derivation path: TS 38.508-1 [4], Table 4.7.1-11 | | | |
|--|--------------|---------|-----------|
| Information Element | Value/remark | Comment | Condition |
| Payload container type | '0010'B | SMS | |
| Payload container | CP-ACK | | |

9.2 5GS Non-3GPP Access Mobility Management

9.2.1 Primary authentication and key agreement procedure

9.2.1.1 EAP based primary authentication and key agreement

9.2.1.1.1 Test Purpose (TP)

Same TP's as clause 9.1.1.1.1

9.2.1.1.2 Conformance requirements

Same Conformance requirements as in clause 9.1.1.1.2.

9.2.1.1.3 Test description

9.2.1.1.3.1 Pre-test conditions

System Simulator:

- WLAN Cell 27

UE:

- None.

Preamble:

- The UE is in state Switched OFF (state 0W-B) according to TS 38.508-1 [4].

9.2.1.1.3.2 Test procedure sequence

Table 9.2.1.1.3.2-1: Main behaviour

| St | Procedure | Message Sequence | | TP | Verdict |
|-------|--|------------------|-------------------------------|----|---------|
| | | U - S | Message | | |
| 1 | Switch the UE on | - | - | - | - |
| 2-4 | The UE initiates establishment of an IPsec tunnel and registration procedure by executing steps 1-3 of Table 4.5.2.2-3 in TS 38.508-1 [4]. | - | - | - | - |
| 5 | SS transmits an AUTHENTICATION REQUEST message with an EAP-Request/AKA'-Identity message. | <-- | 5GMM: AUTHENTICATION REQUEST | | |
| 6 | Check: Does the UE respond with an AUTHENTICATION RESPONSE message, with an EAP-Response/AKA'-Identity message? | --> | 5GMM: AUTHENTICATION RESPONSE | 1 | P |
| 7 | SS transmits an AUTHENTICATION REQUEST message with an EAP-Request/AKA'-challenge message which contains a not correct sequence number. | <-- | 5GMM: AUTHENTICATION REQUEST | - | - |
| 8 | Check: Does the UE respond with an AUTHENTICATION RESPONSE message, with an EAP-Response/AKA'-synchronization-failure? | --> | 5GMM: AUTHENTICATION RESPONSE | 2 | P |
| 9 | SS transmits a correct AUTHENTICATION REQUEST message with an EAP-Request/AKA'-challenge message. | <-- | 5GMM: AUTHENTICATION REQUEST | - | - |
| 10 | Check: Does the UE respond with a correct AUTHENTICATION RESPONSE message, with an EAP-Request/AKA'-challenge message? | --> | 5GMM: AUTHENTICATION RESPONSE | 3 | P |
| 11 | SS transmits an AUTHENTICATION RESULT message with an EAP-success message. | <-- | 5GMM: AUTHENTICATION RESULT | - | - |
| 12-14 | The registration procedure is performed by executing steps 6-8 of Table 4.5.2.2-3 in TS 38.508-1 [4]. | - | - | - | - |
| 15 | Check: Does the UE transmits a REGISTRATION COMPLETE message? | --> | 5GMM: REGISTRATION COMPLETE | 4 | P |
| 16 | The registration procedure is successfully completed by executing steps 10 of Table 4.5.2.2-3 in TS 38.508-1 [4]. | - | - | - | - |

9.2.1.1.3.3 Specific message contents

Table 9.2.1.1.3.3-1: Message AUTHENTICATION REQUEST (step 5, Table 9.2.1.1.3.2-1)

| Derivation path: TS 38.508-1 [4], table 4.7.1-1 | | | |
|---|---------------------------|---|-----------|
| Information Element | Value/Remark | Comment | Condition |
| EAP message | EAP-request/AKA'-Identity | See Table 4.7.3.2-7 in TS 38.508-1 [4]. | EAP-AKA |

Table 9.2.1.1.3.3-2: Message AUTHENTICATION RESPONSE (step 6, Table 9.2.1.1.3.2-1)

| Derivation path: TS 38.508-1 [4], table 4.7.1-2 | | | |
|---|----------------------------|---|-----------|
| Information Element | Value/Remark | Comment | Condition |
| EAP message | EAP-response/AKA'-Identity | See Table 4.7.3.2-8 in TS 38.508-1 [4]. | EAP-AKA |

Table 9.2.1.1.3.3-3: Message AUTHENTICATION REQUEST (step 7, Table 9.2.1.1.3.2-1)

| Derivation path: TS 38.508-1 [4], table 4.7.1-1 | | | |
|---|----------------------------|--|-----------|
| Information Element | Value/Remark | Comment | Condition |
| EAP message | EAP-request/AKA'-challenge | The sequence number in AUTN is not correct | EAP-AKA |

Table 9.2.1.1.3.3-4: Message AUTHENTICATION RESPONSE (step 8, Table 9.2.1.1.3.2-1)

| Derivation path: TS 38.508-1 [4], table 4.7.1-2 | | | |
|---|---|---|-----------|
| Information Element | Value/Remark | Comment | Condition |
| EAP message | EAP-response/AKA'-synchronization-failure | See Table 4.7.3.2-5 in TS 38.508-1 [4]. | EAP-AKA |

Table 9.2.1.1.3.3-5: Message AUTHENTICATION RESPONSE (step 10, Table 9.2.1.1.3.2-1)

| Derivation path: TS 38.508-1 [4], table 4.7.1-2 | | | |
|---|-----------------------------|---|-----------|
| Information Element | Value/Remark | Comment | Condition |
| EAP message | EAP-Response/AKA'-Challenge | RES* equal to the XRES* calculated in the SS with the parameters provided/indicated in the AUTHENTICATION REQUEST | EAP-AKA |

Table 9.2.1.1.3.3-6: Message AUTHENTICATION RESULT (step 11, Table 9.2.1.1.3.2-1)

| Derivation path: TS 38.508-1 [4], table 4.7.1-3 | | | |
|---|--------------|---------|-----------|
| Information Element | Value/Remark | Comment | Condition |
| EAP message | EAP-Success | | EAP-AKA |

9.2.1.2 5G AKA based primary authentication and key agreement

9.2.1.2.1 Test Purpose (TP)

Same Test purpose as in clause 9.1.1.4.1

9.2.1.2.2 Conformance requirements

Same Conformance requirements as in clause 9.1.1.4.2

9.2.1.2.3 Test description

9.2.1.2.3.1 Pre-test conditions

System Simulator:

- WLAN Cell 27

UE:

- None.

Preamble:

- The UE is in state Switched OFF (state 0W-B) according to TS 38.508-1 [4].

9.2.1.2.3.2 Test procedure sequence

Table 9.2.1.2.3.2-1: Main behaviour

| St | Procedure | Message Sequence | | TP | Verdict |
|-------|---|------------------|-------------------------|----|---------|
| | | U - S | Message | | |
| 1 | Switch the UE on | - | - | - | - |
| 2-4 | The UE initiates establishment of an IPsec tunnel and registration procedure by executing steps 1-3 of Table 4.5.2.2-3 in TS 38.508-1 [4]. | - | - | - | - |
| 5 | The SS transmits an AUTHENTICATION REQUEST message which contains an invalid MAC code. | <-- | AUTHENTICATION REQUEST | - | - |
| 6 | Check: Does the UE respond with an AUTHENTICATION FAILURE message with 5GMM cause "MAC failure"? | --> | AUTHENTICATION FAILURE | 1 | P |
| 7 | SS transmits a correct AUTHENTICATION REQUEST message with RAND different to the one send in Step 5 | <-- | AUTHENTICATION REQUEST | - | - |
| 8 | Check: Does the UE respond with a correct AUTHENTICATION RESPONSE message with RES* that is equal to the XRES* calculated in the SS? | --> | AUTHENTICATION RESPONSE | 4 | P |
| 9 | SS transmits a NAS SECURITY MODE COMMAND message including the ngKSI of the new 5G NAS security context (as provided in step 7), to proceed with the registration procedure. | <-- | SECURITY MODE COMMAND | - | - |
| 10 | Check: Does the UE respond with NAS SECURITY MODE COMPLETE message integrity protected and ciphered with the new 5G NAS security context identified by the ngKSI received in the SECURITY MODE COMMAND message in step 9. | --> | SECURITY MODE COMPLETE | 5 | P |
| 11 | Steps 10 of the generic procedure (TS 38.508-1 Table 4.5.2.2-3 [4]) are executed to successfully complete the registration procedure. | - | - | - | - |
| 12 | Switch off procedure in Ipsec_SA_Established specified in TS 38.508-1 [4] subclause 4.9.6.5 is performed. | - | - | - | - |
| 13-16 | Steps 1-4 above are repeated | - | - | - | - |
| 17 | SS transmits an AUTHENTICATION REQUEST message with "separation bit" in the AMF field is 0. | <-- | AUTHENTICATION REQUEST | - | - |
| 18 | Check: Does the UE respond with an AUTHENTICATION FAILURE message, with 5GMM cause " Non-5G authentication unacceptable "? | --> | AUTHENTICATION FAILURE | 2 | P |
| 19 | SS transmits a correct AUTHENTICATION REQUEST message with RAND different to the one send in Step 22 | <-- | AUTHENTICATION REQUEST | - | - |
| 20 | Check: Does the UE respond with a correct AUTHENTICATION RESPONSE message with RES* that is equal to the XRES* calculated in the SS? | --> | AUTHENTICATION RESPONSE | 4 | P |
| 21 | Step 10 of the generic procedure (TS 38.508-1 Table 4.5.2.2-3 [4]) are executed to successfully complete the registration procedure. | - | - | - | - |
| 22 | Switch off procedure in Ipsec_SA_Established specified in TS 38.508-1 [4] subclause 4.9.6.5 is performed. | - | - | - | - |
| 23-26 | Steps 1-4 above are repeated | - | - | - | - |
| 27 | SS transmits AUTHENTICATION REQUEST | <-- | AUTHENTICATION REQUEST | - | - |

| | | | | | |
|----|--|-----|-------------------------|---|---|
| | message with the AMF field in the IE "Authentication parameter AUTN" set to "AMF _{RESYNCH} " value to trigger SQN re-synchronisation procedure in test USIM | | | | |
| 28 | Check: Does the UE respond with an AUTHENTICATION FAILURE message, with 5GMM cause "Synch failure" and Authentication failure parameter? | --> | AUTHENTICATION FAILURE | 3 | P |
| 29 | SS transmits a correct AUTHENTICATION REQUEST message with RAND different to the one send in Step 32. | <-- | AUTHENTICATION REQUEST | - | - |
| 30 | Check: Does the UE respond with a correct AUTHENTICATION RESPONSE message with RES* that is equal to the XRES* calculated in the SS? | --> | AUTHENTICATION RESPONSE | 4 | P |
| 31 | Step 10 of the generic procedure (TS 38.508-1 Table 4.5.2.2-3 [4]) are executed to successfully complete the registration procedure. | - | - | - | - |

9.2.1.2.3.3 Specific message contents

Table 9.2.1.2.3.3-1: AUTHENTICATION RESPONSE (step 8, step 20 and step 30, Table 9.2.1.2.3.2-1)

| Derivation path: TS 38.508, Table 4.7.1-2 | | | |
|---|---|---------|-----------|
| Information Element | Value/remark | Comment | Condition |
| Authentication response parameter | RES* equal to the XRES* calculated in the SS with the parameters provided/indicated in the AUTHENTICATION REQUEST | | |

Table 9.2.1.2.3.3-2: AUTHENTICATION REQUEST (step 5, Table 9.2.1.2.3.2-1)

| Derivation path: TS 38.508, Table 4.7.1-1 | | | |
|---|--------------|---|-----------|
| Information Element | Value/remark | Comment | Condition |
| Authentication parameter AUTN | Invalid MAC | SS shall calculate the correct MAC value as specified in TS 33.102 and use any different value, e.g. correct_MAC+5. | |

Table 9.2.1.2.3.3-3: AUTHENTICATION FAILURE (step 6, Table 9.2.1.2.3.2-1)

| Derivation path: TS 38.508, Table 4.7.1-4 | | | |
|---|--------------|-------------|-----------|
| Information Element | Value/remark | Comment | Condition |
| 5GMM cause | '0001 0100'B | MAC failure | |

Table 9.2.1.2.3.3-4: AUTHENTICATION REQUEST (step 17, Table 9.2.1.2.3.2-1)

| Derivation path: TS 38.508, Table 4.7.1-1 | | | |
|---|--------------------|--|-----------|
| Information Element | Value/remark | Comment | Condition |
| Authentication parameter AUTN | "separation bit"=0 | The "separation bit" in the AMF field of AUTN supplied by the core network is 0. | |

Table 9.2.1.2.3.3-5: AUTHENTICATION FAILURE (step 18, Table 9.2.1.2.3.2-1)

| Derivation path: TS 38.508, Table 4.7.1-4 | | | |
|---|--------------|------------------------------------|-----------|
| Information Element | Value/remark | Comment | Condition |
| 5GMM cause | '0001 1010'B | Non-5G authentication unacceptable | |

Table 9.2.1.2.3.3-6: AUTHENTICATION REQUEST (step 27, Table 9.2.1.2.3.2-1)

| Derivation path: TS 38.508, Table 4.7.1-1 | | | |
|---|--|--|-----------|
| Information Element | Value/remark | Comment | Condition |
| Authentication parameter AUTN | AMF field set to "AMF _{FRESYNCH} ",
AMF _{FRESYNCH} = '1111 1111 1111 1111'B | AMF _{FRESYNCH} see TS 34.108, 8.1.2.2 | |

Table 9.2.1.2.3.3-7: AUTHENTICATION FAILURE (step 28, Table 9.2.1.2.3.2-1)

| Derivation path: TS 38.508, Table 4.7.1-4 | | | |
|---|--------------|-----------------------------|-----------|
| Information Element | Value/remark | Comment | Condition |
| 5GMM cause | '0001 0101'B | Synch failure | |
| Authentication failure parameter | AUTS | AUTS see TS 34.108, 8.1.2.2 | |

9.2.2 Security Mode Control

9.2.2.1 NAS security mode command

9.2.2.1.1 Test Purpose (TP)

(1)

```
with { the UE is in 5GMM-REGISTERED-INITIATED state and the SS initiates the NAS security mode control procedure by sending a SECURITY MODE COMMAND message during initial registration procedure }
ensure that {
  when { the UE receives an integrity protected SECURITY MODE COMMAND message including not matching replayed security capabilities }
  then { the UE send a SECURITY MODE REJECT message and does not start applying the NAS security in both UL and DL }
}
```

(2)

```
with { the UE is in 5GMM-REGISTERED-INITIATED state and the SS initiates the NAS security mode control procedure by sending a SECURITY MODE COMMAND message during initial registration procedure }
ensure that {
  when { the UE receives an integrity protected SECURITY MODE COMMAND message including IMEISV request }
  then { the UE send an integrity protected and ciphered SECURITY MODE COMPLETE message including IMEISV and starts applying the NAS Security in both UL and DL }
}
```

9.2.2.1.2 Conformance requirements

References: The conformance requirements covered in the present test case are specified in: TS 24.501, clauses 5.4.2.1, 5.4.2.3 and 5.4.2.5. Unless otherwise stated these are Rel-15 requirements.

[TS 24.501, clause 5.4.2.1]

The purpose of the NAS security mode control procedure is to take a 5G NAS security context into use, and initialise and start NAS signalling security between the UE and the AMF with the corresponding 5G NAS keys and 5G NAS security algorithms.

Furthermore, the network may also initiate the security mode control procedure in the following cases:

- a)- in order to change the 5G NAS security algorithms for a current 5G NAS security context already in use;
- b) in order to change the value of uplink NAS COUNT used in the latest SECURITY MODE COMPLETE message as described in 3GPP TS 33.501 [24], subclause 6.9.4.4; and
- c) in order to provide the Selected EPS NAS security algorithms to the UE

For restrictions concerning the concurrent running of a security mode control procedure with other security related procedures in the AS or inside the core network see 3GPP TS 33.501 [24], subclause 6.9.5.

[TS 24.501, clause 5.4.2.3]

Upon receipt of the SECURITY MODE COMMAND message, the UE shall check whether the security mode command can be accepted or not. This is done by performing the integrity check of the message, and by checking that the received Replayed UE security capabilities IE has not been altered compared to the latest values that the UE sent to the network.

When the SECURITY MODE COMMAND message includes an EAP-success message the UE handles the EAP-success message and the ABBA as described in subclause 5.4.1.2.2.8.

If the UE is registered for emergency services, performing initial registration for emergency services or establishing an emergency PDU session and the SECURITY MODE COMMAND message is received with ngKSI value "000" and 5G-IA0 and 5G-EA0 as selected 5G NAS security algorithms, the UE shall locally derive and take in use 5G NAS security context. The UE shall delete existing current 5G NAS security context.

The UE shall ignore the Replayed S1 UE security capabilities IE if this IE is included in the SECURITY MODE COMMAND message.

The UE shall accept a SECURITY MODE COMMAND message indicating the "null integrity protection algorithm" 5G-EA0 as the selected 5G NAS integrity algorithm only if the message is received when the UE is registered for emergency services, performing initial registration for emergency services or establishing an emergency PDU session.

If the type of security context flag included in the SECURITY MODE COMMAND message is set to "native security context" and if the ngKSI matches a valid non-current native 5G NAS security context held in the UE while the UE has a mapped 5G NAS security context as the current 5G NAS security context, the UE shall take the non-current native 5G NAS security context into use which then becomes the current native 5G NAS security context and delete the mapped 5G NAS security context.

If the SECURITY MODE COMMAND message can be accepted, the UE shall take the 5G NAS security context indicated in the message into use. The UE shall in addition reset the uplink NAS COUNT counter if:

- a) the SECURITY MODE COMMAND message is received in order to take a 5G NAS security context into use created after a successful execution of the 5G AKA based primary authentication and key agreement procedure or the EAP based primary authentication and key agreement procedure; or
- b) the SECURITY MODE COMMAND message received includes the type of security context flag set to "mapped security context" in the NAS key set identifier IE the ngKSI does not match the current 5G NAS security context, if it is a mapped 5G NAS security context.

If the SECURITY MODE COMMAND message can be accepted and a new 5G NAS security context is taken into use and SECURITY MODE COMMAND message does not indicate the "null integrity protection algorithm" 5G-IA0 as the selected NAS integrity algorithm, the UE shall:

- if the SECURITY MODE COMMAND message has been successfully integrity checked using an estimated downlink NAS COUNT equal to 0, then the UE shall set the downlink NAS COUNT of this new 5G NAS security context to 0;
- otherwise the UE shall set the downlink NAS COUNT of this new 5G NAS security context to the downlink NAS COUNT that has been used for the successful integrity checking of the SECURITY MODE COMMAND message.

If the SECURITY MODE COMMAND message includes the horizontal derivation parameter indicating "K_{AMF} derivation is required", the UE shall derive a new K'_{AMF}, as specified in 3GPP TS 33.501 [24] for K_{AMF} to K'_{AMF} derivation in mobility, and set both uplink and downlink NAS COUNTs to zero. When the new 5G NAS security context is taken into use for current access and the UE is registered with the same PLMN over the 3GPP access and the non-3GPP access:

- a) the UE is in 5GMM-IDLE mode over the non-current access, the AMF and the UE shall activate the new 5G NAS security context over the non-current access as described in 3GPP TS 33.501 [24]. The AMF and the UE shall set the downlink NAS COUNT and uplink NAS COUNT to zero for the non-current access; or
- b) the UE is in 5GMM-CONNECTED mode over the non-current access, the AMF shall send the SECURITY MODE COMMAND message over the non-current access to activate the new 5G NAS security context that was activated over the current access as described in 3GPP TS 33.501 [24]. The AMF shall include the same ngKSI in the SECURITY MODE COMMAND message to identify the new 5G NAS security context.

If the SECURITY MODE COMMAND message includes the horizontal derivation parameter indicating "K_{AMF} derivation is not required" or the Additional 5G security parameters IE is not included in the message, the UE is registered with the same PLMN over the 3GPP access and non-3GPP access, then after the completion of a security mode control procedure over the current access:

- a) the UE is in 5GMM-IDLE mode over the non-current access, the AMF and the UE shall activate the new 5G NAS security context for the non-current access. If a primary authentication and key agreement procedure was completed before the security mode control procedure, the AMF and the UE shall set the downlink NAS COUNT and uplink NAS COUNT to zero for the non-current access, otherwise the downlink NAS COUNT and uplink NAS COUNT for the non-3GPP access are not changed; or
- b) the UE is in 5GMM-CONNECTED mode over the non-current access, the AMF shall send the SECURITY MODE COMMAND message over the non-current access to activate the new 5G NAS security context that was activated over the current access as described in 3GPP TS 33.501 [24]. The AMF shall include the same ngKSI in the SECURITY MODE COMMAND message to identify the new 5G NAS security context.

If the SECURITY MODE COMMAND message can be accepted, the UE shall send a SECURITY MODE COMPLETE message integrity protected with the selected 5GS integrity algorithm and the 5G NAS integrity key based on the K_{AMF} or mapped K'_{AMF} if the type of security context flag is set to "mapped security context" indicated by the ngKSI. When the SECURITY MODE COMMAND message includes the type of security context flag set to "mapped security context" in the NAS key set identifier IE, then the UE shall check whether the SECURITY MODE COMMAND message indicates the ngKSI of the current 5GS security context, if it is a mapped 5G NAS security context, in order not to re-generate the K'_{AMF}.

Furthermore, if the SECURITY MODE COMMAND message can be accepted, the UE shall cipher the SECURITY MODE COMPLETE message with the selected 5GS ciphering algorithm and the 5GS NAS ciphering key based on the K_{AMF} or mapped K'_{AMF} indicated by the ngKSI. The UE shall set the security header type of the message to "integrity protected and ciphered with new 5G NAS security context".

From this time onward the UE shall cipher and integrity protect all NAS signalling messages with the selected 5GS integrity and ciphering algorithms.

If the AMF indicated in the SECURITY MODE COMMAND message that the IMEISV is requested, the UE shall include its IMEISV in the SECURITY MODE COMPLETE message.

If, during an ongoing registration procedure or service request procedure, the SECURITY MODE COMMAND message includes the Additional 5G security information IE with the RINMR bit set to "Retransmission of the initial NAS message requested", the UE shall include the entire unciphered REGISTRATION REQUEST message or SERVICE REQUEST message, which the UE had previously included in the NAS message container IE of the initial NAS message (i.e. REGISTRATION REQUEST message or SERVICE REQUEST message, respectively), in the NAS message container IE of the SECURITY MODE COMPLETE message.

If, prior to receiving the SECURITY MODE COMMAND message, the UE without a valid 5GS NAS security context had sent a REGISTRATION REQUEST message the UE shall include the entire REGISTRATION REQUEST message in the NAS message container IE of the SECURITY MODE COMPLETE message as described in subclause 4.4.6.

If the UE operating in the single-registration mode receives the Selected EPS NAS security algorithms IE, the UE shall use the IE according to 3GPP TS 33.501 [24].

For a UE operating in single-registration mode with N26 interface supported in the network, after an inter-system change from S1 mode to N1 mode in 5GMM-CONNECTED mode, the UE shall set the value of the Selected EPS NAS security algorithms IE in the 5G NAS security context to the NAS security algorithms that were received from the source MME when the UE was in S1 mode.

[TS 24.501, clause 5.4.2.5]

If the security mode command cannot be accepted, the UE shall send a SECURITY MODE REJECT message. The SECURITY MODE REJECT message contains a 5GMM cause that typically indicates one of the following cause values:

- #23 UE security capabilities mismatch.
- #24 security mode rejected, unspecified.

If the UE detects that the received Replayed UE security capabilities IE has been altered compared to the latest values that the UE sent to the network, the UE shall set the cause value to #23 "UE security capabilities mismatch".

Upon receipt of the SECURITY MODE REJECT message, the AMF shall stop timer T3560. The AMF shall also abort the ongoing procedure that triggered the initiation of the NAS security mode control procedure.

Both the UE and the AMF shall apply the 5G NAS security context in use before the initiation of the security mode control procedure, if any, to protect the SECURITY MODE REJECT message and any other subsequent messages according to the rules in subclause 4.4.4 and 4.4.5.

9.2.2.1.3 Test description

9.2.2.1.3.1 Pre-test conditions

System Simulator:

- WLAN Cell 27

UE:

- None.

Preamble:

- The UE is in state Switched OFF (state 0-A) according to TS 38.508-1 [4].

9.2.2.1.3.2 Test procedure sequence

Table 9.2.2.1.3.2-1: Main behaviour

| St | Procedure | Message Sequence | | TP | Verdict |
|---|---|------------------|-------------------------|----|---------|
| | | U - S | Message | | |
| 1 | The UE is switched on. | - | - | - | - |
| 1A | The UE transmits a REGISTRATION REQUEST message. | --> | REGISTRATION REQUEST | - | - |
| 1B | The SS transmits an AUTHENTICATION REQUEST message including EAP-Request/AKA'-Challenge or 5G AKA Challenge. | <-- | AUTHENTICATION REQUEST | - | - |
| 1C | The UE transmits an AUTHENTICATION RESPONSE message including EAP-Response/AKA'-Challenge or 5G AKA Response. | --> | AUTHENTICATION RESPONSE | - | - |
| 1D | The SS transmits a SECURITY MODE COMMAND message including EAP-Success if EAP-AKA' used. | <-- | SECURITY MODE COMMAND | - | - |
| 1E | The UE transmits a SECURITY MODE COMPLETE message. | --> | SECURITY MODE COMPLETE | - | - |
| 1F | The SS transmits a REGISTRATION REJECT message with the cause value set to #6 Illegal ME as default. | <-- | REGISTRATION REJECT | - | - |
| 1G | The UE is switched off. | - | - | - | - |
| 1H | The UE is switched on. | - | - | - | - |
| 2-6 | Steps 1-5 of the generic procedure for UE registration specified in TS 38.508-1 [4] table 4.5.2.2-3 are performed. | - | - | - | - |
| 7 | The SS transmits a SECURITY MODE COMMAND message to activate NAS security. It is integrity protected and includes unmatched replayed security capabilities. | <-- | SECURITY MODE COMMAND | - | - |
| 8 | Check: Does the UE transmit a SECURITY MODE REJECT message with cause'#23: UE security capabilities mismatch'? | --> | SECURITY MODE REJECT | 1 | P |
| 9 | The SS transmits an IDENTITY REQUEST message (Security not applied). | <-- | IDENTITY REQUEST | - | - |
| 10 | Check: Does the UE transmit a non-security protected IDENTITY RESPONSE message? | --> | IDENTITY RESPONSE | 1 | P |
| 11 | The SS transmits a SECURITY MODE COMMAND message to activate NAS security. It is integrity protected and includes IMEISV. | <-- | SECURITY MODE COMMAND | - | - |
| 12 | Check: Does the UE transmit a SECURITY MODE COMPLETE message and does it establish the initial security configuration? | --> | SECURITY MODE COMPLETE | 2 | P |
| 13-15 | Steps 8-10 of the generic procedure for UE registration specified in TS 38.508-1 [4] table 4.5.2.2-3 are performed. | - | - | - | - |
| 16 | The SS transmits an IDENTITY REQUEST message (Security protected as per the algorithms specified in step 11). | <- | IDENTITY REQUEST | - | - |
| 17 | Check: Does the UE transmit an IDENTITY RESPONSE message (Security Protected as per the algorithms specified in step 11)? | --> | IDENTITY RESPONSE | 2 | P |
| Note 1: The UE establishes an IPsec tunnel in parallel to 5GC registration steps 4 to 12 as per the IKEv2 protocol as defined in 3GPP TS 23.502 [31] clause 4.12.2.2 figure 4.12.2.2-1. | | | | | |

9.2.2.1.3.3 Specific message contents

Table 9.2.2.1.3.3-0: REGISTRATION REJECT (Step 1F, Table 9.2.2.1.3.2-1)

| Derivation path: TS 38.508-1 [4], table 4.7.1-9 | | | |
|---|--------------|------------|-----------|
| Information Element | Value/Remark | Comment | Condition |
| 5GMM cause | '00000110'B | Illegal ME | |

Table 9.2.2.1.3.3-1: SECURITY MODE COMMAND (Step 7, Table 9.2.2.1.3.2-1)

| Derivation path: TS 38.508-1 [4], table 4.7.1-25 | | | |
|--|--|---------|-----------|
| Information Element | Value/Remark | Comment | Condition |
| Replayed UE security capabilities | Set to mismatch the security capability of UE under test | | |

Table 9.2.2.1.3.3-2: SECURITY MODE REJECT (Step 8, Table 9.2.2.1.3.2-1)

| Derivation path: TS 38.508-1 [4], table 4.7.1-27 | | | |
|--|--------------|---------|-----------|
| Information Element | Value/Remark | Comment | Condition |
| 5GMM cause | #23 | | |

Table 9.2.2.1.3.3-3: IDENTITY REQUEST (Step 9, Table 9.2.2.1.3.2-1)

| Derivation path: TS 38.508-1 [4], table 4.7.1-21 | | | |
|--|--------------|---------|-----------|
| Information Element | Value/Remark | Comment | Condition |
| Identity type | '0001'B | SUCI | |

Table 9.2.2.1.3.3-4: IDENTITY RESPONSE (Step 10, Table 9.2.2.1.3.2-1)

| Derivation path: TS 38.508-1 [4], table 4.7.1-22 | | | |
|--|--------------|---------|-----------|
| Information Element | Value/Remark | Comment | Condition |
| Mobile identity | | | |
| Type of identity | '001'B | SUCI | |

Table 9.2.2.1.3.3-5: SECURITY MODE COMMAND (Step 11, Table 9.2.2.1.3.2-1)

| Derivation path: TS 38.508-1 [4], table 4.7.1-25 | | | |
|--|--|------------------------------|-----------|
| Information Element | Value/Remark | Comment | Condition |
| Selected NAS security algorithms | | | |
| Type of ciphering algorithm | Set according to PIXIT parameter for default ciphering algorithm if it is set to a value different to 5G-EA0, or, set to any value different to 5G-EA0 otherwise | Non-zero ciphering algorithm | |
| IMEISV request | Present | | |

Table 9.2.2.1.3.3-6: SECURITY MODE COMPLETE (Step 12, Table 9.2.2.1.3.2-1)

| Derivation path: TS 38.508-1 [4], table 4.7.1-26 | | | |
|--|--------------|---------|-----------|
| Information Element | Value/Remark | Comment | Condition |
| IMEISV | Present | | |

Table 9.2.2.1.3.3-7: IDENTITY REQUEST (Step 16, Table 9.2.2.1.3.2-1)

| Derivation path: TS 38.508-1 [4], table 4.7.1-21 | | | |
|--|--------------|---------|-----------|
| Information Element | Value/Remark | Comment | Condition |
| Identity type | '0011'B | IMEI | |

Table 9.2.2.1.3.3-8: IDENTITY RESPONSE (Step 17, Table 9.2.2.1.3.2-1)

| Derivation path: TS 38.508-1 [4], table 4.7.1-22 | | | |
|--|--------------|---------|-----------|
| Information Element | Value/Remark | Comment | Condition |
| Mobile identity | | | |
| Type of identity | '011'B | IMEI | |

9.2.2.2 Protection of initial NAS signalling messages

9.2.2.2.1 Test Purpose (TP)

Same Test purpose as in clause 9.1.2.2.1

9.2.2.2.2 Conformance requirements

Same conformance requirements as in clause 9.1.2.2.2

9.2.2.2.3 Test description

9.2.2.2.3.1 Pre-test conditions

System Simulator:

- WLAN Cell 27.

UE:

- None.

Preamble:

- The UE is in state 0W-B on WLAN Cell 27 according to TS 38.508-1 [4].
- The UE does not have a valid 5G NAS security context.

9.2.2.2.3.2 Test procedure sequence

Table 9.2.2.2.3.2-1: Main behaviour

| St | Procedure | Message Sequence | | TP | Verdict |
|------|---|------------------|-------------------------|----|---------|
| | | U - S | Message | | |
| 1 | The UE is switched on. | - | - | - | - |
| 2-3 | Steps 1-2 of the generic procedure for UE registration specified in TS 38.508-1 [4] table 4.5.2.2-3 are performed. | - | - | - | - |
| - | Exception: The UE establishes an IPsec tunnel in parallel to 5GC registration steps 4 to 8 as per the IKEv2 protocol as defined in 3GPP TS 23.502 [31] clause 4.12.2.2 figure 4.12.2.2-1. | - | - | - | - |
| 4 | The UE transmits a REGISTRATION REQUEST message. | --> | REGISTRATION REQUEST | 1 | P |
| 5 | The SS transmits a <i>DLInformationTransfer</i> message and a AUTHENTICATION REQUEST message. | <-- | AUTHENTICATION REQUEST | - | - |
| 6 | The UE transmits an <i>ULInformationTransfer</i> message and a AUTHENTICATION RESPONSE message. | --> | AUTHENTICATION RESPONSE | - | - |
| 7 | The SS transmits a <i>DLInformationTransfer</i> message and a SECURITY MODE COMMAND message. | <-- | SECURITY MODE COMMAND | | |
| 8 | The UE transmits an <i>ULInformationTransfer</i> message and a SECURITY MODE COMPLETE message. | --> | SECURITY MODE COMPLETE | 2 | P |
| 9-11 | Steps 8-10 of the generic procedure for UE registration specified in TS 38.508-1 [4] table 4.5.2.2-3 are performed. | - | - | - | - |

9.2.2.2.3.3 Specific message contents

Table 9.2.2.2.3.3-1: REGISTRATION REQUEST (Step 4, Table 9.2.2.2.3.2-1)

| Derivation path: TS 38.508-1 [4], table 4.7.1-6 using condition NON_CLEARTEXT_IE | | | |
|--|--------------|---------|-----------|
| Information Element | Value/Remark | Comment | Condition |
| | | | |

Table 9.2.2.2.3.3-2: SECURITY MODE COMPLETE (Step 8, Table 9.2.2.2.3.2-1)

| Derivation path: TS 38.508-1 [4], table 4.7.1-26 | | | |
|--|---------------------------------|---------|-----------|
| Information Element | Value/Remark | Comment | Condition |
| NAS message container | Contents of Table 9.2.2.2.3.3-3 | | |

Table 9.2.2.2.3.3-3: REGISTRATION REQUEST (Step 8, Table 9.2.2.2.3.2-1)

| Derivation path: TS 38.508-1 [4], table 4.7.1-6 using condition CIPHERED_MESSAGE | | | |
|--|--------------|---------|-----------|
| Information Element | Value/Remark | Comment | Condition |
| | | | |

9.2.3 Void

9.2.4 Generic UE configuration

9.2.4.1 Generic UE configuration update

9.2.4.1.1 Test Purpose (TP)

(1)

```
with { UE in 5GMM-REGISTERED state }
ensure that {
  when { UE receives a new 5G-GUTI in the CONFIGURATION UPDATE COMMAND message and acknowledgement
from the UE is requested }
  then { UE sends a CONFIGURATION UPDATE COMPLETE message and UE shall consider new 5G-GUTI as
valid }
}
```

(2)

```
with { UE in 5GMM-REGISTERED state }
ensure that {
  when { UE receives a NITZ information in the CONFIGURATION UPDATE COMMAND message and
acknowledgement from the UE is not requested }
  then { UE updates NITZ information }
}
```

(3)

```
with { UE in 5GMM-REGISTERED state }
ensure that {
  when { UE receives CONFIGURATION UPDATE COMMAND message indicating "registration requested" and
contains no other parameters }
  then { UE deletes any stored allowed NSSAI for this PLMN and then release the existing N1 NAS
signalling connection, starts a mobility registration procedure }
}
```

(4)

```
with { UE in 5GMM-REGISTERED state }
ensure that {
  when { UE receives a new allowed NSSAI in the CONFIGURATION UPDATE COMMAND message and
registration is not requested }
  then { UE replaces any stored allowed NSSAI for this PLMN with new allowed NSSAI }
}
```

9.2.4.1.2 Conformance requirements

References: The conformance requirements covered in the present TC are specified in: TS 24.501, clause 4.6.2.2, 5.4.4.1, 5.4.4.2 and 5.4.4.3. Unless otherwise stated these are Rel-15 requirements.

[TS 24.501 clause 4.6.2.2]

If available, the configured NSSAI(s) shall be stored in a non-volatile memory in the ME as specified in annex C.

...

If the UE receives the CONFIGURATION UPDATE COMMAND message indicating "registration requested" and contains no other parameters (see subclauses 5.4.4.2 and 5.4.4.3), the UE shall delete any stored allowed NSSAI for this PLMN, and delete any stored mapping of each S-NSSAI of the allowed NSSAI to the S-NSSAI(s) of the HPLMN, if available;

...

d) When the UE receives the Network slicing indication IE with the Network slicing subscription change indication set to "Network slicing subscription changed" in the REGISTRATION ACCEPT message or in the

CONFIGURATION UPDATE COMMAND message, the UE shall delete the network slicing information for each of the PLMNs that the UE has slicing information stored for (excluding the current PLMN). The UE shall not delete the default configured NSSAI. Additionally, the UE shall update the network slicing information for the current PLMN (if received) as specified above in bullets a), b) and c):

[TS 24.501 clause 5.4.4.1]

The purpose of this procedure is to:

- a) allow the AMF to update the UE configuration for access and mobility management-related parameters decided and provided by the AMF by providing new parameter information within the command; or
- b) request the UE to perform a registration procedure for mobility and periodic registration update towards the network to update access and mobility management-related parameters decided and provided by the AMF (see subclause 5.5.1.3).

This procedure is initiated by the network and can only be used when the UE has an established 5GMM context, and the UE is in 5GMM-CONNECTED mode. When the UE is in 5GMM-IDLE mode, the AMF may use the paging or notification procedure to initiate the generic UE configuration update procedure. The AMF can request a confirmation response in order to ensure that the parameter has been updated by the UE.

This procedure shall be initiated by the network to assign a new 5G-GUTI to the UE after a successful service request procedure invoked as a response to a paging request from the network and before the release of the N1 NAS signalling connection. If the service request procedure was triggered due to 5GSM downlink signalling pending, the procedure for assigning a new 5G-GUTI can be initiated by the network after the transport of the 5GSM downlink signalling.

The following parameters are supported by the generic UE configuration update procedure without the need to request the UE to perform the registration procedure for mobility and periodic registration update:

- a) 5G-GUTI;
- b) TAI list;
- c) Service area list;
- d) Network identity and time zone information (Full name for network, short name for network, local time zone, universal time and local time zone, network daylight saving time);
- e) LADN information;
- f) Rejected NSSAI;r
- g) Network slicing indication;
- h) Operator-defined access category definitions; and
- i) SMS indication.

The following parameters can be sent to the UE with or without a request to perform the registration procedure for mobility and periodic registration update:

- a) Allowed NSSAI; or
- b) Configured NSSAI.

The following parameter is sent to the UE with a request to perform the registration procedure for mobility and periodic registration update:

- a) MICO indication.

The following parameters are sent over 3GPP access only:

- a) LADN information;
- b) MICO indication;
- c) TAI list; and

- d) Service area list.

The following parameters are managed and sent per access type i.e., independently over 3GPP access or non 3GPP access:

- a) Allowed NSSAI; and
b) Rejected NSSAI (when the NSSAI is rejected for the current registration area).

The following parameters are managed commonly and sent over 3GPP access or non 3GPP access:

- a) 5G-GUTI;
b) Network identity and time zone information;
c) Rejected NSSAI (when the NSSAI is rejected for the current PLMN);
d) Configured NSSAI; and
e) SMS indication.

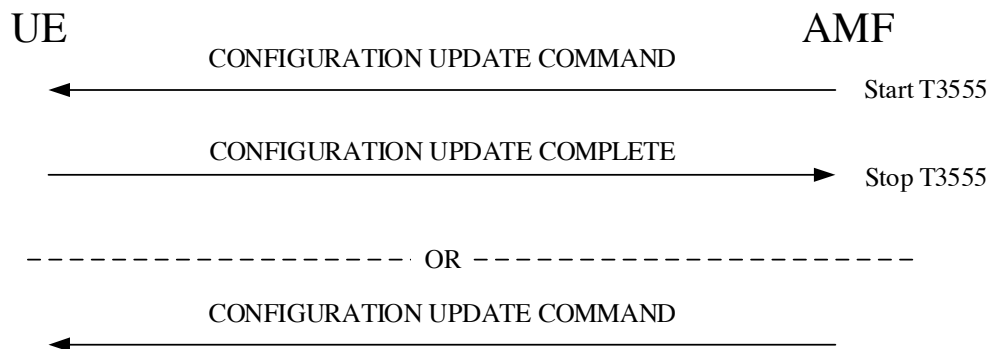

Figure 5.4.4.1.1: Generic UE configuration update procedure

[TS 24.501 clause 5.4.4.2]

The AMF shall initiate the generic UE configuration update procedure by sending the CONFIGURATION UPDATE COMMAND message to the UE.

The AMF shall in the CONFIGURATION UPDATE COMMAND message either:

- a) include one or more of the following parameters: 5G-GUTI, TAI list, allowed NSSAI that may include the mapped S-NSSAI(s), LADN information, service area list, MICO indication NITZ information, configured NSSAI that may include the mapped S-NSSAI(s), rejected NSSAI, network slicing indication, operator-defined access category definitions or SMS indication;
b) include the Configuration update indication IE with the Registration requested bit set to "registration requested";
or
c) include a combination of both a) and b).

If an acknowledgement from the UE is requested, the AMF shall indicate "acknowledgement requested" in the Acknowledgement bit of the Configuration update indication IE in the CONFIGURATION UPDATE COMMAND message and shall start timer T3555. Acknowledgement shall be requested for all parameters except when only NITZ is included.

To initiate parameter re-negotiation between the UE and network, the AMF shall indicate "registration requested" in the Registration requested bit of the Configuration update indication IE in the CONFIGURATION UPDATE COMMAND message.

If a new allowed NSSAI information or AMF re-configuration of supported S-NSSAIs requires an AMF relocation, the AMF shall indicate "registration requested" in the Registration requested bit of the Configuration update indication IE and include the Allowed NSSAI IE in the CONFIGURATION UPDATE COMMAND message.

If the AMF includes a new configured NSSAI in the CONFIGURATION UPDATE COMMAND message and the new configured NSSAI requires an AMF relocation as specified in 3GPP TS 23.501 [8], the AMF shall indicate "registration requested" in the Registration requested bit of the Configuration update indication IE in the message.

If the AMF indicates "registration requested" in the Registration requested bit of the Configuration update indication IE, acknowledgement shall be requested.

If changes to the allowed NSSAI require the UE to initiate a registration procedure, but the AMF is unable to determine an allowed NSSAI for the UE as specified in 3GPP TS 23.501 [8], the CONFIGURATION UPDATE COMMAND message shall indicate "registration requested" in the Registration requested bit of the Configuration update indication IE, and shall not contain any other parameters.

If the AMF needs to update the LADN information, the AMF shall include the LADN information in the LADN information IE of the CONFIGURATION UPDATE COMMAND message.

During an established 5GMM context, the network may send none, one, or more CONFIGURATION UPDATE COMMAND messages to the UE. If more than one CONFIGURATION UPDATE COMMAND message is sent, the messages need not have the same content.

[TS 24.501 clause 5.4.4.3]

Upon receiving the CONFIGURATION UPDATE COMMAND message, the UE shall stop timer T3346 if running and use the contents to update appropriate information stored within the UE.

If "acknowledgement requested" is indicated in the Acknowledgement bit of the Configuration update indication IE in the CONFIGURATION UPDATE COMMAND message, the UE shall send a CONFIGURATION UPDATE COMPLETE message.

If the UE receives a new 5G-GUTI in the CONFIGURATION UPDATE COMMAND message, the UE shall consider the new 5G-GUTI as valid, the old 5G-GUTI as invalid, stop timer T3519 if running, and delete any stored SUCI; otherwise, the UE shall consider the old 5G-GUTI as valid. The UE shall provide the 5G-GUTI to the lower layer of 3GPP access if the CONFIGURATION UPDATE COMMAND message is sent over the non-3GPP access, and the UE is in 5GMM-REGISTERED in both 3GPP access and non-3GPP access in the same PLMN.

If the UE receives a new TAI list in the CONFIGURATION UPDATE COMMAND message, the UE shall consider the new TAI list as valid and the old TAI list as invalid; otherwise, the UE shall consider the old TAI list as valid.

If the UE receives a new service area list in the CONFIGURATION UPDATE COMMAND message, the UE shall consider the new service area list as valid and the old service area list as invalid; otherwise, the UE shall consider the old service area list, if any, as valid.

If the UE receives new NITZ information in the CONFIGURATION UPDATE COMMAND message, the UE considers the new NITZ information as valid and the old NITZ information as invalid; otherwise, the UE shall consider the old NITZ information as valid.

If the UE receives a LADN information IE in the CONFIGURATION UPDATE COMMAND message, the UE shall consider the old LADN information as invalid and the new LADN information as valid, if any; otherwise, the UE shall consider the old LADN information as valid.

If the UE receives a new allowed NSSAI for the associated access type in the CONFIGURATION UPDATE COMMAND message, the UE shall consider the new allowed NSSAI as valid for the associated access type, store the allowed NSSAI for the associated access type as specified in subclause 4.6.2.2 and consider the old allowed NSSAI for the associated access type as invalid; otherwise, the UE shall consider the old Allowed NSSAI as valid for the associated access type.

If the UE receives a new configured NSSAI in the CONFIGURATION UPDATE COMMAND message, the UE shall consider the new configured NSSAI for the registered PLMN as valid and the old configured NSSAI for the registered PLMN as invalid; otherwise, the UE shall consider the old configured NSSAI for the registered PLMN as valid. The UE shall store the new configured NSSAI as specified in subclause 4.6.2.2.

If the UE receives the Network slicing indication IE in the CONFIGURATION UPDATE COMMAND message with the Network slicing subscription change indication set to "Network slicing subscription changed", the UE shall delete the network slicing information for each and every PLMN except for the current PLMN as specified in subclause 4.6.2.2.

If the UE receives Operator-defined access category definitions IE in the CONFIGURATION UPDATE COMMAND message and the Operator-defined access category definitions IE contains one or more operator-defined access category definitions, the UE shall delete any operator-defined access category definitions stored for the RPLMN and shall store the received operator-defined access category definitions for the RPLMN. If the UE receives the Operator-defined access category definitions IE in the CONFIGURATION UPDATE COMMAND message and the Operator-defined access category definitions IE contains no operator-defined access category definitions, the UE shall delete any operator-defined access category definitions stored for the RPLMN. If the CONFIGURATION UPDATE COMMAND message does not contain the Operator-defined access category definitions IE, the UE shall not delete the operator-defined access category definitions stored for the RPLMN.

If the UE receives the SMS indication IE in the CONFIGURATION UPDATE COMMAND message with the SMS availability indication set to:

- a) "SMS over NAS not available", the UE shall consider that SMS over NAS transport is not allowed by the network; and
- b) "SMS over NAS available", the UE may request the use of SMS over NAS transport by performing a registration procedure for mobility and periodic registration update as specified in subclause 5.5.1.3, after the completion of the generic UE configuration update procedure.

If the CONFIGURATION UPDATE COMMAND message indicates "registration requested" in the Registration requested bit of the Configuration update indication IE and:

- a) contains no other parameters or contains at least one of the following parameters: a new allowed NSSAI, a new configured NSSAI or the Network slicing subscription change indication, and:
 - 1) an emergency PDU session exists, the UE shall, after the completion of the generic UE configuration update procedure and the release of the emergency PDU session, release the existing N1 NAS signalling connection, and start a registration procedure for mobility and periodic registration update as specified in subclause 5.5.1.3; or
 - 2) no emergency PDU Session exists, the UE shall, after the completion of the generic UE configuration update procedure and the release of the existing N1 NAS signalling connection, start a registration procedure for mobility and periodic registration update as specified in subclause 5.5.1.3; or
- b) an MICO indication is included without a new allowed NSSAI or a new configured NSSAI, the UE shall, after the completion of the generic UE configuration update procedure, start a registration procedure for mobility and registration update as specified in subclause 5.5.1.3 to re-negotiate MICO mode with the network.

The UE receiving the rejected NSSAI in the CONFIGURATION UPDATE COMMAND message takes the following actions based on the rejection cause in the rejected NSSAI:

"S-NSSAI not available in the current PLMN"

The UE shall add the rejected S-NSSAI(s) in the rejected NSSAI for the current PLMN as specified in subclause 4.6.2.2 and not attempt to use this S-NSSAI in the current PLMN until switching off the UE or the UICC containing the USIM is removed.

"S-NSSAI not available in the current registration area"

The UE shall add the rejected S-NSSAI(s) in the rejected NSSAI for the current registration area as specified in subclause 4.6.2.2 and not attempt to use this S-NSSAI in the current registration area until switching off the UE, the UE moving out of the current registration area or the UICC containing the USIM is removed.

9.2.4.1.3 Test description

9.2.4.1.3.1 Pre-test conditions

System Simulator:

- WLAN Cell 27

UE:

- None.

Preamble:

- The UE is in state 3W-A on WLAN Cell 27 according to TS 38.508-1 [4].

9.2.4.1.3.2 Test procedure sequence

Table 9.2.4.1.3.2-1: Main behaviour

| St | Procedure | Message Sequence | | TP | Verdict |
|-----------|---|------------------|-------------------------------|----|---------|
| | | U - S | Message | | |
| 1 | The SS transmits a CONFIGURATION UPDATE COMMAND message including a new 5G-GUTI. | <-- | CONFIGURATION UPDATE COMMAND | - | - |
| 2 | Check: Does UE transmit a CONFIGURATION UPDATE COMPLETE message? | --> | CONFIGURATION UPDATE COMPLETE | 1 | P |
| 3 | The SS transmits an IDENTITY REQUEST requesting 5G-GUTI in the IE identity type | <-- | IDENTITY REQUEST | - | - |
| 4 | Check: Does the UE respond with an IDENTITY RESPONSE message with including the new 5G-GUTI assigned in step 1 in the 5GS mobile identity IE? | --> | IDENTITY RESPONSE | 1 | P |
| 5 | The SS transmits a CONFIGURATION UPDATE COMMAND message including NITZ information. | <-- | CONFIGURATION UPDATE COMMAND | - | - |
| 6 | Check: Does the UE transmit a CONFIGURATION UPDATE COMPLETE message within the expiry of T3555? | --> | CONFIGURATION UPDATE COMPLETE | 2 | F |
| 7 | Check: Using MMI/AT command verify the NITZ update on the UE. | - | - | 2 | P |
| 8 | Switch off procedure in Ipsec_SA_Established specified in TS 38.508-1 [4] subclause 4.9.6.5 is performed. | - | - | - | - |
| 9 | The UE is switched On. | - | - | - | - |
| 10-16 | Steps 1 to 7 of the generic procedure for WLAN Ipsec_SA_Released specified in TS 38.508-1 [4] subclause 4.5.2 are performed. | - | - | - | - |
| 17 | The SS transmits a REGISTRATION ACCEPT message including Configured NSSAI. | <-- | REGISTRATION ACCEPT | - | - |
| 17A - 17B | Steps 9 to 10 of the generic procedure for WLAN Ipsec_SA_Released specified in TS 38.508-1 [4] subclause 4.5.2 are performed. | - | - | - | - |
| 18 | The SS transmits a CONFIGURATION UPDATE COMMAND message including registration requested IE. | <-- | CONFIGURATION UPDATE COMMAND | - | - |
| 19 | The UE transmits a CONFIGURATION UPDATE COMPLETE message. | --> | CONFIGURATION UPDATE COMPLETE | - | - |
| 19A | The generic procedure for SS-requested IPsec Secure tunnel disconnection, specified in subclause 4.5A.3 of TS 38.508-1 [4], takes place performing disconnection of security association. | - | - | - | - |
| 20 | Check: Does UE transmit a REGISTRATION REQUEST message with registration type value set to "Mobility" and including the Requested NSSAI? | --> | REGISTRATION REQUEST | 3 | P |
| 21-25 | Void | - | - | - | - |
| 26 | The SS transmits a REGISTRATION ACCEPT message including Allowed NSSAI. | <-- | REGISTRATION ACCEPT | - | - |
| 27 | The UE transmits a REGISTRATION COMPLETE message. | - | REGISTRATION COMPLETE | - | - |
| 27A | The generic procedure for SS-requested IPsec Secure tunnel disconnection, specified in subclause 4.5A.3 of TS 38.508-1 [4], takes place performing disconnection of security association. | - | - | - | - |
| 28 | Check: Using MMI/AT command (+C5GNSSAIRDP) verify the update of | - | - | 3 | P |

| | | | | | |
|----------|---|-----|-------------------------------|---|---|
| | allowed NSSAI. | | | | |
| 28A
- | Steps 1 to 2 of the generic procedure for WLAN IPsec_SA_Established specified in TS 38.508-1 [4] subclause 4.5.4.2-4 are performed. | - | - | - | - |
| 28B | | | | | |
| 29 | The SS transmits a CONFIGURATION UPDATE COMMAND message including a new allowed NSSAI list. | <-- | CONFIGURATION UPDATE COMMAND | - | - |
| 30 | The UE transmits a CONFIGURATION UPDATE COMPLETE message. | --> | CONFIGURATION UPDATE COMPLETE | - | - |
| 31 | Check: Using MMI/AT command (+C5GNSSAIRDP) verify the update of allowed NSSAI. | - | - | 4 | P |

9.2.4.1.3.3 Specific message contents

Table 9.2.4.1.3.3-1: CONFIGURATION UPDATE COMMAND (step 1, Table 9.2.4.1.3.2-1)

| Derivation path: TS 38.508-1 [4], Table 4.7.1-19 | | | |
|--|------------------------------|---------------------------------|-----------|
| Information Element | Value/remark | Comment | Condition |
| Configuration update indication | 0001 | Acknowledgement (ACK) requested | |
| 5G-GUTI | Other than the default value | | |

Table 9.2.4.1.3.3-2: IDENTITY REQUEST (step 3, Table 9.2.4.1.3.2-1)

| Derivation Path: TS 38.508-1 [4], Table 4.7.1-21 | | | |
|--|--------------|---------|-----------|
| Information Element | Value/remark | Comment | Condition |
| Identity type | '010'B | 5G-GUTI | |

Table 9.2.4.1.3.3-3: IDENTITY RESPONSE (step 4, Table 9.2.4.1.3.2-1)

| Derivation Path: TS 38.508-1 [4], Table 4.7.1-22 | | | |
|--|----------------------------|---------|-----------|
| Information Element | Value/remark | Comment | Condition |
| mobile identity IE | 5G-GUTI assigned in step 1 | 5G-GUTI | |

Table 9.2.4.1.3.3-4: CONFIGURATION UPDATE COMMAND (step 5, Table 9.2.4.1.3.2-1)

| Derivation path: TS 38.508-1 [4], Table 4.7.1-19 | | | |
|--|--------------|---------|-----------|
| Information Element | Value/remark | Comment | Condition |
| Full name for network | Present | | |
| Universal time and local time zone | Present | | |

Table 9.2.4.1.3.3-5: REGISTRATION ACCEPT (step 17, Table 9.2.4.1.3.2-1)

| Derivation path: TS 38.508-1 [4], Table 4.7.1-7 | | | |
|---|--------------|-----------------|-----------|
| Information Element | Value/remark | Comment | Condition |
| 5GS registration result value | '010'B | Non-3GPP access | |
| Configured NSSAI | | | |
| S-NSSAI IEI | | S-NSSAI value 2 | |
| Length of S-NSSAI contents | '00000001'B | SST | |
| SST | '00000001'B | 2 | |
| SD | Not Present | | |
| Mapped configured SST | Not Present | | |
| Mapped configured SD | Not Present | | |
| S-NSSAI IEI | | S-NSSAI value 3 | |
| Length of S-NSSAI contents | '00000001'B | SST | |
| SST | '00000010'B | 3 | |
| SD | Not Present | | |
| Mapped configured SST | Not Present | | |
| Mapped configured SD | Not Present | | |

Table 9.2.4.1.3.3-6: CONFIGURATION UPDATE COMMAND (step 18, Table 9.2.4.1.3.2-1)

| Derivation path: TS 38.508-1 [4], Table 4.7.1-19 | | | |
|--|--------------|------------------------|-----------|
| Information Element | Value/remark | Comment | Condition |
| Configuration update indication | 0010 | Registration requested | |

Table 9.2.4.1.3.3-7: REGISTRATION REQUEST (step 33, Table 9.2.4.1.3.2-1)

| Derivation path: TS 38.508-1 [4], Table 4.7.1-6 | | | |
|---|--------------|-----------------|-----------|
| Information Element | Value/remark | Comment | Condition |
| 5GS registration type value | '010'B | | MOBILITY |
| Requested NSSAI | | | |
| S-NSSAI IEI | | S-NSSAI value 2 | |
| Length of S-NSSAI contents | '00000001'B | SST | |
| SST | '00000010'B | 2 | |
| SD | Not Present | | |
| Mapped configured SST | Not Present | | |
| Mapped configured SD | Not Present | | |
| S-NSSAI IEI | | S-NSSAI value 3 | |
| Length of S-NSSAI contents | '00000001'B | SST | |
| SST | '00000011'B | 3 | |
| SD | Not Present | | |
| Mapped configured SST | Not Present | | |
| Mapped configured SD | Not Present | | |

Table 9.2.4.1.3.3-8: REGISTRATION ACCEPT (step 20, Table 9.2.4.1.3.2-1)

| Derivation path: TS 38.508-1 [4], Table 4.7.1-7 | | | |
|---|--------------|-----------------|-----------|
| Information Element | Value/remark | Comment | Condition |
| 5GS registration result value | '010'B | Non-3GPP access | |
| Allowed NSSAI | | | |
| S-NSSAI IEI | | S-NSSAI value 1 | |
| Length of S-NSSAI contents | '00000001'B | SST | |
| SST | '00000001'B | 1 | |
| SD | Not Present | | |
| Mapped configured SST | Not Present | | |
| Mapped configured SD | Not Present | | |
| S-NSSAI IEI | | S-NSSAI value 2 | |
| Length of S-NSSAI contents | '00000001'B | SST | |
| SST | '00000010'B | 2 | |
| SD | Not Present | | |
| Mapped configured SST | Not Present | | |
| Mapped configured SD | Not Present | | |
| S-NSSAI IEI | | S-NSSAI value 3 | |
| Length of S-NSSAI contents | '00000001'B | SST | |
| SST | '00000011'B | 3 | |
| SD | Not Present | | |
| Mapped configured SST | Not Present | | |
| Mapped configured SD | Not Present | | |

Table 9.2.4.1.3.3-9: CONFIGURATION UPDATE COMMAND (step 30, Table 9.2.4.1.3.2-1)

| Derivation path: TS 38.508-1 [4], Table 4.7.1-19 | | | |
|--|--------------|---------------------------------|-----------|
| Information Element | Value/remark | Comment | Condition |
| Configuration update indication | 0001 | Acknowledgement (ACK) requested | |
| Allowed NSSAI | | | |
| S-NSSAI IEI | | S-NSSAI value 1 | |
| Length of S-NSSAI contents | '00000001'B | SST | |
| SST | '00000001'B | 1 | |
| SD | Not Present | | |
| Mapped configured SST | Not Present | | |
| Mapped configured SD | Not Present | | |
| S-NSSAI IEI | | S-NSSAI value 2 | |
| Length of S-NSSAI contents | '00000001'B | SST | |
| SST | '00000010'B | 2 | |
| SD | Not Present | | |
| Mapped configured SST | Not Present | | |
| Mapped configured SD | Not Present | | |

9.2.5 Registration

9.2.5.1 Initial Registration

9.2.5.1.1 Initial registration / Success / 5G-GUTI reallocation, Last visited TAI

9.2.5.1.1.1 Test Purpose (TP)

(1)

```

with { the UE has no valid 5G-GUTI but available SUCI and switched off }
ensure that {
  when { the UE is switched on }
  then { the UE sends a REGISTRATION REQUEST message including the SUCI in the 5GS mobile identity IE }
}

```

(2)

```

with { the UE is 5GMM-REGISTERED state with assigned 5G-GUTI and last visited registered TAI and
switched off }
ensure that {
  when { the UE is switched on }
    then { the UE sends a REGISTRATION REQUEST message including the 5G-GUTI assigned previously in
the 5GS mobile identity IE and the last visited registered TAI }
}

```

9.2.5.1.1.2 Conformance requirements

References: The conformance requirements covered in the current TC are specified in: TS 24.501 clauses 5.5.1.2.2 and 5.5.1.2.4. Unless otherwise stated these are Rel-15 requirements.

[TS 24.501, clause 5.5.1.2.2]

The UE initiates the registration procedure for initial registration by sending a REGISTRATION REQUEST message to the AMF, starting timer T3510. If timer T3502 is currently running, the UE shall stop timer T3502. If timer T3511 is currently running, the UE shall stop timer T3511.

During initial registration the UE handles the 5GS mobile identity IE in the following order:

...

- b) if the UE holds a valid 5G-GUTI that was previously assigned, over 3GPP access or non-3GPP access, by the same PLMN with which the UE is performing the registration, the UE shall indicate the 5G-GUTI in the 5GS mobile identity IE;
- c) if the UE holds a valid 5G-GUTI that was previously assigned, over 3GPP access or non-3GPP access, by an equivalent PLMN, the UE shall indicate the 5G-GUTI in the 5GS mobile identity IE;
- d) if the UE holds a valid 5G-GUTI that was previously assigned, over 3GPP access or non-3GPP, by any other PLMN, the UE shall indicate the 5G-GUTI in the 5GS mobile identity IE;
- e) if a SUCI is available the UE shall include the SUCI in the 5GS mobile identity IE; and

If the SUCI is included in the 5GS mobile identity IE and the timer T3519 is not running, the UE shall start timer T3519 and store the value of the SUCI sent in the REGISTRATION REQUEST message. The UE shall include the stored SUCI in the REGISTRATION REQUEST message while timer T3519 is running.

...

If the last visited registered TAI is available, the UE shall include the last visited registered TAI in the REGISTRATION REQUEST message.

[TS 24.501, clause 5.5.1.2.4]

The 5G-GUTI reallocation shall be part of the initial registration procedure. During the initial registration procedure, if the AMF has not allocated a new 5G-GUTI by the generic UE configuration update procedure, the AMF shall include in the REGISTRATION ACCEPT message the new assigned 5G-GUTI together with the assigned TAI list.

9.2.5.1.1.3 Test description

9.2.5.1.1.3.1 Pre-test conditions

System Simulator:

- WLAN Cell 27

UE:

- None.

Preamble:

- The UE is in state Switched OFF (state 0W-B) according to TS 38.508-1 [4].

9.2.5.1.1.3.2 Test procedure sequence

Table 9.2.5.1.1.3.2-1: Main behaviour

| St | Procedure | Message Sequence | | TP | Verdict |
|-------|---|------------------|---------------------|----|---------|
| | | U – S | Message | | |
| 1 | The UE is switched on. | - | - | - | - |
| 2-8 | UE establishes an IPSEC SA and trigger 5GMM Registration procedure by executing steps 1 to 7 of Table 4.5.2.2-3 in TS38.508-1 [4]. | - | - | - | - |
| 9 | SS transmits an REGISTRATION REJECT message with the 5GMM cause IE setting as "Illegal ME".
NOTE1: 5G-GUTI-1 should be deleted, then UE has no valid 5G-GUTI but available SUCI now. | <- | REGISTRATION REJECT | - | - |
| 10 | The generic procedure for SS-requested IPsec Secure tunnel disconnection, specified in subclause 4.5A.3 of TS 38.508-1 [4], takes place performing disconnection of security association. | - | - | - | - |
| 11 | If possible (see ICS) switch off is performed or the USIM is removed.
Otherwise the power is removed. | - | - | - | - |
| 12 | The UE is brought back to operation or the USIM is inserted. | - | - | - | - |
| 13-23 | Steps 1-11 of Table 4.5.2.2-2 of the generic procedure in TS 38.508-1 [4] are performed | - | - | 1 | P |
| 24 | If possible (see ICS) switch off is performed or the USIM is removed.
Otherwise the power is removed. | - | - | - | - |
| 25 | The UE is brought back to operation or the USIM is inserted. | - | - | - | - |
| 26-35 | Steps 1-11 of Table 4.5.2.2-2 of the generic procedure in TS 38.508-1 [4] are performed | - | - | 2 | P |

9.2.5.1.1.3.3 Specific message contents

Table 9.2.5.1.1.3.3-1: Message REGISTRATION REJECT (step 9, Table 9.2.5.1.1.3.2-1)

| Derivation path: TS 38.508-1 [4], table 4.7.1-9 | | | |
|---|--------------|------------|-----------|
| Information Element | Value/Remark | Comment | Condition |
| 5GMM cause | '0000 0011'B | Illegal UE | |

Table 9.2.5.1.1.3.3-2: Message REGISTRATION REQUEST (step 15, Table 9.2.5.1.1.3.2-1)

| Derivation path: TS 38.508-1 [4], table 4.7.1-6 | | | |
|---|--------------|----------------------|-----------|
| Information Element | Value/Remark | Comment | Condition |
| 5GS registration type | '0000 0001'B | Initial registration | |
| 5GS mobile identity | SUCI | The SUCI of UE | |

Table 9.2.5.1.1.3.3-3: Message REGISTRATION ACCEPT (step 21, Table 9.2.5.1.1.3.2-1)

| Derivation path: TS 38.508-1 [4], table 4.7.1-7 | | | |
|---|--------------|---------|-----------|
| Information Element | Value/Remark | Comment | Condition |
| 5G-GUTI | 5G-GUTI-2 | | |

Table 9.2.5.1.1.3.3-4: Message REGISTRATION REQUEST (step 34, Table9.2.5.1.1.3.2-1)

| Derivation path: TS 38.508-1 [4], table 4.7.1-6 | | | |
|---|--------------|----------------------|-----------|
| Information Element | Value/Remark | Comment | Condition |
| 5GS registration type | '0000 0001'B | Initial registration | |
| 5GS mobile identity | 5G-GUTI-2 | | |
| Last visited registered TAI | TAI-1 | N3GPP TAI | |

9.2.5.1.2 Initial registration / 5GS services / NSSAI handling

9.2.5.1.2.1 Test Purpose (TP)

(1)

```
with { UE has sent a REGISTRATION REQUEST message including requested NSSAI}
ensure that {
  when { UE receives REGISTRATION ACCEPT message with allowed NSSAI }
  then { UE shall replace any stored allowed NSSAI for the current PLMN with new allowed NSSAI for
the current PLMN }
}
```

(2)

```
with { UE has sent a REGISTRATION REQUEST message including Requested NSSAI}
ensure that {
  when { UE receives REGISTRATION ACCEPT message with Rejected NSSAI with reject cause "S-NSSAI not
available in the current PLMN" }
  then { UE shall add the rejected S-NSSAI(s) in the rejected NSSAI for the current PLMN and not
attempt to use the Rejected NSSAI in the current PLMN until switching off the UE or the UICC
containing the USIM is removed }
}
```

(3)

```
with { UE receives REGISTRATION ACCEPT message with Rejected NSSAI with reject cause "S-NSSAI not
available in the current PLMN" }
ensure that {
  when { UE has been switched off, then switched on }
  then { UE shall delete the stored Rejected NSSAI and shall send the NSSAI in Requested NSSAI IE
of the REGISTRATION REQUEST message as per the configured and Allowed NSSAI for current PLMN }
}
```

(4)

```
with { UE has sent a REGISTRATION REQUEST message including Requested NSSAI}
ensure that {
  when { UE receives REGISTRATION ACCEPT message with Rejected NSSAI with reject cause "S-NSSAI not
available in the current registration area" }
  then { UE shall add the rejected S-NSSAI(s) in the rejected NSSAI for the current PLMN and
registration area combination and not attempt to use the Rejected NSSAI in the current registration
area until switching off the UE, the UE moving out of the current registration area or the UICC
containing the USIM is removed }
}
```

9.2.5.1.2.2 Conformance requirements

References: The conformance requirements covered in the present TC are specified in: TS 24.501, clause 5.5.1.2.2 and 5.5.1.2.4. Unless otherwise stated these are Rel-15 requirements.

[TS 24.501 clause 5.5.1.2.2]

5.5.1.2.1 General

This procedure can be used by a UE for initial registration for 5GS services.

...

The UE shall include the requested NSSAI containing the S-NSSAI(s) corresponding to the slice(s) to which the UE wants to register and shall include the mapping of the requested NSSAI which is the mapping of each S-NSSAI of the requested NSSAI to the S-NSSAI(s) of the HPLMN, if available, in the REGISTRATION REQUEST message. If the UE has allowed NSSAI or configured NSSAI for the current PLMN, the requested NSSAI shall be either:

- a) the configured NSSAI for the current PLMN, or a subset thereof as described below, if the UE has no allowed NSSAI for the current PLMN;
- b) the allowed NSSAI for the current PLMN, or a subset thereof as described below, if the UE has an allowed NSSAI for the current PLMN; or
- c) the allowed NSSAI for the current PLMN, or a subset thereof as described below, plus one or more S-NSSAIs from the configured NSSAI for which no corresponding S-NSSAI is present in the allowed NSSAI and those are neither in the rejected NSSAI for the current PLMN nor in the rejected NSSAI for the current PLMN and registration area combination.

If the UE has neither allowed NSSAI for the current PLMN nor configured NSSAI for the current PLMN and has a default configured NSSAI, the UE shall:

- a) include the S-NSSAI(s) in the Requested NSSAI IE of the REGISTRATION REQUEST message using the default configured NSSAI; and
- b) include the Network slicing indication IE with the Default configured NSSAI indication bit set to "Requested NSSAI created from default configured NSSAI" in the REGISTRATION REQUEST message.

If the UE has no allowed NSSAI for the current PLMN, no configured NSSAI for the current PLMN, and no default configured NSSAI, the UE shall not include a requested NSSAI in the REGISTRATION message.

The subset of configured NSSAI provided in the requested NSSAI consists of one or more S-NSSAIs in the configured NSSAI applicable to the current PLMN, if the S-NSSAI is neither in the rejected NSSAI for the current PLMN nor in the rejected NSSAI for the current PLMN and registration area combination.

The subset of allowed NSSAI provided in the requested NSSAI consists of one or more S-NSSAIs in the allowed NSSAI for the current PLMN.

NOTE 3: How the UE selects the subset of configured NSSAI or allowed NSSAI to be provided in the requested NSSAI is implementation.

NOTE 4: The number of S-NSSAI(s) included in the requested NSSAI cannot exceed eight.

[TS 24.501 clause 5.5.1.2.4]

The AMF shall include the allowed NSSAI for the current PLMN and shall include the mapping of each S-NSSAI of the allowed NSSAI to the S-NSSAI(s) of the HPLMN contained in the requested NSSAI from the UE if available, in the REGISTRATION ACCEPT message if the UE included the requested NSSAI in the REGISTRATION REQUEST message and the AMF allows one or more S-NSSAIs in the requested NSSAI. The AMF may also include rejected NSSAI in the REGISTRATION ACCEPT message. Rejected NSSAI contains S-NSSAI(s) which was included in the requested NSSAI but rejected by the network associated with rejection cause(s).

The AMF may include a new configured NSSAI for the current PLMN in the REGISTRATION ACCEPT message if:

- a) the REGISTRATION REQUEST message did not include the requested NSSAI;
- b) the REGISTRATION REQUEST message included the requested NSSAI containing an S-NSSAI that is not valid in the serving PLMN; or
- c) the REGISTRATION REQUEST message included the Network slicing indication IE with the Default configured NSSAI indication bit set to "Requested NSSAI created from default configured NSSAI".

If a new configured NSSAI for the current PLMN is included in the REGISTRATION ACCEPT message, the AMF shall also include the mapping of the configured NSSAI for the current PLMN the S-NSSAI(s) of the HPLMN if available in the REGISTRATION ACCEPT message. In this case the AMF shall start timer T3550 and enter state 5GMM-COMMON-PROCEDURE-INITIATED as described in subclause 5.1.3.2.3.3.

The AMF shall include the Network slicing indication IE with the Network slicing subscription change indication set to "Network slicing subscription changed" in the REGISTRATION ACCEPT message if the UDM has indicated that the

subscription data for network slicing has changed. In this case the AMF shall start timer T3550 and enter state 5GMM-COMMON-PROCEDURE-INITIATED as described in subclause 5.1.3.2.3.3.

The UE receiving the rejected NSSAI in the REGISTRATION ACCEPT message takes the following actions based on the rejection cause in the rejected NSSAI:

"S-NSSAI not available in the current PLMN"

The UE shall add the rejected S-NSSAI(s) in the rejected NSSAI for the current PLMN as specified in subclause 4.6.2.2 and not attempt to use this S-NSSAI in the current PLMN until switching off the UE or the UICC containing the USIM is removed.

"S-NSSAI not available in the current registration area"

The UE shall add the rejected S-NSSAI(s) in the rejected NSSAI for the current PLMN and registration area combination as specified in subclause 4.6.2.2 and not attempt to use this S-NSSAI in the current registration area until switching off the UE, the UE moving out of the current registration area or the UICC containing the USIM is removed.

If the UE did not include the requested NSSAI in the REGISTRATION REQUEST message or none of the requested NSSAI are present in the subscribed S-NSSAIs, and one or more subscribed S-NSSAIs (containing one or more S-NSSAIs each of which may be associated with a new S-NSSAI) marked as default are available, the AMF shall put the subscribed S-NSSAIs marked as default in the allowed NSSAI of the REGISTRATION ACCEPT message. The AMF shall determine a registration area such that all S-NSSAIs of the allowed NSSAI are available in the registration area.

9.2.5.1.2.3 Test description

9.2.5.1.2.3.1 Pre-test conditions

System Simulator:

- WLAN Cell 27

UE:

- UE is previously registered on WLAN Cell 27 using default message contents according to TS 38.508-1 [4];
- Empty URSP Configuration.

Preamble:

- The UE is in state Switched OFF (state 0W-B) according to TS 38.508-1 [4].

9.2.5.1.2.3.2 Test procedure sequence

Table 9.2.5.1.2.3.2-1: Main behaviour

| St | Procedure | Message Sequence | | TP | Verdict |
|-------|---|------------------|-----------------------|----|---------|
| | | U - S | Message | | |
| 1 | The UE is switched on. | - | - | - | - |
| - | Exception: The UE establishes an IPsec tunnel in parallel to 5GC registration steps 2 to 6 as per the IKEv2 protocol as defined in 3GPP TS 23.502 [33] clause 4.12.2.2 figure 4.12.2.2-1. | - | - | - | - |
| 2 | Check: Does UE transmit a REGISTRATION REQUEST message? | --> | REGISTRATION REQUEST | - | - |
| 3-6 | Steps 4 to 7 of the generic procedure for WLAN Ipsec_SA_Released specified in TS 38.508-1 subclause 4.5.2 are performed. | - | - | - | - |
| 7 | The SS transmits a REGISTRATION ACCEPT message including Allowed NSSAI and Configured NSSAI. | <-- | REGISTRATION ACCEPT | - | - |
| 8 | Step 10 of the generic procedure for WLAN Ipsec_SA_Released specified in TS 38.508-1 subclause 4.5.2 are performed. | - | - | - | - |
| 9 | Switch off procedure in WLAN Ipsec_SA_Established specified in TS 38.508-1 subclause 4.9.6.5 is performed. | - | - | - | - |
| 10 | The UE is brought back to operation or the USIM is inserted. | - | - | - | - |
| - | Exception: The UE establishes an IPsec tunnel in parallel to 5GC registration steps 11 to 15 as per the IKEv2 protocol as defined in 3GPP TS 23.502 [33] clause 4.12.2.2 figure 4.12.2.2-1. | - | - | - | - |
| 11 | Check: Does UE transmit a REGISTRATION REQUEST message including Requested NSSAI? | --> | REGISTRATION REQUEST | 1 | P |
| 12-15 | Steps 4 to 7 of the generic procedure for WLAN Ipsec_SA_Released specified in TS 38.508-1 subclause 4.5.2 are performed. | - | - | - | - |
| 16 | The SS transmits a REGISTRATION ACCEPT message including Allowed NSSAI and Rejected NSSAI. | <-- | REGISTRATION ACCEPT | - | - |
| 17 | Step 10 of the generic procedure for WLAN Ipsec_SA_Released specified in TS 38.508-1 subclause 4.5.2 are performed. | - | - | - | - |
| 18 | Switch off procedure in WLAN Ipsec_SA_Established specified in TS 38.508-1 subclause 4.9.6.5 is performed. | - | - | - | - |
| - | Exception: The UE establishes an IPsec tunnel in parallel to 5GC registration steps 19 to 23 as per the IKEv2 protocol as defined in 3GPP TS 23.502 [33] clause 4.12.2.2 figure 4.12.2.2-1. | - | - | - | - |
| 19 | Check: Does UE transmit a REGISTRATION REQUEST message including Requested NSSAI? | --> | REGISTRATION REQUEST | 2 | P |
| 20-23 | Steps 4 to 7 of the generic procedure for WLAN Ipsec_SA_Released specified in TS 38.508-1 subclause 4.5.2 are performed. | - | - | - | - |
| 24 | The SS transmits a REGISTRATION ACCEPT message including Allowed NSSAI. | <-- | REGISTRATION ACCEPT | - | - |
| 25 | The UE transmits a REGISTRATION COMPLETE message. | --> | REGISTRATION COMPLETE | - | - |
| 26 | Step 10 of the generic procedure for WLAN Ipsec_SA_Released specified in TS 38.508-1 subclause 4.5.2 are performed. | - | - | - | - |
| 27 | Check: Is S-NSSAI=2 in the Rejected NSSAI | - | - | 2 | P |

| | | | | | |
|-------|---|-----|-----------------------|---|---|
| | list with cause "S-NSSAI not available in the current PLMN" associated with current PLMN using AT/MMI? | | | | |
| 28 | Switch off procedure in WLAN Ipsec_SA_Established specified in TS 38.508-1 subclause 4.9.6.5 is performed. | - | - | - | - |
| 29 | The UE is brought back to operation or the USIM is inserted | - | - | - | - |
| - | Exception: The UE establishes an IPsec tunnel in parallel to 5GC registration steps 30 to 34 as per the IKEv2 protocol as defined in 3GPP TS 23.502 [33] clause 4.12.2.2 figure 4.12.2.2-1. | - | - | - | - |
| 30 | Check: Does UE transmit a REGISTRATION REQUEST message including Requested NSSAI? | --> | REGISTRATION REQUEST | 3 | P |
| 31-34 | Steps 4 to 7 of the generic procedure for WLAN Ipsec_SA_Released specified in TS 38.508-1 subclause 4.5.2 are performed. | - | - | - | - |
| 35 | The SS transmits a REGISTRATION ACCEPT message including Allowed NSSAI and Rejected NSSAI. | <-- | REGISTRATION ACCEPT | - | - |
| 36 | Step 10 of the generic procedure for WLAN Ipsec_SA_Released specified in TS 38.508-1 subclause 4.5.2 are performed. | - | - | - | - |
| 37 | Check: Is S-NSSAI=2 removed from the Rejected NSSAI list associated with current PLMN? | - | - | 3 | P |
| 37A | Check: Is S-NSSAI=1 in the Rejected NSSAI list with cause "S-NSSAI not available in the current registration area" associated with current PLMN and registration area combination using AT/MMI? | - | - | 4 | P |
| 38 | Switch off procedure in WLAN Ipsec_SA_Established specified in TS 38.508-1 subclause 4.9.6.5 is performed. | - | - | - | - |
| 39 | The UE is brought back to operation or the USIM is inserted | - | - | - | - |
| - | Exception: The UE establishes an IPsec tunnel in parallel to 5GC registration steps 40 to 44 as per the IKEv2 protocol as defined in 3GPP TS 23.502 [33] clause 4.12.2.2 figure 4.12.2.2-1. | - | - | - | - |
| 40 | Check: Does UE transmit a REGISTRATION REQUEST message including Requested NSSAI? | --> | REGISTRATION REQUEST | 4 | P |
| 41-44 | Steps 4 to 7 of the generic procedure for WLAN Ipsec_SA_Released specified in TS 38.508-1 subclause 4.5.2 are performed. | - | - | - | - |
| 45 | The SS transmits a REGISTRATION ACCEPT message including Allowed NSSAI. | <-- | REGISTRATION ACCEPT | - | - |
| 46 | The UE transmits a REGISTRATION COMPLETE message. | --> | REGISTRATION COMPLETE | - | - |
| 47 | Check: Is S-NSSAI=1 in the Rejected NSSAI list with cause "S-NSSAI not available in the current registration area" associated with current PLMN and registration area combination using AT/MMI? | - | - | 4 | P |

9.2.5.1.2.3.3 Specific message contents

Table 9.2.5.1.2.3.3-1: REGISTRATION REQUEST (step 2, Table 9.2.5.1.2.3.2-1)

| Derivation path: TS 38.508-1 Table 4.7.1-6 | | | |
|--|---|----------------------|-----------|
| Information Element | Value/remark | Comment | Condition |
| 5GS registration type value | '001'B | Initial registration | |
| Requested NSSAI | | Note | |
| S-NSSAI IEI | | S-NSSAI value 1 | Note |
| Length of S-NSSAI contents | '00000001'B | SST | |
| SST | '00000001'B | 1 | |
| SD | Not Present | | |
| Mapped configured SST | Not Present | | |
| Mapped configured SD | Not Present | | |
| Note: | S-NSSAI =1 will be always included from the allowed NSSAI list associated with PLMN of WLAN Cell 27 by the UE but may include other S-NSSAI from Configured NSSAI list associated with PLMN of NCG WLAN Cell 27 if configured in the UE. See TS 24.501 sub-clause 5.5.1.2.1 | | |

Table 9.2.5.1.2.3.3-2: REGISTRATION ACCEPT (step 7, Table 9.2.5.1.2.3.2-1)

| Derivation path: TS 38.508-1 Table 4.7.1-7 | | | |
|--|--------------|-----------------|-----------|
| Information Element | Value/remark | Comment | Condition |
| 5GS registration result value | '010'B | Non 3GPP access | |
| Allowed NSSAI | | | |
| S-NSSAI IEI | | S-NSSAI value 1 | |
| Length of S-NSSAI contents | '00000001'B | SST | |
| SST | '00000010'B | 2 | |
| SD | Not Present | | |
| Mapped configured SST | Not Present | | |
| Mapped configured SD | Not Present | | |
| Configured NSSAI | | | |
| S-NSSAI IEI | | S-NSSAI value 1 | |
| Length of S-NSSAI contents | '00000001'B | SST | |
| SST | '00000001'B | 1 | |
| SD | Not Present | | |
| Mapped configured SST | Not Present | | |
| Mapped configured SD | Not Present | | |
| S-NSSAI IEI | | S-NSSAI value 2 | |
| Length of S-NSSAI contents | '00000001'B | SST | |
| SST | '00000010'B | 2 | |
| SD | Not Present | | |
| Mapped configured SST | Not Present | | |
| Mapped configured SD | Not Present | | |

Table 9.2.5.1.2.3.3-3: PDU SESSION ESTABLISHMENT ACCEPT (step 10, Table 9.2.5.1.2.3.2-1)

| Derivation path: TS 38.508-1 clause 4.7.2-2 | | | |
|---|--------------|-------------|-----------|
| Information Element | Value/remark | Comment | Condition |
| S-NSSAI | | | |
| Length of S-NSSAI contents | '0000 0001'B | SST | |
| SST | '0000 0010'B | SST value 2 | |

Table 9.2.5.1.2.3.3-4: REGISTRATION REQUEST (step 11, Table 9.2.5.1.2.3.2-1)

| Derivation path: TS 38.508-1 Table 4.7.1-6 | | | |
|--|--|----------------------|-----------|
| Information Element | Value/remark | Comment | Condition |
| 5GS registration type value | '001'B | Initial registration | |
| Requested NSSAI | | Note | |
| S-NSSAI IEI | | S-NSSAI value 1 | |
| Length of S-NSSAI contents | '00000001'B | SST | |
| SST | '00000010'B | 2 | |
| SD | Not Present | | |
| Mapped configured SST | Not Present | | |
| Mapped configured SD | Not Present | | |
| S-NSSAI IEI | | S-NSSAI value 2 | Note |
| Length of S-NSSAI contents | '00000001'B | SST | |
| SST | '00000001'B | 1 | |
| SD | Not Present | | |
| Mapped configured SST | Not Present | | |
| Mapped configured SD | Not Present | | |
| Note: | S-NSSAI =2 will be always included by the UE from the allowed NSSAI list associated with PLMN of NCG WLAN Cell 27 but may include S-NSSAI =1 from Configured NSSAI list associated with PLMN of NCG WLAN Cell 27. See TS 24.501 sub-clause 5.5.1.2.1 | | |

Table 9.2.5.1.2.3.3-5: REGISTRATION ACCEPT (step 16, Table 9.2.5.1.2.3.2-1)

| Derivation path: TS 38.508-1 Table 4.7.1-7 | | | |
|--|--|---|-----------|
| Information Element | Value/remark | Comment | Condition |
| 5GS registration result value | '010'B | Non 3GPP access | |
| Allowed NSSAI | | Note | |
| S-NSSAI IEI | | S-NSSAI value 1 | Note |
| Length of S-NSSAI contents | '00000001'B | SST | |
| SST | '00000001'B | 1 | |
| SD | Not Present | | |
| Mapped configured SST | Not Present | | |
| Mapped configured SD | Not Present | | |
| Rejected NSSAI | | | |
| Rejected S-NSSAI-1 | | Rejected S-NSSAI value 1 | |
| Cause value | '0000'B | S-NSSAI not available in the current PLMN | |
| SST | '00000010'B | 2 | |
| SD | Not Present | | |
| Note: | If UE has requested only S-NSSAI =2 in step 22 and S-NSSAI =2 is added in the Rejected NSSAI list by the SS then AMF/SS can include default subscribed S-NSSAIs in the allowed NSSAI of REGISTRATION ACCEPT message, see TS 24.501 sub-clause 5.5.1.2.4. | | |

Table 9.2.5.1.2.3.3-6: REGISTRATION REQUEST (step 19, Table 9.2.5.1.2.3.2-1)

| Derivation path: TS 38.508-1 Table 4.7.1-6 | | | |
|--|--------------|----------------------|-----------|
| Information Element | Value/remark | Comment | Condition |
| 5GS registration type value | '001'B | Initial registration | |
| Requested NSSAI | | | |
| S-NSSAI IEI | | S-NSSAI value 1 | |
| Length of S-NSSAI contents | '00000001'B | SST | |
| SST | '00000001'B | 1 | |
| SD | Not Present | | |
| Mapped configured SST | Not Present | | |
| Mapped configured SD | Not Present | | |

Table 9.2.5.1.2.3.3-7: REGISTRATION ACCEPT (step 24, Table 9.2.5.1.2.3.2-1)

| Derivation path: TS 38.508-1 Table 4.7.1-7 | | | |
|--|--------------|-----------------|-----------|
| Information Element | Value/remark | Comment | Condition |
| 5GS registration result value | '010'B | Non 3GPP access | |
| Allowed NSSAI | | | |
| S-NSSAI IEI | | S-NSSAI value 1 | |
| Length of S-NSSAI contents | '00000001'B | SST | |
| SST | '00000001'B | 1 | |
| SD | Not Present | | |
| Mapped configured SST | Not Present | | |
| Mapped configured SD | Not Present | | |

Table 9.2.5.1.2.3.3-8: REGISTRATION REQUEST (step 30, Table 9.2.5.1.2.3.2-1)

| Derivation path: TS 38.508-1 Table 4.7.1-6 | | | |
|--|--|----------------------|-----------|
| Information Element | Value/remark | Comment | Condition |
| 5GS registration type value | '001'B | Initial registration | |
| Requested NSSAI | | Note | |
| S-NSSAI IEI | | S-NSSAI value 1 | Note |
| Length of S-NSSAI contents | '00000001'B | SST | |
| SST | '00000001'B | 1 | |
| SD | Not Present | | |
| Mapped configured SST | Not Present | | |
| Mapped configured SD | Not Present | | |
| S-NSSAI IEI | | S-NSSAI value 1 | |
| Length of S-NSSAI contents | '00000001'B | SST | |
| SST | '00000010'B | 2 | |
| SD | Not Present | | |
| Mapped configured SST | Not Present | | |
| Mapped configured SD | Not Present | | |
| Note: | S-NSSAI =1 will be always included by the UE from the allowed NSSAI list associated with PLMN of NCG Cell C but may include S-NSSAI =2 from Configured NSSAI list associated with PLMN of NCG Cell C. See TS 24.501 sub-clause 5.5.1.2.1 | | |

Table 9.2.5.1.2.3.3-9: REGISTRATION ACCEPT (step 35, Table 9.2.5.1.2.3.2-1)

| Derivation path: TS 38.508-1 Table 4.7.1-7 | | | |
|--|--|---|-----------|
| Information Element | Value/remark | Comment | Condition |
| 5GS registration result value | '010'B | Non 3GPP access | |
| TAI list | | | |
| Type of list | '01'B | list of TACs belonging to one PLMN, with consecutive TAC values | |
| Number of elements | '00001'B | 2 Elements | |
| TAC | PLMN =MCC/MNC stored in EF _{IMSI}
TAC 1 = 2 | TAI2, TAI 3 | |
| Allowed NSSAI | | | |
| S-NSSAI IEI | | S-NSSAI value 1 | |
| Length of S-NSSAI contents | '00000001'B | SST | |
| SST | '00000010'B | 2 | |
| SD | Not Present | | |
| Mapped configured SST | Not Present | | |
| Mapped configured SD | Not Present | | |
| Rejected NSSAI | | | |
| Rejected S-NSSAI-1 | | Rejected S-NSSAI value 1 | |
| Cause value | '0001'B | S-NSSAI not available in the current registration area | |
| SST | '00000001'B | 1 | |
| SD | Not Present | | |
| Note: | If UE has requested only S-NSSAI =1 in step 57 and S-NSSAI =1 is added in the Rejected NSSAI list by the SS then AMF/SS can include default subscribed S-NSSAIs in the allowed NSSAI of REGISTRATION ACCEPT message, see TS 24.501 sub-clause 5.5.1.2.4. | | |

Table 9.2.5.1.2.3.3-10: PDU SESSION ESTABLISHMENT ACCEPT (step 36, Table 9.2.5.1.2.3.2-1)

| Derivation path: TS 38.508-1 clause 4.7.2-2 | | | |
|---|--------------|-------------|-----------|
| Information Element | Value/remark | Comment | Condition |
| S-NSSAI | | | |
| Length of S-NSSAI contents | '0000 0001'B | SST | |
| SST | '0000 0010'B | SST value 2 | |

Table 9.2.5.1.2.3.3-11: REGISTRATION REQUEST (step 40, Table 9.2.5.1.2.3.2-1)

| Derivation path: TS 38.508-1 Table 4.7.1-6 | | | |
|--|--------------|----------------------|-----------|
| Information Element | Value/remark | Comment | Condition |
| 5GS registration type value | '001'B | initial registration | |
| Requested NSSAI | | Note | |
| S-NSSAI IEI | | S-NSSAI value 1 | |
| Length of S-NSSAI contents | '00000001'B | SST | |
| SST | '00000001'B | 2 | |
| SD | Not Present | | |
| Mapped configured SST | Not Present | | |
| Mapped configured SD | Not Present | | |

Table 9.2.5.1.2.3.3-12: REGISTRATION ACCEPT (step 45, Table 9.2.5.1.2.3.2-1)

| Derivation path: TS 38.508-1 Table 4.7.1-7 | | | |
|--|--------------|-----------------|-----------|
| Information Element | Value/remark | Comment | Condition |
| 5GS registration result value | '010'B | Non 3GPP access | |
| Allowed NSSAI | | | |
| S-NSSAI IEI | | S-NSSAI value 1 | |
| Length of S-NSSAI contents | '00000010'B | SST | |
| SST | '00000001'B | 2 | |
| SD | Not Present | | |
| Mapped configured SST | Not Present | | |
| Mapped configured SD | Not Present | | |

9.2.5.1.3 Void

9.2.5.1.4 Initial registration / Rejected / Congestion / Abnormal cases / T3346

9.2.5.1.4.1 Test Purpose (TP)

(1)

```
with { The UE has sent initial REGISTRAION REQUEST message }
ensure that {
  when { UE receives a REGISTRATION REJECT with cause #22 (Congestion) with T3346 included and the
  UE is NOT configured for High Priority Access }
  then { UE does not start the Initial registration until T3346 expires }
}
```

(2)

```
with { The UE has received initial REGISTRATION REJECT with T3346 included }
ensure that {
  when { upon expiry of T3346 }
  then { UE starts the Initial registration procedure }
}
```

(3)

```
with { The UE has received initial REGISTRATION REJECT with T3346 included }
ensure that {
  when { the timer T3346 is running and the UE needs to perform initial registration for emergency
  services }
  then { UE starts the Initial registration procedure }
}
```

9.2.5.1.4.2 Conformance requirements

References: The conformance requirements covered in the present TC are specified in: TS 24.501, clauses 5.5.1.2.5 and 5.5.1.2.7 and TS 24.301, clause 5.5.1.2.5. Unless otherwise stated these are Rel-15 requirements.

[TS 24.501, clause 5.5.1.2.5]

If the initial registration request cannot be accepted by the network, the AMF shall send a REGISTRATION REJECT message to the UE including an appropriate 5GMM cause value.

If the initial registration request is rejected due to general NAS level mobility management congestion control, the network shall set the 5GMM cause value to #22 "congestion" and assign a back-off timer T3346.

The UE shall take the following actions depending on the 5GMM cause value received in the REGISTRATION REJECT message.

#3 (Illegal UE); or

#6 (Illegal ME).

...

#22 (Congestion).

If the T3346 value IE is present in the REGISTRATION REJECT message and the value indicates that this timer is neither zero nor deactivated, the UE shall proceed as described below; otherwise it shall be considered as an abnormal case and the behaviour of the UE for this case is specified in subclause 5.5.1.2.7.

The UE shall abort the initial registration procedure, set the 5GS update status to 5U2 NOT UPDATED and enter state 5GMM-DEREGISTERED.ATTEMPTING-REGISTRATION.

The UE shall stop timer T3346 if it is running.

If the REGISTRATION REJECT message is integrity protected, the UE shall start timer T3346 with the value provided in the T3346 value IE.

If the REGISTRATION REJECT message is not integrity protected, the UE shall start timer T3346 with a random value from the default range specified in 3GPP TS 24.008 [12].

The UE stays in the current serving cell and applies the normal cell reselection process. The initial registration procedure is started if still needed when timer T3346 expires or is stopped.

If the UE is operating in single-registration mode, the UE shall handle the EMM parameters EMM state, EPS update status, and attach attempt counter as specified in 3GPP TS 24.301 [15] for the case when the EPS attach request procedure is rejected with the EMM cause with the same value.

...

Other values are considered as abnormal cases. The behaviour of the UE in those cases is specified in subclause 5.5.1.2.7.

[TS 24.501, clause 5.5.1.2.7]

The following abnormal cases can be identified:

- a) Timer T3346 is running.

The UE shall not start the registration procedure for initial registration unless:

- 1) the UE is a UE configured for high priority access in selected PLMN;
- 2) the UE needs to perform the registration procedure for initial registration for emergency services; or
- 3) the UE receives a DEREGISTRATION REQUEST message with the "re-registration required" indication.

The UE stays in the current serving cell and applies the normal cell reselection process.

NOTE 1: It is considered an abnormal case if the UE needs to initiate a registration procedure for initial registration while timer T3346 is running independent on whether timer T3346 was started due to an abnormal case or a non-successful case.

[TS 24.301, clause 5.5.1.2.5]

...

#22 (Congestion);

If the T3346 value IE is present in the ATTACH REJECT message and the value indicates that this timer is neither zero nor deactivated, the UE shall proceed as described below; otherwise it shall be considered as an abnormal case and the behaviour of the UE for this case is specified in subclause 5.5.1.2.6.

The UE shall abort the attach procedure, reset the attach attempt counter, set the EPS update status to EU2 NOT UPDATED and enter state EMM-DEREGISTERED.ATTEMPTING-TO-ATTACH.

The UE shall stop timer T3346 if it is running.

If the ATTACH REJECT message is integrity protected, the UE shall start timer T3346 with the value provided in the T3346 value IE.

If the ATTACH REJECT message is not integrity protected, the UE shall start timer T3346 with a random value from the default range specified in 3GPP TS 24.008 [13].

The UE stays in the current serving cell and applies the normal cell reselection process. The attach procedure is started if still needed when timer T3346 expires or is stopped.

If A/Gb mode or Iu mode is supported by the UE, the UE shall in addition handle the GMM parameters GMM state, GPRS update status and GPRS attach attempt counter as specified in 3GPP TS 24.008 [13] for the case when the normal attach procedure is rejected with the GMM cause with the same value.

If the UE is operating in single-registration mode, the UE shall in addition handle the 5GMM parameters as specified in 3GPP TS 24.501 [54] for the case when the initial registration procedure is rejected with the 5GMM cause with the same value.

...

9.2.5.1.4.3 Test description

9.2.5.1.4.3.1 Pre-test conditions

System Simulator:

- WLAN Cell 27

UE:

None.

Preamble:

- The UE is in state Switched OFF (State 0W-A as per TS 38.508-1 [4] Table 4.4A.2-0).

9.2.5.1.4.3.2 Test procedure sequence

Table 9.2.5.1.4.3.2-1: Main behaviour

| St | Procedure | Message Sequence | | TP | Verdict |
|-------|---|------------------|---------------------|----|---------|
| | | U - S | Message | | |
| 1 | UE is switched on. | - | - | - | - |
| 2-8 | Steps 1-7 of Table 4.5.2.2-3 of the generic procedure in TS 38.508-1 [4] are performed. | - | - | - | - |
| 9 | SS transmits a REGISTRATION REJECT message with cause #22 (Congestion) and T3346 set to 3 minutes. (Note 1) | <-- | REGISTRATION REJECT | - | - |
| 10 | The generic procedure for SS-requested IPsec Secure tunnel disconnection, specified in subclause 4.5A.3 of TS 38.508-1 [4], takes place performing disconnection of security association. | - | - | - | - |
| 11 | Check: Does the UE initiate IPsec secure tunnel as per 3GPP TS 24.502 [33] clause 7.3.2 within T3346 minutes of Step 9? (Note 1) | - | - | 1 | F |
| 12-18 | Steps 1-7 of Table 4.5.2.2-3 of the generic procedure in TS 38.508-1 [4] are performed. | - | - | 2 | P |
| 19 | SS transmits a REGISTRATION REJECT message with cause #22 (Congestion) and T3346 set to 3 minutes. (Note 1) | <-- | REGISTRATION REJECT | - | - |
| 20 | The generic procedure for SS-requested IPsec Secure tunnel disconnection, specified in subclause 4.5A.3 of TS 38.508-1 [4], takes place performing disconnection of security association. | - | - | - | - |
| 21 | The UE is made to establish an emergence PDU session. This can be done by an AT/MMI command | - | - | - | - |
| 22-32 | Steps 1-11 of Table 4.5.2.2-2 of the generic procedure in TS 38.508-1 [4] are performed, REGISTRATION REQUEST message with IE 5GS registration type set to "Initial registration" | - | - | 3 | P |

Note 1: T3346 is set to 3 minutes. This is checked for 3 minutes less tolerance.

9.2.5.1.4.3.3 Specific message contents

Table 9.2.5.1.4.3.3-1: REGISTRATION REJECT (steps 9, 19 Table 9.2.5.1.4.3.2-1)

| Derivation Path: TS 38.508-1 [4], Table 4.7.1-9 | | | |
|---|--------------|------------------------|-----------|
| Information Element | Value/remark | Comment | Condition |
| 5GMM cause | '0001 0110'B | Cause #22 (Congestion) | |
| T3346 Value | '00100011'B | 3 minutes | |

Table 9.2.5.1.4.3.3-2: REGISTRATION REQUEST (step 25 Table 9.2.5.1.4.3.2-1)

| Derivation Path: TS 38.508-1 [4], Table 4.7.1-6 | | | |
|---|--------------|----------------------|-----------|
| Information Element | Value/remark | Comment | Condition |
| 5GS registration type | | | |
| 5GS registration type value | '001'B | Initial registration | |

9.2.5.2 Mobility Registration

9.2.5.2.1 Mobility registration update / registered slice(s) change

9.2.5.2.1.1 Test Purpose (TP)

```
with { UE in state 5GMM-REGISTERED, and 5GMM-IDLE mode over non 3GPP access }
ensure that {
  when { UE needs to change the slice(s) currently registered to }
  then { UE initiates and successfully completes the registration procedure for mobility
registration update }
}
```

9.2.5.2.1.2 Conformance requirements

Same conformance requirements as in clause 9.1.5.2.6.2

9.2.5.2.1.3 Test description

9.2.5.2.1.3.1 Pre-test conditions

System Simulator:

WLAN Cell 27

UE:

-None

Preamble:

The UE is in state 3W-A with PDU session Active state according to TS 38.508-1 [4].

9.2.5.2.1.3.2 Test procedure sequence

Table 9.2.5.2.1.3.2-1: Main behaviour

| St | Procedure | Message Sequence | | TP | Verdict |
|--|---|------------------|-----------------------------|----|---------|
| | | U - S | Message | | |
| 1 | Make the UE change the slice(s) the UE is currently registered to.
(NOTE 1) | - | - | - | - |
| 2 | The UE transmits an REGISTRATION REQUEST message indicating "mobility registration updating". | --> | 5GMM: REGISTRATION REQUEST | 1 | P |
| 3 | SS sends a REGISTRATION ACCEPT message | <<-- | 5GMM: REGISTRATION ACCEPT | - | - |
| 4 | Check: Does the UE send a REGISTRATION COMPLETE? | --> | 5GMM: REGISTRATION COMPLETE | - | - |
| Note 1: This can be done by MMI or AT command
- If the AT command +C5GNSSAI is to be used then in accordance with its definition (TS 27.007 [40], clause 10.1.62) it would need to be run 2 times: once to delete the stored in the UE default NSSAI, and, second time to allocate a new one
- In the Preamble SS has sent one allowed S-NSSAI which the UE has accepted as the S-NSSAI it is registered to (see 38.508-1 [4], Table 4.7.1-7). A S-NSSAI different to that one needs to be selected. | | | | | |

9.2.5.2.1.3.3 Specific message contents

None.

NOTE: The UE is expected to request a new S-NSSAI in the REGISTRATION REQUEST message sent as part of step 2. However, due to this S-NSSAI being implementation dependent, there is no verification of the content of the REGISTRATION REQUEST message foreseen.

9.2.5.2.2 Mobility registration update/Change of SMS over NAS capability

9.2.5.2.2.1 Test Purpose (TP)

(1)

```
with { UE in state 5GMM-REGISTERED, and 5GMM-IDLE mode over non 3GPP access }
ensure that {
  when { UE needs to change the SMS over NAS capability }
  then { UE initiates and successfully completes the registration procedure for mobility
registration update }
}
```

9.2.5.2.2.2 Conformance requirements

References: The conformance requirements covered in the present TC are specified in: TS 24.501 [22], subclause 5.5.1.3.2. Unless otherwise stated these are Rel-15 requirements.

[TS 24.501, clause 5.5.1.3.2]

The UE in state 5GMM-REGISTERED shall initiate the registration procedure for mobility and periodic registration update by sending a REGISTRATION REQUEST message to the AMF,

...

- 1) when the UE needs to register for SMS over NAS, indicate a change in the requirements to use SMS over NAS, or de-register from SMS over NAS;

...

For a REGISTRATION REQUEST message with a 5GS registration type IE indicating "mobility registration updating", UE shall include the requested NSSAI containing the S-NSSAI(s) corresponding to the slices to which the UE intends to register with and shall include the mapped S-NSSAI(s) for the requested NSSAI, if available, in the REGISTRATION REQUEST message. If the UE has allowed NSSAI or configured NSSAI for the current PLMN, the requested NSSAI shall be either:

- a) the configured NSSAI for the current PLMN, or a subset thereof as described below, if the UE has no allowed NSSAI for the current PLMN;
- b) the allowed NSSAI for the current PLMN, or a subset thereof as described below, if the UE has an allowed NSSAI for the current PLMN; or
- c) the allowed NSSAI for the current PLMN, or a subset thereof as described below, plus one or more S-NSSAIs from the configured NSSAI for which no corresponding S-NSSAI is present in the allowed NSSAI and those are neither in the rejected NSSAI for the current PLMN nor in the rejected NSSAI for the current registration area.

If the UE has neither allowed NSSAI for the current PLMN nor configured NSSAI for the current PLMN and has a default configured NSSAI, the UE shall:

- a) include the S-NSSAI(s) in the Requested NSSAI IE of the REGISTRATION REQUEST message using the default configured NSSAI; and
- b) include the Network slicing indication IE with the Default configured NSSAI indication bit set to "Requested NSSAI created from default configured NSSAI" in the REGISTRATION REQUEST message.

If the UE has no allowed NSSAI for the current PLMN, no configured NSSAI for the current PLMN, and no default configured NSSAI, the UE shall not include a requested NSSAI in the REGISTRATION REQUEST message.

The subset of configured NSSAI provided in the requested NSSAI consists of one or more S-NSSAIs in the configured NSSAI applicable to this PLMN, if the S-NSSAI is neither in the rejected NSSAIs for the current PLMN nor in the rejected NSSAI for the current registration area.

The subset of allowed NSSAI provided in the requested NSSAI consists of one or more S-NSSAIs in the allowed NSSAI for this PLMN.

NOTE 3: How the UE selects the subset of configured NSSAI or allowed NSSAI to be provided in the requested NSSAI is implementation specific. The UE can take preferences indicated by the upper layers (e.g. policies, applications) into account.

9.2.5.2.2.3 Test description

9.2.5.2.2.3.1 Pre-test conditions

System Simulator:

WLAN Cell 27

UE:

UE is enabled for SMS over NAS

Preamble:

The UE is in state 3W-A with PDU session Active state according to TS 38.508-1 [4] SMS over NAS allowed.

9.2.5.2.1.3.2 Test procedure sequence

Table 9.2.5.2.1.3.2-1: Main behaviour

| St | Procedure | Message Sequence | | TP | Verdict |
|----|---|------------------|-----------------------------|----|---------|
| | | U - S | Message | | |
| 1 | Make the UE deregister the SMS over NAS (NOTE 1) | - | - | - | - |
| 2 | The UE transmits an REGISTRATION REQUEST message indicating "mobility registration updating". | --> | 5GMM: REGISTRATION REQUEST | 1 | P |
| 3 | SS sends a REGISTRATION ACCEPT message | <<-- | 5GMM: REGISTRATION ACCEPT | - | - |
| 4 | Check: Does the UE send a REGISTRATION COMPLETE? | --> | 5GMM: REGISTRATION COMPLETE | - | - |

Note 1: This can be done by MMI or AT command +C5GUSMS

9.2.5.2.1.3.3 Specific message contents

Table 9.2.5.2.1.3.3-1: REGISTRATION REQUEST (preamble)

| Derivation path: TS 38.508-1 [4], Table 4.7.1-6 | | | |
|---|------------------------|---------|-----------|
| Information Element | Value/remark | Comment | Condition |
| 5GS registration type | | | |
| 5GS registration type value | '001'B | | INITIAL |
| 5GS update type | | | |
| SMS requested | SMS over NAS supported | | |

Table 9.2.5.2.1.3.3-2: REGISTRATION ACCEPT (preamble)

| Derivation path: TS 38.508-1 [4], Table 4.7.1-7 | | | |
|---|----------------------|---------|-----------|
| Information Element | Value/remark | Comment | Condition |
| 5GS registration result | | | |
| SMS allowed | SMS over NAS allowed | | |
| T3512 value | | | |
| Timer value | '00011'B | | |
| Unit | '101'B | | |

Table 9.2.5.2.1.3.3-3: REGISTRATION REQUEST (Table 9.2.5.2.1.3.2-1, step 2)

| Derivation path: TS 38.508-1 [4], Table 4.7.1-6 | | | |
|---|----------------------------|---------|-----------|
| Information Element | Value/remark | Comment | Condition |
| 5GS registration type | | | |
| 5GS registration type value | '010'B | | MOBILITY |
| 5GS update type | | | |
| SMS requested | SMS over NAS not supported | | |

9.2.6 De-registration

9.2.6.1 UE-initiated de-registration

9.2.6.1.1 UE-initiated de-registration / switch off

9.2.6.1.1.1 Test Purpose (TP)

(1)

```
with { the UE in 5GMM-REGISTERED state }
ensure that {
  when { the UE is switched off }
  then { the UE shall send DEREGISTRATION REQUEST message with De-registration type IE indicated to "Switch off" }
}
```

(2)

```
with { the UE supports remove USIM without power down and in 5GMM-REGISTERED state }
ensure that {
  when { the USIM is removed from the UE }
  then { the UE shall send DEREGISTRATION REQUEST message with De-registration type IE indicated to "Switch off" }
}
```

(3)

```
with { the UE in 5GMM-DEREGISTERED-INTIATED state }
ensure that {
  when { the first four expiries of the timer T3521 }
  then { the UE shall retransmit the DEREGISTRATION REQUEST message and shall reset and restart timer T3521 }
}
```

(4)

```
with { the UE in 5GMM-DEREGISTERED-INTIATED state }
ensure that {
  when { On the fifth expiry of timer T3521 }
  then { the deregistration procedure shall be aborted and the UE perform local detach }
}
```

9.2.6.1.1.2 Conformance requirements

References: The conformance requirements covered in the present TC are specified in: TS 24.501, clauses 5.5.2.1, 5.5.2.2.1 and 5.5.2.2.6. Unless otherwise stated these are Rel-15 requirements.

[TS 24.501, clause 5.5.2.1]

The de-registration procedure is used:

- a) by the UE to de-register for 5GS services over 3GPP access when the UE is registered over 3GPP access;
- b) by the UE to de-register for 5GS services over 3GPP access, non-3GPP access, or both when the UE is registered in the same PLMN over both accesses;
- c) by the network to inform the UE that it is deregistered for 5GS services over 3GPP access when the UE is registered over 3GPP access;
- d) by the network to inform the UE that it is deregistered for 5GS services over 3GPP access, non-3GPP access, or both when the UE is registered in the same PLMN over both accesses; and
- e) by the network to inform the UE to re-register to the network.

The de-registration procedure with appropriate de-registration type shall be invoked by the UE:

- a) if the UE is switched off; and
- b) as part of the eCall inactivity procedure defined in subclause 5.5.3.

The de-registration procedure with appropriate de-registration type shall be invoked by the network:

- a) if the network informs whether the UE should re-register to the network.

The de-registration procedure with appropriate access type shall be invoked by the UE:

- a) if the UE wants to de-register for 5GS services over 3GPP access when the UE is registered over 3GPP access;
or
- b) the UE wants to de-register for 5GS services over 3GPP access, non-3GPP access, or both when the UE is registered in the same PLMN over both accesses.

If the de-registration procedure is triggered due to USIM removal, the UE shall indicate "switch off" in the de-registration type IE.

If the de-registration procedure is requested by the UDM for a UE that has an emergency PDU session, the AMF shall not send a DEREGISTRATION REQUEST message to the UE.

If the de-registration procedure for 5GS services is performed, the PDU sessions, if any, for this particular UE are released locally without peer-to-peer signalling between the UE and the network.

The UE is allowed to initiate the de-registration procedure even if the timer T3346 is running.

NOTE: When the UE has no PDU sessions over non-3GPP access, or the UE moves all the PDU sessions over a non-3GPP access to a 3GPP access, the UE and the AMF need not initiate de-registration over the non-3GPP access.

The AMF shall provide the UE with a non-3GPP de-registration timer.

[TS 24.501, clause 5.5.2.2.1]

The de-registration procedure is initiated by the UE by sending a DEREGISTRATION REQUEST message (see example in figure 5.5.2.2.1). The De-registration type IE included in the message indicates whether the de-registration procedure is due to a "switch off" or not. The access type included in the message indicates whether the de-registration procedure is:

- a) for 5GS services over 3GPP access when the UE is registered over 3GPP access only;
- b) for 5GS services over non-3GPP access when the UE is registered over non-3GPP access only; or

- c) for 5GS services over 3GPP access, non-3GPP access or both 3GPP access and non-3GPP access when the UE is registered in the same PLMN over both accesses.

If the UE has a valid 5G-GUTI, the UE shall populate the 5GS mobile identity IE with the valid 5G-GUTI. If the UE does not have a valid 5G-GUTI, the UE shall populate the 5GS mobile identity IE with its SUCI.

If the UE does not have a valid 5G-GUTI and it does not have a valid SUCI, then the UE shall populate the 5GS mobile identity IE with its PEI.

If the de-registration request is not due to switch off and the UE is in the state 5GMM-REGISTERED or 5GMM-REGISTERED-INITIATED, timer T3521 shall be started in the UE after the DEREGISTRATION REQUEST message has been sent. The UE shall enter the state 5GMM-DEREGISTERED-INITIATED.

If the UE is to be switched off, the UE shall try for a period of 5 seconds to send the DEREGISTRATION REQUEST message. During this period, the UE may be switched off as soon as the DEREGISTRATION REQUEST message has been sent.

[TS 24.501, clause 5.5.2.2.6]

...

- c) T3521 timeout.

On the first four expiries of the timer, the UE shall retransmit the DEREGISTRATION REQUEST message and shall reset and restart timer T3521. On the fifth expiry of timer T3521, the de-registration procedure shall be aborted and the UE proceeds as follows:

9.2.6.1.1.3 Test description

9.2.6.1.1.3.1 Pre-test conditions

System Simulator:

- WLAN Cell 27.

UE:

- None.

Preamble:

- The UE is in state 3W-A on WLAN Cell 27 according to 38.508-1[4].

9.2.6.1.1.3.2 Test procedure sequence

Table 9.2.6.1.1.3.2-1: Main behaviour

| St | Procedure | Message Sequence | | TP | Verdict |
|------|---|------------------|-----------------------------------|----|---------|
| | | U - S | Message | | |
| 1 | Cause switch off | - | - | - | - |
| 2 | Check: Does the UE transmit a DEREGISTRATION REQUEST with the De-registration type IE indicating "switch off"? | --> | DEREGISTRATION REQUEST | 1 | P |
| 3 | SS Transmits DEREGISTRATION ACCEPT | <-- | DEREGISTRATION ACCEPT | - | - |
| 4 | The generic procedure for SS-requested IPsec Secure tunnel disconnection, specified in subclause 4.5A.3 of TS 38.508-1 [4], takes place performing disconnection of security association. | - | - | - | - |
| 5 | The UE is switched on. | - | - | - | - |
| 6-15 | The registration procedure is completed by executing steps 1-10 of the UE registration procedure in TS 38.508-1 [4] table 4.5.2.2-3. | - | - | - | - |
| 16 | Cause UE to initiate deregistration. | - | - | - | - |
| 17 | The UE transmits UE transmit a DEREGISTRATION REQUEST message. The UE starts timer T3521. | --> | DEREGISTRATION REQUEST | - | - |
| 18 | The SS does not respond to the DEREGISTRATION REQUEST message. | - | - | - | - |
| 19 | Check: When the timer T3521 expires does the UE re-transmit DETACH REQUEST message. Timer T3421 is re-started (1 st expiry). | --> | DEREGISTRATION REQUEST | 3 | P |
| 20 | The SS does not respond to the DEREGISTRATION REQUEST message. | - | - | - | - |
| 21 | Check: When the timer T3521 expires does the UE re-transmit DEREGISTRATION REQUEST message. Timer T3521 is re-started (2 nd expiry). | --> | DEREGISTRATION REQUEST | 3 | P |
| 22 | The SS does not respond to the DEREGISTRATION REQUEST message. | - | - | - | - |
| 23 | Check: When the timer T3521 expires does the UE re-transmit DEREGISTRATION REQUEST message. Timer T3521 is re-started (3 rd expiry). | --> | DEREGISTRATION REQUEST | 3 | P |
| 24 | The SS does not respond to the DEREGISTRATION REQUEST message. | - | - | - | - |
| 25 | Check: When the timer T3521 expires does the UE re-transmit DEREGISTRATION REQUEST message. Timer T3521 is re-started (4 th expiry). | --> | DEREGISTRATION REQUEST | 3 | P |
| 26 | The SS does not respond to the DETACH REQUEST message. | - | - | - | - |
| 27 | When the timer T3521 expires the UE aborts the detach procedure and performs a local detach (5 th expiry). | - | - | 4 | P |
| 28 | SS Transmits PDU SESSION MODIFICATION COMMAND | <-- | PDU SESSION MODIFICATION COMMAND | - | - |
| 29 | Check: Does the UE transmit a PDU SESSION MODIFICATION COMPLETE? | --> | PDU SESSION MODIFICATION COMPLETE | 4 | F |
| 30 | The generic procedure for SS-requested IPsec Secure tunnel disconnection, specified in subclause 4.5A.3 of TS 38.508-1 [4], takes place performing disconnection of security association. | - | - | - | - |
| - | EXCEPTION: Steps 31 to 46 shall be implemented if the UE supports remove USIM without power down: pc_USIM_Removal = TRUE [29] | - | - | - | - |
| 31 | The UE is switched off. | - | - | - | - |

| | | | | | |
|-------|---|-----|------------------------|---|---|
| 32 | The UE is switched on. | - | - | - | - |
| 33-42 | The registration procedure is completed by executing steps 1-10 of the UE registration procedure in TS 38.508-1 [4] table 4.5.2.2-3. | - | - | - | - |
| 43 | Cause removal of USIM from the UE without powering down. | - | - | - | - |
| 44 | Check: Does the UE transmit a DEREGISTRATION REQUEST with the De-registration type IE indicating "switch off"? | --> | DEREGISTRATION REQUEST | 2 | P |
| 45 | SS Transmits DEREGISTRATION ACCEPT | <-- | DEREGISTRATION ACCEPT | - | - |
| 46 | The generic procedure for SS-requested IPsec Secure tunnel disconnection, specified in subclause 4.5A.3 of TS 38.508-1 [4], takes place performing disconnection of security association. | - | - | - | - |

9.2.6.1.1.3.3 Specific message contents

Table 9.2.6.1.1.3.3-1: DEREGISTRATION REQUEST (Step 1 and step 44, Table 9.2.6.1.1.3.2-1)

| Derivation path: TS 38.508-1 [4], table 4.7.1-12 | | | |
|--|--------------|---------|-----------|
| Information Element | Value/Remark | Comment | Condition |
| De-registration type | | | |
| Switch off | '1'B | | |

9.2.6.2 Network-initiated de-registration

9.2.6.2.1 Network-initiated de-registration / De-registration for Non-3GPP access / Re-registration required

9.2.6.2.1.1 Test Purpose (TP)

(1)

```
with { the UE in 5GMM-REGISTERED state }
ensure that {
  when { the SS sends a DEREGISTRATION REQUEST message indicates "re-registration required" and the
de-registration request is for non 3GPP access }
  then { the UE sends a DEREGISTRATION ACCEPT message to the network and releases the existing NAS
signalling connection, then initiates an initial registration and also re-establishes any previously
established PDU sessions }
}
```

9.2.6.2.1.2 Conformance requirements

References: The conformance requirement covered in the present TC is specified in: 3GPP TS 24.501 clauses 5.5.2.3.2. Unless otherwise stated these are Rel-15 requirements.

[TS 24.501 clause 5.5.2.3.2]

NOTE 1: When the de-registration type indicates "re-registration required", user interaction is necessary in some cases when the UE cannot re-establish the PDU session (s), if any, automatically.

...

Upon sending a DEREGISTRATION ACCEPT message, the UE shall delete the rejected NSSAI as specified in subclause 4.6.2.2.

If the de-registration type indicates "re-registration required", then the UE shall ignore the 5GMM cause IE if received.

If the de-registration type indicates "re-registration not required", the UE shall take the actions depending on the received 5GMM cause value:

- #3 (Illegal UE);
- #6 (Illegal ME); or
- #7 (5GS services not allowed).

The UE shall set the 5GS update status to 5U3 ROAMING NOT ALLOWED (and shall store it according to subclause 5.1.3.2.2) and shall delete any 5G-GUTI, last visited registered TAI, TAI list and ngKSI. The UE shall consider the USIM as invalid for 5GS services until switching off or the UICC containing the USIM is removed. The UE shall delete the list of equivalent PLMNs and shall enter the state 5GMM-DEREGISTERED.

If the UE is operating in single-registration mode, the UE shall handle the EMM parameters EMM state, EPS update status, 4G-GUTI, last visited registered TAI, TAI list and eKSI as specified in 3GPP TS 24.301 [15] for the case when a DETACH REQUEST is received with the EMM cause with the same value and with detach type set to "re-attach not required".

NOTE 2: The possibility to configure a UE so that the radio transceiver for a specific radio access technology is not active, although it is implemented in the UE, is out of scope of the present specification.

If the UE also supports the registration procedure over the other access, the UE shall in addition handle 5GMM parameters and 5GMM state for this access, as described for this 5GMM cause value.

...

- #72 (Non-3GPP access to 5GCN not allowed).

The UE shall set the 5GS update status to 5U3 ROAMING NOT ALLOWED (and shall store it according to subclause 5.1.3.2.2) and shall delete 5G-GUTI, last visited registered TAI, TAI list and ngKSI. Additionally, the UE shall reset the registration attempt counter and enter the state 5GMM-DEREGISTERED.

NOTE 3: The 5GMM sublayer states, the 5GMM parameters and the registration status are managed per access type independently, i.e. 3GPP access or non-3GPP access (see subclauses 4.7.2 and 5.1.3).

The UE shall disable the N1 mode capability for non-3GPP access (see subclause 4.9.3).

As an implementation option, the UE may enter the state 5GMM-DEREGISTERED.PLMN-SEARCH in order to perform a PLMN selection according to 3GPP TS 23.122 [5].

9.2.6.2.1.3 Test description

9.2.6.2.1.3.1 Pre-test conditions

System Simulator:

- WLAN Cell 27.

UE:

- None.

Preamble:

- the UE is in state 3W-A on WLAN Cell 27 according to TS 38.508-1 [4].

9.2.6.2.1.3.2 Test procedure sequence

Table 9.2.6.2.1.3.2-1: Main behaviour

| St | Procedure | Message Sequence | | TP | Verdict |
|------|---|------------------|------------------------|----|---------|
| | | U - S | Message/PDU/SDU | | |
| 1 | The SS transmits a DEREGISTRATION REQUEST with indicates "re-registration required". | <- | DEREGISTRATION REQUEST | - | - |
| 2 | Check: Does the UE transmits a DEREGISTRATION ACCEPT message? | --> | DEREGISTRATION ACCEPT | 1 | P |
| 3 | The generic procedure for SS-requested IPsec Secure tunnel disconnection, specified in subclause 4.5A.3 of TS 38.508-1 [4], takes place performing disconnection of security association. | - | - | - | - |
| - | EXCEPTION: step 4 describes a behaviour which depends on the UE capability | - | - | - | - |
| 4 | IF NOT pc_Automatic_Re_registration, the user initiates a registration by MMI. | - | - | - | - |
| 6-15 | The registration procedure is completed by executing steps 1-10 of the UE registration procedure in TS 38.508-1 [4] table 4.5.2.2-3. | - | - | 1 | P |

9.2.6.2.1.3.3 Specific message contents

Table 9.2.6.2.1.3.3-1: DEREGISTRATION REQUEST (step 1, Table 9.2.6.2.1.3.2-1)

| Derivation path: TS 38.508-1 [4] Table 4.7.1-14 | | | |
|---|--------------|--------------------------|-----------|
| Information Element | Value/Remark | Comment | Condition |
| DEREGISTRATION type | | | |
| Switch off | '0'B | Normal de-registration | |
| Re-registration required | '1'B | re-registration required | |
| Access type | '10'B | Non 3GPP access | |
| 5GMM cause | '0000 0011'B | Cause #3 (Illegal UE) | |

Table 9.2.6.2.1.3.3-2: REGISTRATION REQUEST (step 8, Table 9.2.6.2.1.3.2-1)

| Derivation path: TS 38.508-1 [4] Table 4.7.1-6 | | | |
|--|---------------------------------|---------|-----------|
| Information Element | Value/remark | Comment | Condition |
| 5GS mobile identity | The valid 5G-GUTI that UE holds | | |

9.2.6.2.2 Network-initiated de-registration / De-registration for Non 3GPP access / Re-registration not required

9.2.6.2.2.1 Test Purpose (TP)

(1)

```

with { the UE in 5GMM-REGISTERED state }
ensure that {
  when { the SS sends a DEREGISTRATION REQUEST message indicates no 5GMM cause IE, "re-registration not required" and the de-registration request is for npn-3GPP access and 5GMM cause value is not included }

```

```

    then { the UE deletes 5G-GUTI, TAI list, last visited registered TAI, list of equivalent PLMNs,
ngKSI, sends a DEREGISTRATION ACCEPT message enter the state 5GMM-DEREGISTERED for non 3GPP access }
    }

```

(2)

```

with { the UE in 5GMM-REGISTERED state }
ensure that {
    when { the SS sends a DEREGISTRATION REQUEST message indicates no 5GMM cause IE, "re-registration
not required" and the de-registration request is for non-3GPP access and 5GMM cause value set to #7
5GS services not allowed }
    then { the UE deletes 5G-GUTI, TAI list, last visited registered TAI, list of equivalent PLMNs,
ngKSI, consider the USIM as invalid for 5GS services until switching off or the UICC containing the
USIM is removed, sends a DEREGISTRATION ACCEPT message enter the state 5GMM-DEREGISTERED for Non
3GPP access }
}

```

(3)

```

with { the UE in 5GMM-REGISTERED state }
ensure that {
    when { the SS sends a DEREGISTRATION REQUEST message indicates no 5GMM cause IE, "re-registration
not required" and the de-registration request is for non-3GPP access and 5GMM cause value set to #72
Non-3GPP access to 5GCN not allowed }
    then { the UE deletes 5G-GUTI, TAI list, last visited registered TAI, ngKSI, disable the N1 mode
capability for non-3GPP access, sends a DEREGISTRATION ACCEPT message enter the state 5GMM-
DEREGISTERED for Non 3GPP access }
}

```

9.2.6.2.2.2 Conformance requirements

References: The conformance requirements covered in the current TC are specified in: TS 24.501 clauses 5.5.2.3.2 and 5.5.2.3.4. Unless otherwise stated these are Rel-15 requirements.

[TS 24.501, clause 5.5.2.3.2]

Upon receiving the DEREGISTRATION REQUEST message, if the DEREGISTRATION REQUEST message indicates "re-registration not required" and the de-registration request is for 3GPP access, the UE shall release locally the PDU sessions over 3GPP access, if any. The UE shall send a DEREGISTRATION ACCEPT message to the network and enter the state 5GMM-DEREGISTERED for 3GPP access.

...

If the de-registration type indicates "re-registration not required", the UE shall take the actions depending on the received 5GMM cause value:

...

#7 (5GS services not allowed).

The UE shall set the 5GS update status to 5U3 ROAMING NOT ALLOWED (and shall store it according to subclause 5.1.3.2.2) and shall delete any 5G-GUTI, last visited registered TAI, TAI list and ngKSI. The UE shall consider the USIM as invalid for 5GS services until switching off or the UICC containing the USIM is removed. The UE shall delete the list of equivalent PLMNs and shall enter the state 5GMM-DEREGISTERED.

If the UE is operating in single-registration mode, the UE shall handle the EMM parameters EMM state, EPS update status, 4G-GUTI, last visited registered TAI, TAI list and eKSI as specified in 3GPP TS 24.301 [15] for the case when a DETACH REQUEST is received with the EMM cause with the same value and with detach type set to "re-attach not required".

NOTE 2: The possibility to configure a UE so that the radio transceiver for a specific radio access technology is not active, although it is implemented in the UE, is out of scope of the present specification.

If the UE also supports the registration procedure over the other access, the UE shall in addition handle 5GMM parameters and 5GMM state for this access, as described for this 5GMM cause value.

...

#72 (Non-3GPP access to 5GCN not allowed).

The UE shall set the 5GS update status to 5U3 ROAMING NOT ALLOWED (and shall store it according to subclause 5.1.3.2.2) and shall delete 5G-GUTI, last visited registered TAI, TAI list and ngKSI. Additionally, the UE shall reset the registration attempt counter and enter the state 5GMM-DEREGISTERED.

NOTE 3: The 5GMM sublayer states, the 5GMM parameters and the registration status are managed per access type independently, i.e. 3GPP access or non-3GPP access (see subclauses 4.7.2 and 5.1.3).

The UE shall disable the N1 mode capability for non-3GPP access (see subclause 4.9.3).

As an implementation option, the UE may enter the state 5GMM-DEREGISTERED.PLMN-SEARCH in order to perform a PLMN selection according to 3GPP TS 23.122 [5].

[TS 24.501, clause 5.5.2.3.4]

- b) DEREGISTRATION REQUEST, other 5GMM cause values than those treated in subclause 5.5.2.3.2 or no 5GMM cause IE is included, and the De-registration type IE indicates "re-registration not required".

The UE shall delete 5G-GUTI, TAI list, last visited registered TAI, list of equivalent PLMNs, ngKSI, shall set the 5GS update status to 5U2 NOT UPDATED and shall start timer T3502.

A UE not supporting S1 mode may enter the state 5GMM-DEREGISTERED.PLMN-SEARCH in order to perform a PLMN selection according to 3GPP TS 23.122 [5]; otherwise the UE shall enter the state 5GMM-DEREGISTERED.ATTEMPTING-REGISTRATION.

A UE operating in single-registration mode shall:

- enter the state 5GMM-DEREGISTERED and attempt to select E-UTRAN radio access technology and proceed with the appropriate EMM specific procedures. In this case, the UE may disable N1 mode capability (see subclause 4.9); or
- enter the state 5GMM-DEREGISTERED.PLMN-SEARCH in order to perform a PLMN selection according to 3GPP TS 23.122 [5].

A UE operating in single-registration mode shall set the EPS update status to EU2 NOT UPDATED and shall delete the EMM parameters 4G-GUTI, last visited registered TAI, TAI list and eKSI and shall enter the state EMM-DEREGISTERED.

9.2.6.2.2.3 Test description

9.2.6.2.2.3.1 Pre-test conditions

System Simulator:

- WLAN Cell 27.

UE:

- None

Preamble:

- The UE is in state 3W-A on WLAN Cell 27 according to TS 38.508-1 [4].

9.2.6.2.2.3.2 Test procedure sequence

Table 9.2.6.2.2.3.2-1: Main behaviour

| St | Procedure | Message Sequence | | TP | Verdict |
|-------|--|------------------|---------------------------------|----|---------|
| | | U – S | Message | | |
| 1 | SS sends a DEREGISTRATION REQUEST message indicates no 5GMM cause IE, "re-registration not required" and the de-registration request is for non 3GPP access | <-- | NR 5GMM: DEREGISTRATION REQUEST | - | - |
| 2 | Check: Does the UE transmit an DEREGISTRATION ACCEPT message? | --> | NR 5GMM: DEREGISTRATION ACCEPT | 1 | P |
| 3 | The generic procedure for SS-requested IPsec Secure tunnel disconnection, specified in subclause 4.5A.3 of TS 38.508-1 [4], takes place performing disconnection of security association. | - | - | - | - |
| 4 | Cause UE to initiate registration. | - | - | - | - |
| 5-15 | The registration procedure is completed by executing steps 1-10 of the UE registration procedure in TS 38.508-1 [4] table 4.5.2.2-3. | - | - | 1 | P |
| 16 | SS sends a DEREGISTRATION REQUEST message indicates no 5GMM cause IE, "re-registration not required", 5GMM Cause set to #7 (5GS services not allowed) and the de-registration request is for non 3GPP access | <-- | NR 5GMM: DEREGISTRATION REQUEST | - | - |
| 17 | Check: Does the UE transmit an DEREGISTRATION ACCEPT message? | --> | NR 5GMM: DEREGISTRATION ACCEPT | 2 | P |
| 18 | The generic procedure for SS-requested IPsec Secure tunnel disconnection, specified in subclause 4.5A.3 of TS 38.508-1 [4], takes place performing disconnection of security association. | - | - | - | - |
| 19 | Check for 60 seconds if UE initiates Registration procedure | - | NR 5GMM: REGISTRATION REQUEST | 2 | F |
| 20 | The UE is switched off. | - | - | - | - |
| 21 | The UE is switched on. | - | - | - | - |
| 22-31 | The registration procedure is completed by executing steps 1-10 of the UE registration procedure in TS 38.508-1 [4] table 4.5.2.2-3. | - | - | - | - |
| 32 | SS sends a DEREGISTRATION REQUEST message indicates no 5GMM cause IE, "re-registration not required", 5GMM Cause set to #72 (Non-3GPP access to 5GCN not allowed) and the de-registration request is for non 3GPP access | <-- | NR 5GMM: DEREGISTRATION REQUEST | - | - |
| 33 | Check: Does the UE transmit an DEREGISTRATION ACCEPT message? | --> | NR 5GMM: DEREGISTRATION ACCEPT | 3 | P |
| 34 | The generic procedure for SS-requested IPsec Secure tunnel disconnection, specified in subclause 4.5A.3 of TS 38.508-1 [4], takes place performing disconnection of security association. | - | - | - | - |
| 35 | Check for 60 seconds if UE initiates Registration procedure | - | NR 5GMM: REGISTRATION REQUEST | 3 | F |
| 36 | The UE is switched off. | - | - | - | - |

9.2.6.2.2.3.3 Specific message contents

Table 9.2.6.2.2.3.3-1: Message DEREGISTRATION REQUEST (step 1, Table 9.2.6.2.2.3.2-1)

| Derivation path: TS 38.508-1 [4], Table 4.7.1-12 | | | |
|--|--------------|------------------------------|-----------|
| Information Element | Value/remark | Comment | Condition |
| De-registration type | | | |
| Switch off | '0'B | Normal de-registration | |
| Re-registration required | '0'B | re-registration not required | |
| Access type | '01'B | 3GPP access | |
| 5GMM cause | Not Present | | |

Table 9.2.6.2.2.3.3-2: Message REGISTRATION REQUEST (step 8, Table 9.2.6.2.2.3.2-1)

| Derivation path: TS 38.508-1 [4], table 4.7.1-6 | | | |
|---|-------------------|---|-----------|
| Information Element | Value/Remark | Comment | Condition |
| ngKSI | | | |
| NAS key set identifier | '111'B | no key is available (UE to network) | |
| TSC | Any allowed value | TSC does not apply for NAS key set identifier value "111" | |
| 5GS mobile identity | The valid SUCI | | |
| Last visited registered TAI | Not present | | |

Table 9.2.6.2.2.3.3-2: Message ATTACH REQUEST (step 28, Table 9.2.6.2.2.3.2-1)

| Derivation Path: TS 36.508 [7], Table 4.7.2-4 | | | |
|---|-------------------|--|-----------|
| Information Element | Value/remark | Comment | Condition |
| NAS key set identifier | | | |
| NAS key set identifier | '111'B | no key is available | |
| TSC | Any allowed value | TSC does not apply for NAS key set identifier value "111". | |
| Old GUTI or IMSI | IMSI1 | | |
| Last visited registered TAI | Not present | | |

9.2.7 Service request

9.2.7.1 Service request / IDLE mode uplink user data transport / Rejected / Restricted service area, Abnormal / T3517

9.2.7.1.1 Test Purpose (TP)

Same test purposes as clause 9.1.7.1.1

9.2.7.1.2 Conformance requirements

Same conformance requirements as in clause 9.1.7.1.2

9.2.7.1.3 Test description

9.2.7.1.3.1 Pre-test conditions

System Simulator:

- WLAN Cell 27

UE:

- None.

Preamble:

- The UE is in state 3W-A with PDU session Active state according to TS 38.508-1 [4]

9.2.7.1.3.2 Test procedure sequence

Table 9.2.7.1.3.2-1: Main behaviour

| St | Procedure | Message Sequence | | TP | Verdict |
|------|---|------------------|-----------------------|----|---------|
| | | U - S | Message | | |
| 1 | The generic procedure for SS-requested IPsec Secure tunnel disconnection, specified in subclause 4.5A.3 of TS 38.508-1 [4], takes place performing disconnection of security association. | - | - | - | - |
| 2 | Trigger UE to initiate IPsec SA (Note 1) | - | - | - | - |
| - | Exception: In parallel to steps 3, the UE initiates an IPsec security association and one child security association as defined in TS 24.502 [35] clause 7.3.2 | - | - | - | - |
| 3 | Check: Does UE transmit a SERVICE REQUEST message with Service type IE set to 'data'? | --> | SERVICE REQUEST | 1 | P |
| 4 | The SS transmits a SERVICE REJECT message with 5GMM cause = "Restricted service area ". | << | SERVICE REJECT | - | - |
| 5-6 | Void. | - | - | - | - |
| 6A | The SS starts timer 5 sec.
Note: An arbitrary chosen timer to avoid message crossing. | - | - | - | - |
| - | EXCEPTION: Steps 6Ba1 to 6Bb3 describe behaviour that depends on the UE implementation; the "lower case letter" identifies a step sequence that take place if the UE is implemented in a certain way. | - | - | - | - |
| - | Exception: In parallel to steps 6Ba1 to 8B, the UE initiates an IPsec security association as defined in TS 24.502 [35] clause 7.3.2 | - | - | - | - |
| 6Ba1 | Check: Does the UE transmit REGISTRATION REQUEST for mobility registration?
NOTE: Allowed for Rel-15 UEs. | --> | REGISTRATION REQUEST | 2 | P |
| 6Ba2 | Stop timer 5 sec. | - | - | - | - |
| 6Bb1 | Timer 5 sec expires. | - | - | - | - |
| 6Bb2 | The generic procedure for SS-requested IPsec Secure tunnel disconnection, specified in subclause 4.5A.3 of TS 38.508-1 [4], takes place performing disconnection of security association. | - | - | - | - |
| 6Bb3 | Check: Does the UE transmit REGISTRATION REQUEST for mobility registration over a new signalling connection? | --> | REGISTRATION REQUEST | 2 | P |
| 7-8 | Void. | - | - | - | - |
| 8A | SS stops transmitting UL grant. | - | - | - | - |
| 8B | SS sends a REGISTRATION ACCEPT message containing a 5G-GUTI. | << | REGISTRATION ACCEPT | - | - |
| 8C | SS transmits one UL grant, for the UE to transmit the REGISTRATION COMPLETE message at step 8D. | - | - | - | - |
| 8D | The UE send a REGISTRATION COMPLETE. | --> | REGISTRATION COMPLETE | - | - |
| 8E | The generic procedure for SS-requested IPsec Secure tunnel disconnection, specified in subclause 4.5A.3 of TS 38.508-1 [4], takes place performing disconnection of security association. | - | - | - | - |
| 8F | The SS resumes UL grant transmission. | - | - | - | - |
| 8G | The UE transmits a SERVICE REQUEST | --> | SERVICE REQUEST | - | - |

| | | | | | |
|---|---|-----|-----------------|-----|---|
| | message over a new signalling connection. | | | | |
| 8H | The SS does not respond to SERVICE REQUEST message.
Note: The UE locally releases the signalling connection after T3517 expiry. | - | - | - | - |
| - | EXCEPTION: Steps 9 to 10 are repeated for 4 times. | - | - | - | - |
| 9 | Check: does the UE transmits a SERVICE REQUEST message after T3517 expiry but before 60s over a new signalling connection? | --> | SERVICE REQUEST | 3 | P |
| 10 | The SS does not respond to SERVICE REQUEST message.
Note: The UE locally releases the signalling connection after T3517 expiry. | --> | SERVICE REQUEST | - | - |
| 11 | Check: Does the UE transmits a SERVICE REQUEST message within 60 seconds (minimum value of T3525) over a new signalling connection? | --> | SERVICE REQUEST | 3,4 | F |
| 12 | The SS starts timer 10 sec after Step 11 to see if UE performs the optional Steps listed below. | - | - | - | - |
| - | EXCEPTION: Steps 12a1 to 12a7a2 describe behaviour that depends on the UE implementation; the "lower case letter" identifies a step sequence that take place if the UE is implemented in a certain way. | - | - | - | - |
| 12a1 | Trigger UE to initiate IPsec SA (Note 1) | - | - | - | - |
| | Exception: In parallel to steps 12a2 to 12a5, the UE initiates an IPsec security association and one child security association as defined in TS 24.502 [35] clause 7.3.2 | - | - | - | - |
| 12a2 | The UE transmits a SERVICE REQUEST message after T3525 expiry over a new signalling connection. | --> | SERVICE REQUEST | - | - |
| 12a3-12a7a2 | Steps 5 to 9a2 of the NR RRC_CONNECTED procedure in TS 38.508-1 [4] Table 4.5.4.2-3 are executed. | - | - | - | - |
| Note 1: This could be done by e.g. MMI or by AT command +CGACT. | | | | | |

9.2.7.1.3.3 Specific message contents

Table 9.2.7.1.3.3-3: SERVICE REQUEST (steps 3, 8G and 9, Table 9.2.7.1.3.2-1)

| Derivation Path: TS 38.508-1 [4] Table 4.7.1-16 | | | |
|---|--------------|---------|-----------|
| Information Element | Value/remark | Comment | Condition |
| Service type | | | |
| Service type value | '0001'B | data | |

Table 9.2.7.1.3.3-4: SERVICE REJECT (step 4, Table 9.2.7.1.3.2-1)

| Derivation Path: TS 38.508-1 [4] Table 4.7.1-18 | | | |
|---|--------------|-------------------------|-----------|
| Information Element | Value/remark | Comment | Condition |
| 5GMM cause | '0001 1100'B | Restricted service area | |

9.2.7.2 Service request / CMM CONNECTED mode/uplink user data transport / Abnormal / T3517

9.2.7.2.1 Test Purpose (TP)

(1)

```
with { the UE is in 5GMM-REGISTERED state and 5GMM-CONNECTED mode over 3GPP access }
ensure that {
  when { the UE has user data pending due to no user-plane resources established for PDU session(s)
used for user data transport }
  then { the UE sends a SERVICE REQUEST message }
}
```

(2)

```
with { the UE sends a SERVICE REQUEST message in 5GMM-CONNECTED mode }
ensure that {
  when { T3517 expired }
  then { the UE stays in 5GMM-CONNECTED mode }
}
```

9.2.7.2.2 Conformance requirements

Same conformance requirements as in clause 9.1.7.2.2

9.2.7.2.3 Test description

9.2.7.2.3.1 Pre-test conditions

System Simulator:

- WLAN Cell 27

UE:

- None.

Preamble:

- The UE is in state 3W-A with PDU session (with PDU session ID X where $1 \leq X \leq 15$) Active state according to TS 38.508-1 [4]

9.2.7.2.3.2 Test procedure sequence

Table 9.2.7.2.3.2-1: Main behaviour

| St | Procedure | Message Sequence | | TP | Verdict |
|---|--|------------------|---------------------------------|----|---------|
| | | U – S | Message | | |
| 1 | The SS initiated child SA deletion procedure sec tunnel as defined in TS 24.502 [33] clause 7.7.2 | - | - | - | - |
| 2 | Trigger UE to send a ICMP ECHO REQUEST (pc_IPv4 = TRUE)_or ICMPv6 ECHO REQUEST (pc_IPv6 = TRUE) (Note 2) | - | - | - | - |
| 3 | The UE transmits a SERVICE REQUEST message. | --> | NR 5GMM: SERVICE REQUEST | 1 | P |
| 4 | The SS does not respond to the <i>SERVICE REQUEST</i> message. | - | - | - | - |
| 5 | Wait for T3517 seconds (Note 1). | - | - | - | - |
| 6 | The UE transmit a <i>SERVICE REQUEST</i> message. | --> | NR 5GMM: <i>SERVICE REQUEST</i> | - | - |
| 7 | The SS sends an IDENTITY REQUEST message. | <<-- | NR 5GMM: IDENTITY REQUEST | - | - |
| 8 | Check: Does the UE transmit an IDENTITY RESPONSE message? | --> | NR 5GMM: IDENTITY RESPONSE | 2 | P |
| - | Exception: In parallel to steps 9, the SS initiates one child security association as defined in TS 24.502 [33] clause 7.5 | - | - | - | - |
| 9 | The SS transmits SERVICE ACCEPT message to setup User-plane resources for the PDU session X. | <<-- | NR 5GMM: SERVICE ACCEPT | | |
| - | EXCEPTION: Steps 10a1 to 10b2 describe behaviour that depends on the UE implementation; the "lower case letter" identifies a step sequence that take place depending on the UE implementation. | - | - | - | - |
| 10a1 | IF (pc_IPv4 = TRUE) THEN, check that the UE sends an ICMP Echo request to the SS? | --> | <i>ICMP ECHO REQUEST</i> | 1 | P |
| 10a2 | The SS sends an ICMP Echo reply | <<-- | <i>ICMP ECHO REPLY</i> | - | |
| 10b1 | ELSE IF (pc_IPv4 = FALSE AND pc_IPv6 = TRUE) THEN, check the UE sends an ICMPv6 Echo request to the SS? | --> | <i>ICMPv6 ECHO REQUEST</i> | 1 | P |
| 10b2 | The SS sends an ICMPv6 Echo reply | <<-- | <i>ICMPv6 ECHO REPLY</i> | - | - |
| Note 1: T3517 expires after 15 seconds. | | | | | |
| Note 2: This could be done by a MMI command | | | | | |

9.2.7.2.3.3 Specific message contents

Table 9.2.7.2.3.3-1: SERVICE REQUEST (step 3, 6, Table 9.2.7.2.3.2-1)

| Derivation path: TS 38.508-1 [4], table 4.7.1-16 | | | |
|--|--------------|--|-----------|
| Information Element | Value/Remark | Comment | Condition |
| Service type | '0001'B | data | |
| Uplink data status | | | |
| PSI(X) | '1'B | PSI(X) is set to 1 indicates that uplink data are pending for the PDU session X activated in preamble. | |

Table 9.2.7.2.3.3-2: IDENTITY REQUEST (step 7, Table 9.2.7.2.3.2-1)

| Derivation Path: TS 38.508-1 [4] table 4.7.1-21 | | | |
|---|--------------|---------|-----------|
| Information Element | Value/remark | Comment | Condition |
| Identity type | '0010'B | 5G-GUTI | |

Table 9.2.7.2.3.3-3: IDENTITY RESPONSE (step 8, Table 9.2.7.2.3.2-1)

| Derivation Path: TS 38.508-1 [4] table 4.7.1-22 | | | |
|---|--------------|---------|-----------|
| Information Element | Value/remark | Comment | Condition |
| Mobile identity | 5G-GUTI | | |

Table 9.2.7.2.3.3-4: SERVICE ACCEPT (step 9, Table 9.2.7.2.3.2-1)

| Derivation path: TS 38.508-1 [4], table 4.7.1-17 | | | |
|--|--------------|--|-----------|
| Information Element | Value/Remark | Comment | Condition |
| PDU session reactivation result | | | |
| PSI(X) | '0'B | PSI(X) is set to 0 indicates that establishment of user-plane resource of the PDU session X activated in preamble is successful. | |

9.2.8 SMS over NAS

9.2.8.1 SMS over NAS / MO SMS over NAS - 5GMM-Idle mode

9.2.8.1.1 Test Purpose (TP)

(1)

```
with { the UE in switched off state with valid USIM inserted }
ensure that {
  when { the UE requests initial registration for SMS over NAS }
  then { the UE shall send REGISTRATION REQUEST message with SMS requested bit of the 5GS
registration type IE "SMS over NAS supported" }
}
```

(2)

```
with { the UE in 5GMM_Connected state with 5GMM-Idle mode and the UE has sent a SERVICE REQUEST
message triggered by initiating MO SMS}
ensure that {
  when { UE receives a SERVICE ACCEPT message from SS }
  then { UE sends CP-DATA containing RP-DATA RPDU (SMS SUBMIT TPDU) encapsulated in an Uplink NAS
transport message }
}
```

(3)

```
with { UE has sent CP-DATA containing an RP-DATA RPDU (SMS SUBMIT TPDU) encapsulated in an Uplink
NAS transport message }
ensure that {
  when { UE receives a CP-DATA containing an RP-ACK RPDU encapsulated in a Downlink NAS transport
message }
  then { UE sends a CP-ACK encapsulated in an Uplink NAS Transport message }
```

9.2.8.1.2 Conformance requirements

Same conformance requirements as in clause 9.2.8.1.2

9.2.8.1.3 Test description

9.2.8.1.3.1 Pre-test conditions

System Simulator:

WLAN Cell 27;

UE:

The UE does not have any stored SMS message.

Preamble:

The UE is in state Switched OFF (state-0W-B) according to TS 38.508-1 [4].

9.2.8.1.3.2 Test procedure sequence

Table 9.2.8.1.3.2-1: Main behaviour

| St | Procedure | Message Sequence | | TP | Verdict |
|---------|---|------------------|------------------------|----|---------|
| | | U - S | Message | | |
| 1 | The UE is switched ON | - | - | - | - |
| 2-3 | Steps 1-2 of the generic procedure for UE registration specified in TS 38.508-1 [4] table 4.5.2.2-3 are performed. | - | - | - | - |
| - | Exception: The UE establishes an IPsec tunnel in parallel to 5GC registration steps 4 to 8 as per the IKEv2 protocol as defined in 3GPP TS 23.502 [31] clause 4.12.2.2 figure 4.12.2.2-1. | - | - | - | - |
| 4 | Check: Does UE transmit a REGISTRATION REQUEST message including 5GS update type IE with SMS requested bit set to "SMS over NAS supported"? | --> | REGISTRATION REQUEST | 1 | P |
| 5 - 8 | Steps 4-5 of the generic procedure for UE registration specified in TS 38.508-1 [4] table 4.5.2.2-3 are performed. | - | - | - | - |
| 9 | SS transmits REGISTRATION ACCEPT message including 5GS registration result with SMS allowed bit set to "SMS over NAS allowed". | <-- | REGISTRATION ACCEPT | - | - |
| 10 - 12 | Steps 9-11 of the generic procedure for UE registration specified in TS 38.508-1 [4] table 4.5.2.2-3 are performed. | - | - | - | - |
| 13 | Sending of a 160 character MO SMS is initiated at the UE via MMI or AT command | - | - | - | - |
| 14 | UE transmits establishes a IPSEC SA and NAS signalling connection as per generic procedure in table 4.5A.4.2.2-1 of 38.508-1 [4]. | - | - | - | - |
| 15 | Check: Does the UE transmit a CP-DATA containing an RP-DATA RPDU (SMS SUBMIT TPDU) encapsulated in an Uplink NAS transport message? | --> | UPLINK NAS TRANSPORT | 2 | P |
| 16 | The SS transmits a CP-ACK encapsulated in a Downlink NAS Transport message. | <-- | DOWNLINK NAS TRANSPORT | - | - |
| 17 | The SS transmits a CP-DATA containing an RP-ACK RPDU encapsulated in a Downlink NAS transport message | <-- | DOWNLINK NAS TRANSPORT | - | - |

| | | | | | |
|----|---|-----|----------------------|---|---|
| 18 | Check: Does the UE transmit a CP-ACK encapsulated in an Uplink NAS Transport message? | --> | UPLINK NAS TRANSPORT | 3 | P |
|----|---|-----|----------------------|---|---|

9.2.8.1.3.3 Specific message contents

Table 9.2.8.1.3.3-1: REGISTRATION REQUEST (step 4, Table 9.2.8.1.3.2-1)

| Derivation path: TS 38.508-1 [4], Table 4.7.1-6 | | | |
|---|------------------------|---------|-----------|
| Information Element | Value/remark | Comment | Condition |
| 5GS registration type | | | |
| 5GS registration type value | '001'B | | INITIAL |
| 5GS update type | | | |
| SMS requested | SMS over NAS supported | | |

Table 9.2.8.1.3.3-2: REGISTRATION ACCEPT (step 9, Table 9.2.8.1.3.2-1)

| Derivation path: TS 38.508-1 [4], Table 4.7.1-7 | | | |
|---|----------------------|---------|-----------|
| Information Element | Value/remark | Comment | Condition |
| 5GS registration result | | | |
| SMS allowed | SMS over NAS allowed | | |
| T3512 value | | | |
| Timer value | '00011'B | | |
| Unit | '101'B | | |

Table 9.2.8.1.3.3-3: UL NAS TRANSPORT (step 15, Table 9.2.8.1.3.2-1)

| Derivation path: TS 38.508-1 [4], Table 4.7.1-10 | | | |
|--|--------------|--------------|-----------|
| Information Element | Value/remark | Comment | Condition |
| Payload container type | '0010'B | SMS | |
| Payload container | CP-DATA | RP-DATA RPDU | |

Table 9.2.8.1.3.3-3a: Message CP-DATA (step 15, Table 9.2.8.1.3.2-1)

| Information Element | Value/remark | Comment | Condition |
|---------------------|--------------|---------|-----------|
| CP-User data | RP-DATA | | |

Table 9.2.8.1.3.3-4: DL NAS TRANSPORT (step 16, Table 9.2.8.1.3.2-1)

| Derivation path: TS 38.508-1 [4], Table 4.7.1-11 | | | |
|--|--------------|---------|-----------|
| Information Element | Value/remark | Comment | Condition |
| Payload container type | '0010'B | SMS | |
| Payload container | CP-ACK | | |

Table 9.2.8.1.3.3-5: DL NAS TRANSPORT (step 17, Table 9.2.8.1.3.2-1)

| Derivation path: TS 38.508-1 [4], Table 4.7.1-11 | | | |
|--|--------------|-------------|-----------|
| Information Element | Value/remark | Comment | Condition |
| Payload container type | '0010'B | SMS | |
| Payload container | CP-DATA | RP-ACK RPDU | |

Table 9.2.8.1.3.3-5a: Message CP-DATA (step 17, Table 9.2.8.1.3.2-1)

| Information Element | Value/remark | Comment | Condition |
|---------------------|--------------|---------|-----------|
| CP-User data | RP-DATA | | |

Table 9.2.8.1.3.3-6: UL NAS TRANSPORT (step 18, Table 9.2.8.1.3.2-1)

| Derivation path: TS 38.508-1 [4], Table 4.7.1-10 | | | |
|--|--------------|---------|-----------|
| Information Element | Value/remark | Comment | Condition |
| Payload container type | '0010'B | SMS | |
| Payload container | CP-ACK | | |

9.3 Inter-system mobility

9.3.1 5GS-EPC Inter-system mobility

9.3.1.1 Inter-system mobility registration update / Single-registration mode with N26 / 5GMM-IDLE / 5GC to EPC

9.3.1.1.1 Test Purpose (TP)

(1)

```
with { UE in state 5GMM-REGISTERED and 5GMM-IDLE on a 5GC NR cell and has been previously registered
on EPC as well, UE supporting S1 and N1 and operating in single-registration mode, NWK supporting
Single-registration mode with N26 interface }
ensure that {
  when { UE detects a suitable EPC E-UTRA cell after the serving NGC cell becomes not suitable }
  then { UE performs a Inter-system change from N1 mode to S1 mode by initiating and successfully
completing a TAU procedure, mapped EPC context used }
}
```

9.3.1.1.2 Conformance requirements

References: The conformance requirements covered in the present TC are specified in: TS 24.501 [22], subclause 5.1.4.2; TS 24.301 [21], subclause 4.4.2.3. Unless otherwise stated these are Rel-15 requirements.

[TS 24.501, subclause 5.1.4.2]

At Inter-system change from N1 mode to S1 mode when there is at least one active PDU session for which interworking with EPS is supported as specified in subclause 6.1.4.1, the UE shall enter sub states EMM-REGISTERED.NORMAL-SERVICE and 5GMM-REGISTERED.NO-CELL-AVAILABLE and initiate a tracking area updating procedure (see 3GPP TS 24.301 [15]).

[TS 24.301, subclause 4.4.2.3]

During Inter-system change from N1 mode to S1 mode in 5GMM-IDLE mode, if the UE is operating in the single-registration mode and:

- 1) if the tracking area updating procedure is initiated as specified in 3GPP TS 24.501 [54], the UE shall transmit a TRACKING AREA UPDATE REQUEST message integrity protected with the current 5G NAS security context and the UE shall derive a mapped EPS security context (see subclause 8.6.1 of 3GPP TS 33.501 [56]). The UE shall include the eKSI indicating the 5G NAS security context value in the TRACKING AREA UPDATE REQUEST message.

After receiving the TRACKING AREA UPDATE REQUEST message including the eKSI, the MME forwards the TRACKING AREA UPDATE REQUEST message to the source AMF, if possible, to obtain the mapped EPS security context from the AMF as specified in 3GPP TS 33.501 [56]. The MME re-establishes the secure exchange of NAS messages by either:

- replying with a TRACKING AREA UPDATE ACCEPT message that is integrity protected and ciphered using the mapped EPS NAS security context. From this time onward, all NAS messages exchanged between the UE and the MME are sent integrity protected and except for the messages specified in subclause 4.4.5, all NAS messages exchanged between the UE and the MME are sent ciphered; or

9.3.1.1.3 Test description

9.3.1.1.3.1 Pre test conditions

System Simulator:

- 2 cells
- NGC Cell A as defined in TS 38.508-1 [4] Table 6.3.2.2-1. System information combination NR-6 as defined in TS 38.508-1 [4], subclause 4.4.3.1.2.
- E-UTRA Cell A as defined in TS 36.508 [7] Table 6.3.2.2-1. System information combination 31 as defined in TS 36.508 [7], subclause 4.4.3.1.1.

UE:

- None.

Preamble:

- With E-UTRA Cell A "Serving cell" and NGC Cell A "Non-suitable "Off" cell", the UE is brought to state RRC_IDLE Connectivity (*E-UTRA/EPC*) in accordance with the procedure described in TS 38.508-1 [4], Table 4.5.2.2-1. 4G GUTI and eKSI are assigned and security context established
- the UE is switched-off
- With NGC Cell A "Serving cell" and E-UTRA Cell A "Non-suitable "Off" cell", the UE is brought to state IN-A, RRC_IDLE Connectivity (NR), in accordance with the procedure described in TS 38.508-1 [4], Table 4.5.2.2-2. 5G-GUTI and ngKSI are assigned and security context established.

9.3.1.1.2 Test procedure sequence

Table 9.3.1.1.3.2-1: Main behaviour

| St | Procedure | Message Sequence | | TP | Verdict |
|----|--|------------------|---------|----|---------|
| | | U - S | Message | | |
| 1 | The SS configures:
- E-UTRA Cell A as "Serving cell"
- NGC Cell A as "Non-suitable "off" cell". | - | - | - | - |
| 2 | Check: Does the UE perform on the E-UTRA Cell A the TAU procedure for Inter-system change from N1 mode to S1 mode in 5GMM/EMM-IDLE mode as described in TS 38.508-1 [4], Table 4.9.7.2.2-1, 'connected without release'? | - | - | 1 | - |

9.3.1.1.3.3 Specific message contents

None.

9.3.1.2 Inter-system mobility registration update / Single-registration mode with N26 / 5GMM-IDLE / EPC to 5GC

9.3.1.2.1 Test Purpose (TP)

(1)

```
with { UE in state EMM-REGISTERED and EMM-IDLE on an E-UTRA cell and has been previously registered
on 5GC, UE supporting S1 and N1 and operating in single-registration mode, NWK supporting Single-
registration mode with N26 interface }
ensure that {
  when { UE detects a suitable NGC cell after the serving E-UTRA cell becomes not suitable }
}
```

```

    then { UE performs a Inter-system change from S1 mode to N1 mode by initiating and successfully
    completing a mobility and periodic registration update procedure, mapped 5G context used }
    }

```

9.3.1.2.2 Conformance requirements

References: The conformance requirements covered in the present TC are specified in: TS 24.501 [22], subclauses 4.4.2.1, 4.4.2.5, 5.1.4.2, 5.5.1.3.2; TS 24.301 [21], subclause 5.5.5. Unless otherwise stated these are Rel-15 requirements.

[TS 24.501, subclause 4.4.2.1]

Before security can be activated, the AMF and the UE need to establish a 5G NAS security context. Usually, the 5G NAS security context is created as the result of a primary authentication and key agreement procedure between the AMF and the UE. A new 5G NAS security context may also be created during an N1 mode to N1 mode handover. Alternatively, during inter-system change from S1 mode to N1 mode, the AMF not supporting interworking without N26 and the UE operating in single-registration mode may derive a mapped 5G NAS security context from an EPS security context that has been established while the UE was in S1 mode.

...

The key set identifier ngKSI is assigned by the AMF either during the primary authentication and key agreement procedure or, for the mapped 5G NAS security context, during the inter-system change. The ngKSI consists of a value and a type of security context parameter indicating whether a 5G NAS security context is a native 5G NAS security context or a mapped 5G NAS security context. When the 5G NAS security context is a native 5G NAS security context, the ngKSI has the value of KSI_{AMF}, and when the current 5G NAS security context is of type mapped, the ngKSI has the value of KSI_{ASME}.

The 5G NAS security context which is indicated by an ngKSI can be taken into use to establish the secure exchange of NAS messages when a new N1 NAS signalling connection is established without executing a new primary authentication and key agreement procedure (see subclause 5.4.1) or when the AMF initiates a security mode control procedure. For this purpose, the initial NAS messages (i.e. REGISTRATION REQUEST, DEREGISTRATION REQUEST, SERVICE REQUEST and CONTROL PLANE SERVICE REQUEST) and the SECURITY MODE COMMAND message contain an ngKSI in the NAS key set identifier IE indicating the current 5G NAS security context used to integrity protect the NAS message.

[TS 24.501, subclause 4.4.2.5]

Secure exchange of NAS messages via a NAS signalling connection is usually established by the AMF during the registration procedure by initiating a security mode control procedure. After successful completion of the security mode control procedure, all NAS messages exchanged between the UE and the AMF are sent integrity protected using the current 5G security algorithms, and except for the messages specified in subclause 4.4.5, all NAS messages exchanged between the UE and the AMF are sent ciphered using the current 5G security algorithms.

...

During inter-system change from S1 mode to N1 mode in 5GMM-IDLE mode, if the UE is operating in single-registration mode and:

- ..b) if the UE has no valid native 5G NAS security context, the UE shall send the REGISTRATION REQUEST message without integrity protection and encryption.

After receiving the REGISTRATION REQUEST message without integrity protection and encryption:

- 1) if N26 interface is supported:
 - i) if an EPS security context received from the source MME does not include the NAS security algorithms set to EIA0 and EEA0, the AMF shall either create a fresh mapped 5G NAS security context (see subclause 8.6.2 of 3GPP TS 33.501 [24]) or trigger a primary authentication and key agreement procedure to create a fresh native 5G NAS security context; or

...

The newly created 5G NAS security context is taken into use by initiating a security mode control procedure and this context becomes the current 5G NAS security context in both the UE and the AMF. This re-establishes the secure exchange of NAS messages.

[TS 24.501, subclause 5.1.4.2]

At inter-system change from S1 mode to N1 mode, the UE shall enter sub states 5GMM-REGISTERED.NORMAL-SERVICE and EMM-REGISTERED.NO-CELL-AVAILABLE and initiate a registration procedure for mobility and periodic registration update indicating "mobility registration updating" in the 5GS registration type IE of the REGISTRATION REQUEST message (see subclause 5.5.1.3).

[TS 24.501, subclause 5.5.1.3.2]

The UE in state 5GMM-REGISTERED shall initiate the registration procedure for mobility and periodic registration update by sending a REGISTRATION REQUEST message to the AMF,

...

e) upon Inter-system change from S1 mode to N1 mode;

...

If case b) is the only reason for initiating the registration procedure for mobility and periodic registration update, the UE shall indicate "periodic registration updating" in the 5GS registration type IE; otherwise the UE shall indicate "mobility registration updating".

If the UE indicates "mobility registration updating" in the 5GS registration type IE and the UE supports S1 mode, the UE shall:

- set the S1 mode bit to "S1 mode supported" in the 5GMM capability IE of the REGISTRATION REQUEST message;
- include the S1 UE network capability IE in the REGISTRATION REQUEST message; and
- if the UE supports sending an ATTACH REQUEST message containing a PDN CONNECTIVITY REQUEST message with request type set to "handover" to transfer a PDU session from N1 mode to S1 mode, set the HO attach bit to "attach request message containing PDN connectivity request with request type set to handover to transfer PDU session from N1 mode to S1 mode supported" in the 5GMM capability IE of the REGISTRATION REQUEST message.

...

If the last visited registered TAI is available, the UE shall include the last visited registered TAI in the REGISTRATION REQUEST message.

The UE shall handle the 5GS mobility identity IE in the REGISTRATION REQUEST message as follows:

- a) if the UE is operating in the single-registration mode, performs Inter-system change from S1 mode to N1 mode, and the UE holds a valid 4G-GUTI, the UE shall include the 5G-GUTI mapped from the 4G-GUTI as specified in 3GPP TS 23.003 [4] in the 5GS mobility identity IE. Additionally, if the UE holds a valid 5G-GUTI, the UE shall include the 5G-GUTI in the Additional GUTI IE in the REGISTRATION REQUEST message in the following order:
 - 1) a valid 5G-GUTI that was previously assigned by the same PLMN with which the UE is performing the registration, if available;
 - 2) a valid 5G-GUTI that was previously assigned by an equivalent PLMN, if available; and
 - 3) a valid 5G-GUTI that was previously assigned by any other PLMN, if available; and

...

If the UE operating in the single-registration mode performs Inter-system change from S1 mode to N1 mode, the UE:

- a) shall include the UE status IE with the EMM registration status set to "UE is in EMM-REGISTERED state" in the REGISTRATION REQUEST message;

NOTE 1: Inclusion of the UE status IE with this setting corresponds to the indication that the UE is "moving from EPC" as specified in 3GPP TS 23.502 [9], subclause 4.11.1.3.3 and 4.11.2.3.

- b) may include the PDU session status IE in the REGISTRATION REQUEST message indicating the status of the PDU session(s) mapped during the Inter-system change from S1 mode to N1 mode from the PDN connection(s) for which the EPS indicated that interworking to 5GS is supported, if any (see subclause 6.1.4.1); and
- c) shall include a TRACKING AREA UPDATE REQUEST message as specified in 3GPP TS 24.301 [15] in the IE in the REGISTRATION REQUEST message.

...

The UE shall send the REGISTRATION REQUEST message including the NAS message container IE as described in subclause 4.4.6:

...

- b) when the UE is sending the message after an Inter-system change from S1 mode to N1 mode in 5GMM-IDLE mode and the UE has a valid 5G NAS security context and needs to send non-clear-text IEs.

[TS 24.301, subclause 5.5.5]

The tracking area updating procedure is used to construct a TRACKING AREA UPDATE REQUEST message for the inter-system change from S1 mode to N1 mode for further security verification by the MME.

The TRACKING AREA UPDATE REQUEST message is created by EMM by request of 5GMM which further includes the message in the REGISTRATION REQUEST message as described in 3GPP TS 24.501 [54].

The TRACKING AREA UPDATE REQUEST message shall contain only mandatory information elements.

The UE shall set the EPS update type IE in the TRACKING AREA UPDATE REQUEST message to "TA updating".

If the UE has a current EPS security context, the UE shall include the eKSI (either KSI_{ASME} or KSI_{SGSN}) in the NAS Key Set Identifier IE in the TRACKING AREA UPDATE REQUEST message. Otherwise, the UE shall set the NAS Key Set Identifier IE to the value "no key is available". If the UE has a current EPS security context, the UE shall integrity protect the TRACKING AREA UPDATE REQUEST message with the current EPS security context and increase the uplink NAS COUNT by one. Otherwise the UE shall not integrity protect the TRACKING AREA UPDATE REQUEST message. The UE shall set associated GUTI in the Old GUTI IE.

When the UE is in EMM-REGISTERED.NO-CELL-AVAILABLE substate and needs to construct the TRACKING AREA UPDATE REQUEST message for inter-system change from S1 mode to N1 mode, the UE shall consider that the tracking area updating procedure is not initiated and the UE shall remain in EMM-REGISTERED.NO-CELL-AVAILABLE state.

9.3.1.2.3 Test description

9.3.1.2.3.1 Pre test conditions

System Simulator:

- 2 cells
 - NGC Cell A as defined in TS 38.508-1 [4] Table 6.3.2.2-1. System information combination NR-6 as defined in TS 38.508-1 [4], subclause 4.4.3.1.2.
 - E-UTRA Cell A as defined in TS 36.508 [7] Table 6.3.2.2-1. System information combination 31 as defined in TS 36.508 [7], subclause 4.4.3.1.1.

UE:

None.

Preamble:

- With NGC Cell A "Serving cell" and E-UTRA Cell A "Non-suitable "Off" cell", the UE is switched on and when it initiates the initial registration procedure then it is rejected as specified in subclause 4.9.8 Procedure for Registration Reject. This is made to ensure that the UE does not have a valid native 5G NAS security context for the rest of the test case.
- the UE is switched-off
- With E-UTRA Cell A "Serving cell" and NGC Cell A "Non-suitable "Off" cell", the UE is brought to state RRC_IDLE Connectivity (*E-UTRA/EPC*) in accordance with the procedure described in TS 38.508-1 [4], Table 4.5.2.2-5. 4G GUTI and eKSI are assigned and security context established

9.3.1.2.3.2 Test procedure sequence

Table 9.3.1.2.3.2-1: Main behaviour

| St | Procedure | Message Sequence | | TP | Verdict |
|----|---|------------------|---------|----|---------|
| | | U - S | Message | | |
| 1 | The SS configures:
- NGC Cell A as "Serving cell"
- E-UTRA Cell A as "Non-suitable "off" cell". | - | - | - | - |
| 2 | Check: Does the UE perform on the NGC Cell A the Test procedure for UE Tracking area updating for Inter-system change from S1 mode to N1 mode in 5GMM/EMM-IDLE mode as described in TS 38.508-1 [4], Table 4.9.9.2.2-1 with the exception that the SS does not initiate the primary authentication and key agreement procedure described in steps 4-5 (NOTE 1), ' <i>connected without release</i> '? | - | - | 1 | - |

NOTE 1: This is required to allow for the verification of the UE using mapped 5GC context as per TP1.

9.3.1.2.3.3 Specific message contents

Table 9.3.1.2.3.3-1: REGISTRATION REQUEST (Preamble; TS 38.508-1 [4], Table 4.5.2.2-2)

| Derivation Path: TS 38.508-1 [4], Table 4.7.1-6 | | | |
|---|--------------|--|-----------|
| Information Element | Value/remark | Comment | Condition |
| 5GMM capability | '0000 0xx1' | S1 mode supported

x - not checked | |
| S1 UE network capability | | | |
| All octets with the exception of octet 9, bit 6 | Not checked | | |
| N1 mode supported (N1 mode) (octet 9, bit 6) | '1' | N1 mode supported | |

Table 9.3.1.2.3.3-2: REGISTRATION REJECT (Preamble; step 8, TS 38.508-1 [4], Table 4.9.8.2.2-1)

| Derivation path: TS 38.508-1 [4], Table 4.9.8.2.3-1 | | | |
|---|--------------|------------|-----------|
| Information Element | Value/remark | Comment | Condition |
| 5GMM cause | '0000 0011'B | Illegal UE | |

Table 9.3.1.2.3.3-3: Message ATTACH REQUEST (Preamble; step 4, TS 38.508-1 [4], Table 4.5.2.2-5)

| Derivation Path: TS 36.508 [7], Table 4.7.2-4 with condition NR | | | |
|---|-------------------|--|-----------|
| Information Element | Value/remark | Comment | Condition |
| NAS key set identifier | | | |
| NAS key set identifier | '111'B | no key is available | |
| TSC | Any allowed value | TSC does not apply for NAS key set identifier value "111". | |
| Old GUTI or IMSI | IMSI1 | | |
| Last visited registered TAI | Not present | | |

Table 9.3.1.2.3.3-4: REGISTRATION REQUEST (step 2, Table 9.3.1.2.3.2-1; step 1, TS 38.508-1 [4] Table 4.9.9.2.2-1)

| Derivation Path: TS 38.508-1 [4], Table 4.7.1-6 with condition Not_Registered_Previously_on_5GCN. |
|---|
|---|

Table 9.3.1.2.3.3-5: TRACKING AREA UPDATE REQUEST (9.3.1.2.3.3-3)

| Derivation path: TS 38.508-1 [4], Table 4.9.9.2.3-2 | | | |
|---|---|---------------------------------------|-----------|
| Information Element | Value/remark | Comment | Condition |
| NAS key set identifier | | | |
| NAS key set identifier | the eKSI for the current EPS security context | | |
| TSC | '0'B | native (current) EPS security context | |

Table 9.3.1.2.3.3-6: SECURITY MODE COMMAND (step 2, Table 9.3.1.2.3.2-1; step 6, TS 38.508-1 [4] Table 4.9.9.2.2-1)

| Derivation Path: TS 38.508-1 [4], Table 4.7.1-25. | | | |
|---|---|--|-----------|
| Information Element | Value/remark | Comment | Condition |
| ngKSI | | | |
| NAS key set identifier | KSI _{ASME} that was created when the UE last registered to EPS | | |
| TSC | '1'B | mapped security context (for KSI _{ASME}) | |

9.3.1.3 Inter-system mobility and periodic registration update / Rejected / Single-registration mode with N26 / Handling of EPC relevant parameters

9.3.1.3.1 Test Purpose (TP)

(1)

```

with { UE in state 5GMM-REGISTERED on an NGC cell, UE supporting S1 and N1 and operating in single-
registration mode, NWK supporting Single-registration mode with N26 interface }
ensure that {
  when { UE initiates a Mobility and periodic registration procedure on an NGC cell and receives a
REGISTRATION REJECT message including 5GMM cause value #9 (UE identity cannot be derived by the
network) }
  then { UE deletes the EPS relevant parameters 4G-GUTI, last visited registered TAI and eKSI and
enters the state EMM-DEREGISTERED, and, subsequently, when it finds a suitable E-UTRA cell it moves
to it and automatically initiates an attach procedure }
}

```

9.3.1.3.2 Conformance requirements

References: The conformance requirements covered in the present TC are specified in: TS 24.501 [22], subclause 5.5.1.3.5, TS 24.301 [21], clause 5.5.3.2.5. Unless otherwise stated these are Rel-15 requirements.

[TS 24.501, subclause 5.5.1.3.5]

If the mobility and periodic registration update request cannot be accepted by the network, the AMF shall send a REGISTRATION REJECT message to the UE including an appropriate 5GMM cause value.

The UE shall take the following actions depending on the 5GMM cause value received in the REGISTRATION REJECT message.

...

#9 (UE identity cannot be derived by the network).

...

If the UE is operating in single-registration mode, the UE shall handle the EMM parameters EMM state, EPS update status, 4G-GUTI, last visited registered TAI, TAI list and eKSI as specified in 3GPP TS 24.301 [15] for the case when the normal tracking area updating procedure is rejected with the EMM cause with the same value.

[TS 24.301, subclause 5.5.3.2.5]

If the tracking area updating cannot be accepted by the network, the MME sends a TRACKING AREA UPDATE REJECT message to the UE including an appropriate EMM cause value.

...

#9 (UE identity cannot be derived by the network);

The UE shall set the EPS update status to EU2 NOT UPDATED (and shall store it according to subclause 5.1.3.3) and shall delete any GUTI, last visited registered TAI, TAI list and eKSI. The UE shall enter the state EMM-DEREGISTERED.

If the rejected request was not for initiating a PDN connection for emergency bearer services, the UE shall subsequently, automatically initiate the attach procedure.

9.3.1.3.3 Test description

9.3.1.3.3.1 Pre test conditions

System Simulator:

- 2 cells
- NGC Cell A as defined in TS 38.508-1 [4] Table 6.3.2.2-1. System information combination NR-6 as defined in TS 38.508-1 [4], subclause 4.4.3.1.2.
- E-UTRA Cell A as defined in TS 36.508 [7] Table 6.3.2.2-1. System information combination 31 as defined in TS 36.508 [7], subclause 4.4.3.1.1.

UE:

None.

Preamble:

- With E-UTRA Cell A "Serving cell" and NGC Cell A "Non-suitable "Off" cell", the UE is brought to state RRC_IDLE Connectivity (*E-UTRA/EPC*) in accordance with the procedure described in TS 38.508-1 [4], Table 4.5.2.2-1. 4G GUTI and eKSI are assigned and security context established
- the UE is switched-off

- With NGC Cell A "Serving cell" and E-UTRA Cell A "Non-suitable "Off" cell", the UE is brought to state 1N-A, RRC_IDLE Connectivity (NR), in accordance with the procedure described in TS 38.508-1 [4], Table 4.5.2.2-2. 5G-GUTI and ngKSI are assigned and security context established.

9.3.1.3.3.2 Test procedure sequence

Table 9.3.1.3.3.2-1: Main behaviour

| St | Procedure | Message Sequence | | TP | Verdict |
|----|--|------------------|----------------------|----|---------|
| | | U - S | Message | | |
| 1 | Wait for 25 seconds (expiry of T3512 periodic registration update timer, the value of 30 sec is provided during the initial registration in the Preamble). | - | - | - | - |
| 2 | The UE transmit a REGISTRATION REQUEST message with the 5GS registration type IE indicating "periodic registration updating". | --> | REGISTRATION REQUEST | - | - |
| 3 | The SS configures:
- E-UTRA Cell A "Suitable neighbour inter-frequency cell". | - | - | - | - |
| 4 | The SS transmits a REGISTRATION REJECT message including 5GMM cause value #9 (UE identity cannot be derived by the network). | <-- | REGISTRATION REJECT | - | - |
| 4A | The SS configures:
- NGC Cell A as "Non-Suitable "Off" cell". | - | - | - | - |
| 5 | Check: Does the UE perform on the E-UTRA Cell A an attach procedure as described in TS 38.508-1 [4], Table 4.5.2.2-1? The UE does not provide 4G-GUTI or 4G eKSI; nor last visited registered TAI. | - | - | 1 | - |

9.3.1.3.3.3 Specific message contents

Table 9.3.1.3.3.3-1: REGISTRATION ACCEPT (Preamble; TS 38.508-1 [4] Table 4.5.2.2-2)

| Derivation path: TS 38.508-1 [4], Table 4.7.1-7. | | | |
|--|--------------|---|-----------|
| Information Element | Value/remark | Comment | Condition |
| T3512 value | | | |
| Unit | '100'B | value is incremented in multiples of 30 seconds | |
| Timer value | '0 0001'B | 30 seconds | |

Table 9.3.1.3.3.3-2: REGISTRATION REQUEST (step 2, Table 9.3.1.3.3.2-1)

| Derivation Path: TS 38.508-1 [4], Table 4.7.1-6. | | | |
|--|--|---|-----------|
| Information Element | Value/remark | Comment | Condition |
| 5GS registration type | '00xxx011' | periodic registration updating

x - not checked | |
| ngKSI | Active ngKSI assigned in the Preamble | | |
| 5GS mobile identity | Active 5G-GUTI assigned in the Preamble | | |
| Last visited registered TAI | The TAI of the NGC Cell A, see TS 38.508-1 [4] Table 6.3.2.2-1 | | |

Table 9.3.1.3.3.3-3: REGISTRATION REJECT (step 4, Table 9.3.1.3.3.2-1)

| Derivation Path: TS 38.508-1 [4], Table 4.7.1-9. | | | |
|--|--------------|---|-----------|
| Information Element | Value/remark | Comment | Condition |
| 5GMM cause | '0000 1001'B | #9 - UE identity cannot be derived by the network | |

Table 9.3.1.3.3.3-4: ATTACH REQUEST (step 5, Table 9.3.1.3.3.2-1; step 5, TS 38.508-1 [4] Table 4.5.2.2-1)

| Derivation Path: TS 36.508 [7], Table 4.7.2-4. | | | |
|--|--------------|---------------------|-----------|
| Information Element | Value/remark | Comment | Condition |
| NAS key set identifier | '111' | no key is available | |
| EPS mobile identity | IMSI | | |
| Old P-TMSI signature | Not present | | |
| Last visited registered TAI | Not present | | |
| Old location area identification | Not checked | | |
| Old GUTI type | Not present | | |

10 Session management

10.1 5GS session management

Editor's note: Intended to capture tests of 5G Core Network behaviour defined in TS 24.301, TS 24.501 et.al. (TR 24.890).

FFS.

10.1.1 PDU session authentication and authorization

10.1.1.1 PDU session authentication and authorization / during the UE-requested PDU session procedure

10.1.1.1.1 Test Purpose (TP)

(1)

```
with { UE is establishing UE-requested PDU session by sending PDU Session establishment Request message }
ensure that {
  when { UE receives a PDU SESSION AUTHENTICATION COMMAND message }
  then { UE transmits a PDU SESSION AUTHENTICATION COMPLETE message }
}
```

(2)

```
with { PDU session authentication and authorization procedure is performed during the UE-requested PDU session establishment procedure }
ensure that {
  when { UE receives EAP-failure message in the PDU SESSION ESTABLISHMENT REJECT message }
  then { UE consider that the PDU session is not established }
}
```

(3)

```
with { PDU session authentication and authorization procedure is performed during the UE-requested PDU session establishment procedure }
ensure that {
```

```
when { UE receives EAP-success message in the PDU SESSION ESTABLISHMENT ACCEPT message }
  then { UE consider that the PDU session is established }
}
```

10.1.1.1.2 Conformance requirements

References: The conformance requirements covered in the present TC are specified in: TS 24.501, clause 6.3.1.2.1, 6.3.1.2.2 and 6.4.1.4. Unless otherwise stated these are Rel-15 requirements.

[TS 24.501 clause 6.3.1.2.1]

In order to initiate the PDU EAP message reliable transport procedure, the SMF shall create a PDU SESSION AUTHENTICATION COMMAND message.

The SMF shall set the PTI IE of the PDU SESSION AUTHENTICATION COMMAND message to "No procedure transaction identity assigned".

The SMF shall set the EAP message IE of the PDU SESSION AUTHENTICATION COMMAND message to the EAP-request message provided by the DN or generated locally.

The SMF shall send the PDU SESSION AUTHENTICATION COMMAND message, and the SMF shall start timer T3590 (see example in figure 6.3.1.1).

Upon receipt of a PDU SESSION AUTHENTICATION COMMAND message and a PDU session ID, using the NAS transport procedure as specified in subclause 5.4.5, the UE passes to the upper layers the EAP message received in the EAP message IE of the PDU SESSION AUTHENTICATION COMMAND message. Apart from this action, the authentication and authorization procedure initiated by the DN is transparent to the 5GSM layer of the UE.

[TS 24.501 clause 6.3.1.2.2]

When the upper layers provide an EAP-response message responding to the received EAP-request message, the UE shall create a PDU SESSION AUTHENTICATION COMPLETE message.

The UE shall set the EAP message IE of the PDU SESSION AUTHENTICATION COMPLETE message to the EAP-response message.

The UE shall transport the PDU SESSION AUTHENTICATION COMPLETE message and the PDU session ID, using the NAS transport procedure as specified in subclause 5.4.5. Apart from this action, the authentication and authorization procedure initiated by the DN is transparent to the 5GSM layer of the UE.

Upon receipt of a PDU SESSION AUTHENTICATION COMPLETE message, the SMF shall stop timer T3590 and provides the EAP message received in the EAP message IE of the PDU SESSION AUTHENTICATION COMPLETE message to the DN or handles it locally.

[TS 24.501 clause 6.4.1.4]

If the connectivity with the requested DN is rejected by the network, the SMF shall create a SM PDU SESSION ESTABLISHMENT REJECT message.

The SMF shall set the 5GSM cause IE of the PDU SESSION ESTABLISHMENT REJECT message to indicate the reason for rejecting the PDU session establishment.

The 5GSM cause IE typically indicates one of the following SM cause values:

- #8 operator determined barring;
- #26 insufficient resources;
- #27 missing or unknown DNN;
- #28 unknown PDU session type;
- #29 user authentication or authorization failed;

10.1.1.1.3 Test description

10.1.1.1.3.1 Pre-test conditions

System Simulator:

NGC Cell A

UE:

None.

Preamble:

The UE is in state 1N-A with PDU session Active state using the generic procedure NR RRC_IDLE according to TS 38.508-1 [4].

10.1.1.1.3.2 Test procedure sequence

Table 10.1.1.1.3.2-1: Main behaviour

| St | Procedure | Message Sequence | | TP | Verdict |
|--------|---|------------------|---|----|---------|
| | | U - S | Message | | |
| 1 | Cause the UE to request connectivity to an additional PDU session. (see Note 1) | - | - | - | - |
| 2-2A | Steps 2-3 of the generic procedure for NR RRC_Connected specified in TS 38.508-1 Table 4.5.4.2-3 are performed. | - | - | - | - |
| 2B | The UE transmits an <i>RRCSetupComplete</i> message and a SERVICE REQUEST message with service type IE set to "signalling". | --> | SERVICE REQUEST | - | - |
| 3-3A | Steps 5 and 6 of the generic procedure for NR RRC_Connected specified in TS 38.508-1 Table 4.5.4.2-3 are performed. | - | - | - | - |
| 4 | The SS transmits an <i>RRCReconfiguration</i> message and a SERVICE ACCEPT message to establish SRB2 and DRB. | <-- | NR RRC: RRCReconfiguration
5GMM: SERVICE ACCEPT | - | - |
| 4A | The UE transmits an <i>RRCReconfigurationComplete</i> message. | --> | NR RRC:
<i>RRCReconfigurationComplete</i> | - | - |
| 5 | The UE transmits a PDU SESSION ESTABLISHMENT REQUEST message to request an additional PDU session.

Note: PDU SESSION ESTABLISHMENT REQUEST is included in UL NAS transport. UL NAS transport message is included in dedicatedNAS-Message of <i>ULInformationTransfer</i> message. DNN information is included in UL NAS transport message. | --> | 5GMM: UL NAS TRANSPORT
5GSM: PDU SESSION ESTABLISHMENT REQUEST | - | - |
| 6 | The SS transmits PDU SESSION AUTHENTICATION COMMAND including an EAP-Request message. | <-- | PDU SESSION AUTHENTICATION COMMAND | | |
| 7 | Check: Does the UE transmit a PDU SESSION AUTHENTICATION COMPLETE containing EAP-Response message? | --> | PDU SESSION AUTHENTICATION COMPLETE | 1 | P |
| 8 | The SS transmits PDU SESSION ESTABLISHMENT REJECT message with 5GSM cause #29 including an EAP-Failure message. | <-- | PDU SESSION ESTABLISHMENT REJECT | | |
| 9 | The SS releases the RRC connection. | - | - | - | - |
| 10 | Cause the UE to request connectivity to an additional PDU session. (see Note 1) | - | - | - | - |
| 11-11A | Steps 2-3 of the generic procedure for NR RRC_Connected specified in TS 38.508-1 Table 4.5.4.2-3 are performed. | - | - | - | - |
| 11B | The UE transmits an <i>RRCSetupComplete</i> message and a SERVICE REQUEST message with service type IE set to "signalling". | --> | SERVICE REQUEST | - | - |
| 12-12A | Steps 5 and 6 of the generic procedure for NR RRC_Connected specified in TS 38.508-1 Table 4.5.4.2-3 are performed. | - | - | - | - |
| 13 | The SS transmits an <i>RRCReconfiguration</i> message and a SERVICE ACCEPT message to establish SRB2 and DRB. | <-- | NR RRC: RRCReconfiguration
5GMM: SERVICE ACCEPT | - | - |
| 13A | The UE transmits an <i>RRCReconfigurationComplete</i> message. | --> | NR RRC:
<i>RRCReconfigurationComplete</i> | - | - |
| 14 | The UE transmits a PDU SESSION ESTABLISHMENT REQUEST message to request an additional PDU session.

Note: PDU SESSION ESTABLISHMENT | --> | 5GMM: UL NAS TRANSPORT
5GSM: PDU SESSION ESTABLISHMENT REQUEST | 2 | P |

| | | | | | |
|--|---|-----|-------------------------------------|---|---|
| | REQUEST is included in UL NAS transport. UL NAS transport message is included in dedicatedNAS-Message of <i>ULInformationTransfer</i> message
DNN information is included in UL NAS transport message. | | | | |
| 15 | The SS transmits PDU SESSION AUTHENTICATION COMMAND including an EAP-Request message. | <-- | PDU SESSION AUTHENTICATION COMMAND | | |
| 16 | Check: Does the UE transmit a PDU SESSION AUTHENTICATION COMPLETE containing EAP-Response message? | --> | PDU SESSION AUTHENTICATION COMPLETE | - | - |
| 17 | The SS transmits <i>RRCReconfiguration</i> message containing PDU SESSION ESTABLISHMENT ACCEPT message containing an EAP-Success message. | <-- | PDU SESSION ESTABLISHMENT ACCEPT | | |
| 18 | The UE transmits <i>RRCReconfigurationComplete</i> message to confirm the establishment of DRB. | - | - | 3 | P |
| - | EXCEPTION: Step 19a1 describes behaviour depending UE implementation; the "lower case letter" identifies a step sequence that take place if the UE performs a specific action. | - | - | - | - |
| 19a
1 | If initiated by the UE, the generic procedure for IP address allocation in the user plane, specified in subclause 4.5.6, takes place performing IP address allocation in the user plane. | - | - | - | - |
| 20 | The SS releases the RRC connection. | - | - | - | - |
| Note 1: The request of connectivity to an additional PDU session may be performed by MMI or AT command +CGACT. | | | | | |

10.1.1.1.3.3 Specific message contents

Table 10.1.1.1.3.3-1: SERVICE REQUEST (step 2B and 11B, Table 10.1.1.1.3.2-1)

| Derivation path: TS 38.508-1 [4], Table 4.7.1-16 | | | |
|--|-----------------|--|-----------|
| Information Element | Value/remark | Comment | Condition |
| Service type | '0000'B | signalling | |
| PDU session status | PDU session IDs | PDU session IDs of the ACTIVE PDU session established during Preamble. | |

Table 10.1.1.1.3.3-2: SERVICE ACCEPT (step 4 and 13, Table 10.1.1.1.3.2-1)

| Derivation path: TS 38.508-1 [4], Table 4.7.1-17 | | | |
|--|-----------------|--|-----------|
| Information Element | Value/remark | Comment | Condition |
| PDU session status | PDU session IDs | PDU session IDs of the ACTIVE PDU session established during Preamble. | |

Table 10.1.1.1.3.3-3: PDU SESSION ESTABLISHMENT REQUEST (step 5 and 14, Table 10.1.1.1.3.2-1)

| Derivation path: TS 38.508-1 [4], Table 4.7.2-1 | | | |
|---|--------------|--|-----------|
| Information Element | Value/remark | Comment | Condition |
| PDU session ID | PSI-1 | UE assigns a particular PSI not yet used between 1 and 15 | |
| PTI | PTI-1 | UE assigns a particular PTI not yet used between 1 and 254 | |

Table 10.1.1.1.3.3-4: UL NAS Transport (step 5 and 14, Table 10.1.1.1.3.2-1)

| Derivation path: TS 38.508-1 [4], Table 4.7.1-10 | | | |
|--|----------------------|--|-----------|
| Information Element | Value/remark | Comment | Condition |
| Payload container type | '0001'B | N1 SM information | |
| PDU session ID | PSI-1 | | |
| Request type | '001'B | Initial request | |
| S-NSSAI | Not Present | | |
| DNN | DNN-1 (New DNN name) | The requested DNN is different from default DNN. | |

Table 10.1.1.1.3.3-5: PDU SESSION ESTABLISHMENT REJECT (step 8, Table 10.1.1.1.3.2-1)

| Derivation path: TS 38.508-1 [4], Table 4.7.2-3 | | | |
|---|--------------|---|-----------|
| Information Element | Value/remark | Comment | Condition |
| PDU session ID | PSI-1 | | |
| PTI | PTI-1 | | |
| 5GSM cause | '00011 101' | User authentication or authorization failed | |

Table 10.1.1.1.3.3-6: PDU SESSION ESTABLISHMENT ACCEPT (step 17, Table 10.1.1.1.3.2-1)

| Derivation path: TS 38.508-1 [4], Table 4.7.2-2 | | | |
|---|---------------------|---------------------------------------|-----------|
| Information Element | Value/remark | Comment | Condition |
| PDU session ID | PSI-1 | | |
| PTI | PTI-1 | | |
| Authorized QoS rules | | | |
| QoS rule | | | |
| QoS rule identifier | '0000 0001'B | | |
| Rule operation code | '001'B | Create new QoS rule | |
| DQR bit | '1'B | The QoS rule is the default QoS rule. | |
| Number of packet filters | '0001'B | 1 packet filter | |
| Packet filter list | See table 4.8.2.1-1 | Packet filter list #1 | |
| Packet filter direction | '11'B | bidirectional | |
| Packet filter identifier | '0000'B | Id 0 | |
| Component type 1 ID | '0000 0001'B | Match-all type | |
| QoS rule precedence | '0000 0000'B | 0 | |
| QoS flow identifier (QFI) | '00 0011'B | QFI 3 | |
| EAP message | | | |
| QoS flow description | | | |
| QFI | '00 0011'B | QFI 3 | |
| Operation code | '001'B | Create new QoS flow description | |
| E bit | '1'B | Parameters list is included | |
| Number of parameters | '00 0001'B | 1 parameters | |
| 5QI | '0000 1001'B | 5QI 9 | |
| DNN | DNN-1 | | |

10.1.1.2 PDU session authentication and authorization / after the UE-requested PDU session procedure

10.1.1.2.1 Test Purpose (TP)

(1)

```
with { the UE is in 5GMM-REGISTERED state with an established PDU session }
ensure that {
  when { UE receives a PDU SESSION AUTHENTICATION COMMAND message }
  then { UE transmits a PDU SESSION AUTHENTICATION COMPLETE message }
}
```

(2)

```
with { PDU session authentication and authorization procedure is performed after the UE-requested
PDU session establishment procedure }
ensure that {
  when { UE receives EAP-failure message in the PDU SESSION RELEASE COMMAND message }
  then { the 5GSM state of the UE is PDU SESSION INACTIVE state }
}
```

(3)

```
with { PDU session authentication and authorization procedure is performed after the UE-requested
PDU session establishment procedure }
ensure that {
  when { UE receives EAP-success message in the PDU SESSION AUTHENTICATION RESULT message }
  then { the 5GSM state of the UE is PDU SESSION ACTIVE state }
}
```

10.1.1.2.2 Conformance requirements

References: The conformance requirements covered in the present TC are specified in: TS 24.501, clause 6.3.1.1, clause 6.3.1.2.1, 6.3.1.2.2 and 6.3.1.3.1. Unless otherwise stated these are Rel-15 requirements.

[TS 24.501 clause 6.3.1.1]

The purpose of the PDU session authentication and authorization procedure is to enable the DN:

- a) to authenticate the upper layers of the UE, when establishing the PDU session;
- b) to authorize the upper layers of the UE, when establishing the PDU session;
- c) both of the above; or
- d) to re-authenticate the upper layers of the UE after establishment of the PDU session.

The PDU session authentication and authorization procedure can be performed only during or after the UE-requested PDU session procedure establishing a non-emergency PDU session. The PDU session authentication and authorization procedure shall not be performed during or after the UE-requested PDU session establishment procedure establishing an emergency PDU session.

The network authenticates the UE using the Extensible Authentication Protocol (EAP) as specified in IETF RFC 3748 [32].

EAP has defined four types of EAP messages:

- a) an EAP-request message;
- b) an EAP-response message;
- c) an EAP-success message; and
- d) an EAP-failure message.

The EAP-request message is transported from the network to the UE using the PDU SESSION AUTHENTICATION COMMAND message of the PDU EAP message reliable transport procedure.

The EAP-response message to the EAP-request message is transported from the UE to the network using the PDU SESSION AUTHENTICATION COMPLETE message of the PDU EAP message reliable transport procedure.

If the PDU session authentication and authorization procedure is performed during the UE-requested PDU session establishment procedure:

- a) and the DN authentication of the UE completes successfully, the EAP-success message is transported from the network to the UE as part of the UE-requested PDU session establishment procedure in the PDU SESSION ESTABLISHMENT ACCEPT message.
- b) and the DN authentication of the UE completes unsuccessfully, the EAP-failure message is transported from the network to the UE as part of the UE-requested PDU session establishment procedure in the PDU SESSION ESTABLISHMENT REJECT message.

If the PDU session authentication and authorization procedure is performed after the UE-requested PDU session establishment procedure:

- a) and the DN authentication of the UE completes successfully, the EAP-success message is transported from the network to the UE using the PDU SESSION AUTHENTICATION RESULT message of the PDU EAP result message transport procedure.
- b) and the DN authentication of the UE completes unsuccessfully, the EAP-failure message is transported from the network to the UE using the PDU SESSION RELEASE COMMAND message of the network-requested PDU session release procedure.

There can be several rounds of exchange of an EAP-request message and a related EAP-response message for the DN to complete the authentication and authorization of the request for a PDU session (see example in figure 6.3.1.1).

The SMF shall set the authenticator retransmission timer specified in IETF RFC 3748 [34] subclause 4.3 to infinite value.

NOTE: The PDU session authentication and authorization procedure provides a reliable transport of EAP messages and therefore retransmissions at the EAP layer of the SMF do not occur.

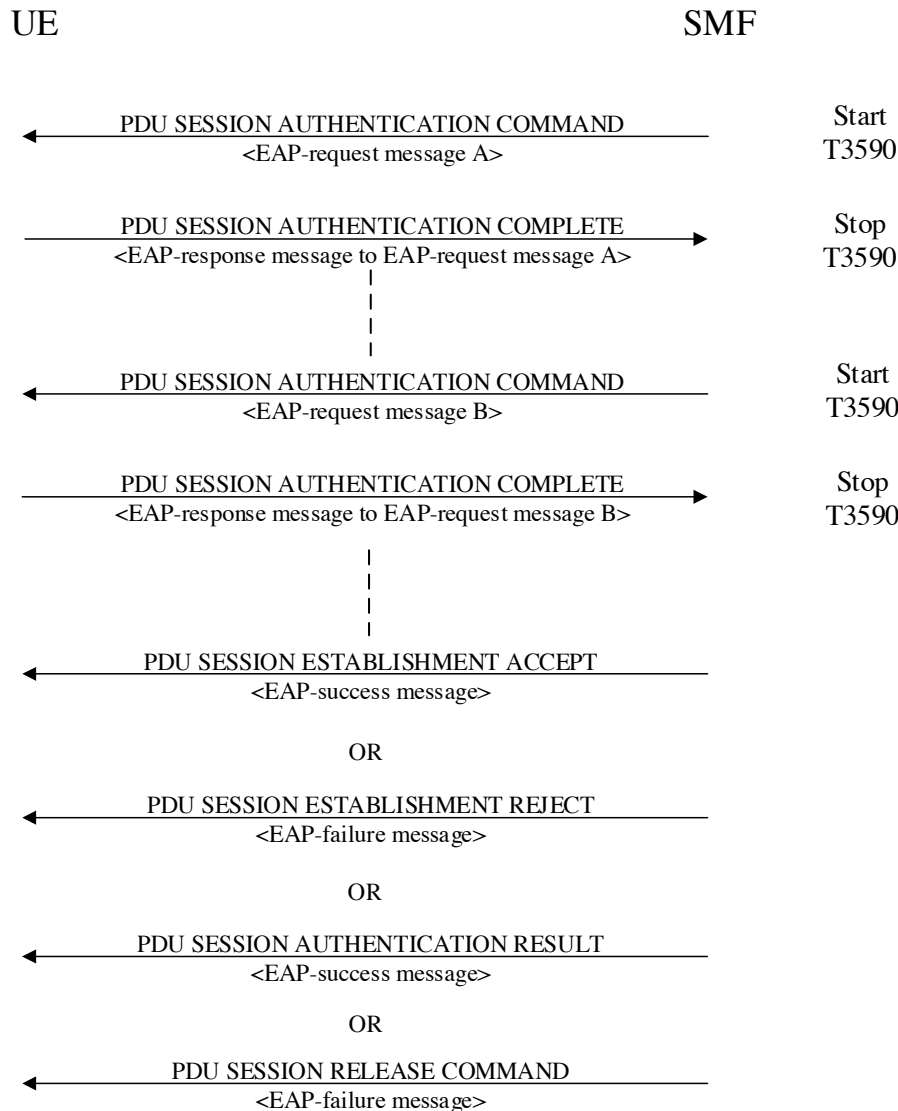

Figure 6.3.1.1: PDU session authentication and authorization procedure

[TS 24.501 clause 6.3.1.2.1]

In order to initiate the PDU EAP message reliable transport procedure, the SMF shall create a PDU SESSION AUTHENTICATION COMMAND message.

The SMF shall set the PTI IE of the PDU SESSION AUTHENTICATION COMMAND message to "No procedure transaction identity assigned".

The SMF shall set the EAP message IE of the PDU SESSION AUTHENTICATION COMMAND message to the EAP-request message provided by the DN or generated locally.

The SMF shall send the PDU SESSION AUTHENTICATION COMMAND message, and the SMF shall start timer T3590 (see example in figure 6.3.1.1).

Upon receipt of a PDU SESSION AUTHENTICATION COMMAND message and a PDU session ID, using the NAS transport procedure as specified in subclause 5.4.5, the UE passes to the upper layers the EAP message received in the EAP message IE of the PDU SESSION AUTHENTICATION COMMAND message. Apart from this action, the authentication and authorization procedure initiated by the DN is transparent to the 5GSM layer of the UE.

[TS 24.501 clause 6.3.1.2.2]

When the upper layers provide an EAP-response message responding to the received EAP-request message, the UE shall create a PDU SESSION AUTHENTICATION COMPLETE message.

The UE shall set the EAP message IE of the PDU SESSION AUTHENTICATION COMPLETE message to the EAP-response message.

The UE shall transport the PDU SESSION AUTHENTICATION COMPLETE message and the PDU session ID, using the NAS transport procedure as specified in subclause 5.4.5. Apart from this action, the authentication and authorization procedure initiated by the DN is transparent to the 5GSM layer of the UE.

Upon receipt of a PDU SESSION AUTHENTICATION COMPLETE message, the SMF shall stop timer T3590 and provides the EAP message received in the EAP message IE of the PDU SESSION AUTHENTICATION COMPLETE message to the DN or handles it locally.

[TS 24.501 clause 6.3.1.3.1]

In order to initiate the PDU EAP result message transport procedure, the SMF shall create a PDU SESSION AUTHENTICATION RESULT message.

The SMF shall set the PTI IE of the PDU SESSION AUTHENTICATION RESULT message to "No procedure transaction identity assigned".

The SMF shall set the EAP message IE of the PDU SESSION AUTHENTICATION RESULT message to the EAP-success message provided by the DN.

The SMF shall send the PDU SESSION AUTHENTICATION RESULT message.

Upon receipt of a PDU SESSION AUTHENTICATION RESULT message and a PDU session ID, using the NAS transport procedure as specified in subclause 5.4.5, the UE passes to the upper layers the EAP message received in the EAP message IE of the PDU SESSION AUTHENTICATION RESULT message. Apart from this action, the authentication and authorization procedure initiated by the DN is transparent to the 5GSM layer of the UE.

10.1.1.2.3 Test description

10.1.1.2.3.1 Pre-test conditions

System Simulator:

NGC Cell A

UE:

None.

Preamble:

The UE is in state 3N-A, on NGC Cell A with at least one PDU Session X ($1 \leq X \leq 15$) active according to TS 38.508-1 [4].

10.1.1.2.3.2 Test procedure sequence

Table 10.1.1.2.3.2-1: Main behaviour

| St | Procedure | Message Sequence | | TP | Verdict |
|--------|---|------------------|-------------------------------------|----|---------|
| | | U - S | Message | | |
| 0A | Cause the UE to request establishment of PDU session Y to the DN.(Note 1) | - | | - | - |
| 0B | The PDU session establishment procedure as specified in TS 38.508-1 [4] subclause 4.5A.2 take place. | - | | - | - |
| 1 | The SS transmits PDU SESSION AUTHENTICATION COMMAND including an EAP-Request message. | <-- | PDU SESSION AUTHENTICATION COMMAND | - | - |
| 2 | Check: Does the UE transmit a PDU SESSION AUTHENTICATION COMPLETE containing EAP-Response message? | --> | PDU SESSION AUTHENTICATION COMPLETE | 1 | P |
| 3 | The SS transmits PDU SESSION AUTHENTICATION RESULT message containing an EAP-Success message. | <-- | PDU SESSION AUTHENTICATION RESULT | - | - |
| 4 | The SS transmits PDU SESSION AUTHENTICATION COMMAND including an EAP-Request message. | <-- | PDU SESSION AUTHENTICATION COMMAND | - | - |
| 5 | Check: Does the UE transmit a PDU SESSION AUTHENTICATION COMPLETE containing EAP-Response message? | --> | PDU SESSION AUTHENTICATION COMPLETE | 3 | P |
| 6 - 17 | Void | - | - | - | - |
| 18 | Check: Does the UE perform PDU session release procedure defined in clause 4.9.21 of TS 38.508-1 [4] with PDU SESSION RELEASE COMMAND including 5GSM cause #29 "user authentication or authorization failed"? | - | - | 2- | P |
| 19 | Void | - | - | - | - |

Note 1: The request of connectivity to an additional PDU session may be performed by MMI or AT command.

10.1.1.2.3.3 Specific message contents

Table 10.1.1.2.3.3-1: Void**Table 10.1.1.2.3.3-2: Void****Table 10.1.1.2.3.3-2A: PDU SESSION AUTHENTICATION RESULT (step 3, Table 10.1.1.2.3.2-1)**

| Derivation Path: TS 38.508-1 table 4.7.2-6 | | | |
|--|--------------|---------------------------------------|-----------|
| Information Element | Value/remark | Comment | Condition |
| EAP message | EAP-success | See TS 24.501 [25] subclause 9.11.2.2 | |

Table 10.1.1.2.3.3-3: Void**Table 10.1.1.2.3.3-3A: Void****Table 10.1.1.2.3.3-4: Void**

Table 10.1.1.2.3.3-5: PDU SESSION RELEASE COMMAND (step 18, Table 10.1.1.2.3.2-1; step 1, TS 36.508 [4] Table 4.9.21.2.2-1)

| Derivation Path: TS 38.508-1 [4] Table 4.7.2-14 | | | |
|---|--|---|-----------|
| Information Element | Value/remark | Comment | Condition |
| PDU session ID | The same ID as the ID of PDU session which UE request in step 13 in Table 10.1.1.2.3.2-1 | | |
| 5GSM cause | '0001 1101'B | user authentication or authorization failed | |
| Back-off timer value | '1010 0000'B | 0 minutes | |
| EAP Message | EAP-Failure | See TS 24.501 [25] subclause 9.11.2.2 | |

10.1.2 Network-requested PDU session modification

10.1.2.1 Network-requested PDU session modification / Accepted

10.1.2.1.1 Test Purpose (TP)

(1)

```
with { the UE in 5GMM-REGISTERED state with an established PDU session }
ensure that {
  when { the UE receives a PDU SESSION MODIFICATION COMMAND message }
  then { UE sends a PDU SESSION MODIFICATION COMPLETE message and modifies the PDU session accordingly }
}
```

(2)

```
with { the UE in 5GMM-REGISTERED state with an established PDU session has been modified }
ensure that {
  when { the UE has IP packets for transmission where each IP packet matches the modified packet filters configured in the UL TFTs for the PDU session }
  then { the UE evaluates the packet filters in the correct evaluation order and transmits IP packets in uplink on the dedicated PDU session associated with the matched packet filter }
}
```

10.1.2.1.2 Conformance requirements

References: The conformance requirements covered in the present TC are specified in: TS 24.501, clauses 6.3.2.3 and TS 24.008, clause 10.5.6.12. Unless otherwise stated these are Rel-15 requirements.

[TS 24.501, clause 6.3.2.3]

Upon receipt of the PDU SESSION MODIFICATION COMMAND message, if the UE provided a DNN during the PDU session establishment, the UE shall stop timer T3396, if it is running for the DNN provided by the UE. If the UE did not provide a DNN during the PDU session establishment and the request type was different from "initial emergency request" and different from "existing emergency PDU session", the UE shall stop the timer T3396 associated with no DNN if it is running. If the PDU SESSION MODIFICATION COMMAND message was received for an emergency PDU session, the UE shall not stop the timer T3396 associated with no DNN if it is running.

Upon receipt of the PDU SESSION MODIFICATION COMMAND message, if the UE provided an S-NSSAI and a DNN during the PDU session establishment, the UE shall stop timer T3584, if it is running for the same [S-NSSAI, DNN] combination provided by the UE. If the UE did not provide an S-NSSAI during the PDU session establishment, the UE shall stop timer T3584, if it is running for the same [no S-NSSAI, DNN] combination provided by the UE. If the UE provided neither a DNN nor an S-NSSAI during the PDU session establishment, the UE shall stop timer T3584, if it is running for the same [no S-NSSAI, no DNN] combination provided by the UE.

Upon receipt of the PDU SESSION MODIFICATION COMMAND message, if the UE provided an S-NSSAI during the PDU session establishment, the UE shall stop timer T3585, if it is running for the S-NSSAI provided by the UE. If the UE did not provide an S-NSSAI during the PDU session establishment and the request type was different from "initial emergency request" and different from "existing emergency PDU session", the UE shall stop the timer T3585 associated with no S-NSSAI if it is running. If the PDU SESSION MODIFICATION COMMAND message was received for an emergency PDU session, the UE shall not stop the timer T3585 associated with no S-NSSAI if it is running.

NOTE 1: Upon receipt of the PDU SESSION MODIFICATION COMMAND message for a PDU session, if the UE provided a DNN (or no DNN) and an S-NSSAI (or no S-NSSAI) when the PDU session is established, timer T3396 associated with the DNN (or no DNN, if no DNN was provided by the UE) is running, and timer T3584 associated with the DNN (or no DNN, if no DNN was provided by the UE) and the S-NSSAI (or no S-NSSAI, if no S-NSSAI was provided by the UE) is running, then the UE stops both the timer T3396 and the timer T3584.

NOTE 2: Upon receipt of the PDU SESSION MODIFICATION COMMAND message for a PDU session, if the UE provided a DNN (or no DNN) and an S-NSSAI (or no S-NSSAI) when the PDU session is established, timer T3585 associated with the S-NSSAI (or no S-NSSAI, if no S-NSSAI was provided by the UE) is running, and timer T3584 associated with the DNN (or no DNN, if no DNN was provided by the UE) and the S-NSSAI (or no S-NSSAI, if no S-NSSAI was provided by the UE) is running, then the UE stops both the timer T3585 and the timer T3584.

If the PDU SESSION MODIFICATION COMMAND message includes the Authorized QoS rules IE, the UE shall process the QoS rules sequentially starting with the first QoS rule.

The UE shall replace the stored authorized QoS rules, authorized QoS flow descriptions and session-AMBR of the PDU session with the received value(s), if any, in the PDU SESSION MODIFICATION COMMAND message.

If the PDU SESSION MODIFICATION COMMAND message includes a Mapped EPS bearer contexts IE, the UE shall check each mapped EPS bearer context for different types of errors as follows:

NOTE 3: An error detected in a mapped EPS bearer context does not cause the UE to discard the Authorized QoS rules IE and Authorized QoS flow descriptions IE included in the PDU SESSION MODIFICATION COMMAND message, if any.

a) Semantic error in the mapped EPS bearer operation:

- 1) operation code = "Create new EPS bearer" and there is already an existing mapped EPS bearer context with the same EPS bearer identity associated with any PDU session.
- 2) operation code = "Delete existing EPS bearer" and there is no existing mapped EPS bearer context with the same EPS bearer identity associated with the PDU session that is being modified.
- 3) operation code = "Modify existing EPS bearer" and there is no existing mapped EPS bearer context with the same EPS bearer identity associated with the PDU session that is being modified.

In case 1, if the existing mapped EPS bearer context is associated with the PDU session that is being modified, the UE shall not diagnose an error, further process the create request and, if it was processed successfully, delete the old EPS bearer context.

In case 2, the UE shall not diagnose an error, further process the delete request and, if it was processed successfully, consider the mapped EPS bearer context as successfully deleted.

Otherwise, after sending the PDU SESSION MODIFICATION COMPLETE for the ongoing PDU session modification procedure, the UE shall initiate a PDU session modification procedure by sending a PDU SESSION MODIFICATION REQUEST message to delete the mapped EPS bearer context with 5GSM cause #85 "Invalid mapped EPS bearer identity".

b) if the mapped EPS bearer context includes a traffic flow template, the UE shall check the traffic flow template for different types of TFT IE errors as follows:

2) Semantic errors in TFT operations:

- i) TFT operation = "Create a new TFT" when there is already an existing TFT for the EPS bearer context.

- ii) When the TFT operation is an operation other than "Create a new TFT" and there is no TFT for the EPS bearer context.
- iii) TFT operation = "Delete packet filters from existing TFT" when it would render the TFT empty.
- iv) TFT operation = "Delete existing TFT" for a dedicated EPS bearer context.

In case iv, after sending the PDU SESSSION MODIFICATION COMPLETE for the ongoing PDU session modification procedure, the UE shall initiate a PDU session modification procedure by sending a PDU SESSION MODIFICATION REQUEST message to delete the mapped EPS bearer context with 5GSM cause #41 "semantic error in the TFT operation".

In the other cases the UE shall not diagnose an error and perform the following actions to resolve the inconsistency:

In case i, the UE shall further process the new activation request and, if it was processed successfully, delete the old TFT.

In case ii, the UE shall:

- process the new request and if the TFT operation is "Delete existing TFT" or "Delete packet filters from existing TFT", and if no error according to items b, c, and d was detected, consider the TFT as successfully deleted;
- process the new request as an activation request, if the TFT operation is "Add packet filters in existing TFT" or "Replace packet filters in existing TFT".

In case iii, if the packet filters belong to a dedicated EPS bearer context, the UE shall process the new deletion request and, if no error according to items b, c, and d was detected, after sending the PDU SESSSION MODIFICATION COMPLETE for the ongoing PDU session modification procedure, the UE shall initiate a PDU session modification procedure by sending a PDU SESSION MODIFICATION REQUEST message to delete the mapped EPS bearer context with 5GSM cause #41 "semantic error in the TFT operation".

In case iii, if the packet filters belong to the default EPS bearer context, the UE shall process the new deletion request and if no error according to items b, c, and d was detected then delete the existing TFT, this corresponds to using match-all packet filter for the default EPS bearer context.

2) Syntactical errors in TFT operations:

- i) When the TFT operation = "Create a new TFT", "Add packet filters in existing TFT", "Replace packet filters in existing TFT" or "Delete packet filters from existing TFT" and the packet filter list in the TFT IE is empty.
- ii) TFT operation = "Delete existing TFT" or "No TFT operation" with a non-empty packet filter list in the TFT IE.
- iii) TFT operation = "Replace packet filters in existing TFT" when the packet filter to be replaced does not exist in the original TFT.
- iv) TFT operation = "Delete packet filters from existing TFT" when the packet filter to be deleted does not exist in the original TFT.
- v) TFT operation = "Delete packet filters from existing TFT" with a packet filter list also including packet filters in addition to the packet filter identifiers.
- vi) When there are other types of syntactical errors in the coding of the TFT IE, such as a mismatch between the number of packet filters subfield, and the number of packet filters in the packet filter list.

In case iii, the UE shall not diagnose an error, further process the replace request and, if no error according to items c and d was detected, include the packet filters received to the existing TFT.

In case iv, the UE shall not diagnose an error, further process the deletion request and, if no error according to items c and d was detected, consider the respective packet filter as successfully deleted.

Otherwise, after sending the PDU SESSSION MODIFICATION COMPLETE for the ongoing PDU session modification procedure, the UE shall initiate a PDU session modification procedure by sending a PDU SESSION MODIFICATION REQUEST message to delete the mapped EPS bearer context with 5GSM cause #42 "syntactical error in the TFT operation".

3) Semantic errors in packet filters:

- i) When a packet filter consists of conflicting packet filter components which would render the packet filter ineffective, i.e. no IP packet will ever fit this packet filter. How the UE determines a semantic error in a packet filter is outside the scope of the present document.
- ii) When the resulting TFT, which is assigned to a dedicated EPS bearer context, does not contain any packet filter applicable for the uplink direction among the packet filters created on request from the network.

After sending the PDU SESSSION MODIFICATION COMPLETE for the ongoing PDU session modification procedure, the UE shall initiate a PDU session modification procedure by sending a PDU SESSION MODIFICATION REQUEST message to delete the mapped EPS bearer context with 5GSM cause #44 "semantic errors in packet filter(s)".

4) Syntactical errors in packet filters:

- i) When the TFT operation = "Create a new TFT", "Add packet filters to existing TFT", and two or more packet filters in the resultant TFT would have identical packet filter identifiers.
- ii) When the TFT operation = "Create a new TFT", "Add packet filters to existing TFT" or "Replace packet filters in existing TFT", and two or more packet filters among all TFTs associated with this PDN connection would have identical packet filter precedence values.
- iii) When there are other types of syntactical errors in the coding of packet filters, such as the use of a reserved value for a packet filter component identifier.

In case i, if two or more packet filters with identical packet filter identifiers are contained in the new request, after sending the PDU SESSSION MODIFICATION COMPLETE for the ongoing PDU session modification procedure, the UE shall initiate a PDU session modification procedure by sending a PDU SESSION MODIFICATION REQUEST message to delete the mapped EPS bearer context with 5GSM cause #45 "syntactical error in packet filter(s)". Otherwise, the UE shall not diagnose an error, further process the new request and, if it was processed successfully, delete the old packet filters which have the identical packet filter identifiers.

In case ii, if the old packet filters do not belong to the default EPS bearer context, the UE shall not diagnose an error, shall further process the new request and, if it was processed successfully, shall delete the old packet filters which have identical filter precedence values.

In case ii, if one or more old packet filters belong to the default EPS bearer context, after sending the PDU SESSSION MODIFICATION COMPLETE for the ongoing PDU session modification procedure, the UE shall initiate a PDU session modification procedure by sending a PDU SESSION MODIFICATION REQUEST message to delete the mapped EPS bearer context with 5GSM cause #45 "syntactical errors in packet filter(s)".

Otherwise, after sending the PDU SESSSION MODIFICATION COMPLETE for the ongoing PDU session modification procedure, the UE shall initiate a PDU session modification procedure by sending a PDU SESSION MODIFICATION REQUEST message to delete the mapped EPS bearer context with 5GSM cause #45 "syntactical error in packet filter(s)".

And if a new EPS bearer identity parameter in authorized QoS flow descriptions IE is received for a QoS flow which can be transferred to EPS, the UE shall update the association between the QoS flow and the mapped EPS bearer context, based on the new EPS bearer identity and the mapped EPS bearer contexts. If the "Delete existing EPS bearer" operation code in the Mapped EPS bearer contexts IE was received, the UE shall discard the association between the QoS flow and the corresponding mapped EPS bearer context.

Upon receipt of a PDU SESSION MODIFICATION COMMAND message and a PDU session ID, using the NAS transport procedure as specified in subclause 5.4.5, if the UE accepts the PDU SESSION MODIFICATION COMMAND message, the UE considers the PDU session as modified and the UE shall create a PDU SESSION MODIFICATION COMPLETE message.

If the PDU SESSION MODIFICATION COMMAND message contains the PTI value allocated in the UE-requested PDU session modification procedure, the UE shall stop the timer T3581. The UE should ensure that the PTI value assigned to this procedure is not released immediately.

NOTE 4: The way to achieve this is implementation dependent. For example, the UE can ensure that the PTI value assigned to this procedure is not released during the time equal to or greater than the default value of timer T3591.

While the PTI value is not released, the UE regards any received PDU SESSION MODIFICATION COMMAND message with the same PTI value as a network retransmission (see subclause 7.3.1).

If the selected SSC mode of the PDU session is "SSC mode 3" and the PDU SESSION MODIFICATION COMMAND message includes 5GSM cause #39 "reactivation requested", the UE can provide to the upper layers the PDU session address lifetime if received in the PDU session address lifetime PCO parameter of the Extended protocol configuration options IE of the PDU SESSION MODIFICATION COMMAND message. After the completion of the network-requested PDU session modification procedure, the UE should re-initiate the UE-requested PDU session establishment procedure with a new PDU session ID as specified in subclause 6.4.1 for:

- a) the PDU session type associated with the present PDU session;
- b) the SSC mode associated with the present PDU session;
- c) the DNN associated with the present PDU session; and
- d) the S-NSSAI associated with (if available in roaming scenarios) a mapped S-NSSAI if provided in the UE-requested PDU session establishment procedure of the present PDU session.

The UE shall include the PDU session ID of the old PDU session which is about to get released in the old PDU session ID IE of the UL NAS TRANSPORT message that transports the PDU SESSION ESTABLISHMENT REQUEST message.

NOTE 5: The UE is expected to maintain the PDU session for which the PDU SESSION MODIFICATION COMMAND message including 5GSM cause #39 "reactivation requested" is received during the time indicated by the PDU session address lifetime value or until receiving an indication from upper layers (e.g. that the old PDU session is no more needed).

If the selected PDU session type of the PDU session is "Unstructured" or "Ethernet", the UE supports inter-system change from N1 mode to S1 mode, the UE does not support establishment of a PDN connection for the PDN type set to "non-IP" in S1 mode, and the parameters list field of one or more authorized QoS flow descriptions received in the authorized QoS flow descriptions IE of the PDU SESSION MODIFICATION COMMAND message contains an EPS bearer identity (EBI) then the UE shall locally remove the EPS bearer identity (EBI) from the parameters list field of such one or more authorized QoS flow descriptions.

If the Always-on PDU session indication IE is included in the PDU SESSION MODIFICATION COMMAND message and:

- a) the value of the IE is set to "Always-on PDU session required", the UE shall consider the established PDU session as an always-on PDU session; or
- b) the value of the IE is set to "Always-on PDU session not allowed", the UE shall not consider the established PDU session as an always-on PDU session.

If the UE does not receive the Always-on PDU session indication IE in the PDU SESSION MODIFICATION COMMAND message:

- a) if the network-requested PDU session modification procedure is triggered by a UE-requested PDU session modification procedure upon the first inter-system change from S1 mode to N1 mode for a PDN connection established when in S1 mode, the UE shall not consider the modified PDU session as an always-on PDU session; or
- b) otherwise:
 - 1) if the UE has received the Always-on PDU session indication IE with the value set to "Always-on PDU session required" for this PDU session, the UE shall consider the PDU session as an always-on PDU session; or

2) otherwise the UE shall not consider the PDU session as an always-on PDU session.

The UE shall transport the PDU SESSION MODIFICATION COMPLETE message and the PDU session ID, using the NAS transport procedure as specified in subclause 5.4.5.

After sending the PDU SESSION MODIFICATION COMPLETE message, if the "Create new EPS bearer" operation code in the mapped EPS bearer contexts IE was received in the PDU SESSION MODIFICATION COMMAND message and there is neither a corresponding authorized QoS flow descriptions IE in the PDU SESSION MODIFICATION COMMAND message nor an existing QoS flow description corresponding to the EPS bearer identity included in the mapped EPS bearer context, the UE shall send a PDU SESSION MODIFICATION REQUEST message including a mapped EPS bearer contexts IE to delete the mapped EPS bearer context.

Upon receipt of a PDU SESSION MODIFICATION COMPLETE message, the SMF shall stop timer T3591 and shall consider the PDU session as modified. If the selected SSC mode of the PDU session is "SSC mode 3" and the PDU SESSION MODIFICATION COMMAND message included 5GSM cause #39 "reactivation requested", the SMF shall start timer T3593. If the PDU Session Address Lifetime value is sent to the UE in the PDU SESSION MODIFICATION COMMAND message then timer T3593 shall be started with the same value, otherwise it shall use a default value.

[TS 24.008, clause 10.5.6.12]

The purpose of the *traffic flow template* information element is to specify the TFT parameters and operations for a PDP context. In addition, this information element may be used to transfer extra parameters to the network (e.g. the Authorization Token; see 3GPP TS 24.229 [95]). The TFT may contain packet filters for the downlink direction, the uplink direction or packet filters that are applicable to both directions. The packet filters determine the traffic mapping to PDP contexts. The downlink packet filters shall be used by the network and the uplink packet filters shall be used by the MS. A packet filter that is applicable to both directions shall be used by the network as a downlink packet filter and by the MS as an uplink packet filter.

The *traffic flow template* is a type 4 information element with a minimum length of 3 octets. The maximum length for the IE is 257 octets.

NOTE 1: The IE length restriction is due to the maximum length that can be encoded in a single length octet.

NOTE 2: A maximum size IPv4 packet filter can be 32 bytes. Therefore, 7 maximum size IPv4 type packet filters, plus the last packet filter which can contain max 30 octets can fit into one TFT IE, i.e. if needed not all packet filter components can be defined into one message. A maximum size IPv6 packet filter can be 60 bytes. Therefore, only 4 maximum size IPv6 packet filters can fit into one TFT IE. However, using "Add packet filters to existing TFT", it's possible to create a TFT data structure including 16 maximum size IPv4 or IPv6 filters.

The *traffic flow template* information element is coded as shown in figure 10.5.144/3GPP TS 24.008 and table 10.5.162/3GPP TS 24.008.

NOTE 3: The 3GPP TS 24.301 [120] reuses the traffic flow template information element for the purpose of the traffic flow aggregate description, where the use of individual TFT parameters, e.g. the packet filter identifier in the parameter list, can differ from this specification.

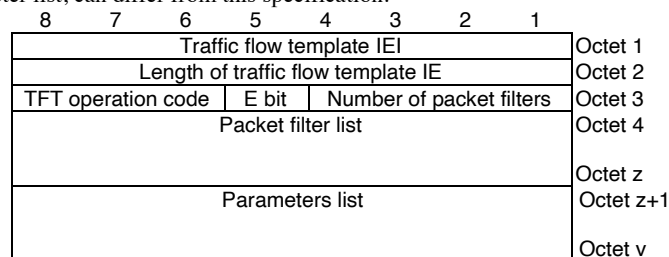
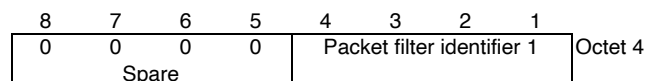

Figure 10.5.144/3GPP TS 24.008: *Traffic flow template* information element



| | | | | | | |
|-----|---|---|---|-------|----------------------------|-----------|
| 0 | 0 | 0 | 0 | Spare | Packet filter identifier 2 | Octet 5 |
| ... | | | | | | |
| 0 | 0 | 0 | 0 | Spare | Packet filter identifier N | Octet N+3 |

Figure 10.5.144a/3GPP TS 24.008: **Packet filter list** when the TFT operation is "delete packet filters from existing TFT" (z=N+3)

| | | | | | | | | |
|---------------------------------------|---|---------------------------|----------------------------|---|---|---|-------|-----------|
| 8 | 7 | 6 | 5 | 4 | 3 | 2 | 1 | |
| 0 | 0 | Packet filter direction 1 | Packet filter identifier 1 | | | | Spare | Octet 4 |
| Packet filter evaluation precedence 1 | | | | | | | | Octet 5 |
| Length of Packet filter contents 1 | | | | | | | | Octet 6 |
| Packet filter contents 1 | | | | | | | | Octet 7 |
| ... | | | | | | | | Octet m |
| 0 | 0 | Packet filter direction 2 | Packet filter identifier 2 | | | | Spare | Octet m+1 |
| Packet filter evaluation precedence 2 | | | | | | | | Octet m+2 |
| Length of Packet filter contents 2 | | | | | | | | Octet m+3 |
| Packet filter contents 2 | | | | | | | | Octet m+4 |
| ... | | | | | | | | Octet n |
| ... | | | | | | | | Octet n+1 |
| ... | | | | | | | | Octet y |
| 0 | 0 | Packet filter direction N | Packet filter identifier N | | | | Spare | Octet y+1 |
| Packet filter evaluation precedence N | | | | | | | | Octet y+2 |
| Length of Packet filter contents N | | | | | | | | Octet y+3 |
| Packet filter contents N | | | | | | | | Octet y+4 |
| ... | | | | | | | | Octet z |

Figure 10.5.144b/3GPP TS 24.008: **Packet filter list** when the TFT operation is "create new TFT", or "add packet filters to existing TFT" or "replace packet filters in existing TFT"

| | | | | | | | | |
|--------------------------------|---|---|---|---|---|---|---|-----------|
| 8 | 7 | 6 | 5 | 4 | 3 | 2 | 1 | |
| Parameter identifier 1 | | | | | | | | Octet z+1 |
| Length of Parameter contents 1 | | | | | | | | Octet z+2 |
| Parameter contents 1 | | | | | | | | Octet z+3 |
| ... | | | | | | | | Octet k |
| Parameter identifier 2 | | | | | | | | Octet k+1 |
| Length of Parameter contents 2 | | | | | | | | Octet k+2 |
| Parameter contents 2 | | | | | | | | Octet k+3 |
| ... | | | | | | | | Octet p |
| ... | | | | | | | | Octet p+1 |
| ... | | | | | | | | Octet q |
| Parameter identifier N | | | | | | | | Octet q+1 |
| Length of Parameter contents N | | | | | | | | Octet q+2 |
| Parameter contents N | | | | | | | | Octet q+3 |
| ... | | | | | | | | Octet v |

Figure 10.5.144c/3GPP TS 24.008: **Parameters list**

Table 10.5.162/3GPP TS 24.008: *Traffic flow template* information element

TFT operation code (octet 3)

Bits

8 7 6

0 0 0 Ignore this IE

0 0 1 Create new TFT

0 1 0 Delete existing TFT

0 1 1 Add packet filters to existing TFT

1 0 0 Replace packet filters in existing TFT

1 0 1 Delete packet filters from existing TFT

1 1 0 No TFT operation

1 1 1 Reserved

The TFT operation code "No TFT operation" shall be used if a *parameters list* is included but no *packet filter list* is included in the *traffic flow template* information element.

The TFT operation code "Ignore this IE" shall be used by the MS if the Traffic flow aggregate information element has presence requirement "M" in a message, but the information element does not serve any useful purpose in the specific procedure for which the message is sent (see 3GPP TS 24.301 [120], subclauses 6.5.3.2 and 6.5.4.2). If the TFT operation code indicates "Ignore this IE", the MS shall also set the E bit and the number of packet filters to zero.

If the TFT operation code is set to "Ignore this IE" and the E bit and the number of packet filters to zero, then the network shall ignore the contents of the traffic flow template information element.

E bit (bit 5 of octet 3)

The *E bit* indicates if a *parameters list* is included in the TFT IE and it is encoded as follows:

0 *parameters list* is not included

1 *parameters list* is included

Number of packet filters (octet 3)

The *number of packet filters* contains the binary coding for the number of packet filters in the *packet filter list*. The *number of packet filters* field is encoded in bits 4 through 1 of octet 3 where bit 4 is the most significant and bit 1 is the least significant bit. For the "delete existing TFT" operation and for the "no TFT operation", the *number of packet filters* shall be coded as 0. For all other operations, the number of packet filters shall be greater than 0 and less than or equal to 15.

Packet filter list (octets 4 to z)

The *packet filter list* contains a variable number of packet filters. For the "delete existing TFT" operation and the "no TFT operation", the *packet filter list* shall be empty.

For the "delete packet filters from existing TFT" operation, the *packet filter list* shall contain a variable number of packet filter identifiers. This number shall be derived from the coding of the *number of packet filters* field in octet 3.

For the "create new TFT", "add packet filters to existing TFT" and "replace packet filters in existing TFT" operations, the *packet filter list* shall contain a variable number of packet filters. This number shall be derived from the coding of the *number of packet filters* field in octet 3.

Each packet filter is of variable length and consists of

- a packet filter identifier and direction (1 octet);
- a packet filter evaluation precedence (1 octet);
- the length of the packet filter contents (1 octet); and
- the packet filter contents itself (v octets).

The *packet filter identifier* field is used to identify each packet filter in a TFT. The least significant 4 bits are used.

The *packet filter direction* is used to indicate, in bits 5 and 6, for what traffic direction the filter applies:

00 - pre Rel-7 TFT filter
 01 - downlink only
 10 - uplink only
 11 - bidirectional
 Bits 8 through 7 are spare bits.

The *packet filter evaluation precedence* field is used to specify the precedence for the packet filter among all packet filters in all TFTs associated with this PDP address. Higher the value of the *packet filter evaluation precedence* field, lower the precedence of that packet filter is. The first bit in transmission order is the most significant bit.

The *length of the packet filter contents* field contains the binary coded representation of the length of the *packet filter contents* field of a packet filter. The first bit in transmission order is the most significant bit.

The *packet filter contents* field is of variable size and contains a variable number (at least one) of *packet filter components*. Each *packet filter component* shall be encoded as a sequence of a one octet *packet filter component type identifier* and a fixed length *packet filter component value* field. The *packet filter component type identifier* shall be transmitted first.

In each packet filter, there shall not be more than one occurrence of each packet filter component type. Among the "IPv4 remote address type" and "IPv6 remote address type" packet filter components, only one shall be present in one packet filter. Among the "single local port type" and "local port range type" packet filter components, only one shall be present in one packet filter. Among the "single remote port type" and "remote port range type" packet filter components, only one shall be present in one packet filter.

The term *local* refers to the MS and the term *remote* refers to an external network entity.

Packet filter component type identifier

Bits

| | |
|-----------------|--|
| 8 7 6 5 4 3 2 1 | |
| 0 0 0 1 0 0 0 0 | IPv4 remote address type |
| 0 0 0 1 0 0 0 1 | IPv4 local address type |
| 0 0 1 0 0 0 0 0 | IPv6 remote address type |
| 0 0 1 0 0 0 0 1 | IPv6 remote address/prefix length type |
| 0 0 1 0 0 0 1 1 | IPv6 local address/prefix length type |
| 0 0 1 1 0 0 0 0 | Protocol identifier/Next header type |
| 0 1 0 0 0 0 0 0 | Single local port type |
| 0 1 0 0 0 0 0 1 | Local port range type |
| 0 1 0 1 0 0 0 0 | Single remote port type |
| 0 1 0 1 0 0 0 1 | Remote port range type |
| 0 1 1 0 0 0 0 0 | Security parameter index type |
| 0 1 1 1 0 0 0 0 | Type of service/Traffic class type |
| 1 0 0 0 0 0 0 0 | Flow label type |
| 1 0 0 0 0 0 0 1 | Destination MAC address type |
| 1 0 0 0 0 0 1 0 | Source MAC address type |
| 1 0 0 0 0 0 1 1 | 802.1Q C-TAG VID type |
| 1 0 0 0 0 1 0 0 | 802.1Q S-TAG VID type |
| 1 0 0 0 0 1 0 1 | 802.1Q C-TAG PCP/DEI type |
| 1 0 0 0 0 1 1 0 | 802.1Q S-TAG PCP/DEI type |
| 1 0 0 0 0 1 1 1 | Ethertype type |

All other values are reserved.

The description and valid combinations of packet filter component type identifiers in a packet filter are defined in 3GPP TS 23.060 [74] subclause 15.3.2.

For "IPv4 remote address type", the *packet filter component value* field shall be encoded as a sequence of a four octet *IPv4 address* field and a four octet *IPv4 address mask* field. The *IPv4 address* field shall be transmitted first.

For "IPv4 local address type", the *packet filter component value* field shall be

encoded as defined for "IPv4 remote address type".

Both the MS and network indication for support of the Local address in TFTs are required to use this packet filter component.

For "IPv6 remote address type", the *packet filter component value* field shall be encoded as a sequence of a sixteen octet *IPv6 address* field and a sixteen octet *IPv6 address mask* field. The *IPv6 address* field shall be transmitted first.

For "IPv6 remote address/prefix length type", the packet filter component value field shall be encoded as a sequence of a sixteen octet IPv6 address field and one octet prefix length field. The IPv6 address field shall be transmitted first.

This parameter shall be used, instead of IPv6 remote address type, when both the MS and network indication for support of the Local address in TFT are present.

For "IPv6 local address/prefix length type", the packet filter component value field shall be encoded as defined for "IPv6 remote address /prefix length".

Both the MS and network indication for support of the Local address in TFTs are required to use this packet filter component.

NOTE: Local IP address and mask can be used when IPv6 prefix delegation is used (see 3GPP TS 23.060 [74] subclause 9.2.1.2).

For "Protocol identifier/Next header type", the *packet filter component value* field shall be encoded as one octet which specifies the IPv4 protocol identifier or IPv6 next header.

For "Single local port type" and "Single remote port type", the *packet filter component value* field shall be encoded as two octet which specifies a port number.

For "Local port range type" and "Remote port range type", the *packet filter component value* field shall be encoded as a sequence of a two octet *port range low limit* field and a two octet *port range high limit* field. The *port range low limit* field shall be transmitted first.

For "Security parameter index", the *packet filter component value* field shall be encoded as four octet which specifies the IPsec security parameter index.

For "Type of service/Traffic class type", the *packet filter component value* field shall be encoded as a sequence of a one octet *Type-of-Service/Traffic Class* field and a one octet *Type-of-Service/Traffic Class mask* field. The *Type-of-Service/Traffic Class* field shall be transmitted first.

For "Flow label type", the *packet filter component value* field shall be encoded as three octet which specifies the IPv6 flow label. The bits 8 through 5 of the first octet shall be spare whereas the remaining 20 bits shall contain the IPv6 flow label. Parameters list (octets z+1 to v)

For "destination MAC address type" and "source MAC address type", the *packet filter component value* field shall be encoded as 6 octets which specify a MAC address.

For "802.1Q C-TAG VID type", the *packet filter component value* field shall be encoded as two octets which specify the VID of the customer-VLAN tag (C-TAG). The bits 8 through 5 of the first octet shall be spare whereas the remaining 12 bits shall contain the VID.

For "802.1Q S-TAG VID type", the *packet filter component value* field shall be encoded as two octets which specify the VID of the service-VLAN tag (S-TAG). The bits 8 through 5 of the first octet shall be spare whereas the remaining 12 bits shall contain the VID.

For "802.1Q C-TAG PCP/DEI type", the *packet filter component value* field shall be encoded as one octet which specifies the 802.1Q C-TAG PCP and DEI. The bits 8 through 5 of the octet shall be spare, the bits 4 through 2 contain the PCP and bit 1 contains the DEI.

For "802.1Q S-TAG PCP/DEI type", the *packet filter component value* field shall be encoded as one octet which specifies the 802.1Q S-TAG PCP. The bits 8 through 5

of the octet shall be spare, the bits 4 through 2 contain the PCP and bit 1 contains the DEI.

For "ethertype type", the *packet filter component value* field shall be encoded as two octets which specify an ethertype.

The *parameters list* contains a variable number of parameters that may be transferred. If the *parameters list* is included, the *E bit* is set to 1; otherwise, the *E bit* is set to 0.

Each parameter included in the *parameters list* is of variable length and consists of:

- a parameter identifier (1 octet);
- the length of the parameter contents (1 octet); and
- the parameter contents itself (*v* octets).

The *parameter identifier* field is used to identify each parameter included in the *parameters list* and it contains the hexadecimal coding of the parameter identifier.

Bit 8 of the *parameter identifier* field contains the most significant bit and bit 1 contains the least significant bit. In this version of the protocol, the following parameter identifiers are specified:

- 01H (Authorization Token);
- 02H (Flow Identifier); and
- 03H (Packet Filter Identifier).

If the *parameters list* contains a parameter identifier that is not supported by the receiving entity the corresponding parameter shall be discarded.

The *length of parameter contents* field contains the binary coded representation of the length of the *parameter contents* field. The first bit in transmission order is the most significant bit.

When the *parameter identifier* indicates Authorization Token, the *parameter contents* field contains an authorization token, as specified in 3GPP TS 29.207 [100]. The first octet is the most significant octet of the authorization token and the last octet is the least significant octet of the authorization token.

The *parameters list* shall be coded in a way that an Authorization Token (i.e. a parameter with identifier 01H) is always followed by one or more Flow Identifiers (i.e. one or more parameters with identifier 02H).

If the *parameters list* contains two or more consecutive Authorization Tokens without any Flow Identifiers in between, the receiver shall treat this as a semantical TFT error.

When the *parameter identifier* indicates Flow Identifier, the *parameter contents* field contains the binary representation of a flow identifier. The Flow Identifier consists of four octets. Octets 1 and 2 contains the Media Component number as specified in 3GPP TS 29.207 [100]. Bit 1 of octet 2 is the least significant bit, and bit 8 of octet 1 is the most significant bit. Octets 3 and 4 contains the IP flow number as specified in 3GPP TS 29.207 [100]. Bit 1 of octet 4 is the least significant bit, and bit 8 of octet 3 is the most significant bit.

When the *parameter identifier* indicates Packet Filter Identifier, the *parameter contents* field contains the binary representation of one or more packet filter identifiers. Each packet filter identifier is encoded in one octet, in the 4 least significant bits. This parameter is used by the MS and the network to identify one or more packet filters in a TFT when modifying the QoS of a PDP context without modifying the packet filter itself.

10.1.2.1.3 Test description

10.1.2.1.3.1 Pre-test conditions

System Simulator:

- NGC Cell A.

UE:

- None.

Preamble:

- The UE is in state 3N-A on NGC Cell A with at least one PDU session for Internet active according to TS 38.508-1 [4], clause 4.4A.3 Table 4.4A.3-1 and using the message condition UE TEST LOOP MODE B active.

10.1.2.1.3.2 Test procedure sequence

Table 10.1.2.1.3.2-1: Main behaviour

| St | Procedure | Message Sequence | | TP | Verdict |
|----|---|------------------|-----------------------------------|----|---------|
| | | U - S | Message | | |
| 1 | The SS transmits a PDU session modification command message with PDU session ID IE is set to the same value as the first PDU session ID for Internet in the PDU SESSION ESTABLISHMENT REQUEST message. This message is included in a DLInformationTransfer message. | <-- | PDU SESSION MODIFICATION COMMAND | - | - |
| 2 | Check: Does the UE transmit a PDU session modification complete? | --> | PDU SESSION MODIFICATION COMPLETE | 1 | P |
| 3 | The SS transmits one IP Packet matching with new packet filter (reference packet filter list #2). | - | - | - | - |
| 4 | Check: Does UE send the IP Packet on the data radio bearer associated with the PDU QoS rule? | - | - | 2 | P |

10.1.2.1.3.3 Specific message contents

Table 10.1.2.1.3.3-1: PDU SESSION MODIFICATION COMMAND (Step 1, Table 10.1.2.1.3.2-1)

| Derivation path: TS 38.508-1 [4], table 4.7.2-9 | | | |
|---|--|---------|-----------|
| Information Element | Value/Remark | Comment | Condition |
| PDU session ID | The value the first PDU session ID for Internet indicated in PDU SESSION ESTABLISHMENT REQUEST message in the preamble | | |
| Authorized QoS rules | Reference QoS rule #3 as defined in 38.508-1 [4] table 4.8.2.1-3. | | |

10.1.2.2 Network-requested PDU session modification / Abnormal / PDU session in state PDU SESSION INACTIVE

10.1.2.2.1 Test Purpose (TP)

(1)

```

with { the UE in PDU SESSION ACTIVE state and 5GMM-CONNECTED mode }
ensure that {
  when { the UE receives a PDU SESSION MODIFICATION COMMAND message include the PDU session ID which
  belong to any PDU session in PDU SESSION INACTIVE state in UE }
  then { UE sends a 5GSM STATUS message and set the 5GSM cause to #43: invalid PDU session
  identity }
}

```

10.1.2.2.2 Conformance requirements

References: The conformance requirements covered in the present TC are specified in: TS 24.501, clauses 6.3.2.6 and 7.3.2. Unless otherwise stated these are Rel-15 requirements.

[TS 24.501, clause 6.3.2.6]

The following abnormal cases can be identified:

- a) PDU session inactive for the received PDU session ID.

If the PDU session ID in the PDU SESSION MODIFICATION COMMAND message belongs to any PDU session in state PDU SESSION INACTIVE in the UE, the UE shall set the 5GSM cause IE to #43 "Invalid PDU session identity" in the 5GSM STATUS message, and set the PDU session ID to the received PDU session ID in the UL NAS TRANSPORT message as specified in subclause 5.4.5.

[TS 24.501, clause 7.3.2]

The following UE procedures shall apply for handling an unknown, erroneous, or unforeseen PDU session identity received in the header of a 5GSM message:

- a) If the UE receives a 5GSM message which includes an unassigned or reserved PDU session identity value, the UE shall ignore the message.
- b) If the UE receives a 5GSM message which includes a PDU session identity belonging to any PDU session in state PDU SESSION INACTIVE in the UE, the UE shall respond with a 5GSM STATUS message including 5GSM cause #43 "invalid PDU session identity".

10.1.2.2.3 Test description

10.1.2.2.3.1 Pre-test conditions

System Simulator:

- NGC Cell A.

UE:

- None.

Preamble:

- The UE is in state 3N-A on NGC Cell A with at least one PDU session for Internet active according to 38.508-1[4]

10.1.2.2.3.2 Test procedure sequence

Table 10.1.2.2.3.2-1: Main behaviour

| St | Procedure | Message Sequence | | TP | Verdict |
|----|---|------------------|----------------------------------|----|---------|
| | | U - S | Message | | |
| 1 | The generic test procedure in TS 38.508-1 clause 4.9.21 for PDU Session Release is performed message with PDU session ID IE is set to the same value as the first PDU session ID for Internet in PDU SESSION ESTABLISHMENT REQUEST message in preamble. | - | - | - | - |
| 2 | Void | - | | - | - |
| 3 | The SS transmits a PDU session modification command message with PDU session ID IE is set to the same value in PDU SESSION RELEASE COMMAND message. This message is included in a DLInformationTransfer message. | <- | PDU SESSION MODIFICATION COMMAND | - | - |
| 4 | Check: Does the UE transmit a 5GSM STATUS with the 5GSM cause IE indicating #43 "invalid PDU session identity"? | --> | 5GSM STATUS | 1 | P |

10.1.2.2.3.3 Specific message contents

Table 10.1.2.2.3.3-1: PDU SESSION MODIFICATION COMMAND (Step 3, Table 10.1.2.2.3.2-1)

| Derivation path: TS 38.508-1 [4], table 4.7.2-9 | | | |
|---|---|---------|-----------|
| Information Element | Value/Remark | Comment | Condition |
| PDU session ID | The same value in PDU SESSION RELEASE COMMAND message | | |

Table 10.1.2.2.3.3-2: 5GSM STATUS (Step 4, Table 10.1.2.2.3.2-1)

| Derivation path: TS 38.508-1 [4], table 4.7.2-16 | | | |
|--|---|------------------------------|-----------|
| Information Element | Value/Remark | Comment | Condition |
| PDU session ID | The same value as the value set in PDU SESSION modification command message | | |
| 5GSM cause | '00101011'B | Invalid PDU session identity | |

Table 10.1.2.2.3.3-3: PDU SESSION RELEASE COMMAND (Step 1, Table 10.1.2.2.3.2-1; step 1, TS 36.508 [4] Table 4.9.21.2.2-1)

| Derivation path: TS 38.508-1 [4], table 4.7.2-14 | | | |
|--|---|---------|-----------|
| Information Element | Value/Remark | Comment | Condition |
| PDU session ID | The value of the first PDU session ID for Internet indicated in PDU SESSION ESTABLISHMENT REQUEST message in preamble | | |

10.1.3 Network-requested PDU session release

10.1.3.1 Void

10.1.3.2 Network-requested PDU session release / Accepted / Insufficient resources / T3396, Accepted / Insufficient resources for specific slice and DNN / T3584, Abnormal / No PDU session context active for the received PDU session ID

10.1.3.2.1 Test Purpose (TP)

(1)

```
with { UE is in PDU SESSION ACTIVE state }
ensure that {
  when { UE receives a PDU SESSION RELEASE COMMAND message including 5GSM cause #26 "insufficient
resources" and the Back-off timer value that indicates neither zero nor deactivated }
  then { UE does not send a PDU SESSION ESTABLISHMENT REQUEST until timer T3396 expires or timer
T3396 is stopped }
}
```

(2)

```
with { UE is in PDU SESSION ACTIVE state }
ensure that {
  when { UE receives a PDU SESSION RELEASE COMMAND message including 5GSM cause #26 "insufficient
resources" and the Back-off timer value that indicates zero }
  then { UE sends a PDU SESSION ESTABLISHMENT REQUEST message }
}
```

(3)

```
with { UE is in PDU SESSION ACTIVE state }
ensure that {
  when { UE receives a PDU SESSION RELEASE COMMAND message including 5GSM cause #26 "insufficient
resources" and the Back-off timer value that indicates deactivated }
  then { UE does not send a PDU SESSION ESTABLISHMENT REQUEST message until the UE is switched off
or the USIM is removed }
}
```

(4)

```
with { UE is in PDU SESSION ACTIVE state }
ensure that {
  when { UE receives a PDU SESSION RELEASE COMMAND message including 5GSM cause #67 "insufficient
resources for specific slice and DNN" and the Back-off timer value that indicates neither zero nor
deactivated }
  then { UE does not send a PDU SESSION ESTABLISHMENT REQUEST message for the same [S-NSSAI, DNN]
combination until timer T3584 expires }
}
```

(5)

```
with { UE is in PDU SESSION ACTIVE state }
ensure that {
  when { UE receives a PDU SESSION RELEASE COMMAND message including 5GSM cause #67 "insufficient
resources for specific slice and DNN" and the Back-off timer value that indicates zero }
  then { UE sends a PDU SESSION ESTABLISHMENT REQUEST message for the same [S-NSSAI, DNN]
combination }
}
```

(6)

```
with { UE is in PDU SESSION ACTIVE state }
ensure that {
  when { UE receives a PDU SESSION RELEASE COMMAND message including 5GSM cause #67 "insufficient
resources for specific slice and DNN" and the Back-off timer value that indicates deactivated }
  then { UE does not send a PDU SESSION ESTABLISHMENT REQUEST message for the same [S-NSSAI, DNN]
combination until the UE is switched off or the USIM is removed }
}
```

}

(7)

```

with { UE is in PDU SESSION ACTIVE state }
ensure that {
  when { UE receives a PDU SESSION RELEASE COMMAND message, in which the PDU session ID belongs to
any PDU session in state PDU SESSION INACTIVE in the UE }
  then { UE sends 5GSM STATUS message including 5GSM cause #43 "Invalid PDU session identity" }
}

```

10.1.3.2.2 Conformance requirements

References: The conformance requirements covered in the current TC are specified in: TS 24.501, clause 6.3.3.2 and 6.3.3.3. Unless otherwise stated these are Rel-15 requirements.

[TS 24.501, clause 6.3.3.2]

In order to initiate the network-requested PDU session release procedure, the SMF shall create a PDU SESSION RELEASE COMMAND message.

The SMF shall set the SM cause IE of the PDU SESSION RELEASE COMMAND message to indicate the reason for releasing the PDU session.

The SM cause IE typically indicates one of the following SM cause values:

```

#26 insufficient resources;
...
#67 insufficient resources for specific slice and DNN;

```

...

The SMF may include a Back-off timer value IE in the PDU SESSION RELEASE COMMAND message when the 5GSM cause value #26 "insufficient resources" is included in the PDU SESSION RELEASE COMMAND message. If the 5GSM cause value is #26 "insufficient resources" and the PDU SESSION RELEASE COMMAND message is sent to a UE configured for high priority access in selected PLMN or the request type was set to "initial emergency request" or "existing emergency PDU session" for the establishment of the PDU session, the network shall not include a Back-off timer value IE.

The SMF may include a Back-off timer value IE in the PDU SESSION RELEASE COMMAND message when the 5GSM cause value #67 "insufficient resources for specific slice and DNN" is included in the PDU SESSION RELEASE COMMAND message. If the 5GSM cause value is #67 "insufficient resources for specific slice and DNN" and the PDU SESSION RELEASE COMMAND message is sent to a UE configured for high priority access in selected PLMN or the request type was set to "initial emergency request" or "existing emergency PDU session" for the establishment of the PDU session, the network shall not include a Back-off timer value IE.

[TS 24.501, clause 6.3.3.3]

Upon receipt of a PDU SESSION RELEASE COMMAND message and a PDU session ID, using the NAS transport procedure as specified in subclause 5.4.5, the UE considers the PDU session as released and the UE shall create a PDU SESSION RELEASE COMPLETE message.

...

If the PDU SESSION RELEASE COMMAND message includes 5GSM cause #26 "insufficient resources" and the Back-off timer value IE, the UE shall take different actions depending on the timer value received for timer T3396 in the Back-off timer value:

- a) If the timer value indicates neither zero nor deactivated and a DNN was provided during the PDU session establishment, the UE shall stop timer T3396 associated with the corresponding DNN, if it is running. If the timer value indicates neither zero nor deactivated and no DNN was provided during the PDU session establishment and the request type was different from "initial emergency request" and different from "existing emergency PDU session", the UE shall stop timer T3396 associated with no DNN if it is running. The UE shall then start timer T3396 with the value provided in the Back-off timer value IE and:

- 1) shall not send a PDU SESSION ESTABLISHMENT REQUEST message or PDU SESSION MODIFICATION REQUEST message with exception of those identified in subclause 6.4.2.1, for the same DNN that was sent by the UE, until timer T3396 expires or timer T3396 is stopped; and
- 2) shall not send a PDU SESSION ESTABLISHMENT REQUEST message without an DNN and with request type different from "initial emergency request" and different from "existing emergency PDU session", or a PDU SESSION MODIFICATION REQUEST message with exception of those identified in subclause 6.4.2.1, for a non-emergency PDU session established without an DNN provided by the UE, if no DNN was provided during the PDU session establishment and the request type was different from "initial emergency request" and different from "existing emergency PDU session", until timer T3396 expires or timer T3396 is stopped.

The UE shall not stop timer T3396 upon a PLMN change or inter-system change;

- b) if the timer value indicates that this timer is deactivated and a DNN was provided during the PDU session establishment, the UE shall stop timer T3396 associated with the corresponding DNN, if it is running. If the timer value indicates that this timer is deactivated and no DNN was provided during the PDU session establishment and the request type was different from "initial emergency request" and different from "existing emergency PDU session", the UE shall stop timer T3396 associated with no DNN if it is running. The UE:
 - 1) shall not send a PDU SESSION ESTABLISHMENT REQUEST message or PDU SESSION MODIFICATION REQUEST message with exception of those identified in subclause 6.4.2.1, for the same DNN until the UE is switched off or the USIM is removed, or the UE receives a PDU SESSION MODIFICATION COMMAND message for the same DNN from the network or a PDU SESSION RELEASE COMMAND message including 5GSM cause #39 "reactivation requested" for the same DNN from the network; and
 - 2) shall not send a PDU SESSION ESTABLISHMENT REQUEST message without an DNN and with request type different from "initial emergency request" and different from "existing emergency PDU session", or a PDU SESSION MODIFICATION REQUEST message with exception of those identified in subclause 6.4.2.1, for a non-emergency PDU session established without an DNN provided by the UE, if no DNN was provided during the PDU session establishment and the request type was different from "initial emergency request" and different from "existing emergency PDU session", until the UE is switched off or the USIM is removed, or the UE receives a PDU SESSION MODIFICATION COMMAND message for a non-emergency PDU session established without an DNN provided by the UE, or a PDU SESSION RELEASE COMMAND message including 5GSM cause IE set to 5GSM cause #39 "reactivation requested" for a non-emergency PDU session established without an DNN provided by the UE.

The timer T3396 remains deactivated upon a PLMN change or inter-system change; and

- c) if the timer value indicates zero, the UE:
 - 1) shall stop timer T3396 associated with the corresponding DNN, if running, and may send a PDU SESSION ESTABLISHMENT REQUEST message or PDU SESSION MODIFICATION REQUEST message for the same DNN; and
 - 2) if no DNN was provided during the PDU session establishment and the request type was different from "initial emergency request" and different from "existing emergency PDU session", the UE shall stop timer T3396 associated with no DNN, if running, and may send a PDU SESSION ESTABLISHMENT REQUEST message without a DNN, or a PDU SESSION MODIFICATION REQUEST message without an DNN provided by the UE.

If the PDU SESSION RELEASE COMMAND message includes 5GSM cause #26 "insufficient resources" and the Back-off timer value IE is not included, then the UE may send a PDU SESSION ESTABLISHMENT REQUEST message or PDU SESSION MODIFICATION REQUEST message for the same DNN or without a DNN.

When the timer T3396 is running or the timer is deactivated, the UE is allowed to initiate a PDU session establishment procedure for emergency services.

If the timer T3396 is running when the UE enters state 5GMM-DEREGISTERED, the UE remains switched on, and the USIM in the UE remains the same, then timer T3396 is kept running until it expires or it is stopped.

If the UE is switched off when the timer T3396 is running, and if the USIM in the UE remains the same when the UE is switched on, the UE shall behave as follows:

- let t_1 be the time remaining for T3396 timeout at switch off and let t be the time elapsed between switch off and switch on. If t_1 is greater than t , then the timer shall be restarted with the value $t_1 - t$. If t_1 is equal to or less than t , then the timer need not be restarted. If the UE is not capable of determining t , then the UE shall restart the timer with the value t_1 .

If the 5GSM cause value is #67 "insufficient resources for specific slice and DNN" and the Back-off timer value IE is included, the UE shall take different actions depending on the timer value received for timer T3584 in the Back-off timer value:

- a) If the timer value indicates neither zero nor deactivated, the UE shall stop timer T3584 associated with the same [S-NSSAI, DNN] combination as that the UE provided when the PDU session is established, if it is running. The UE shall then start timer T3584 with the value provided in the Back-off timer value IE.

The UE shall not send another PDU SESSION ESTABLISHMENT REQUEST message with request type different from "initial emergency request" and different from "existing emergency PDU session", or PDU SESSION MODIFICATION REQUEST message with exception of those identified in subclause 6.4.2.1, for the same [S-NSSAI, DNN] combination that was sent by the UE, until timer T3584 expires or timer T3584 is stopped;

The UE shall not stop timer T3584 upon a PLMN change or inter-system change;

- b) if the timer value indicates that this timer is deactivated, the UE shall stop timer T3584 associated with the same [S-NSSAI, DNN] combination as that the UE provided when the PDU session is established, if it is running.

The UE shall not send another PDU SESSION ESTABLISHMENT REQUEST message with request type different from "initial emergency request" and different from "existing emergency PDU session", or PDU SESSION MODIFICATION REQUEST message with exception of those identified in subclause 6.4.2.1, for the same [S-NSSAI, DNN] combination that was sent by the UE, until the UE is switched off or the USIM is removed, or the UE receives a PDU SESSION MODIFICATION REQUEST message for the same [S-NSSAI, DNN] combination from the network or a PDU SESSION RELEASE COMMAND message including 5GSM cause #39 "reactivation requested" for the same [S-NSSAI, DNN] combination from the network; and

The timer T3584 remains deactivated upon a PLMN change or inter-system change; and

- c) if the timer value indicates zero, the UE shall stop timer T3584 associated with the same [S-NSSAI, DNN] combination that was sent by the UE, if running, and may send another PDU SESSION ESTABLISHMENT REQUEST message or PDU SESSION MODIFICATION REQUEST message for the same [S-NSSAI, DNN] combination.

If the 5GSM cause value is #67 "insufficient resources for specific slice and DNN" and the Back-off timer value IE is not included, then the UE may send another PDU SESSION ESTABLISHMENT REQUEST message or PDU SESSION MODIFICATION REQUEST message for the same [S-NSSAI, DNN] combination.

When the timer T3584 is running or the timer is deactivated, the UE is allowed to initiate a PDU session establishment procedure for emergency services.

If the timer T3584 is running when the UE enters state 5GMM-DEREGISTERED, the UE remains switched on, and the USIM in the UE remains the same, then timer T3584 is kept running until it expires or it is stopped.

If the UE is switched off when the timer T3584 is running, and if the USIM in the UE remains the same when the UE is switched on, the UE shall behave as follows:

- let t_1 be the time remaining for T3584 timeout at switch off and let t be the time elapsed between switch off and switch on. If t_1 is greater than t , then the timer shall be restarted with the value $t_1 - t$. If t_1 is equal to or less than t , then the timer need not be restarted. If the UE is not capable of determining t , then the UE shall restart the timer with the value t_1 .

[TS 24.501, clause 6.3.3.6]

The following abnormal cases can be identified:

- a) PDU session inactive for the received PDU session ID.

If the PDU session ID in the PDU SESSION RELEASE COMMAND message belongs to any PDU session in state PDU SESSION INACTIVE in the UE, the UE shall include the 5GSM cause #43 "Invalid PDU session

identity" in the 5GSM STATUS message, and set the PDU session ID to the received PDU session ID in the UL NAS TRANSPORT message as specified in subclause 5.4.5.

[TS 24.501, clause B.1]

Cause #43 –Invalid PDU session identity

This 5GSM cause is used by the network or the UE to indicate that the PDU session identity value provided to it is not a valid value or the PDU session identified by the PDU session identity IE in the request or the command is not active.

[24.501, clause 7.3.2]

...

The following UE procedures shall apply for handling an unknown, erroneous, or unforeseen PDU session identity received in the header of a 5GSM message:

- a) If the UE receives a 5GSM message which includes an unassigned or reserved PDU session identity value, the UE shall ignore the message.
- b) If the UE receives a 5GSM message which includes a PDU session identity belonging to any PDU session in state PDU SESSION INACTIVE in the UE, the UE shall respond with a 5GSM STATUS message including 5GSM cause #43 "invalid PDU session identity".

10.1.3.2.3 Test description

10.1.3.2.3.1 Pre-test conditions

System Simulator:

- NGC Cell A.

UE:

None.

Preamble:

- The UE is in state 3N-A on NGC Cell A according to TS 38.508-1 [4].

10.1.3.2.3.2 Test procedure sequence

Table 10.1.3.2.3.2-1: Main behaviour

| St | Procedure | Message Sequence | | TP | Verdict |
|----|--|------------------|---|----|---------|
| | | U – S | Message | | |
| 1 | Cause the UE to request establishment of PDU session without DNN.(Note 1) | - | - | - | - |
| 2 | The PDU session establishment procedure as specified in TS 38.508-1 [4] subclause 4.5A.2 take place. | - | - | - | - |
| 3 | The generic test procedure in TS 38.508-1 Table 4.9.21.2.2-1 of Procedure for PDU Session Release is performed. | - | - | - | - |
| 4 | Void | - | - | - | - |
| 5 | Cause the UE to request establishment of PDU session without DNN within 2 minutes of Step 3 (Note 1) | - | - | - | - |
| 6 | Check: Does the UE transmit a PDU SESSION ESTABLISHMENT REQUEST message before timer T3396 has expired? | --> | 5GMM: UL NAS TRANSPORT
5GSM: PDU SESSION ESTABLISHMENT REQUEST | 1 | F |
| 7 | Cause the UE to request establishment of PDU session without DNN after 2 minutes since Step 3.(Note 1) | - | - | - | - |
| 8 | Check: Does the UE transmit a PDU SESSION ESTABLISHMENT REQUEST message? | --> | 5GMM: UL NAS TRANSPORT
5GSM: PDU SESSION ESTABLISHMENT REQUEST | 1 | P |
| 9 | The SS transmits a PDU SESSION ESTABLISHMENT ACCEPT message. | <-- | 5GMM: DL NAS TRANSPORT
5GSM: PDU SESSION ESTABLISHMENT ACCEPT | - | - |
| 10 | The generic test procedure in TS 38.508-1 Table 4.9.21.2.2-1 of Procedure for PDU Session Release is performed | - | - | - | - |
| 11 | Void | - | - | - | - |
| 12 | Cause the UE to request establishment of PDU session without DNN.(Note 1) | - | - | - | - |
| 13 | Check: Does the UE transmit a PDU SESSION ESTABLISHMENT REQUEST message? | --> | 5GMM: UL NAS TRANSPORT
5GSM: PDU SESSION ESTABLISHMENT REQUEST | 2 | P |
| 14 | The SS transmits a PDU SESSION ESTABLISHMENT ACCEPT message. | <-- | 5GMM: DL NAS TRANSPORT
5GSM: PDU SESSION ESTABLISHMENT ACCEPT | - | - |
| 15 | The generic test procedure in TS 38.508-1 Table 4.9.21.2.2-1 of Procedure for PDU Session Release is performed | - | - | - | - |
| 16 | Void | - | - | - | - |
| 17 | Cause the UE to request establishment of PDU session without DNN.(Note 1) | - | - | - | - |
| 18 | Check: Does the UE transmit a PDU SESSION ESTABLISHMENT REQUEST message in 5 seconds? | --> | 5GMM: UL NAS TRANSPORT
5GSM: PDU SESSION ESTABLISHMENT REQUEST | 3 | F |
| 19 | Switch off UE in RRC CONNECTED as described in TS38.508-1 [4] subclause 4.9.6.3 | - | - | - | - |
| 20 | Switch on UE. | - | - | - | - |
| 21 | The general procedure is completed by executing of the UE registration procedure in TS 38.508-1 [4] table 4.5.2.2-2 , 'connected without release'. | - | - | - | - |
| 22 | Cause the UE to request establishment of PDU session without DNN.(Note 1) | - | - | - | - |
| 23 | Check: Does the UE transmit a PDU SESSION ESTABLISHMENT REQUEST message? | --> | 5GMM: UL NAS TRANSPORT
5GSM: PDU SESSION ESTABLISHMENT REQUEST | 3 | P |
| 24 | The SS transmits a PDU SESSION ESTABLISHMENT ACCEPT message. | <-- | 5GMM: DL NAS TRANSPORT
5GSM: PDU SESSION ESTABLISHMENT ACCEPT | - | - |
| 25 | Cause the UE to request establishment of | - | - | - | - |

| | | | | | |
|----|--|-----|---|---|---|
| | PDU session with [S-NSSAI, DNN] combination.(Note 1) | | | | |
| 26 | The PDU session establishment procedure as specified in TS 38.508-1 [4] subclause 4.5A.2 take place. | - | - | - | - |
| 27 | The generic test procedure in TS 38.508-1 Table 4.9.21.2.2-1 of Procedure for PDU Session Release is performed | - | - | - | - |
| 28 | Void | - | - | - | - |
| 29 | Cause the UE to request establishment of PDU session with the same [S-NSSAI, DNN] combination as the PDU session established at step 26 within 2 minutes of Step 27.(Note 1) | - | - | - | - |
| 30 | Check: Does the UE transmit a PDU SESSION ESTABLISHMENT REQUEST before timer T3584 has expired? | --> | 5GMM: UL NAS TRANSPORT
5GSM: PDU SESSION ESTABLISHMENT REQUEST | 4 | F |
| 31 | Cause the UE to request establishment of PDU session with the same [S-NSSAI, DNN] combination as the PDU session established at step 26 after 2 minutes since Step 27.(Note 1) | - | - | - | - |
| 32 | Check: Does the UE transmit a PDU SESSION ESTABLISHMENT REQUEST? | --> | 5GMM: UL NAS TRANSPORT
5GSM: PDU SESSION ESTABLISHMENT REQUEST | 4 | P |
| 33 | The SS transmits a PDU SESSION ESTABLISHMENT ACCEPT message. | <-- | 5GMM: DL NAS TRANSPORT
5GSM: PDU SESSION ESTABLISHMENT ACCEPT | - | - |
| 34 | The generic test procedure in TS 38.508-1 Table 4.9.21.2.2-1 of Procedure for PDU Session Release is performed | - | - | - | - |
| 35 | Void | - | - | - | - |
| 36 | Cause the UE to request establishment of PDU session with the same [S-NSSAI, DNN] combination as the PDU session established at step 26.(Note 1) | - | - | - | - |
| 37 | Check: Does the UE transmit a PDU SESSION ESTABLISHMENT REQUEST? | --> | 5GMM: UL NAS TRANSPORT
5GSM: PDU SESSION ESTABLISHMENT REQUEST | 5 | P |
| 38 | The SS transmits a PDU SESSION ESTABLISHMENT ACCEPT message. | <-- | 5GMM: DL NAS TRANSPORT
5GSM: PDU SESSION ESTABLISHMENT ACCEPT | - | - |
| 39 | The generic test procedure in TS 38.508-1 Table 4.9.21.2.2-1 of Procedure for PDU Session Release is performed | - | - | - | - |
| 40 | Void | - | - | - | - |
| 41 | Cause the UE to request establishment of PDU session with the same [S-NSSAI, DNN] combination as the PDU session established at step 26.(Note 1) | - | - | - | - |
| 42 | Check: Does the UE transmit a PDU SESSION ESTABLISHMENT REQUEST in 5 seconds? | --> | 5GMM: UL NAS TRANSPORT
5GSM: PDU SESSION ESTABLISHMENT REQUEST | 6 | F |
| 43 | The SS transmits a PDU SESSION RELEASE COMMAND including the PDU session ID UE requested in step 42. | <-- | 5GMM: DL NAS TRANSPORT
5GSM: PDU SESSION RELEASE COMMAND | - | - |
| 44 | Check: Does the UE transmit a 5GSM STATUS message with value #43? | --> | 5GSM: UL NAS TRANSPORT
5GSM: 5GSM STATUS | 7 | P |
| 45 | Switch off UE in RRC CONNECTED as described in TS38.508-1 [4] subclause 4.9.6.3 | - | - | - | - |
| 46 | Switch on UE. | - | - | - | - |
| 47 | The general procedure is completed by executing of the UE registration procedure in TS 38.508-1 [4] table 4.5.2.2-2 , 'connected without release'. | - | - | - | - |
| 48 | Cause the UE to request establishment of PDU session with the same [S-NSSAI, DNN] combination as the PDU session established | - | - | - | - |

| | | | | | |
|---|--|-----|---|---|---|
| | at step 26.(Note 1) | | | | |
| 49 | Check: Does the UE transmit a PDU SESSION ESTABLISHMENT REQUEST? | --> | 5GMM: UL NAS TRANSPORT
5GSM: PDU SESSION ESTABLISHMENT REQUEST | 6 | P |
| 50 | The SS transmits a PDU SESSION ESTABLISHMENT ACCEPT message. | <-- | 5GMM: DL NAS TRANSPORT
5GSM: PDU SESSION ESTABLISHMENT ACCEPT | - | - |
| Note 1: The request to establish a PDU session may be performed by MMI or AT Command. | | | | | |

Table 10.1.3.2.3.2-2: Void

Table 10.1.3.2.3.2-3: Void

10.1.3.2.3.3 Specific message contents

Table 10.1.3.2.3.3-1: UL NAS TRANSPORT (step 2, 8, 13 and 23, Table 10.1.3.2.3.2-1)

| Derivation Path: TS 38.508-1 [4] Table 4.7.1-10 | | | |
|---|-----------------------------------|-------------------|-----------|
| Information Element | Value/remark | Comment | Condition |
| Payload container type | '0001'B | N1 SM information | |
| Payload container | PDU SESSION ESTABLISHMENT REQUEST | | |
| DNN | Not present | | |

Table 10.1.3.2.3.3-2: PDU SESSION RELEASE COMMAND (step 3, Table 10.1.3.2.3.2-1; step 1, Table 4.9.21.2.2-1, TS 38.508-1[4])

| Derivation Path: TS 38.508-1 [4] Table 4.7.2-14 | | | |
|---|---|------------------------|-----------|
| Information Element | Value/remark | Comment | Condition |
| PDU session ID | The same ID as the ID of PDU session which UE request in step 2 in Table 10.1.3.2.3.2-1 | | |
| 5GSM cause | '0001 1010'B | insufficient resources | |
| Back-off timer value | '0010 0010'B | 2 minutes | |

Table 10.1.3.2.3.3-3: Void

Table 10.1.3.2.3.3-4: PDU SESSION RELEASE COMMAND (step 10, Table 10.1.3.2.3.2-1; step 1, Table 4.9.21.2.2-1, TS 38.508-1[4])

| Derivation Path: TS 38.508-1 [4] Table 4.7.2-14 | | | |
|---|---|------------------------|-----------|
| Information Element | Value/remark | Comment | Condition |
| PDU session ID | The same ID as the ID of PDU session which UE request in step 8 in Table 10.1.3.2.3.2-1 | | |
| 5GSM cause | '0001 1010'B | insufficient resources | |
| Back-off timer value | '1010 0000'B | 0 minutes | |

Table 10.1.3.2.3.3-5: PDU SESSION RELEASE COMMAND (step 15, Table 10.1.3.2.3.2-1; step 1, Table 4.9.21.2.2-1, TS 38.508-1[4])

| Derivation Path: TS 38.508-1 [4] Table 4.7.2-14 | | | |
|---|--|------------------------|-----------|
| Information Element | Value/remark | Comment | Condition |
| PDU session ID | The same ID as the ID of PDU session which UE request in step 13 in Table 10.1.3.2.3.2-1 | | |
| 5GSM cause | '0001 1010'B | insufficient resources | |
| Back-off timer value | '1110 0000'B | deactivated | |

Table 10.1.3.2.3.3-6: UL NAS TRANSPORT (step 26, Table 10.1.3.2.3.2-1)

| Derivation Path: TS 38.508-1 [4] Table 4.7.1-10 | | | |
|---|-----------------------------------|-------------------|-----------|
| Information Element | Value/remark | Comment | Condition |
| Payload container type | '0001'B | N1 SM information | |
| Payload container | PDU SESSION ESTABLISHMENT REQUEST | | |
| S-NSSAI | present | | |
| DNN | present | | |

Table 10.1.3.2.3.3-7: PDU SESSION RELEASE COMMAND (step 27, Table 10.1.3.2.3.2-1; step 1, Table 4.9.21.2.2-1, TS 38.508-1[4])

| Derivation Path: TS 38.508-1 [4] Table 4.7.2-14 | | | |
|---|--|---|-----------|
| Information Element | Value/remark | Comment | Condition |
| PDU session ID | The same ID as the ID of PDU session which UE request in step 26 in Table 10.1.3.2.3.2-1 | | |
| 5GSM cause | '0100 0011'B | insufficient resources for specific slice and DNN | |
| Back-off timer value | '0010 0010'B | 2 minutes | |

Table 10.1.3.2.3.3-8: UL NAS TRANSPORT (step 32, 37 and 49, Table 10.1.3.2.3.2-1)

| Derivation Path: TS 38.508-1 [4] Table 4.7.1-10 | | | |
|---|--|-------------------|-----------|
| Information Element | Value/remark | Comment | Condition |
| Payload container type | '0001'B | N1 SM information | |
| Payload container | PDU SESSION ESTABLISHMENT REQUEST | | |
| S-NSSAI | The same S-NSSAI as the S-NSSAI of the PDU session which UE request at step 26 | | |
| DNN | The same DNN as the DNN of the PDU session which UE request at step 26 | | |

Table 10.1.3.2.3.3-9: PDU SESSION RELEASE COMMAND (step 34, Table 10.1.3.2.3.2-1; step 1, Table 4.9.21.2.2-1, TS 38.508-1[4])

| Derivation Path: TS 38.508-1 [4] Table 4.7.2-14 | | | |
|---|--|---|-----------|
| Information Element | Value/remark | Comment | Condition |
| PDU session ID | The same ID as the ID of PDU session which UE request in step 32 in Table 10.1.3.2.3.2-1 | | |
| 5GSM cause | '0100 0011'B | insufficient resources for specific slice and DNN | |
| Back-off timer value | '1010 0000'B | 0 minutes | |

Table 10.1.3.2.3.3-10: PDU SESSION RELEASE COMMAND (step 39, Table 10.1.3.2.3.2-1; step 1, Table 4.9.21.2.2-1, TS 38.508-1[4])

| Derivation Path: TS 38.508-1 [4] Table 4.7.2-14 | | | |
|---|--|---|-----------|
| Information Element | Value/remark | Comment | Condition |
| PDU session ID | The same ID as the ID of PDU session which UE request in step 37 in Table 10.1.3.2.3.2-1 | | |
| 5GSM cause | '0100 0011'B | insufficient resources for specific slice and DNN | |
| Back-off timer value | '1110 0000'B | deactivated | |

Table 10.1.3.2.3.3-11: PDU SESSION RELEASE COMMAND (step 43, Table 10.1.3.2.3.2-1; step 1, Table 4.9.21.2.2-1, TS 38.508-1[4])

| Derivation Path: TS 38.508-1 [4] Table 4.7.2-14 | | | |
|---|--|--------------------------|-----------|
| Information Element | Value/remark | Comment | Condition |
| PDU session ID | The same ID as the ID of PDU session which UE request in step 37 in Table 10.1.3.2.3.2-1 | | |
| 5GSM cause | '0010 0100'B | #36 regular deactivation | |

Table 10.1.3.2.3.3-11A: UL NAS TRANSPORT (step 44, Table 10.1.3.2.3.2-1)

| Derivation Path: TS 38.508-1 [4] Table 4.7.1-10 | | | |
|---|--|-------------------|-----------|
| Information Element | Value/remark | Comment | Condition |
| PDU session ID | The same ID as the ID of PDU session which UE request in step 37 in Table 10.1.3.2.3.2-1 | | |
| Payload container type | '0001'B | N1 SM information | |
| Payload container | 5GSM STATUS | | |

Table 10.1.3.2.3.3-12: 5GSM STATUS (Table 10.1.3.2.3.3-11)

| Derivation Path: TS 38.508-1 [4] Table 4.7.2-16 | | | |
|---|--------------|----------------------------------|-----------|
| Information Element | Value/remark | Comment | Condition |
| 5GSM cause | '0010 1011'B | #43 Invalid PDU session identity | |

10.1.4 UE-requested PDU session establishment

10.1.4.1 UE-requested PDU session establishment / Abnormal / T3580

10.1.4.1.1 Test Purpose (TP)

(1)

```
with { the UE in 5GMM-REGISTERED state and at least one PDU session has been established. the SS
sends PDU SESSION RELEASE COMMAND with #39 "reactivation requested", and the UE has sent a PDU
SESSION ESTABLISHMENT REQUEST message }
ensure that {
  when { On the 1st, 2nd, 3rd, 4th expiry of timer T3580 }
  then { the UE retransmits PDU SESSION ESTABLISHMENT REQUEST message for the same [S-NSSAI, DNN]
values provided in PDU SESSION RELEASE COMMAND }
}
```

(2)

```
with { the UE in 5GMM-REGISTERED state and has sent a PDU SESSION ESTABLISHMENT REQUEST message }
ensure that {
  when { on the maximum 5th expiry of timer T3580 }
  then { the UE aborts the procedure }
}
```

10.1.4.1.2 Conformance requirements

References: The conformance requirements covered in the present TC are specified in: TS 24.501, clause 6.4.1.6. Unless otherwise stated these are Rel-15 requirements.

[TS 24.501, clause 6.4.1.6]

The following abnormal cases can be identified:

a) Expiry of timer T3580

The UE shall, on the first expiry of the timer T3580, retransmit the PDU SESSION ESTABLISHMENT REQUEST message and the PDU session information which was transported together with the initial transmission of the PDU SESSION ESTABLISHMENT REQUEST message and shall reset and start timer T3580, if still needed. This retransmission can be repeated up to four times, i.e. on the fifth expiry of timer T3580, the UE shall abort the procedure, release the allocated PTI and enter the state PROCEDURE TRANSACTION INACTIVE.

10.1.4.1.3 Test description

10.1.4.1.3.1 Pre-test conditions

System Simulator:

- NGC Cell A.

UE:

- None.

Preamble:

- The UE is in state 3N-A on NGC Cell A with at least one PDU session X ($1 \leq X \leq 15$) active according to 38.508-1[4].

10.1.4.1.3.2 Test procedure sequence

Table 10.1.4.1.3.2-1: Main behaviour

| St | Procedure | Message Sequence | | TP | Verdict |
|------|--|------------------|---|----|---------|
| | | U - S | Message | | |
| 1 | The generic test procedure in TS 38.508-1 clause 4.9.21 for PDU Session Release is performed with PDU SESSION RELEASE COMMAND message includes 5GSM cause #39 "reactivation requested" to release PDU session X. | - | - | - | - |
| 2-15 | Void. | - | - | - | - |
| 16 | The UE transmits a PDU SESSION ESTABLISHMENT REQUEST message and the S-NSSAI and DNN in UL NAS TRANSPORT message are the same values as released (Note 2). | --> | 5GMM: UL NAS TRANSPORT
5GSM: PDU SESSION ESTABLISHMENT REQUEST | - | - |
| 17 | The SS waits 16 seconds (T3580). | - | - | - | - |
| 18 | Check: Does the UE re-transmit the PDU SESSION ESTABLISHMENT REQUEST message and the S-NSSAI and DNN in UL NAS TRANSPORT message are the same values as sent in step 16? | --> | 5GMM: UL NAS TRANSPORT
5GSM: PDU SESSION ESTABLISHMENT REQUEST | 1 | P |
| 19 | The SS waits 16 seconds (2 nd expiry of T3580). | - | - | - | - |
| 20 | Check: Does the UE re-transmit the PDU SESSION ESTABLISHMENT REQUEST message and the S-NSSAI and DNN in UL NAS TRANSPORT message are the same values as sent in step 16? | --> | 5GMM: UL NAS TRANSPORT
5GSM: PDU SESSION ESTABLISHMENT REQUEST | 1 | P |
| 21 | The SS waits 16 seconds (3 rd expiry of T3580). | - | - | - | - |
| 22 | Check: Does the UE re-transmit the PDU SESSION ESTABLISHMENT REQUEST message and the S-NSSAI and DNN in UL NAS TRANSPORT message are the same values as sent in step 16? | --> | 5GMM: UL NAS TRANSPORT
5GSM: PDU SESSION ESTABLISHMENT REQUEST | 1 | P |
| 23 | The SS waits 16 seconds (4 th expiry of T3580). | - | - | - | - |
| 24 | Check: Does the UE re-transmit the PDU SESSION ESTABLISHMENT REQUEST message and the S-NSSAI and DNN in UL NAS TRANSPORT message are the same values as sent in step 16? | --> | 5GMM: UL NAS TRANSPORT
5GSM: PDU SESSION ESTABLISHMENT REQUEST | 1 | P |
| 25 | The SS waits 16 seconds (5 th expiry of T3580). | - | - | - | - |
| 26 | Check: Does the UE re-transmit the PDU SESSION ESTABLISHMENT REQUEST message and the S-NSSAI and DNN in UL NAS TRANSPORT message are the same values as sent in step 16 in the next 20 seconds? (Note 1) | --> | 5GMM: UL NAS TRANSPORT
5GSM: PDU SESSION ESTABLISHMENT REQUEST | 2 | F |

Note 1: The 20 seconds is chosen randomly as long as it is greater than T3580 = 16 seconds.
Note 2 : At step 16 the SS waits for 1s for the UE to transmit the PDU Session Establishment REQ. Upon expiry of 1s, the PDU Session Establishment may be performed by MMI or AT command.

10.1.4.1.3.3 Specific message contents

Table 10.1.4.1.3.3-1: PDU SESSION RELEASE COMMAND (Step 1, Table 10.1.4.1.3.2-1; step 1, TS 36.508 [4] Table 4.9.21.2.2-1)

| Derivation path: TS 38.508-1 [4], table 4.7.2-14 | | | |
|--|--------------|--|-----------|
| Information Element | Value/Remark | Comment | Condition |
| PDU session ID | X | ID of the active PDU session in preamble | |
| 5GSM cause | '0010 0111'B | Reactivation requested | |

Table 10.1.4.1.3.3-2: UL NAS TRANSPORT (Step 16, 18, 20, 22, 24 Table 10.1.4.1.3.2-1)

| Derivation path: TS 38.508-1 [4], table 4.7.2-1 | | | |
|---|--|---------|-----------|
| Information Element | Value/Remark | Comment | Condition |
| S-NSSAI | Same as the S-NSSAI of PDU session X in the Preamble | | |
| DNN | Same as the DN of PDU session X in the Preamble | | |

10.1.5 UE-requested PDU session modification

10.1.5.1 UE-requested PDU session modification

10.1.5.1.1 Test Purpose (TP)

(1)

```

with { UE in PDU SESSION ACTIVE state and in 5GMM-CONNECTED mode }
ensure that {
  when { UE is requested to modify of PDU session }
  then { UE sends a PDU SESSION MODIFICATION REQUEST message }
}

```

10.1.5.1.2 Conformance requirements

References: The conformance requirements covered in the present TC are specified in: TS 24.501, clause 6.4.2.1 and 6.4.2.2. Unless otherwise stated these are Rel-15 requirements.

[TS 24.501, clause 6.4.2.1]

The purpose of the UE-requested PDU session modification procedure is:

- a) to enable the UE to request modification of a PDU session;
- b) to indicate a change of 3GPP PS data off UE status for a PDU session;
- c) to revoke the previously indicated support for reflective QoS;
- d) to request specific QoS handling and segregation of service data flows;
- e) to indicate to the network the relevant 5GSM parameters and capabilities (e.g. the UE's 5GSM capabilities, whether the UE supports more than 16 packet filters, the maximum data rate per UE for user-plane integrity protection supported by the UE for uplink and the maximum data rate per UE for user-plane integrity protection supported by the UE for downlink) for a PDN connection established when in S1 mode, after the first inter-system change from S1 mode to N1 mode, if the UE is operating in single-registration mode in the network supporting N26 interface; or

f) to delete one or more mapped EPS bearer contexts.

NOTE: The UE does not request a PDU session modification for an LADN when the UE is located outside the LADN service area.

[TS 24.501, clause 6.4.2.2]

In order to initiate the UE-requested PDU session modification procedure, the UE shall create a PDU SESSION MODIFICATION REQUEST message.

The UE shall allocate a PTI value currently not used and shall set the PTI IE of the PDU SESSION MODIFICATION REQUEST message to the allocated PTI value.

The UE shall not perform the UE-requested PDU session modification procedure for an emergency PDU session.

The UE shall not perform the UE-requested PDU session modification procedure for a PDU session for LADN when the UE is located outside the LADN service area.

If the UE requests a specific QoS handling, the UE shall include the requested QoS rules IE indicating requested QoS rules and the requested QoS flow descriptions IE indicating requested QoS flow descriptions for the specific QoS handling. The QoS rules IE includes the packet filters which describe the service data flows requested by the UE. The specific QoS parameters requested by the UE is specified in the QoS flow descriptions IE. If the UE requests the network to bind specific service data flows to a dedicated QoS flow, the UE shall create a new QoS rule by setting the rule operation code to "Create new QoS rule" and shall set the segregation bit to "Segregation requested" for the corresponding QoS rule in the QoS rules IE. The UE shall set the QRI values to "no QoS rule identifier assigned" in the requested QoS rules IE, if the QoS rules are newly created; otherwise, the UE shall set the QRI values to those of the existing QoS rules for which the specific QoS handling applies. The UE shall set the QFI values to "no QoS flow identifier assigned" in the requested QoS flow descriptions IE, if the QoS flow descriptions are newly created; otherwise, the UE shall set the QFI values to the QFIs of the existing QoS flow descriptions for which the specific QoS handling applies.

...

If the UE is performing the PDU session modification procedure to request the deletion of a non-default QoS rule due to errors in QoS operations or packet filters, the UE shall include the 5GSM cause IE in the PDU SESSION MODIFICATION REQUEST message as described in subclause 6.4.1.3.

Even if the timer T3396, T3584, or T3585 is running or is deactivated, the UE shall indicate a change of 3GPP PS data off UE status associated to a PDU session, by including the extended protocol configuration options IE in the PDU SESSION MODIFICATION REQUEST message and setting the 3GPP PS data off UE status.

For a PDN connection established when in S1 mode, after the first inter-system change from S1 mode to N1 mode, if the UE is operating in single-registration mode in the network supporting N26 interface and the UE requests the PDU session to be an always-on PDU session in the 5GS, the UE shall include the Always-on PDU session requested IE and set the value of the IE to "Always-on PDU session requested" in the PDU SESSION MODIFICATION REQUEST message.

The UE shall transport the PDU SESSION MODIFICATION REQUEST message, the PDU session ID, and the request type set to "modification request", using the NAS transport procedure as specified in subclause 5.4.5, and the UE shall start timer T3581 (see example in figure 6.4.2.2.1).

10.1.5.1.3 Test description

10.1.5.1.3.1 Pre-test conditions

System Simulator:

- NGC Cell A.

UE:

- None.

Preamble:

- The UE is in state 3N-A on NGC Cell A with PDU SESSION ACTIVE according to TS 38.508-1[4].

10.1.5.1.3.2 Test procedure sequence

Table 10.1.5.1.3.2-1: Main behaviour

| St | Procedure | Message Sequence | | TP | Verdict |
|----|--|------------------|-----------------------------------|----|---------|
| | | U - S | Message | | |
| 1 | Cause the UE to pdu session modification with the previously established PDN session at preamble. (see Note) | - | - | - | - |
| 2 | Check: Does the UE transmit a PDU SESSION MODIFICATION REQUEST message? | --> | PDU SESSION MODIFICATION REQUEST | 1 | P |
| 3 | The SS transmits an PDU SESSION MODIFICATION COMMAND message. | <-- | PDU SESSION MODIFICATION COMMAND | - | - |
| 4 | the UE transmit an PDU SESSION MODIFICATION COMPLETE message. | --> | PDU SESSION MODIFICATION COMPLETE | - | - |

Note: The request of pdu session modification may be performed by MMI or AT command.

10.1.5.1.3.3 Specific message contents

Table 10.1.5.1.3.3-1: PDU SESSION MODIFICATION COMMAND (step 3, Table 10.1.5.1.3.2-1)

| Derivation path: TS 36.508, Table 4.7.2-9 | | | |
|---|--|---------|-----------|
| Information Element | Value/remark | Comment | Condition |
| PDU session ID | The value indicated in PDU SESSION MODIFICATION REQUEST | | |
| PTI | The value indicated in PDU SESSION MODIFICATION REQUEST | | |
| Authorized QoS rules | According to QoS rule #1 except for Rule operation code set to '100'B and QoS rule precedence set to '0000 0010'- see TS 38.508-1[4] | | |

10.1.6 UE-requested PDU session release

10.1.6.1 UE-requested PDU session release / Abnormal / Collision with network-requested PDU session modification procedure

10.1.6.1.1 Test Purpose (TP)

(1)

```
with { the UE is in PDU SESSION ACTIVE state and has sent a PDU SESSION RELEASE REQUEST message }
ensure that {
  when { UE receives a PDU SESSION MODIFICATION COMMAND message indicating a PDU session that UE
wants to release }
  then { the UE ignores the PDU SESSION MODIFICATION COMMAND message and proceed with the PDU
session release procedure }
}
```

10.1.6.1.2 Conformance requirements

References: The conformance requirements covered in the current TC are specified in: TS 24.501, clause 6.4.3.2, 6.4.3.3 and 6.4.3.5. Unless otherwise stated these are Rel-15 requirements.

[TS 24.501, clause 6.4.3.2]

In order to initiate the UE-requested PDU session release procedure, the UE shall create a PDU SESSION RELEASE REQUEST message.

The UE may set the 5GSM cause IE of the PDU SESSION RELEASE REQUEST message to indicate the reason for releasing the PDU session.

The 5GSM cause IE typically indicates one of the following 5GSM cause values:

- #36 regular deactivation;
- #41 Semantic error in the TFT operation;
- #42 Syntactical error in the TFT operation;
- #44 Semantic errors in packet filter(s);
- #45 Syntactical error in packet filter(s).

The UE shall allocate a PTI value currently not used and shall set the PTI IE of the PDU SESSION RELEASE REQUEST message to the allocated PTI value.

The UE shall transport the PDU SESSION RELEASE REQUEST message and the PDU session ID, using the NAS transport procedure as specified in subclause 5.4.5, and the UE shall start timer T3582 (see example in figure 6.4.3.2.1).

[TS 24.501, clause 6.4.3.3]

Upon receipt of a PDU SESSION RELEASE REQUEST message and a PDU session ID, if the SMF accepts the request to release the PDU session, and shall perform the network-requested PDU session release procedure as specified in subclause 6.3.3.

[TS 24.501, clause 6.4.3.5]

The following abnormal cases can be identified:

- b) Collision of UE-requested PDU session release procedure and network-requested PDU session modification procedure.

When the UE receives a PDU SESSION MODIFICATION COMMAND message during the UE-requested PDU session release procedure, and the PDU session indicated in PDU SESSION MODIFICATION COMMAND message is the PDU session that the UE had requested to release, the UE shall ignore the PDU SESSION MODIFICATION COMMAND message and proceed with the PDU session release procedure.

10.1.6.1.3 Test description

10.1.6.1.3.1 Pre-test conditions

System Simulator:

- NGC Cell A.

UE:

None.

Preamble:

The UE is in state 3N-A on NGC Cell A according to TS 38.508-1 [4].

10.1.6.1.3.2 Test procedure sequence

Table 10.1.6.1.3.2-1: Main behaviour

| St | Procedure | Message Sequence | | TP | Verdict |
|----|---|------------------|----------------------------------|----|---------|
| | | U - S | Message | | |
| 1 | Cause the UE to request establishment of PDU session to the DN.(Note 1) | - | - | - | - |
| 2 | The PDU session establishment procedure as specified in TS 38.508-1 [4] subclause 4.5A.2 take place. | - | - | - | - |
| 3 | Cause the UE to request release of PDU session established during step 2.(Note 2) | - | - | - | - |
| 4 | The UE transmits a PDU SESSION RELEASE REQUEST message. | --> | PDU SESSION RELEASE REQUEST | - | - |
| 5 | The SS transmits a PDU SESSION MODIFICATION COMMAND message. | <-- | PDU SESSION MODIFICATION COMMAND | - | - |
| 6 | Check: Does the UE transmit a PDU SESSION MODIFICATION COMPLETE or PDU SESSION MODIFICATION COMMAND REJECT message in the next 3 seconds? | - | - | 1 | F |
| 7 | Check: Does the UE perform PDU session release procedure defined in clause 4.9.21 of TS 38.508-1 [4]? | - | - | 1 | P |
| 8 | Void | - | - | | |

Note 1: The request to establish a PDU session may be performed by MMI or AT command.
Note 2: The request to release a PDU session may be performed by MMI.

10.1.6.1.3.3 Specific message contents

Table 10.1.6.1.3.3-1: PDU SESSION RELEASE REQUEST (step 4, Table 10.1.6.1.3.2-1)

| Derivation Path: TS 38.508-1 [4] Table 4.7.2-12 | | | |
|---|--|---------|-----------|
| Information Element | Value/remark | Comment | Condition |
| PDU session ID | Set to the ID UE requested in step 2 in Table 10.1.6.1.3.2-1 | | |
| PTI | Any value from 1 to 254 | | |

Table 10.1.6.1.3.3-2: PDU SESSION MODIFICATION COMMAND (step 5, Table 10.1.6.1.3.2-1)

| Derivation Path: TS 38.508-1 [4] Table 4.7.2-9 | | | |
|--|--|--|-----------|
| Information Element | Value/remark | Comment | Condition |
| PDU session ID | Set to the ID UE requested in step 2 in Table 10.1.6.1.3.2-1 | | |
| PTI | '0000 0000'B | No procedure transaction identity assigned | |

Table 10.1.6.1.3.3-3: PDU SESSION RELEASE COMMAND (step 7, Table 10.1.6.1.3.2-1; step 1, TS 36.508 [4] Table 4.9.21.2.2-1)

| Derivation Path: TS 38.508-1 [4] Table 4.7.2-14 | | | |
|---|--|--------------------------|-----------|
| Information Element | Value/remark | Comment | Condition |
| PDU session ID | Same ID as the ID UE requested in step 2 in Table 10.1.6.1.3.2-1 | | |
| PTI | The value indicated in PDU SESSION RELEASE REQUEST | | |
| 5GSM cause | '0010 0100'B | #36 regular deactivation | |

Table 10.1.6.1.3.3-4: PDU SESSION RELEASE COMPLETE (step 8, Table 10.1.6.1.3.2-1; step 2, TS 36.508 [4] Table 4.9.21.2.2-1)

| Derivation Path: TS 38.508-1 [4] Table 4.7.2-15 | | | |
|---|--|---------|-----------|
| Information Element | Value/remark | Comment | Condition |
| PDU session ID | Same ID as the ID UE requested in step 2 in Table 10.1.6.1.3.2-1 | | |
| PTI | The value indicated in PDU SESSION RELEASE REQUEST | | |

10.1.6.2 UE-requested PDU session release / Abnormal / Collision with network-requested PDU session release procedure

10.1.6.2.1 Test Purpose (TP)

(1)

```

with { the UE is in PDU SESSION ACTIVE state and transported the PDU SESSION RELEASE REQUEST message
}
ensure that {
  when { UE receives a PDU SESSION RELEASE COMMAND message with the PTI IE set to "No procedure
transaction identity assigned" indicating a PDU session that UE wants to release }
  then { the UE aborts the UE-requested PDU session release procedure and proceeds with the
network-requested PDU session release procedure }
}

```

10.1.6.2.2 Conformance requirements

References: The conformance requirements covered in the current TC are specified in: TS 24.501, clause 6.4.3.2, 6.4.3.3 and 6.4.3.5. Unless otherwise stated these are Rel-15 requirements.

[TS 24.501, clause 6.4.3.2]

In order to initiate the UE-requested PDU session release procedure, the UE shall create a PDU SESSION RELEASE REQUEST message.

The UE may set the 5GSM cause IE of the PDU SESSION RELEASE REQUEST message to indicate the reason for releasing the PDU session.

The 5GSM cause IE typically indicates one of the following 5GSM cause values:

- #36 regular deactivation;
- #41 Semantic error in the TFT operation;
- #42 Syntactical error in the TFT operation;

#44 Semantic errors in packet filter(s);

#45 Syntactical error in packet filter(s).

The UE shall allocate a PTI value currently not used and shall set the PTI IE of the PDU SESSION RELEASE REQUEST message to the allocated PTI value.

The UE shall transport the PDU SESSION RELEASE REQUEST message and the PDU session ID, using the NAS transport procedure as specified in subclause 5.4.5, and the UE shall start timer T3582 (see example in figure 6.4.3.2.1).

[TS 24.501, clause 6.4.3.3]

Upon receipt of a PDU SESSION RELEASE REQUEST message and a PDU session ID, if the SMF accepts the request to release the PDU session, and shall perform the network-requested PDU session release procedure as specified in subclause 6.3.3.

[TS 24.501, clause 6.4.3.5]

The following abnormal cases can be identified:

...

- c) Collision of UE-requested PDU session release procedure and network-requested PDU session release procedure.

When the UE receives a PDU SESSION RELEASE COMMAND message with the PTI IE set to "No procedure transaction identity assigned" during the UE-requested PDU session release procedure, and the PDU session indicated in the PDU SESSION RELEASE COMMAND message is the same as the PDU session that the UE requests to release, the UE shall abort the UE-requested PDU session release procedure and proceed with the network-requested PDU session release procedure.

10.1.6.2.3 Test description

10.1.6.2.3.1 Pre-test conditions

System Simulator:

- NGC Cell A.

UE:

None.

Preamble:

- The UE is in state 3N-A on NGC Cell A according to TS 38.508-1 [4].

10.1.6.2.3.2 Test procedure sequence

Table 10.1.6.2.3.2-1: Main behaviour

| St | Procedure | Message Sequence | | TP | Verdict |
|----|---|------------------|-----------------------------|----|---------|
| | | U - S | Message | | |
| 1 | Cause the UE to request establishment of PDU session to the DN.(Note 1) | - | - | - | - |
| 2 | The PDU session establishment procedure as specified in TS 38.508-1 [4] subclause 4.5A.2 take place. | - | - | - | - |
| 3 | Cause the UE to request release of PDU session established during step 2.(Note 2) | - | - | - | - |
| 4 | The UE transmits a PDU SESSION RELEASE REQUEST message. | --> | PDU SESSION RELEASE REQUEST | - | - |
| 5 | Check: Does the UE perform PDU session release procedure defined in clause 4.9.21 of TS 38.508-1 [4]? | - | - | 1 | P |
| 6 | Void | - | - | - | - |

Note 1: The request to establish a PDU session may be performed by MMI or AT command.
Note 2: The request to release a PDU session may be performed by MMI.

10.1.6.2.3.3 Specific message contents

Table 10.1.6.2.3.3-1: PDU SESSION RELEASE REQUEST (step 4, Table 10.1.6.2.3.2-1)

| Derivation Path: TS 38.508-1 [4] Table 4.7.2-12 | | | |
|---|--|---------|-----------|
| Information Element | Value/remark | Comment | Condition |
| PDU session ID | Set to the ID UE requested in step 2 in Table 10.1.6.2.3.2-1 | | |
| PTI | Any value from 1 to 254 | | |

Table 10.1.6.2.3.3-2: PDU SESSION RELEASE COMMAND (step 5, Table 10.1.6.2.3.2-1; step 1, TS 36.508 [4] Table 4.9.21.2.2-1)

| Derivation Path: TS 38.508-1 [4] Table 4.7.2-14 | | | |
|---|--|--|-----------|
| Information Element | Value/remark | Comment | Condition |
| PDU session ID | Set to the ID UE requested in step 2 in Table 10.1.6.2.3.2-1 | | |
| PTI | '0000 0000'B | No procedure transaction identity assigned | |
| 5GSM cause | '0010 0100'B | #36 regular deactivation | |

Table 10.1.6.2.3.3-3: PDU SESSION RELEASE COMPLETE (step 6, Table 10.1.6.2.3.2-1; step 2, TS 36.508 [4] Table 4.9.21.2.2-1)

| Derivation Path: TS 38.508-1 [4] Table 4.7.2-15 | | | |
|---|--|------------|-----------|
| Information Element | Value/remark | Comment | Condition |
| PDU session ID | Set to the ID UE requested in step 2 in Table 10.1.6.2.3.2-1 | | |
| PTI | '0000 0000'B | unassigned | |

10.2 EN-DC session management

10.2.1 Network initiated procedures

10.2.1.1 Default EPS bearer context activation

10.2.1.1.1 Test Purpose (TP)

(1)

```
with { UE has sent a PDN CONNECTIVITY REQUEST message }
ensure that {
  when { UE receives an RRCConnectionReconfiguration message including an ACTIVATE DEFAULT EPS
  BEARER CONTEXT REQUEST message with IE Procedure transaction identity matching the PDN CONNECTIVITY
  REQUEST message and including the Extended APN-AMBR IE }
  then { UE transmits an ACTIVATE DEFAULT EPS BEARER CONTEXT ACCEPT message and enters BEARER
  CONTEXT ACTIVE state }
}
```

10.2.1.1.2 Conformance requirements

References: The conformance requirements covered in the present TC are specified in: TS 24.301, clause 6.4.1.3, 8.3.6.17 and 9.9.4.29. Unless otherwise stated these are Rel-15 requirements.

[TS 24.301, clause 6.4.1.3]

Upon receipt of the ACTIVATE DEFAULT EPS BEARER CONTEXT REQUEST message, if the UE provided an APN for the establishment of the PDN connection, the UE shall stop timer T3396 if it is running for the APN provided by the UE. If the UE did not provide an APN for the establishment of the PDN connection and the request type was different from "emergency" and from "handover of emergency bearer services", the UE shall stop the timer T3396 associated with no APN if it is running. If the ACTIVATE DEFAULT EPS BEARER CONTEXT REQUEST message was received in response to a request for an emergency PDN connection, the UE shall not stop the timer T3396 associated with no APN if it is running. For any case, the UE shall then send an ACTIVATE DEFAULT EPS BEARER CONTEXT ACCEPT message and enter the state BEARER CONTEXT ACTIVE. When the default bearer is activated as part of the attach procedure, the UE shall send the ACTIVATE DEFAULT EPS BEARER CONTEXT ACCEPT message together with ATTACH COMPLETE message. When the default bearer is activated as the response to the stand-alone PDN CONNECTIVITY REQUEST message, the UE shall send the ACTIVATE DEFAULT EPS BEARER CONTEXT ACCEPT message alone.

If a WLAN offload indication information element is included in the ACTIVATE DEFAULT EPS BEARER CONTEXT REQUEST message, the UE shall store the WLAN offload acceptability values for this PDN connection and use the E-UTRAN offload acceptability value to determine whether this PDN connection is offloadable to WLAN or not.

The UE checks the PTI in the ACTIVATE DEFAULT EPS BEARER CONTEXT REQUEST message to identify the UE requested PDN connectivity procedure to which the default bearer context activation is related (see subclause 6.5.1).

If the UE receives a serving PLMN rate control IE in the ACTIVATE DEFAULT EPS BEARER CONTEXT REQUEST message, the UE shall store the serving PLMN rate control IE value and use the stored serving PLMN rate control value as the maximum allowed limit of uplink User data container IEs included in ESM DATA TRANSPORT messages for the corresponding PDN connection in accordance with 3GPP TS 23.401 [10].

If the UE receives an APN rate control parameters container in the protocol configuration options IE or extended protocol configuration options IE in the ACTIVATE DEFAULT EPS BEARER CONTEXT REQUEST message, the UE shall store the APN rate control parameters value and use the stored APN rate control parameters value as the maximum allowed limit of uplink user data related to the APN indicated in the ACTIVATE DEFAULT EPS BEARER CONTEXT REQUEST message in accordance with 3GPP TS 23.401 [10]. If the UE has a previously stored APN rate control parameters value for this APN, the UE shall replace the stored APN rate control parameters value for this APN with the received APN rate control parameters value.

If the UE receives an additional APN rate control parameters for exception data container in the protocol configuration options IE or extended protocol configuration options IE in the ACTIVATE DEFAULT EPS BEARER CONTEXT REQUEST message, the UE shall store the additional APN rate control parameters for exception data value and use the

stored additional APN rate control parameters for exception data value as the maximum allowed limit of uplink exception data related to the APN indicated in the ACTIVATE DEFAULT EPS BEARER CONTEXT REQUEST message in accordance with 3GPP TS 23.401 [10]. If the UE has a previously stored additional APN rate control parameters for exception data value for this APN, the UE shall replace the stored additional APN rate control parameters for exception data value for this APN with the received additional APN rate control parameters for exception data value.

If the UE receives non-IP Link MTU parameter or IPv4 Link MTU parameter of the protocol configuration options IE in the ACTIVATE DEFAULT EPS BEARER CONTEXT REQUEST message, the UE shall pass the received Non-IP Link MTU or IPv4 Link MTU to the upper layer.

NOTE: The Non-IP Link MTU and the IPv4 Link MTU size correspond to the maximum length of user data that can be sent either in the user data container in the ESM DATA TRANSPORT message or via S1-U interface.

If the UE receives a session-AMBR and QoS rule(s), which correspond to the default EPS bearer of the PDN connectivity being activated, in the protocol configuration options IE or the extended protocol configuration options IE in the ACTIVATE DEFAULT EPS BEARER CONTEXT REQUEST message, the UE stores the session-AMBR and QoS rule(s) for use during inter-system change from S1 mode to N1 mode.

Upon receipt of the ACTIVATE DEFAULT EPS BEARER CONTEXT ACCEPT message, the MME shall enter the state BEARER CONTEXT ACTIVE and stop the timer T3485, if the timer is running. If the PDN CONNECTIVITY REQUEST message included a low priority indicator set to "MS is configured for NAS signalling low priority", the MME shall store the NAS signalling low priority indication within the default EPS bearer context.

[TS 24.301, clause 8.3.6.17]

This IE shall be included in the message only if the network wishes to transmit the APN-AMBR values to the UE for possible uplink policy enforcement and at least one of the values to be transmitted exceeds the maximum value specified in the APN aggregate maximum bit rate information element in subclause 9.9.4.2.

[TS 24.301, clause 9.9.4.29]

The purpose of the extended APN aggregate maximum bit rate information element is to indicate the initial subscribed APN-AMBR with a value higher than 65280 Mbps when the UE establishes a PDN connection or to indicate the new APN-AMBR with a value higher than 65280 Mbps if it is changed by the network.

The receiving entity shall ignore the bit rate values which are included in the extended APN aggregate maximum bit rate information element and not higher than 65280 Mbps.

The extended APN aggregate maximum bit rate information element is coded as shown in figure 9.9.4.29.1 and table 9.9.4.29.1.

The extended APN aggregate maximum bit rate is a type 4 information element with a length of 8 octets.

| 8 | 7 | 6 | 5 | 4 | 3 | 2 | 1 | |
|--|---|---|---|---|---|---|---|---------|
| Extended APN aggregate maximum bit rate IEI | | | | | | | | octet 1 |
| Length of extended APN aggregate maximum bit rate contents | | | | | | | | octet 2 |
| Unit for extended APN-AMBR for downlink | | | | | | | | octet 3 |
| Extended APN-AMBR for downlink | | | | | | | | octet 4 |
| Extended APN-AMBR for downlink (continued) | | | | | | | | octet 5 |
| Unit for extended APN-AMBR for uplink | | | | | | | | octet 6 |
| Extended APN-AMBR for uplink | | | | | | | | octet 7 |
| Extended APN-AMBR for uplink (continued) | | | | | | | | octet 8 |

Figure 9.9.4.29.1: Extended APN aggregate maximum bit rate information element

Table 9.9.4.29.1: Extended APN aggregate maximum bit rate information element

| | |
|---|---|
| Unit for extended APN-AMBR for downlink (octet 3) | |
| 0 0 0 0 0 0 0 0 | value is not used |
| 0 0 0 0 0 0 0 1 | value is not used |
| 0 0 0 0 0 0 1 0 | value is not used |
| 0 0 0 0 0 0 1 1 | value is incremented in multiples of 4 Mbps |
| 0 0 0 0 0 1 0 0 | value is incremented in multiples of 16 Mbps |
| 0 0 0 0 0 1 0 1 | value is incremented in multiples of 64 Mbps |
| 0 0 0 0 0 1 1 0 | value is incremented in multiples of 256 Mbps |
| 0 0 0 0 0 1 1 1 | value is incremented in multiples of 1 Gbps |
| 0 0 0 0 1 0 0 0 | value is incremented in multiples of 4 Gbps |
| 0 0 0 0 1 0 0 1 | value is incremented in multiples of 16 Gbps |
| 0 0 0 0 1 0 1 0 | value is incremented in multiples of 64 Gbps |
| 0 0 0 0 1 0 1 1 | value is incremented in multiples of 256 Gbps |
| 0 0 0 0 1 1 0 0 | value is incremented in multiples of 1 Tbps |
| 0 0 0 0 1 1 0 1 | value is incremented in multiples of 4 Tbps |
| 0 0 0 0 1 1 1 0 | value is incremented in multiples of 16 Tbps |
| 0 0 0 0 1 1 1 1 | value is incremented in multiples of 64 Tbps |
| 0 0 0 1 0 0 0 0 | value is incremented in multiples of 256 Tbps |
| 0 0 0 1 0 0 0 1 | value is incremented in multiples of 1 Pbps |
| 0 0 0 1 0 0 1 0 | value is incremented in multiples of 4 Pbps |
| 0 0 0 1 0 0 1 1 | value is incremented in multiples of 16 Pbps |
| 0 0 0 1 0 1 0 0 | value is incremented in multiples of 64 Pbps |
| 0 0 0 1 0 1 0 1 | value is incremented in multiples of 256 Pbps |
| Other values shall be interpreted as multiples of 256 Pbps in this version of the protocol. | |
| Extended APN-AMBR for downlink (octets 4 and 5) | |
| Octets 4 and 5 represent the binary coded value of extended APN-AMBR for downlink in units defined by octet 3 | |
| Unit for extended APN-AMBR for uplink (octet 6) | |
| The coding is identical to that of the unit for extended APN-AMBR for downlink (octet 3) | |
| Extended APN-AMBR for uplink (octets 7 and 8) | |
| Octets 7 and 8 represent the binary coded value of extended APN-AMBR for uplink in units defined by octet 6. | |

10.2.1.1.3 Test description

10.2.1.1.3.1 Pre-test conditions

System Simulator:

- E-UTRA Cell 1 is the PCell and NR Cell 1 is the PSCell.

UE:

None.

Preamble:

- The UE is in RRC_IDLE state on E-UTRA Cell 1 using generic procedure parameter Connectivity (*EN-DC*) and Bearers (*MCG only*) established according to TS 38.508-1 [4].

10.2.1.1.3.2 Test procedure sequence

Table 10.2.1.1.3.2-1: Main behaviour

| St | Procedure | Message Sequence | | TP | Verdict |
|----|--|------------------|---|----|---------|
| | | U - S | Message | | |
| 1 | Cause the UE to request connectivity to an additional PDN (see Note 1) | - | - | - | - |
| 2 | UE transmit an <i>RRCCConnectionRequest</i> message with <i>establishmentCause</i> set to 'mo-Data' followed by a SERVICE REQUEST message. | --> | SERVICE REQUEST | - | - |
| 3 | The SS establishes SRB2 and DRB associated with default EPS bearer context (a first PDN obtained during the attach procedure). | - | - | - | - |
| 4 | The UE transmit a PDN CONNECTIVITY REQUEST message as specified to request an additional PDN. | --> | PDN CONNECTIVITY REQUEST | - | - |
| 5 | The SS transmits an <i>RRCCConnectionReconfiguration</i> message containing NR <i>RRCCReconfiguration</i> message to add NR <i>PSCell</i> with SCG DRB. The <i>RRCCConnectionReconfiguration</i> message contains ACTIVATE DEFAULT EPS BEARER CONTEXT REQUEST message containing Extended APN-AMBR IE. | <-- | RRC: <i>RRCCConnectionReconfiguration</i> ((<i>RRCCReconfiguration</i>)
NAS: ACTIVATE DEFAULT EPS BEARER CONTEXT REQUEST | - | - |
| 6 | The UE transmits an <i>RRCCConnectionReconfigurationComplete</i> message to confirm the establishment of default bearer. | --> | RRC: <i>RRCCConnectionReconfigurationComplete</i>
(<i>RRCCReconfigurationComplete</i>) | - | - |
| - | EXCEPTION: In parallel to the event described in step 7 below, if initiated by the UE the generic procedure for IP address allocation in the U-plane specified in TS 36.508 subclause 4.5A.1 takes place performing IP address allocation in the U-plane. | - | - | - | - |
| 7 | The UE transmits ACTIVATE DEFAULT EPS BEARER CONTEXT ACCEPT message. | --> | RRC: <i>ULInformationTransfer</i>
NAS: ACTIVATE DEFAULT EPS BEARER CONTEXT ACCEPT | 1 | P |

Note 1: The request of connectivity to an additional PDN may be performed by MMI or AT command.

10.2.1.1.3.3 Specific message contents

Table 10.2.1.1.3.3-1: PDN CONNECTIVITY REQUEST (step 4, Table 10.2.1.1.3.2-1)

| Derivation path: TS 36.508 [7], Table 4.7.3-20 | | | |
|--|---------------------|--|-----------|
| Information Element | Value/remark | Comment | Condition |
| Protocol discriminator | ESM | | |
| EPS bearer identity | 0 | No EPS bearer identity assigned | |
| Procedure transaction identity | PTI-1 | UE assigns a particular PTI not yet used between 1 and 254 | |
| Access point name | APN-1(New PDN name) | The requested PDN is different from default PDN | |

Table 10.2.1.1.3.3-2: ACTIVATE DEFAULT EPS BEARER CONTEXT REQUEST (step 5, Table 10.2.1.1.3.2-1)

| Derivation Path: TS 36.508 [7], Table 4.7.3-6 | | | |
|---|---|---|-----------|
| Information Element | Value/remark | Comment | Condition |
| Protocol discriminator | ESM | | |
| EPS bearer identity | 6 | | |
| Procedure transaction identity | PTI-1 | SS re-uses the particular PTI defined by UE for this present additional PDN connectivity request procedure. | |
| EPS QoS | | | |
| QCI | 8 | | |
| Maximum bit rate for uplink | 384 kbps | | |
| Maximum bit rate for downlink | '11111110'B (8640 kbps) | | |
| Guaranteed bit rate for uplink | 128 kbps | | |
| Guaranteed bit rate for downlink | 128 kbps | | |
| Maximum bit rate for uplink (extended) | 0 | | |
| Maximum bit rate for downlink (extended) | '11111010'B (256 Mbps) | | |
| Guaranteed bit rate for uplink (extended) | 0 | | |
| Guaranteed bit rate for downlink (extended) | 0 | | |
| Maximum bit rate for uplink (extended-2) | 0 | | |
| Maximum bit rate for downlink (extended-2) | '11110110'B (10 Gbps) | | |
| Guaranteed bit rate for uplink (extended-2) | 0 | | |
| Guaranteed bit rate for downlink (extended-2) | 0 | | |
| APN-AMBR | | | |
| APN-AMBR for downlink | '11111110'B (8640 kbps) | | |
| APN-AMBR for uplink | '11111110'B (8640 kbps) | | |
| APN-AMBR for downlink (extended) | '11111010' B(256 Mbps) | | |
| APN-AMBR for uplink (extended) | '11111010' B(256 Mbps) | | |
| APN-AMBR for downlink (extended-2) | '11111110'B (65280 Mbps) | | |
| APN-AMBR for uplink (extended-2) | 0 | | |
| Access point name | APN-1 | SS re-uses the particular APN defined by UE for this present additional PDN connectivity request procedure | |
| Extended APN-AMBR | | | |
| Unit for extended APN-AMBR for downlink | '00000111'B (value is incremented in multiples of 1 Gbps) | | |
| Extended APN-AMBR for downlink | '0000000010000000' (128 Gbps) | | |
| Unit for extended APN-AMBR for uplink | 0 | | |
| Extended APN-AMBR for uplink | 0 | | |

10.2.1.2 Dedicated EPS bearer context activation

10.2.1.2.1 Test Purpose (TP)

(1)

```

with { UE in EMM-REGISTERED state }
ensure that {
  when { UE receives an ACTIVATE DEDICATED EPS BEARER CONTEXT REQUEST message, including the
  Extended EPS QoS IE, linked to the existing default EPS bearer }
  then { UE transmits an ACTIVATE DEDICATED EPS BEARER CONTEXT ACCEPT }
}

```

(2)

```

with { the UE in BEARER CONTEXT ACTIVE STATE and in EMM-CONNECTED mode }
ensure that {
  when { the UE receives a MODIFY EPS BEARER CONTEXT REQUEST message including the Extended EPS QoS
and Extended APN-AMBR IEs }
  then { UE transmits a MODIFY EPS BEARER CONTEXT ACCEPT }
}

```

10.2.1.2.2 Conformance requirements

References: The conformance requirements covered in the present TC are specified in: TS 24.301, clauses 6.4.2.3, 6.4.3.1, 6.4.3.2, 6.4.3.3, 8.3.3.11, 9.9.4.29 and 9.9.4.30. Unless otherwise stated these are Rel-15 requirements.

[TS 24.301, clause 6.4.2.3]

Upon receipt of the ACTIVATE DEDICATED EPS BEARER CONTEXT REQUEST message, if the UE provided an APN for the establishment of the PDN connection, the UE shall stop timer T3396, if it is running for the APN provided by the UE. If the UE did not provide an APN for the establishment of the PDN connection and the request type was different from "emergency" and from "handover of emergency bearer services", the UE shall stop the timer T3396 associated with no APN if it is running. If the ACTIVATE DEDICATED EPS BEARER CONTEXT REQUEST message was received for an emergency PDN connection, the UE shall not stop the timer T3396 associated with no APN if it is running. For any case, the UE shall then check the received TFT before taking it into use, send an ACTIVATE DEDICATED EPS BEARER CONTEXT ACCEPT message and enter the state BEARER CONTEXT ACTIVE. The ACTIVATE DEDICATED EPS BEARER CONTEXT ACCEPT message shall include the EPS bearer identity.

The linked EPS bearer identity included in the ACTIVATE DEDICATED EPS BEARER CONTEXT REQUEST message indicates to the UE to which default bearer, IP address and PDN the dedicated bearer is linked.

If the ACTIVATE DEDICATED EPS BEARER CONTEXT REQUEST message contains a PTI value other than "no procedure transaction identity assigned" and "reserved" (see 3GPP TS 24.007 [12]), the UE uses the PTI to identify the UE requested bearer resource allocation procedure or the UE requested bearer resource modification procedure to which the dedicated bearer context activation is related.

[TS 24.301, clause 6.4.3.1]

The purpose of the EPS bearer context modification procedure is to modify an EPS bearer context with a specific QoS and TFT, or re-negotiate header compression configuration associated to an EPS bearer context. The EPS bearer context modification procedure is initiated by the network, but it may also be initiated as part of the UE requested bearer resource allocation procedure or the UE requested bearer resource modification procedure.

The network may also initiate the EPS bearer context modification procedure to update the APN-AMBR of the UE, for instance after an inter-system handover. See 3GPP TS 23.401 [10] annex E.

[TS 24.301, clause 6.4.3.2]

The MME shall initiate the EPS bearer context modification procedure by sending a MODIFY EPS BEARER CONTEXT REQUEST message to the UE, starting the timer T3486, and entering the state BEARER CONTEXT MODIFY PENDING (see example in figure 6.4.3.2.1).

The MME shall include an EPS bearer identity that identifies the EPS bearer context to be modified in the MODIFY EPS BEARER CONTEXT REQUEST message.

[TS 24.301, clause 6.4.3.3]

Upon receipt of the MODIFY EPS BEARER CONTEXT REQUEST message, if the UE provided an APN for the establishment of the PDN connection, the UE shall stop timer T3396, if it is running for the APN provided by the UE. If the UE did not provide an APN for the establishment of the PDN connection and the request type was different from "emergency" and from "handover of emergency bearer services", the UE shall stop the timer T3396 associated with no APN if it is running. If the MODIFY EPS BEARER CONTEXT REQUEST message was received for an emergency PDN connection, the UE shall not stop the timer T3396 associated with no APN if it is running. For any case, the UE shall then check the received TFT before taking it into use and send a MODIFY EPS BEARER CONTEXT ACCEPT message to the MME.

If the MODIFY EPS BEARER CONTEXT REQUEST message contains a PTI value other than "no procedure transaction identity assigned" and "reserved" (see 3GPP TS 24.007 [12]), the UE uses the PTI to identify the UE requested bearer resource allocation procedure or the UE requested bearer resource modification procedure to which the EPS bearer context modification is related (see subclause 6.5.3 and subclause 6.5.4).

If the MODIFY EPS BEARER CONTEXT REQUEST message contains a PTI value other than "no procedure transaction identity assigned" and "reserved" (see 3GPP TS 24.007 [12]) and the PTI is associated to a UE requested bearer resource allocation procedure or a UE requested bearer resource modification procedure, the UE shall release the traffic flow aggregate description associated to the PTI value provided.

...

Upon receipt of the MODIFY EPS BEARER CONTEXT ACCEPT message, the MME shall stop the timer T3486 and enter the state BEARER CONTEXT ACTIVE.

[TS 24.301, clause 8.3.3.11]

This IE shall be included in the message only if the network wishes to transmit the maximum and guaranteed bit rate values to the UE and at least one of the values to be transmitted exceeds the maximum value specified in the EPS quality of service information element in subclause 9.9.4.3

[TS 24.301, clause 9.9.4.29]

The purpose of the extended APN aggregate maximum bit rate information element is to indicate the initial subscribed APN-AMBR with a value higher than 65280 Mbps when the UE establishes a PDN connection or to indicate the new APN-AMBR with a value higher than 65280 Mbps if it is changed by the network.

The receiving entity shall ignore the bit rate values which are included in the extended APN aggregate maximum bit rate information element and not higher than 65280 Mbps.

The extended APN aggregate maximum bit rate information element is coded as shown in figure 9.9.4.29.1 and table 9.9.4.29.1.

The extended APN aggregate maximum bit rate is a type 4 information element with a length of 8 octets

[TS 24.301, clause 9.9.4.30]

The purpose of the Extended EPS quality of service information element is to indicate for an EPS bearer context the maximum bit rates for uplink and downlink and the guaranteed bit rates for uplink and downlink, if at least one of the bit rates has a value higher than 10 Gbps.

The Extended EPS quality of service information element is coded as shown in figure 9.9.4.30.1 and table 9.9.4.30.1. For uplink and downlink, if sending entity only has to indicate one bit rate (i.e., with a value higher than 10 Gbps), it shall encode the other bit rate (i.e., with a value smaller or equal to 10 Gbps) as "00000000". The receiving entity shall ignore the bit rate which is included in the extended quality of service information element and has a value smaller or equal to 10 Gbps.

10.2.1.2.3 Test description

10.2.1.2.3.1 Pre-test conditions

System Simulator:

- E-UTRA Cell 1 is the PCell and NR Cell 1 is the PSCell.

UE:

- None.

Preamble:

- The UE is in RRC_IDLE state on E-UTRA Cell 1 using generic procedure parameter Connectivity (EN-DC) according to TS 38.508-1 [4].

10.2.1.2.3.2 Test procedure sequence

Table 10.2.1.2.3.2-1: Main behaviour

| St | Procedure | Message Sequence | | TP | Verdict |
|---|---|------------------|--|----|---------|
| | | U - S | Message | | |
| 1-6 | Steps 1 to 6 of generic procedure defined in clause 4.5.4 in TS 38.508-1 [4]. | - | - | - | - |
| 7 | The SS configures a dedicated EPS bearer associated with the default EPS bearer context by sending ACTIVATE DEDICATED EPS BEARER CONTEXT REQUEST including the Extended QoS IE.
(See Note 1 and Note 2). | <-- | NAS: ACTIVATE DEDICATED EPS BEARER CONTEXT REQUEST | - | - |
| 8 | Check: Does the UE transmit an ACTIVATE DEDICATED EPS BEARER CONTEXT ACCEPT message as specified? | --> | ACTIVATE DEDICATED EPS BEARER CONTEXT ACCEPT | 1 | P |
| 9 | The SS transmits a MODIFY EPS BEARER CONTEXT REQUEST message with Extended EPS QoS and Extended APN-AMBR IEs. This message is included in a DLInformationTransfer message. | <-- | MODIFY EPS BEARER CONTEXT REQUEST | - | - |
| 10 | Check: Does the UE transmit a MODIFY EPS BEARER CONTEXT ACCEPT message? | --> | MODIFY EPS BEARER CONTEXT ACCEPT | 2 | P |
| Note 1: The ACTIVATE DEDICATED EPS BEARER CONTEXT REQUEST message is included in a <i>RRCCConnectionReconfiguration</i> message including a DRB setup for the same EPS bearer ID. | | | | | |
| Note 2: The <i>RRCCConnectionReconfiguration</i> uses the condition for DC bearer MCG and SCG | | | | | |

10.2.1.2.3.3 Specific message contents

Table 10.2.1.2.3.3-1: ACTIVATE DEDICATED EPS BEARER CONTEXT REQUEST (step 7, Table 10.2.1.2.3.2-1)

| Derivation Path: TS 38.508-1[4], Table 4.5.4.3-1 | | | |
|--|--|--|-----------|
| Information Element | Value/remark | Comment | Condition |
| Protocol discriminator | ESM | | |
| EPS bearer identity | 6 | | |
| Procedure transaction identity | '0000 0000'B | No procedure transaction identity assigned | |
| EPS QoS | | | |
| QCI | 8 | | |
| Maximum bit rate for uplink | '01101000'B (384) kbps | | |
| Maximum bit rate for downlink | '11111110'B (8640) kbps | | |
| Guaranteed bit rate for uplink | '01001000'B (128) kbps | | |
| Guaranteed bit rate for downlink | '01001000'B (128) kbps | | |
| Maximum bit rate for uplink (extended) | 0 | | |
| Maximum bit rate for downlink (extended) | '11111010'B (256) Mbps | | |
| Guaranteed bit rate for uplink (extended) | 0 | | |
| Guaranteed bit rate for downlink (extended) | 0 | | |
| Maximum bit rate for uplink (extended-2) | 0 | | |
| Maximum bit rate for downlink (extended-2) | '11110110'B (10) Gbps | | |
| Guaranteed bit rate for uplink (extended-2) | 0 | | |
| Guaranteed bit rate for downlink (extended-2) | 0 | | |
| Extended EPS QoS | | | |
| Unit for maximum bit rate | '00000111' (value is incremented in multiples of 1 Gbps) | | |
| Maximum bit rate for uplink | '0000000000000000'B | | |
| Maximum bit rate for downlink | '000000000001100'B (12) Gbps | | |
| Unit for guaranteed bit rate | '00000000'B | | |
| Guaranteed bit rate for uplink | '00000000'B | | |
| Guaranteed bit rate for downlink | '00000000'B | | |

Table 10.2.1.2.3.3-2: MODIFY EPS BEARER CONTEXT REQUEST (step 9, Table 10.2.1.2.3.2-1)

| Derivation path: TS 36.508 [7], Table 4.7.3-18 | | | |
|--|---|---------|-----------|
| Information Element | Value/Remark | Comment | Condition |
| New EPS QoS | | | |
| QCI | 8 | | |
| Maximum bit rate for uplink | '01101000'B (384 kbps) | | |
| Maximum bit rate for downlink | '11111110'B (8640 kbps) | | |
| Guaranteed bit rate for uplink | '01001000'B (128 kbps) | | |
| Guaranteed bit rate for downlink | '01001000'B (128 kbps) | | |
| Maximum bit rate for uplink (extended) | 0 | | |
| Maximum bit rate for downlink (extended) | '11111010'B (256 Mbps) | | |
| Guaranteed bit rate for uplink (extended) | 0 | | |
| Guaranteed bit rate for downlink (extended) | 0 | | |
| Maximum bit rate for uplink (extended-2) | 0 | | |
| Maximum bit rate for downlink (extended-2) | '11110110'B (10 Gbps) | | |
| Guaranteed bit rate for uplink (extended-2) | 0 | | |
| Guaranteed bit rate for downlink (extended-2) | 0 | | |
| APN-AMBR | | | |
| APN-AMBR for downlink | '11111110'B (8640 kbps) | | |
| APN-AMBR for uplink | '11111110'B (8640 kbps) | | |
| APN-AMBR for downlink (extended) | '11111010' B(256 Mbps) | | |
| APN-AMBR for uplink (extended) | '11111010' B(256 Mbps) | | |
| APN-AMBR for downlink (extended-2) | '11111110'B (65280 Mbps) | | |
| APN-AMBR for uplink (extended-2) | 0 | | |
| Extended APN-AMBR | | | |
| Unit for extended APN-AMBR for downlink | '00000111'B (value is incremented in multiples of 1 Gbps) | | |
| Extended APN-AMBR for downlink | '0000000010000000' (128 Gbps) | | |
| Unit for extended APN-AMBR for uplink | 0 | | |
| Extended APN-AMBR for uplink | 0 | | |
| Extended EPS QoS | | | |
| Unit for maximum bit rate | '00000111' (value is incremented in multiples of 1 Gbps) | | |
| Maximum bit rate for uplink | '0000000000000000'B | | |
| Maximum bit rate for downlink | '0000000000001110'B | | |
| Unit for guaranteed bit rate | '00000000'B | | |
| Guaranteed bit rate for uplink | '00000000'B | | |
| Guaranteed bit rate for downlink | '00000000'B | | |

10.2.2 UE initiated procedures

10.2.2.1 EPS bearer resource allocation / modification

10.2.2.1.1 Test Purpose (TP)

(1)

```
with { UE in PROCEDURE TRANSACTION INACTIVE state and in EMM-IDLE mode }
ensure that {
  when { UE is requested to allocate bearer resource using Extended EPS QoS }
  then { UE sends a BEARER RESOURCE ALLOCATION REQUEST including the Extended EPS QoS IE }
}
```

(2)

```
with { UE has sent the BEARER RESOURCE ALLOCATION REQUEST message }
ensure that {
  when { UE receives an ACTIVATE DEDICATED EPS BEARER CONTEXT REQUEST message with the procedure
transaction identity (PTI) indicated in the BEARER RESOURCE ALLOCATION REQUEST message }
}
```

```

    then { UE sends an ACTIVATE DEDICATED EPS BEARER CONTEXT ACCEPT message }
  }

```

(3)

```

with { UE in PROCEDURE TRANSACTION INACTIVE state and in EMM-CONNECTED mode }
ensure that {
  when { UE is requested to modify of bearer resource corresponding to the dedicated bearer using
Extended EPS QoS }
    then { UE sends a BEARER RESOURCE MODIFICATION REQUEST message including the Extended EPS QoS IE
  }
}

```

(4)

```

with { UE having sent the BEARER RESOURCE MODIFICATION REQUEST message }
ensure that {
  when { UE receives an MODIFY EPS BEARER CONTEXT REQUEST message with the procedure transaction
identity (PTI) indicated in the BEARER RESOURCE MODIFICATION REQUEST message }
    then { UE sends a MODIFY EPS BEARER CONTEXT ACCEPT message }
}

```

10.2.2.1.2 Conformance requirements

References: The conformance requirements covered in the present TC are specified in: TS 24.301, clauses 6.4.2.3, 6.5.3.2, 6.5.3.3, 6.5.4.2, 6.5.4.3, 8.3.8, 8.3.10 and 9.9.4.30. Unless otherwise stated these are Rel-15 requirements.

[TS 24.301, clause 6.4.2.3]

The linked EPS bearer identity included in the ACTIVATE DEDICATED EPS BEARER CONTEXT REQUEST message indicates to the UE to which default bearer, IP address and PDN the dedicated bearer is linked.

If the ACTIVATE DEDICATED EPS BEARER CONTEXT REQUEST message contains a PTI value other than "no procedure transaction identity assigned" and "reserved" (see 3GPP TS 24.007 [12]), the UE uses the PTI to identify the UE requested bearer resource allocation procedure or the UE requested bearer resource modification procedure to which the dedicated bearer context activation is related.

[TS 24.301, clause 6.5.3.2]

In order to request the allocation of bearer resources for one traffic flow aggregate, the UE shall send a BEARER RESOURCE ALLOCATION REQUEST message to the MME, start timer T3480 and enter the state PROCEDURE TRANSACTION PENDING (see example in figure 6.5.3.2.1).

The UE shall include the EPS bearer identity of the default EPS bearer associated with the requested bearer resource in the Linked EPS bearer identity IE. The UE shall set the TFT operation code in the Traffic flow aggregate IE to "Create new TFT". The packet filters in the Traffic flow aggregate IE shall include at least one packet filter applicable for the uplink direction. In the Required traffic flow QoS IE, the UE shall indicate a QCI and, if the UE also includes a GBR, the additional GBR required for the traffic flow aggregate.

[TS 24.301, clause 6.5.3.3]

If the bearer resource allocation requested is accepted by the network, the MME shall initiate either a dedicated EPS bearer context activation procedure or an EPS bearer context modification procedure. Upon receipt of an ACTIVATE DEDICATED EPS BEARER CONTEXT REQUEST or MODIFY EPS BEARER CONTEXT REQUEST message with a PTI which matches the value used for the BEARER RESOURCE ALLOCATION REQUEST message, the UE shall stop timer T3480 and enter the state PROCEDURE TRANSACTION INACTIVE. The UE should ensure that the procedure transaction identity (PTI) assigned to this procedure is not released immediately. The way to achieve this is implementation dependent. While the PTI value is not released, the UE regards any received ACTIVATE DEDICATED EPS BEARER CONTEXT REQUEST or MODIFY EPS BEARER CONTEXT REQUEST message with the same PTI value as a network retransmission (see subclause 7.3.1).

If the ACTIVATE DEDICATED EPS BEARER CONTEXT REQUEST message is received, the UE shall verify that the EPS bearer identity given in the EPS bearer identity IE is not already used by any EPS bearer context. The UE shall then proceed as described in subclause 6.4.2.3 or subclause 6.4.2.4.

[TS 24.301, clause 6.5.4.2]

In order to request the modification of bearer resources for one traffic flow aggregate, the UE shall send a BEARER RESOURCE MODIFICATION REQUEST message to the MME, start timer T3481 and enter the state PROCEDURE TRANSACTION PENDING (see example in figure 6.5.4.2.1).

[TS 24.301, clause 6.5.4.3]

Upon receipt of the BEARER RESOURCE MODIFICATION REQUEST message, the MME checks whether the resources requested by the UE can be established, modified or released by verifying the EPS bearer identity given in the EPS bearer identity for packet filter IE.

If the bearer resource modification requested is accepted by the network, the MME shall initiate either a dedicated EPS bearer context activation procedure, an EPS bearer context modification procedure or an EPS bearer context deactivation procedure.

...

Upon receipt of an ACTIVATE DEDICATED EPS BEARER CONTEXT REQUEST, MODIFY EPS BEARER CONTEXT REQUEST or DEACTIVATE EPS BEARER CONTEXT REQUEST message with a PTI which matches the value used for the BEARER RESOURCE MODIFICATION REQUEST message, the UE shall stop timer T3481 and enter the state PROCEDURE TRANSACTION INACTIVE. The UE should ensure that the procedure transaction identity (PTI) assigned to this procedure is not released immediately. The way to achieve this is implementation dependent. While the PTI value is not released, the UE regards any received ACTIVATE DEDICATED EPS BEARER CONTEXT REQUEST or MODIFY EPS BEARER CONTEXT REQUEST message with the same PTI value as a network retransmission (see subclause 7.3.1).

- i) If the ACTIVATE DEDICATED EPS BEARER CONTEXT REQUEST message is received, the UE shall verify that the EPS bearer identity given in the EPS bearer identity IE is not already used by any EPS bearer context. The UE shall then proceed as described in subclause 6.4.2.3 or subclause 6.4.2.4.

[TS 24.301, clause 8.3.8]

This IE shall be included in the message only if the UE wishes to transmit the maximum and guaranteed bit rate values to the network and at least one of the values to be transmitted exceeds the maximum value specified in the EPS quality of service information element in subclause 9.9.4.3.

[TS 24.301, clause 8.3.10]

This IE shall be included in the message only if the UE wishes to transmit the maximum and guaranteed bit rate values to the network and at least one of the values to be transmitted exceeds the maximum value specified in the EPS quality of service information element in subclause 9.9.4.3.

[TS 24.301, clause 9.9.4.30]

The purpose of the Extended quality of service information element is to indicate for an EPS bearer context the maximum bit rates for uplink and downlink and the guaranteed bit rates for uplink and downlink, if at least one of the bit rates has a value higher than 10 Gbps.

The Extended quality of service information element is coded as shown in figure 9.9.4.30.1 and table 9.9.4.30.1. For uplink and downlink, if the sending entity only has to indicate one bit rate (i.e., with a value higher than 10 Gbps), it shall encode the other bit rate (i.e., with a value smaller or equal to 10 Gbps) as "00000000". The receiving entity shall ignore a bit rate which is included in the extended quality of service information element and has a value smaller or equal to 10 Gbps.

The Extended quality of service is a type 4 information element with a length of 12 octets.

| 8 | 7 | 6 | 5 | 4 | 3 | 2 | 1 | |
|--|---|---|---|---|---|---|---|----------|
| Extended quality of service IEI | | | | | | | | octet 1 |
| Length of Extended quality of service contents | | | | | | | | octet 2 |
| Unit for maximum bit rate | | | | | | | | octet 3 |
| Maximum bit rate for uplink | | | | | | | | octet 4 |
| Maximum bit rate for uplink (continued) | | | | | | | | octet 5 |
| Maximum bit rate for downlink | | | | | | | | octet 6 |
| Maximum bit rate for downlink (continued) | | | | | | | | octet 7 |
| Unit for guaranteed bit rate | | | | | | | | octet 8 |
| Guaranteed bit rate for uplink | | | | | | | | octet 9 |
| Guaranteed bit rate for uplink (continued) | | | | | | | | octet 10 |
| Guaranteed bit rate for downlink | | | | | | | | octet 11 |
| Guaranteed bit rate for downlink (continued) | | | | | | | | octet 12 |

Figure 9.9.4.30.1: Extended quality of service information element

Table 9.9.4.30.1: Extended quality of service information element

| | |
|--|---|
| Unit for maximum bit rate (octet 3) | |
| 0 0 0 0 0 0 0 0 | value is not used |
| 0 0 0 0 0 0 0 1 | value is incremented in multiples of 200 kbps |
| 0 0 0 0 0 0 1 0 | value is incremented in multiples of 1 Mbps |
| 0 0 0 0 0 0 1 1 | value is incremented in multiples of 4 Mbps |
| 0 0 0 0 0 1 0 0 | value is incremented in multiples of 16 Mbps |
| 0 0 0 0 0 1 0 1 | value is incremented in multiples of 64 Mbps |
| 0 0 0 0 0 1 1 0 | value is incremented in multiples of 256 Mbps |
| 0 0 0 0 0 1 1 1 | value is incremented in multiples of 1 Gbps |
| 0 0 0 0 1 0 0 0 | value is incremented in multiples of 4 Gbps |
| 0 0 0 0 1 0 0 1 | value is incremented in multiples of 16 Gbps |
| 0 0 0 0 1 0 1 0 | value is incremented in multiples of 64 Gbps |
| 0 0 0 0 1 0 1 1 | value is incremented in multiples of 256 Gbps |
| 0 0 0 0 1 1 0 0 | value is incremented in multiples of 1 Tbps |
| 0 0 0 0 1 1 0 1 | value is incremented in multiples of 4 Tbps |
| 0 0 0 0 1 1 1 0 | value is incremented in multiples of 16 Tbps |
| 0 0 0 0 1 1 1 1 | value is incremented in multiples of 64 Tbps |
| 0 0 0 1 0 0 0 0 | value is incremented in multiples of 256 Tbps |
| 0 0 0 1 0 0 0 1 | value is incremented in multiples of 1 Pbps |
| 0 0 0 1 0 0 1 0 | value is incremented in multiples of 4 Pbps |
| 0 0 0 1 0 0 1 1 | value is incremented in multiples of 16 Pbps |
| 0 0 0 1 0 1 0 0 | value is incremented in multiples of 64 Pbps |
| 0 0 0 1 0 1 0 1 | value is incremented in multiples of 256 Pbps |
| Other values shall be interpreted as multiples of 256 Pbps in this version of the protocol. | |
| Maximum bit rate for uplink (octets 4 and 5) | |
| Octets 4 and 5 represent the binary coded value of maximum bit rate for uplink in units defined by octet 3. | |
| Maximum bit rate for downlink (octets 6 and 7) | |
| Octets 6 and 7 represent the binary coded value of maximum bit rate for downlink in units defined by octet 3. | |
| Unit for guaranteed bit rate (octet 8) | |
| The coding is identical to that of the unit for maximum bit rate (octet 3). | |
| Guaranteed bit rate for uplink (octets 9 and 10) | |
| Octets 9 and 10 represent the binary coded value of guaranteed bit rate for uplink in units defined by octet 8. | |
| Guaranteed bit rate for downlink (octets 11 and 12) | |
| Octets 11 and 12 represent the binary coded value of guaranteed bit rate for downlink in units defined by octet 8. | |

10.2.2.1.3 Test description

10.2.2.1.3.1 Pre-test conditions

System Simulator:

- E-UTRA Cell 1 and NR Cell 1.

UE:

- None.

Preamble:

- The UE is in state RRC_IDLE using generic procedure parameter Connectivity (*EN-DC*) according to [4].

10.2.2.1.3.2 Test procedure sequence

Table 10.2.2.1.3.2-1: Main behaviour

| St | Procedure | Message Sequence | | TP | Verdict |
|---|---|------------------|---|----|---------|
| | | U - S | Message | | |
| 1 | Cause the UE to request bearer resource allocation of dedicated EPS bearer associated with non-IMS PDN connectivity if pc_MULTI_PDN=TRUE else first PDN connectivity. (Note 1). | - | - | - | - |
| 2 | The UE transmits a SERVICE REQUEST message. | --> | SERVICE REQUEST | - | - |
| 3 | The SS establishes SRB2 and the MCG DRBs associated with the default EPS bearer context activated during the preamble. | - | - | - | - |
| 4 | Check: Does the UE transmit a BEARER RESOURCE ALLOCATION REQUEST message? | --> | BEARER RESOURCE ALLOCATION REQUEST | 1 | P |
| 5 | The SS transmits an ACTIVATE DEDICATED EPS BEARER CONTEXT REQUEST message and establishes a RLC-AM SCG DRB bearer using MCG_and_SCG condition. | <-- | ACTIVATE DEDICATED EPS BEARER CONTEXT REQUEST | - | - |
| 6 | Check: Does the UE transmit an ACTIVATE DEDICATED EPS BEARER CONTEXT ACCEPT message? | --> | ACTIVATE DEDICATED EPS BEARER CONTEXT ACCEPT | 2 | P |
| 7 | Cause the UE to request bearer resource modification of dedicated EPS bearer associated with non-IMS PDN connectivity if pc_MULTI_PDN=TRUE else first PDN connectivity. (Note 2). | - | - | - | - |
| 8 | Check: Does the UE transmit a BEARER RESOURCE MODIFICATION REQUEST message? | --> | BEARER RESOURCE MODIFICATION REQUEST | 3 | P |
| 9 | The SS transmits an ACTIVATE DEDICATED EPS BEARER CONTEXT REQUEST message. | <-- | MODIFY EPS BEARER CONTEXT REQUEST | - | - |
| 10 | Check: Does the UE transmit an ACTIVATE DEDICATED EPS BEARER CONTEXT ACCEPT message? | --> | MODIFY EPS BEARER CONTEXT ACCEPT | 4 | P |
| Note 1: The request is assumed to be triggered by AT command +CGDSCONT, and +CGACT (activated). | | | | | |
| Note 2: The request is assumed to be triggered by AT command +CGCMOD. | | | | | |

10.2.2.1.3.3 Specific message contents

Table 10.2.2.1.3.3-1: Message BEARER RESOURCE ALLOCATION REQUEST (step 4, Table 10.2.2.1.3.2-1)

| Derivation path: TS 36.508 [7], Table 4.7.3-6B | | | |
|---|-------------------------|---------|-----------|
| Information Element | Value/Remark | Comment | Condition |
| Linked EPS bearer identity | 12 | | |
| EPS QoS | | | |
| QCI | 1 | | |
| Maximum bit rate for uplink | 384 kbps | | |
| Maximum bit rate for downlink | '11111110'B (8640 kbps) | | |
| Guaranteed bit rate for uplink | 128 kbps | | |
| Guaranteed bit rate for downlink | 128 kbps | | |
| Maximum bit rate for uplink (extended) | 0 | | |
| Maximum bit rate for downlink (extended) | '11111010'B (256 Mbps) | | |
| Guaranteed bit rate for uplink (extended) | 0 | | |
| Guaranteed bit rate for downlink (extended) | 0 | | |
| Maximum bit rate for uplink (extended-2) | 0 | | |
| Maximum bit rate for downlink (extended-2) | '11110110'B (10 Gbps) | | |
| Guaranteed bit rate for uplink (extended-2) | 0 | | |
| Guaranteed bit rate for downlink (extended-2) | 0 | | |
| Extended EPS QoS | | | |
| Unit for maximum bit rate | Any value(Note1) | | |
| Maximum bit rate for uplink | '00000000'B | | |
| Maximum bit rate for downlink | Any value(Note1) | | |
| Unit for guaranteed bit rate | '00000000'B | | |
| Guaranteed bit rate for uplink | '00000000'B | | |
| Guaranteed bit rate for downlink | '00000000'B | | |
| Note1: The product of Unit for maximum bit rate and maximum bit rate for downlink should be 12Gbps. | | | |

Table 10.2.2.1.3.3-2: Message ACTIVATE DEDICATED EPS BEARER CONTEXT REQUEST (step 5, Table 10.2.2.1.3.2-1)

| Derivation path: TS 38.508-1 [4], Table 4.5.4.3-1 , condition UE-INITIATED | | | |
|--|--|---------|-----------|
| Information Element | Value/Remark | Comment | Condition |
| EPS bearer identity | 6 | | |
| EPS QoS | | | |
| QCI | 1 | | |
| Maximum bit rate for uplink | 384 kbps | | |
| Maximum bit rate for downlink | '11111110'B (8640 kbps) | | |
| Guaranteed bit rate for uplink | 128 kbps | | |
| Guaranteed bit rate for downlink | 128 kbps | | |
| Maximum bit rate for uplink (extended) | 0 | | |
| Maximum bit rate for downlink (extended) | '11111010'B (256 Mbps) | | |
| Guaranteed bit rate for uplink (extended) | 0 | | |
| Guaranteed bit rate for downlink (extended) | 0 | | |
| Maximum bit rate for uplink (extended-2) | 0 | | |
| Maximum bit rate for downlink (extended-2) | '11110110'B (10 Gbps) | | |
| Guaranteed bit rate for uplink (extended-2) | 0 | | |
| Guaranteed bit rate for downlink (extended-2) | 0 | | |
| Extended EPS QoS | | | |
| Unit for maximum bit rate | '00000111' (value is incremented in multiples of 1 Gbps) | | |
| Maximum bit rate for uplink | '00000000'B | | |
| Maximum bit rate for downlink | '0000000000001100' B (12 Gbps) | | |
| Unit for guaranteed bit rate | '00000000'B | | |
| Guaranteed bit rate for uplink | '00000000'B | | |
| Guaranteed bit rate for downlink | '00000000'B | | |

Table 10.2.2.1.3.3-3: Message BEARER RESOURCE MODIFICATION REQUEST (step 8, Table 10.2.2.1.3.2-1)

| Derivation path: TS 36.508 [7], Table 4.7.3-8 | | | |
|---|-------------------------|---------|-----------|
| Information Element | Value/Remark | Comment | Condition |
| EPS bearer identity for packet filter | 6 | | |
| Required traffic flow QoS | | | |
| QCI | 1 | | |
| Maximum bit rate for uplink | 384 kbps | | |
| Maximum bit rate for downlink | '11111110'B (8640 kbps) | | |
| Guaranteed bit rate for uplink | 128 kbps | | |
| Guaranteed bit rate for downlink | 128 kbps | | |
| Maximum bit rate for uplink (extended) | 0 | | |
| Maximum bit rate for downlink (extended) | '11111010'B (256 Mbps) | | |
| Guaranteed bit rate for uplink (extended) | 0 | | |
| Guaranteed bit rate for downlink (extended) | 0 | | |
| Maximum bit rate for uplink (extended-2) | 0 | | |
| Maximum bit rate for downlink (extended-2) | '11110110'B (10 Gbps) | | |
| Guaranteed bit rate for uplink (extended-2) | 0 | | |
| Guaranteed bit rate for downlink (extended-2) | 0 | | |
| Extended EPS QoS | | | |
| Unit for maximum bit rate | Any value (Note1) | | |
| Maximum bit rate for uplink | '00000000'B | | |
| Maximum bit rate for downlink | Any value (Note1) | | |
| Unit for guaranteed bit rate | '00000000'B | | |
| Guaranteed bit rate for uplink | '00000000'B | | |
| Guaranteed bit rate for downlink | '00000000'B | | |

Note1: The product of Unit for maximum bit rate and maximum bit rate for downlink should be 16Gbps.

Table 10.2.2.1.3.3-4: Message MODIFY EPS BEARER CONTEXT REQUEST (step 7, Table 10.2.2.1.3.2-1)

| Derivation path: TS 36.508 [7], Table 4.7.3-18, condition UE-INITIATED | | | |
|--|---|---------|-----------|
| Information Element | Value/Remark | Comment | Condition |
| EPS bearer identity | 6 | | |
| Linked EPS bearer identity | 12 | | |
| New EPS QoS | | | |
| QCI | 1 | | |
| Maximum bit rate for uplink | 384 kbps | | |
| Maximum bit rate for downlink | '11111110'B (8640 kbps) | | |
| Guaranteed bit rate for uplink | 128 kbps | | |
| Guaranteed bit rate for downlink | 128 kbps | | |
| Maximum bit rate for uplink (extended) | 0 | | |
| Maximum bit rate for downlink (extended) | '11111010'B (256 Mbps) | | |
| Guaranteed bit rate for uplink (extended) | 0 | | |
| Guaranteed bit rate for downlink (extended) | 0 | | |
| Maximum bit rate for uplink (extended-2) | 0 | | |
| Maximum bit rate for downlink (extended-2) | '11110110'B (10 Gbps) | | |
| Guaranteed bit rate for uplink (extended-2) | 0 | | |
| Guaranteed bit rate for downlink (extended-2) | 0 | | |
| APN-AMBR | | | |
| APN-AMBR for downlink | '11111110'B (8640 kbps) | | |
| APN-AMBR for uplink | '11111110'B (8640 kbps) | | |
| APN-AMBR for downlink (extended) | '11111010' B(256 Mbps) | | |
| APN-AMBR for uplink (extended) | '11111010' B(256 Mbps) | | |
| APN-AMBR for downlink (extended-2) | '11111110'B (65280 Mbps) | | |
| APN-AMBR for uplink (extended-2) | 0 | | |
| Extended APN-AMBR | | | |
| Unit for extended APN-AMBR for downlink | '00000111'B (value is incremented in multiples of 1 Gbps) | | |
| Extended APN-AMBR for downlink | '0000000010000000' (128 Gbps) | | |
| Unit for extended APN-AMBR for uplink | 0 | | |
| Extended APN-AMBR for uplink | 0 | | |
| Extended EPS QoS | | | |
| Unit for maximum bit rate | '00000111' (value is incremented in multiples of 1 Gbps) | | |
| Maximum bit rate for uplink | '00000000'B | | |
| Maximum bit rate for downlink | '000000000010000' B (16 Gbps) | | |
| Unit for guaranteed bit rate | '00000000'B | | |
| Guaranteed bit rate for uplink | '00000000'B | | |
| Guaranteed bit rate for downlink | '00000000'B | | |

10.3 5GS Non-3GPP Access Session Management

10.3.1 PDU session authentication and authorization

10.3.1.1 PDU session authentication and authorization / during the UE-requested PDU session procedure

10.3.1.1.1 Test Purpose (TP)

Same Test Purpose as in clause 10.1.1.1.1

10.3.1.1.2 Conformance requirements

Same conformance requirements as in clause 10.1.1.1.2

10.3.1.1.3 Test description

10.3.1.1.3.1 Pre-test conditions

System Simulator:

WLAN Cell 27

UE:

None.

Preamble:

The UE is in state 1W-A with PDU session Active state according to TS 38.508-1 [4].

10.3.1.1.3.2 Test procedure sequence

Table 10.3.1.1.3.2-1: Main behaviour

| St | Procedure | Message Sequence | | TP | Verdict |
|----|---|------------------|---|----|---------|
| | | U - S | Message | | |
| 1 | Cause the UE to request connectivity to an additional PDU session. (see Note 1) | - | - | - | - |
| 2 | UE transmits establishes a IPSEC SA and NAS signalling connection as per generic procedure in table 4.5A.4.2.2-1 of 38.508-1 [4]. | - | - | - | - |
| 3 | The UE transmits a PDU SESSION ESTABLISHMENT REQUEST message to request an additional PDU session.

Note: PDU SESSION ESTABLISHMENT REQUEST is included in UL NAS transport. UL NAS transport message is included in dedicatedNAS-Message of <i>ULInformationTransfer</i> message. DNN information is included in UL NAS transport message. | --> | 5GMM: UL NAS TRANSPORT
5GSM: PDU SESSION ESTABLISHMENT REQUEST | - | - |
| 4 | The SS transmits PDU SESSION AUTHENTICATION COMMAND including an EAP-Request message. | <-- | PDU SESSION AUTHENTICATION COMMAND | | |
| 5 | Check: Does the UE transmit a PDU SESSION AUTHENTICATION COMPLETE containing EAP-Response message? | --> | PDU SESSION AUTHENTICATION COMPLETE | 1 | P |
| 6 | The SS transmits PDU SESSION ESTABLISHMENT REJECT message with 5GSM cause #29 including an EAP-Failure message. | <-- | PDU SESSION ESTABLISHMENT REJECT | | |
| 7 | The generic procedure for SS-requested IPsec Secure tunnel disconnection, specified in subclause 4.5A.3 of TS 38.508-1 [4], takes place performing disconnection of security association. | - | | - | - |
| 8 | Cause the UE to request connectivity to an additional PDU session. (see Note 1) | - | - | - | - |
| 9 | UE transmits establishes a IPSEC SA and NAS signalling connection as per generic procedure in table 4.5A.4.2.2-1 of 38.508-1 [4]. | - | - | - | - |
| 10 | The UE transmits a PDU SESSION ESTABLISHMENT REQUEST message to request an additional PDU session.

Note: PDU SESSION ESTABLISHMENT REQUEST is included in UL NAS transport. UL NAS transport message is included in dedicatedNAS-Message of <i>ULInformationTransfer</i> message. DNN information is included in UL NAS transport message. | --> | 5GMM: UL NAS TRANSPORT
5GSM: PDU SESSION ESTABLISHMENT REQUEST | 2 | P |
| 11 | The SS transmits PDU SESSION AUTHENTICATION COMMAND including an EAP-Request message. | <-- | PDU SESSION AUTHENTICATION COMMAND | | |
| 12 | Check: Does the UE transmit a PDU SESSION AUTHENTICATION COMPLETE containing EAP-Response message? | --> | PDU SESSION AUTHENTICATION COMPLETE | - | - |
| 13 | The SS establishes an IPsec child security association according to the IKEv2 specification in RFC 7296 [32] | - | - | - | - |
| 14 | The SS transmits PDU SESSION ESTABLISHMENT ACCEPT message containing an EAP-Success message. | <-- | PDU SESSION ESTABLISHMENT ACCEPT | | |

| | | | | | |
|--|--|-----|-----------------------------------|---|---|
| 15 | SS Transmits PDU SESSION MODIFICATION COMMAND | << | PDU SESSION MODIFICATION COMMAND | - | - |
| | Check: Does the UE transmit a PDU SESSION MODIFICATION COMPLETE? | --> | PDU SESSION MODIFICATION COMPLETE | 3 | P |
| - | EXCEPTION: Step 16a1 describes behaviour depending UE implementation; the "lower case letter" identifies a step sequence that take place if the UE performs a specific action. | - | - | - | - |
| 16a1 | If initiated by the UE, the generic procedure for IP address allocation in the user plane, specified in subclause 4.5.6, takes place performing IP address allocation in the user plane. | - | - | - | - |
| Note 1: The request of connectivity to an additional PDU session may be performed by MMI or AT command +CGACT. | | | | | |

10.3.1.1.3.3 Specific message contents

Table 10.3.1.1.3.3-1: SERVICE REQUEST (step 2 and 9, Table 10.3.1.1.3.2-1)

| Derivation path: TS 38.508-1 [4], Table 4.7.1-16 | | | |
|--|-----------------|--|-----------|
| Information Element | Value/remark | Comment | Condition |
| Service type | '0000'B | signalling | |
| PDU session status | PDU session IDs | PDU session IDs of the ACTIVE PDU session established during Preamble. | |

Table 10.3.1.1.3.3-2: SERVICE ACCEPT (step 2 and 9, Table 10.3.1.1.3.2-1)

| Derivation path: TS 38.508-1 [4], Table 4.7.1-17 | | | |
|--|-----------------|--|-----------|
| Information Element | Value/remark | Comment | Condition |
| PDU session status | PDU session IDs | PDU session IDs of the ACTIVE PDU session established during Preamble. | |

Table 10.3.1.1.3.3-3: PDU SESSION ESTABLISHMENT REQUEST (step 3 and 10, Table 10.3.1.1.3.2-1)

| Derivation path: TS 38.508-1 [4], Table 4.7.2-1 | | | |
|---|--------------|--|-----------|
| Information Element | Value/remark | Comment | Condition |
| PDU session ID | PSI-1 | UE assigns a particular PSI not yet used between 1 and 15 | |
| PTI | PTI-1 | UE assigns a particular PTI not yet used between 1 and 254 | |

Table 10.3.1.1.3.3-4: UL NAS Transport (step 3 and 10, Table 10.3.1.1.3.2-1)

| Derivation path: TS 38.508-1 [4], Table 4.7.1-10 | | | |
|--|----------------------|--|-----------|
| Information Element | Value/remark | Comment | Condition |
| Payload container type | '0001'B | N1 SM information | |
| PDU session ID | PSI-1 | | |
| Request type | '001'B | Initial request | |
| S-NSSAI | Not Present | | |
| DNN | DNN-1 (New DNN name) | The requested DNN is different from default DNN. | |

Table 10.3.1.1.3.3-5: PDU SESSION ESTABLISHMENT REJECT (step 6, Table 10.3.1.1.3.2-1)

| Derivation path: TS 38.508-1 [4], Table 4.7.2-3 | | | |
|---|--------------|---|-----------|
| Information Element | Value/remark | Comment | Condition |
| PDU session ID | PSI-1 | | |
| PTI | PTI-1 | | |
| 5GSM cause | '00011 101' | User authentication or authorization failed | |

Table 10.3.1.1.3.3-6: PDU SESSION ESTABLISHMENT ACCEPT (step 14, Table 10.3.1.1.3.2-1)

| Derivation path: TS 38.508-1 [4], Table 4.7.2-2 | | | |
|---|---------------------|---------------------------------------|-----------|
| Information Element | Value/remark | Comment | Condition |
| PDU session ID | PSI-1 | | |
| PTI | PTI-1 | | |
| Authorized QoS rules | | | |
| QoS rule | | | |
| QoS rule identifier | '0000 0001'B | | |
| Rule operation code | '001'B | Create new QoS rule | |
| DQR bit | '1'B | The QoS rule is the default QoS rule. | |
| Number of packet filters | '0001'B | 1 packet filter | |
| Packet filter list | See table 4.8.2.1-1 | Packet filter list #1 | |
| Packet filter direction | '11'B | bidirectional | |
| Packet filter identifier | '0000'B | Id 0 | |
| Component type 1 ID | '0000 0001'B | Match-all type | |
| QoS rule precedence | '0000 0000'B | 0 | |
| QoS flow identifier (QFI) | '00 0011'B | QFI 3 | |
| EAP message | | | |
| QoS flow description | | | |
| QFI | '00 0011'B | QFI 3 | |
| Operation code | '001'B | Create new QoS flow description | |
| E bit | '1'B | Parameters list is included | |
| Number of parameters | '00 0001'B | 1 parameters | |
| 5QI | '0000 1001'B | 5QI 9 | |
| DNN | DNN-1 | | |

10.3.2 Network-requested PDU session modification

10.3.2.1 Network-requested PDU session modification /Accepted/Rejected

10.3.2.1.1 Test Purpose (TP)

(1)

```
with { the UE in PDU SESSION ACTIVE state and 5GMM-CONNECTED mode }
ensure that {
  when { the UE receives a PDU SESSION MODIFICATION COMMAND message include the PDU session ID which
does not belong to any PDU session in PDU SESSION ACTIVE state in UE }
  then { UE sends a PDU SESSION MODIFICATION COMMAND REJECT message and set the 5GSM cause to #43:
invalid PDU session identity }
}
```

(2)

```
with { the UE in PDU SESSION ACTIVE state and 5GMM-CONNECTED mode }
ensure that {
  when { the UE receives a PDU SESSION MODIFICATION COMMAND message include the PDU session ID which
belongs to a PDU session in PDU SESSION ACTIVE state in UE }
  then { UE sends a PDU SESSION MODIFICATION COMMAND REJECT message and set the 5GSM cause to #43:
invalid PDU session identity }
}
```

10.3.2.1.2 Conformance requirements

References: The conformance requirements covered in the present TC are specified in: TS 24.501, clauses 6.3.2.2, 6.3.2.4. Unless otherwise stated these are Rel-15 requirements.

[TS 24.501, clause 6.3.2.2]

In order to initiate the network-requested PDU session modification procedure, the SMF shall create a PDU SESSION MODIFICATION COMMAND message.

If the authorized QoS rules of the PDU session is modified, the SMF shall set the authorized QoS rules IE of the PDU SESSION MODIFICATION COMMAND message to the authorized QoS rules of the PDU session. The SMF shall ensure that the number of the packet filters used in the authorized QoS rules of the PDU Session does not exceed the maximum number of packet filters supported by the UE for the PDU session. The SMF may bind service data flows for which the UE has requested traffic segregation to a dedicated QoS flow for the PDU session, if possible. Otherwise the SMF may bind the service data flows to an existing QoS flow. The SMF shall use only one dedicated QoS flow for traffic segregation. If the UE has requested traffic segregation for multiple service data flows with different QoS handling, the SMF shall bind all these service data flows to a single QoS flow. If the SMF allows traffic segregation for service data flows in a QoS rule, then the SMF shall create a new authorized QoS rule for these service data flows and shall delete packet filters corresponding to these service data flows from the other authorized QoS rules.

If the authorized QoS flow descriptions of the PDU session is modified, the SMF shall set the authorized QoS flow descriptions IE of the PDU SESSION MODIFICATION COMMAND message to the authorized QoS flow descriptions of the PDU session.

If SMF creates a new authorized QoS rule for a new QoS flow, then SMF shall include the authorized QoS flow description for that QoS flow in the authorized QoS flow descriptions IE of the PDU SESSION MODIFICATION COMMAND message, if:

- a) the newly created authorized QoS rules is for a new GBR QoS flow;
- b) the QFI of the new QoS flow is not the same as the 5QI of the QoS flow identified by the QFI; or
- c) the new QoS flow can be mapped to an EPS bearer as specified in subclause 4.11.2 of 3GPP TS 23.502 [9].

If the session-AMBR of the PDU session is modified, the SMF shall set the selected Session-AMBR IE of the PDU SESSION MODIFICATION COMMAND message to the session-AMBR of the PDU session.

If interworking with EPS is supported for the PDU session and if the mapped EPS bearer contexts of the PDU session is modified, the SMF shall set the mapped EPS bearer contexts IE of the PDU SESSION MODIFICATION COMMAND

message to the mapped EPS bearer contexts of the PDU session. If the association between a QoS flow and the mapped EPS bearer context is changed, the SMF shall set the EPS bearer identity parameter in authorized QoS flow descriptions IE of the PDU SESSION MODIFICATION COMMAND message to the new EPS bearer identity associated with the QoS flow.

If the network-requested PDU session modification procedure is triggered by a UE-requested PDU session modification procedure and the PDU SESSION MODIFICATION REQUEST message includes a 5GSM capability IE, the SMF shall:

- a) if the RQoS bit is set to:
 - 1) "Reflective QoS supported", consider that the UE supports reflective QoS for this PDU session; or
 - 2) "Reflective QoS not supported", consider that the UE does not support reflective QoS for this PDU session; and;
- b) if the MH6-PDU bit is set to:
 - 1) "Multi-homed IPv6 PDU session supported", consider that this PDU session is supported to use multiple IPv6 prefixes; or
 - 2) "Multi-homed IPv6 PDU session not supported", consider that this PDU session is not supported to use multiple IPv6 prefixes.

If the SMF considers that reflective QoS is supported for QoS flows belonging to this PDU session, the SMF may include the RQ timer IE set to an RQ timer value in the PDU SESSION MODIFICATION COMMAND message.

If the network-requested PDU session modification procedure is triggered by a UE-requested PDU session modification procedure, the PDU session type is "IPv4", "IPv6", "IPv4v6" or "Ethernet" and the PDU SESSION MODIFICATION REQUEST message includes a Maximum number of supported packet filters IE, the SMF shall consider this number as the maximum number of packet filters that can be supported by the UE for this PDU session. Otherwise the SMF considers that the UE supports 16 packet filters for this PDU session.

For a PDN connection established when in S1 mode, upon the first inter-system change from S1 mode to N1 mode, if the network-requested PDU session modification procedure is triggered by a UE-requested PDU session modification procedure, the SMF shall consider that the maximum data rate per UE for user-plane integrity protection supported by the UE for uplink and the maximum data rate per UE for user-plane integrity protection supported by the UE for downlink are valid for the lifetime of the PDU session.

For a PDN connection established when in S1 mode, upon the first inter-system change from S1 mode to N1 mode, if the network-requested PDU session modification procedure is triggered by a UE-requested PDU session modification procedure and the SMF determines, based on local policies or configurations in the SMF and the Always-on PDU session requested IE in the PDU SESSION MODIFICATION REQUEST message (if available), that either:

- a) the requested PDU session needs to be an always-on PDU session, the SMF shall include the Always-on PDU session indication IE in the PDU SESSION MODIFICATION COMMAND message and shall set the value to "Always-on PDU session required"; or
- b) the requested PDU session shall not be an always-on PDU session and:
 - i) if the UE included the Always-on PDU session requested IE, the SMF shall include the Always-on PDU session indication IE in the PDU SESSION MODIFICATION COMMAND message and shall set the value to "Always-on PDU session not allowed"; or
 - ii) if the UE did not include the Always-on PDU session requested IE, the SMF shall not include the Always-on PDU session indication IE in the PDU SESSION MODIFICATION COMMAND message.

If the value of the RQ timer is set to "deactivated" or has a value of zero, the UE considers that RQoS is not applied for this PDU session and remove the derived QoS rule(s) associated with the PDU session, if any.

If the network-requested PDU session modification procedure is triggered by a UE-requested PDU session modification procedure, the SMF shall set the PTI IE of the PDU SESSION MODIFICATION COMMAND message to the PTI of the PDU SESSION MODIFICATION REQUEST message received as part of the UE-requested PDU session modification procedure.

If the network-requested PDU session modification procedure is not triggered by a UE-requested PDU session modification procedure, the SMF shall set the PTI IE of the PDU SESSION MODIFICATION COMMAND message to "No procedure transaction identity assigned".

If the selected SSC mode of the PDU session is "SSC mode 3" and the SMF requests the relocation of SSC mode 3 PDU session anchor with multiple PDU sessions as specified in 3GPP TS 23.502 [9], the SMF shall include 5GSM cause #39 "reactivation requested", in the PDU SESSION MODIFICATION COMMAND message, and may include the PDU session address lifetime in a PDU session address lifetime PCO parameter in the Extended protocol configuration options IE of the PDU SESSION MODIFICATION COMMAND message.

The SMF shall send the PDU SESSION MODIFICATION COMMAND message, and the SMF shall start timer T3591 (see example in figure 6.3.2.2.1).

NOTE: If the SMF requests the relocation of SSC mode 3 PDU session anchor with multiple PDU sessions as specified in 3GPP TS 23.502 [9], the reallocation requested indication indicating whether the SMF is to be reallocated or the SMF is to be reused is provided to the AMF.

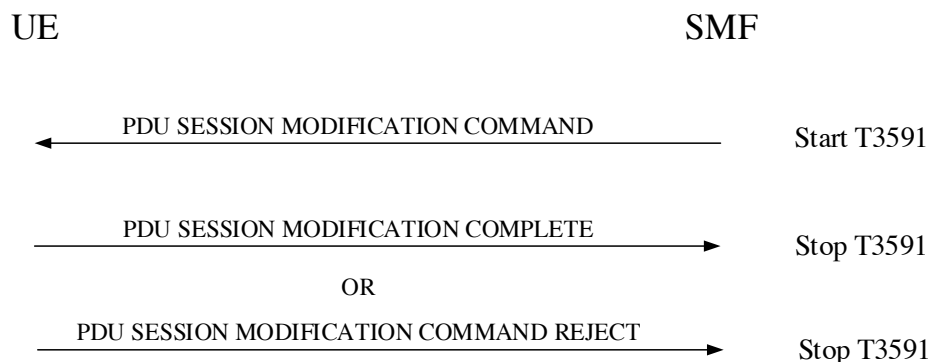

Figure 6.3.2.2.1: Network-requested PDU session modification procedure

[TS 24.501, clause 6.3.2.4]

Upon receipt of a PDU SESSION MODIFICATION COMMAND message and a PDU session ID, using the NAS transport procedure as specified in subclause 5.4.5, if the UE rejects the PDU SESSION MODIFICATION COMMAND message, the UE shall create a PDU SESSION MODIFICATION COMMAND REJECT message.

If the PDU SESSION MODIFICATION COMMAND message contains the PTI value allocated in the UE-requested PDU session modification procedure, the UE shall release the PTI indicated by the PTI IE and shall stop the timer T3581.

The UE shall set the 5GSM cause IE of the PDU SESSION MODIFICATION COMMAND REJECT message to indicate the reason for rejecting the PDU session modification.

The 5GSM cause IE typically indicates one of the following 5GSM cause values:

- #26 insufficient resources;
- #43 invalid PDU session identity;
- #44 semantic error in packet filter(s);
- #45 syntactical error in packet filter(s);
- #83 semantic error in the QoS operation; or

#84 syntactical error in the QoS operation.

10.3.2.1.3 Test description

10.3.2.1.3.1 Pre-test conditions

System Simulator:

WLAN Cell 27

UE:

None.

Preamble:

The UE is in state 3W-A on WLAN Cell 27 with PDU session Active state according to TS 38.508-1 [4].

10.3.2.1.3.2 Test procedure sequence

Table 10.3.2.1.3.2-1: Main behaviour

| St | Procedure | Message Sequence | | TP | Verdict |
|----|--|------------------|-----------------------------------|----|---------|
| | | U - S | Message | | |
| 1 | The SS transmits a PDU session modification command message with PDU session ID IE is set to a different value from the value set in PDU SESSION ESTABLISHMENT REQUEST message. This message is included in a DLInformationTransfer message. | <-- | PDU SESSION MODIFICATION COMMAND | - | - |
| 2 | Check: Does the UE transmit a PDU session modification reject with the 5GSM cause IE indicating #43 "invalid PDU session identity"? | --> | PDU SESSION MODIFICATION REJECT | 1 | P |
| 3 | The SS transmits a PDU session modification command message with PDU session ID IE is the value set in PDU SESSION ESTABLISHMENT REQUEST message. This message is included in a DLInformationTransfer message. | <-- | PDU SESSION MODIFICATION COMMAND | - | - |
| 4 | Check: Does the UE transmit a PDU session modification complete? | --> | PDU SESSION MODIFICATION COMPLETE | 2 | P |

10.3.2.1.3.3 Specific message contents

Table 10.3.2.1.3.3-1: PDU SESSION MODIFICATION COMMAND (Step 1, Table 10.3.2.1.3.2-1)

| Derivation path: TS 38.508-1 [4], table 4.7.2-9 | | | |
|---|---|---------|-----------|
| Information Element | Value/Remark | Comment | Condition |
| PDU session ID | The different value from the value set in PDU SESSION ESTABLISHMENT REQUEST message in preamble | | |

Table 10.3.2.1.3.3-2: PDU SESSION MODIFICATION REJECT (Step 2, Table 10.3.2.1.3.2-1)

| Derivation path: TS 38.508-1 [4], table 4.7.2-8 | | | |
|---|---|------------------------------|-----------|
| Information Element | Value/Remark | Comment | Condition |
| PDU session ID | The same value as the value set in PDU SESSION modification command message | | |
| 5GSM cause | '00101011'B | Invalid PDU session identity | |

Table 10.3.2.1.3.3-1: PDU SESSION MODIFICATION COMMAND (Step 3, Table 10.3.2.1.3.2-1)

| Derivation path: TS 38.508-1 [4], table 4.7.2-9 | | | |
|---|--|---------|-----------|
| Information Element | Value/Remark | Comment | Condition |
| PDU session ID | The value set in PDU SESSION ESTABLISHMENT REQUEST message in preamble | | |
| Authorized QoS rules | Reference QoS rule #3 as defined in 38.508-1 [4]Table 4.8.2.1-1. | | |

10.3.3 Network-requested PDU session Release

10.3.3.1 Network-requested PDU session release / accepted/ with and without reactivation

10.3.3.1.1 Test Purpose (TP)

(1)

```
with { the UE in PDU SESSION ACTIVE state }
ensure that {
  when { the UE receives a PDU SESSION RELEASE COMMAND message includes 5GSM cause #39 "reactivation requested" }
  then { the UE re-initiates a PDU SESSION establishment procedure for the same [S-NSSAI, DNN] combination provided in PDU session establishment procedure }
}
```

(2)

```
with { UE is in PDU SESSION ACTIVE state }
ensure that {
  when { UE receives a PDU SESSION RELEASE COMMAND message including 5GSM cause #26 "insufficient resources" and the Back-off timer value that indicates deactivated }
  then { UE does not send a PDU SESSION ESTABLISHMENT REQUEST message until the UE is switched off or the USIM is removed }
}
```

10.3.3.1.2 Conformance requirements

References: The conformance requirements covered in the present TC are specified in: TS 24.501, clauses 6.3.3.2, 6.3.3.3. Unless otherwise stated these are Rel-15 requirements.

[TS 24.501, clause 6.3.3.2]

In order to initiate the network-requested PDU session release procedure, the SMF shall create a PDU SESSION RELEASE COMMAND message.

The SMF shall set the SM cause IE of the PDU SESSION RELEASE COMMAND message to indicate the reason for releasing the PDU session.

The SM cause IE typically indicates one of the following SM cause values:

#26 insufficient resources;

...

The SMF may include a Back-off timer value IE in the PDU SESSION RELEASE COMMAND message when the 5GSM cause value #26 "insufficient resources" is included in the PDU SESSION RELEASE COMMAND message. If the 5GSM cause value is #26 "insufficient resources" and the PDU SESSION RELEASE COMMAND message is sent to a UE configured for high priority access in selected PLMN or the request type was set to "initial emergency request" or "existing emergency PDU session" for the establishment of the PDU session, the network shall not include a Back-off timer value IE.

The SMF may include a Back-off timer value IE in the PDU SESSION RELEASE COMMAND message when the 5GSM cause value #67 "insufficient resources for specific slice and DNN" is included in the PDU SESSION RELEASE COMMAND message. If the 5GSM cause value is #67 "insufficient resources for specific slice and DNN" and the PDU SESSION RELEASE COMMAND message is sent to a UE configured for high priority access in selected PLMN or the request type was set to "initial emergency request" or "existing emergency PDU session" for the establishment of the PDU session, the network shall not include a Back-off timer value IE.

[TS 24.501, clause 6.3.3.3]

Upon receipt of a PDU SESSION RELEASE COMMAND message and a PDU session ID, using the NAS transport procedure as specified in subclause 5.4.5, the UE considers the PDU session as released and the UE shall create a PDU SESSION RELEASE COMPLETE message.

If the PDU SESSION RELEASE COMMAND message contains the PTI value allocated in the UE-requested PDU session release procedure, the UE shall stop the timer T3582. The UE should ensure that the PTI value assigned to this procedure is not released immediately.

NOTE 1: The way to achieve this is implementation dependent. For example, the UE can ensure that the PTI value assigned to this procedure is not released during the time equal to or greater than the default value of timer T3592.

While the PTI value is not released, the UE regards any received PDU SESSION RELEASE COMMAND message with the same PTI value as a network retransmission (see subclause 7.3.1).

If the PDU SESSION RELEASE COMMAND message includes 5GSM cause #39 "reactivation requested", then after completion of the network-requested PDU session release procedure, the UE should re-initiate the UE-requested PDU session establishment procedure as specified in subclause 6.4.1 for:

- a) the PDU session type associated with the released PDU session;
- b) the SSC mode associated with the released PDU session;
- c) the DNN associated with the released PDU session; and
- d) the S-NSSAI associated with (if available in roaming scenarios) a mapped S-NSSAI if provided in the UE-requested PDU session establishment procedure of the released PDU session.

If the PDU SESSION RELEASE COMMAND message includes 5GSM cause #39 "reactivation requested" and the UE provided an S-NSSAI during the PDU session establishment, the UE shall stop timer T3585 if it is running for the S-NSSAI provided by the UE. The UE should then re-initiate the UE requested PDU session establishment procedure for the same S-NSSAI. If the UE did not provide an S-NSSAI during the PDU session establishment and the request type was different from "initial emergency request" and different from "existing emergency PDU session", the UE shall stop the timer T3585 associated with no S-NSSAI if it is running, and should re-initiate the UE requested PDU session establishment procedure without including an S-NSSAI. If the PDU SESSION RELEASE COMMAND message was received for an emergency PDU session, the UE shall not stop the timer T3585 associated with no S-NSSAI if it is running.

If the PDU SESSION RELEASE COMMAND message includes 5GSM cause #39 "reactivation requested" and the UE provided a DNN during the PDU session establishment, the UE shall stop timer T3396 if it is running for the DNN provided by the UE. The UE should then re-initiate the UE requested PDU session establishment procedure for the same DNN. If the UE did not provide a DNN during the PDU session establishment and the request type was different from "initial emergency request" and different from "existing emergency PDU session", the UE shall stop the timer

T3396 associated with no DNN if it is running, and should re-initiate the UE requested PDU session establishment procedure without including a DNN. If the PDU SESSION RELEASE COMMAND message was received for an emergency PDU session, the UE shall not stop the timer T3396 associated with no DNN if it is running.

If the PDU SESSION RELEASE COMMAND message includes 5GSM cause #39 "reactivation requested" and the UE provided an S-NSSAI and a DNN during the PDU session establishment, the UE shall stop timer T3584 if it is running for the same [S-NSSAI, DNN] combination provided by the UE. The UE should then re-initiate the UE requested PDU session establishment procedure for the same [S-NSSAI, DNN] combination. If the UE did not provide an S-NSSAI during the PDU session establishment, the UE shall stop the timer T3584 associated with [no S-NSSAI, DNN] if it is running, and should re-initiate the UE requested PDU session establishment procedure with the same DNN but without an S-NSSAI. If the UE did not provide a DNN during the PDU session establishment and the request type was different from "initial emergency request" and different from "existing emergency PDU session", the UE shall stop the timer T3584 associated with [S-NSSAI, no DNN] if it is running, and should re-initiate the UE requested PDU session establishment procedure with the same S-NSSAI but without a DNN. If the PDU SESSION RELEASE COMMAND message was received for an emergency PDU session, the UE shall not stop the timer T3584 associated with [S-NSSAI, no DNN] if it is running. If the UE provided neither a DNN nor an S-NSSAI during the PDU session establishment and the request type was different from "initial emergency request" and different from "existing emergency PDU session", the UE shall stop the timer T3584 associated with [no S-NSSAI, no DNN] if it is running, and should re-initiate the UE requested PDU session establishment procedure without an S-NSSAI and a DNN. If the PDU SESSION RELEASE COMMAND message was received for an emergency PDU session, the UE shall not stop the timer T3584 associated with [no S-NSSAI, no DNN] if it is running.

NOTE 2: User interaction is necessary in some cases when the UE cannot re-initiate the UE-requested PDU session establishment procedure automatically.

NOTE 3: If the PDU SESSION RELEASE COMMAND message includes 5GSM cause #39 "reactivation requested" for a PDU session, the UE provided a DNN (or no DNN) and an S-NSSAI (or no S-NSSAI) when the PDU session is established, timer T3396 associated with the DNN (or no DNN, if no DNN was provided by the UE) is running, and timer T3584 associated with the DNN (or no DNN, if no DNN was provided by the UE) and the S-NSSAI (or no S-NSSAI, if no S-NSSAI was provided by the UE) is running, then the UE stops both the timer T3396 and the timer T3584.

NOTE 4: If the PDU SESSION RELEASE COMMAND message includes 5GSM cause #39 "reactivation requested" for a PDU session, the UE provided a DNN (or no DNN) and an S-NSSAI (or no S-NSSAI) when the PDU session is established, timer T3585 associated with the S-NSSAI (or no S-NSSAI, if no S-NSSAI was provided by the UE) is running, and timer T3584 associated with the DNN (or no DNN, if no DNN was provided by the UE) and the S-NSSAI (or no S-NSSAI, if no S-NSSAI was provided by the UE) is running, then the UE stops both the timer T3585 and the timer T3584.

10.3.3.1.3 Test description

10.3.3.1.3.1 Pre-test conditions

System Simulator:

- WLAN Cell 27

UE:

- None.

Preamble:

- The UE is in state 3W-A on WLAN Cell 27 according to TS 38.508-1 [4].

10.3.3.1.3.2 Test procedure sequence

Table 10.3.3.1.3.2-1: Main behaviour

| St | Procedure | Message Sequence | | TP | Verdict |
|----|---|------------------|--|----|---------|
| | | U - S | Message | | |
| 1 | The SS transmits a PDU SESSION RELEASE COMMAND including 5GSM cause #39 "reactivation requested " with PDU session ID IE is set to the same value in PDU SESSION ESTABLISHMENT REQUEST message in preamble. | <-- | 5GMM: DL NAS TRANSPORT
5GSM: PDU SESSION RELEASE
COMMAND | - | - |
| 2 | Check: Does the UE transmit a PDU SESSION ESTABLISHMENT REQUEST and the S-NSSAI and DNN in UL NAS TRANSPORT message are the same values in UL NAS TRANSPORT message in preamble? | --> | 5GMM: UL NAS TRANSPORT
5GSM: PDU SESSION
ESTABLISHMENT REQUEST | 1 | P |
| 3 | The SS transmits an PDU SESSION ESTABLISHMENT ACCEPT | <-- | 5GMM: DL NAS TRANSPORT
5GSM: PDU SESSION
ESTABLISHMENT ACCEPT | - | - |
| 4 | The SS transmits a PDU SESSION RELEASE COMMAND including 5GSM cause #26 "insufficient resources" and T3396 value (deactivated). | <-- | 5GMM: DL NAS TRANSPORT
5GSM: PDU SESSION RELEASE
COMMAND | - | - |
| 5 | The UE transmits a PDU SESSION RELEASE COMPLETE message. | --> | 5GMM: UL NAS TRANSPORT
5GSM: PDU SESSION RELEASE
COMPLETE | - | - |
| 6 | Cause the UE to request establishment of PDU session without DNN.(Note 1) | - | - | - | - |
| 7 | Check: Does the UE transmit a PDU SESSION ESTABLISHMENT REQUEST message? | --> | 5GMM: UL NAS TRANSPORT
5GSM: PDU SESSION
ESTABLISHMENT REQUEST | 2 | F |
| 8 | Switch off procedure in Ipsec_SA_Established specified in TS 38.508-1 [4] subclause 4.9.6.5 is performed. | - | - | - | - |
| 9 | Switch on UE. | - | - | - | - |
| 10 | The general procedure is completed by executing of the UE registration procedure in TS 38.508-1 [4] table 4.5.2.2-3 , 'connected without release'. | - | - | - | - |
| 11 | Cause the UE to request establishment of PDU session without DNN.(Note 1) | - | - | - | - |
| 12 | Check: Does the UE transmit a PDU SESSION ESTABLISHMENT REQUEST message? | --> | 5GMM: UL NAS TRANSPORT
5GSM: PDU SESSION
ESTABLISHMENT REQUEST | 3 | P |
| 13 | The SS transmits a PDU SESSION ESTABLISHMENT ACCEPT message. | <-- | 5GMM: DL NAS TRANSPORT
5GSM: PDU SESSION
ESTABLISHMENT ACCEPT | - | - |

Note 1: The request to establish a PDU session may be performed by MMI or AT command.

10.3.3.1.3.3 Specific message contents

Table 10.3.3.1.3.3-1: PDU SESSION RELEASE COMMAND (Step 1, Table 10.3.3.1.3.2-1)

| Derivation path: TS 38.508-1 [4], table 4.7.2-14 | | | |
|--|---|------------------------|-----------|
| Information Element | Value/Remark | Comment | Condition |
| PDU session ID | The same value indicated in PDU SESSION ESTABLISHMENT REQUEST message in preamble | | |
| 5GSM cause | '00100111'B | Reactivation requested | |

Table 10.3.3.1.3.3-2: UL NAS TRANSPORT (Step 2, Table 10.3.3.1.3.2-1)

| Derivation path: TS 38.508-1 [4], table 4.7.1-10 | | | |
|--|--|---------|--|
| Information Element | Value/Remark | Comment | Condition |
| S-NSSAI | The same value indicated in UL NAS TRANSPORT message in preamble | | If present in UL NAS TRANSPORT message in preamble |
| | Not present | | If not present in UL NAS TRANSPORT message in preamble |
| DNN | The same value indicated in UL NAS TRANSPORT message in preamble | | If present in UL NAS TRANSPORT message in preamble |
| | Not present | | If not present in UL NAS TRANSPORT message in preamble |

Table 10.3.3.1.3.3-3: PDU SESSION RELEASE COMMAND (step 4, Table 10.3.3.1.3.2-1)

| Derivation Path: TS 38.508-1 [4] Table 4.7.2-14 | | | |
|---|--|------------------------|-----------|
| Information Element | Value/remark | Comment | Condition |
| PDU session ID | The same ID as the ID of PDU session which UE request in step 13 in Table 10.1.3.2.3.2-1 | | |
| 5GSM cause | '0001 1010'B | insufficient resources | |
| Back-off timer value | '1110 0000'B | deactivated | |

10.3.4 UE-requested PDU session establishment

10.3.4.1 UE-requested PDU session establishment / Abnormal / T3580

10.3.4.1.1 Test Purpose (TP)

Same test purpose as in clause 10.1.4.2.1

10.3.4.1.2 Conformance requirements

Same conformance requirements as in clause 10.1.4.2.2

10.3.4.1.3 Test description

10.3.4.1.3.1 Pre-test conditions

System Simulator:

- WLAN Cell 27

UE:

- None.

Preamble:

- The UE is in state Switched OFF [State 0-A as per TS 38.508-1 [4] Table 4.4A.2-0].

10.3.4.1.3.2 Test procedure sequence

Table 10.3.4.1.3.2-1: Main behaviour

| St | Procedure | Message Sequence | | TP | Verdict |
|------|--|------------------|-----------------------------------|----|---------|
| | | U - S | Message | | |
| 1 | UE is switched on | - | - | - | - |
| 2-10 | Steps 1-9 of Table 4.5.2.2-3 of the generic procedure in TS 38.508-1 [4] are performed. | - | - | - | - |
| 11 | The UE transmits a PDU SESSION ESTABLISHMENT REQUEST message to request an additional PDU session. | --> | PDU SESSION ESTABLISHMENT REQUEST | - | - |
| - | EXCEPTION: Steps 12-13 shall be repeated for 4 times | - | - | - | - |
| 12 | The SS waits 16 seconds (T3580). | - | - | - | - |
| 13 | The UE transmits a PDU SESSION ESTABLISHMENT REQUEST message to request an additional PDU session. (Attempt counter = 5) | --> | PDU SESSION ESTABLISHMENT REQUEST | 1 | P |
| 15 | The UE transmits a PDU SESSION ESTABLISHMENT REQUEST message to request an additional PDU session. | --> | PDU SESSION ESTABLISHMENT REQUEST | 2 | F |

10.3.4.1.3.3 Specific message contents

None.

10.3.5 UE-requested PDU session modification

10.3.5.1 UE-requested PDU session modification/Success

10.3.5.1.1 Test Purpose (TP)

(1)

```
with { UE in PDU SESSION ACTIVE state and in 5GMM-CONNECTED mode }
ensure that {
  when { UE is requested to modify of PDU session }
  then { UE sends a PDU SESSION MODIFICATION REQUEST message }
}
```

10.3.5.1.2 Conformance requirements

Same conformance requirements as in clause 10.1.5.1.2

10.3.5.1.3 Test description

10.3.5.1.3.1 Pre-test conditions

System Simulator:

- WLAN Cell 27.

UE:

- None.

Preamble:

- The UE is in state 3W-A on WLAN Cell 27 with PDU SESSION ACTIVE according to TS 38.508-1[4].

10.3.5.1.3.2 Test procedure sequence

Same test procedure sequence as in clause 10.1.5.1.3.2

10.3.5.1.3.3 Specific message contents

Same specific message contents as in clause 10.1.5.1.3.3

10.3.6 UE-requested PDU session release

10.3.6.1 UE-requested PDU session release / Abnormal / Collision with network-requested PDU session modification procedure

10.3.6.1.1 Test Purpose (TP)

(1)

```
with { the UE is in PDU SESSION ACTIVE state and has sent a PDU SESSION RELEASE REQUEST message }
ensure that {
  when { UE receives a PDU SESSION MODIFICATION COMMAND message indicating a PDU session that UE
  wants to release }
  then { the UE ignores the PDU SESSION MODIFICATION COMMAND message and proceed with the PDU
  session release procedure }
}
```

10.3.6.1.2 Conformance requirements

Same conformance requirements as in clause 10.1.6.1.2

10.3.6.1.3 Test description

10.3.6.1.3.1 Pre-test conditions

System Simulator:

- WLAN Cell 27.

UE:

None.

Preamble:

- The UE is in state 3W-A on WLAN Cell 27 according to TS 38.508-1 [4].

10.3.6.1.3.2 Test procedure sequence

Table 10.3.6.1.3.2-1: Main behaviour

| St | Procedure | Message Sequence | | TP | Verdict |
|----|---|------------------|--|----|---------|
| | | U - S | Message | | |
| 1 | Cause the UE to request establishment of PDU session to the DN.(Note 1) | - | - | - | - |
| 2 | New PDU session establishment procedure is performed as per generic procedure in clause 4.5A.2A of TS 38.508-1 [4] | - | - | - | - |
| 3 | Cause the UE to request release of PDU session established during preamble.(Note 2) | - | - | - | - |
| 4 | The UE transmits a PDU SESSION RELEASE REQUEST message. | --> | 5GMM: UL NAS TRANSPORT
5GSM: PDU SESSION RELEASE REQUEST | - | - |
| 5 | The SS transmits a PDU SESSION MODIFICATION COMMAND message. | <-- | 5GMM: DL NAS TRANSPORT
5GSM: PDU SESSION MODIFICATION COMMAND | - | - |
| 6 | The SS transmits a PDU SESSION RELEASE COMMAND message. | <-- | 5GMM: DL NAS TRANSPORT
5GSM: PDU SESSION RELEASE COMMAND | - | - |
| 7 | Check: Does the UE transmit PDU SESSION RELEASE COMPLETE message? | --> | 5GMM: UL NAS TRANSPORT
5GSM: PDU SESSION RELEASE COMPLETE | 1 | P |
| 8 | The SS deletes the payload associated with IPSec child security association according to the IKEv2 specification in RFC 7296 [32] | - | - | - | - |

Note 1: The request to establish a PDU session may be performed by MMI or AT command.

Note 2: The request to release a PDU session may be performed by MMI or AT command.

10.3.6.1.3.3 Specific message contents

Table 10.3.6.1.3.3-1: PDU SESSION RELEASE REQUEST (step 4, Table 10.3.6.1.3.2-1)

| Derivation Path: TS 38.508-1 [4] Table 4.7.2-12 | | | |
|---|--|---------|-----------|
| Information Element | Value/remark | Comment | Condition |
| PDU session ID | Set to the ID UE requested in step 2 in Table 10.3.6.1.3.2-1 | | |
| PTI | Any value from 1 to 254 | | |

Table 10.3.6.1.3.3-2: PDU SESSION MODIFICATION COMMAND (step 5, Table 10.3.6.1.3.2-1)

| Derivation Path: TS 38.508-1 [4] Table 4.7.2-9 | | | |
|--|--|--|-----------|
| Information Element | Value/remark | Comment | Condition |
| PDU session ID | Set to the ID UE requested in step 2 in Table 10.3.6.1.3.2-1 | | |
| PTI | '0000 0000'B | No procedure transaction identity assigned | |

Table 10.3.6.1.3.3-3: PDU SESSION RELEASE COMMAND (step 6, Table 10.3.6.1.3.2-1)

| Derivation Path: TS 38.508-1 [4] Table 4.7.2-14 | | | |
|---|--|--------------------------|-----------|
| Information Element | Value/remark | Comment | Condition |
| PDU session ID | Set to the ID UE requested in step 2 in Table 10.3.6.1.3.2-1 | | |
| PTI | The value indicated in PDU SESSION RELEASE REQUEST | | |
| 5GSM cause | '0010 0100'B | #36 regular deactivation | |

Table 10.3.6.1.3.3-4: PDU SESSION RELEASE COMPLETE (step 7, Table 10.3.6.1.3.2-1)

| Derivation Path: TS 38.508-1 [4] Table 4.7.2-15 | | | |
|---|--|---------|-----------|
| Information Element | Value/remark | Comment | Condition |
| PDU session ID | Set to the ID UE requested in step 2 in Table 10.3.6.1.3.2-1 | | |
| PTI | The value indicated in PDU SESSION RELEASE REQUEST | | |

11 Multilayer Procedures

11.1 5GS\EPS Fallback

11.1.1 MO MMTEL voice call setup from NR RRC_IDLE / EPS Fallback with redirection / Single registration mode with N26 interface / Success

11.1.1.1 Test Purpose (TP)

(1)

```

with { UE supporting both S1 mode and N1 mode and operating in single-registration mode and the
Network having indicated "interworking without N26 interface not supported" and the UE in NR
RRC_IDLE state }
ensure that {
  when { User initiates an MMTEL call and the UE completes Access control and checking in 5GMM-IDLE
mode }
  then { UE requests the establishment of an MMTEL call by transmitting an RRCSetupRequest message
with establishmentCause set to 'mo-VoiceCall' and a SERVICE REQUEST message with Service type set to
'data' }
}

```

(2)

```

with { UE being in NR RRC_CONNECTED state after having requested an MMTEL call establishment and the
MO IMS voice session establishment has been initiated }
ensure that {
  when { UE receives an RRCRelease message which includes redirectedCarrierInfo indicating
redirection to E-UTRA }
  then {UE selects the E-UTRA cell, performs a TAU procedure, and, successfully completes the
MMTEL call setup in EPS }
}

```

11.1.1.2 Conformance requirements

References: The conformance requirements covered in the present TC are specified in: TS 24.501, clauses 4.5.4.1, 5.6.1.2 and TS 38.331: clauses 5.3.3.2, 5.3.3.3. Unless otherwise stated these are Rel-15 requirements.

[TS 24.501, clause 4.5.4.1]

When the UE is in 5GMM-IDLE mode, upon receiving a request from the upper layers for an access attempt, the NAS shall categorize the access attempt into access identities and an access category following subclause 4.5.2, table 4.5.2.1 and table 4.5.2.2, and subclause 4.5.3, and provide the applicable access identities and the access category to the lower layers for the purpose of access control checking. In this request to the lower layer the NAS can also provide to the lower layer the RRC establishment cause determined as specified in subclause 4.5.6 of this specification.

NOTE 1: The access barring check is performed by the lower layers.

NOTE 2: As an implementation option, the NAS can provide the RRC establishment cause to the lower layers after being informed by the lower layers that the access attempt is allowed.

If the UE has uplink user data pending for one or more PDU sessions when it builds a REGISTRATION REQUEST or SERVICE REQUEST message as initial NAS message, the UE shall indicate the respective PDU sessions in the Uplink data status IE as specified in subclause 5.5.1.3.2 and 5.6.1.2, regardless of the access category for which the access barring check is performed.

NOTE 3: The UE indicates pending user data for all the respective PDU sessions, even if barring timers are running for some of the corresponding access categories.

If the lower layers indicate that the access attempt is allowed, the NAS shall initiate the procedure to send the initial NAS message for the access attempt.

[TS 24.501, clause 5.6.1.2]

For cases d) and e) in subclause 5.6.1.1, the Uplink data status IE shall be included in the SERVICE REQUEST message to indicate the PDU session(s) the UE has pending user data to be sent. If the UE is not a UE configured for high priority access in selected PLMN:

- a) if there exists an emergency PDU session which is indicated in the Uplink data status IE the service type IE in the SERVICE REQUEST message shall be set to "emergency services"; or
- b) otherwise, the service type IE in the SERVICE REQUEST message shall be set to "data".

[TS 38.331, clause 5.3.3.2]

The UE initiates the procedure when upper layers request establishment of an RRC connection while the UE is in RRC_IDLE and it has acquired essential system information as described in 5.2.2.1.

The UE shall ensure having valid and up to date essential system information as specified in clause 5.2.2.2 before initiating this procedure.

Upon initiation of the procedure, the UE shall:

- 1> if the upper layers provide an Access Category and one or more Access Identities upon requesting establishment of an RRC connection:
- 2> perform the unified access control procedure as specified in 5.3.14 using the Access Category and Access Identities provided by upper layers;

[TS 38.331, clause 5.3.3.3]

The UE shall set the contents of *RRCSetupRequest* message as follows:

- 1> set the *ue-Identity* as follows:
 - 2> if upper layers provide a 5G-S-TMSI:
 - 3> set the *ue-Identity* to *ng-5G-S-TMSI-Part1*;
 - 2> else:
 - 3> draw a 39-bit random value in the range $0..2^{39}-1$ and set the *ue-Identity* to this value;

NOTE 1: Upper layers provide the *5G-S-TMSI* if the UE is registered in the TA of the current cell.

- 1> set the *establishmentCause* in accordance with the information received from upper layers;

The UE shall submit the *RRCSetupRequest* message to lower layers for transmission.

11.1.1.3 Test Description

11.1.1.3.1 Pre-test conditions

System Simulator:

- NR Cell 1 is configured according to TS 38.508-1 [4] Table 4.4.2-3 and is connected to 5GC.
- E-UTRA Cell 1 is configured to TS 36.508 [7] Table 4.4.2-2 and is connected to EPC.
- System information for the NR Cell 1 in accordance with combination NR-6 in TS 38.508-1 [4] sub-clause 4.4.3.1.2, and, for the E-UTRA Cell 1 in accordance with system information combination 31 as defined in TS 36.508 [7], subclause 4.4.3.1.1.
- N26 interface is configured.
- Power levels are constant and as defined in Table 11.1.1.3.1-1

Table 11.1.1.3.1-1: Cell power levels

| | Parameter name | Unit | NR Cell 1 | E-UTRA Cell 1 |
|----|---------------------|-----------|----------------|----------------|
| T0 | SS/PBCH
SSS EPRE | dBm/SCS | "Serving Cell" | |
| | RS EPRE | dBm/15kHz | | "Serving Cell" |

UE:

None.

Preamble:

With E-UTRA Cell 1 "Serving cell" and NR Cell 1 "Non-suitable "Off" cell" in accordance with TS 38.508-1 [4], Table 6.2.2.1-3, the UE is brought to state RRC_IDLE Connectivity (*E-UTRA/EPC*) in accordance with the procedure described in TS 38.508-1 [4], Table 4.5.2.2-1. 4G GUTI and eKSI are assigned and security context established

The UE is switched-off

With E-UTRA Cell 1 "Non-suitable "Off" cell" and NR Cell 1 "Serving cell" in accordance with TS 38.508-1 [4], Table 6.2.2.1-3, the UE is brought to state 1N-A, RRC_IDLE Connectivity (NR), in accordance with the

procedure described in TS 38.508-1 [4], Table 4.5.2.2-2. 5G-GUTI and ngKSI are assigned and security context established.

11.1.1.3.2 Test procedure sequence

Table 11.1.1.3.2-1: Main behaviour

| St | Procedure | Message Sequence | | TP | Verdict |
|-----------|---|------------------|--|----|---------|
| | | U - S | Message | | |
| 0 | Set the power levels according to "T0" as per Table 11.1.1.3.1-1. | - | - | - | - |
| 1 | Make the UE attempt an MTSI MO Speech Call (Note 1). | - | - | - | - |
| 2 | Check: Does the UE send NR <i>RRCSetupRequest</i> with <i>EstablishmentCause</i> set to 'mo-VoiceCall'? | --> | NR RRC: <i>RRCSetupRequest</i> | 1 | P |
| 3 | SS transmits an NR <i>RRCSetup</i> message | <-- | NR RRC: <i>RRCSetup</i> | - | - |
| 4 | Check: Does the UE transmit an NR <i>RRCSetupComplete</i> message to confirm the successful completion of the connection establishment including initiation of 5GSM procedure by including the SERVICE REQUEST message with <i>Service Type</i> set to 'data'? | --> | NR RRC: <i>RRCSetupComplete</i>
5GSM: SERVICE REQUEST | 1 | P |
| 5-8 | Steps 5-8 of expected sequence from Table 4.5.4.2-3 as defined in TS 38.508-1 [4] are performed. | - | - | - | - |
| 9-13 | Steps 1-5 of expected sequence from A.9.1 as defined in TS 34.229-5 [41] are performed for initiating an MTSI MO speech call. | - | - | - | - |
| 14 | SS transmits <i>RRCRelease</i> message indicating redirection to E-UTRA Cell 1. | <-- | NR RRC: <i>RRCRelease</i> | - | - |
| 15-20 | UE performs generic procedure as defined in TS 38.508-1 [4], Table 4.9.7.2.2-1 Steps 1-6 for N1 to S1 Inter mode change with condition 'connected without release' & 'mapped 5G security context'. | - | - | - | - |
| 21-24 | Generic Test Procedure as defined in Steps 5-8 of TS 36.508-1 [4] Table 4.5A.6.3-1 is performed to establish radio bearer corresponding to IMS PDN. | - | - | - | - |
| - | EXCEPTION: Steps 25a1-25a2 describe a step sequence depending on UE implementation. | - | - | - | - |
| 25a1-25a2 | The UE may perform steps 1-2 according to TS 34.229-1 subclause C.46 to perform IMS re-registration on EUTRAN. | - | - | - | - |
| 26 | The SS configures a new RLC-UM data radio bearer with condition DRB (0,1), associated with the dedicated EPS bearer context. <i>RRCConnectionReconfiguration</i> message contains the ACTIVATE DEDICATED EPS BEARER CONTEXT REQUEST message. EPS bearer context #4 (QCI 1) according to table 6.6.2-1: Reference dedicated EPS bearer contexts. | <-- | RRC:
<i>RRCConnectionReconfiguration</i>
NAS:
ACTIVATE DEDICATED EPS BEARER CONTEXT REQUEST | - | - |
| - | EXCEPTION: In parallel to the events described in steps 27-28 the steps specified in table 11.1.1.3.2-2 will take place. | - | - | - | - |
| 27 | The UE transmits an <i>RRCConnectionReconfigurationComplete</i> message to confirm the establishment of the new data radio bearer, associated with the dedicated EPS bearer. | --> | RRC:
<i>RRCConnectionReconfigurationComplete</i> | - | - |
| 28 | The UE transmits an ACTIVATE DEDICATED EPS BEARER CONTEXT ACCEPT message. | --> | RRC: ULInformationTransfer
NAS:ACTIVATE DEDICATED EPS BEARER CONTEXT ACCEPT | - | - |
| 29 | UE is triggered by MMI to release the call. | - | - | - | - |

| | | | | | |
|---|--|-----|---------------------------------|---|---|
| 30-33 | Follow the Test Steps 2-5 as defined in TS 34.229-1 [35] subclause C.32 for Generic test procedure for MO release of IMS call followed by EPS Bearer Deactivation. | - | - | - | - |
| 34 | SS transmits <i>RRConnectionRelease</i> message indicating redirection to NR Cell 1. | <-- | RRC: <i>RRConnectionRelease</i> | - | - |
| 35 | Generic Test procedure for Tracking area updating / Inter-system change from S1 mode to N1 mode in 5GMM/EMM-IDLE mode with <i>connected without release</i> is present as mentioned in TS 38.508-1 [4] Table 4.9.9.2.2-1 is performed. | - | - | - | - |
| 36-37 | IF UE performed IMS re-registration over E-UTRAN in Steps 25a1-25a2, THEN the UE may perform IMS re-registration on NR Cell1 as per Annex A.12 of TS 34.229-5 [41] | - | - | - | - |
| 38 | Generic Procedure as defined in TS 38.508-1 [4] Table 4.9.6.3-1A to switch off the UE in NR RRC_CONNECTED mode with T3540 started is performed. | - | - | - | - |
| Note 1: UE is configured such that Access Control check passes for MO MMTEL Voice call. | | | | | |

Table 11.1.1.3.2-2: Parallel behaviour

| St | Procedure | Message Sequence | | TP | Verdict |
|-----|---|------------------|---------|----|---------|
| | | U - S | Message | | |
| 1-4 | Steps 1 to 4 of the Generic test procedure for setting up MTSI MO speech call - EPS fallback according TS 34.229-5 [41] subclause A.9.2 take place. | - | - | - | - |
| 5 | Step 5 of the Generic test procedure for setting up MTSI MO speech call - EPS fallback according TS 34.229-5 [41] subclause A.9.2 takes place. | - | - | 2 | P |

11.1.1.3.3 Specific message contents

Table 11.1.1.3.3-1: RRCSetupRequest (step 2, table 11.1.1.3.2-1)

| Derivation Path: TS 38.508-1 [4] Table 4.6.1-23 | | | |
|---|--------------|---------|-----------|
| Information Element | Value/remark | Comment | Condition |
| RRCSetupRequest ::= SEQUENCE { | | | |
| rrcSetupRequest SEQUENCE { | | | |
| establishmentCause | mo-VoiceCall | | |
| } | | | |
| } | | | |

Table 11.1.1.3.3-2: SERVICE REQUEST (step 4, table 11.1.1.3.2-1)

| Derivation path: TS 38.508-1 [4] Table 4.7.1-16 | | | |
|---|--------------|--|-----------|
| Information Element | Value/Remark | Comment | Condition |
| Service type | '0001'B | data | |
| Uplink data status | Present | PSI bit corresponding to IMS PDN needs to be set | |

Table 11.1.1.3.3-3: RRCRelease (step 14, table 11.1.1.3.2-1)

| Derivation path: TS 38.508-1 [4] Table 4.6.1-16 | | | |
|---|---------------------------------|---------|-----------|
| Information Element | Value/Remark | Comment | Condition |
| RRCRelease ::= SEQUENCE { | | | |
| criticalExtensions CHOICE { | | | |
| rrcRelease SEQUENCE { | | | |
| redirectionCarrierInfo CHOICE { | | | |
| eutra SEQUENCE { | | | |
| eutraFrequency | Downlink EARFCN of EUTRA cell 1 | | |
| cnType | epc | | |
| } | | | |
| } | | | |
| } | | | |
| } | | | |
| } | | | |
| } | | | |

Table 11.1.1.3.3-4: RRCConnectionRelease (step 34, table 11.1.1.3.2-1)

| Derivation path: TS 36.508 [4] Table 4.6.1-15 | | | |
|---|---|---------|----------------------------|
| Information Element | Value/Remark | Comment | Condition |
| RRCConnectionRelease ::= SEQUENCE { | | | |
| criticalExtensions CHOICE { | | | |
| c1 CHOICE { | | | |
| rrcConnectionRelease-r8 SEQUENCE { | | | |
| redirectionCarrierInfo SEQUENCE { | | | |
| nr-r15 ::= SEQUENCE { | | | |
| carrierFreq-r15 | Downlink NR SSB ARFCN of cell NR Cell 1 | | TS 38.508-1 [4] cl.6.2.3.1 |
| subcarrierSpacingSSB-r15 | | | |
| } | | | |
| } | | | |
| } | | | |
| } | | | |
| } | | | |

11.1.2 MO MMTEL voice call setup from NR RRC_IDLE / EPS Fallback with redirection / Single registration mode without N26 interface / Success

11.1.2.1 Test Purpose (TP)

(1)

```

with {UE supporting both S1 mode and N1 mode and operating in single-registration mode, and, the Network has indicated "interworking without N26 interface supported", and, the UE is in NR RRC_IDLE state}
ensure that {
  when {User initiates a MMTEL call and the UE completes Access control and checking in 5GMM-IDLE mode}
  then {UE requests the establishment of a MMTEL call by transmitting an RRCSetupRequest message with establishmentCause set to 'mo-VoiceCall', and, a SERVICE REQUEST message with Service type set to 'data'}
}

```

(2)

```

with {the UE is NR RRC_CONNECTED state after having requested a MMTEL call establishment and the MO IMS voice session establishment has been initiated}
ensure that {

```



```

when {the UE receives a RRCRelease message which includes redirectedCarrierInfo indicating
redirection to eutra}
then {the UE selects the E-UTRA cell, performs an ATTACH or a TAU procedure, and, successfully
completes the MO MMTEL call setup in EPS}
}
    
```

11.1.2.2 Conformance requirements

References: The conformance requirements covered in the current TC are specified in: TS23.502, clauses 4.11.2.2, 4.13.6.1; TS 24.501, clauses 4.5.4.1, 4.8.2.3; TS 38.331, clause 5.3.11. Unless otherwise stated these are Rel-15 requirements.

[TS 23.502, clause 4.11.2.2]

The following procedure is used by UEs in single-registration or dual registration mode on mobility from 5GS to EPS.

In the case of network sharing the UE selects the target PLMN ID according to clause 5.18.3 of TS 23.501 [2].

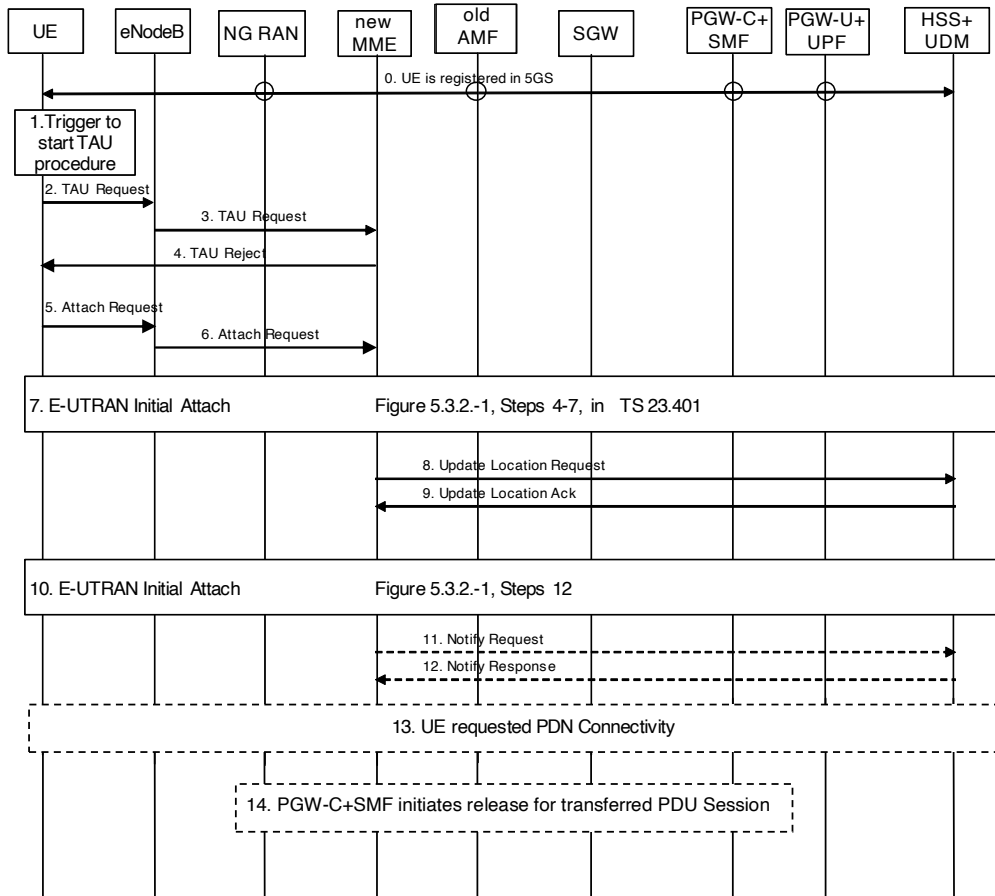

Figure 4.11.2.2-1: Mobility procedure from 5GS to EPS without N26 interface

The UE operating in single-registration mode can start the procedure from Step 1 or Step 5. The UE operating in dual-registration mode starts the procedure from Step 5.

NOTE 1: The network has indicated the "Interworking without N26" to the UE. To support IP address preservation, the UE in single-registration mode starts the procedure from Step 5. If the UE in single-registration mode starts the procedure from Step 1, the IP address preservation is not provided.

0. UE is registered in 5GS and established PDU sessions. The FQDN for the S5/S8 interface of the PGW-C+SMF is also stored in the UDM by the PGW-C+SMF during PDU Session setup in addition to what is specified in clause 4.3.2.2.1 and clause 4.3.2.2.2.

NOTE 2: At 5GS to EPS mobility, the MME use the FQDN for the S5/S8 interface of the PGW-C+SMF to find the PGW-C+SMF, and when UE moves back from EPS to 5GS, the AMF uses FQDN for the S5/S8 interface of the PGW-C+SMF to find the PGW-C+SMF.

1. Step 1 as in clause 5.3.3.1 (Tracking Area Update) in TS 23.401 [13].
2. Step 2 as in clause 5.3.3.1 (Tracking Area Update) in TS 23.401 [13] with the following modifications:
The UE shall provide a EPS-GUTI that is mapped from the 5G-GUTI following the mapping rules specified in TS 23.501 [2]. The UE indicates that it is moving from 5GC.
3. Step 3 as in clause 5.3.3.1 (Tracking Area Update) in TS 23.401 [13].
4. If the MME determined that the old node is an AMF based on UE's GUTI mapped from 5G-GUTI and the MME is configured to support 5GS-EPS interworking without N26 procedure, the MME sends a TAU Reject to the UE.
5. Step 1 as in clause 5.3.2.1 (E-UTRAN Initial Attach) in TS 23.401 [13] with the modifications captured in clause 4.11.2.4.1.
6. Step 2 as in clause 5.3.2.1 (E-UTRAN Initial Attach) in TS 23.401 [13].
7. Steps 4-7 as in clause 5.3.2.1 (E-UTRAN Initial Attach) in TS 23.401 [13], with the modifications captured in clause 4.11.2.4.1.
8. Step 8 as in clause 5.3.2.1 (E-UTRAN Initial Attach) in TS 23.401 [13], with the modifications captured in clause 4.11.2.4.1.
9. Step 11 as in clause 5.3.2.1 (E-UTRAN Initial Attach) in TS 23.401 [13], with the following modifications:
The subscription profile the MME receives from HSS+UDM includes per DNN/APN at most one PGW-C+SMF FQDN as described in in clause 5.17.2.1 in TS 23.501 [2].
10. Steps 12-24 as in clause 5.3.2.1 (E-UTRAN Initial Attach) in TS 23.401 [13], with the modifications as described in clause 4.11.2.4.1.
11. Step 25 as in clause 5.3.2.1 (E-UTRAN Initial Attach) in TS 23.401 [13].
12. Step 26 as in clause 5.3.2.1 (E-UTRAN Initial Attach) in TS 23.401 [13].
13. If the UE has remaining PDU Sessions in 5GS which it wants to transfer to EPS and maintain the same IP address/prefix, the UE performs the UE requested PDN Connectivity Procedure as specified in TS 23.401 [13] clause 5.10.2 and sets the Request Type to "handover" in Step 1 of the procedure with modification captured in clause 4.11.2.4.2. UE provides an APN and the PDU Session ID corresponding to the PDU Session it wants to transfer to EPS. The UE provides the PDU Session ID in PCO as described in clause 4.11.1.1.

UEs in single-registration mode performs this step for each PDU Session immediately after completing the E-UTRAN Initial Attach procedure. UEs in dual-registration mode may perform this step any time after the completing of E-UTRAN Initial Attach procedure. Also, UEs in dual-registration mode may perform this step only for a subset of PDU Sessions.

The MME determines the PGW-C+SMF address for the Create Session Request based on the APN received from the UE and the subscription profile received from the HSS+UDM in Step 9 or when the HSS+UDM notifies the MME for the new PGW-C+SMF ID in the updated subscription profile.

The PGW-C+SMF uses the PDU Session ID to correlate the transferred PDN connection with the PDU Session in 5GC.

As a result of the procedure the PGW-U+UPF starts routing DL data packets to the Serving GW for the default and any dedicated EPS bearers established for this PDN connection.

14. The PGW-C+SMF initiates release of the PDU Session(s) in 5GS transferred to EPS as specified in clause 4.3.4.2 with the following clarification:

In step 2, the PGW-C+SMF shall not release IP address/prefix(es) allocated for the PDU Session.

If UP connection of the PDU Session is not active, step 3b is not executed, thus the steps triggered by step 3b are not executed;

If UP connection of the PDU Session is active, the SMF invokes the Namf_Communication_N1N2MessageTransfer service operation without including N1 SM container (PDU Session Release Command).

[TS 23.502, clause 4.13.6.1]

Figure 4.13.6.1-1 describes the EPS fallback procedure for IMS voice.

When the UE is served by the 5G System, the UE has one or more ongoing PDU Sessions each including one or more QoS Flows. The serving PLMN AMF has sent an indication towards the UE during the Registration procedure that IMS voice over PS session is supported, see clause 5.16.3.10 in TS 23.501 [2] and the UE has registered in the IMS. If N26 is not supported, the serving PLMN AMF sends an indication towards the UE during the Registration procedure that interworking without N26 is supported, see clause 5.17.2.3.1 in TS 23.501 [2].

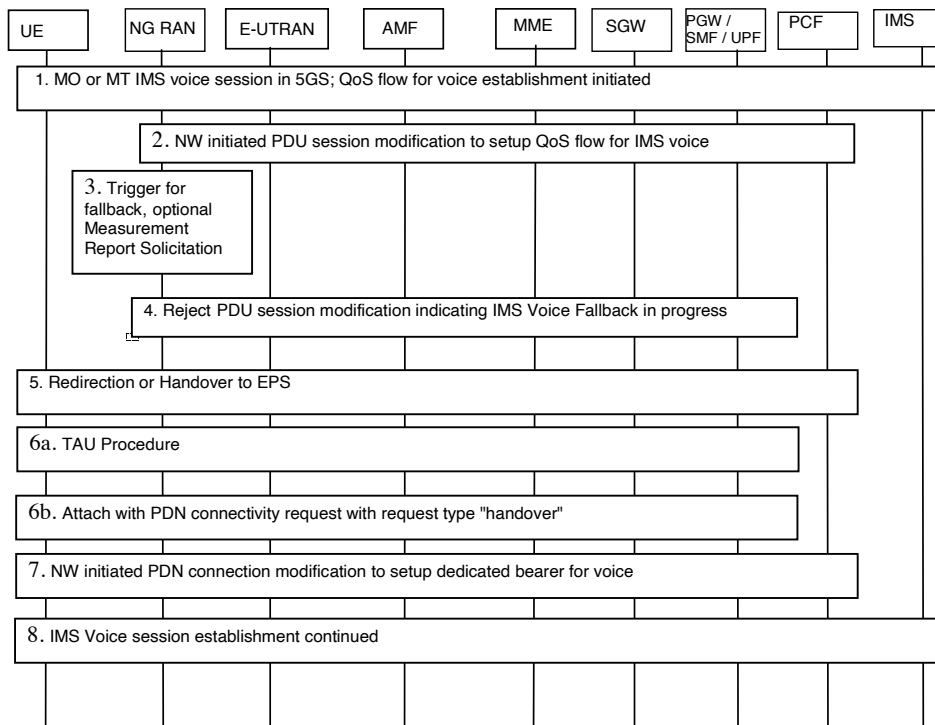

Figure 4.13.6.1-1: EPS Fallback for IMS voice

1. UE camps on NG-RAN in the 5GS and an MO or MT IMS voice session establishment has been initiated.
2. Network initiated PDU Session modification to setup QoS flow for voice reaches the NG-RAN (see N2 PDU Session Request in clause 4.3.3).
3. NG-RAN is configured to support EPS fallback for IMS voice and decides to trigger fallback to EPS, taking into account UE capabilities, indication from AMF that "Redirection for EPS fallback for voice is possible" (received as part of initial context setup as defined in TS 38.413 [10]), network configuration (e.g. N26 availability configuration) and radio conditions. If NG-RAN decides not to trigger fallback to EPS, then the procedure stops here and following steps are not executed.

NG-RAN may initiate measurement report solicitation from the UE including E-UTRAN as target.

NOTE 1: If AMF has indicated that "Redirection for EPS fallback for voice is not possible", then AN Release via inter-system redirection to EPS is not performed in step 5.

4. NG-RAN responds indicating rejection of the PDU Session modification to setup QoS flow for IMS voice received in step 2 by PDU Session Response message towards the PGW-C+SMF (or H-SMF+P-GW-C via V-SMF, in case of roaming scenario) via AMF with an indication that mobility due to fallback for IMS voice is ongoing. The PGW-C+SMF maintains the PCC rule(s) associated with the QoS Flow(s).
5. NG-RAN initiates either handover (see clause 4.11.1.2.1), or AN Release via inter-system redirection to EPS (see clause 4.2.6 and clause 4.11.1.3.2), taking into account UE capabilities. The PGW-C+SMF reports change of the RAT type if subscribed by PCF as specified in clause 4.11.1.2.1, or clause 4.11.1.3.2.6. When the UE is connected to EPS, either 6a or 6b is executed
 - 6a. In the case of 5GS to EPS handover, see clause 4.11.1.2.1, and in the case of inter-system redirection to EPS with N26 interface, see clause 4.11.1.3.2. In either case the UE initiates TAU procedure; or
 - 6b. In the case of inter-system redirection to EPS without N26 interface, see clause 4.11.2.2. If the UE supports Request Type flag "handover" for PDN connectivity request during the attach procedure as described in clause 5.3.2.1 of TS 23.401 [13] and has received the indication that interworking without N26 is supported, then the UE initiates Attach with PDN connectivity request with request type "handover".

In inter-system redirection, the UE uses the emergency indication in the RRC message as specified in clause 6.2.2 of TS 36.331 [16] and E-UTRAN provides the emergency indication to MME during Tracking Area Update or Attach procedure. For the handover procedure see clause 4.11.1.2.1, step 1.
7. After completion of the mobility procedure to EPS or as part of the 5GS to EPS handover procedure (see clause 4.11.1.2.1), the SMF/PGW re-initiates the setup of the dedicated bearer for IMS voice, mapping the 5G QoS to EPC QoS parameters. The PGW-C+SMF behaves as specified in clause 4.9.1.3.1. The PGW-C+SMF reports about Successful Resource Allocation and Access Network Information if subscribed by PCF.
8. The IMS voice session establishment is continued.

At least for the duration of the voice call in EPS the E-UTRAN is configured to not trigger any handover to 5GS.

[TS 24.501, clause 4.5.4.1]

When the UE is in 5GMM-IDLE mode, upon receiving a request from the upper layers for an access attempt, the NAS shall categorize the access attempt into access identities and an access category following subclause 4.5.2, table 4.5.2.1 and table 4.5.2.2, and subclause 4.5.3, and provide the applicable access identities and the access category to the lower layers for the purpose of access control checking. In this request to the lower layer the NAS can also provide to the lower layer the RRC establishment cause determined as specified in subclause 4.5.6 of this specification.

NOTE 1: The access barring check is performed by the lower layers.

NOTE 2: As an implementation option, the NAS can provide the RRC establishment cause to the lower layers after being informed by the lower layers that the access attempt is allowed.

If the UE has uplink user data pending for one or more PDU sessions when it builds a REGISTRATION REQUEST or SERVICE REQUEST message as initial NAS message, the UE shall indicate the respective PDU sessions in the Uplink data status IE as specified in subclause 5.5.1.3.2 and 5.6.1.2, regardless of the access category for which the access barring check is performed.

NOTE 3: The UE indicates pending user data for all the respective PDU sessions, even if barring timers are running for some of the corresponding access categories.

If the lower layers indicate that the access attempt is allowed, the NAS shall initiate the procedure to send the initial NAS message for the access attempt.

If the lower layers indicate that the access attempt is barred, the NAS shall not initiate the procedure to send the initial NAS message for the access attempt. Additionally:

- a) if the event which triggered the access attempt was an MO-MMTEL-voice-call-started indication or an MO-MMTEL-video-call-started indication:

- 1) if the UE is operating in the single-registration mode and the UE's usage setting is "voice centric", the UE may attempt to select an E-UTRA cell connected to EPC. If the UE finds a suitable E-UTRA cell connected to EPC, it then proceeds with the appropriate EMM specific procedures and, if necessary, ESM procedures to make a PDN connection providing access to IMS available; see subclause 4.8.2 and 3GPP TS 24.301 [15];
 - 2) if the UE is operating in the dual-registration mode, the UE may proceed in S1 mode with the appropriate EMM specific procedures and ESM procedures to make a PDN connection providing access to IMS available; see subclause 4.8.3 and 3GPP TS 24.301 [15];
 - 3) otherwise, the NAS shall notify the upper layers that the access attempt is barred. In this case, upon receiving an indication from the lower layers that the barring is alleviated for the access category with which the access attempt was associated, the NAS shall notify the upper layers that the barring is alleviated for the access category and may initiate the procedure to send the initial NAS message, if still needed; and
- b) if the event which triggered the access attempt was an MO-SMSoIP-attempt-started indication:
- 1) if the UE is operating in the single-registration mode, the UE may attempt to select an E-UTRA cell connected to EPC. If the UE finds a suitable E-UTRA cell connected to EPC, it then proceeds with the appropriate EMM specific procedures and, if necessary, ESM procedures to make a PDN connection providing access to IMS available; see subclause 4.8.2 and 3GPP TS 24.301 [15];
 - 2) if the UE is operating in the dual-registration mode, the UE may proceed in S1 mode with the appropriate EMM specific procedures and ESM procedures to make a PDN connection providing access to IMS available; see subclause 4.8.3 and 3GPP TS 24.301 [15];
 - 3) otherwise, the NAS layer shall notify the upper layers that the access attempt is barred. In this case, upon receiving an indication from the lower layers that the barring is alleviated for the access category with which the access attempt was associated, the NAS shall notify the upper layers that the barring is alleviated for the access category and may initiate the procedure to send the initial NAS message, if still needed.

NOTE 4: Barring timers, on a per access category basis, are run by the lower layers. At expiry of barring timers, the indication of alleviation of access barring is indicated to the NAS on a per access category basis.

[TS 24.501, clause 4.8.2.3]

At inter-system change from N1 mode to S1 mode in EMM-IDLE mode when: (PDU SEESION ACTIVE)

- a) the UE supports non-IP PDN type and at least one PDU session is active; or
- b) the UE does not support non-IP PDN type and at least one PDU session of IPv4, IPv6 or IPv4v6 PDU session type is active,

the UE shall proceed as follows:

- a) if the UE supports sending an ATTACH REQUEST message containing a PDN CONNECTIVITY REQUEST message with request type set to "handover" to transfer a PDU session from N1 mode to S1 mode and the UE has received an "interworking without N26 interface supported" indication from the network, the UE shall:
 - 1) enter substates EMM-DEREGISTERED.NORMAL-SERVICE and 5GMM-REGISTERED.NO-CELL-AVAILABLE;
 - 2) map the PDU session(s) which the UE intends to transfer to EPS to the default EPS bearer context of the corresponding PDN connection(s) as specified in subclause 6.1.4.2; and
 - 3) initiate an EPS attach procedure and include a PDN CONNECTIVITY REQUEST message with request type set to "handover" in the ATTACH REQUEST message to activate a default EPS bearer context for one of the active PDU sessions which the UE intends to transfer to EPS.

After successful completion of the EPS attach procedure, the UE shall reset the registration attempt counter and the attach attempt counter (see 3GPP TS 24.301 [15]) and attempt to activate each of the other default EPS bearer contexts, if any, by initiating a stand-alone PDN connectivity procedure with request type set to "handover" in the PDN CONNECTIVITY REQUEST message; and

- b) otherwise, enter substates EMM-REGISTERED.NORMAL-SERVICE and 5GMM-REGISTERED.NO-CELL-AVAILABLE and initiate a tracking area update procedure (see 3GPP TS 24.301 [15]).

At inter-system change from N1 mode to S1 mode in EMM-IDLE mode when: (NO PDU SESSION)

- a) the UE supports non-IP PDN type and no PDU session is active; or
- b) the UE does not support non-IP PDN type and no PDU session of IPv4, IPv6 or IPv4v6 PDU session type is active,

the UE shall enter substates EMM-DEREGISTERED.NORMAL-SERVICE and 5GMM-DEREGISTERED.NO-CELL-AVAILABLE, and initiate an attach procedure.

At inter-system change from S1 mode to N1 mode in 5GMM-IDLE mode, the UE shall:

- a) enter substate 5GMM-REGISTERED.NORMAL-SERVICE and substate EMM-REGISTERED.NO-CELL-AVAILABLE;
- b) map the default EPS bearer context(s) of the PDN connection(s) which the UE intends to transfer to 5GS, if any, to the corresponding PDU session(s) as specified in subclause 6.1.4.2; and
- c) initiate the registration procedure for mobility and periodic registration update indicating "mobility registration updating" in the 5GS registration type IE of the REGISTRATION REQUEST message (see subclause 5.5.1.3).

After having successfully registered in N1 mode the UE shall reset the registration attempt counter and the attach attempt counter (see 3GPP TS 24.301 [15]) and:

- a) if the UE supports the PDU session establishment procedure with request type set to "existing PDU session" to transfer a PDN connection from S1 mode to N1 mode and the UE has received an "interworking without N26 interface supported" indication from the network, attempt to transfer the PDN connection(s) which the UE intends to transfer to 5GS, if any, from S1 mode to N1 mode by initiating the PDU session establishment procedure with request type set to "existing PDU session"; and
- b) otherwise, establish PDU session(s) corresponding to the PDN connection(s) which the UE intends to transfer to 5GS, if any, by initiating the PDU session establishment procedure with request type set to "initial request".

See subclause 5.1.4.3 for coordination between 5GMM and EMM and subclause 6.1.4.2 for coordination between 5GSM and ESM.

[TS 38.331, clause 5.3.11]

UE shall:

- 1> reset MAC;
- 1> if T302 is running:
 - 2> stop timer T302;
 - 2> perform the actions as specified in 5.3.14.4;
- 1> stop all timers that are running except T320 and T325;
- 1> discard the UE Inactive AS context;
- 1> set the variable *pendingRnaUpdate* to *false*, if that is set to *true*;
- 1> discard the K_{gNB} , the $K_{RRCCenc}$ key, the K_{RRCint} , the K_{UPint} key and the K_{UPenc} key, if any;
- 1> release all radio resources, including release of the RLC entity, the MAC configuration and the associated PDCP entity and SDAP for all established RBs;
- 1> indicate the release of the RRC connection to upper layers together with the release cause;
- 1> enter RRC_IDLE and perform cell selection as specified in TS 38.304 [20], except if going to RRC_IDLE was triggered by selecting an inter-RAT cell while T311 was running;
- 1> if going to RRC_IDLE was triggered by reception of the *RRCRelease* message including a *waitTime*:
 - 2> start timer T302 with the value set to the *waitTime*;

2> inform the upper layer that access barring is applicable for all access categories except categories '0' and '2'.

11.1.2.3 Test description

11.1.2.3.1 Pre-test conditions

System Simulator:

- 2 cells
- NR Cell 1 as defined in TS 38.508-1 [4] Table 4.4.2-3. System information combination NR-6 as defined in TS 38.508-1 [4], sub-clause 4.4.3.1.2.
- E-UTRA Cell 1 as defined in TS 36.508 [7] Table 4.4.2-2. System information combination 31 as defined in TS 36.508 [7], sub-clause 4.4.3.1.1.

UE:

-None

Preamble:

- With E-UTRA Cell 1 "Serving cell" and NR Cell 1 "Non-suitable "Off" cell" in accordance with TS 38.508-1 [4], Table 6.2.2.1-3, the UE is brought to state RRC_IDLE Connectivity (*E-UTRA/EPC*) in accordance with the procedure described in TS 38.508-1 [4], Table 4.5.2.2-1. 4G GUTI and eKSI are assigned and security context established
- The UE is switched-off
- With E-UTRA Cell 1 "Non-suitable "Off" cell" and NR Cell 1 "Serving cell" in accordance with TS 38.508-1 [4], Table 6.2.2.1-3, the UE is brought to state 1N-A, RRC_IDLE Connectivity (NR), in accordance with the procedure described in TS 38.508-1 [4], with one IMS PDU session on NR Cell 1, Table 4.5.2.2-2. 5G-GUTI and ngKSI are assigned and security context established.

11.1.2.3.2 Test procedure sequence

Table 11.1.2.3.2-1: Main behaviour

| St | Procedure | Message Sequence | | TP | Verdict |
|-------|---|------------------|---|----|---------|
| | | U – S | Message | | |
| 1 | The SS configures:
- E-UTRA Cell 1 as "Suitable neighbour intra-frequency cell" in accordance with TS 38.508-1 [4], Table 6.2.2.1-3. | - | - | - | - |
| - | EXCEPTION: Unless otherwise stated the following messages are exchange on NR Cell 1. | - | - | - | - |
| 2 | User initiates a MMTEL call. | - | - | - | - |
| 3 | Check: Does the UE transmits an <i>RRCSetupRequest</i> message? | --> | NR RRC: <i>RRCSetupRequest</i> | 1 | P |
| 4 | The SS transmits an <i>RRCSetup</i> message. | <-- | NR RRC: <i>RRCSetup</i> | - | - |
| 5 | Check: Does the UE transmits an <i>RRCSetupComplete</i> message and a SERVICE REQUEST message? | --> | NR RRC: <i>RRCSetupComplete</i>
5GMM: SERVICE REQUEST | 1 | P |
| 6 | The SS transmits an <i>RRCRelease</i> message. | <-- | NR RRC: <i>RRCRelease</i> | - | - |
| - | EXCEPTION: Unless otherwise stated the following messages are exchange on E-UTRA Cell 1. | - | - | - | - |
| 7 | The UE transmits an <i>RRCConnectionRequest</i> message on the cell specified in the test case. | --> | RRC: <i>RRCConnectionRequest</i> | - | - |
| 8 | SS transmits an <i>RRCConnectionSetup</i> message. | <-- | RRC: <i>RRCConnectionSetup</i> | - | - |
| - | EXCEPTION: Steps 8a1 to 8b18 describe behaviour that depends on the UE implementation; the "lower case letter" identifies a step sequence that take place depending on the UE implementation. | - | - | - | - |
| 8a1 | If the UE tries to preserve the IP address of the PDN connection then check does the UE transmits an ATTACH REQUEST message? | --> | RRC: <i>RRCConnectionSetupComplete</i>
NAS: ATTACH REQUEST | 2 | P |
| 8b1 | Else check: does the UE transmit a TRACKING AREA UPDATE REQUEST message? | --> | RRC: <i>RRCConnectionSetupComplete</i>
NAS: TRACKING AREA UPDATE REQUEST | 2 | P |
| 8b2 | The SS transmits a TRACKING AREA UPDATE REJECT message to UE. | <-- | RRC: <i>DLInformationTransfer</i>
NAS: TRACKING AREA UPDATE REQUEST REJECT | - | - |
| 8b3 | The UE transmits an ATTACH REQUEST message. | --> | RRC: <i>ULInformationTransfer</i>
NAS: ATTACH REQUEST | - | - |
| 9-20 | Steps 5 to 16 of the generic test procedure for UE registration (TS 36.508 [2] Table 4.5.2.3-1) | - | - | - | - |
| - | EXCEPTION: In parallel to the events described in steps 10 to 16 the UE may perform IMS re-registration on EUTRAN assteps as defined in TS 34.229-1 [35] subclause C.46 | - | - | - | - |
| 21-28 | Steps 7-14 from the Generic Test Procedure for MTSI MO speech call establishment (TS 36.508 [2] table 4.5A.6.3-1) are performed. | - | - | - | - |
| 29 | The SS waits 1 second. | - | - | - | - |
| 30 | Release IMS Call as specified in the generic procedure in TS 34.229-1 [35] subclause C.32. | - | - | - | - |

11.1.2.3.3 Specific message contents

Table 11.1.2.3.3-0: REGISTRATION ACCEPT (preamble; step 14, TS 38.508-1 [4], Table 4.5.2.2-2)

| Derivation path: TS 38.508-1[4] Table 4.7.1-7 | | | |
|---|------------------------|---|-----------|
| Information Element | Value/remark | Comment | Condition |
| Extended protocol discriminator | '0111 1110'B | 5GS mobility management messages | |
| Security header type | '0000'B | Plain 5GS NAS message, not security protected | |
| Spare half octet | '0000'B | | |
| 5GS network feature support | '0100 0001 0000 0000'B | Interworking without N26 interface supported | |

Table 11.1.2.3.3-1: RRCSetupRequest (step 3, table 11.1.2.3.2-1)

| Derivation Path: TS 38.508-1 [4] Table 4.6.1-23 | | | |
|---|--------------|---------|-----------|
| Information Element | Value/remark | Comment | Condition |
| RRCSetupRequest ::= SEQUENCE { | | | |
| rrcSetupRequest SEQUENCE { | | | |
| establishmentCause | Mo-Voicecall | | |
| } | | | |
| } | | | |

Table 11.1.2.3.3-2: SERVICE REQUEST (step 5, table 11.1.2.3.2-1)

| Derivation path: TS 38.508-1 [4] Table 4.7.1-16 | | | |
|---|--------------|--|-----------|
| Information Element | Value/Remark | Comment | Condition |
| Service type | '0001'B | data | |
| Uplink data status | Present | PSI bit corresponding to IMS PDN needs to be set | |

Table 11.1.2.3.3-3: RRCRelease (step 6, table 11.1.2.3.2-1)

| Derivation path: TS 38.508-1 [4] Table 4.6.1-16 | | | |
|---|----------------------------------|---------|-----------|
| Information Element | Value/Remark | Comment | Condition |
| RRCRelease ::= SEQUENCE { | | | |
| criticalExtensions CHOICE { | | | |
| rrcRelease SEQUENCE { | | | |
| redirectedCarrierInfo CHOICE { | | | |
| eutra.SEQUENCE{ | | | |
| eutraFrequency | Downlink EARFCN of E-UTRA cell 1 | | |
| cnType | epc | | |
| } | | | |
| } | | | |
| } | | | |
| } | | | |

Table 11.1.2.3.3-3A: ATTACH REQUEST (step 8a1, table 11.1.2.3.2-1)

| Derivation Path: TS 36.508 [7], Table 4.7.2-4. | | | |
|--|---|---------|-----------|
| Information Element | Value/Remark | Comment | Condition |
| NAS key set identifier | KSI _{ASME} that was created when the UE last registered to EPC E-UTRA | | |
| Old GUTI | GUTI, mapped from the 5G-GUTI assigned at the initial registration when the UE entered N1 | | |
| Last visited registered TAI | The TAI the last visited E-UTRA Cell belonged to, if any. Not included if the UE does not have last stored EPC TAI. | | |
| Old GUTI type | "Native GUTI" | | |
| ESM message container | PDN CONNECTIVITY REQUEST message to active PDU sessions which the UE intends to transfer to EPS. | | |

Table 11.1.2.3.3-3B: PDN CONNECTIVITY REQUEST (Table 11.1.2.3.3-3A)

| Derivation Path: TS 36.508 [7], Table 4.7.3-20 | | | |
|--|---|--|-----------|
| Information Element | Value/remark | Comment | Condition |
| EPS bearer identity | 0 | No EPS bearer identity assigned, for coding see Table 9.11.4.8.1 in TS 24.501 [22] | |
| Procedure transaction identity | Any value from 1 to 254 | | |
| PDN connectivity request message identity | '1101 0000'B | PDN connectivity request | |
| Request type | '010'B | Handover | |
| PDN type | Any value between '001'B, '010'B, '011'B and '100'B | The allowed values are respectively IPv4, IPv6, IPv4v6 and "unused but interpreted as IPv6 by the network" | |
| Protocol configuration options | PDU session ID of 5GS PDU session | | |

Table 11.1.2.3.3-4: TRACKING AREA UPDATE REQUEST (step 8b1, table 11.1.2.3.2-1)

| Derivation Path: TS 36.508 [7], Table 4.7.2-27, condition NR. | | | |
|---|---|--|-----------|
| Information Element | Value/Remark | Comment | Condition |
| "Active" flag | 0001 | Bearer Establishment requested | |
| EPS bearer context status | Present | EBI corresponding to active PDU Sessions need to be set to 1 | |
| NAS key set identifier | KSI _{ASME} that was created when the UE last registered to EPC E-UTRA | | |
| Old GUTI | GUTI, mapped from the 5G-GUTI assigned at the initial registration when the UE entered N1 | | |
| Last visited registered TAI | The TAI the last visited E-UTRA Cell belonged to, if any. Not included if the UE does not have last stored EPC TAI. | | |
| Old GUTI type | "Native GUTI" | | |
| UE status | "UE is in 5GMM-REGISTERED state" | | |

Table 11.1.2.3.3-5: TRACKING AREA UPDATE REJECT (step 8b2, table 11.1.2.3.2-1)

| Derivation Path: TS 36.508 [7], Table 4.7.2-26. | | | |
|---|--------------|---|-----------|
| Information Element | Value/Remark | Comment | Condition |
| EMM cause | '0000 1001'B | #9 "UE identity cannot be derived by the network" | |

Table 11.1.2.3.3-6: ATTACH REQUEST (step 8b3, table 11.1.2.3.2-1)

| Derivation Path: TS 36.508 [7], Table 4.7.2-4. | | | |
|--|----------------|---------|-----------|
| Information Element | Value/Remark | Comment | Condition |
| IMSI | IMSI of the UE | | |

11.1.3 MO MMTEL voice call setup from NR RRC_CONNECTED / EPS Fallback with handover / Single registration mode with N26 interface / Success

11.1.3.1 Test Purpose (TP)

(1)

```

with { UE supporting both S1 mode and N1 mode and operating in single-registration mode, and, the
Network has indicated "interworking without N26 interface not supported", and, the UE is in NR
RRC_CONNECTED state after having established connection with establishmentCause set to 'mo-Data',
and, the UE is receiving and transmitting PS data }
ensure that {
  when { User initiates a MMTEL call, the MO IMS voice session establishment has been initiated and
the UE receives a MobilityFromNRCommand message which includes targetRAT-Type set to eutra }
  then { UE performs a handover to the E-UTRA including a TAU procedure, and, while the UE
continues receiving and transmitting PS data the UE successfully completes the MO MMTEL call in EPS
}
}

```

11.1.3.2 Conformance requirements

References: The conformance requirements covered in the present test case are specified in: TS 23.502, clauses 4.13.6.1, TS 24.501, clauses 4.8.2.2, 5.5.1.2.2, 5.5.1.2.4, 5.1.4.2 and 6.1.4.1, TS 38.331, clause 5.4.3.3 and 5.4.3.4. Unless otherwise stated these are Rel-15 requirements.

[TS 23.502, clause 4.13.6.1]

Figure 4.13.6.1-1 describes the EPS fallback procedure for IMS voice.

When the UE is served by the 5G System, the UE has one or more ongoing PDU Sessions each including one or more QoS Flows. The serving PLMN AMF has sent an indication towards the UE during the Registration procedure that IMS voice over PS session is supported, see clause 5.16.3.10 in TS 23.501 [2] and the UE has registered in the IMS. If N26 is not supported, the serving PLMN AMF sends an indication towards the UE during the Registration procedure that interworking without N26 is supported, see clause 5.17.2.3.1 in TS 23.501 [2].

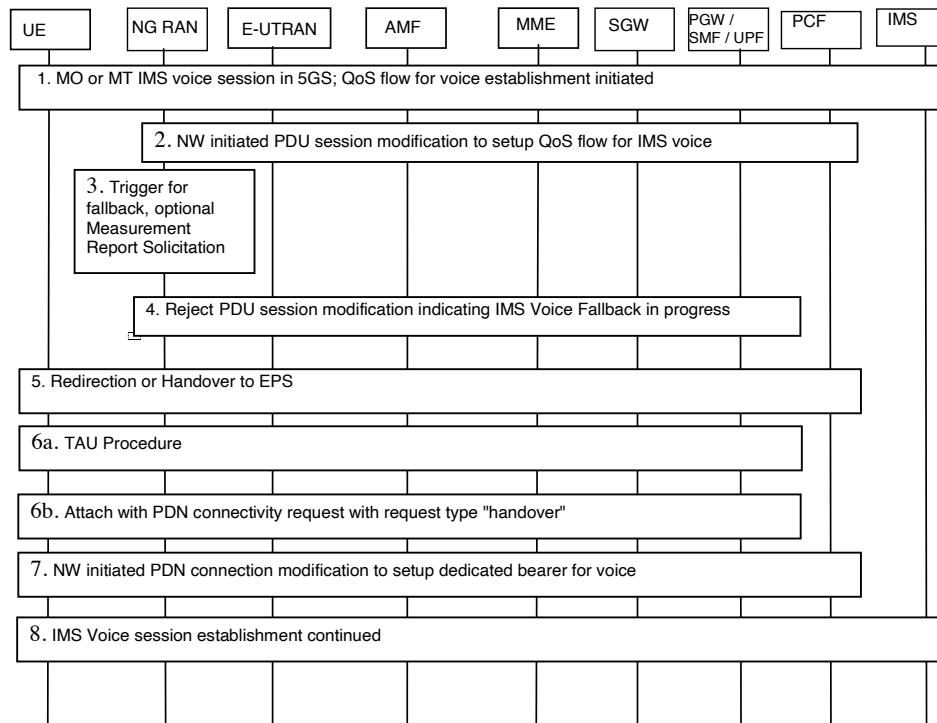

Figure 4.13.6.1-1: EPS Fallback for IMS voice

1. UE camps on NG-RAN in the 5GS and an MO or MT IMS voice session establishment has been initiated.
2. Network initiated PDU Session modification to setup QoS flow for voice reaches the NG-RAN (see N2 PDU Session Request in clause 4.3.3).
3. NG-RAN is configured to support EPS fallback for IMS voice and decides to trigger fallback to EPS, taking into account UE capabilities, indication from AMF that "Redirection for EPS fallback for voice is possible" (received as part of initial context setup as defined in TS 38.413 [10]), network configuration (e.g. N26 availability configuration) and radio conditions. If NG-RAN decides not to trigger fallback to EPS, then the procedure stops here and following steps are not executed.

NG-RAN may initiate measurement report solicitation from the UE including E-UTRAN as target.

NOTE 1: If AMF has indicated that "Redirection for EPS fallback for voice is not possible", then AN Release via inter-system redirection to EPS is not performed in step 5.

4. NG-RAN responds indicating rejection of the PDU Session modification to setup QoS flow for IMS voice received in step 2 by PDU Session Response message towards the PGW-C+SMF (or H-SMF+P-GW-C via V-SMF, in case of roaming scenario) via AMF with an indication that mobility due to fallback for IMS voice is ongoing. The PGW-C+SMF maintains the PCC rule(s) associated with the QoS Flow(s).
5. NG-RAN initiates either handover (see clause 4.11.1.2.1), or AN Release via inter-system redirection to EPS (see clause 4.2.6 and clause 4.11.1.3.2), taking into account UE capabilities. The PGW-C+SMF reports change of the RAT type if subscribed by PCF as specified in clause 4.11.1.2.1, or clause 4.11.1.3.2.6. When the UE is connected to EPS, either 6a or 6b is executed
 - 6a. In the case of 5GS to EPS handover, see clause 4.11.1.2.1, and in the case of inter-system redirection to EPS with N26 interface, see clause 4.11.1.3.2. In either case the UE initiates TAU procedure; or
 - 6b. In the case of inter-system redirection to EPS without N26 interface, see clause 4.11.2.2. If the UE supports Request Type flag "handover" for PDN connectivity request during the attach procedure as described in clause 5.3.2.1 of TS 23.401 [13] and has received the indication that interworking without N26 is supported, then the UE initiates Attach with PDN connectivity request with request type "handover".

In inter-system redirection, the UE uses the emergency indication in the RRC message as specified in clause 6.2.2 of TS 36.331 [16] and E-UTRAN provides the emergency indication to MME during Tracking Area Update or Attach procedure. For the handover procedure see clause 4.11.1.2.1, step 1.
7. After completion of the mobility procedure to EPS or as part of the 5GS to EPS handover procedure (see clause 4.11.1.2.1), the SMF/PGW re-initiates the setup of the dedicated bearer for IMS voice, mapping the 5G QoS to EPC QoS parameters. The PGW-C+SMF behaves as specified in clause 4.9.1.3.1. The PGW-C+SMF reports about Successful Resource Allocation and Access Network Information if subscribed by PCF.
8. The IMS voice session establishment is continued.

At least for the duration of the voice call in EPS the E-UTRAN is configured to not trigger any handover to 5GS.

[TS 24.501, clause 4.8.2.2]

See subclause 5.1.4.2 for coordination between 5GMM and EMM and subclause 6.1.4.1 for coordination between 5GSM and ESM.

[TS 24.501, clause 5.5.1.2.2]

If the UE supports S1 mode, the UE shall:

- set the S1 mode bit to "S1 mode supported" in the 5GMM capability IE of the REGISTRATION REQUEST message;
- include the S1 UE network capability IE in the REGISTRATION REQUEST message; and
- if the UE supports sending an ATTACH REQUEST message containing a PDN CONNECTIVITY REQUEST message with request type set to "handover" to transfer a PDU session from N1 mode to S1 mode, set the HO attach bit to "attach request message containing PDN connectivity request with request type set to handover to transfer PDU session from N1 mode to S1 mode supported" in the 5GMM capability IE of the REGISTRATION REQUEST message.

[TS 24.501, clause 5.5.1.2.4]

If the UE included S1 mode supported indication in the REGISTRATION REQUEST message, the AMF supporting interworking with EPS shall set the IWK N26 bit to either:

- a) "interworking without N26 interface not supported" if the AMF supports N26 interface ; or
- b) "interworking without N26 interface supported" if the AMF does not support N26 interface

in the 5GS network feature support IE in the REGISTRATION ACCEPT message.

The UE supporting S1 mode shall operate in the mode for interworking with EPS as follows:

- a) if the IWK N26 bit in the 5GS network feature support IE is set to "interworking without N26 interface not supported", the UE shall operate in single-registration mode;

- b) if the IWK N26 bit in the 5GS network feature support IE is set to "interworking without N26 interface supported" and the UE supports dual-registration mode, the UE may operate in dual-registration mode; or

NOTE 3: The registration mode used by the UE is implementation dependent.

- c) if the IWK N26 bit in the 5GS network feature support IE is set to "interworking without N26 interface supported" and the UE only supports single-registration mode, the UE shall operate in single-registration mode.

The UE shall treat the received interworking without N26 interface indicator for interworking with EPS as valid in the entire PLMN and its equivalent PLMN(s).

The network informs the UE about the support of specific features, such as IMS voice over PS session, emergency services or emergency services fallback, in the 5GS network feature support information element. In a UE with IMS voice over PS session capability, the IMS voice over PS session indicator, the Emergency services support indicator, and the Emergency services fallback indicator shall be provided to the upper layers. The upper layers take the IMS voice over PS session indicator into account when selecting the access domain for voice sessions or calls. When initiating an emergency call, the upper layers also take the IMS voice over PS session indicator, the Emergency services support indicator, and the Emergency services fallback indicator into account for the access domain selection.

[TS 24.501, clause 5.1.4.2]

At inter-system change from N1 mode to S1 mode when there is at least one active PDU session for which interworking with EPS is supported as specified in subclause 6.1.4.1, the UE shall enter substates EMM-REGISTERED.NORMAL-SERVICE and 5GMM-REGISTERED.NO-CELL-AVAILABLE and initiate a tracking area updating procedure (see 3GPP TS 24.301 [15]).

[TS 24.501, clause 6.1.4.1]

Upon inter-system change from N1 mode to S1 mode, the UE shall create the default EPS bearer context and the dedicated EPS bearer context(s) based on the parameters of the mapped EPS bearer contexts or the associations between QoS flow and mapped EPS bearer in the PDU session, if available. The EPS bearer identity assigned for the QoS flow of the default QoS rule becomes the EPS bearer identity of the default bearer in the corresponding PDN connection. If there is no EPS bearer identity assigned to the QoS flow of the default QoS rule, the UE shall release locally the PDU session. If there is no EPS bearer identity assigned to the QoS flow(s) which is not associated with the default QoS rule, the UE shall locally delete the QoS rules and the QoS flow level QoS parameters associated with the QoS flow(s). The UE uses the parameters from each PDU session for which interworking with EPS is supported to create corresponding default EPS bearer context and optionally dedicated EPS bearer context(s) as follows:

- a) the PDU session type of the PDU session shall be mapped to the PDN type of the default EPS bearer context as follows:
 - 1) the PDN type shall be set to "non-IP" if the PDU session type is "Ethernet" or "Unstructured";
 - 2) the PDN type shall be set to "IPv4" if the PDU session type is "IPv4";
 - 3) the PDN type shall be set to "IPv6" if the PDU session type is "IPv6"; and
 - 4) the PDN type shall be set to "IPv4v6" if the PDU session type is "IPv4v6";
- b) the PDU address of the PDU session shall be mapped to the PDN address of the default EPS bearer context as follows:
 - 1) the PDN address of the default EPS bearer context is set to the PDU address of the PDU session, if the PDU session type is "IPv4", "IPv6" or "IPv4v6"; and
 - 2) the PDN address of the default EPS bearer context is set to zero, if the PDU session type is "Ethernet" or "Unstructured";
- c) the DNN of the PDU session shall be mapped to the APN of the default EPS bearer context;
- d) the APN-AMBR and extended APN-AMBR received in the parameters of the default EPS bearer context of the mapped EPS bearer contexts shall be mapped to the APN-AMBR and extended APN-AMBR of the default EPS bearer context;

- e) for each PDU session in state PDU SESSION ACTIVE, PDU SESSION MODIFICATION PENDING or PDU SESSION INACTIVE PENDING the UE shall set the state of the mapped EPS bearer context(s) to BEARER CONTEXT ACTIVE; and
- f) for any other PDU session the UE shall set the state of the mapped EPS bearer context(s) to BEARER CONTEXT INACTIVE.

Additionally, for each mapped EPS bearer context or the association between QoS flow and mapped EPS bearer in the PDU session:

- a) the EPS bearer identity shall be set to the EPS bearer identity received in the mapped EPS bearer context, or the EPS bearer identity associated with the QoS flow;
- b) the EPS QoS parameters shall be set to the mapped EPS QoS parameters of the EPS bearer received in the mapped EPS bearer context, or the EPS QoS parameters associated with the QoS flow;
- c) the extended EPS QoS parameters shall be set to the mapped extended EPS QoS parameters of the EPS bearer received in the mapped EPS bearer context, or the extended EPS QoS parameters associated with the QoS flow; and
- d) the traffic flow template shall be set to the mapped traffic flow template of the EPS bearer received in the mapped EPS bearer context, or the stored traffic flow template associated with the QoS flow, if available.

After inter-system change from N1 mode to S1 mode, the UE shall associate the PDU session identity, the S-NSSAI, and the session-AMBR with the default EPS bearer context, and for each EPS bearer context mapped from one or more QoS flows, associate the QoS rule(s) for the QoS flow(s) and the QoS flow description(s) for the QoS flow(s) with the EPS bearer context.

After inter-system change from N1 mode to S1 mode, the UE and the SMF shall maintain the PDU session type of the PDU session until the PDN connection corresponding to the PDU session is released if the UE supports non-IP PDN type and the PDU session type is "Ethernet" or "Unstructured".

After inter-system change from N1 mode to S1 mode, the UE and the SMF shall maintain the always-on PDU session indication.

After inter-system change from N1 mode to S1 mode, the UE and the SMF shall maintain the maximum number of supported packet filters until the PDN connection corresponding to the PDU session is released.

[TS 38.331, clause 5.4.3.3]

The UE shall:

- 1> if T390 is running:
 - 2> stop timer T390 for all access categories;
 - 2> perform the actions as specified in 5.3.14.4;
- 1> if the *targetRAT-Type* is set to *eutra*:
 - 2> consider inter-RAT mobility as initiated towards E-UTRA;
 - 2> forward the *nas-SecurityParamFromNR* to the upper layers, if included;
- 1> access the target cell indicated in the inter-RAT message in accordance with the specifications of the target RAT.

[TS 38.331, clause 5.4.3.4]

Upon successfully completing the handover, at the source side the UE shall:

- 1> reset MAC;
- 1> stop all timers that are running;
- 1> release *ran-NotificationAreaInfo*, if stored;

- 1> release the AS security context including the K_{RRCEnc} key, the K_{RRCint} key, the K_{UPint} key and the K_{UPenc} key, if stored;
- 1> release all radio resources, including release of the RLC entity and the MAC configuration;
- 1> if the E-UTRA *RRCConnectionReconfiguration* message included in the received *MobilityFromNRCommand* does not include *fullConfig*:
 - 2> maintain source RAT configuration of PDCP and SDAP for applicable RBs which is used for target RAT RBs;
- 1> else:
 - 2> release the associated PDCP entity and SDAP entity for all established RBs;
- 1> indicate the release of the RRC connection to upper layers together with the release cause 'other'.

11.1.3.3 Test Description

11.1.3.3.1 Pre-test conditions

System Simulator:

- 2 cells
- NR Cell 1 as defined in TS 38.508-1 [4] Table 4.4.2-3. System information combination NR-6 as defined in TS 38.508-1 [4], sub-clause 4.4.3.1.2.
- E-UTRA Cell 1 as defined in TS 36.508 [7] Table 4.4.2-2. System information combination 31 as defined in TS 36.508 [7], sub-clause 4.4.3.1.1.
- N26 interface is configured.

UE:

None.

Preamble:

- With E-UTRA Cell 1 "Serving cell" and NR Cell 1 "Non-suitable "Off" cell" in accordance with TS 38.508-1 [4], Table 6.2.2.1-3, the UE is brought to state RRC_IDLE Connectivity (*E-UTRA/EPC*) in accordance with the procedure described in TS 38.508-1 [4], Table 4.5.2.2-1. 4G GUTI and eKSI are assigned and security context established.
- The UE is switched-off.
- With E-UTRA Cell 1 "Non-suitable "Off" cell" and NR Cell 1 "Serving cell" in accordance with TS 38.508-1 [4], Table 6.2.2.1-3, the UE is brought to state 1N-A, RRC_IDLE Connectivity (NR) with at least one Internet PDU session and one IMS PDU session on NR Cell 1, in accordance with the procedure described in TS 38.508-1 [4], Table 4.5.2.2-2. 5G-GUTI and ngKSI are assigned.

11.1.3.3.2 Test procedure sequence

Table 11.1.3.3.2-1: Main behaviour

| St | Procedure | Message Sequence | | TP | Verdict |
|-------|---|------------------|---|----|---------|
| | | U - S | Message | | |
| 1 | The SS configures:
- E-UTRA Cell 1 as "Suitable neighbour intra-frequency cell" in accordance with TS 38.508-1 [4], Table 6.2.2.1-3. | | | | |
| - | The following messages are to be observed on NR Cell 1 unless explicitly stated otherwise. | - | - | - | - |
| 2 | The SS transmits a <i>Paging</i> message. | <-- | NR RRC: <i>Paging</i> | - | - |
| 3 | The UE transmits an <i>RRCSetupRequest</i> message. | --> | NR RRC: <i>RRCSetupRequest</i> | - | - |
| 4-9 | Steps 3 to 8 of the NR RRC_CONNECTED procedure in TS 38.508-1 [4] Table 4.5.4.2-3 are executed to successfully complete the service request procedure. | - | - | - | - |
| - | EXCEPTION: Step 10a1 describe behaviour that depends on the UE implementation; the "lower case letter" identifies a step sequence that take place depending on the UE implementation | | | | |
| 10a1 | IF pc_IP_Ping = TRUE, THEN Check: Does the test result of generic test procedure 1a1-1b2 in TS 38.508-1 [4] subclause 4.9.1 indicate that the UE is capable of exchanging IP data? | | | 1 | P |
| 11 | Make the UE attempt an MTSI MO Speech Call. | - | - | - | - |
| 12-16 | Steps 1-5 of the MTSI MO speech call for 5GS procedure according to Annex A.9.1 of TS 34.229-5 [41] take place. | - | - | - | - |
| 17 | The SS transmits a <i>MobilityFromNRCommand</i> message which includes targetRAT-Type set to eutra according to 38.508-1 [4] Table 4.6.1-8. | <-- | NR RRC:
<i>MobilityFromNRCommand</i> | - | - |
| - | The following messages are to be observed on E-UTRA Cell 1 unless explicitly stated otherwise. | - | - | - | - |
| 18 | Check: Does the UE transmit an <i>RRCConnectionReconfigurationComplete</i> message to confirm the successful completion of handover? | --> | RRC:
<i>RRCConnectionReconfigurationComplete</i> | 1 | P |
| 19 | The UE transmits an <i>ULInformationTransfer</i> message on the cell specified in the test case. This message includes a TRACKING AREA UPDATE REQUEST message. | --> | RRC: <i>ULInformationTransfer</i>
NAS: TRACKING AREA UPDATE REQUEST | 1 | P |
| 20-23 | Steps 4a1-6 of the generic test procedure in TS 38.508-1 [4] Table 4.9.7.2.2-1 for N1 to S1 Inter mode change with condition 'connected without release' & 'mapped 5G security context' are performed to make sure successfully camped on E-UTRAN cell upon mobility from NR. | - | - | - | - |
| 24 | The SS configures a new RLC-UM data radio bearer with condition DRB (0,1), associated with the dedicated EPS bearer context. <i>RRCConnectionReconfiguration</i> message contains the ACTIVATE DEDICATED EPS BEARER CONTEXT REQUEST message. EPS bearer context #4 | <-- | RRC:
<i>RRCConnectionReconfiguration</i>
NAS: ACTIVATE DEDICATED EPS BEARER CONTEXT REQUEST | - | - |

| | | | | | |
|------|--|-----|--|---|---|
| | (QCI 1) according to TS 36.508 [7] Table 6.6.2-1: Reference dedicated EPS bearer contexts.
Reference dedicated EPS bearer contexts is to establish the dedicated EPS bearer context on IMS PDN. | | | | |
| - | EXCEPTION: In parallel to the events described in steps 25-28 below, the steps specified in table 11.1.3.3.2-2 will take place. | - | - | - | - |
| 25 | The UE transmits an <i>RRCConnectionReconfigurationComplete</i> message. | --> | RRC: <i>RRCConnectionReconfigurationComplete</i> | - | - |
| 26 | The UE transmits an <i>ULInformationTransfer</i> message including the ACTIVATE DEDICATED EPS BEARER CONTEXT ACCEPT message. | --> | RRC: <i>ULInformationTransfer</i>
NAS: ACTIVATE DEDICATED EPS BEARER CONTEXT ACCEPT | - | - |
| 27 | The SS waits 1 second for call duration. | - | - | - | - |
| | EXCEPTION: Step 28a1 describe behaviour that depends on the UE implementation; the "lower case letter" identifies a step sequence that take place depending on the UE implementation | | | | |
| 28a1 | IF <i>pc_IP_Ping</i> = TRUE, THEN Check: Does the test result of generic test procedure 1a1-1b2 in TS 38.508-1 [4] subclause 4.9.1 indicate that the UE is capable of exchanging IP data? | | | 1 | P |
| 29 | Release IMS Call as specified in the generic procedure in TS 34.229-1 [35] subclause C.32. | - | - | - | - |

Table 11.1.3.3.2-2: Parallel behaviour

| St | Procedure | Message Sequence | | TP | Verdict |
|---------|---|------------------|----------|----|---------|
| | | U - S | Message | | |
| - | EXCEPTION: Steps 1a1 to 1b7 describe behaviour that depends on the UE capability; the "lower case letter" identifies a step sequence that take place if a capability is supported | - | - | - | - |
| 1a1-a2 | The UE performs IMS re-registration on EUTRAN as per steps 1-2 as defined in TS 34.229-1 [35] C.46. | - | - | - | - |
| 1a3-1a6 | Steps 1-4 clause A.9.2 "EPS Fallback for Voice Call / steps after fallback / 5GS" of TS 34.229-5 [41] take place. | - | - | - | - |
| 1a7 | Check: Does the UE perform step 5 of the generic procedure "EPS Fallback for Voice Call / steps after fallback / 5GS" as defined in Appendix A.9.2 of TS 34.229-5 [41] | --> | SIP: ACK | 1 | P |

11.1.3.3.3 Specific message contents

Table 11.1.3.3.3-1: REGISTRATION REQUEST (preamble, Table 11.1.3.3.2-1)

| Derivation path: TS 38.508-1 [4] Table 4.7.1-6 | | | |
|--|----------------------------------|-------------------|-----------|
| Information Element | Value/remark | Comment | Condition |
| 5GMM capability | | | |
| S1 mode | '1'B | S1 mode supported | |
| S1 UE network capability | Present but contents not checked | | |

Table 11.1.3.3.3-2: REGISTRATION ACCEPT (preamble, Table 11.1.3.3.2-1)

| Derivation path: TS 38.508-1 [4] Table 4.7.1-7 | | | |
|--|--------------|--|-----------|
| Information Element | Value/remark | Comment | Condition |
| 5GS network feature support | | | |
| IMS- VoPS-3GPP | '1'B | IMS voice over PS session supported over 3GPP access | |
| IWK N26 | '0'B | Interworking without N26 interface not supported | |

Table 11.1.3.3.3-3: PDU SESSION ESTABLISHMENT ACCEPT (preamble for PDU Session for PS data, Table 11.1.3.3.2-1)

| Derivation path: TS 38.508-1 [4] Table 4.7.2-2, condition Interworking_with_EPS | | | |
|---|--|--|--|
|---|--|--|--|

Table 11.1.3.3.3-4: PDU SESSION ESTABLISHMENT ACCEPT (preamble for IMS PDU Session, Table 11.1.3.3.2-1)

| Derivation path: TS 38.508-1 [4] Table 4.7.2-2, condition Interworking_with_EPS, IMS_DNN_Requested | | | |
|--|--|--|--|
|--|--|--|--|

Table 11.1.3.3.3-5: Void**Table 11.1.3.3.3-6: MobilityFromNRCommand (step 17, Table 11.1.3.3.2-1)**

| Derivation path: TS 38.508-1 [4] Table 4.6.1-8 | | | |
|--|---------------------------------|---------|-----------|
| Information Element | Value/remark | Comment | Condition |
| MobilityFromNRCommand ::= SEQUENCE { | | | |
| rrc-TransactionIdentifier | RRC-TransactionIdentifier | | |
| criticalExtensions CHOICE { | | | |
| mobilityFromNRCommand SEQUENCE { | | | |
| targetRAT-Type | eutra | | |
| targetRAT-MessageContainer | RRCConnectionReconfiguration | | |
| nas-SecurityParamFromNR | 8 LSB of the downlink NAS COUNT | | |
| } | | | |
| } | | | |
| } | | | |

Table 11.1.3.3.3-7: RRCConnectionReconfiguration (Table 11.1.3.3.3-6)

| |
|--|
| Derivation path: TS 36.508-1 [4], Table 4.6.1-8 condition HO-TO-EUTRA(2,0) |
|--|

Table 11.1.3.3.3-8: MobilityControlInfo (Table 11.1.3.3.3-7)

| Derivation path: TS 36.508 [7], Table 4.6.5-1 | | | |
|---|--|---------|-------------|
| Information Element | Value/remark | Comment | Condition |
| MobilityControlInfo ::= SEQUENCE { | | | |
| targetPhysCellId | PhysicalCellIdentity of E-UTRA Cell 1 | | |
| carrierFreq SEQUENCE { | | | |
| dl-CarrierFreq | Same downlink EARFCN as used for E-UTRA Cell 1 | | |
| } | | | |
| carrierFreq | Not present | | Band > 64 |
| carrierBandwidth SEQUENCE { | | | |
| dl-Bandwidth | Downlink system bandwidth under test. | | |
| ul-Bandwidth | Uplink Bandwidth under test. | | FDD |
| ul-Bandwidth | Not present | | TDD |
| } | | | |
| additionalSpectrumEmission | 1 | | HO-to-EUTRA |
| carrierFreq-v9e0 SEQUENCE { | | | Band > 64 |
| dl-CarrierFreq-v9e0 | Same downlink EARFCN as used for E-UTRA Cell 1 | | |
| } | | | |
| } | | | |

| Condition | Explanation |
|-----------|--------------------------|
| FDD | FDD cell environment |
| TDD | TDD cell environment |
| Band > 64 | If band > 64 is selected |

Table 11.1.3.3.3-9: TRACKING AREA UPDATE REQUEST (step 19, Table 11.1.3.3.2-1)

| Derivation Path: TS 36.508 [7], Table 4.7.2-27, condition NR. | | | |
|--|---|--|-----------|
| Information Element | Value/remark | Comment | Condition |
| EPS update type | | | |
| EPS update type Value | '000'B | TA updating | |
| "Active" flag | '0'B | No bearer establishment requested | |
| NAS key set identifier | the eKSI indicating the 5G NAS security context value assigned at the initial registration when the UE entered N1 | | |
| Old GUTI | GUTI, mapped from the 5G-GUTI assigned at the initial registration when the UE entered N1 | | |
| Last visited registered TAI | The TAI to which the NR cell belonged to (the cell in which the UE was when in N1 before moving to S1). | | |
| UE radio capability information update needed | '1'B | UE radio capability information update needed | |
| EPS bearer context status | Present, Content not checked | EBI corresponding to active PDU Sessions need to be set to 1 | |
| Old GUTI type | "Native GUTI" | | |
| UE status | "UE is in 5GMM-REGISTERED state" | | |
| NOTE: The message shall be integrity protected using the 5GS security context available in the UE. | | | |

11.1.4 MO MMTEL voice call setup from NR RRC_CONNECTED / EPS Fallback with redirection / Single registration mode with N26 interface / E-UTRAN cell reselection using cell status barred / Success

11.1.4.1 Test Purpose (TP)

(1)

```

with { UE supporting both S1 mode and N1 mode and operating in single-registration mode, and, the
Network has indicated "interworking without N26 interface not supported", and, the UE in NR
RRC_CONNECTED state after having established connection with establishmentCause set to 'mo-Data',
and, the UE receiving and transmitting PS data }
ensure that {
  when { User initiates a MMTEL call, the MO IMS voice session establishment has been initiated and
the UE receives a RRCRelease message which includes redirectedCarrierInfo indicating redirection to
eutra, and, a higher ranked E-UTRA cell is found with cell status "barred" and a lower ranked E-UTRA
cell is found which is not "barred" }
  then { UE selects the not "barred" E-UTRA cell, performs a TAU procedure, and, while the UE
continues receiving and transmitting PS data the UE successfully completes the MO MMTEL call in EPS
}
}

```

11.1.4.2 Conformance requirements

References: The conformance requirements covered in the present test case are specified in: TS 23.502, clauses 4.13.6.1 and 4.11.1.3.2, TS 24.501, clauses 4.8.2.2, 5.1.4.2 and 6.1.4.1, TS 38.331, clauses 5.3.3.2, 5.3.3.3, 5.3.8.3 and 5.3.11; TS 36.304 clauses 5.2.4.4 and 5.3.1. Unless otherwise stated these are Rel-15 requirements.

[TS 23.502, clause 4.13.6.1]

Figure 4.13.6.1-1 describes the EPS fallback procedure for IMS voice.

When the UE is served by the 5G System, the UE has one or more ongoing PDU Sessions each including one or more QoS Flows. The serving PLMN AMF has sent an indication towards the UE during the Registration procedure that IMS voice over PS session is supported, see clause 5.16.3.10 in TS 23.501 [2] and the UE has registered in the IMS. If N26 is not supported, the serving PLMN AMF sends an indication towards the UE during the Registration procedure that interworking without N26 is supported, see clause 5.17.2.3.1 in TS 23.501 [2].

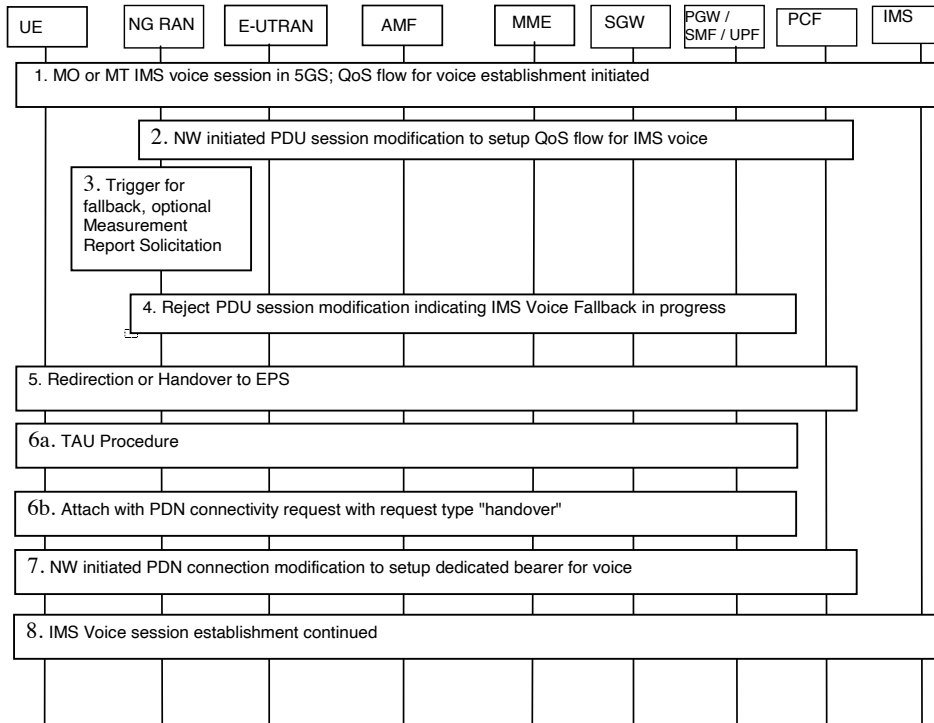

Figure 4.13.6.1-1: EPS Fallback for IMS voice

1. UE camps on NG-RAN in the 5GS and an MO or MT IMS voice session establishment has been initiated.
2. Network initiated PDU Session modification to setup QoS flow for voice reaches the NG-RAN (see N2 PDU Session Request in clause 4.3.3).
3. NG-RAN is configured to support EPS fallback for IMS voice and decides to trigger fallback to EPS, taking into account UE capabilities, indication from AMF that "Redirection for EPS fallback for voice is possible" (received as part of initial context setup as defined in TS 38.413 [10]), network configuration (e.g. N26 availability configuration) and radio conditions. If NG-RAN decides not to trigger fallback to EPS, then the procedure stops here and following steps are not executed.

NG-RAN may initiate measurement report solicitation from the UE including E-UTRAN as target.

NOTE 1: If AMF has indicated that "Redirection for EPS fallback for voice is not possible", then AN Release via inter-system redirection to EPS is not performed in step 5.

4. NG-RAN responds indicating rejection of the PDU Session modification to setup QoS flow for IMS voice received in step 2 by PDU Session Response message towards the PGW-C+SMF (or H-SMF+P-GW-C via V-SMF, in case of roaming scenario) via AMF with an indication that mobility due to fallback for IMS voice is ongoing. The PGW-C+SMF maintains the PCC rule(s) associated with the QoS Flow(s).

5. NG-RAN initiates either handover (see clause 4.11.1.2.1), or AN Release via inter-system redirection to EPS (see clause 4.2.6 and clause 4.11.1.3.2), taking into account UE capabilities. The PGW-C+SMF reports change of the RAT type if subscribed by PCF as specified in clause 4.11.1.2.1, or clause 4.11.1.3.2.6. When the UE is connected to EPS, either 6a or 6b is executed
 - 6a. In the case of 5GS to EPS handover, see clause 4.11.1.2.1, and in the case of inter-system redirection to EPS with N26 interface, see clause 4.11.1.3.2. In either case the UE initiates TAU procedure; or
 - 6b. In the case of inter-system redirection to EPS without N26 interface, see clause 4.11.2.2. If the UE supports Request Type flag "handover" for PDN connectivity request during the attach procedure as described in clause 5.3.2.1 of TS 23.401 [13] and has received the indication that interworking without N26 is supported, then the UE initiates Attach with PDN connectivity request with request type "handover".

In inter-system redirection, the UE uses the emergency indication in the RRC message as specified in clause 6.2.2 of TS 36.331 [16] and E-UTRAN provides the emergency indication to MME during Tracking Area Update or Attach procedure. For the handover procedure see clause 4.11.1.2.1, step 1.

7. After completion of the mobility procedure to EPS or as part of the 5GS to EPS handover procedure (see clause 4.11.1.2.1), the SMF/PGW re-initiates the setup of the dedicated bearer for IMS voice, mapping the 5G QoS to EPC QoS parameters. The PGW-C+SMF behaves as specified in clause 4.9.1.3.1. The PGW-C+SMF reports about Successful Resource Allocation and Access Network Information if subscribed by PCF.
8. The IMS voice session establishment is continued.

At least for the duration of the voice call in EPS the E-UTRAN is configured to not trigger any handover to 5GS.

[TS 23.502, clause 4.11.1.3.2]

Clause 4.11.1.3.2 covers the case of idle mode mobility from 5GC to EPC. UE performs Tracking Area Update procedure in E-UTRA/EPS when it moves from NG-RAN/5GS to E-UTRA/EPS coverage area.

The procedure involves a Tracking Area Update to EPC and setup of default EPS bearer and dedicated bearers in EPC in steps 1-11 and re-activation, if required.

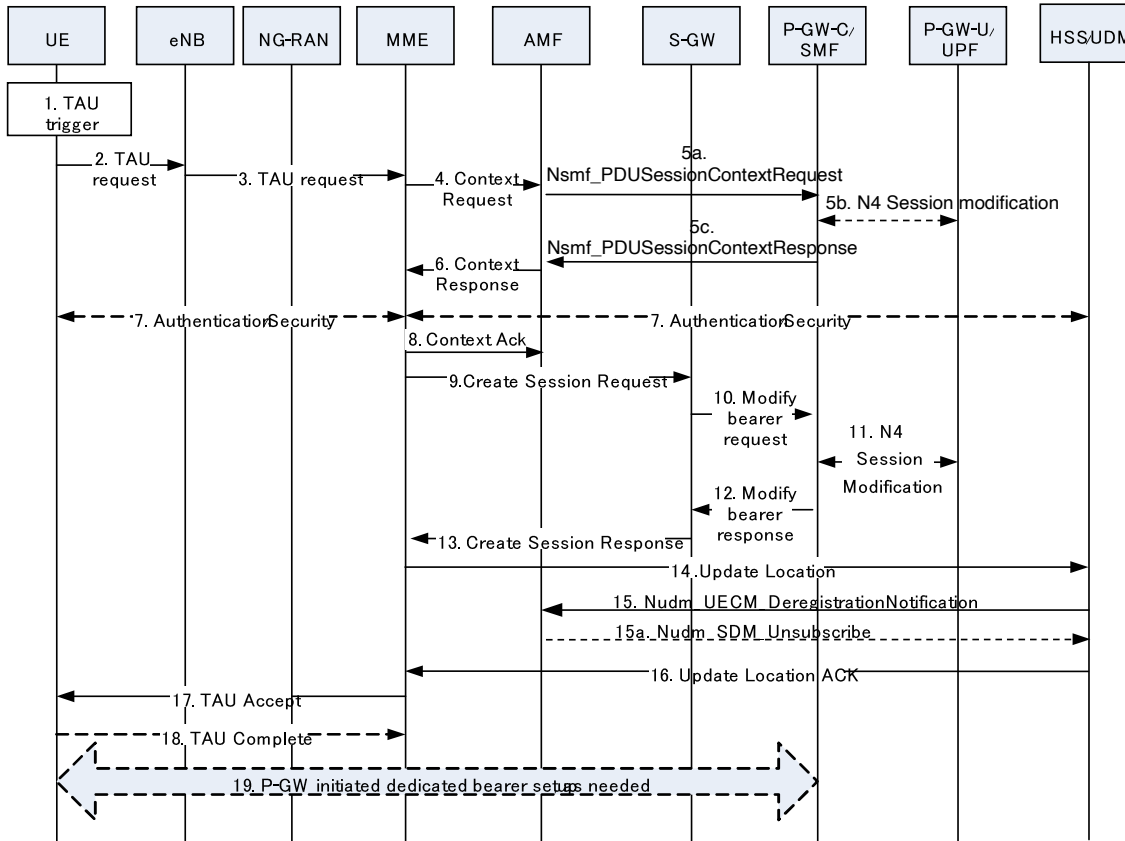

Figure 4.11.1.3.2-1: 5GS to EPS Idle mode mobility using N26 interface

The TAU procedure in TS 23.401 [13] is used with the following 5GS interaction:

1. Step 1 from clause 5.3.3.1 (Tracking Area Update procedure with Serving GW change) in TS 23.401 [13].
2. Step 2 from clause 5.3.3.1 (Tracking Area Update procedure with Serving GW change) in TS 23.401 [13] with the modification captured in clause 4.11.1.5.3.
- 3-4. Steps 3-4 from clause 5.3.3.1 (Tracking Area Update procedure with Serving GW change) in TS 23.401 [13].
- 5a. The AMF verifies the integrity of the TAU request message and requests the PGW-C+SMF to provide SM Context by using Nsmf_PDUSession_ContextRequest that also includes the mapped EPS Bearer Contexts. The AMF provides the target MME capability to SMF in the request to allow the SMF to determine whether to include EPS Bearer context for non-IP PDN Type or not. This step is performed with all the PGW-C+SMFs corresponding to PDU Sessions of the UE which are associated with 3GPP access and have EBI(s) allocated to them. In this step, if the AMF correctly validates the UE, then the AMF starts a timer.

NOTE 1: The AMF knows the MME capability to support non-IP PDN type or not through local configuration.

5b. For Non-roaming or roaming with local breakout scenario, if CN Tunnel Info is allocated by the PGW-U+UPF, the SMF sends N4 Session Modification Request to PGW-U+UPF to establish the tunnel for each EPS bearers, and PGW-U+UPF provides the PGW-U Tunnel Info for each EPS bearers to PGW-C+SMF.

NOTE2: In home routed roaming case, the CN Tunnel Info for each EPS bearer has been prepared by the PGW-C+SMF and provided to the V-SMF as specified in clause 4.11.1.4.1.

5c. SMF returns mapped EPS bearer contexts, which includes PGW-C control plane tunnel information of the PDN connection corresponding to the PDU session, EBI for each EPS bearer, PGW-U tunnel information for each

EPS bearer, and EPS QoS parameters for each EPS bearer. For PDU Sessions with PDU Session Type Ethernet or Unstructured, the SMF provides SM Context for non-IP PDN Type.

6. The AMF responds with a Context Response message carrying mapped MM context (including mapped security context), Return preferred and SM EPS UE Context (default and dedicated GBR bearers) to the MME. If the verification of the integrity protection fails, the AMF returns an appropriate error cause. Return preferred is an optional indication by the AMF of a preferred return of the UE to the 5GS PLMN at a later access change to a 5GS shared network. The AMF may start an implementation specific (guard) timer for the UE context.
- 7 - 14. Steps 6-12 from clause 5.3.3.1 (Tracking Area Update procedure with Serving GW change) in TS 23.401 [13] are performed with following addition and modification:

In the step 10, If the QoS Flow associated with the default QoS rule has an EPS Bearer ID assigned, the PGW-C+SMF keeps the PDU Session (PDN connection) and for the remaining QoS Flows that do not have EPS bearer ID(s) assigned, the PGW-C+SMF deletes the PCC rule(s) associated with those QoS Flows and informs the PCF about the removed PCC rule(s).

In the step 11, the PGW-C+SMF requests the PGW-U+UPF to establish the tunnel for each EPS bearer by providing SGW-U Tunnel Info, and PGW-U Tunnel Info if the PGW-U Tunnel Info is allocated by the PGW-C+SMF.

In step 10, the PGW-C+SMF may need to report some subscribed event to the PCF by performing an SMF initiated SM Policy Association Modification procedure as defined in clause 4.16.5.

Step 9a from clause 5.3.3.1 (Tracking Area Update procedure with Serving GW change) in TS 23.401 [13] with the modification captured in clause 4.11.1.5.3

- 15a. The HSS+UDM invokes Nudm_UECM_DeregistrationNotification to notify the AMF associated with 3GPP access with reason as 5GS to EPS Mobility. If the timer started in step 6 is not running, the old AMF removes the UE context. Otherwise, the AMF may remove UE context when the timer expires. The AMF request the release of the PDU Session which is associated with 3GPP access, not expected to be transferred to EPC, i.e. no EBI(s) allocated to them, and corresponding to the PGW-C+SMF which is not contacted by AMF for SM context at step 5a. The AMF requests the release of the SM context in the V-SMF only, for Home Routed PDU Session with EBIs allocated. The 5GC may also keep UE context to allow the use of native security parameters when UE moves back from EPS to 5GS later.

Registration associated with the non-3GPP access in the AMF is not removed (i.e. an AMF that was serving the UE over both 3GPP and non-3GPP accesses does not consider the UE as deregistered over non 3GPP access and will remain registered and subscribed to subscription data updates in UDM).

When the UE decides to deregister over non-3GPP access or the old AMF decides not to maintain a UE registration for non-3GPP access anymore, the old AMF then deregisters from UDM by sending a Nudm_UECM_Deregistration service operation, unsubscribes from Subscription Data updates by sending an Nudm_SDM_Unsubscribe service operation to UDM and releases all the AMF and AN resources related to the UE.

- 16 - 18. Steps 17-21 from clause 5.3.3.1 (Tracking Area Update procedure with Serving GW change) in TS 23.401 [13] with the following modification:

The MME may provide the eNodeB with a PLMN list in the Handover Restriction List taking into account the last used 5GS PLMN ID and the Return preferred indication. The Handover Restriction List contains a list of PLMN IDs as specified by TS 23.251 [35] clause 5.2a for eNodeB functions.

The MME may not release the signaling connection with the UE based on the indication received in the step 1 that the UE is moving from 5GC.

19. [conditional] Step 19 from clause 4.11.1.2.1 applies.

[TS 24.501, clause 4.8.2.2]

See subclause 5.1.4.2 for coordination between 5GMM and EMM and subclause 6.1.4.1 for coordination between 5GSM and ESM.

[TS 24.501, clause 5.1.4.2]

At inter-system change from N1 mode to S1 mode when there is at least one active PDU session for which interworking with EPS is supported as specified in subclause 6.1.4.1, the UE shall enter substates EMM-REGISTERED.NORMAL-SERVICE and 5GMM-REGISTERED.NO-CELL-AVAILABLE and initiate a tracking area updating procedure (see 3GPP TS 24.301 [15]).

[TS 24.501, clause 6.1.4.1]

Upon inter-system change from N1 mode to S1 mode, the UE shall create the default EPS bearer context and the dedicated EPS bearer context(s) based on the parameters of the mapped EPS bearer contexts or the associations between QoS flow and mapped EPS bearer in the PDU session, if available. The EPS bearer identity assigned for the QoS flow of the default QoS rule becomes the EPS bearer identity of the default bearer in the corresponding PDN connection. If there is no EPS bearer identity assigned to the QoS flow of the default QoS rule, the UE shall release locally the PDU session. If there is no EPS bearer identity assigned to the QoS flow(s) which is not associated with the default QoS rule, the UE shall locally delete the QoS rules and the QoS flow level QoS parameters associated with the QoS flow(s). The UE uses the parameters from each PDU session for which interworking with EPS is supported to create corresponding default EPS bearer context and optionally dedicated EPS bearer context(s) as follows:

- a) the PDU session type of the PDU session shall be mapped to the PDN type of the default EPS bearer context as follows:
 - 1) the PDN type shall be set to "non-IP" if the PDU session type is "Ethernet" or "Unstructured";
 - 2) the PDN type shall be set to "IPv4" if the PDU session type is "IPv4";
 - 3) the PDN type shall be set to "IPv6" if the PDU session type is "IPv6"; and
 - 4) the PDN type shall be set to "IPv4v6" if the PDU session type is "IPv4v6";
- b) the PDU address of the PDU session shall be mapped to the PDN address of the default EPS bearer context as follows:
 - 1) the PDN address of the default EPS bearer context is set to the PDU address of the PDU session, if the PDU session type is "IPv4", "IPv6" or "IPv4v6"; and
 - 2) the PDN address of the default EPS bearer context is set to zero, if the PDU session type is "Ethernet" or "Unstructured";
- c) the DNN of the PDU session shall be mapped to the APN of the default EPS bearer context;
- d) the APN-AMBR and extended APN-AMBR received in the parameters of the default EPS bearer context of the mapped EPS bearer contexts shall be mapped to the APN-AMBR and extended APN-AMBR of the default EPS bearer context;
- e) for each PDU session in state PDU SESSION ACTIVE, PDU SESSION MODIFICATION PENDING or PDU SESSION INACTIVE PENDING the UE shall set the state of the mapped EPS bearer context(s) to BEARER CONTEXT ACTIVE; and
- f) for any other PDU session the UE shall set the state of the mapped EPS bearer context(s) to BEARER CONTEXT INACTIVE.

Additionally, for each mapped EPS bearer context or the association between QoS flow and mapped EPS bearer in the PDU session:

- a) the EPS bearer identity shall be set to the EPS bearer identity received in the mapped EPS bearer context, or the EPS bearer identity associated with the QoS flow;
- b) the EPS QoS parameters shall be set to the mapped EPS QoS parameters of the EPS bearer received in the mapped EPS bearer context, or the EPS QoS parameters associated with the QoS flow;
- c) the extended EPS QoS parameters shall be set to the mapped extended EPS QoS parameters of the EPS bearer received in the mapped EPS bearer context, or the extended EPS QoS parameters associated with the QoS flow; and
- d) the traffic flow template shall be set to the mapped traffic flow template of the EPS bearer received in the mapped EPS bearer context, or the stored traffic flow template associated with the QoS flow, if available.

After inter-system change from N1 mode to S1 mode, the UE shall associate the PDU session identity, the S-NSSAI, and the session-AMBR with the default EPS bearer context, and for each EPS bearer context mapped from one or more QoS flows, associate the QoS rule(s) for the QoS flow(s) and the QoS flow description(s) for the QoS flow(s) with the EPS bearer context.

After inter-system change from N1 mode to S1 mode, the UE and the SMF shall maintain the PDU session type of the PDU session until the PDN connection corresponding to the PDU session is released if the UE supports non-IP PDN type and the PDU session type is "Ethernet" or "Unstructured".

After inter-system change from N1 mode to S1 mode, the UE and the SMF shall maintain the always-on PDU session indication.

After inter-system change from N1 mode to S1 mode, the UE and the SMF shall maintain the maximum number of supported packet filters until the PDN connection corresponding to the PDU session is released.

[TS 38.331, clause 5.3.3.2]

Upon initiation of the procedure, the UE shall:

- 1> if the upper layers provide an Access Category and one or more Access Identities upon requesting establishment of an RRC connection:
 - 2> perform the unified access control procedure as specified in 5.3.14 using the Access Category and Access Identities provided by upper layers;
 - 3> if the access attempt is barred, the procedure ends;
- 1> apply the default L1 parameter values as specified in corresponding physical layer specifications except for the parameters for which values are provided in *SIB1*;
- 1> apply the default MAC Cell Group configuration as specified in 9.2.2;
- 1> apply the CCCH configuration as specified in 9.1.1.2;
- 1> apply the *timeAlignmentTimerCommon* included in *SIB1*;
- 1> start timer T300;
- 1> initiate transmission of the *RRCSetupRequest* message in accordance with 5.3.3.3;

[TS 38.331, clause 5.3.3.3]

The UE shall set the contents of *RRCSetupRequest* message as follows:

- 1> set the *ue-Identity* as follows:
 - 2> if upper layers provide a 5G-S-TMSI:
 - 3> set the *ue-Identity* to *ng-5G-S-TMSI-Part1*;
 - 2> else:
 - 3> draw a 39-bit random value in the range $0..2^{39}-1$ and set the *ue-Identity* to this value;

NOTE 1: Upper layers provide the 5G-S-TMSI if the UE is registered in the TA of the current cell.

- 1> set the *establishmentCause* in accordance with the information received from upper layers;

The UE shall submit the *RRCSetupRequest* message to lower layers for transmission.

The UE shall continue cell re-selection related measurements as well as cell re-selection evaluation. If the conditions for cell re-selection are fulfilled, the UE shall perform cell re-selection as specified in 5.3.3.6.

[TS 38.331, clause 5.3.8.3]

The UE shall:

...

- 1> if the *RRCRelease* message includes *redirectedCarrierInfo* indicating redirection to *eutra*:
- 2> if *cnType* is included:
 - 3> after the cell selection, indicate the available CN Type(s) and the received *cnType* to upper layers;

NOTE 1: Handling the case if the E-UTRA cell selected after the redirection does not support the core network type specified by the *cnType*, is up to UE implementation.

- 2> if *voiceFallbackIndication* is included:
 - 3> consider the RRC connection release was for EPS fallback for IMS voice (see TS 23.502 [43]);
- 1> if the *RRCRelease* message includes the *cellReselectionPriorities*:
 - 2> store the cell reselection priority information provided by the *cellReselectionPriorities*;

[TS 38.331, clause 5.3.11]

The UE shall:

...

- 1> else:
 - 2> if T302 is running:
 - 3> stop timer T302;

3> perform the actions as specified in 5.3.14.4; [TS 36.304, clause 5.2.4.4]

For the highest ranked cell (including serving cell) according to cell reselection criteria specified in clause 5.2.4.6, for the best cell according to absolute priority reselection criteria specified in clause 5.2.4.5, the UE shall check if the access is restricted according to the rules in clause 5.3.1.

If that cell and other cells have to be excluded from the candidate list, as stated in clause 5.3.1, the UE shall not consider these as candidates for cell reselection. This limitation shall be removed when the highest ranked cell changes.

If the highest ranked cell or best cell according to absolute priority reselection rules is an intra-frequency or inter-frequency cell which is not suitable for a CN type due to being part of the "list of forbidden TAs for roaming" or belonging to a PLMN which is not indicated as being equivalent to the registered PLMN, the UE shall not consider this cell and other cells on the same frequency, as candidates for reselection for the CN type for a maximum of 300s. If the UE enters into state *any cell selection*, any limitation shall be removed. If the UE is redirected under E-UTRAN control to a frequency for which the timer is running, any limitation on that frequency shall be removed.

[TS 36.304, clause 5.3.11]

Cell status and cell reservations are indicated in the *SystemInformationBlockType1* message (or *SystemInformationBlockType1-BR* message or *SystemInformationBlockType1-NB* message) TS 36.331 [3] by means of the following fields:

- *cellBarred* (IE type: "barred" or "not barred")
 - This field indicates if the cell is barred for connectivity to EPC.
 - This field is ignored by the UEs supporting *crs-IntfMitig* while *crs-IntfMitigEnabled* is included in SIB1.
 - This field is ignored by the BL UEs or UEs in CE supporting *ce-CRS-IntfMitig* while *crs-IntfMitigNumPRBs* is included in SIB1-BR.
 - In case of multiple EPC PLMNs indicated in SIB1/SIB1-BR, this field is common for all EPC PLMNs

NOTE: For IAB node, it ignores the *cellBarred*, *cellReservedForOperatorUse* and *cellReservedForOtherUse* as defined in TS 36.331 [3].

...

The following description for handling of barred and reserved cells is per CN type. If the UE supports more than one CN type, the UE shall only exclude a cell as candidate for selection/reselection if it is excluded for both CN types.

NOTE: Fields *cellBarred-CRS* and *cellReservedForOperatorUse-CRS* are not indicated in *SystemInformationBlockType1-NB*

When cell status is indicated as "not barred" and "not reserved" for operator use,

- All UEs shall treat this cell as candidate during the cell selection and cell reselection procedures.

When cell status is indicated as "not barred" and "reserved" for operator use for any PLMN,

- UEs assigned to Access Class 11 or 15 operating in their HPLMN/EHPLMN shall treat this cell as candidate during the cell selection and reselection procedures if the field *cellReservedForOperatorUse* for that PLMN set to "reserved".
- UEs assigned to an Access Class in the range of 0 to 9, 12 to 14 shall behave as if the cell status is "barred" in case the cell is "reserved for operator use" for the registered PLMN or the selected PLMN.

NOTE: ACs 11, 15 are only valid for use in the HPLMN/ EHPLMN; ACs 12, 13, 14 are only valid for use in the home country TS 22.011 [4].

When cell status "barred" is indicated or to be treated as if the cell status is "barred",

- The UE is not permitted to select/reselect this cell, not even for emergency calls.
- The UE shall consider other cells for cell selection/reselection according to the following rule:

11.1.4.3 Test Description

11.1.4.3.1 Pre-test conditions

System Simulator:

- NR Cell 1 is configured according to TS 38.508-1 [4] Table 4.4.2-3 and is connected to 5GC.
- E-UTRA Cell 1 and E-UTRA Cell 3 are configured to TS 36.508 [7] Table 4.4.2-2 and are connected to EPC.
- System information on the NR Cell 1 in accordance with combination NR-6 in TS 38.508-1 [4] sub-clause 4.4.3.1.2, and, for the E-UTRA Cell 1 and Cell 3 in accordance with combination 31 as defined in TS 36.508 [7], subclause 4.4.3.1.1.
- N26 interface is configured.
- Power levels are constant and as defined in Table 11.1.4.3.1-1.

Table 11.1.4.3.1-1: Cell power levels

| | Parameter name | Unit | NR Cell 1 | E-UTRA Cell 1 | E-UTRA Cell 3 |
|----|---------------------|-----------|-----------|---------------|---------------|
| T0 | SS/PBCH SSS
EPRE | dBm/SCS | -88 | - | - |
| | RS EPRE | dBm/15kHz | - | -97 | -85 |

UE:

None.

Preamble:

- With E-UTRA Cell 1 "Serving cell" and NR Cell 1 "Non-suitable "Off" cell" in accordance with TS 38.508-1 [4], Table 6.2.2.1-3, the UE is brought to state RRC_IDLE Connectivity (*E-UTRA*) in accordance with the procedure described in TS 38.508-1 [4], Table 4.5.2.2-1. 4G GUTI and eKSI are assigned and security context established.
- The UE is switched-off.

- With E-UTRA Cell 1 "Non-suitable "Off" cell" and NR Cell 1 "Serving cell" in accordance with TS 38.508-1 [4], Table 6.2.2.1-3, the UE is brought to state 1N-A, RRC_IDLE Connectivity (NR) with at least one Internet PDU session and one IMS PDU session on NR Cell 1, in accordance with the procedure described in TS 38.508-1 [4], Table 4.5.2.2-2. 5G-GUTI and ngKSI are assigned.

11.1.4.3.2 Test procedure sequence

Table 11.1.4.3.2-1: Main behaviour

| St | Procedure | Message Sequence | | TP | Verdict |
|-------|--|------------------|---|----|---------|
| | | U - S | Message | | |
| 1 | Set the power levels according to "T0" as per Table 11.1.4.3.1-1 | - | - | - | - |
| - | The following messages are to be observed on NR Cell 1 unless explicitly stated otherwise. | - | - | - | - |
| 2 | The SS transmits a <i>Paging</i> message. | <-- | NR RRC: <i>Paging</i> | - | - |
| 3 | The UE transmits an <i>RRCSetupRequest</i> message. | --> | NR RRC: <i>RRCSetupRequest</i> | - | - |
| 4-9 | Steps 3 to 8 of the NR RRC_CONNECTED procedure in TS 38.508-1 [4] Table 4.5.4.2-3 are executed to successfully complete the service request procedure. | - | - | - | - |
| - | EXCEPTION: Steps 10a1 describe behaviour that depends on the UE implementation; the "lower case letter" identifies a step sequence that take place depending on the UE implementation | - | - | - | - |
| 10a1 | IF <i>pc_IP_Ping</i> = TRUE, THEN Check: Does the test result of generic test procedure 1a1-1b2 in TS 38.508-1 [4] subclause 4.9.1 indicate that the UE is capable of exchanging IP data? | - | - | 1 | P |
| 11 | Make the UE attempt an IMS speech call. | - | - | - | - |
| 12-16 | Steps 1-5 of generic procedure "EPS Fallback for Voice Call / steps before fallback / 5GS" as defined in Appendix A.9.1 of TS 34.229-5 [41] take place. | - | - | - | - |
| 17 | The SS transmits an <i>RRCRelease</i> message | <-- | NR RRC: <i>RRCRelease</i> | - | - |
| - | The following messages are to be observed on E-UTRA Cell 1 unless explicitly stated otherwise. | - | - | - | - |
| 18 | Generic test procedure in TS 38.508-1 [4] Table 4.9.7.2.2-1 Steps 1-6 is performed without ' <i>connected without release</i> ' on E-UTRAN cell upon mobility from NR. | - | - | - | - |
| 19 | The SS configures a new RLC-UM data radio bearer with condition DRB (0,1), associated with the dedicated EPS bearer context. <i>RRCConnectionReconfiguration</i> message contains the ACTIVATE DEDICATED EPS BEARER CONTEXT REQUEST message. EPS bearer context #4 (QCI 1) according to TS 36.508 [7] Table 6.6.2-1: Reference dedicated EPS bearer contexts. Reference dedicated EPS bearer contexts is to establish the dedicated EPS bearer context on IMS PDN. | <-- | RRC:
<i>RRCConnectionReconfiguration</i>
NAS: ACTIVATE DEDICATED EPS BEARER CONTEXT REQUEST | - | - |
| - | EXCEPTION: In parallel to the events described in steps 20-22 below, the steps specified in table 11.1.4.3.2-2 will take place. | - | - | - | - |
| 20 | The UE transmits an <i>RRCConnectionReconfigurationComplete</i> message. | --> | RRC:
<i>RRCConnectionReconfigurationComplete</i> | - | - |
| 21 | The UE transmits an <i>ULInformationTransfer</i> message including the ACTIVATE DEDICATED EPS BEARER CONTEXT ACCEPT message. | --> | RRC: <i>ULInformationTransfer</i>
NAS: ACTIVATE DEDICATED EPS BEARER CONTEXT ACCEPT | - | - |
| 22 | The SS waits 1 second for call duration. | - | - | - | - |
| - | EXCEPTION: Steps 23a1 describe behaviour that depends on the UE | - | - | - | - |

| | | | | | |
|------|--|---|---|---|---|
| | implementation; the "lower case letter" identifies a step sequence that take place depending on the UE implementation | | | | |
| 23a1 | IF pc_IP_Ping = TRUE, THEN Check: Does the test result of generic test procedure 1a1-1b2 in TS 38.508-1 [4] subclause 4.9.1 indicate that the UE is capable of exchanging IP data? | - | - | 1 | P |
| 24 | Release IMS Call as specified in the generic procedure in TS 34.229-1 [35] subclause C.32. | - | - | - | - |

Table 11.1.4.3.2-2: Parallel behaviour

| St | Procedure | Message Sequence | | TP | Verdict |
|---------|---|------------------|----------|----|---------|
| | | U - S | Message | | |
| - | EXCEPTION: Steps 1a1 to 1b7 describe behaviour that depends on the UE capability; the "lower case letter" identifies a step sequence that take place if a capability is supported | - | - | - | - |
| 1a1-1a2 | The UE performs IMS re-registration on EUTRAN as per steps 1-2 as defined in TS 34.229-1 [35] C.46. | - | - | - | - |
| 1a3-1a6 | Steps 1-4 of the generic procedure "EPS Fallback for Voice Call / steps after fallback / 5GS" as defined in Appendix A.9.2 of TS 34.229-5 [41] take place. | - | - | - | - |
| 1a7 | Check: Does the UE perform step 5 of the generic procedure "EPS Fallback for Voice Call / steps after fallback / 5GS" as defined in Appendix A.9.2 of TS 34.229-5 [41] | --> | SIP: ACK | 1 | P |

11.1.4.3.3 Specific message contents

Table 11.1.4.3.3-1: REGISTRATION REQUEST (preamble, Table 11.1.4.3.2-1)

| Derivation path: TS 38.508-1 [4] Table 4.7.1-6 | | | |
|--|----------------------------------|-------------------|-----------|
| Information Element | Value/remark | Comment | Condition |
| 5GMM capability | | | |
| S1 mode | '1'B | S1 mode supported | |
| S1 UE network capability | Present but contents not checked | | |

Table 11.1.4.3.3-2: REGISTRATION ACCEPT (preamble, Table 11.1.4.3.2-1)

| Derivation path: TS 38.508-1 [4] Table 4.7.1-7 | | | |
|--|--------------|--|-----------|
| Information Element | Value/remark | Comment | Condition |
| 5GS network feature support | | | |
| IMS- VoPS-3GPP | '1'B | IMS voice over PS session supported over 3GPP access | |
| IWK N26 | '0'B | Interworking without N26 interface not supported | |

Table 11.1.4.3.3-3: PDU SESSION ESTABLISHMENT ACCEPT (preamble for PDU Session for PS data, Table 11.1.4.3.2-1)

Derivation path: TS 38.508-1 [4] Table 4.7.2-2, condition Interworking_with_EPS

Table 11.1.4.3.3-4: PDU SESSION ESTABLISHMENT ACCEPT (preamble for IMS PDU Session, Table 11.1.4.3.2-1)

Derivation path: TS 38.508-1 [4] Table 4.7.2-2, condition Interworking_with_EPS, IMS_DNN_Requested

Table 11.1.4.3.3-5: RRCSetupRequest (step 3, Table 11.1.4.3.2-1)

| Derivation path: TS 38.508-1 [4] Table 4.6.1-4H | | | |
|---|--------------|---------|-----------|
| Information Element | Value/remark | Comment | Condition |
| RRCSetupRequest ::= SEQUENCE { | | | |
| rrcSetupRequest SEQUENCE { | | | |
| establishmentCause | mo-Data | | |
| } | | | |
| } | | | |

Table 11.1.4.3.3-6: RRCRelease message (step 17, table 11.1.4.3.2-1)

| Derivation path: TS 38.508-1 [4] Table 4.6.1-16 | | | |
|---|-----------------|---------|-----------|
| Information Element | Value/remark | Comment | Condition |
| RRCRelease ::= SEQUENCE { | | | |
| criticalExtensions CHOICE { | | | |
| rrcRelease SEQUENCE { | | | |
| redirectedCarrierInfo CHOICE { | | | |
| eutra SEQUENCE { | | | |
| eutraFrequency | Cell 1's EARFCN | | |
| } | | | |
| redirectedCarrierInfo CHOICE { | | | |
| eutra SEQUENCE { | | | |
| eutraFrequency | Cell 3's EARFCN | | |
| } | | | |
| } | | | |
| cellReselectionPriorities SEQUENCE { | | | |
| freqPriorityListEUTRA SEQUENCE (SIZE (1..maxFreq)) OF FreqPriorityEUTRA { | 2 entries | | |
| freqPriorityListEUTRA[1] SEQUENCE { | | entry 1 | |
| carrierFreq | Cell 3's EARFCN | | |
| cellReselectionPriority | 1 | | |
| cellReselectionSubPriority | Not present | | |
| } | | | |
| freqPriorityListEUTRA[2] SEQUENCE { | | | |
| carrierFreq | Cell 1's EARFCN | | |
| cellReselectionPriority | 0 | | |
| cellReselectionSubPriority | Not present | | |
| } | | | |
| } | | | |
| } | | | |
| } | | | |

Table 11.1.4.3.3-7: SystemInformationBlockType1 of E-UTRA Cell 3 (all steps, Table 11.1.4.3.2-1)

| Derivation Path: 36.508 [7] Table 4.4.3.2-3 | | | |
|---|--------------|---------|-----------|
| Information Element | Value/remark | Comment | Condition |
| SystemInformationBlockType1 ::= SEQUENCE { | | | |
| cellAccessRelatedInfo SEQUENCE { | | | |
| cellBarred | Barred | | |
| } | | | |
| } | | | |

11.1.5 MO MMTEL voice call setup from NR RRC_CONNECTED / EPS Fallback with redirection / Single registration mode without N26 interface / E-UTRAN cell reselection using cell status reservation / Success

11.1.5.1 Test Purpose (TP)

(1)

with {UE supporting both S1 mode and N1 mode and operating in single-registration mode, and, the Network has indicated "interworking without N26 interface supported", and, the UE is in in NR RRC_CONNECTED state after having established connection with establishmentCause set to 'mo-Data', and, the UE receiving and transmitting PS data}

ensure that {

when {User initiates a MMTEL call, the MO IMS voice session establishment has been initiated and the UE receives a RRCRelease message which includes redirectedCarrierInfo indicating redirection to eutra, and, a higher ranked E-UTRA cell is found with cell status "reserved for operator use" and a lower ranked E-UTRA cell is found which is not "reserved for operator use" both cells belonging to the UE's HPLMN}

then { UE selects the E-UTRA cell respecting the UE Access Class, performs an ATTACH or a TAU procedure, and, while the UE continues receiving and transmitting PS data the UE successfully completes the MO MMTEL call in EPS}

}

11.1.5.2 Conformance requirements

References: The conformance requirements covered in the current TC are specified in: TS23.502, clauses 4.11.2.2, 4.13.6.1; TS 24.501, clause 6.1.4.2; TS 38.331, clause 5.3.11. Unless otherwise stated these are Rel-15 requirements.

[TS 23.502, clause 4.11.2.2]

The following procedure is used by UEs in single-registration or dual registration mode on mobility from 5GS to EPS.

In the case of network sharing the UE selects the target PLMN ID according to clause 5.18.3 of TS 23.501 [2].

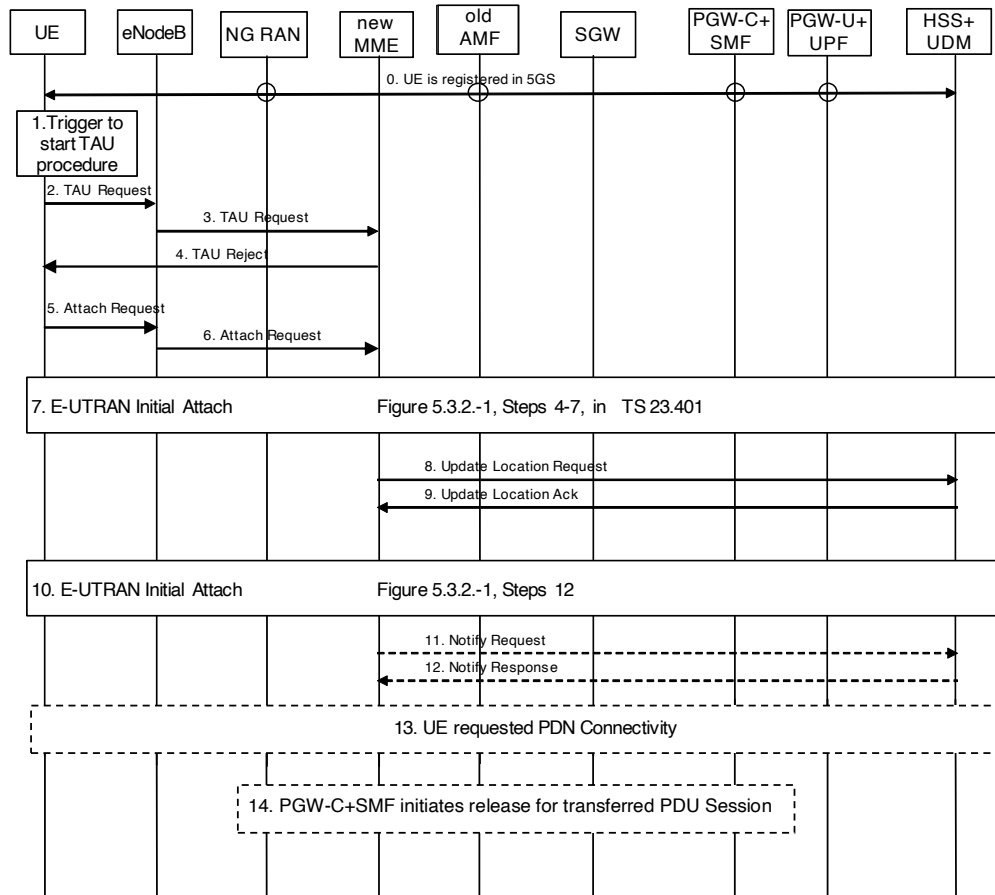

Figure 4.11.2.2-1: Mobility procedure from 5GS to EPS without N26 interface

The UE operating in single-registration mode can start the procedure from Step 1 or Step 5. The UE operating in dual-registration mode starts the procedure from Step 5.

NOTE 1: The network has indicated the "Interworking without N26" to the UE. To support IP address preservation, the UE in single-registration mode starts the procedure from Step 5. If the UE in single-registration mode starts the procedure from Step 1, the IP address preservation is not provided.

0. UE is registered in 5GS and established PDU sessions. The FQDN for the S5/S8 interface of the PGW-C+SMF is also stored in the UDM by the PGW-C+SMF during PDU Session setup in addition to what is specified in clause 4.3.2.2.1 and clause 4.3.2.2.2.

NOTE 2: At 5GS to EPS mobility, the MME use the FQDN for the S5/S8 interface of the PGW-C+SMF to find the PGW-C+SMF, and when UE moves back from EPS to 5GS, the AMF uses FQDN for the S5/S8 interface of the PGW-C+SMF to find the PGW-C+SMF.

1. Step 1 as in clause 5.3.3.1 (Tracking Area Update) in TS 23.401 [13].

2. Step 2 as in clause 5.3.3.1 (Tracking Area Update) in TS 23.401 [13] with the following modifications:

The UE shall provide a EPS-GUTI that is mapped from the 5G-GUTI following the mapping rules specified in TS 23.501 [2]. The UE indicates that it is moving from 5GC.

3. Step 3 as in clause 5.3.3.1 (Tracking Area Update) in TS 23.401 [13].

4. If the MME determined that the old node is an AMF based on UE's GUTI mapped from 5G-GUTI and the MME is configured to support 5GS-EPS interworking without N26 procedure, the MME sends a TAU Reject to the UE.
5. Step 1 as in clause 5.3.2.1 (E-UTRAN Initial Attach) in TS 23.401 [13] with the modifications captured in clause 4.11.2.4.1.
6. Step 2 as in clause 5.3.2.1 (E-UTRAN Initial Attach) in TS 23.401 [13].
7. Steps 4-7 as in clause 5.3.2.1 (E-UTRAN Initial Attach) in TS 23.401 [13], with the modifications captured in clause 4.11.2.4.1.
8. Step 8 as in clause 5.3.2.1 (E-UTRAN Initial Attach) in TS 23.401 [13], with the modifications captured in clause 4.11.2.4.1.
9. Step 11 as in clause 5.3.2.1 (E-UTRAN Initial Attach) in TS 23.401 [13], with the following modifications:

The subscription profile the MME receives from HSS+UDM includes per DNN/APN at most one PGW-C+SMF FQDN as described in clause 5.17.2.1 in TS 23.501 [2].
10. Steps 12-24 as in clause 5.3.2.1 (E-UTRAN Initial Attach) in TS 23.401 [13], with the modifications as described in clause 4.11.2.4.1.
11. Step 25 as in clause 5.3.2.1 (E-UTRAN Initial Attach) in TS 23.401 [13].
12. Step 26 as in clause 5.3.2.1 (E-UTRAN Initial Attach) in TS 23.401 [13].
13. If the UE has remaining PDU Sessions in 5GS which it wants to transfer to EPS and maintain the same IP address/prefix, the UE performs the UE requested PDN Connectivity Procedure as specified in TS 23.401 [13] clause 5.10.2 and sets the Request Type to "handover" in Step 1 of the procedure with modification captured in clause 4.11.2.4.2. UE provides an APN and the PDU Session ID corresponding to the PDU Session it wants to transfer to EPS. The UE provides the PDU Session ID in PCO as described in clause 4.11.1.1.

UEs in single-registration mode performs this step for each PDU Session immediately after completing the E-UTRAN Initial Attach procedure. UEs in dual-registration mode may perform this step any time after the completing of E-UTRAN Initial Attach procedure. Also, UEs in dual-registration mode may perform this step only for a subset of PDU Sessions.

The MME determines the PGW-C+SMF address for the Create Session Request based on the APN received from the UE and the subscription profile received from the HSS+UDM in Step 9 or when the HSS+UDM notifies the MME for the new PGW-C+SMF ID in the updated subscription profile.

The PGW-C+SMF uses the PDU Session ID to correlate the transferred PDN connection with the PDU Session in 5GC.

As a result of the procedure the PGW-U+UPF starts routing DL data packets to the Serving GW for the default and any dedicated EPS bearers established for this PDN connection.

14. The PGW-C+SMF initiates release of the PDU Session(s) in 5GS transferred to EPS as specified in clause 4.3.4.2 with the following clarification:
 - In step 2, the PGW-C+SMF shall not release IP address/prefix(es) allocated for the PDU Session.
 - If UP connection of the PDU Session is not active, step 3b is not executed, thus the steps triggered by step 3b are not executed;
 - If UP connection of the PDU Session is active, the SMF invokes the Namf_Communication_N1N2MessageTransfer service operation without including N1 SM container (PDU Session Release Command).

[TS 23.502, clause 4.13.6.1]

Figure 4.13.6.1-1 describes the EPS fallback procedure for IMS voice.

When the UE is served by the 5G System, the UE has one or more ongoing PDU Sessions each including one or more QoS Flows. The serving PLMN AMF has sent an indication towards the UE during the Registration procedure that IMS

voice over PS session is supported, see clause 5.16.3.10 in TS 23.501 [2] and the UE has registered in the IMS. If N26 is not supported, the serving PLMN AMF sends an indication towards the UE during the Registration procedure that interworking without N26 is supported, see clause 5.17.2.3.1 in TS 23.501 [2].

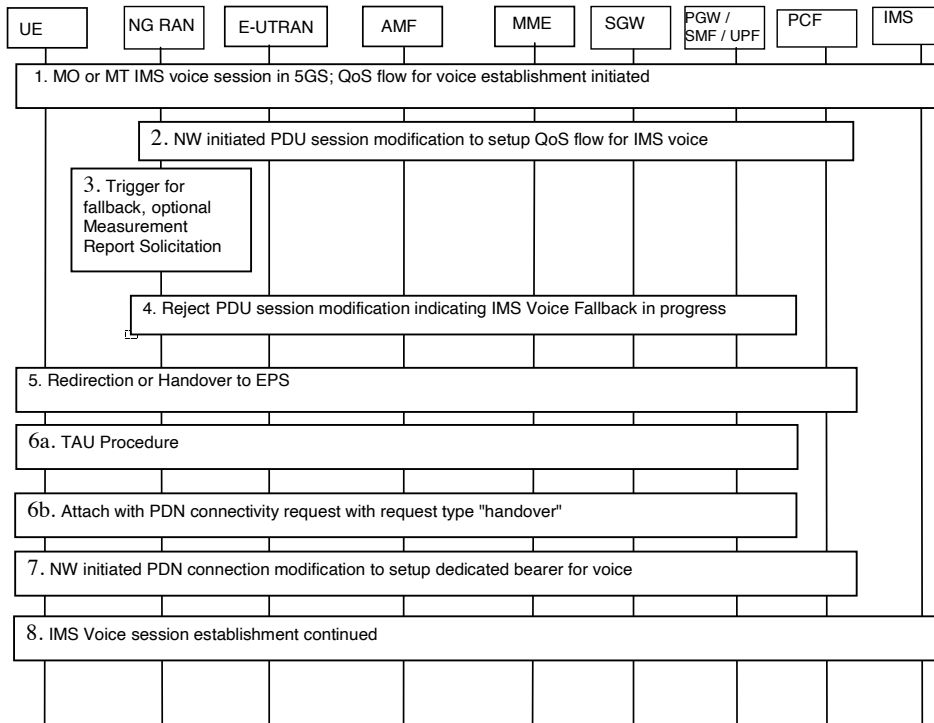

Figure 4.13.6.1-1: EPS Fallback for IMS voice

1. UE camps on NG-RAN in the 5GS and an MO or MT IMS voice session establishment has been initiated.
2. Network initiated PDU Session modification to setup QoS flow for voice reaches the NG-RAN (see N2 PDU Session Request in clause 4.3.3).
3. NG-RAN is configured to support EPS fallback for IMS voice and decides to trigger fallback to EPS, taking into account UE capabilities, indication from AMF that "Redirection for EPS fallback for voice is possible" (received as part of initial context setup as defined in TS 38.413 [10]), network configuration (e.g. N26 availability configuration) and radio conditions. If NG-RAN decides not to trigger fallback to EPS, then the procedure stops here and following steps are not executed.

NG-RAN may initiate measurement report solicitation from the UE including E-UTRAN as target.

NOTE 1: If AMF has indicated that "Redirection for EPS fallback for voice is not possible", then AN Release via inter-system redirection to EPS is not performed in step 5.

4. NG-RAN responds indicating rejection of the PDU Session modification to setup QoS flow for IMS voice received in step 2 by PDU Session Response message towards the PGW-C+SMF (or H-SMF+P-GW-C via V-SMF, in case of roaming scenario) via AMF with an indication that mobility due to fallback for IMS voice is ongoing. The PGW-C+SMF maintains the PCC rule(s) associated with the QoS Flow(s).
5. NG-RAN initiates either handover (see clause 4.11.1.2.1), or AN Release via inter-system redirection to EPS (see clause 4.2.6 and clause 4.11.1.3.2), taking into account UE capabilities. The PGW-C+SMF reports change of the RAT type if subscribed by PCF as specified in clause 4.11.1.2.1, or clause 4.11.1.3.2.6. When the UE is connected to EPS, either 6a or 6b is executed
- 6a. In the case of 5GS to EPS handover, see clause 4.11.1.2.1, and in the case of inter-system redirection to EPS with N26 interface, see clause 4.11.1.3.2. In either case the UE initiates TAU procedure; or

6b. In the case of inter-system redirection to EPS without N26 interface, see clause 4.11.2.2. If the UE supports Request Type flag "handover" for PDN connectivity request during the attach procedure as described in clause 5.3.2.1 of TS 23.401 [13] and has received the indication that interworking without N26 is supported, then the UE initiates Attach with PDN connectivity request with request type "handover".

In inter-system redirection, the UE uses the emergency indication in the RRC message as specified in clause 6.2.2 of TS 36.331 [16] and E-UTRAN provides the emergency indication to MME during Tracking Area Update or Attach procedure. For the handover procedure see clause 4.11.1.2.1, step 1.

7. After completion of the mobility procedure to EPS or as part of the 5GS to EPS handover procedure (see clause 4.11.1.2.1), the SMF/PGW re-initiates the setup of the dedicated bearer for IMS voice, mapping the 5G QoS to EPC QoS parameters. The PGW-C+SMF behaves as specified in clause 4.9.1.3.1. The PGW-C+SMF reports about Successful Resource Allocation and Access Network Information if subscribed by PCF.
8. The IMS voice session establishment is continued.

At least for the duration of the voice call in EPS the E-UTRAN is configured to not trigger any handover to 5GS.

[TS 24.501, clause 6.1.4.2]

When the network does not support N26 interface, the SMF does not provide the UE with the mapped EPS bearer context for a PDU session.

NOTE 1: Since the SMF does not provide the UE with the mapped EPS bearer context for a PDU session, the UE does not know whether interworking with EPS is supported for a PDU session before attempting to transfer the PDU session from N1 mode to S1 mode.

NOTE 2: It is up to UE implementation to decide which PDU session(s) to be attempted to transfer from N1 mode to S1 mode, e.g. based on UE policy or user preference.

Upon inter-system change from N1 mode to S1 mode in EMM-IDLE mode, the UE shall use the parameters from each PDU session which the UE intends to transfer to EPS to create the contents of a PDN CONNECTIVITY REQUEST message as follows:

- a) if the PDU session is an emergency PDU session, the request type shall be set to "handover of emergency bearer services". Otherwise the request type shall be set to "handover";
- b) the PDU session type of the PDU session shall be mapped to the PDN type of the default EPS bearer context as follows:
 - 1) the PDN type shall be set to "non-IP" if the PDU session type is "Ethernet" or "Unstructured";
 - 2) the PDN type shall be set to "IPv4" if the PDU session type is "IPv4";
 - 3) the PDN type shall be set to "IPv6" if the PDU session type is "IPv6"; and
 - 4) the PDN type shall be set to "IPv4v6" if the PDU session type is "IPv4v6";
- c) the DNN of the PDU session shall be mapped to the APN of the default EPS bearer context; and
- d) the PDU session ID parameter in the PCO IE shall be set to the PDU session identity of the PDU session.

After inter-system change from N1 mode to S1 mode, the UE shall associate the PDU session identity with the default EPS bearer context.

Upon successful completion of an EPS attach procedure after inter-system change from N1 mode to S1 mode (see 3GPP TS 24.301 [15]), the UE shall delete any UE derived QoS rules.

The UE shall locally release the PDU session(s) and QoS flow(s) associated with the 3GPP access which have not been transferred to EPS.

...

[TS 38.331, clause 5.3.11]

UE shall:

- 1> reset MAC;
- 1> if T302 is running:
 - 2> stop timer T302;
 - 2> perform the actions as specified in 5.3.14.4;
- 1> stop all timers that are running except T320 and T325;
- 1> discard the UE Inactive AS context;
- 1> set the variable *pendingRnaUpdate* to *false*, if that is set to *true*;
- 1> discard the K_{gNB} , the K_{RRcenc} key, the K_{RRcint} , the K_{UPint} key and the K_{UPenc} key, if any;
- 1> release all radio resources, including release of the RLC entity, the MAC configuration and the associated PDCP entity and SDAP for all established RBs;
- 1> indicate the release of the RRC connection to upper layers together with the release cause;
- 1> enter RRC_IDLE and perform cell selection as specified in TS 38.304 [20], except if going to RRC_IDLE was triggered by selecting an inter-RAT cell while T311 was running;
- 1> if going to RRC_IDLE was triggered by reception of the *RRCRelease* message including a *waitTime*:
 - 2> start timer T302 with the value set to the *waitTime*;
 - 2> inform the upper layer that access barring is applicable for all access categories except categories '0' and '2'.

11.1.5.3 Test description

11.1.5.3.1 Pre-test conditions

System Simulator:

- 3 cells
 - NR Cell 1 as defined in TS 38.508-1 [4] Table 4.4.2-3. System information combination NR-6 as defined in TS 38.508-1 [4], sub-clause 4.4.3.1.2.
 - E-UTRA Cell 1 as defined in TS 36.508 [7] Table 4.4.2-2. System information combination 31 as defined in TS 36.508 [7], sub-clause 4.4.3.1.1.
 - E-UTRA Cell 2 as defined in TS 36.508 [7] Table 4.4.2-2. System information combination 1 as defined in TS 36.508 [7], sub-clause 4.4.3.1.1. Cell 2 is set as "reserved for operator use" in SIB1.

UE:

- The UE fitted with a USIM with access class 0..9

Preamble:

- With E-UTRA Cell 1 "Serving cell", E-UTRA Cell 2 "Non-suitable "Off" cell" and NR Cell 1 "Non-suitable "Off" cell" in accordance with TS 38.508-1 [4], Table 6.2.2.1-3, the UE is brought to state RRC_IDLE Connectivity (*E-UTRA/EPC*) in accordance with the procedure described in TS 38.508-1 [4], Table 4.5.2.2-1. 4G GUTI and eKSI are assigned and security context established.
- The UE is switched-off.
- With E-UTRA Cell 1 "Non-suitable "Off" cell", E-UTRA Cell 2 "Non-suitable "Off" cell" and NR Cell 1 "Serving cell" in accordance with TS 38.508-1 [4], Table 6.2.2.1-3, the UE is brought to state 1N-A, RRC_IDLE Connectivity (NR), with one Internet PDU session and one IMS PDU session on NR Cell 1, in accordance with the procedure described in TS 38.508-1 [4], Table 4.5.2.2-2. 5G-GUTI and ngKSI are assigned.

11.1.5.3.2 Test procedure sequence

Table 11.1.5.3.2-0 illustrates the downlink power levels and other changing parameters to be applied for the cells at various time instants of the test execution. The configuration marked "T1" is applied at the point indicated in the Main behaviour description in Table 11.1.5.3.2-1.

Table 11.1.5.3.2-0: Time instances of cell power level and parameter changes

| | Parameter | Unit | E-UTRA
Cell 1 | E-UTRA
Cell 2 | Remark |
|-----------|--------------------------|-----------|------------------|------------------|--|
| T1 | Cell-specific
RS EPRE | dBm/15kHz | -85 | -73 | The power level values are assigned to satisfy $R_{\text{Cell 1}} < R_{\text{Cell 2}}$. |

Table 11.1.5.3.2-1: Main behaviour

| St | Procedure | Message Sequence | | TP | Verdict |
|-------|--|------------------|---|----|---------|
| | | U – S | Message | | |
| 0 | SS adjusts cell power levels of EUTRA Cell 1 and EUTRA Cell 2 according to row T1 of Table 11.1.5.3.2-0. | - | - | - | - |
| - | EXCEPTION: The following messages are to be observed on NR Cell 1 unless explicitly stated otherwise. | - | - | - | - |
| 1 | The SS transmits a <i>Paging</i> message. | <-- | NR RRC: <i>Paging</i> | - | - |
| 2 | The UE transmits an <i>RRCSetupRequest</i> message. | --> | NR RRC: <i>RRCSetupRequest</i> | - | - |
| 3-9a2 | Steps 3 to 9a2 of the NR RRC_CONNECTED procedure in TS 38.508-1 [4] Table 4.5.4.2-3 are executed to successfully complete the service request procedure. | - | - | - | - |
| 10 | Make the UE attempt an MTSI MO Speech Call. | - | - | - | - |
| 11 | The UE transmits an INVITE message. | - | - | - | - |
| 12 | Void | - | - | - | - |
| - | EXCEPTION: Steps 12a1 describe behaviour that depends on the UE implementation; the "lower case letter" identifies a step sequence that take place depending on the UE implementation. | - | - | - | - |
| 12a1 | IF pc_IP_Ping = TRUE, THEN Check: Does the test result of generic test procedure 1a1-1b2 in TS 38.508-1 [4] subclause 4.9.1 indicate that the UE is capable of exchanging IP data on DRB associated with the internet PDN? | - | - | 1 | P |
| 13 | The SS transmits an <i>RRCRelease</i> message. | <-- | NR RRC: <i>RRCRelease</i> | - | - |
| - | EXCEPTION: The following messages are to be observed on E-UTRA Cell 1 unless explicitly stated otherwise. | - | - | - | - |
| 14 | Check: Does the UE send an <i>RRCConnectionRequest</i> message on E-UTRA cell 1? | --> | RRC: <i>RRCConnectionRequest</i> | 1 | P |
| 15 | SS transmits an <i>RRCConnectionSetup</i> message. | <-- | RRC: <i>RRCConnectionSetup</i> | - | - |
| - | EXCEPTION: Steps 15a1 to 15b3 describe behaviour that depends on the UE implementation; the "lower case letter" identifies a step sequence that take place depending on the UE implementation. | - | - | - | - |
| 15a1 | If the UE tries to preserve the IP address of the PDN connection then check does the UE transmits an ATTACH REQUEST message? | --> | RRC: <i>RRCConnectionSetupComplete</i>
NAS: ATTACH REQUEST | 1 | P |
| 15b1 | Else check: does the UE transmit a TRACKING AREA UPDATE REQUEST message? | --> | RRC: <i>RRCConnectionSetupComplete</i>
NAS: TRACKING AREA UPDATE REQUEST | 1 | P |
| 15b2 | The SS transmits a TRACKING AREA UPDATE REJECT message to UE. | <-- | RRC: <i>DLInformationTransfer</i>
NAS: TRACKING AREA UPDATE REQUEST REJECT | - | - |
| 15b3 | The UE transmits an ATTACH REQUEST message. | --> | RRC: <i>ULInformationTransfer</i>
NAS: ATTACH REQUEST | - | - |
| 16-27 | Steps 5 to 16 of the generic test procedure for UE registration (TS 36.508 [2] Table 4.5.2.3-1). | - | - | - | - |
| - | EXCEPTION: In parallel to the events described in steps 27a1 to 36 the steps specified in Table 11.1.5.3.2-2 will take place to transfer internet PDU session to EPS. | - | - | - | - |
| - | EXCEPTION: In parallel to the events described in steps 28 to 37 the UE may perform IMS re-registration on EUTRAN as per | - | - | - | - |

| | | | | | |
|-------|--|-----|--|---|---|
| | steps 3-11 as defined in 34.229-1 [35] subclause C.46 using the message "REGISTER" with condition A31. | | | | |
| 28-32 | Steps 9a1-13 from the Generic Test Procedure for MTSI MO speech call establishment (TS 36.508 [2] table 4.5A.6.3-1) are performed. | - | - | - | - |
| 33-34 | Void | - | - | - | - |
| 35 | Check: Does the UE transmit an ACTIVATE DEDICATED EPS BEARER CONTEXT ACCEPT message? | --> | RRC: ULInformationTransfer
NAS:ACTIVATE DEDICATED EPS BEARER CONTEXT ACCEPT | 1 | P |
| 36 | The SS waits 1 second. | - | - | - | - |
| - | EXCEPTION: Steps 36a1 describe behaviour that depends on the UE implementation; the "lower case letter" identifies a step sequence that take place depending on the UE implementation | - | - | - | - |
| 36a1 | IF pc_IP_Ping = TRUE, THEN Check: Does the test result of generic test procedure 1a1-1b2 in TS 38.508-1 [4] subclause 4.9.1 indicate that the UE is capable of exchanging IP data on DRB associated with the internet PDN? | - | - | 1 | P |
| 37 | Release IMS Call as specified in the generic procedure in TS 34.229-1 [35] subclause C.32. | - | - | - | - |

Table 11.1.5.3.2-2: Parallel behaviour

| St | Procedure | Message Sequence | | TP | Verdict |
|----|---|------------------|--|----|---------|
| | | U - S | Message | | |
| 1 | Check: Does the UE transmit a PDN CONNECTIVITY REQUEST message to request an additional PDN. | --> | RRC: <i>ULInformationTransfer</i>
NAS: PDN CONNECTIVITY REQUEST | 1 | P |
| 2 | The SS configures a new data radio bearer, associated with the additional default EPS bearer context.
<i>RRCConnectionReconfiguration</i> message contains the ACTIVATE DEFAULT EPS BEARER CONTEXT REQUEST message. | <-- | RRC:
<i>RRCConnectionReconfiguration</i>
NAS:
ACTIVATE DEFAULT EPS BEARER CONTEXT REQUEST | | |
| 3 | The UE transmits an <i>RRCConnectionReconfigurationComplete</i> message to confirm the establishment of additional default bearer. | --> | RRC:
<i>RRCConnectionReconfigurationComplete</i> | | |
| - | EXCEPTION: In parallel to the event described in step 4 below, if initiated by the UE the generic procedure for IP address allocation in the U-plane specified in TS 36.508 subclause 4.5A.1 takes place performing IP address allocation in the U-plane. | - | - | | |
| 4 | The UE transmits an ACTIVATE DEFAULT EPS BEARER CONTEXT ACCEPT message. | --> | RRC: <i>ULInformationTransfer</i>
NAS: ACTIVATE DEFAULT EPS BEARER CONTEXT ACCEPT | | |

11.1.5.3.3 Specific message contents

Table 11.1.5.3.3-0: REGISTRATION ACCEPT (preamble; step 14, TS 38.508-1 [4], Table 4.5.2.2-2)

| Derivation path: TS 38.508-1 [4] Table 4.7.1-7 | | | |
|--|------------------------|---|-----------|
| Information Element | Value/remark | Comment | Condition |
| Extended protocol discriminator | '0111 1110'B | 5GS mobility management messages | |
| Security header type | '0000'B | Plain 5GS NAS message, not security protected | |
| Spare half octet | '0000'B | | |
| 5GS network feature support | '0100 0001 0000 0000'B | Interworking without N26 interface supported | |

Table 11.1.5.3.3-1: RRCRelease (step 13, table 11.1.5.3.2-1)

| Derivation path: TS 38.508-1 [4] Table Table 4.6.1-16 | | | |
|---|---------------------------|---------|-----------|
| Information Element | Value/Remark | Comment | Condition |
| RRCRelease ::= SEQUENCE { | | | |
| criticalExtensions CHOICE { | | | |
| rrcRelease SEQUENCE { | | | |
| redirectedCarrierInfo CHOICE { | | | |
| eutra SEQUENCE { | | | |
| eutraFrequency | Downlink EARFCN of cell 1 | | |
| cnType | epc | | |
| } | | | |
| } | | | |
| } | | | |
| } | | | |

Table 11.1.5.3.3-2: ATTACH REQUEST (step 15a1, table 11.1.5.3.2-1)

| Derivation Path: TS 36.508 [7], Table 4.7.2-4 | | | |
|---|---|---------|-----------|
| Information Element | Value/Remark | Comment | Condition |
| NAS key set identifier | KSI _{ASME} that was created when the UE last registered to EPC E-UTRA | | |
| Old GUTI | GUTI, mapped from the 5G-GUTI assigned at the initial registration when the UE entered N1 | | |
| Last visited registered TAI | The TAI the last visited E-UTRA Cell belonged to, if any. Not included if the UE does not have last stored EPC TAI. | | |
| Old GUTI type | "Native GUTI" | | |
| ESM message container | PDN CONNECTIVITY REQUEST message to active PDU sessions which the UE intends to transfer to EPS. | | |

Table 11.1.5.3.3-3: PDN CONNECTIVITY REQUEST (Table 11.1.5.3.3-2)

| Derivation Path: TS 36.508 [7], Table 4.7.3-20 | | | |
|--|---|--|-----------|
| Information Element | Value/remark | Comment | Condition |
| EPS bearer identity | 0 | No EPS bearer identity assigned, for coding see Table 9.11.4.8.1 in TS 24.501 [22] | |
| Procedure transaction identity | Any value from 1 to 254 | | |
| PDN connectivity request message identity | '1101 0000'B | PDN connectivity request | |
| Request type | '010'B | Handover | |
| PDN type | Any value between '001'B, '010'B, '011'B and '100'B | The allowed values are respectively IPv4, IPv6, IPv4v6 and "unused but interpreted as IPv6 by the network" | |
| Protocol configuration options | PDU session ID of IMS PDU session | | |

Table 11.1.5.3.3-4: TRACKING AREA UPDATE REQUEST (step 15b1, table 11.1.5.3.2-1)

| Derivation Path: TS 36.508 [7], Table 4.7.2-27, condition NR. | | | |
|---|---|--|-----------|
| Information Element | Value/Remark | Comment | Condition |
| "Active" flag | 0001 | Bearer Establishment requested | |
| EPS bearer context status | Present | EBI corresponding to active PDU Sessions need to be set to 1 | |
| NAS key set identifier | KSI _{ASME} that was created when the UE last registered to EPC E-UTRA | | |
| Old GUTI | GUTI, mapped from the 5G-GUTI assigned at the initial registration when the UE entered N1 | | |
| Last visited registered TAI | The TAI the last visited E-UTRA Cell belonged to, if any. Not included if the UE does not have last stored EPC TAI. | | |
| Old GUTI type | "Native GUTI" | | |
| UE status | "UE is in 5GMM-REGISTERED state" | | |

Table 11.1.5.3.3-5: TRACKING AREA UPDATE REJECT (step 15b2, table 11.1.5.3.2-1)

| Derivation Path: TS 36.508 [7], Table 4.7.2-26. | | | |
|---|--------------|---|-----------|
| Information Element | Value/Remark | Comment | Condition |
| EMM cause | '0000 1001'B | #9 "UE identity cannot be derived by the network" | |

Table 11.1.5.3.3-6: ATTACH REQUEST (step 15b3, table 11.1.5.3.2-1)

| Derivation Path: TS 36.508 [7], Table 4.7.2-4. | | | |
|--|----------------|---------|-----------|
| Information Element | Value/Remark | Comment | Condition |
| IMSI | IMSI of the UE | | |

Table 11.1.5.3.3-7: PDN CONNECTIVITY REQUEST (step 1, table 11.1.5.3.2-2)

| Derivation Path: TS 36.508 [7], Table 4.7.3-20 | | | |
|--|---|--|-----------|
| Information Element | Value/remark | Comment | Condition |
| EPS bearer identity | 0 | No EPS bearer identity assigned, for coding see Table 9.11.4.8.1 in TS 24.501 [22] | |
| Procedure transaction identity | Any value from 1 to 254 | | |
| PDN connectivity request message identity | '1101 0000'B | PDN connectivity request | |
| Request type | '010'B | Handover | |
| PDN type | Any value between '001'B, '010'B, '011'B and '100'B | The allowed values are respectively IPv4, IPv6, IPv4v6 and "unused but interpreted as IPv6 by the network" | |
| Protocol configuration options | PDU session ID of internet PDU session | | |

11.1.6 MT MMTEL voice call setup from NR RRC_IDLE / EPS Fallback with redirection / Single registration mode without N26 interface / Success

11.1.6.1 Test Purpose (TP)

(1)

```

with {UE supporting both S1 mode and N1 mode and operating in single-registration mode, and, the
Network has indicated "interworking without N26 interface supported", and, the UE is in NR RRC_IDLE
state}
ensure that {
  when { UE receives a Paging message with MT MMTEL voice call, the MT IMS voice session
establishment has been initiated and the UE receives a RRCRelease message which includes
redirectedCarrierInfo indicating redirection to eutra }
  then {{the UE selects the E-UTRA cell, performs an ATTACH or a TAU procedure, and, successfully
completes the MT MMTEL call setup in EPS }
}

```

11.1.6.2 Conformance requirements

References: The conformance requirements covered in the current TC are specified in: TS23.502, clauses 4.11.2.2, 4.13.6.1; TS 24.501, clauses 4.5.4.1, 4.8.2.3; TS 38.331, clause 5.3.11. Unless otherwise stated these are Rel-15 requirements.

[TS 23.502, clause 4.11.2.2]

The following procedure is used by UEs in single-registration or dual registration mode on mobility from 5GS to EPS.

In the case of network sharing the UE selects the target PLMN ID according to clause 5.18.3 of TS 23.501 [2].

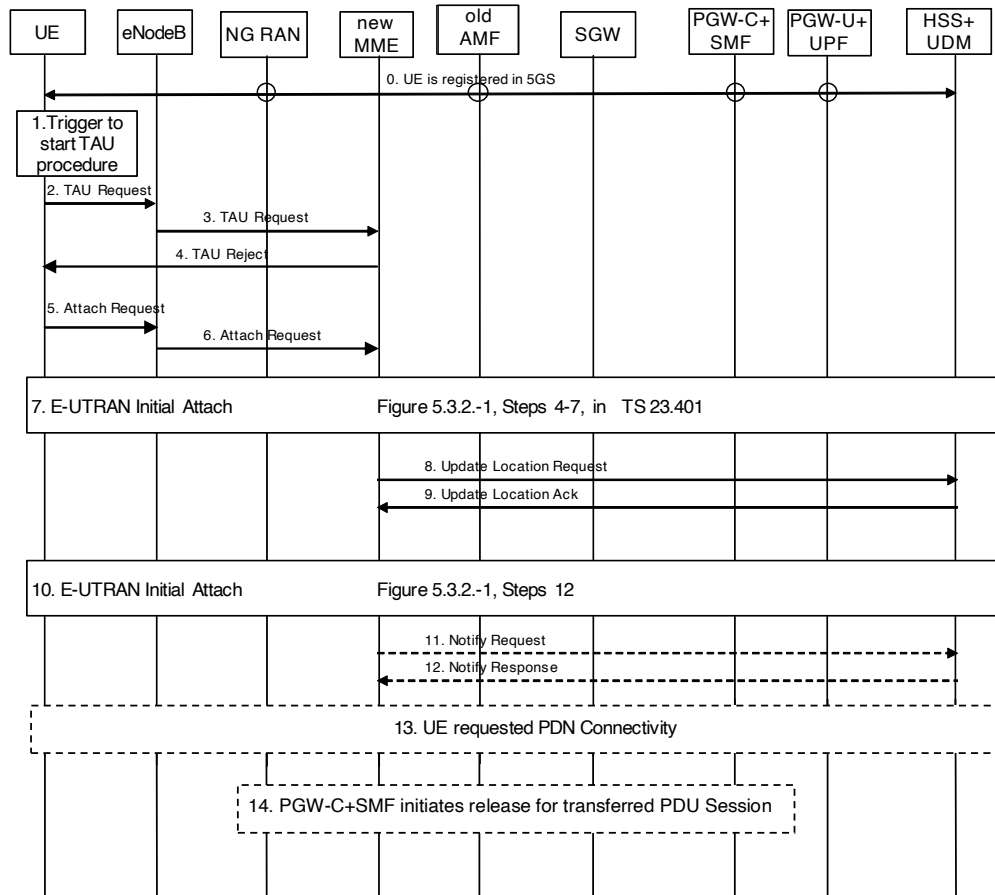

Figure 4.11.2.2-1: Mobility procedure from 5GS to EPS without N26 interface

The UE operating in single-registration mode can start the procedure from Step 1 or Step 5. The UE operating in dual-registration mode starts the procedure from Step 5.

NOTE 1: The network has indicated the "Interworking without N26" to the UE. To support IP address preservation, the UE in single-registration mode starts the procedure from Step 5. If the UE in single-registration mode starts the procedure from Step 1, the IP address preservation is not provided.

0. UE is registered in 5GS and established PDU sessions. The FQDN for the S5/S8 interface of the PGW-C+SMF is also stored in the UDM by the PGW-C+SMF during PDU Session setup in addition to what is specified in clause 4.3.2.2.1 and clause 4.3.2.2.2.

NOTE 2: At 5GS to EPS mobility, the MME use the FQDN for the S5/S8 interface of the PGW-C+SMF to find the PGW-C+SMF, and when UE moves back from EPS to 5GS, the AMF uses FQDN for the S5/S8 interface of the PGW-C+SMF to find the PGW-C+SMF.

1. Step 1 as in clause 5.3.3.1 (Tracking Area Update) in TS 23.401 [13].

2. Step 2 as in clause 5.3.3.1 (Tracking Area Update) in TS 23.401 [13] with the following modifications:

The UE shall provide a EPS-GUTI that is mapped from the 5G-GUTI following the mapping rules specified in TS 23.501 [2]. The UE indicates that it is moving from 5GC.

3. Step 3 as in clause 5.3.3.1 (Tracking Area Update) in TS 23.401 [13].

4. If the MME determined that the old node is an AMF based on UE's GUTI mapped from 5G-GUTI and the MME is configured to support 5GS-EPS interworking without N26 procedure, the MME sends a TAU Reject to the UE.
5. Step 1 as in clause 5.3.2.1 (E-UTRAN Initial Attach) in TS 23.401 [13] with the modifications captured in clause 4.11.2.4.1.
6. Step 2 as in clause 5.3.2.1 (E-UTRAN Initial Attach) in TS 23.401 [13].
7. Steps 4-7 as in clause 5.3.2.1 (E-UTRAN Initial Attach) in TS 23.401 [13], with the modifications captured in clause 4.11.2.4.1.
8. Step 8 as in clause 5.3.2.1 (E-UTRAN Initial Attach) in TS 23.401 [13], with the modifications captured in clause 4.11.2.4.1.
9. Step 11 as in clause 5.3.2.1 (E-UTRAN Initial Attach) in TS 23.401 [13], with the following modifications:
 The subscription profile the MME receives from HSS+UDM includes per DNN/APN at most one PGW-C+SMF FQDN as described in in clause 5.17.2.1 in TS 23.501 [2].
10. Steps 12-24 as in clause 5.3.2.1 (E-UTRAN Initial Attach) in TS 23.401 [13], with the modifications as described in clause 4.11.2.4.1.
11. Step 25 as in clause 5.3.2.1 (E-UTRAN Initial Attach) in TS 23.401 [13].
12. Step 26 as in clause 5.3.2.1 (E-UTRAN Initial Attach) in TS 23.401 [13].
13. If the UE has remaining PDU Sessions in 5GS which it wants to transfer to EPS and maintain the same IP address/prefix, the UE performs the UE requested PDN Connectivity Procedure as specified in TS 23.401 [13] clause 5.10.2 and sets the Request Type to "handover" in Step 1 of the procedure with modification captured in clause 4.11.2.4.2. UE provides an APN and the PDU Session ID corresponding to the PDU Session it wants to transfer to EPS. The UE provides the PDU Session ID in PCO as described in clause 4.11.1.1.

UEs in single-registration mode performs this step for each PDU Session immediately after completing the E-UTRAN Initial Attach procedure. UEs in dual-registration mode may perform this step any time after the completing of E-UTRAN Initial Attach procedure. Also, UEs in dual-registration mode may perform this step only for a subset of PDU Sessions.

The MME determines the PGW-C+SMF address for the Create Session Request based on the APN received from the UE and the subscription profile received from the HSS+UDM in Step 9 or when the HSS+UDM notifies the MME for the new PGW-C+SMF ID in the updated subscription profile.

The PGW-C+SMF uses the PDU Session ID to correlate the transferred PDN connection with the PDU Session in 5GC.

As a result of the procedure the PGW-U+UPF starts routing DL data packets to the Serving GW for the default and any dedicated EPS bearers established for this PDN connection.

14. The PGW-C+SMF initiates release of the PDU Session(s) in 5GS transferred to EPS as specified in clause 4.3.4.2 with the following clarification:
 - In step 2, the PGW-C+SMF shall not release IP address/prefix(es) allocated for the PDU Session.
 - If UP connection of the PDU Session is not active, step 3b is not executed, thus the steps triggered by step 3b are not executed;
 - If UP connection of the PDU Session is active, the SMF invokes the Namf_Communication_N1N2MessageTransfer service operation without including N1 SM container (PDU Session Release Command).

[TS 23.502, clause 4.13.6.1]

Figure 4.13.6.1-1 describes the EPS fallback procedure for IMS voice.

When the UE is served by the 5G System, the UE has one or more ongoing PDU Sessions each including one or more QoS Flows. The serving PLMN AMF has sent an indication towards the UE during the Registration procedure that IMS

voice over PS session is supported, see clause 5.16.3.10 in TS 23.501 [2] and the UE has registered in the IMS. If N26 is not supported, the serving PLMN AMF sends an indication towards the UE during the Registration procedure that interworking without N26 is supported, see clause 5.17.2.3.1 in TS 23.501 [2].

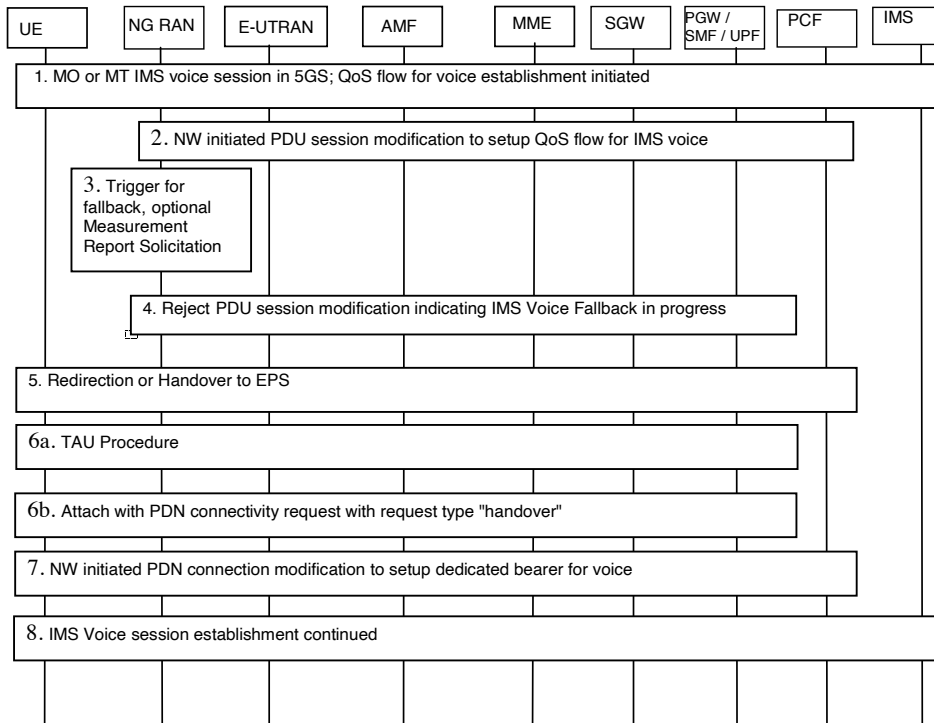

Figure 4.13.6.1-1: EPS Fallback for IMS voice

1. UE camps on NG-RAN in the 5GS and an MO or MT IMS voice session establishment has been initiated.
2. Network initiated PDU Session modification to setup QoS flow for voice reaches the NG-RAN (see N2 PDU Session Request in clause 4.3.3).
3. NG-RAN is configured to support EPS fallback for IMS voice and decides to trigger fallback to EPS, taking into account UE capabilities, indication from AMF that "Redirection for EPS fallback for voice is possible" (received as part of initial context setup as defined in TS 38.413 [10]), network configuration (e.g. N26 availability configuration) and radio conditions. If NG-RAN decides not to trigger fallback to EPS, then the procedure stops here and following steps are not executed.

NG-RAN may initiate measurement report solicitation from the UE including E-UTRAN as target.

NOTE 1: If AMF has indicated that "Redirection for EPS fallback for voice is not possible", then AN Release via inter-system redirection to EPS is not performed in step 5.

4. NG-RAN responds indicating rejection of the PDU Session modification to setup QoS flow for IMS voice received in step 2 by PDU Session Response message towards the PGW-C+SMF (or H-SMF+P-GW-C via V-SMF, in case of roaming scenario) via AMF with an indication that mobility due to fallback for IMS voice is ongoing. The PGW-C+SMF maintains the PCC rule(s) associated with the QoS Flow(s).
5. NG-RAN initiates either handover (see clause 4.11.1.6.1), or AN Release via inter-system redirection to EPS (see clause 4.2.6 and clause 4.11.1.3.2), taking into account UE capabilities. The PGW-C+SMF reports change of the RAT type if subscribed by PCF as specified in clause 4.11.1.6.1, or clause 4.11.1.3.2.6. When the UE is connected to EPS, either 6a or 6b is executed
- 6a. In the case of 5GS to EPS handover, see clause 4.11.1.6.1, and in the case of inter-system redirection to EPS with N26 interface, see clause 4.11.1.3.2. In either case the UE initiates TAU procedure; or

6b. In the case of inter-system redirection to EPS without N26 interface, see clause 4.11.2.2. If the UE supports Request Type flag "handover" for PDN connectivity request during the attach procedure as described in clause 5.3.2.1 of TS 23.401 [13] and has received the indication that interworking without N26 is supported, then the UE initiates Attach with PDN connectivity request with request type "handover".

In inter-system redirection, the UE uses the emergency indication in the RRC message as specified in clause 6.2.2 of TS 36.331 [16] and E-UTRAN provides the emergency indication to MME during Tracking Area Update or Attach procedure. For the handover procedure see clause 4.11.1.6.1, step 1.

7. After completion of the mobility procedure to EPS or as part of the 5GS to EPS handover procedure (see clause 4.11.1.6.1), the SMF/PGW re-initiates the setup of the dedicated bearer for IMS voice, mapping the 5G QoS to EPC QoS parameters. The PGW-C+SMF behaves as specified in clause 4.9.1.3.1. The PGW-C+SMF reports about Successful Resource Allocation and Access Network Information if subscribed by PCF.
8. The IMS voice session establishment is continued.

At least for the duration of the voice call in EPS the E-UTRAN is configured to not trigger any handover to 5GS.

[TS 24.501, clause 4.5.4.1]

When the UE is in 5GMM-IDLE mode, upon receiving a request from the upper layers for an access attempt, the NAS shall categorize the access attempt into access identities and an access category following subclause 4.5.2, table 4.5.2.1 and table 4.5.2.2, and subclause 4.5.3, and provide the applicable access identities and the access category to the lower layers for the purpose of access control checking. In this request to the lower layer the NAS can also provide to the lower layer the RRC establishment cause determined as specified in subclause 4.5.6 of this specification.

NOTE 1: The access barring check is performed by the lower layers.

NOTE 2: As an implementation option, the NAS can provide the RRC establishment cause to the lower layers after being informed by the lower layers that the access attempt is allowed.

If the UE has uplink user data pending for one or more PDU sessions when it builds a REGISTRATION REQUEST or SERVICE REQUEST message as initial NAS message, the UE shall indicate the respective PDU sessions in the Uplink data status IE as specified in subclause 5.5.1.3.2 and 5.6.1.2, regardless of the access category for which the access barring check is performed.

NOTE 3: The UE indicates pending user data for all the respective PDU sessions, even if barring timers are running for some of the corresponding access categories.

If the lower layers indicate that the access attempt is allowed, the NAS shall initiate the procedure to send the initial NAS message for the access attempt.

If the lower layers indicate that the access attempt is barred, the NAS shall not initiate the procedure to send the initial NAS message for the access attempt. Additionally:

- a) if the event which triggered the access attempt was an MO-MMTEL-voice-call-started indication or an MO-MMTEL-video-call-started indication:
 - 1) if the UE is operating in the single-registration mode and the UE's usage setting is "voice centric", the UE may attempt to select an E-UTRA cell connected to EPC. If the UE finds a suitable E-UTRA cell connected to EPC, it then proceeds with the appropriate EMM specific procedures and, if necessary, ESM procedures to make a PDN connection providing access to IMS available; see subclause 4.8.2 and 3GPP TS 24.301 [15];
 - 2) if the UE is operating in the dual-registration mode, the UE may proceed in S1 mode with the appropriate EMM specific procedures and ESM procedures to make a PDN connection providing access to IMS available; see subclause 4.8.3 and 3GPP TS 24.301 [15];
 - 3) otherwise, the NAS shall notify the upper layers that the access attempt is barred. In this case, upon receiving an indication from the lower layers that the barring is alleviated for the access category with which the access attempt was associated, the NAS shall notify the upper layers that the barring is alleviated for the access category and may initiate the procedure to send the initial NAS message, if still needed; and
- b) if the event which triggered the access attempt was an MO-SMSoIP-attempt-started indication:
 - 1) if the UE is operating in the single-registration mode, the UE may attempt to select an E-UTRA cell connected to EPC. If the UE finds a suitable E-UTRA cell connected to EPC, it then proceeds with the

appropriate EMM specific procedures and, if necessary, ESM procedures to make a PDN connection providing access to IMS available; see subclause 4.8.2 and 3GPP TS 24.301 [15];

- 2) if the UE is operating in the dual-registration mode, the UE may proceed in S1 mode with the appropriate EMM specific procedures and ESM procedures to make a PDN connection providing access to IMS available; see subclause 4.8.3 and 3GPP TS 24.301 [15];
- 3) otherwise, the NAS layer shall notify the upper layers that the access attempt is barred. In this case, upon receiving an indication from the lower layers that the barring is alleviated for the access category with which the access attempt was associated, the NAS shall notify the upper layers that the barring is alleviated for the access category and may initiate the procedure to send the initial NAS message, if still needed.

NOTE 4: Barring timers, on a per access category basis, are run by the lower layers. At expiry of barring timers, the indication of alleviation of access barring is indicated to the NAS on a per access category basis.

[TS 24.501, clause 4.8.2.3]

At inter-system change from N1 mode to S1 mode in EMM-IDLE mode when: (PDU SEESION ACTIVE)

- a) the UE supports non-IP PDN type and at least one PDU session is active; or
- b) the UE does not support non-IP PDN type and at least one PDU session of IPv4, IPv6 or IPv4v6 PDU session type is active,

the UE shall proceed as follows:

- a) if the UE supports sending an ATTACH REQUEST message containing a PDN CONNECTIVITY REQUEST message with request type set to "handover" to transfer a PDU session from N1 mode to S1 mode and the UE has received an "interworking without N26 interface supported" indication from the network, the UE shall:
 - 1) enter substates EMM-DEREGISTERED.NORMAL-SERVICE and 5GMM-REGISTERED.NO-CELL-AVAILABLE;
 - 2) map the PDU session(s) which the UE intends to transfer to EPS to the default EPS bearer context of the corresponding PDN connection(s) as specified in subclause 6.1.4.2; and
 - 3) initiate an EPS attach procedure and include a PDN CONNECTIVITY REQUEST message with request type set to "handover" in the ATTACH REQUEST message to activate a default EPS bearer context for one of the active PDU sessions which the UE intends to transfer to EPS.

After successful completion of the EPS attach procedure, the UE shall reset the registration attempt counter and the attach attempt counter (see 3GPP TS 24.301 [15]) and attempt to activate each of the other default EPS bearer contexts, if any, by initiating a stand-alone PDN connectivity procedure with request type set to "handover" in the PDN CONNECTIVITY REQUEST message; and

- b) otherwise, enter substates EMM-REGISTERED.NORMAL-SERVICE and 5GMM-REGISTERED.NO-CELL-AVAILABLE and initiate a tracking area update procedure (see 3GPP TS 24.301 [15]).

At inter-system change from N1 mode to S1 mode in EMM-IDLE mode when: (NO PDU SESSION)

- a) the UE supports non-IP PDN type and no PDU session is active; or
- b) the UE does not support non-IP PDN type and no PDU session of IPv4, IPv6 or IPv4v6 PDU session type is active,

the UE shall enter substates EMM-DEREGISTERED.NORMAL-SERVICE and 5GMM-DEREGISTERED.NO-CELL-AVAILABLE, and initiate an attach procedure.

At inter-system change from S1 mode to N1 mode in 5GMM-IDLE mode, the UE shall:

- a) enter substate 5GMM-REGISTERED.NORMAL-SERVICE and substate EMM-REGISTERED.NO-CELL-AVAILABLE;
- b) map the default EPS bearer context(s) of the PDN connection(s) which the UE intends to transfer to 5GS, if any, to the corresponding PDU session(s) as specified in subclause 6.1.4.2; and

- c) initiate the registration procedure for mobility and periodic registration update indicating "mobility registration updating" in the 5GS registration type IE of the REGISTRATION REQUEST message (see subclause 5.5.1.3).

After having successfully registered in N1 mode the UE shall reset the registration attempt counter and the attach attempt counter (see 3GPP TS 24.301 [15]) and:

- a) if the UE supports the PDU session establishment procedure with request type set to "existing PDU session" to transfer a PDN connection from S1 mode to N1 mode and the UE has received an "interworking without N26 interface supported" indication from the network, attempt to transfer the PDN connection(s) which the UE intends to transfer to 5GS, if any, from S1 mode to N1 mode by initiating the PDU session establishment procedure with request type set to "existing PDU session"; and
- b) otherwise, establish PDU session(s) corresponding to the PDN connection(s) which the UE intends to transfer to 5GS, if any, by initiating the PDU session establishment procedure with request type set to "initial request".

See subclause 5.1.4.3 for coordination between 5GMM and EMM and subclause 6.1.4.2 for coordination between 5GSM and ESM.

[TS 38.331, clause 5.3.11]

UE shall:

- 1> reset MAC;
- 1> if T302 is running:
 - 2> stop timer T302;
 - 2> perform the actions as specified in 5.3.14.4;
- 1> stop all timers that are running except T320 and T325;
- 1> discard the UE Inactive AS context;
- 1> set the variable *pendingRnaUpdate* to *false*, if that is set to *true*;
- 1> discard the K_{gNB} , the K_{RRCEnc} key, the K_{RRCint} , the K_{UPint} key and the K_{UPenc} key, if any;
- 1> release all radio resources, including release of the RLC entity, the MAC configuration and the associated PDCP entity and SDAP for all established RBs;
- 1> indicate the release of the RRC connection to upper layers together with the release cause;
- 1> enter RRC_IDLE and perform cell selection as specified in TS 38.304 [20], except if going to RRC_IDLE was triggered by selecting an inter-RAT cell while T311 was running;
- 1> if going to RRC_IDLE was triggered by reception of the *RRCRelease* message including a *waitTime*:
 - 2> start timer T302 with the value set to the *waitTime*;
 - 2> inform the upper layer that access barring is applicable for all access categories except categories '0' and '2'.

11.1.6.3 Test description

11.1.6.3.1 Pre-test conditions

System Simulator:

- 2 cells
 - NR Cell 1 as defined in TS 38.508-1 [4] Table 4.4.2-3. System information combination NR-6 as defined in TS 38.508-1 [4], sub-clause 4.4.3.1.2.
 - E-UTRA Cell 1 as defined in TS 36.508 [7] Table 4.4.2-2. System information combination 31 as defined in TS 36.508 [7], sub-clause 4.4.3.1.1.

UE:

None.

Preamble:

- With E-UTRA Cell 1 "Serving cell" and NR Cell 1 "Non-suitable "Off" cell" in accordance with TS 38.508-1 [4], Table 6.2.2.1-3, the UE is brought to state RRC_IDLE Connectivity (*E-UTRA/EPC*) in accordance with the procedure described in TS 38.508-1 [4], Table 4.5.2.2-1. 4G GUTI and eKSI are assigned and security context established.
- The UE is switched-off.
- With E-UTRA Cell 1 "Non-suitable "Off" cell" and NR Cell 1 "Serving cell" in accordance with TS 38.508-1 [4], Table 6.2.2.1-3, the UE is brought to state 1N-A, RRC_IDLE Connectivity (NR), in accordance with the procedure described in TS 38.508-1 [4], with one IMS PDU session on NR Cell 1, Table 4.5.2.2-2. 5G-GUTI and ngKSI are assigned and security context established.

11.1.6.3.2 Test procedure sequence

Table 11.1.6.3.2-1: Main behaviour

| St | Procedure | Message Sequence | | TP | Verdict |
|------|--|------------------|---|----|---------|
| | | U – S | Message | | |
| 1 | The SS configures:
- E-UTRA Cell 1 as "Suitable neighbour intra-frequency cell" in accordance with TS 38.508-1 [4], Table 6.2.2.1-3. | - | - | - | - |
| - | EXCEPTION: Unless otherwise stated the following messages are exchange on NR Cell 1. | - | - | - | - |
| 2 | The SS transmits a <i>Paging</i> message. | <-- | NR RRC: <i>Paging</i> | - | - |
| 3 | The UE transmits an <i>RRCSetupRequest</i> message. | --> | NR RRC: <i>RRCSetupRequest</i> | - | - |
| 4 | The SS transmits an <i>RRCSetup</i> message. | <-- | NR RRC: <i>RRCSetup</i> | - | - |
| 5 | The UE transmits an <i>RRCSetupComplete</i> message and a SERVICE REQUEST message. | --> | NR RRC: <i>RRCSetupComplete</i>
5GMM: SERVICE REQUEST | - | - |
| 6 | The SS transmits an <i>RRCRelease</i> message. | <-- | NR RRC: <i>RRCRelease</i> | - | - |
| - | EXCEPTION: The following message was sent on E-UTRA Cell 1. | - | - | - | - |
| 7 | UE transmits an <i>RRCCONNECTIONREQUEST</i> message. | --> | RRC: <i>RRCCONNECTIONREQUEST</i> | - | - |
| 8 | SS transmits an <i>RRCCONNECTIONSETUP</i> message. | <-- | RRC: <i>RRCCONNECTIONSETUP</i> | - | - |
| - | EXCEPTION: Steps 8a1 to 8b3 describe behaviour that depends on the UE implementation; the "lower case letter" identifies a step sequence that take place depending on the UE implementation. | - | - | - | - |
| 8a1 | If the UE tries to preserve the IP address of the PDN connection then check does the UE transmits an ATTACH REQUEST message? | --> | RRC: <i>RRCCONNECTIONSETUPCOMPLETE</i>
NAS: ATTACH REQUEST | 1 | P |
| 8b1 | Else check: does the UE transmit a TRACKING AREA UPDATE REQUEST message? | --> | RRC: <i>RRCCONNECTIONSETUPCOMPLETE</i>
NAS: TRACKING AREA UPDATE REQUEST | 1 | P |
| 8b2 | The SS transmits a TRACKING AREA UPDATE REJECT message to UE. | <-- | RRC: <i>DLINFORMATIONTRANSFER</i>
NAS: TRACKING AREA UPDATE REQUEST REJECT | - | - |
| 8b3 | The UE transmits an ATTACH REQUEST message. | --> | RRC: <i>ULINFORMATIONTRANSFER</i>
NAS: ATTACH REQUEST | - | - |
| 9-20 | Steps 5 to 16 of the generic test procedure for UE registration (TS 36.508 [7] Table 4.5.2.3-1). | - | - | - | - |

Table 11.1.6.3.3-1A: ATTACH REQUEST (step 8a1, table 11.1.6.3.2-1)

| Derivation Path: TS 36.508 [7], Table 4.7.2-4. | | | |
|--|---|---------|-----------|
| Information Element | Value/Remark | Comment | Condition |
| NAS key set identifier | KSI _{ASME} that was created when the UE last registered to EPC E-UTRA | | |
| Old GUTI | GUTI, mapped from the 5G-GUTI assigned at the initial registration when the UE entered N1 | | |
| Last visited registered TAI | The TAI the last visited E-UTRA Cell belonged to, if any. Not included if the UE does not have last stored EPC TAI. | | |
| Old GUTI type | "Native GUTI" | | |
| ESM message container | PDN CONNECTIVITY REQUEST message to active PDU sessions which the UE intends to transfer to EPS. | | |

Table 11.1.6.3.3-1B: PDN CONNECTIVITY REQUEST (step 8a1, table 11.1.6.3.2-1)

| Derivation Path: TS 36.508 [7], Table 4.7.3-20 | | | |
|--|---|--|-----------|
| Information Element | Value/remark | Comment | Condition |
| EPS bearer identity | 0 | No EPS bearer identity assigned | |
| Procedure transaction identity | Any value from 1 to 254 | | |
| PDN connectivity request message identity | '1101 0000'B | PDN connectivity request | |
| Request type | '010'B | Handover | |
| PDN type | Any value between '001'B, '010'B, '011'B and '100'B | The allowed values are respectively IPv4, IPv6, IPv4v6 and "unused but interpreted as IPv6 by the network" | |
| Protocol configuration options | PDU session ID of 5GS PDU session | | |

Table 11.1.6.3.3-2: TRACKING AREA UPDATE REQUEST (step 8b1, table 11.1.6.3.2-1)

| Derivation Path: TS 36.508 [7], Table 4.7.2-27, condition NR. | | | |
|---|---|--|-----------|
| Information Element | Value/Remark | Comment | Condition |
| "Active" flag | 0001 | Bearer Establishment requested | |
| EPS bearer context status | Present | EBI corresponding to active PDU Sessions need to be set to 1 | |
| NAS key set identifier | KSI _{ASME} that was created when the UE last registered to EPC E-UTRA | | |
| Old GUTI | GUTI, mapped from the 5G-GUTI assigned at the initial registration when the UE entered N1 | | |
| Last visited registered TAI | The TAI the last visited E-UTRA Cell belonged to, if any. Not included if the UE does not have last stored EPC TAI. | | |
| Old GUTI type | "Native GUTI" | | |
| UE status | "UE is in 5GMM-REGISTERED state" | | |

Table 11.1.6.3.3-3: TRACKING AREA UPDATE REJECT (step8b2, table 11.1.6.3.2-1)

| Derivation Path: TS 36.508 [7], Table 4.7.2-26. | | | |
|---|--------------|---|-----------|
| Information Element | Value/Remark | Comment | Condition |
| EMM cause | '0000 1001'B | #9 "UE identity cannot be derived by the network" | |

Table 11.1.6.3.3-4: ATTACH REQUEST (step 8b3, table 11.1.6.3.2-1)

| Derivation Path: TS 36.508 [7], Table 4.7.2-4. | | | |
|--|----------------|---------|-----------|
| Information Element | Value/Remark | Comment | Condition |
| IMSI | IMSI of the UE | | |

11.1.7 Emergency call setup from NR RRC_IDLE / Emergency Services Fallback to EPS with redirection / Single registration mode with N26 interface / Success

11.1.7.1 Test Purpose (TP)

(1)

```

with { UE supporting both S1 mode and N1 mode and operating in single-registration mode, and, the
Network has indicated "interworking without N26 interface not supported", and, the UE in NR RRC_IDLE
state }
ensure that {
  when { User initiates an Emergency call and the UE completes Access control and checking in 5GMM-
IDLE mode }
  then { UE requests the establishment of an Emergency call by transmitting an RRCSetupRequest
message with establishmentCause set to 'emergency', and, a SERVICE REQUEST message with Service type
set to 'emergency services fallback' }
}

```

(2)

```
with { UE is NR RRC_CONNECTED state after having requested a MMTEL call establishment and the MO IMS voice session establishment has been initiated }
ensure that {
  when { UE receives a RRCRelease message which includes redirectedCarrierInfo indicating redirection with cnType=epc }
  then { UE selects the E-UTRA cell, performs a TAU procedure, and, successfully completes the Emergency call setup in EPS }
}
```

11.1.7.2 Conformance requirements

References: The conformance requirements covered in the present TC are specified in: TS 24.501 [22], subclauses 5.6.1.1, 5.6.1.2, 5.6.1.4; TS 23.502 [31], subclause 4.13.4.2; TS 24.301 [21], subclauses 4.4.2.3, 5.5.3.2.2. Unless otherwise stated these are Rel-15 requirements.

NOTE: Conformance requirements in regard to establishing an emergency call in EPS are not provided. This can be found in IMS Emergency tests specified in TS 36.523-1 [13].

[TS 24.501, subclause 5.6.1.1]

The UE shall invoke the service request procedure when:

...

- h) the UE, in 5GMM-IDLE, 5GMM-CONNECTED mode over 3GPP access, or 5GMM-CONNECTED mode with RRC inactive indication, receives a request for emergency services fallback from the upper layer and performs emergency services fallback as specified in subclause 4.13.4.2 of 3GPP TS 23.502 [9]; or

[TS 24.501, subclause 5.6.1.2]

For case h) in subclause 5.6.1.1, the UE shall send a SERVICE REQUEST message with service type set to "emergency services fallback".

[TS 24.501, subclause 5.6.1.4]

For case h) in subclause 5.6.1.1, the UE shall treat the indication from the lower layers when the UE has changed to S1 mode or E-UTRA connected to 5GCN (see 3GPP TS 23.502 [9]) as successful completion of the procedure and stop timer T3517.

[TS 23.502, subclause 4.13.4.2]

The call flow in Figure 4.13.4.2-1 describes the procedure for emergency services fallback.

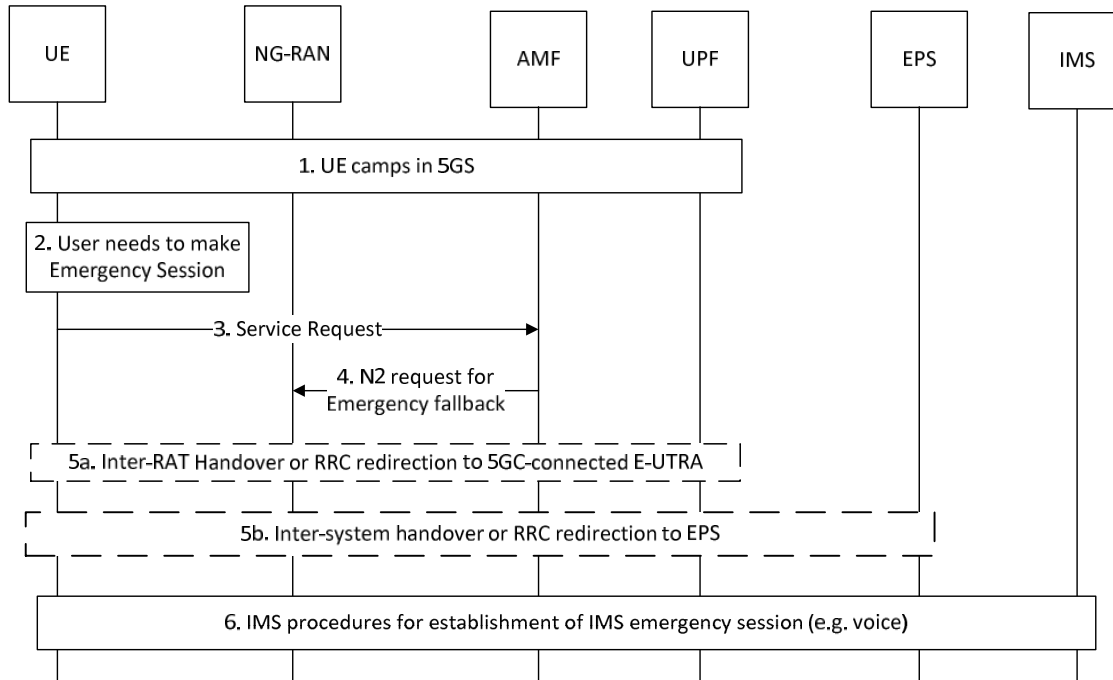

Figure 4.13.4.2-1: Emergency Services Fallback

1. UE camps on E-UTRA or NR cell in the 5GS (in either CM_IDLE or CM_CONNECTED state).
2. UE has a pending IMS emergency session request (e.g. voice) from the upper layers.
3. If the AMF has indicated support for emergency services using fallback via the Registration Accept message for the current RAT, the UE sends a Service Request message indicating that it requires emergency services fallback.
- ...
5. Based on the target CN indicated in message 4, one of the following procedures is executed by NG-RAN:
 - ...
 - 5b. NG-RAN initiates handover (see clause 4.11.1.2.1) or redirection to E-UTRAN connected to EPS. NG-RAN uses the security context provided by the AMF to secure the redirection procedure.

If the redirection procedure is used either in 5a or 5b the target CN is also conveyed to the UE in order to be able to perform the appropriate NAS procedures (S1 or N1 Mode).

[TS 24.301, subclause 4.4.2.3]

Secure exchange of NAS messages via a NAS signalling connection is usually established by the MME during the attach procedure by initiating a security mode control procedure. After successful completion of the security mode control procedure, all NAS messages exchanged between the UE and the MME are sent integrity protected using the current EPS security algorithms, and except for the messages specified in subclause 4.4.5, all NAS messages exchanged between the UE and the MME are sent ciphered using the current EPS security algorithms.

...

During inter-system change from N1 mode to S1 mode in 5GMM-IDLE mode, if the UE is operating in the single-registration mode and:

- 1) if the tracking area updating procedure is initiated as specified in 3GPP TS 24.501 [54], the UE shall transmit a TRACKING AREA UPDATE REQUEST message integrity protected with the current 5G NAS security context and the UE shall derive a mapped EPS security context (see subclause 8.6.1 of 3GPP TS 33.501 [56]). The UE shall include the eKSI indicating the 5G NAS security context value in the TRACKING AREA UPDATE REQUEST message.

After receiving the TRACKING AREA UPDATE REQUEST message including the eKSI, the MME forwards the TRACKING AREA UPDATE REQUEST message to the source AMF, if possible, to obtain the mapped EPS security context from the AMF as specified in 3GPP TS 33.501 [56]. The MME re-establishes the secure exchange of NAS messages by either:

- replying with a TRACKING AREA UPDATE ACCEPT message that is integrity protected and ciphered using the mapped EPS NAS security context. From this time onward, all NAS messages exchanged between the UE and the MME are sent integrity protected and except for the messages specified in subclause 4.4.5, all NAS messages exchanged between the UE and the MME are sent ciphered; or

[TS 24.301, subclause 5.5.3.2.2]

The UE in state EMM-REGISTERED shall initiate the tracking area updating procedure by sending a TRACKING AREA UPDATE REQUEST message to the MME,

...

- z) when the UE performs inter-system change from N1 mode to S1 mode in EMM-IDLE mode, the UE operates in single-registration mode, and conditions specified in 3GPP TS 24.501 [54] apply;

...

- zd) when the UE performs inter-system change from N1 mode to S1 mode in EMM-CONNECTED mode.

For all cases except case b, the UE shall set the EPS update type IE in the TRACKING AREA UPDATE REQUEST message to "TA updating". For case b, the UE shall set the EPS update type IE to "periodic updating".

...

When initiating a tracking area updating procedure while in S1 mode, the UE shall use the current EPS NAS integrity key to integrity protect the TRACKING AREA UPDATE REQUEST message, unless the UE is performing inter-system change from N1 mode to S1 mode.

...

If a UE has established PDN connection(s) and uplink user data pending to be sent via user plane when it initiates the tracking area updating procedure, or uplink signalling not related to the tracking area updating procedure when the UE does not support control plane CIoT EPS optimization, it may also set an "active" flag in the TRACKING AREA UPDATE REQUEST message to indicate the request to establish the user plane to the network and to keep the NAS signalling connection after the completion of the tracking area updating procedure.

...

If the UE has a current EPS security context, the UE shall include the eKSI (either KSI_{ASME} or KSI_{SGSN}) in the NAS Key Set Identifier IE in the TRACKING AREA UPDATE REQUEST message. Otherwise, the UE shall set the NAS Key Set Identifier IE to the value "no key is available". If the UE has a current EPS security context, the UE shall integrity protect the TRACKING AREA UPDATE REQUEST message with the current EPS security context. Otherwise the UE shall not integrity protect the TRACKING AREA UPDATE REQUEST message.

...

For the case z and zd, the TRACKING AREA UPDATE REQUEST message shall be integrity protected using the 5GS security context available in the UE. The UE shall include a GUTI, mapped from 5G-GUTI (see 3GPP TS 23.501 [54] and 3GPP TS 23.003 [2]), in the Old GUTI IE in the TRACKING AREA UPDATE REQUEST message. In addition, the UE shall include Old GUTI type IE with GUTI set to "Native GUTI", and the UE shall include a UE status IE with a 5GMM registration status set to "UE is in 5GMM-REGISTERED state".

When the tracking area updating procedure is initiated in EMM-IDLE mode, the UE may also include an EPS bearer context status IE in the TRACKING AREA UPDATE REQUEST message, indicating which EPS bearer contexts are

active in the UE. The UE shall include the EPS bearer context status IE in TRACKING AREA UPDATE REQUEST message:

- ...
- for the case z; and
- ...

If the UE initiates the first tracking area updating procedure following an initial registration in N1 mode and the UE is operating in the single-registration mode, the UE shall include a UE radio capability information update needed IE in the TRACKING AREA UPDATE REQUEST message.

...

If the UE supports NB-S1 mode, Non-IP PDN type, or N1 mode, then the UE shall support the extended protocol configuration options IE.

For all cases except case b, if the UE supports the extended protocol configuration options IE, then the UE shall set the ePCO bit to "extended protocol configuration options supported" in the UE network capability IE of the TRACKING AREA UPDATE REQUEST message.

...

For all cases except case b, if the UE supports dual connectivity with NR, then the UE shall set the DCNR bit to "dual connectivity with NR supported" in the UE network capability IE of the TRACKING AREA UPDATE REQUEST message and shall include the UE additional security capability IE in the TRACKING AREA UPDATE REQUEST message.

...

For all cases except case b, if the UE supports N1 mode, the UE shall set the N1mode bit to "N1 mode supported" in the UE network capability IE of the TRACKING AREA UPDATE REQUEST message and shall include the UE additional security capability IE in the TRACKING AREA UPDATE REQUEST message.

11.1.7.3 Test description

11.1.7.3.1 Pre-test conditions

System Simulator:

- 2 cells
 - NR Cell 1 as defined in TS 38.508-1 [4] Table 4.4.2-3. System information combination NR-6 as defined in TS 38.508-1 [4], subclause 4.4.3.1.2.
 - E-UTRA Cell 1 as defined in TS 36.508 [7] Table 4.4.2-2. System information combination 31 as defined in TS 36.508 [7], subclause 4.4.3.1.1.

UE:

None.

Preamble:

- With E-UTRA Cell 1 "Serving cell" and NR Cell 1 "Non-suitable "Off" cell" in accordance with TS 38.508-1 [4], Table 6.2.2.1-3, the UE is brought to state RRC_IDLE Connectivity (*E-UTRA/EPC*) in accordance with the procedure described in TS 38.508-1 [4], Table 4.5.2.2-1. 4G GUTI and eKSI are assigned and security context established
 - the UE is switched-off
- With E-UTRA Cell 1 "Non-suitable "Off" cell" and NR Cell 1 "Serving cell" in accordance with TS 38.508-1 [4], Table 6.2.2.1-3, the UE is brought to state IN-A, RRC_IDLE Connectivity (NR), in accordance with the

procedure described in TS 38.508-1 [4], Table 4.5.2.2-2. 5G-GUTI and ngKSI are assigned and security context established.

11.1.7.2 Test procedure sequence

Table 11.1.7.3.2-1: Main behaviour

| St | Procedure | Message Sequence | | TP | Verdict |
|---------------------|---|------------------|--|----|---------|
| | | U - S | Message | | |
| 1 | The SS configures:
- E-UTRA Cell 1 as "Suitable neighbour intra-frequency cell" in accordance with TS 38.508-1 [4], Table 6.2.2.1-3. | - | - | - | - |
| - | EXCEPTION: Unless otherwise stated the following messages are exchange on NR Cell 1. | - | - | - | - |
| 2 | Make the UE initiate an Emergency call. | - | - | - | - |
| 3 | Check: Does the UE transmit an <i>RRCSetupRequest</i> message with <i>establishmentCause</i> set to 'emergency'? | --> | NR RRC: <i>RRCSetupRequest</i> | 1 | P |
| 4 | The SS transmits an <i>RRCSetup</i> message. | <-- | NR RRC: <i>RRCSetup</i> | - | - |
| 5 | Check: Does the UE transmit a SERVICE REQUEST message with Service type set to 'emergency services fallback'?
NOTE: The UE shall request 'emergency services fallback' when the AMF has indicated support for emergency services using fallback via the Registration Accept message for the current RAT as per TS 23.502 [31], subclause 4.13.4.2. | --> | NR RRC: <i>RRCSetupComplete</i>
5GMM: SERVICE REQUEST | 1 | P |
| 6 | SS transmits <i>RRCRelease</i> message indicating redirection to E-UTRA Cell 1. | <-- | NR RRC: <i>RRCRelease</i> | - | - |
| - | EXCEPTION: Unless otherwise stated the following messages are exchange on E-UTRA Cell 1. | - | - | - | - |
| 7 | The UE transmits an <i>RRCConnectionRequest</i> message with 'establishmentCause' set to 'emergency'. | --> | RRC: <i>RRCConnectionRequest</i> | 2 | P |
| 8-10b
2 | Steps 2-4b2 from the Tracking area updating procedure as specified in TS 38.508-1 [4], Table 4.9.7.2.2-1 are performed (UE performs inter-system change from N1 to S1, mapped EPS NAS security context from the 5GC). | - | - | - | - |
| 10
A-
10
D | Steps 5-8 from the Generic Test Procedure for IMS Emergency call establishment in EUTRA: Normal Service as specified in TS 36.508 [7], Table 4.5A.4.3-1 are performed | - | - | - | - |
| 10
E | SS responds with TRACKING AREA UPDATE ACCEPT message. | <-- | RRC: <i>DLInformationTransfer</i>
NAS: TRACKING AREA UPDATE ACCEPT | - | - |
| 11 | Check: Does the UE transmit a TRACKING AREA UPDATE COMPLETE message? | --> | RRC: <i>ULInformationTransfer</i>
NAS: TRACKING AREA UPDATE COMPLETE | 2 | P |
| 12-17 | Steps 9-14 from the Generic Test Procedure for IMS Emergency call establishment in EUTRA: Normal Service as specified in TS 36.508 [7], Table 4.5A.4.3-1 are performed. | - | - | - | - |
| 18-19 | Void | | | | |
| 20 | Check: Does the UE transmit an ACTIVATE DEDICATED EPS BEARER CONTEXT ACCEPT message? | --> | RRC: <i>ULInformationTransfer</i>
NAS: ACTIVATE DEDICATED EPS BEARER CONTEXT ACCEPT | 2 | P |
| 21 | The SS waits 1 second. | - | - | - | - |
| 22 | Release IMS Call as specified in the generic procedure in TS 34.229-1 [35] subclause C.32. | - | - | - | - |

11.1.7.3.3 Specific message contents

Table 11.1.7.3.3-1: REGISTRATION REQUEST (Preamble; TS 38.508-1 [4], Table 4.5.2.2-2)

| Derivation Path: TS 38.508-1 [4], Table 4.7.1-6 | | | |
|---|--------------|--|-----------|
| Information Element | Value/remark | Comment | Condition |
| 5GMM capability | '0000 0xx1' | S1 mode supported

x - not checked | |

Table 11.1.7.3.3-2: REGISTRATION ACCEPT (Preamble; TS 38.508-1 [4], Table 4.5.2.2-2)

| Derivation path: TS 38.508-1 [4], Table 4.7.1-7 | | | |
|---|--------------|--|-----------|
| Information Element | Value/remark | Comment | Condition |
| 5GS network feature support | | | |
| Emergency service fallback indicator for 3GPP access (EMF) (octet 3, bit 5 and bit 6) | '01' | Emergency services fallback supported in NR connected to 5GCN only | |

Table 11.1.7.3.3-3: RRCSetupRequest (step 3, table 11.1.7.3.2-1)

| Derivation Path: TS 38.508-1 [4], Table 4.6.1-23 | | | |
|--|--------------|---------|-----------|
| Information Element | Value/remark | Comment | Condition |
| RRCSetupRequest ::= SEQUENCE { | | | |
| rrcSetupRequest SEQUENCE { | | | |
| establishmentCause | emergency | | |
| } | | | |
| } | | | |

Table 11.1.7.3.3-4: SERVICE REQUEST (step 5, table 11.1.7.3.2-1)

| Derivation path: TS 38.508-1 [4], Table 4.7.1-16 | | | |
|--|--------------|-----------------------------|-----------|
| Information Element | Value/Remark | Comment | Condition |
| Service type | '0100'B | emergency services fallback | |

Table 11.1.7.3.3-5: RRCRelease (step 6, table 11.1.7.3.2-1)

| Derivation path: TS 38.508-1 [4], Table 4.6.1-16 | | | |
|--|----------------------------------|---------|-----------|
| Information Element | Value/Remark | Comment | Condition |
| RRCRelease ::= SEQUENCE { | | | |
| criticalExtensions CHOICE { | | | |
| rrcRelease SEQUENCE { | | | |
| redirectedCarrierInfo CHOICE { | | | |
| eutra SEQUENCE { | | | |
| eutraFrequency | Downlink EARFCN of E-UTRA Cell 1 | | |
| cnType | epc | | |
| } | | | |
| } | | | |
| } | | | |
| } | | | |

Table 11.1.7.3.3-6: RRCConnectionRequest (step 7, Table 11.1.7.3.2-1)

| Derivation Path: TS 36.508 [7], Table 4.6.1-16 | | | |
|--|--------------|---------|-----------|
| Information Element | Value/remark | Comment | Condition |
| RRCConnectionRequest ::= SEQUENCE { | | | |
| criticalExtensions CHOICE { | | | |
| rrcConnectionRequest-r8 SEQUENCE { | | | |
| establishmentCause | emergency | | |
| } | | | |
| } | | | |
| } | | | |

Table 11.1.7.3.3-7: Void**Table 11.1.7.3.3-8: Void****Table 11.1.7.3.3-8a: TRACKING AREA UPDATE ACCEPT (Step 10D, Table 11.1.7.3.2-1)**

| Derivation Path: TS 36.508 [2], Table 4.7.2-24, condition NR. |
|---|
|---|

Table 11.1.7.3.3-9: Message PDN CONNECTIVITY REQUEST (step 14, Table 11.1.7.3.2-1)

| Derivation Path: TS 36.508 [7], Table 4.7.2-1. | | | |
|--|--------------|-----------|-----------|
| Information Element | Value/Remark | Comment | Condition |
| Request type | '0100'B | emergency | |
| Access point name | Not present | | |

Table 11.1.7.3.3-10: Message ACTIVATE DEFAULT EPS BEARER CONTEXT REQUEST (step 15, Table 11.1.7.3.2-1)

| Derivation path: TS 36.508 [7], Table 4.7.3-6 and table 4.6.1-8 with condition UM-DRB-ADD(2). | | | |
|---|---|---|-----------|
| Information Element | Value/Remark | Comment | Condition |
| EPS bearer identity | an additional EPS Bearer Id different from default EPS Bearer Id or/and any mapped EPS bearer | | |
| Access point name | sos | APN value as recommended by IR.88 clause 6.4 [39] | |

11.1.8

11.1.9 MO MMTEL voice call setup from NR RRC_IDLE / EPS Fallback with redirection / Single registration mode with N26 interface / voiceFallbackIndication

11.1.9.1 Test Purpose (TP)

(1)

```

with { UE being in NR RRC_CONNECTED state after having requested an MMTEL call establishment and the
MO IMS voice session establishment has been initiated }
ensure that {
  when { UE receives an RRCRelease message which includes redirectedCarrierInfo indicating
redirection to E-UTRA and with voiceFallbackIndication }

```

```
    then {UE selects the E-UTRA cell, uses "mo-VoiceCall" as the establishment cause value in RRC
Connection Request, performs a TAU procedure, and, successfully completes the MMTEL call setup in
EPS }
}
```

11.1.9.2 Conformance requirements

References: The conformance requirements covered in the current TC are specified in: TS 24.501, clauses 4.5.4.1; TS 38.331, clause 5.3.8.3, 5.3.11. Unless otherwise stated these are Rel-16 requirements.

[TS 24.501, clause 4.5.4.1]

When the UE is in 5GMM-IDLE mode or 5GMM-IDLE mode with suspend indication, upon receiving a request from the upper layers for an access attempt, the NAS shall categorize the access attempt into access identities and an access category following:

- a) subclause 4.5.2, table 4.5.2.1 and table 4.5.2.2, and subclause 4.5.3, if the UE is not operating in SNPN access mode; or
- b) subclause 4.5.2A, table 4.5.2A.1 and table 4.5.2A.2, and subclause 4.5.3, if the UE is operating in SNPN access mode,

and provide the applicable access identities and the access category to the lower layers for the purpose of access control checking. In this request to the lower layer the NAS can also provide to the lower layer the RRC establishment cause determined as specified in subclause 4.5.6 of this specification.

NOTE 1: The access barring check is performed by the lower layers.

NOTE 2: As an implementation option, the NAS can provide the RRC establishment cause to the lower layers after being informed by the lower layers that the access attempt is allowed.

If the UE has uplink user data pending for one or more PDU sessions when it builds a REGISTRATION REQUEST or SERVICE REQUEST message as initial NAS message, the UE shall indicate the respective PDU sessions in the Uplink data status IE as specified in subclause 5.5.1.3.2 and 5.6.1.2.1, regardless of the access category for which the access barring check is performed.

If the UE is registered for 5GS services with control plane CIoT 5GS optimization has uplink user data pending for one or more PDU sessions when it builds a CONTROL PLANE SERVICE REQUEST message as initial NAS message, the UE shall indicate the respective PDU sessions as specified in subclause 5.6.1.2.2, regardless of the access category for which the access barring check is performed.

NOTE 3: The UE indicates pending user data for all the respective PDU sessions, even if barring timers are running for some of the corresponding access categories.

If the lower layers indicate that the access attempt is allowed, the NAS shall initiate the procedure to send the initial NAS message for the access attempt.

[TS 38.331, clause 5.3.8.3]

The UE shall:

- 1> delay the following actions defined in this sub-clause 60 ms from the moment the *RRCRelease* message was received or optionally when lower layers indicate that the receipt of the *RRCRelease* message has been successfully acknowledged, whichever is earlier;
- 1> stop timer T380, if running;
- 1> stop timer T320, if running;
- 1> if timer T316 is running:
 - 2> stop timer T316;
 - 2> clear the information included in *VarRLF-Report*, if any;
- 1> stop timer T350, if running;

- 1> if the AS security is not activated:
 - 2> ignore any field included in *RRCRelease* message except *waitTime*;
 - 2> perform the actions upon going to RRC_IDLE as specified in 5.3.11 with the release cause 'other' upon which the procedure ends;
- 1> if the *RRCRelease* message includes *redirectedCarrierInfo* indicating redirection to *eutra*:
 - 2> if *cnType* is included:
 - 3> after the cell selection, indicate the available CN Type(s) and the received *cnType* to upper layers;

NOTE 1: Handling the case if the E-UTRA cell selected after the redirection does not support the core network type specified by the *cnType*, is up to UE implementation.

- 2> if *voiceFallbackIndication* is included:
 - 3> consider the RRC connection release was for EPS fallback for IMS voice (see TS 23.502 [43]);

[TS 38.331, clause 5.3.11]

UE shall:

- 1> reset MAC;
- 1> if T302 is running:
 - 2> stop timer T302;
 - 2> perform the actions as specified in 5.3.14.4;
- 1> stop all timers that are running except T320 and T325;
- 1> discard the UE Inactive AS context;
- 1> set the variable *pendingRnaUpdate* to *false*, if that is set to *true*;
- 1> discard the K_{gNB} , the K_{RRCenc} key, the K_{RRCint} , the K_{UPint} key and the K_{UPenc} key, if any;
- 1> release all radio resources, including release of the RLC entity, the MAC configuration and the associated PDCP entity and SDAP for all established RBs;
- 1> indicate the release of the RRC connection to upper layers together with the release cause;
- 1> enter RRC_IDLE and perform cell selection as specified in TS 38.304 [20], except if going to RRC_IDLE was triggered by selecting an inter-RAT cell while T311 was running;
- 1> if going to RRC_IDLE was triggered by reception of the *RRCRelease* message including a *waitTime*:
 - 2> start timer T302 with the value set to the *waitTime*;
 - 2> inform the upper layer that access barring is applicable for all access categories except categories '0' and '2'.

11.1.9.3 Test description

11.1.9.3.1 Pre-test conditions

System Simulator:

- 2 cells
 - NR Cell 1 is configured according to TS 38.508-1 [4] Table 4.4.2-3 and is connected to 5GC.
 - E-UTRA Cell 1 is configured to TS 36.508 [7] Table 4.4.2-2 and is connected to EPC.

- System information for the NR Cell 1 in accordance with combination NR-6 in TS 38.508-1 [4] sub-clause 4.4.3.1.2, and, for the E-UTRA Cell 1 in accordance with system information combination 31 as defined in TS 36.508 [7], subclause 4.4.3.1.1.
- Power levels are constant and as defined in Table 11.1.9.3.1-1

Table 11.1.9.3.1-1: Cell power levels

| | Parameter name | Unit | NR Cell 1 | E-UTRA Cell 1 |
|----|---------------------|-----------|----------------|----------------|
| T0 | SS/PBCH
SSS EPRE | dBm/SCS | "Serving Cell" | |
| | RS EPRE | dBm/15kHz | | "Serving Cell" |

UE:

None.

Preamble:

With E-UTRA Cell 1 "Serving cell" and NR Cell 1 "Non-suitable "Off" cell" in accordance with TS 38.508-1 [4], Table 6.2.2.1-3, the UE is brought to state RRC_IDLE Connectivity (*E-UTRA/EPC*) in accordance with the procedure described in TS 38.508-1 [4], Table 4.5.2.2-1. 4G GUTI and eKSI are assigned and security context established

The UE is switched-off

With E-UTRA Cell 1 "Non-suitable "Off" cell" and NR Cell 1 "Serving cell" in accordance with TS 38.508-1 [4], Table 6.2.2.1-3, the UE is brought to state 1N-A, RRC_IDLE Connectivity (NR), in accordance with the procedure described in TS 38.508-1 [4], Table 4.5.2.2-2. 5G-GUTI and ngKSI are assigned and security context established.

11.1.9.3.2 Test procedure sequence

Table 11.1.9.3.2-1: Main behaviour

| St | Procedure | Message Sequence | | TP | Verdict |
|-----------|---|------------------|--|----|---------|
| | | U - S | Message | | |
| 0 | Set the power levels according to "T0" as per Table 11.1.9.3.1-1. | - | - | - | - |
| 1 | Make the UE attempt an MTSI MO Speech Call (Note 1). | - | - | - | - |
| 2 | UE sends NR <i>RRCSetupRequest</i> with <i>EstablishmentCause</i> set to 'mo-VoiceCall'. | --> | NR RRC: <i>RRCSetupRequest</i> | - | - |
| 3 | SS transmits an NR <i>RRCSetup</i> message | <-- | NR RRC: <i>RRCSetup</i> | - | - |
| 4 | UE transmits an NR <i>RRCSetupComplete</i> message to confirm the successful completion of the connection establishment including initiation of 5GSM procedure by including the SERVICE REQUEST message with <i>Service Type</i> set to 'data'. | --> | NR RRC: <i>RRCSetupComplete</i>
5GSM: SERVICE REQUEST | - | - |
| 8 | Steps 5-8 of expected sequence from Table 4.5.4.2-3 as defined in TS 38.508-1 [4] are performed. | - | - | - | - |
| 9-13 | Steps 1-5 of expected sequence from A.9.1 as defined in TS 34.229-5 [41] are performed for setting up MTSI MO speech call - EPS fallback. | - | - | - | - |
| 14 | SS transmits <i>RRCRelease</i> message indicating redirection to E-UTRA Cell 1. | <-- | NR RRC: <i>RRCRelease</i> | - | - |
| - | EXCEPTION: Unless otherwise stated all the messages below are transmitted on the cell specified in the test case. | - | - | - | - |
| 15 | The UE transmits an <i>RRCConnectionRequest</i> message on the cell specified in the test case. | --> | RRC: <i>RRCConnectionRequest</i> | 1 | P |
| 16-20 | UE performs generic procedure as defined in TS 38.508-1 [4], Table 4.9.7.2.2-1 Steps 2-6 for N1 to S1 Inter mode change with condition 'connected without release' & 'mapped 5G security context'. | - | - | - | - |
| 21-24 | Generic Test Procedure as defined in Steps 5-8 of TS 36.508-1 [4] Table 4.5A.6.3-1 is performed to establish radio bearer corresponding to IMS PDN. | - | - | - | - |
| - | EXCEPTION: Steps 25a1-25a2 describe a step sequence depending on UE implementation. | - | - | - | - |
| 25a1-25a2 | The UE may perform steps 1-2 according to TS 34.229-1 subclause C.46 to perform IMS re-registration on EUTRAN. | - | - | - | - |
| 26 | The SS configures a new RLC-UM data radio bearer with condition DRB (0,1), associated with the dedicated EPS bearer context. <i>RRCConnectionReconfiguration</i> message contains the ACTIVATE DEDICATED EPS BEARER CONTEXT REQUEST message. EPS bearer context #4 (QCI 1) according to table 6.6.2-1: Reference dedicated EPS bearer contexts. | <-- | RRC:
<i>RRCConnectionReconfiguration</i>
NAS:
ACTIVATE DEDICATED EPS BEARER CONTEXT REQUEST | - | - |
| - | EXCEPTION: In parallel to the events described in steps 27-28 the steps specified in table 11.1.9.3.2-2 will take place. | - | - | - | - |
| 27 | The UE transmits an <i>RRCConnectionReconfigurationComplete</i> message to confirm the establishment of the new data radio bearer, associated with the dedicated EPS bearer. | --> | RRC:
<i>RRCConnectionReconfigurationComplete</i> | - | - |

Table 11.1.9.3.3-2: RRCConnectionRequest (step 15, table 11.1.9.3.2-1)

| Derivation path: TS 36.508-1 Table Table 4.6.1-16 | | | |
|---|----------------------------------|--------------|-----------|
| Information Element | Value/Remark | Comment | Condition |
| RRCConnectionRequest ::= SEQUENCE { | | | |
| criticalExtensions CHOICE { | | | |
| rrcConnectionRequest-r8 SEQUENCE { | | | |
| ue-Identity CHOICE { | | | |
| s-TMSI | Any allowed value | | |
| } | | | |
| establishmentCause | mo-VoiceCall-v1280 | mo-VoiceCall | |
| spare | Present but contents not checked | | |
| } | | | |
| } | | | |
| } | | | |

11.2 5GS/RAT Fallback

FFS

11.3 Unified Access Control (UAC)

11.3.1 UAC / Access Identity 0 / 0% access probability / MTSI MO speech call/SMSoIP/Uplink User data transfer

11.3.1.1 Test Purpose (TP)

(1)

```
with { UE not configured for special AIs (1,2,11-15) having received a SIB1 message indicating UAC
Info set to 0% accessibility for Access category 4 and in NR RRC_IDLE }
ensure that {
  when { User initiates MMTEL Voice call }
    then { UE does not initiate connection over NR Cell }
}
```

(2)

```
with { UE not configured for special AIs (1,2,11-15) , previously barred for MO MTSI MMTEL Voice in
NR RRC_IDLE & current SIB1 indicates no access barred as part of UAC Info }
ensure that {
  when { user tries another MO MTSI MMTEL Voice session after T390 expires }
    then { UE is able to successfully establish MMTEL Voice session }
}
```

(3)

```
with { UE not configured for special AIs (1,2,11-15) with SIB1 indicating UAC info set to 0%
accessibility for Access category 6 in NR RRC_CONNECTED state }
ensure that {
  when { user tries to send SMS over IP }
    then { UE does not initiate SMS access attempt }
}
```

(4)

```
with { UE not configured for special AIs (1,2,11-15) , with at least one PDU Session in 5GSM PDU
SESSION ACTIVE state (with user plane suspended) in NR RRC_INACTIVE state & SIB1 indicating 0%
accessibility for Access Category 7 in NR RRC_INACTIVE state }
ensure that {
```

```

when { User initiates uplink user data packet to be sent for a PDU session with suspended user-
plane resources }
  then { UE does not send the data packet }
}

```

11.3.1.2 Conformance requirements

References: The conformance requirements covered in the present TC are specified in TS 24.501: clause 4.5.2, 4.5.4.1, 4.5.4.2 and 4.5.6 and TS 38.331: clause 5.3.14.1, 5.3.14.2, 5.3.14.4 and 5.3.14.5. Unless otherwise stated these are Rel-15 requirements.

[TS 24.501, clause 4.5.2]

When the UE needs to initiate an access attempt in one of the events listed in subclause 4.5.1, the UE shall determine one or more access identities from the set of standardized access identities, and one access category from the set of standardized access categories and operator-defined access categories, to be associated with that access attempt.

The set of the access identities applicable for the request is determined by the UE in the following way:

- a) for each of the access identities 1, 2, 11, 12, 13, 14 and 15 in table 4.5.2.1, the UE shall check whether the access identity is applicable in the selected PLMN, if a new PLMN is selected, or otherwise if it is applicable in the RPLMN or equivalent PLMN; and
- b) if none of the above access identities is applicable, then access identity 0 is applicable.

Table 4.5.2.1: Access identities

| Access Identity number | UE configuration |
|---|--|
| 0 | UE is not configured with any parameters from this table |
| 1 (NOTE 1) | UE is configured for multimedia priority service (MPS). |
| 2 (NOTE 2) | UE is configured for mission critical service (MCS). |
| 3-10 | Reserved for future use |
| 11 (NOTE 3) | Access Class 11 is configured in the UE. |
| 12 (NOTE 3) | Access Class 12 is configured in the UE. |
| 13 (NOTE 3) | Access Class 13 is configured in the UE. |
| 14 (NOTE 3) | Access Class 14 is configured in the UE. |
| 15 (NOTE 3) | Access Class 15 is configured in the UE. |
| NOTE 1: Access identity 1 is valid when: <ul style="list-style-type: none"> - the USIM file EF_{UAC_AIC} indicates the UE is configured for access identity 1 and the RPLMN is the HPLMN (if the EHPLMN list is not present or is empty) or EHPLMN (if the EHPLMN list is present), or a visited PLMN of the home country (see the definition of home country in 3GPP TS 24.301 [15]); or - the UE receives the 5GS network feature support IE with the MPS indicator bit set to "Access identity 1 valid in RPLMN or equivalent PLMN" from the RPLMN as described in subclause 5.5.1.2.4 and subclause 5.5.1.3.4. | |
| NOTE 2: Access identity 2 is used by UEs configured for MCS and is valid when: <ul style="list-style-type: none"> - the USIM file EF_{UAC_AIC} indicates the UE is configured for access identity 2 and the RPLMN is the HPLMN (if the EHPLMN list is not present or is empty) or EHPLMN (if the EHPLMN list is present), or a visited PLMN of the home country (see 3GPP TS 23.122 [5]); or - the UE receives the 5GS network feature support IE with the MCS indicator bit set to "Access identity 2 valid in RPLMN or equivalent PLMN" from the RPLMN as described in subclause 5.5.1.2.4 and subclause 5.5.1.3.4. | |
| NOTE 3: Access identities 11 and 15 are valid in HPLMN (if the EHPLMN list is not present or is empty) or EHPLMN (if the EHPLMN list is present). Access Identities 12, 13 and 14 are valid in HPLMN and visited PLMNs of home country only (see the definition of home country in 3GPP TS 24.301 [15]). | |

The UE uses the MPS indicator bit of the 5GS network feature support IE to determine if access identity 1 is valid. Processing of the MPS indicator bit of the 5GS network feature support IE in the REGISTRATION ACCEPT message is described in subclause 5.5.1.2.4 and subclause 5.5.1.3.4. The UE shall not consider access identity 1 to be valid when the UE is not in the country of its HPLMN prior to receiving the MPS indicator bit of the 5GS network feature support IE in the REGISTRATION ACCEPT message being set to "Access identity 1 valid in RPLMN or equivalent PLMN".

When the UE is in the country of its HPLMN, the contents of the USIM files EF_{UAC_AIC} and EF_{ACC} as specified in 3GPP TS 31.102 [22] and the rules specified in table 4.5.2.1 are used to determine the applicability of access identity 1

and access classes 11 - 15. When the UE is in the country of its HPLMN, and the USIM file EF_{UAC,AIC} does not indicate the UE is configured for access identity 1, the UE uses the MPS indicator bit of the 5GS network feature support IE in the REGISTRATION ACCEPT message to determine if access identity 1 is valid. When the UE is in the country of its HPLMN, and the USIM file EF_{UAC,AIC} indicates the UE is configured for access identity 1, the MPS indicator bit of the 5GS network feature support IE is not applicable. When the UE is not in the country of its HPLMN, the contents of the USIM files EF_{UAC,AIC} and EF_{ACC} are not applicable.

The UE uses the MCS indicator bit of the 5GS network feature support IE to determine if access identity 2 is valid. Processing of the MCS indicator bit of the 5GS network feature support IE in the REGISTRATION ACCEPT message is described in subclause 5.5.1.2.4 and subclause 5.5.1.3.4. The UE shall not consider access identity 2 to be valid when the UE is not in the country of its HPLMN prior to receiving the MCS indicator bit of the 5GS network feature support IE in the REGISTRATION ACCEPT message being set to "Access identity 2 valid in RPLMN or equivalent PLMN".

When the UE is in the country of its HPLMN, the contents of the USIM files EF_{UAC,AIC} and EF_{ACC} as specified in 3GPP TS 31.102 [22] and the rules specified in table 4.5.2.1 are used to determine the applicability of access identity 2 and access classes 11 - 15. When the UE is in the country of its HPLMN, and the USIM file EF_{UAC,AIC} does not indicate the UE is configured for access identity 2, the UE uses the MCS indicator bit of the 5GS network feature support IE in the REGISTRATION ACCEPT message to determine if access identity 2 is valid. When the UE is in the country of its HPLMN, and the USIM file EF_{UAC,AIC} indicates the UE is configured for access identity 2, the MCS indicator bit of the 5GS network feature support IE is not applicable. When the UE is not in the country of its HPLMN, the contents of the USIM files EF_{UAC,AIC} and EF_{ACC} are not applicable.

In order to determine the access category applicable for the access attempt, the NAS shall check the rules in table 4.5.2.2, and use the access category for which there is a match for barring check. If the access attempt matches more than one rule, the access category of the lowest rule number shall be selected. If the access attempt matches more than one operator-defined access category definition, the UE shall select the access category from the operator-defined access category definition with the lowest precedence value (see subclause 4.5.3).

NOTE: The case when an access attempt matches more than one rule includes the case when multiple events trigger an access attempt at the same time.

Table 4.5.2.2: Mapping table for access categories

| Rule # | Type of access attempt | Requirements to be met | Access Category |
|--|---|--|---|
| 1 | Response to paging or NOTIFICATION over non-3GPP access;
5GMM connection management procedure initiated for the purpose of transporting an LPP message | Access attempt is for MT access | 0 (= MT_acc) |
| 2 | Emergency | UE is attempting access for an emergency session (NOTE 1, NOTE 2) | 2 (= emergency) |
| 3 | Access attempt for operator-defined access category | UE stores operator-defined access category definitions valid in the current PLMN as specified in subclause 4.5.3, and access attempt is matching criteria of an operator-defined access category definition | 32-63
(= based on operator classification) |
| 4 | Access attempt for delay tolerant service | (a) UE is configured for NAS signalling low priority or UE supporting S1 mode is configured for EAB (see the "ExtendedAccessBarring" leaf of NAS configuration MO in 3GPP TS 24.368 [17] or 3GPP TS 31.102 [22]) where "EAB override" does not apply, and
(b) the UE received one of the categories a, b or c as part of the parameters for unified access control in the broadcast system information, and the UE is a member of the broadcasted category in the selected PLMN or RPLMN/equivalent PLMN (NOTE 3, NOTE 5, NOTE 6, NOTE 7, NOTE 8) | 1 (= delay tolerant) |
| 5 | MO MMTel voice call | Access attempt is for MO MMTel voice call or for NAS signalling connection recovery during ongoing MO MMTel voice call (NOTE 2) | 4 (= MO MMTel voice) |
| 6 | MO MMTel video call | Access attempt is for MO MMTel video call or for NAS signalling connection recovery during ongoing MO MMTel video call (NOTE 2) | 5 (= MO MMTel video) |
| 7 | MO SMS over NAS or MO SMSoIP | Access attempt is for MO SMS over NAS (NOTE 4) or MO SMS over SMSoIP transfer or for NAS signalling connection recovery during ongoing MO SMS or SMSoIP transfer (NOTE 2) | 6 (= MO SMS and SMSoIP) |
| 8 | UE NAS initiated 5GMM specific procedures | Access attempt is for MO signalling | 3 (= MO_sig) |
| 9 | UE NAS initiated 5GMM connection management procedure or 5GMM NAS transport procedure | Access attempt is for MO data | 7 (= MO_data) |
| 10 | An uplink user data packet is to be sent for a PDU session with suspended user-plane resources | No further requirement is to be met | 7 (= MO_data) |
| <p>NOTE 1: This includes 5GMM specific procedures while the service is ongoing and 5GMM connection management procedures required to establish a PDU session with request type = "initial emergency request" or "existing emergency PDU session", or to re-establish user-plane resources for such a PDU session. This further includes the service request procedure initiated with a SERVICE REQUEST message with the Service type IE set to "emergency services fallback".<</p> <p>NOTE 2: Access for the purpose of NAS signalling connection recovery during an ongoing service, or for the purpose of NAS signalling connection establishment following fallback indication from lower layers during an ongoing service, is mapped to the access category of the ongoing service in order to derive an RRC establishment cause, but barring checks will be skipped for this access attempt.</p> | | | |

| | |
|---------|--|
| NOTE 3: | If the UE selects a new PLMN, then the selected PLMN is used to check the membership; otherwise the UE uses the RPLMN or a PLMN equivalent to the RPLMN. |
| NOTE 4: | This includes the 5GMM connection management procedures triggered by the UE-initiated NAS transport procedure for transporting the MO SMS. |
| NOTE 5: | The UE configured for NAS signalling low priority is not supported in this release of specification. If a UE supporting both S1 mode and N1 mode is configured for NAS signalling low priority in S1 mode as specified in 3GPP TS 24.368 [17] or 3GPP TS 31.102 [22], the UE shall ignore the configuration for NAS signalling low priority when in N1 mode. |
| NOTE 6: | If the access category applicable for the access attempt is 1, then the UE shall additionally determine a second access category from the range 3 to 7. If more than one access category matches, the access category of the lowest rule number shall be chosen. The UE shall use the second access category only to derive an RRC establishment cause for the access attempt. |
| NOTE 7: | "EAB override" does not apply, if the UE is not configured to allow overriding EAB (see the "Override_ExtendedAccessBarring" leaf of NAS configuration MO in 3GPP TS 24.368 [17] or 3GPP TS 31.102 [22]), or if NAS has not received an indication from the upper layers to override EAB and the UE does not have a PDU session that was established with EAB override. |
| NOTE 8: | For the definition of categories a, b and c associated with access category 1, see 3GPP TS 22.261 [3]. The categories associated with access category 1 are distinct from the categories a, b and c associated with EAB (see 3GPP TS 22.011 [1A]). |

[TS 24.501, clause 4.5.4.1]

When the UE is in 5GMM-IDLE mode, upon receiving a request from the upper layers for an access attempt, the NAS shall categorize the access attempt into access identities and an access category following subclause 4.5.2, table 4.5.2.1 and table 4.5.2.2, and subclause 4.5.3, and provide the applicable access identities and the access category to the lower layers for the purpose of access control checking. In this request to the lower layer the NAS can also provide to the lower layer the RRC establishment cause determined as specified in subclause 4.5.6 of this specification.

NOTE 1: The access barring check is performed by the lower layers.

NOTE 2: As an implementation option, the NAS can provide the RRC establishment cause to the lower layers after being informed by the lower layers that the access attempt is allowed.

If the UE has uplink user data pending for one or more PDU sessions when it builds a REGISTRATION REQUEST or SERVICE REQUEST message as initial NAS message, the UE shall indicate the respective PDU sessions in the Uplink data status IE as specified in subclause 5.5.1.3.2 and 5.6.1.2, regardless of the access category for which the access barring check is performed.

NOTE 3: The UE indicates pending user data for all the respective PDU sessions, even if barring timers are running for some of the corresponding access categories.

If the lower layers indicate that the access attempt is allowed, the NAS shall initiate the procedure to send the initial NAS message for the access attempt.

If the lower layers indicate that the access attempt is barred, the NAS shall not initiate the procedure to send the initial NAS message for the access attempt. Additionally:

- a) if the event which triggered the access attempt was an MO-MMTEL-voice-call-started indication or an MO-MMTEL-video-call-started indication:
 - 1) if the UE is operating in the single-registration mode and the UE's usage setting is "voice centric", the UE may attempt to select an E-UTRA cell connected to EPC. If the UE finds a suitable E-UTRA cell connected to EPC, it then proceeds with the appropriate EMM specific procedures and, if necessary, ESM procedures to make a PDN connection providing access to IMS available; see subclause 4.8.2 and 3GPP TS 24.301 [15];
 - 2) if the UE is operating in the dual-registration mode, the UE may proceed in S1 mode with the appropriate EMM specific procedures and ESM procedures to make a PDN connection providing access to IMS available; see subclause 4.8.3 and 3GPP TS 24.301 [15];
 - 3) otherwise, the NAS shall notify the upper layers that the access attempt is barred. In this case, upon receiving an indication from the lower layers that the barring is alleviated for the access category with which the access attempt was associated, the NAS shall notify the upper layers that the barring is alleviated for the access category and may initiate the procedure to send the initial NAS message, if still needed; and
- b) if the event which triggered the access attempt was an MO-SMSoIP-attempt-started indication:

- 1) if the UE is operating in the single-registration mode, the UE may attempt to select an E-UTRA cell connected to EPC. If the UE finds a suitable E-UTRA cell connected to EPC, it then proceeds with the appropriate EMM specific procedures and, if necessary, ESM procedures to make a PDN connection providing access to IMS available; see subclause 4.8.2 and 3GPP TS 24.301 [15];
- 2) if the UE is operating in the dual-registration mode, the UE may proceed in S1 mode with the appropriate EMM specific procedures and ESM procedures to make a PDN connection providing access to IMS available; see subclause 4.8.3 and 3GPP TS 24.301 [15];
- 3) otherwise, the NAS layer shall notify the upper layers that the access attempt is barred. In this case, upon receiving an indication from the lower layers that the barring is alleviated for the access category with which the access attempt was associated, the NAS shall notify the upper layers that the barring is alleviated for the access category and may initiate the procedure to send the initial NAS message, if still needed.

NOTE 4: Barring timers, on a per access category basis, are run by the lower layers. At expiry of barring timers, the indication of alleviation of access barring is indicated to the NAS on a per access category basis.

[TS 24.501, clause 4.5.4.2]

When the UE is in 5GMM-CONNECTED mode or 5GMM-CONNECTED mode with RRC inactive indication, upon detecting one of events 1) through 6) listed in subclause 4.5.1, the NAS shall categorize the corresponding access attempt into access identities and an access category following subclause 4.5.2, table 4.5.2.1 and table 4.5.2.2, and subclause 4.5.2.3, and provide the access identities and the access category to the lower layers for the purpose of access control checking. In this request to the lower layer the NAS can also provide to the lower layer the RRC establishment cause determined as specified in subclause 4.5.6 of this specification.

NOTE 1: As an implementation option, the NAS can provide the RRC establishment cause to the lower layers after being informed by the lower layers that the access attempt is allowed.

If the UE has uplink user data pending for one or more PDU sessions when it builds a REGISTRATION REQUEST or SERVICE REQUEST message for the access attempt, the UE shall indicate the respective PDU sessions in the Uplink data status IE as specified in subclause 5.5.1.3.2 and 5.6.1.2, regardless of the access category for which the access barring check is performed.

NOTE 2: The UE indicates pending user data for all the respective PDU sessions, even if barring timers are running for some of the corresponding access categories.

If the lower layers indicate that the access attempt is allowed, the NAS shall take the following action depending on the event which triggered the access attempt:

- a) if the event which triggered the access attempt was an MO-MMTEL-voice-call-started indication, an MO-MMTEL-video-call-started indication or an MO-SMSoIP-attempt-started indication, the NAS shall notify the upper layers that the access attempt is allowed;
- b) if the event which triggered the access attempt was a request from upper layers to send a mobile originated SMS over NAS, 5GMM shall initiate the NAS transport procedure as specified in subclause 5.4.5 to send the SMS in an UL NAS TRANSPORT message;
- c) if the event which triggered the access attempt was a request from upper layers to establish a new PDU session, 5GMM shall initiate the NAS transport procedure as specified in subclause 5.4.5 to send the PDU SESSION ESTABLISHMENT REQUEST message;
- d) if the event which triggered the access attempt was a request from upper layers to modify an existing PDU session, 5GMM shall initiate the NAS transport procedure as specified in subclause 5.4.5 to send the PDU SESSION MODIFICATION REQUEST message;
- e) if the event which triggered the access attempt was a request to re-establish the user-plane resources for an existing PDU session, 5GMM shall initiate the service request procedure as specified in subclause 5.6.1; and
- f) if the event which triggered the access attempt was an uplink user data packet to be sent for a PDU session with suspended user-plane resources, 5GMM shall consider that the uplink user data packet is allowed to be sent.

If the lower layers indicate that the access attempt is barred, the NAS shall take the following action depending on the event which triggered the access attempt:

- a) if the event which triggered the access attempt was an MO-MMTEL-voice-call-started indication, an MO-MMTEL-video-call-started indication or an MO-SMSoIP-attempt-started indication:
- 1) if the UE is operating in the dual-registration mode, the UE may proceed in S1 mode with the appropriate EMM specific procedures and ESM procedures to make a PDN connection providing access to IMS available; see subclause 4.8.3 and 3GPP TS 24.301 [15];
 - 2) otherwise, the NAS shall notify the upper layers that the access attempt is barred. In this case, upon receiving an indication from the lower layers that the barring is alleviated for the access category with which the access attempt was associated, the NAS shall notify the upper layers that the barring is alleviated for the access category;

NOTE 3: In this case prohibiting the initiation of the MMTEL voice session, MMTEL video session or prohibiting sending of the SMS over IP is performed by the upper layers.

- b) if the event which triggered the access attempt was a request from upper layers to send a mobile originated SMS over NAS, 5GMM shall not initiate the NAS transport procedure as specified in subclause 5.4.5 to send the SMS in an UL NAS TRANSPORT message. Upon receiving an indication from the lower layers that the barring is alleviated for the access category with which the access attempt was associated, 5GMM may initiate the NAS transport procedure as specified in subclause 5.4.5 to send the SMS in an UL NAS TRANSPORT message, if still needed;
- c) if the event which triggered the access attempt was a request from upper layers to establish a new PDU session, 5GMM shall not initiate the NAS transport procedure to send the PDU SESSION ESTABLISHMENT REQUEST message. Upon receiving an indication from the lower layers that the barring is alleviated for the access category with which the access attempt was associated, the NAS may initiate the NAS transport procedure as specified in subclause 5.4.5, if still needed;
- d) if the event which triggered the access attempt was a request from upper layers to modify an existing PDU session modification, 5GMM shall not initiate the NAS transport procedure to send the PDU SESSION MODIFICATION REQUEST message. Upon receiving an indication from the lower layers that the barring is alleviated for the access category with which the access attempt was associated, the NAS may initiate the NAS transport procedure as specified in subclause 5.4.5, if still needed;
- e) if the event which triggered the access attempt was a request to re-establish the user-plane resources for an existing PDU session, the NAS shall not initiate the service request procedure as specified in subclause 5.6.1. Upon receiving an indication from the lower layers that the barring is alleviated for the access category with which the access attempt was associated, the NAS may initiate the service request procedure as specified in subclause 5.6.1, if still needed; and
- f) if the event which triggered the access attempt was an uplink user data packet to be sent for a PDU session with suspended user-plane resources, 5GMM shall consider that the uplink user data packet is not allowed to be sent. Upon receiving an indication from the lower layers that the barring is alleviated for the access category with which the access attempt was associated, the NAS shall consider that the barring is alleviated for the access category.

[TS 24.501, clause 4.5.6]

When 5GMM requests the establishment of a NAS-signalling connection, the RRC establishment cause used by the UE shall be selected according to one or more access identities (see subclause 4.5.2) and the determined access category as specified in table 4.5.6.1 and table 4.5.6.2. If the determined access category is an operator-defined access category, then the RRC establishment cause used by the UE shall be selected according to table 4.5.6.1 and table 4.5.6.2 based on one or more access identities (see subclause 4.5.2) and the standardized access category determined for the operator-defined access category as described in subclause 4.5.3.

Table 4.5.6.1: Mapping table for access identities/access categories and RRC establishment cause when establishing N1 NAS signalling connection via NR connected to 5GCN

| Access identities | Access categories | RRC establishment cause is set to |
|--|-------------------------|-----------------------------------|
| 0 | 0 (= MT_acc) | mt-Access |
| | 1 (= delay tolerant) | Not applicable (NOTE 1) |
| | 2 (= emergency) | emergency |
| | 3 (= MO_sig) | mo-Signalling |
| | 4 (= MO MMTel voice) | mo-VoiceCall |
| | 5 (= MO MMTel video) | mo-VideoCall |
| | 6 (= MO SMS and SMSoIP) | mo-SMS |
| | 7 (= MO_data) | mo-Data |
| 1 | Any category | mps-PriorityAccess |
| 2 | Any category | mcs-PriorityAccess |
| 11, 15 | Any category | highPriorityAccess |
| 12,13,14, | Any category | highPriorityAccess |
| NOTE 1: A UE using access category 1 for the access barring check will determine a second access category in the range 3 to 7 that is to be used for determination of the RRC establishment cause. See subclause 4.5.2, table 4.5.2.2, NOTE 6. | | |
| NOTE 2: See subclause 4.5.2, table 4.5.2.1 for use of the access identities of 0, 1, 2, and 11-15. | | |

Table 4.5.6.2: Mapping table for access identities/access categories and RRC establishment cause when establishing N1 NAS signalling connection via E-UTRA connected to 5GCN

| Access identities | Access categories | RRC establishment cause is set to |
|--|-------------------------|-----------------------------------|
| 0 | 0 (= MT_acc) | mt-Access |
| | 1 (= delay tolerant) | Not applicable (NOTE 1) |
| | 2 (= emergency) | emergency |
| | 3 (= MO_sig) | mo-Signalling |
| | 4 (= MO MMTel voice) | mo-VoiceCall |
| | 5 (= MO MMTel video) | mo-VoiceCall |
| | 6 (= MO SMS and SMSoIP) | mo-Data |
| | 7 (= MO_data) | mo-Data |
| 1 | Any category | highPriorityAccess |
| 2 | Any category | highPriorityAccess |
| 11, 15 | Any category | highPriorityAccess |
| 12,13,14, | Any category | highPriorityAccess |
| NOTE 1: A UE using access category 1 for the access barring check will determine a second access category in the range 3 to 7 that is to be used for determination of the RRC establishment cause. See subclause 4.5.2, table 4.5.2.2, NOTE 6. | | |
| NOTE 2: See subclause 4.5.2, table 4.5.2.1 for use of the access identities of 0, 1, 2, and 11-15. | | |

[TS 38.331, clause 5.3.14.1]

The purpose of this procedure is to perform access barring check for an access attempt associated with a given Access Category and one or more Access Identities upon request from upper layers according to TS 24.501 [23] or the RRC layer.

After a handover resulting in change of PCell in RRC_CONNECTED the UE shall defer access barring checks until it has obtained valid UAC information (from *SIB1*) from the target cell.

[TS 38.331, clause 5.3.14.2]

Upon initiation of the procedure, the UE shall:

- 1> if timer T390 is running for the Access Category:
 - 2> consider the access attempt as barred;
- 1> else if timer T302 is running and the Access Category is neither '2' nor '0':
 - 2> consider the access attempt as barred;

- 1> else:
 - 2> if the Access Category is '0':
 - 3> consider the access attempt as allowed;
 - 2> else:
 - 3> if *SIB1* includes *uac-BarringPerPLMN-List* and the *uac-BarringPerPLMN-List* contains an *UAC-BarringPerPLMN* entry with the *plmn-IdentityIndex* corresponding to the PLMN selected by upper layers (see TS 24.501 [23]):
 - 4> select the *UAC-BarringPerPLMN* entry with the *plmn-IdentityIndex* corresponding to the PLMN selected by upper layers;
 - 4> in the remainder of this procedure, use the selected *UAC-BarringPerPLMN* entry (i.e. presence or absence of access barring parameters in this entry) irrespective of the *uac-BarringForCommon* included in *SIB1*;
 - 3> else if *SIB1* includes *uac-BarringForCommon*:
 - 4> in the remainder of this procedure use the *uac-BarringForCommon* (i.e. presence or absence of these parameters) included in *SIB1*;
 - 3> else:
 - 4> consider the access attempt as allowed;
 - 3> if *uac-BarringForCommon* is applicable or the *uac-ACBarringListType* indicates that *uac-ExplicitACBarringList* is used:
 - 4> if the corresponding *UAC-BarringPerCatList* contains a *UAC-BarringPerCat* entry corresponding to the Access Category:
 - 5> select the *UAC-BarringPerCat* entry;
 - 5> if the *uac-BarringInfoSetList* contains a *UAC-BarringInfoSet* entry corresponding to the selected *uac-barringInfoSetIndex* in the *UAC-BarringPerCat*:
 - 6> select the *UAC-BarringInfoSet* entry;
 - 6> perform access barring check for the Access Category as specified in 5.3.14.5, using the selected *UAC-BarringInfoSet* as "UAC barring parameter";
 - 5> else:
 - 6> consider the access attempt as allowed;
 - 4> else:
 - 5> consider the access attempt as allowed;
 - 3> else if the *uac-ACBarringListType* indicates that *uac-ImplicitACBarringList* is used:
 - 4> select the *uac-BarringInfoSetIndex* corresponding to the Access Category in the *uac-ImplicitACBarringList*;
 - 4> if the *uac-BarringInfoSetList* contains the *UAC-BarringInfoSet* entry corresponding to the selected *uac-BarringInfoSetIndex*:
 - 5> select the *UAC-BarringInfoSet* entry;
 - 5> perform access barring check for the Access Category as specified in 5.3.14.5, using the selected *UAC-BarringInfoSet* as "UAC barring parameter";
 - 4> else:

- 5> consider the access attempt as allowed;
- 3> else:
 - 4> consider the access attempt as allowed;
- 1> if the access barring check was requested by upper layers:
 - 2> if the access attempt is considered as barred:
 - 3> if timer T302 is running:
 - 4> inform the upper layer that access barring is applicable for all access categories except categories '0' and '2', upon which the procedure ends;
 - 3> else:
 - 4> inform upper layers that the access attempt for the Access Category is barred, upon which the procedure ends;
 - 2> else:
 - 3> inform upper layers that the access attempt for the Access Category is allowed, upon which the procedure ends;
- 1> else:
 - 2> the procedure ends.

[TS 38.331, clause 5.3.14.4]

The UE shall:

- 1> if timer T302 expires or is stopped, and if timer T390 corresponding to an Access Category is not running; or
- 1> if timer T390 corresponding to an Access Category other than '2' expires or is stopped, and if timer T302 is not running; or
- 1> if timer T390 corresponding to the Access Category '2' expires or is stopped:
 - 2> consider the barring for this Access Category to be alleviated;
- 1> when barring for an Access Category is considered being alleviated:
 - 2> if the Access Category was informed to upper layers as barred:
 - 3> inform upper layers about barring alleviation for the Access Category.
 - 2> if barring is alleviated for Access Category '8':
 - 3> perform actions specified in 5.3.13.8;

[TS 38.331, clause 5.3.14.5]

The UE shall:

- 1> if one or more Access Identities are indicated according to TS 24.501 [23], and
- 1> if for at least one of these Access Identities the corresponding bit in the *uac-BarringForAccessIdentity* contained in "UAC barring parameter" is set to *zero*:
 - 2> consider the access attempt as allowed;
- 1> else:
 - 2> draw a random number '*rand*' uniformly distributed in the range: $0 \leq rand < 1$;
 - 2> if '*rand*' is lower than the value indicated by *uac-BarringFactor* included in "UAC barring parameter":

3> consider the access attempt as allowed;

2> else:

3> consider the access attempt as barred;

1> if the access attempt is considered as barred:

2> draw a random number '*rand*' that is uniformly distributed in the range $0 \leq rand < 1$;

2> start timer T390 for the Access Category with the timer value calculated as follows, using the *uac-BarringTime* included in "AC barring parameter":

$$T390 = (0.7 + 0.6 * rand) * uac-BarringTime.$$

11.3.1.3 Test description

11.3.1.3.1 Pre-test conditions

System Simulator:

- NR Cell 1.
- Cell power level is selected according to 38.508-1 [4] Table 6.2.2.1-3.
- System information combination NR-1 as defined in TS 38.508-1 [4] Table 4.4.3.1.2-1 is used in NR cell 1.

UE:

- None.

Preamble:

- The UE is in state 3N-A on NR Cell 1 (serving cell) with at least one PDU session active according to TS 38.508-1 [4] Table 4.4A.2-1 and using the message condition UE TEST LOOP MODE B active with IP PDU delay = 1 second according to TS 38.508-1 [4]. DRB 1 is defined as default DRB for the PDU session.

11.3.1.3.2 Test procedure sequence

Table 11.3.1.3.2-1: Main behaviour

| St | Procedure | Message Sequence | | TP | Verdict |
|----|---|------------------|----------------------------------|----|---------|
| | | U - S | Message | | |
| 1 | SS changes SIB1 according to Table 11.3.1.3.3-1 and send Short Message on PDCCH using P-RNTI. Wait for 2.1* modification period to allow the new system information to take effect. | <-- | PDCCH (DCI 1_0): Short Message | - | - |
| 2 | The SS transmits one IP PDU. | - | - | - | - |
| 3 | The SS transmits an <i>RRCRelease</i> message with <i>suspendConfig</i> IE and move the UE to RRC_Inactive state. | <-- | NR RRC: <i>RRCRelease</i> | - | - |
| 4 | Check: Does the UE transmit <i>RRCResumeRequest</i> message including <i>mo-Data</i> as resume cause within 6 s? | --> | NR RRC: <i>RRCResumeRequest</i> | 4 | F |
| 5 | SS changes SIB1 according to Table 11.3.1.3.3-1 and send Short Message on PDCCH using P-RNTI. Wait for the new system information to take effect and T390 expire. (Note 1) | <-- | PDCCH (DCI 1_0): Short Message | - | - |
| 6 | The UE transmits <i>RRCResumeRequest</i> message including <i>mo-Data</i> as resume cause. | --> | NR RRC: <i>RRCResumeRequest</i> | - | - |
| 7 | SS transmits an NR <i>RRCResume</i> message | <-- | NR RRC: <i>RRCResume</i> | - | - |
| 8 | The UE transmits an NR <i>RRCResumeComplete</i> message to confirm the successful completion of the connection resumption. | --> | NR RRC: <i>RRCResumeComplete</i> | - | - |

| | | | | | |
|--|--|-----|--------------------------------|---|---|
| 9 | The UE loop back the IP PDU. | - | - | - | - |
| 10 | The SS transmits DEACTIVATE TEST MODE message. | <-- | DEACTIVATE TEST MODE | - | - |
| 11 | The UE transmits DEACTIVATE TEST MODE COMPLETE message. | --> | DEACTIVATE TEST MODE COMPLETE | - | - |
| 12 | The SS transmits an <i>RRCRelease</i> message to release RRC connection and move the UE to RRC_IDLE. | <-- | NR RRC: <i>RRCRelease</i> | - | - |
| 13 | Make the UE attempt a MMTel voice call. | - | - | - | - |
| 14 | Check: Does the UE transmit <i>RRCSetupRequest</i> message including <i>mo-VoiceCall</i> with within 6 s? | --> | NR RRC: <i>RRCSetupRequest</i> | 1 | F |
| 15 | SS changes <i>SIB1</i> according to Table 11.3.1.3.3-1 and sends Short Message on PDCCH using P-RNTI. Wait for the new system information to take effect and T390 expire. (Note 1) | <-- | PDCCH (DCI 1_0): Short Message | - | - |
| 16 | Make the UE attempt another MO MTSI MMTEL Voice session. | - | - | - | - |
| 17 | Check: Does the UE send NR <i>RRCSetupRequest</i> with <i>EstablishmentCause</i> set to ' <i>mo-VoiceCall</i> '? | --> | NR RRC: <i>RRCSetupRequest</i> | 2 | P |
| 18-28 | Step3 to step13 from test procedure for IMS MO speech call establishment as described in TS 38.508-1 [4] Table 4.9.15.2.2-1 take place, | - | - | - | - |
| 29-31 | Step1 to step3 from test procedure for test procedure for IMS MO speech call release as described in TS 38.508-1 [4] Table 4.9.17.2.2-1 take place, | - | - | - | - |
| 32 | AT command to make the UE attempt to send SMS over IP | - | - | - | - |
| 33 | Check: Does the UE transmit an <i>RRCSetupRequest</i> message with ' <i>establishmentCause</i> ' set to ' <i>mo-Data</i> '? | --> | NR RRC: <i>RRCSetupRequest</i> | 3 | F |
| 34 | SS changes <i>SIB1</i> according to Table 11.3.1.3.3-1 and sends Short Message on PDCCH using P-RNTI. Wait for the new system information to take effect and T390 expire. (Note 1) | <-- | PDCCH (DCI 1_0): Short Message | - | - |
| 35 | AT command to make the UE attempt to send another SMS over IP | - | - | - | - |
| 36-49 | Steps 2-15 from generic procedure IMS MO SMS in 5GS as described in TS 38.508-1 [4] Table 4.9.19.2.2-1 take place. | - | - | - | - |
| Note 1: T390 is a random value between $(0.7 + 0.6 * 0) * \text{uac-BarringTime}(16\text{s}) = 11.2\text{s}$ and $(0.7 + 0.6 * 1) * \text{uac-BarringTime}(16\text{s}) = 20.8\text{s}$. | | | | | |

11.3.1.3.3 Specific message contents

Table 11.3.1.3.3-1: *SIB1* of NR Cell 1 (All steps, Table 11.3.1.3.2-1)

| Derivation Path: TS 38.508-1 [4], Table 4.6.1-28 | | | |
|--|--------------|--|-----------|
| Information Element | Value/remark | Comment | Condition |
| SIB1 ::= SEQUENCE { | | | |
| uac-BarringInfo SEQUENCE { | | | |
| uac-BarringForCommon SEQUENCE (SIZE(1..maxAccessCat-1)) OF UAC-BarringPerCat { | 1 entry | | |
| UAC-BarringPerCat[1] SEQUENCE { | | entry 1 | |
| accessCategory | 7 | (= MO_data) | Step 1 |
| | 4 | (= MO MMTel voice) | Step 5 |
| | 6 | (= MO SMS and SMSoIP) | Step 15 |
| uac-barringInfoSetIndex | 1 | Value 1 corresponds to the first entry in uac-BarringInfoSetList | |
| } | | | |
| } | | | |
| uac-BarringPerPLMN-List | Not present | | |
| uac-BarringInfoSetList SEQUENCE (SIZE(1..maxBarringInfoSet)) OF UAC-BarringInfoSet { | 1 entry | | |
| UAC-BarringInfoSet[1] SEQUENCE { | | entry 1 | |
| uac-BarringFactor | p00 | 0% access probability | |
| uac-BarringTime | s16 | 16 s | |
| } | | | |
| } | | | |
| uac-AccessCategory1-SelectionAssistanceInfo | Not Present | | |
| } | | | |
| uac-BarringInfo | Not present | | Step 34 |
| } | | | |

11.3.2 UAC / Access Identity 0 / 0% access probability / Paging for MT Access/Emergency Call

11.3.2.1 Test Purpose (TP)

(1)

```

with { UE not configured for special AIs (1,2,11-15) having received a SIB1 message indicating 0%
accessibility for all Access Categories in NR RRC_Idle state }
ensure that {
  when { UE is paged for MT access }
  then { UE does not consider the access as barred and initiates RRC Connection }
}

```

(2)

```

with { UE not configured for special AIs (1,2,11-15) having received a SIB1 message including UAC
Info set to 0% accessibility for Access Category 2 in NR RRC_Idle state }
ensure that {
  when { UE attempts emergency call }
  then { UE does not initiate emergency call }
}

```

(3)

```

with { UE not configured for special AIs (1,2,11-15) with T302 running but T390 expired for Access
Category 2 and with SIB1 including UAC Info indicating 100% accessibility for Access Category 2 in
NR RRC_IDLE state }
ensure that {

```

```

when { UE attempts emergency call }
then { UE does not consider the access attempt as barred and initiates the emergency call }
}

```

11.3.2.2 Conformance requirements

References: The conformance requirements covered in the present TC are specified in TS 24.501: clause 4.5.2, 4.5.4.1 and 4.5.6 and TS 38.331: clause 5.3.14.1, 5.3.14.2, 5.3.14.4 and 5.3.14.5. Unless otherwise stated these are Rel-15 requirements.

[TS 24.501, clause 4.5.2]

When the UE needs to initiate an access attempt in one of the events listed in subclause 4.5.1, the UE shall determine one or more access identities from the set of standardized access identities, and one access category from the set of standardized access categories and operator-defined access categories, to be associated with that access attempt.

The set of the access identities applicable for the request is determined by the UE in the following way:

- a) for each of the access identities 1, 2, 11, 12, 13, 14 and 15 in table 4.5.2.1, the UE shall check whether the access identity is applicable in the selected PLMN, if a new PLMN is selected, or otherwise if it is applicable in the RPLMN or equivalent PLMN; and
- b) if none of the above access identities is applicable, then access identity 0 is applicable.

Table 4.5.2.1: Access identities

| Access Identity number | UE configuration |
|--|--|
| 0 | UE is not configured with any parameters from this table |
| 1 (NOTE 1) | UE is configured for multimedia priority service (MPS). |
| 2 (NOTE 2) | UE is configured for mission critical service (MCS). |
| 3-10 | Reserved for future use |
| 11 (NOTE 3) | Access Class 11 is configured in the UE. |
| 12 (NOTE 3) | Access Class 12 is configured in the UE. |
| 13 (NOTE 3) | Access Class 13 is configured in the UE. |
| 14 (NOTE 3) | Access Class 14 is configured in the UE. |
| 15 (NOTE 3) | Access Class 15 is configured in the UE. |
| <p>NOTE 1: Access identity 1 is valid when:</p> <ul style="list-style-type: none"> - the USIM file EFUAC_AIC indicates the UE is configured for access identity 1 and the RPLMN is the HPLMN (if the EHPLMN list is not present or is empty) or EHPLMN (if the EHPLMN list is present), or a visited PLMN of the home country (see the definition of home country in 3GPP TS 24.301 [15]); or - the UE receives the 5GS network feature support IE with the MPS indicator bit set to "Access identity 1 valid in RPLMN or equivalent PLMN" from the RPLMN as described in subclause 5.5.1.2.4 and subclause 5.5.1.3.4. <p>NOTE 2: Access identity 2 is used by UEs configured for MCS and is valid when:</p> <ul style="list-style-type: none"> - the USIM file EFUAC_AIC indicates the UE is configured for access identity 2 and the RPLMN is the HPLMN (if the EHPLMN list is not present or is empty) or EHPLMN (if the EHPLMN list is present), or a visited PLMN of the home country (see 3GPP TS 23.122 [5]); or - the UE receives the 5GS network feature support IE with the MCS indicator bit set to "Access identity 2 valid in RPLMN or equivalent PLMN" from the RPLMN as described in subclause 5.5.1.2.4 and subclause 5.5.1.3.4. <p>NOTE 3: Access identities 11 and 15 are valid in HPLMN (if the EHPLMN list is not present or is empty) or EHPLMN (if the EHPLMN list is present). Access Identities 12, 13 and 14 are valid in HPLMN and visited PLMNs of home country only (see the definition of home country in 3GPP TS 24.301 [15]).</p> | |

The UE uses the MPS indicator bit of the 5GS network feature support IE to determine if access identity 1 is valid. Processing of the MPS indicator bit of the 5GS network feature support IE in the REGISTRATION ACCEPT message is described in subclause 5.5.1.2.4 and subclause 5.5.1.3.4. The UE shall not consider access identity 1 to be valid when the UE is not in the country of its HPLMN prior to receiving the MPS indicator bit of the 5GS network feature support IE in the REGISTRATION ACCEPT message being set to "Access identity 1 valid in RPLMN or equivalent PLMN".

When the UE is in the country of its HPLMN, the contents of the USIM files EF_{UAC_AIC} and EF_{ACC} as specified in 3GPP TS 31.102 [22] and the rules specified in table 4.5.2.1 are used to determine the applicability of access identity 1 and access classes 11 - 15. When the UE is in the country of its HPLMN, and the USIM file EF_{UAC_AIC} does not indicate

the UE is configured for access identity 1, the UE uses the MPS indicator bit of the 5GS network feature support IE in the REGISTRATION ACCEPT message to determine if access identity 1 is valid. When the UE is in the country of its HPLMN, and the USIM file EF_{UAC_AIC} indicates the UE is configured for access identity 1, the MPS indicator bit of the 5GS network feature support IE is not applicable. When the UE is not in the country of its HPLMN, the contents of the USIM files EF_{UAC_AIC} and EF_{ACC} are not applicable.

The UE uses the MCS indicator bit of the 5GS network feature support IE to determine if access identity 2 is valid. Processing of the MCS indicator bit of the 5GS network feature support IE in the REGISTRATION ACCEPT message is described in subclause 5.5.1.2.4 and subclause 5.5.1.3.4. The UE shall not consider access identity 2 to be valid when the UE is not in the country of its HPLMN prior to receiving the MCS indicator bit of the 5GS network feature support IE in the REGISTRATION ACCEPT message being set to "Access identity 2 valid in RPLMN or equivalent PLMN".

When the UE is in the country of its HPLMN, the contents of the USIM files EF_{UAC_AIC} and EF_{ACC} as specified in 3GPP TS 31.102 [22] and the rules specified in table 4.5.2.1 are used to determine the applicability of access identity 2 and access classes 11 - 15. When the UE is in the country of its HPLMN, and the USIM file EF_{UAC_AIC} does not indicate the UE is configured for access identity 2, the UE uses the MCS indicator bit of the 5GS network feature support IE in the REGISTRATION ACCEPT message to determine if access identity 2 is valid. When the UE is in the country of its HPLMN, and the USIM file EF_{UAC_AIC} indicates the UE is configured for access identity 2, the MCS indicator bit of the 5GS network feature support IE is not applicable. When the UE is not in the country of its HPLMN, the contents of the USIM files EF_{UAC_AIC} and EF_{ACC} are not applicable.

In order to determine the access category applicable for the access attempt, the NAS shall check the rules in table 4.5.2.2, and use the access category for which there is a match for barring check. If the access attempt matches more than one rule, the access category of the lowest rule number shall be selected. If the access attempt matches more than one operator-defined access category definition, the UE shall select the access category from the operator-defined access category definition with the lowest precedence value (see subclause 4.5.3).

NOTE: The case when an access attempt matches more than one rule includes the case when multiple events trigger an access attempt at the same time.

Table 4.5.2.2: Mapping table for access categories

| Rule # | Type of access attempt | Requirements to be met | Access Category |
|--------|--|--|---|
| 1 | Response to paging or NOTIFICATION over non-3GPP access; 5GMM connection management procedure initiated for the purpose of transporting an LPP message | Access attempt is for MT access | 0 (= MT_acc) |
| 2 | Emergency | UE is attempting access for an emergency session (NOTE 1, NOTE 2) | 2 (= emergency) |
| 3 | Access attempt for operator-defined access category | UE stores operator-defined access category definitions valid in the current PLMN as specified in subclause 4.5.3, and access attempt is matching criteria of an operator-defined access category definition | 32-63
(= based on operator classification) |
| 4 | Access attempt for delay tolerant service | (a) UE is configured for NAS signalling low priority or UE supporting S1 mode is configured for EAB (see the "ExtendedAccessBarring" leaf of NAS configuration MO in 3GPP TS 24.368 [17] or 3GPP TS 31.102 [22]) where "EAB override" does not apply, and
(b).the UE received one of the categories a, b or c as part of the parameters for unified access control in the broadcast system information, and the UE is a member of the broadcasted category in the selected PLMN or RPLMN/equivalent PLMN (NOTE 3, NOTE 5, NOTE 6, NOTE 7, NOTE 8) | 1 (= delay tolerant) |
| 5 | MO MMTel voice call | Access attempt is for MO MMTel voice call or for NAS signalling connection recovery | 4 (= MO MMTel voice) |

| | | | |
|---|--|---|-------------------------|
| | | during ongoing MO MMTel voice call (NOTE 2) | |
| 6 | MO MMTel video call | Access attempt is for MO MMTel video call or for NAS signalling connection recovery during ongoing MO MMTel video call (NOTE 2) | 5 (= MO MMTel video) |
| 7 | MO SMS over NAS or MO SMSoIP | Access attempt is for MO SMS over NAS (NOTE 4) or MO SMS over SMSoIP transfer or for NAS signalling connection recovery during ongoing MO SMS or SMSoIP transfer (NOTE 2) | 6 (= MO SMS and SMSoIP) |
| 8 | UE NAS initiated 5GMM specific procedures | Access attempt is for MO signalling | 3 (= MO_sig) |
| 9 | UE NAS initiated 5GMM connection management procedure or 5GMM NAS transport procedure | Access attempt is for MO data | 7 (= MO_data) |
| 10 | An uplink user data packet is to be sent for a PDU session with suspended user-plane resources | No further requirement is to be met | 7 (= MO_data) |
| <p>NOTE 1: This includes 5GMM specific procedures while the service is ongoing and 5GMM connection management procedures required to establish a PDU session with request type = "initial emergency request" or "existing emergency PDU session", or to re-establish user-plane resources for such a PDU session. This further includes the service request procedure initiated with a SERVICE REQUEST message with the Service type IE set to "emergency services fallback".<</p> <p>NOTE 2: Access for the purpose of NAS signalling connection recovery during an ongoing service, or for the purpose of NAS signalling connection establishment following fallback indication from lower layers during an ongoing service, is mapped to the access category of the ongoing service in order to derive an RRC establishment cause, but barring checks will be skipped for this access attempt.</p> <p>NOTE 3: If the UE selects a new PLMN, then the selected PLMN is used to check the membership; otherwise the UE uses the RPLMN or a PLMN equivalent to the RPLMN.</p> <p>NOTE 4: This includes the 5GMM connection management procedures triggered by the UE-initiated NAS transport procedure for transporting the MO SMS.</p> <p>NOTE 5: The UE configured for NAS signalling low priority is not supported in this release of specification. If a UE supporting both S1 mode and N1 mode is configured for NAS signalling low priority in S1 mode as specified in 3GPP TS 24.368 [17] or 3GPP TS 31.102 [22], the UE shall ignore the configuration for NAS signalling low priority when in N1 mode.</p> <p>NOTE 6: If the access category applicable for the access attempt is 1, then the UE shall additionally determine a second access category from the range 3 to 7. If more than one access category matches, the access category of the lowest rule number shall be chosen. The UE shall use the second access category only to derive an RRC establishment cause for the access attempt.</p> <p>NOTE 7: "EAB override" does not apply, if the UE is not configured to allow overriding EAB (see the "Override_ExtendedAccessBarring" leaf of NAS configuration MO in 3GPP TS 24.368 [17] or 3GPP TS 31.102 [22]), or if NAS has not received an indication from the upper layers to override EAB and the UE does not have a PDU session that was established with EAB override.</p> <p>NOTE 8: For the definition of categories a, b and c associated with access category 1, see 3GPP TS 22.261 [3]. The categories associated with access category 1 are distinct from the categories a, b and c associated with EAB (see 3GPP TS 22.011 [1A]).</p> | | | |

[TS 24.501, clause 4.5.4.1]

When the UE is in 5GMM-IDLE mode, upon receiving a request from the upper layers for an access attempt, the NAS shall categorize the access attempt into access identities and an access category following subclause 4.5.2, table 4.5.2.1 and table 4.5.2.2, and subclause 4.5.3, and provide the applicable access identities and the access category to the lower layers for the purpose of access control checking. In this request to the lower layer the NAS can also provide to the lower layer the RRC establishment cause determined as specified in subclause 4.5.6 of this specification.

NOTE 1: The access barring check is performed by the lower layers.

NOTE 2: As an implementation option, the NAS can provide the RRC establishment cause to the lower layers after being informed by the lower layers that the access attempt is allowed.

If the UE has uplink user data pending for one or more PDU sessions when it builds a REGISTRATION REQUEST or SERVICE REQUEST message as initial NAS message, the UE shall indicate the respective PDU sessions in the Uplink data status IE as specified in subclause 5.5.1.3.2 and 5.6.1.2, regardless of the access category for which the access barring check is performed.

NOTE 3: The UE indicates pending user data for all the respective PDU sessions, even if barring timers are running for some of the corresponding access categories.

If the lower layers indicate that the access attempt is allowed, the NAS shall initiate the procedure to send the initial NAS message for the access attempt.

If the lower layers indicate that the access attempt is barred, the NAS shall not initiate the procedure to send the initial NAS message for the access attempt. Additionally:

- a) if the event which triggered the access attempt was an MO-MMTEL-voice-call-started indication or an MO-MMTEL-video-call-started indication:
 - 1) if the UE is operating in the single-registration mode and the UE's usage setting is "voice centric", the UE may attempt to select an E-UTRA cell connected to EPC. If the UE finds a suitable E-UTRA cell connected to EPC, it then proceeds with the appropriate EMM specific procedures and, if necessary, ESM procedures to make a PDN connection providing access to IMS available; see subclause 4.8.2 and 3GPP TS 24.301 [15];
 - 2) if the UE is operating in the dual-registration mode, the UE may proceed in S1 mode with the appropriate EMM specific procedures and ESM procedures to make a PDN connection providing access to IMS available; see subclause 4.8.3 and 3GPP TS 24.301 [15];
 - 3) otherwise, the NAS shall notify the upper layers that the access attempt is barred. In this case, upon receiving an indication from the lower layers that the barring is alleviated for the access category with which the access attempt was associated, the NAS shall notify the upper layers that the barring is alleviated for the access category and may initiate the procedure to send the initial NAS message, if still needed; and
- b) if the event which triggered the access attempt was an MO-SMSoIP-attempt-started indication:
 - 1) if the UE is operating in the single-registration mode, the UE may attempt to select an E-UTRA cell connected to EPC. If the UE finds a suitable E-UTRA cell connected to EPC, it then proceeds with the appropriate EMM specific procedures and, if necessary, ESM procedures to make a PDN connection providing access to IMS available; see subclause 4.8.2 and 3GPP TS 24.301 [15];
 - 2) if the UE is operating in the dual-registration mode, the UE may proceed in S1 mode with the appropriate EMM specific procedures and ESM procedures to make a PDN connection providing access to IMS available; see subclause 4.8.3 and 3GPP TS 24.301 [15];
 - 3) otherwise, the NAS layer shall notify the upper layers that the access attempt is barred. In this case, upon receiving an indication from the lower layers that the barring is alleviated for the access category with which the access attempt was associated, the NAS shall notify the upper layers that the barring is alleviated for the access category and may initiate the procedure to send the initial NAS message, if still needed.

NOTE 4: Barring timers, on a per access category basis, are run by the lower layers. At expiry of barring timers, the indication of alleviation of access barring is indicated to the NAS on a per access category basis.

[TS 24.501, clause 4.5.6]

When 5GMM requests the establishment of a NAS-signalling connection, the RRC establishment cause used by the UE shall be selected according to one or more access identities (see subclause 4.5.2) and the determined access category as specified in table 4.5.6.1 and table 4.5.6.2. If the determined access category is an operator-defined access category, then the RRC establishment cause used by the UE shall be selected according to table 4.5.6.1 and table 4.5.6.2 based on one or more access identities (see subclause 4.5.2) and the standardized access category determined for the operator-defined access category as described in subclause 4.5.3.

Table 4.5.6.1: Mapping table for access identities/access categories and RRC establishment cause when establishing N1 NAS signalling connection via NR connected to 5GCN

| Access identities | Access categories | RRC establishment cause is set to |
|--|-------------------------|-----------------------------------|
| 0 | 0 (= MT_acc) | mt-Access |
| | 1 (= delay tolerant) | Not applicable (NOTE 1) |
| | 2 (= emergency) | emergency |
| | 3 (= MO_sig) | mo-Signalling |
| | 4 (= MO MMTel voice) | mo-VoiceCall |
| | 5 (= MO MMTel video) | mo-VideoCall |
| | 6 (= MO SMS and SMSoIP) | mo-SMS |
| | 7 (= MO_data) | mo-Data |
| 1 | Any category | mps-PriorityAccess |
| 2 | Any category | mcs-PriorityAccess |
| 11, 15 | Any category | highPriorityAccess |
| 12,13,14, | Any category | highPriorityAccess |
| NOTE 1: A UE using access category 1 for the access barring check will determine a second access category in the range 3 to 7 that is to be used for determination of the RRC establishment cause. See subclause 4.5.2, table 4.5.2.2, NOTE 6. | | |
| NOTE 2: See subclause 4.5.2, table 4.5.2.1 for use of the access identities of 0, 1, 2, and 11-15. | | |

Table 4.5.6.2: Mapping table for access identities/access categories and RRC establishment cause when establishing N1 NAS signalling connection via E-UTRA connected to 5GCN

| Access identities | Access categories | RRC establishment cause is set to |
|--|-------------------------|-----------------------------------|
| 0 | 0 (= MT_acc) | mt-Access |
| | 1 (= delay tolerant) | Not applicable (NOTE 1) |
| | 2 (= emergency) | emergency |
| | 3 (= MO_sig) | mo-Signalling |
| | 4 (= MO MMTel voice) | mo-VoiceCall |
| | 5 (= MO MMTel video) | mo-VoiceCall |
| | 6 (= MO SMS and SMSoIP) | mo-Data |
| | 7 (= MO_data) | mo-Data |
| 1 | Any category | highPriorityAccess |
| 2 | Any category | highPriorityAccess |
| 11, 15 | Any category | highPriorityAccess |
| 12,13,14, | Any category | highPriorityAccess |
| NOTE 1: A UE using access category 1 for the access barring check will determine a second access category in the range 3 to 7 that is to be used for determination of the RRC establishment cause. See subclause 4.5.2, table 4.5.2.2, NOTE 6. | | |
| NOTE 2: See subclause 4.5.2, table 4.5.2.1 for use of the access identities of 0, 1, 2, and 11-15. | | |

[TS 38.331, clause 5.3.14.1]

The purpose of this procedure is to perform access barring check for an access attempt associated with a given Access Category and one or more Access Identities upon request from upper layers according to TS 24.501 [23] or the RRC layer.

After a handover resulting in change of PCell in RRC_CONNECTED the UE shall defer access barring checks until it has obtained valid UAC information (from *SIB1*) from the target cell.

[TS 38.331, clause 5.3.14.2]

Upon initiation of the procedure, the UE shall:

- 1> if timer T390 is running for the Access Category:
 - 2> consider the access attempt as barred;
- 1> else if timer T302 is running and the Access Category is neither '2' nor '0':
 - 2> consider the access attempt as barred;

- 1> else:
 - 2> if the Access Category is '0':
 - 3> consider the access attempt as allowed;
 - 2> else:
 - 3> if *SIB1* includes *uac-BarringPerPLMN-List* and the *uac-BarringPerPLMN-List* contains an *UAC-BarringPerPLMN* entry with the *plmn-IdentityIndex* corresponding to the PLMN selected by upper layers (see TS 24.501 [23]):
 - 4> select the *UAC-BarringPerPLMN* entry with the *plmn-IdentityIndex* corresponding to the PLMN selected by upper layers;
 - 4> in the remainder of this procedure, use the selected *UAC-BarringPerPLMN* entry (i.e. presence or absence of access barring parameters in this entry) irrespective of the *uac-BarringForCommon* included in *SIB1*;
 - 3> else if *SIB1* includes *uac-BarringForCommon*:
 - 4> in the remainder of this procedure use the *uac-BarringForCommon* (i.e. presence or absence of these parameters) included in *SIB1*;
 - 3> else:
 - 4> consider the access attempt as allowed;
 - ...
- 1> if the access barring check was requested by upper layers:
 - 2> if the access attempt is considered as barred:
 - 3> if timer T302 is running:
 - 4> inform the upper layer that access barring is applicable for all access categories except categories '0' and '2', upon which the procedure ends;
 - 3> else:
 - 4> inform upper layers that the access attempt for the Access Category is barred, upon which the procedure ends;
 - 2> else:
 - 3> inform upper layers that the access attempt for the Access Category is allowed, upon which the procedure ends;
- 1> else:
 - 2> the procedure ends.

[TS 38.331, clause 5.3.14.4]

The UE shall:

- 1> if timer T302 expires or is stopped, and if timer T390 corresponding to an Access Category is not running; or
- 1> if timer T390 corresponding to an Access Category other than '2' expires or is stopped, and if timer T302 is not running; or
- 1> if timer T390 corresponding to the Access Category '2' expires or is stopped:
 - 2> consider the barring for this Access Category to be alleviated;
- 1> when barring for an Access Category is considered being alleviated:

- 2> if the Access Category was informed to upper layers as barred:
 - 3> inform upper layers about barring alleviation for the Access Category.
- 2> if barring is alleviated for Access Category '8':
 - 3> perform actions specified in 5.3.13.8;

[TS 38.331, clause 5.3.14.5]

The UE shall:

- 1> if one or more Access Identities are indicated according to TS 24.501 [23], and
- 1> if for at least one of these Access Identities the corresponding bit in the *uac-BarringForAccessIdentity* contained in "UAC barring parameter" is set to *zero*:
 - 2> consider the access attempt as allowed;
- 1> else:
 - 2> draw a random number '*rand*' uniformly distributed in the range: $0 \leq rand < 1$;
 - 2> if '*rand*' is lower than the value indicated by *uac-BarringFactor* included in "UAC barring parameter":
 - 3> consider the access attempt as allowed;
 - 2> else:
 - 3> consider the access attempt as barred;
- 1> if the access attempt is considered as barred:
 - 2> draw a random number '*rand*' that is uniformly distributed in the range $0 \leq rand < 1$;
 - 2> start timer T390 for the Access Category with the timer value calculated as follows, using the *uac-BarringTime* included in "AC barring parameter":

$$T390 = (0.7 + 0.6 * rand) * uac-BarringTime.$$

11.3.2.3 Test description

11.3.2.3.1 Pre-test conditions

System Simulator:

- NR Cell 1.
- System information combination NR-1 as defined in TS 38.508-1 [4] Table 4.4.3.1.2-1 is used in NR cell 1 with SIB 1 modified as per Table 11.3.2.3.3-1.

UE:

- None.

Preamble:

- The UE is brought to state 1N-A, RRC_IDLE Connectivity (NR), in accordance with the procedure described in TS 38.508-1 [4], Table 4.5.2.2-2.

11.3.2.3.2 Test procedure sequence

Table 11.3.2.3.2-1: Main behaviour

| St | Procedure | Message Sequence | | TP | Verdict |
|--|--|------------------|---------------------------------|----|---------|
| | | U - S | Message | | |
| 1 | Make the UE attempt an emergency call dialling a number which is stored on the ME (e.g. 112 or 911). (Note 1) | - | - | - | - |
| 2 | Check: Does the UE transmit an <i>RRCSetupRequest</i> message with <i>establishmentCause</i> set to 'emergency' within 30 s? | --> | NR RRC: <i>RRCSetupRequest</i> | 2 | F |
| 3 | SS changes <i>SIB1</i> according to Table 11.3.2.3.3-2 and sends Short Message on PDCCH using P-RNTI. Wait for 2.1* modification period to allow the new system information to take effect and T390 expire. (Note 1) | <-- | PDCCH (DCI 1_0): Short Message | - | - |
| 4 | The SS transmits a <i>Paging</i> message including a matched ng-5G-S-TMSI. | <-- | NR RRC: <i>Paging</i> | - | - |
| 5 | Check: Does the UE transmit an <i>RRCSetupRequest</i> message with <i>establishmentCause</i> set to 'mt-access' ? | --> | NR RRC: <i>RRCSetupRequest</i> | 1 | P |
| 6-12 | Steps 3 to 9a1 of the generic test procedure in TS 38.508-1 [4] Table 4.9.4.2.2-1 are performed on NR Cell 1. | - | - | - | - |
| 13 | SS changes <i>SIB1</i> according to 38.508-1 [4] Table 4.6.1-28 and sends Short Message on PDCCH using P-RNTI. Wait for 2.1* modification period to allow the new system information to take effect. | <-- | PDCCH (DCI 1_0): Short Message | - | - |
| 14-15 | Steps 1-2 of the NR RRC_CONNECTED procedure in table 4.5.4.2-3 in TS 38.508-1[4] are performed. | - | - | - | - |
| 16 | The SS responds with <i>RRCReject</i> message with IE <i>waitTime</i> set to 16s(T302). | <-- | NR RRC: <i>RRCReject</i> | - | - |
| 17 | Make the UE attempt an emergency call dialling a number which is stored on the ME (e.g. 112 or 911), before the T302 timer expires. | - | - | - | - |
| 18 | Check: Does the UE transmit an <i>RRCSetupRequest</i> message with <i>establishmentCause</i> set to 'emergency' (Note 2)? | --> | NR RRC: <i>RRCSetupRequest</i> | 3 | P |
| 19 | The SS transmits an <i>RRCSetup</i> message. | <-- | NR RRC: <i>RRCSetup</i> | - | - |
| 20 | The UE transmits an <i>RRCSetupComplete</i> message. | --> | NR RRC: <i>RRCSetupComplete</i> | - | - |
| 21 | SS transmits an <i>RRCRelease</i> message to release RRC connection and move the UE to RRC_IDLE. | <-- | NR RRC: <i>RRCRelease</i> | - | - |
| <p>Note 1: T390 is a random value between $(0.7 + 0.6 * 0) * \text{uac-BarringTime}(4\text{s}) = 2.8\text{s}$ and $(0.7 + 0.6 * 1) * \text{uac-BarringTime}(4\text{s}) = 5.2\text{s}$, which will start after UE attempts an emergency call.</p> <p>Note2: The emergency call dialling and UE <i>RRCsetupRequest</i> message should be initiated before T302 timer expires.</p> | | | | | |

11.3.2.3.3 Specific message contents

Table 11.3.2.3.3-1: *SIB1* for NR Cell 1 (Preamble, table 11.3.2.3.2-1)

| Derivation Path: TS 38.508-1 [4], Table 4.6.1-28 | | | |
|--|--------------|---------|-----------|
| Information Element | Value/remark | Comment | Condition |
| SIB1 ::= SEQUENCE { | | | |
| uac-BarringInfo SEQUENCE { | | | |
| uac-BarringForCommon SEQUENCE (SIZE (1..maxAccessCat-1)) OF UAC-BarringPerCat { | 1 entry | | |
| UAC-BarringPerCat[1] SEQUENCE { | | entry 1 | |
| accessCategory | 2 | | |
| uac-barringInfoSetIndex | 1 | | |
| } | | | |
| } | | | |
| uac-BarringPerPLMN-List | Not present | | |
| uac-BarringInfoSetList SEQUENCE (SIZE(1..maxBarringInfoSet)) OF UAC-BarringInfoSet { | 1 entry | | |
| UAC-BarringInfoSet[1] SEQUENCE { | | entry 1 | |
| uac-BarringFactor | p00 | | |
| uac-BarringTime | s4 | | |
| uac-BarringForAccessIdentity | '0000000'B | | |
| } | | | |
| } | | | |
| uac-AccessCategory1-SelectionAssistanceInfo | Not Present | | |
| } | | | |
| } | | | |

Table 11.3.2.3.3-2: *SIB1* for NR Cell 1 (Step3, Table 11.3.2.3.2-1)

| Derivation Path: TS 38.508-1 [4], Table 4.6.1-28 | | | |
|--|--------------|---------|-----------|
| Information Element | Value/remark | Comment | Condition |
| SIB1 ::= SEQUENCE { | | | |
| uac-BarringInfo SEQUENCE { | | | |
| uac-BarringForCommon SEQUENCE (SIZE (1..maxAccessCat-1)) OF UAC-BarringPerCat { | 8 entries | | |
| UAC-BarringPerCat[1] SEQUENCE { | | entry 1 | |
| UAC-BarringPerCat[2] SEQUENCE { | | entry 2 | |
| accessCategory | 1 | | |
| uac-barringInfoSetIndex | 1 | | |
| } | | | |
| UAC-BarringPerCat[3] SEQUENCE { | | entry 3 | |
| accessCategory | 2 | | |
| uac-barringInfoSetIndex | 1 | | |
| } | | | |
| UAC-BarringPerCat[4] SEQUENCE { | | entry 4 | |
| accessCategory | 3 | | |
| uac-barringInfoSetIndex | 1 | | |
| } | | | |
| UAC-BarringPerCat[5] SEQUENCE { | | entry 5 | |
| accessCategory | 4 | | |
| uac-barringInfoSetIndex | 1 | | |
| } | | | |
| UAC-BarringPerCat[6] SEQUENCE { | | entry 6 | |
| accessCategory | 5 | | |
| uac-barringInfoSetIndex | 1 | | |
| } | | | |
| UAC-BarringPerCat[7] SEQUENCE { | | entry 7 | |
| accessCategory | 6 | | |
| uac-barringInfoSetIndex | 1 | | |
| } | | | |
| UAC-BarringPerCat[8] SEQUENCE { | | entry 8 | |
| accessCategory | 7 | | |
| uac-barringInfoSetIndex | 1 | | |
| } | | | |
| } | | | |
| uac-BarringPerPLMN-List | Not present | | |
| uac-BarringInfoSetList ::= SEQUENCE (SIZE(1..maxBarringInfoSet)) OF UAC-BarringInfoSet { | 1 entry | | |
| UAC-BarringInfoSet[1] SEQUENCE { | | entry 1 | |
| uac-BarringFactor | p00 | | |
| uac-BarringTime | s4 | | |
| uac-BarringForAccessIdentity | '0000000'B | | |
| } | | | |
| } | | | |
| uac-AccessCategory1-SelectionAssistanceInfo | Not Present | | |
| } | | | |
| } | | | |

Table 11.3.2.3.3-3: *RRCReject* (step 16, table 11.3.2.3.2-1)

| Derivation path: TS 38.508-1 [4] Table 4.6.1-15 | | | |
|---|--------------|------------|-----------|
| Information Element | Value/remark | Comment | Condition |
| RRCReject ::= SEQUENCE { | | | |
| criticalExtensions CHOICE { | | | |
| rrcReject SEQUENCE { | | | |
| waitTime | 16 | 16 seconds | |
| } | | | |
| } | | | |
| } | | | |

11.3.3 UAC / Access Identity 0 / AC8 / RRC_INACTIVE / RNAUpdate/RRC Resume

11.3.3.1 Test Purpose (TP)

(1)

```
with { UE not configured for special AIs (1,2,11-15) having received SIB1 indicating UAC info
containing 0% accessibility for Access category 8 in NR RRC_INACTIVE state }
ensure that {
  when { RRC connection is to be resumed due to an RNA update with no emergency services ongoing }
  then { UE resume attempt is barred and UE does not attempt the connection }
}
```

(2)

```
with { SIB1 indicating UAC info containing 100% accessibility for Access category 8 in NR
RRC_INACTIVE state }
ensure that {
  when { Access Barring is alleviated for Access Category 8 & upper layers do not request resumption
of an RRC connection & variable pendingRnaUpdate is set to true }
  then { UE initiates RRC connection resume procedure with resumeCause value set to rna-Update }
}
```

11.3.3.2 Conformance requirements

References: The conformance requirements covered in the present TC are specified in: TS 38.331, clause 5.3.13.2, 5.3.13.8, 5.3.14.2, 5.3.14.4 and 5.3.14.5. Unless otherwise stated these are Rel-15 requirements.

[TS 38.331, clause 5.3.13.2]

The UE initiates the procedure when upper layers or AS (when responding to RAN paging or upon triggering RNA updates while the UE is in RRC_INACTIVE) requests the resume of a suspended RRC connection.

The UE shall ensure having valid and up to date essential system information as specified in clause 5.2.2.2 before initiating this procedure.

Upon initiation of the procedure, the UE shall:

...

1> else if the resumption of the RRC connection is triggered due to an RNA update as specified in 5.3.13.8:

2> if an emergency service is ongoing:

NOTE: How the RRC layer in the UE is aware of an ongoing emergency service is up to UE implementation.

3> select '2' as the Access Category;

3> set the *resumeCause* to *emergency*;

2> else:

3> select '8' as the Access Category;

2> perform the unified access control procedure as specified in 5.3.14 using the selected Access Category and one or more Access Identities to be applied as specified in TS 24.501 [23];

3> if the access attempt is barred:

4> set the variable *pendingRnaUpdate* to *true*;

4> the procedure ends;

[TS 38.331, clause 5.3.13.8]

In RRC_INACTIVE state, the UE shall:

- 1> if T380 expires; or
- 1> if RNA Update is triggered at reception of SIB1, as specified in 5.2.2.4.2:
 - 2> initiate RRC connection resume procedure in 5.3.13.2 with *resumeCause* set to *rna-Update*;
- 1> if barring is alleviated for Access Category '8', as specified in 5.3.14.4:
 - 2> if upper layers do not request RRC the resumption of an RRC connection, and
 - 2> if the variable *pendingRnaUpdate* is set to *true*:
 - 3> initiate RRC connection resume procedure in 5.3.13.2 with *resumeCause* value set to *rna-Update*.

[TS 38.331, clause 5.3.14.2]

Upon initiation of the procedure, the UE shall:

- 1> if timer T390 is running for the Access Category:
 - 2> consider the access attempt as barred;
- 1> else if timer T302 is running and the Access Category is neither '2' nor '0':
 - 2> consider the access attempt as barred;
- 1> else:
 - 2> if the Access Category is '0':
 - 3> consider the access attempt as allowed;
 - 2> else:

...

- 3> else if SIB1 includes *uac-BarringForCommon*:
 - 4> in the remainder of this procedure use the *uac-BarringForCommon* (i.e. presence or absence of these parameters) included in *SIB1*;
- 3> else:
 - 4> consider the access attempt as allowed;
- 3> if *uac-BarringForCommon* is applicable or the *uac-ACBarringListType* indicates that *uac-ExplicitACBarringList* is used:
 - 4> if the corresponding *UAC-BarringPerCatList* contains a *UAC-BarringPerCat* entry corresponding to the Access Category:
 - 5> select the *UAC-BarringPerCat* entry;
 - 5> if the *uac-BarringInfoSetList* contains a *UAC-BarringInfoSet* entry corresponding to the selected *uac-barringInfoSetIndex* in the *UAC-BarringPerCat*:
 - 6> select the *UAC-BarringInfoSet* entry;
 - 6> perform access barring check for the Access Category as specified in 5.3.14.5, using the selected *UAC-BarringInfoSet* as "UAC barring parameter";
 - 5> else:
 - 6> consider the access attempt as allowed;
 - 4> else:
 - 5> consider the access attempt as allowed;

[TS 38.331, clause 5.3.14.4]

The UE shall:

...

- 1> else if timer T390 corresponding to an Access Category other than '2' expires or is stopped, and if timer T302 is not running:
 - 2> consider the barring for this Access Category to be alleviated;

...

- 1> when barring for an Access Category is considered being alleviated:
 - 2> if the Access Category was informed to upper layers as barred:
 - 3> inform upper layers about barring alleviation for the Access Category.
 - 2> if barring is alleviated for Access Category '8':
 - 3> perform actions specified in 5.3.13.8;

[TS 38.331, clause 5.3.14.5]

The UE shall:

- 1> if one or more Access Identities are indicated according to TS 24.501 [23], and
- 1> if for at least one of these Access Identities the corresponding bit in the *uac-BarringForAccessIdentity* contained in "UAC barring parameter" is set to *zero*:
 - 2> consider the access attempt as allowed;
- 1> else:
 - 2> draw a random number '*rand*' uniformly distributed in the range: $0 \leq rand < 1$;
 - 2> if '*rand*' is lower than the value indicated by *uac-BarringFactor* included in "UAC barring parameter":
 - 3> consider the access attempt as allowed;
 - 2> else:
 - 3> consider the access attempt as barred;
- 1> if the access attempt is considered as barred:
 - 2> draw a random number '*rand*' that is uniformly distributed in the range $0 \leq rand < 1$;
 - 2> start timer T390 for the Access Category with the timer value calculated as follows, using the *uac-BarringTime* included in "AC barring parameter":

$$T390 = (0.7 + 0.6 * rand) * uac-BarringTime.$$

11.3.3.3 Test description

11.3.3.3.1 Pre-test conditions

System Simulator:

- NR Cell 1
- System information combination NR-1 as defined in TS 38.508-1 [4] clause 4.4.3.1.2 is used in NR cells.

UE:

- None.

Preamble:

- The UE is in state 2N-A on NR cell 1 according to TS 38.508-1 [4] Table 4.4A.2-2.

11.3.3.3.2 Test procedure sequence

Table 11.3.3.3.2-1: Main behaviour

| St | Procedure | Message Sequence | | TP | Verdict |
|----|---|------------------|----------------------------------|----|---------|
| | | U - S | Message | | |
| 1 | Wait for 5 minute to make the timer T380 expire and trigger the RNA update procedure in UE. | | | | |
| 2 | Check: Does the UE transmit an <i>RRCResumeRequest</i> message with resumeCause value set to rna-Update on NR Cell 1 within 60s? | --> | NR RRC: <i>RRCResumeRequest</i> | 1 | F |
| 3 | The SS changes the SIB1 according to 38.508-1 [4] Table 4.6.1-28 and transmits a Short message on PDCCH using P-RNTI indicating a systemInfoModification. | <-- | PDCCH (DCI 1_0): Short Message | - | - |
| 4 | Check: Does the UE transmit an <i>RRCResumeRequest</i> message with resumeCause value set to rna-Update on NR Cell 1? | --> | NR RRC: <i>RRCResumeRequest</i> | 2 | P |
| 5 | The SS transmits an <i>RRCResume</i> message. | <-- | NR RRC: <i>RRCResume</i> | - | - |
| 6 | The UE transmits an <i>RRCResumeComplete</i> message. | --> | NR RRC: <i>RRCResumeComplete</i> | - | - |

11.3.3.3.3 Specific message contents

Table 11.3.3.3.3-1: SIB1 for NR Cell 1 (preamble, Table 11.3.3.3.2-1)

| Derivation Path: TS 38.508-1 [4], Table 4.6.1-28 | | | |
|--|--------------|---------|-----------|
| Information Element | Value/remark | Comment | Condition |
| SIB1 ::= SEQUENCE { | | | |
| uac-BarringInfo SEQUENCE { | | | |
| uac-BarringForCommon SEQUENCE (SIZE (1..maxAccessCat-1)) OF UAC-BarringPerCat { | 1 entry | | |
| UAC-BarringPerCat[1] SEQUENCE { | | entry 1 | |
| accessCategory | 8 | | |
| uac-barringInfoSetIndex | 1 | | |
| } | | | |
| } | | | |
| uac-BarringPerPLMN-List | Not present | | |
| uac-BarringInfoSetList SEQUENCE (SIZE(1..maxBarringInfoSet)) OF UAC-BarringInfoSet { | 1 entry | | |
| UAC-BarringInfoSet[1] SEQUENCE { | | entry 1 | |
| uac-BarringFactor | p00 | | |
| uac-BarringTime | s64 | | |
| uac-BarringForAccessIdentity | '0000000'B | | |
| } | | | |
| } | | | |
| uac-AccessCategory1-SelectionAssistanceInfo | Not Present | | |
| } | | | |
| } | | | |

Table 11.3.3.3.3-2: RRCRelease (preamble, Table 11.3.3.3.2-1)

| Derivation Path: TS 38.508-1 [4], Table 4.6.1-16 | | | |
|--|--------------|-----------|---------------------|
| Information Element | Value/remark | Comment | Condition |
| RRCRelease ::= SEQUENCE { | | | |
| criticalExtensions CHOICE { | | | |
| rrcRelease SEQUENCE { | | | |
| suspendConfig SEQUENCE { | | | NR_RRC_I
NACTIVE |
| t380 | min5 | 5 minutes | |
| } | | | |
| } | | | |
| } | | | |
| } | | | |

Table 11.3.3.3.3-3: RRCResumeRequest (step 2 and step 5, Table 11.3.3.3.2-1)

| Derivation Path: TS 38.508-1 [4], Table 4.6.1-19 | | | |
|--|--------------|---------|-----------|
| Information Element | Value/remark | Comment | Condition |
| RRCResumeRequest ::= SEQUENCE { | | | |
| rrcResumeRequest SEQUENCE { | | | |
| resumeCause | rna-Update | | |
| } | | | |
| } | | | |

11.3.4 UAC / Access Identity 0 / Registration procedure for mobility and periodic registration update / BarringPerPLMN/Implicit AC Barring List

11.3.4.1 Test Purpose (TP)

(1)

```
with { UE in NR RRC_IDLE not configured for special AIs (1,2,11-15) having received a SIB1 message
including UAC set to 0% accessibility for Access Category 3 }
ensure that {
  when { UE finds a new cell (AC 3) with SIB1 containing UAC Barring Info Per PLMN with Implicit AC
Barring List }
  then { UE does not access the new cell until access barring is alleviated }
}
```

11.3.4.2 Conformance requirements

References: The conformance requirements covered in the present TC are specified in: TS 24.501 clause 4.5.2, 4.5.4.1 and 5.5.1.3.7, TS 38.331 clause 5.3.14.2, 5.3.14.4 and 5.3.14.5. Unless otherwise stated these are Rel-15 requirements.

[TS 24.501, clause 4.5.2]

When the UE needs to initiate an access attempt in one of the events listed in subclause 4.5.1, the UE shall determine one or more access identities from the set of standardized access identities, and one access category from the set of standardized access categories and operator-defined access categories, to be associated with that access attempt.

The set of the access identities applicable for the request is determined by the UE in the following way:

- a) for each of the access identities 1, 2, 11, 12, 13, 14 and 15 in table 4.5.2.1, the UE shall check whether the access identity is applicable in the selected PLMN, if a new PLMN is selected, or otherwise if it is applicable in the RPLMN or equivalent PLMN; and
- b) if none of the above access identities is applicable, then access identity 0 is applicable.

Table 4.5.2.1: Access identities

| Access Identity number | UE configuration |
|--|--|
| 0 | UE is not configured with any parameters from this table |
| 1 (NOTE 1) | UE is configured for multimedia priority service (MPS). |
| 2 (NOTE 2) | UE is configured for mission critical service (MCS). |
| 3-10 | Reserved for future use |
| 11 (NOTE 3) | Access Class 11 is configured in the UE. |
| 12 (NOTE 3) | Access Class 12 is configured in the UE. |
| 13 (NOTE 3) | Access Class 13 is configured in the UE. |
| 14 (NOTE 3) | Access Class 14 is configured in the UE. |
| 15 (NOTE 3) | Access Class 15 is configured in the UE. |
| <p>NOTE 1: Access identity 1 is valid when:</p> <ul style="list-style-type: none"> - the USIM file EFUAC_AIC indicates the UE is configured for access identity 1 and the RPLMN is the HPLMN (if the EHPLMN list is not present or is empty) or EHPLMN (if the EHPLMN list is present), or a visited PLMN of the home country (see the definition of home country in 3GPP TS 24.301 [15]); or - the UE receives the 5GS network feature support IE with the MPS indicator bit set to "Access identity 1 valid in RPLMN or equivalent PLMN" from the RPLMN as described in subclause 5.5.1.2.4 and subclause 5.5.1.3.4. <p>NOTE 2: Access identity 2 is used by UEs configured for MCS and is valid when:</p> <ul style="list-style-type: none"> - the USIM file EFUAC_AIC indicates the UE is configured for access identity 2 and the RPLMN is the HPLMN (if the EHPLMN list is not present or is empty) or EHPLMN (if the EHPLMN list is present), or a visited PLMN of the home country (see 3GPP TS 23.122 [5]); or - the UE receives the 5GS network feature support IE with the MCS indicator bit set to "Access identity 2 valid in RPLMN or equivalent PLMN" from the RPLMN as described in subclause 5.5.1.2.4 and subclause 5.5.1.3.4. <p>NOTE 3: Access identities 11 and 15 are valid in HPLMN (if the EHPLMN list is not present or is empty) or EHPLMN (if the EHPLMN list is present). Access Identities 12, 13 and 14 are valid in HPLMN and visited PLMNs of home country only (see the definition of home country in 3GPP TS 24.301 [15]).</p> | |

...

In order to determine the access category applicable for the access attempt, the NAS shall check the rules in table 4.5.2.2, and use the access category for which there is a match for barring check. If the access attempt matches more than one rule, the access category of the lowest rule number shall be selected. If the access attempt matches more than one operator-defined access category definition, the UE shall select the access category from the operator-defined access category definition with the lowest precedence value (see subclause 4.5.3).

NOTE: The case when an access attempt matches more than one rule includes the case when multiple events trigger an access attempt at the same time.

Table 4.5.2.2: Mapping table for access categories

| Rule # | Type of access attempt | Requirements to be met | Access Category |
|--|---|--|---|
| 1 | Response to paging or NOTIFICATION over non-3GPP access;
5GMM connection management procedure initiated for the purpose of transporting an LPP message | Access attempt is for MT access | 0 (= MT_acc) |
| 2 | Emergency | UE is attempting access for an emergency session (NOTE 1, NOTE 2) | 2 (= emergency) |
| 3 | Access attempt for operator-defined access category | UE stores operator-defined access category definitions valid in the current PLMN as specified in subclause 4.5.3, and access attempt is matching criteria of an operator-defined access category definition | 32-63
(= based on operator classification) |
| 4 | Access attempt for delay tolerant service | (a) UE is configured for NAS signalling low priority or UE supporting S1 mode is configured for EAB (see the "ExtendedAccessBarring" leaf of NAS configuration MO in 3GPP TS 24.368 [17] or 3GPP TS 31.102 [22]) where "EAB override" does not apply, and
(b) the UE received one of the categories a, b or c as part of the parameters for unified access control in the broadcast system information, and the UE is a member of the broadcasted category in the selected PLMN or RPLMN/equivalent PLMN (NOTE 3, NOTE 5, NOTE 6, NOTE 7, NOTE 8) | 1 (= delay tolerant) |
| 5 | MO MMTel voice call | Access attempt is for MO MMTel voice call or for NAS signalling connection recovery during ongoing MO MMTel voice call (NOTE 2) | 4 (= MO MMTel voice) |
| 6 | MO MMTel video call | Access attempt is for MO MMTel video call or for NAS signalling connection recovery during ongoing MO MMTel video call (NOTE 2) | 5 (= MO MMTel video) |
| 7 | MO SMS over NAS or MO SMSoIP | Access attempt is for MO SMS over NAS (NOTE 4) or MO SMS over SMSoIP transfer or for NAS signalling connection recovery during ongoing MO SMS or SMSoIP transfer (NOTE 2) | 6 (= MO SMS and SMSoIP) |
| 8 | UE NAS initiated 5GMM specific procedures | Access attempt is for MO signalling | 3 (= MO_sig) |
| 9 | UE NAS initiated 5GMM connection management procedure or 5GMM NAS transport procedure | Access attempt is for MO data | 7 (= MO_data) |
| 10 | An uplink user data packet is to be sent for a PDU session with suspended user-plane resources | No further requirement is to be met | 7 (= MO_data) |
| <p>NOTE 1: This includes 5GMM specific procedures while the service is ongoing and 5GMM connection management procedures required to establish a PDU session with request type = "initial emergency request" or "existing emergency PDU session", or to re-establish user-plane resources for such a PDU session. This further includes the service request procedure initiated with a SERVICE REQUEST message with the Service type IE set to "emergency services fallback".<</p> <p>NOTE 2: Access for the purpose of NAS signalling connection recovery during an ongoing service, or for the purpose of NAS signalling connection establishment following fallback indication from lower layers during an ongoing service, is mapped to the access category of the ongoing service in order to derive an RRC establishment cause, but barring checks will be skipped for this access attempt.</p> | | | |

| | |
|---------|--|
| NOTE 3: | If the UE selects a new PLMN, then the selected PLMN is used to check the membership; otherwise the UE uses the RPLMN or a PLMN equivalent to the RPLMN. |
| NOTE 4: | This includes the 5GMM connection management procedures triggered by the UE-initiated NAS transport procedure for transporting the MO SMS. |
| NOTE 5: | The UE configured for NAS signalling low priority is not supported in this release of specification. If a UE supporting both S1 mode and N1 mode is configured for NAS signalling low priority in S1 mode as specified in 3GPP TS 24.368 [17] or 3GPP TS 31.102 [22], the UE shall ignore the configuration for NAS signalling low priority when in N1 mode. |
| NOTE 6: | If the access category applicable for the access attempt is 1, then the UE shall additionally determine a second access category from the range 3 to 7. If more than one access category matches, the access category of the lowest rule number shall be chosen. The UE shall use the second access category only to derive an RRC establishment cause for the access attempt. |
| NOTE 7: | "EAB override" does not apply, if the UE is not configured to allow overriding EAB (see the "Override_ExtendedAccessBarring" leaf of NAS configuration MO in 3GPP TS 24.368 [17] or 3GPP TS 31.102 [22]), or if NAS has not received an indication from the upper layers to override EAB and the UE does not have a PDU session that was established with EAB override. |
| NOTE 8: | For the definition of categories a, b and c associated with access category 1, see 3GPP TS 22.261 [3]. The categories associated with access category 1 are distinct from the categories a, b and c associated with EAB (see 3GPP TS 22.011 [1A]). |

[TS 24.501, clause 4.5.4.1]

When the UE is in 5GMM-IDLE mode, upon receiving a request from the upper layers for an access attempt, the NAS shall categorize the access attempt into access identities and an access category following subclause 4.5.2, table 4.5.2.1 and table 4.5.2.2, and subclause 4.5.3, and provide the applicable access identities and the access category to the lower layers for the purpose of access control checking. In this request to the lower layer the NAS can also provide to the lower layer the RRC establishment cause determined as specified in subclause 4.5.6 of this specification.

NOTE 1: The access barring check is performed by the lower layers.

NOTE 2: As an implementation option, the NAS can provide the RRC establishment cause to the lower layers after being informed by the lower layers that the access attempt is allowed.

...

If the lower layers indicate that the access attempt is allowed, the NAS shall initiate the procedure to send the initial NAS message for the access attempt.

If the lower layers indicate that the access attempt is barred, the NAS shall not initiate the procedure to send the initial NAS message for the access attempt. Additionally:

- a) if the event which triggered the access attempt was an MO-MMTEL-voice-call-started indication or an MO-MMTEL-video-call-started indication:
 - 1) if the UE is operating in the single-registration mode and the UE's usage setting is "voice centric", the UE may attempt to select an E-UTRA cell connected to EPC. If the UE finds a suitable E-UTRA cell connected to EPC, it then proceeds with the appropriate EMM specific procedures and, if necessary, ESM procedures to make a PDN connection providing access to IMS available; see subclause 4.8.2 and 3GPP TS 24.301 [15];
 - 2) if the UE is operating in the dual-registration mode, the UE may proceed in S1 mode with the appropriate EMM specific procedures and ESM procedures to make a PDN connection providing access to IMS available; see subclause 4.8.3 and 3GPP TS 24.301 [15];
 - 3) otherwise, the NAS shall notify the upper layers that the access attempt is barred. In this case, upon receiving an indication from the lower layers that the barring is alleviated for the access category with which the access attempt was associated, the NAS shall notify the upper layers that the barring is alleviated for the access category and may initiate the procedure to send the initial NAS message, if still needed; and
- b) if the event which triggered the access attempt was an MO-SMSoIP-attempt-started indication:
 - 1) if the UE is operating in the single-registration mode, the UE may attempt to select an E-UTRA cell connected to EPC. If the UE finds a suitable E-UTRA cell connected to EPC, it then proceeds with the appropriate EMM specific procedures and, if necessary, ESM procedures to make a PDN connection providing access to IMS available; see subclause 4.8.2 and 3GPP TS 24.301 [15];

- 2) if the UE is operating in the dual-registration mode, the UE may proceed in S1 mode with the appropriate EMM specific procedures and ESM procedures to make a PDN connection providing access to IMS available; see subclause 4.8.3 and 3GPP TS 24.301 [15];

3) otherwise, the NAS layer shall notify the upper layers that the access attempt is barred. In this case, upon receiving an indication from the lower layers that the barring is alleviated for the access category with which the access attempt was associated, the NAS shall notify the upper layers that the barring is alleviated for the access category and may initiate the procedure to send the initial NAS message, if still needed.

NOTE 4: Barring timers, on a per access category basis, are run by the lower layers. At expiry of barring timers, the indication of alleviation of access barring is indicated to the NAS on a per access category basis.

[TS 24.501, clause 5.5.1.3.7]

- b) The lower layers indicate that the access attempt is barred.

The UE shall not start the registration procedure for mobility and periodic registration update. The UE stays in the current serving cell and applies the normal cell reselection process.

The registration procedure for mobility and periodic registration update is started, if still needed, when the lower layers indicate that the barring is alleviated for the access category with which the access attempt was associated.

- ba) The lower layers indicate that access barring is applicable for all access categories except categories 0 and 2 and the access category with which the access attempt was associated is other than 0 and 2.

If the REGISTRATION REQUEST message has not been sent, the UE shall proceed as specified for case b. If the REGISTRATION REQUEST message has been sent, the UE shall proceed as specified for case e and, additionally, the registration procedure for mobility and periodic registration update is started, if still needed, when the lower layers indicate that the barring is alleviated for the access category with which the access attempt was associated. For additional UE requirements for both cases see subclause 4.5.5.

[TS 38.331, clause 5.3.14.2]

Upon initiation of the procedure, the UE shall:

- 1> if timer T390 is running for the Access Category:
2> consider the access attempt as barred;

...

- 1> else:

- 2> if the Access Category is '0':
3> consider the access attempt as allowed;

- 2> else:

- 3> if *SIB1* includes *uac-BarringPerPLMN-List* and the *uac-BarringPerPLMN-List* contains an *UAC-BarringPerPLMN* entry with the *plmn-IdentityIndex* corresponding to the PLMN selected by upper layers (see TS 24.501 [23]):

- 4> select the *UAC-BarringPerPLMN* entry with the *plmn-IdentityIndex* corresponding to the PLMN selected by upper layers;

- 4> in the remainder of this procedure, use the selected *UAC-BarringPerPLMN* entry (i.e. presence or absence of access barring parameters in this entry) irrespective of the *uac-BarringForCommon* included in *SIB1*;

...

- 3> else if the *uac-ACBarringListType* indicates that *uac-ImplicitACBarringList* is used:

- 4> select the *uac-BarringInfoSetIndex* corresponding to the Access Category in the *uac-ImplicitACBarringList*;

- 4> if the *uac-BarringInfoSetList* contains the *UAC-BarringInfoSet* entry corresponding to the selected *uac-BarringInfoSetIndex*:
 - 5> select the *UAC-BarringInfoSet* entry;
 - 5> perform access barring check for the Access Category as specified in 5.3.14.5, using the selected *UAC-BarringInfoSet* as "UAC barring parameter";
- 4> else:
 - 5> consider the access attempt as allowed;
- 3> else:
 - 4> consider the access attempt as allowed;
- 1> if the access barring check was requested by upper layers:
 - 2> if the access attempt is considered as barred:
 - 3> if timer T302 is running:
 - 4> if timer T390 is running for Access Category '2':
 - 5> inform the upper layer that access barring is applicable for all access categories except categories '0', upon which the procedure ends;
 - 4> else:
 - 5> inform the upper layer that access barring is applicable for all access categories except categories '0' and '2', upon which the procedure ends;
 - 3> else:
 - 4> inform upper layers that the access attempt for the Access Category is barred, upon which the procedure ends;
 - 2> else:
 - 3> inform upper layers that the access attempt for the Access Category is allowed, upon which the procedure ends;
 - 1> else:
 - 2> the procedure ends.

[TS 38.331, clause 5.3.14.4]

The UE shall:

...

- 1> else if timer T390 corresponding to an Access Category other than '2' expires or is stopped, and if timer T302 is not running:
 - 2> consider the barring for this Access Category to be alleviated;

...

- 1> when barring for an Access Category is considered being alleviated:
 - 2> if the Access Category was informed to upper layers as barred:
 - 3> inform upper layers about barring alleviation for the Access Category.

[TS 38.331, clause 5.3.14.5]

The UE shall:

- 1> if one or more Access Identities are indicated according to TS 24.501 [23], and
- 1> if for at least one of these Access Identities the corresponding bit in the *uac-BarringForAccessIdentity* contained in "UAC barring parameter" is set to *zero*:
- 2> consider the access attempt as allowed;
- 1> else:
- 2> draw a random number '*rand*' uniformly distributed in the range: $0 \leq rand < 1$;
- 2> if '*rand*' is lower than the value indicated by *uac-BarringFactor* included in "UAC barring parameter":
- 3> consider the access attempt as allowed;
- 2> else:
- 3> consider the access attempt as barred;
- 1> if the access attempt is considered as barred:
- 2> draw a random number '*rand*' that is uniformly distributed in the range $0 \leq rand < 1$;
- 2> start timer T390 for the Access Category with the timer value calculated as follows, using the *uac-BarringTime* included in "AC barring parameter":
- $$T390 = (0.7 + 0.6 * rand) * uac-BarringTime.$$

11.3.4.3 Test description

11.3.4.3.1 Pre-test conditions

System Simulator:

- NR Cell 1 and NR Cell 11 have different tracking areas according to TS 38.508-1 [4] Table 4.4.2-3.
- System information combination NR-2 as defined in TS 38.508-1 [4] clause 4.4.3.1.2 is used in NR Cells.

UE:

- None.

Preamble:

- The UE is in state 1N-A on NR cell 1 according to TS 38.508-1 [4] Table 4.4A.2-1.

11.3.4.3.2 Test procedure sequence

Table 11.3.4.3.2-1/2 illustrate the downlink power levels and other changing parameters to be applied for the cell at various time instants of the test execution. The exact instants on which these values shall be applied are described in the texts in this clause. The configuration T0 indicates the initial conditions for preamble. Configurations marked "T1" is applied at the points indicated in the Main behaviour description in Table 11.3.4.3.2-3.

Table 11.3.4.3.2-1: Time instances of cell power level and parameter changes for FR1

| | Parameter | Unit | NR Cell 1 | NR Cell 11 | Remark |
|-----------|---------------------|-------------|-----------|------------|---|
| T0 | SS/PBCH
SSS EPRE | dBm/
SCS | -88 | Off | |
| T1 | SS/PBCH
SSS EPRE | dBm/
SCS | -88 | -80 | The power level values are assigned to satisfy $R_{NRCell 1} < R_{NRCell 11}$ |

Table 11.3.4.3.2-2: Time instances of cell power level and parameter changes for FR2

| | Parameter | Unit | NR Cell 1 | NR Cell 11 | Remark |
|----|---------------------|-------------|-----------|------------|---|
| T0 | SS/PBCH
SSS EPRE | dBm/
SCS | -91 | Off | |
| T1 | SS/PBCH
SSS EPRE | dBm/
SCS | -91 | -82 | The power level values are assigned to satisfy $R_{NRCell 1} < R_{NRCell 11}$ |

Table 11.3.4.3.2-3: Main behaviour

| St | Procedure | Message Sequence | | TP | Verdict |
|---|--|------------------|--------------------------------|----|---------|
| | | U - S | Message | | |
| 1 | The SS changes the SIB1 of NR Cell 11 according to Table 11.3.4.3.3-1 | | | | |
| 2 | The SS adjusts the SS/PBCH EPRE levels and according to row "T1" in table 11.3.4.3.2-1/2. | - | - | - | - |
| 3 | Wait for 34s for FR1 or 130s for FR2 to allow UE to recognise the change.(Note 1) | | | | |
| 4 | Check: Does the UE transmit an RRCSetupRequest message on NR cell 11? | --> | NR RRC: RRCSetupRequest | 1 | F |
| 5 | The SS changes the SIB1 according to 38.508-1 [4] Table 4.6.1-28 and transmits a Short message on PDCCH using P-RNTI indicating a systemInfoModification. | <-- | PDCCH (DCI 1_0): Short Message | - | - |
| 6 | Wait for 1 second for the UE to receive the modified system information. | | | | |
| 7 | Wait for 84s for T390 to expire. (Note 2) | | | | |
| 8 | Check: Does UE transmit RRCSetupRequest message on NR cell 11? | --> | NR RRC: RRCSetupRequest | 1 | P |
| 912 | Steps 2 to 5 of the generic test procedure in TS 38.508-1 Table 4.9.5.2.2-1 with condition MOBILITY are performed on NR cell 11. NOTE: The UE performs a "REGISTRATION REQUEST procedure with type "mobility registration updating". | - | - | - | - |
| <p>Note 1: The wait time for reselection to a newly detected intra frequency cell is selected to cover T_{detect,NR_Intra} ($25 \cdot 1280ms = 32s$ for FR1 and $25 \cdot 4 \cdot 1280ms = 128s$ for FR2) + T_{SI-NR} (1.28s for FR1 and FR2) = 33.28s rounded up to 34s for FR1 and 129.28s rounded up to 130s for FR2.</p> <p>Note 2: T390 timer value is derived from 38.331[12] $T390 = (0.7 + 0.6 \cdot rand) \cdot uac-BarringTime$ where the $uac-BarringTime$ value of 64s is provided in 38.523 Table 11.3.4.3.3-1 and where the value of $rand$ is chosen to be 1 as to arrive at the maximum value for T390 of 83.2s rounded up to 84s</p> | | | | | |

11.3.4.3.3 Specific message contents

Table 11.3.4.3.3-1: SIB1 for NR Cell 11 (step 1, Table 11.3.4.3.3-1)

| Derivation Path: TS 38.508-1 [4], Table 4.6.1-28 | | | |
|--|--------------|-------------------------------------|-----------|
| Information Element | Value/remark | Comment | Condition |
| SIB1 ::= SEQUENCE { | | | |
| cellAccessRelatedInfo SEQUENCE { | | | |
| PLMN-IdentityInfoList SEQUENCE (SIZE (1..maxPLMN)) OF PLMN-IdentityInfo { | 1 entry | | |
| PLMN-IdentityInfo[1] SEQUENCE { | | entry 1 | |
| plmn-IdentityList SEQUENCE (SIZE (1..maxPLMN)) OF PLMN-Identity { | 1 entry | | |
| plmn-Identity[1] | | entry 1
PLMN ID of NR
Cell 11 | |
| } | | | |
| } | | | |
| } | | | |
| } | | | |
| uac-BarringInfo SEQUENCE { | | | |
| uac-BarringForCommon | Not present | | |
| uac-BarringPerPLMN-List SEQUENCE (SIZE (1..maxPLMN)) OF UAC-BarringPerPLMN { | | | |
| UAC-BarringPerPLMN SEQUENCE { | | | |
| plmn-IdentityIndex | 1 | | |
| uac-ACBarringListType CHOICE { | | | |
| uac-ImplicitACBarringList SEQUENCE (SIZE(maxAccessCat-1)) OF UAC-BarringInfoSetIndex { | 63 entries | | |
| UAC-BarringInfoSetIndex[1] | 2 | entry 1 | |
| UAC-BarringInfoSetIndex[2] | 2 | entry 2 | |
| UAC-BarringInfoSetIndex[3] | 1 | entry 3 | |
| UAC-BarringInfoSetIndex[4] | 2 | entry 4 | |
| UAC-BarringInfoSetIndex[5] | 2 | entry 5 | |
| UAC-BarringInfoSetIndex[6] | 2 | entry 6 | |
| UAC-BarringInfoSetIndex[7] | 2 | entry 7 | |
| UAC-BarringInfoSetIndex[8] | 2 | entry 8 | |
| UAC-BarringInfoSetIndex[9] | 2 | entry 9 | |
| UAC-BarringInfoSetIndex[10] | 2 | entry 10 | |
| UAC-BarringInfoSetIndex[11] | 2 | entry 11 | |
| UAC-BarringInfoSetIndex[12] | 2 | entry 12 | |
| UAC-BarringInfoSetIndex[13] | 2 | entry 13 | |
| UAC-BarringInfoSetIndex[14] | 2 | entry 14 | |
| UAC-BarringInfoSetIndex[15] | 2 | entry 15 | |
| UAC-BarringInfoSetIndex[16] | 2 | entry 16 | |
| UAC-BarringInfoSetIndex[17] | 2 | entry 17 | |
| UAC-BarringInfoSetIndex[18] | 2 | entry 18 | |
| UAC-BarringInfoSetIndex[19] | 2 | entry 19 | |
| UAC-BarringInfoSetIndex[20] | 2 | entry 20 | |
| UAC-BarringInfoSetIndex[21] | 2 | entry 21 | |
| UAC-BarringInfoSetIndex[22] | 2 | entry 22 | |
| UAC-BarringInfoSetIndex[23] | 2 | entry 23 | |
| UAC-BarringInfoSetIndex[24] | 2 | entry 24 | |
| UAC-BarringInfoSetIndex[25] | 2 | entry 25 | |
| UAC-BarringInfoSetIndex[26] | 2 | entry 26 | |
| UAC-BarringInfoSetIndex[27] | 2 | entry 27 | |
| UAC-BarringInfoSetIndex[28] | 2 | entry 28 | |
| UAC-BarringInfoSetIndex[29] | 2 | entry 29 | |
| UAC-BarringInfoSetIndex[30] | 2 | entry 30 | |
| UAC-BarringInfoSetIndex[31] | 2 | entry 31 | |
| UAC-BarringInfoSetIndex[32] | 2 | entry 32 | |
| UAC-BarringInfoSetIndex[33] | 2 | entry 33 | |
| UAC-BarringInfoSetIndex[34] | 2 | entry 34 | |
| UAC-BarringInfoSetIndex[35] | 2 | entry 35 | |
| UAC-BarringInfoSetIndex[36] | 2 | entry 36 | |

| | | | |
|--|-------------|----------|--|
| UAC-BarringInfoSetIndex[37] | 2 | entry 37 | |
| UAC-BarringInfoSetIndex[38] | 2 | entry 38 | |
| UAC-BarringInfoSetIndex[39] | 2 | entry 39 | |
| UAC-BarringInfoSetIndex[40] | 2 | entry 40 | |
| UAC-BarringInfoSetIndex[41] | 2 | entry 41 | |
| UAC-BarringInfoSetIndex[42] | 2 | entry 42 | |
| UAC-BarringInfoSetIndex[43] | 2 | entry 43 | |
| UAC-BarringInfoSetIndex[44] | 2 | entry 44 | |
| UAC-BarringInfoSetIndex[45] | 2 | entry 45 | |
| UAC-BarringInfoSetIndex[46] | 2 | entry 46 | |
| UAC-BarringInfoSetIndex[47] | 2 | entry 47 | |
| UAC-BarringInfoSetIndex[48] | 2 | entry 48 | |
| UAC-BarringInfoSetIndex[49] | 2 | entry 49 | |
| UAC-BarringInfoSetIndex[50] | 2 | entry 50 | |
| UAC-BarringInfoSetIndex[51] | 2 | entry 51 | |
| UAC-BarringInfoSetIndex[52] | 2 | entry 52 | |
| UAC-BarringInfoSetIndex[53] | 2 | entry 53 | |
| UAC-BarringInfoSetIndex[54] | 2 | entry 54 | |
| UAC-BarringInfoSetIndex[55] | 2 | entry 55 | |
| UAC-BarringInfoSetIndex[56] | 2 | entry 56 | |
| UAC-BarringInfoSetIndex[57] | 2 | entry 57 | |
| UAC-BarringInfoSetIndex[58] | 2 | entry 58 | |
| UAC-BarringInfoSetIndex[59] | 2 | entry 59 | |
| UAC-BarringInfoSetIndex[60] | 2 | entry 60 | |
| UAC-BarringInfoSetIndex[61] | 2 | entry 61 | |
| UAC-BarringInfoSetIndex[62] | 2 | entry 62 | |
| UAC-BarringInfoSetIndex[63] | 2 | entry 63 | |
| } | | | |
| } | | | |
| } | | | |
| uac-BarringInfoSetList SEQUENCE
(SIZE(1..maxBarringInfoSet)) OF UAC-BarringInfoSet
{ | 1 entry | | |
| UAC-BarringInfoSet[1] SEQUENCE { | | entry 1 | |
| uac-BarringFactor | p00 | | |
| uac-BarringTime | s64 | | |
| uac-BarringForAccessIdentity | '0000000'B | | |
| } | | | |
| uac-AccessCategory1-SelectionAssistanceInfo | Not Present | | |
| } | | | |
| } | | | |
| Note: UAC-BarringInfoSetIndex value 2 referring to an entry not included in uac-BarringInfoSetList indicates no barring for the Access Category. | | | |

11.3.5 UAC / Access Identity 1 / New cell not in the country of its HPLMN/EHPLMN 0% access probability/MPS indicator / HPLMN/0%/100% accessibility AC5/MMTEL-Video call

11.3.5.1 Test Purpose (TP)

(1)

```

with { UE configured for Access Identity 1 }
ensure that {
  when { UE moves to a new cell which is not in the country of its HPLMN or in an EHPLMN (if the
EHPLMN list is present) having received SIB1 message including UAC set to 0% accessibility for
Access Identity 1 }
  then { UE does not consider Access Identity 1 as valid and continues with the REGISTRATION
procedure }
}

```

(2)

```

with { UE configured for Access Identity 1 }
ensure that {
  when { UE moves to a new cell which is not in the country of its HPLMN or in an EHPLMN (if the
EHPLMN list is present) but receives the MPS indicator bit of the 5GS network feature support IE in
the REGISTRATION ACCEPT message being set to "Access identity 1 valid" }
  then { UE does consider Access Identity 1 as valid }
}

```

(3)

```

with { UE configured for Access Identity 1 having received SIB1 containing UAC Barring Info
indicating 0% accessibility for Access Category 5 in NR RRC_IDLE state on HPLMN }
ensure that {
  when { User initiates MMTEL-Video call }
  then { UE does not attempt to initiate connection on the NR Cell }
}

```

(4)

```

with { UE configured for Access Identity 1 having received SIB1 containing UAC Info indicating 100%
accessibility for Access Category 5 while camped on HPLMN in NR RRC_IDLE state }
ensure that {
  when { User initiates MMTEL-Video call and Access Barring check indicates Barring is alleviated }
  then { UE initiates RRC Connection Setup procedure with establishmentCause set to mps-
PriorityAccess }
}

```

11.3.5.2 Conformance requirements

References: The conformance requirements covered in the present TC are specified in TS 24.501: clause 4.5.2, 4.5.4.1 and 4.5.6 and TS 38.331: clause 5.3.14.1, 5.3.14.2, 5.3.14.4 and 5.3.14.5. Unless otherwise stated these are Rel-15 requirements.

[TS 24.501, clause 4.5.2]

When the UE needs to initiate an access attempt in one of the events listed in subclause 4.5.1, the UE shall determine one or more access identities from the set of standardized access identities, and one access category from the set of standardized access categories and operator-defined access categories, to be associated with that access attempt.

The set of the access identities applicable for the request is determined by the UE in the following way:

- a) for each of the access identities 1, 2, 11, 12, 13, 14 and 15 in table 4.5.2.1, the UE shall check whether the access identity is applicable in the selected PLMN, if a new PLMN is selected, or otherwise if it is applicable in the RPLMN or equivalent PLMN; and
- b) if none of the above access identities is applicable, then access identity 0 is applicable.

Table 4.5.2.1: Access identities

| Access Identity number | UE configuration |
|--|--|
| 0 | UE is not configured with any parameters from this table |
| 1 (NOTE 1) | UE is configured for multimedia priority service (MPS). |
| 2 (NOTE 2) | UE is configured for mission critical service (MCS). |
| 3-10 | Reserved for future use |
| 11 (NOTE 3) | Access Class 11 is configured in the UE. |
| 12 (NOTE 3) | Access Class 12 is configured in the UE. |
| 13 (NOTE 3) | Access Class 13 is configured in the UE. |
| 14 (NOTE 3) | Access Class 14 is configured in the UE. |
| 15 (NOTE 3) | Access Class 15 is configured in the UE. |
| <p>NOTE 1: Access identity 1 is valid when:</p> <ul style="list-style-type: none"> - the USIM file EF_{UAC_AIC} indicates the UE is configured for access identity 1 and the RPLMN is the HPLMN (if the EHPLMN list is not present or is empty) or EHPLMN (if the EHPLMN list is present), or a visited PLMN of the home country (see the definition of home country in 3GPP TS 24.301 [15]); or - the UE receives the 5GS network feature support IE with the MPS indicator bit set to "Access identity 1 valid in RPLMN or equivalent PLMN" from the RPLMN as described in subclause 5.5.1.2.4 and subclause 5.5.1.3.4. <p>NOTE 2: Access identity 2 is used by UEs configured for MCS and is valid when:</p> <ul style="list-style-type: none"> - the USIM file EF_{UAC_AIC} indicates the UE is configured for access identity 2 and the RPLMN is the HPLMN (if the EHPLMN list is not present or is empty) or EHPLMN (if the EHPLMN list is present), or a visited PLMN of the home country (see 3GPP TS 23.122 [5]); or - the UE receives the 5GS network feature support IE with the MCS indicator bit set to "Access identity 2 valid in RPLMN or equivalent PLMN" from the RPLMN as described in subclause 5.5.1.2.4 and subclause 5.5.1.3.4. <p>NOTE 3: Access identities 11 and 15 are valid in HPLMN (if the EHPLMN list is not present or is empty) or EHPLMN (if the EHPLMN list is present). Access Identities 12, 13 and 14 are valid in HPLMN and visited PLMNs of home country only (see the definition of home country in 3GPP TS 24.301 [15]).</p> | |

The UE uses the MPS indicator bit of the 5GS network feature support IE to determine if access identity 1 is valid. Processing of the MPS indicator bit of the 5GS network feature support IE in the REGISTRATION ACCEPT message is described in subclause 5.5.1.2.4 and subclause 5.5.1.3.4. The UE shall not consider access identity 1 to be valid when the UE is not in the country of its HPLMN prior to receiving the MPS indicator bit of the 5GS network feature support IE in the REGISTRATION ACCEPT message being set to "Access identity 1 valid in RPLMN or equivalent PLMN".

When the UE is in the country of its HPLMN, the contents of the USIM files EF_{UAC_AIC} and EF_{ACC} as specified in 3GPP TS 31.102 [22] and the rules specified in table 4.5.2.1 are used to determine the applicability of access identity 1 and access classes 11 - 15. When the UE is in the country of its HPLMN, and the USIM file EF_{UAC_AIC} does not indicate the UE is configured for access identity 1, the UE uses the MPS indicator bit of the 5GS network feature support IE in the REGISTRATION ACCEPT message to determine if access identity 1 is valid. When the UE is in the country of its HPLMN, and the USIM file EF_{UAC_AIC} indicates the UE is configured for access identity 1, the MPS indicator bit of the 5GS network feature support IE is not applicable. When the UE is not in the country of its HPLMN, the contents of the USIM files EF_{UAC_AIC} and EF_{ACC} are not applicable.

The UE uses the MCS indicator bit of the 5GS network feature support IE to determine if access identity 2 is valid. Processing of the MCS indicator bit of the 5GS network feature support IE in the REGISTRATION ACCEPT message is described in subclause 5.5.1.2.4 and subclause 5.5.1.3.4. The UE shall not consider access identity 2 to be valid when the UE is not in the country of its HPLMN prior to receiving the MCS indicator bit of the 5GS network feature support IE in the REGISTRATION ACCEPT message being set to "Access identity 2 valid in RPLMN or equivalent PLMN".

When the UE is in the country of its HPLMN, the contents of the USIM files EF_{UAC_AIC} and EF_{ACC} as specified in 3GPP TS 31.102 [22] and the rules specified in table 4.5.2.1 are used to determine the applicability of access identity 2 and access classes 11 - 15. When the UE is in the country of its HPLMN, and the USIM file EF_{UAC_AIC} does not indicate the UE is configured for access identity 2, the UE uses the MCS indicator bit of the 5GS network feature support IE in the REGISTRATION ACCEPT message to determine if access identity 2 is valid. When the UE is in the country of its HPLMN, and the USIM file EF_{UAC_AIC} indicates the UE is configured for access identity 2, the MCS indicator bit of the 5GS network feature support IE is not applicable. When the UE is not in the country of its HPLMN, the contents of the USIM files EF_{UAC_AIC} and EF_{ACC} are not applicable.

In order to determine the access category applicable for the access attempt, the NAS shall check the rules in table 4.5.2.2, and use the access category for which there is a match for barring check. If the access attempt matches

more than one rule, the access category of the lowest rule number shall be selected. If the access attempt matches more than one operator-defined access category definition, the UE shall select the access category from the operator-defined access category definition with the lowest precedence value (see subclause 4.5.3).

NOTE: The case when an access attempt matches more than one rule includes the case when multiple events trigger an access attempt at the same time.

Table 4.5.2.2: Mapping table for access categories

| Rule # | Type of access attempt | Requirements to be met | Access Category |
|--|--|--|---|
| 1 | Response to paging or NOTIFICATION over non-3GPP access; 5GMM connection management procedure initiated for the purpose of transporting an LPP message | Access attempt is for MT access | 0 (= MT_acc) |
| 2 | Emergency | UE is attempting access for an emergency session (NOTE 1, NOTE 2) | 2 (= emergency) |
| 3 | Access attempt for operator-defined access category | UE stores operator-defined access category definitions valid in the current PLMN as specified in subclause 4.5.3, and access attempt is matching criteria of an operator-defined access category definition | 32-63
(= based on operator classification) |
| 4 | Access attempt for delay tolerant service | (a) UE is configured for NAS signalling low priority or UE supporting S1 mode is configured for EAB (see the "ExtendedAccessBarring" leaf of NAS configuration MO in 3GPP TS 24.368 [17] or 3GPP TS 31.102 [22]) where "EAB override" does not apply, and
(b) the UE received one of the categories a, b or c as part of the parameters for unified access control in the broadcast system information, and the UE is a member of the broadcasted category in the selected PLMN or RPLMN/equivalent PLMN (NOTE 3, NOTE 5, NOTE 6, NOTE 7, NOTE 8) | 1 (= delay tolerant) |
| 5 | MO MMTel voice call | Access attempt is for MO MMTel voice call or for NAS signalling connection recovery during ongoing MO MMTel voice call (NOTE 2) | 4 (= MO MMTel voice) |
| 6 | MO MMTel video call | Access attempt is for MO MMTel video call or for NAS signalling connection recovery during ongoing MO MMTel video call (NOTE 2) | 5 (= MO MMTel video) |
| 7 | MO SMS over NAS or MO SMSoIP | Access attempt is for MO SMS over NAS (NOTE 4) or MO SMS over SMSoIP transfer or for NAS signalling connection recovery during ongoing MO SMS or SMSoIP transfer (NOTE 2) | 6 (= MO SMS and SMSoIP) |
| 8 | UE NAS initiated 5GMM specific procedures | Access attempt is for MO signalling | 3 (= MO_sig) |
| 9 | UE NAS initiated 5GMM connection management procedure or 5GMM NAS transport procedure | Access attempt is for MO data | 7 (= MO_data) |
| 10 | An uplink user data packet is to be sent for a PDU session with suspended user-plane resources | No further requirement is to be met | 7 (= MO_data) |
| NOTE 1: This includes 5GMM specific procedures while the service is ongoing and 5GMM connection management procedures required to establish a PDU session with request type = "initial emergency request" or "existing emergency PDU session", or to re-establish user-plane | | | |

| | |
|---------|---|
| | resources for such a PDU session. This further includes the service request procedure initiated with a SERVICE REQUEST message with the Service type IE set to "emergency services fallback".< |
| NOTE 2: | Access for the purpose of NAS signalling connection recovery during an ongoing service, or for the purpose of NAS signalling connection establishment following fallback indication from lower layers during an ongoing service, is mapped to the access category of the ongoing service in order to derive an RRC establishment cause, but barring checks will be skipped for this access attempt. |
| NOTE 3: | If the UE selects a new PLMN, then the selected PLMN is used to check the membership; otherwise the UE uses the RLPMN or a PLMN equivalent to the RPLMN. |
| NOTE 4: | This includes the 5GMM connection management procedures triggered by the UE-initiated NAS transport procedure for transporting the MO SMS. |
| NOTE 5: | The UE configured for NAS signalling low priority is not supported in this release of specification. If a UE supporting both S1 mode and N1 mode is configured for NAS signalling low priority in S1 mode as specified in 3GPP TS 24.368 [17] or 3GPP TS 31.102 [22], the UE shall ignore the configuration for NAS signalling low priority when in N1 mode. |
| NOTE 6: | If the access category applicable for the access attempt is 1, then the UE shall additionally determine a second access category from the range 3 to 7. If more than one access category matches, the access category of the lowest rule number shall be chosen. The UE shall use the second access category only to derive an RRC establishment cause for the access attempt. |
| NOTE 7: | "EAB override" does not apply, if the UE is not configured to allow overriding EAB (see the "Override_ExtendedAccessBarring" leaf of NAS configuration MO in 3GPP TS 24.368 [17] or 3GPP TS 31.102 [22]), or if NAS has not received an indication from the upper layers to override EAB and the UE does not have a PDU session that was established with EAB override. |
| NOTE 8: | For the definition of categories a, b and c associated with access category 1, see 3GPP TS 22.261 [3]. The categories associated with access category 1 are distinct from the categories a, b and c associated with EAB (see 3GPP TS 22.011 [1A]). |

[TS 24.501, clause 4.5.4.1]

When the UE is in 5GMM-IDLE mode, upon receiving a request from the upper layers for an access attempt, the NAS shall categorize the access attempt into access identities and an access category following subclause 4.5.2, table 4.5.2.1 and table 4.5.2.2, and subclause 4.5.3, and provide the applicable access identities and the access category to the lower layers for the purpose of access control checking. In this request to the lower layer the NAS can also provide to the lower layer the RRC establishment cause determined as specified in subclause 4.5.6 of this specification.

NOTE 1: The access barring check is performed by the lower layers.

NOTE 2: As an implementation option, the NAS can provide the RRC establishment cause to the lower layers after being informed by the lower layers that the access attempt is allowed.

If the UE has uplink user data pending for one or more PDU sessions when it builds a REGISTRATION REQUEST or SERVICE REQUEST message as initial NAS message, the UE shall indicate the respective PDU sessions in the Uplink data status IE as specified in subclause 5.5.1.3.2 and 5.6.1.2, regardless of the access category for which the access barring check is performed.

NOTE 3: The UE indicates pending user data for all the respective PDU sessions, even if barring timers are running for some of the corresponding access categories.

If the lower layers indicate that the access attempt is allowed, the NAS shall initiate the procedure to send the initial NAS message for the access attempt.

If the lower layers indicate that the access attempt is barred, the NAS shall not initiate the procedure to send the initial NAS message for the access attempt. Additionally:

- a) if the event which triggered the access attempt was an MO-MMTEL-voice-call-started indication or an MO-MMTEL-video-call-started indication:
 - 1) if the UE is operating in the single-registration mode and the UE's usage setting is "voice centric", the UE may attempt to select an E-UTRA cell connected to EPC. If the UE finds a suitable E-UTRA cell connected to EPC, it then proceeds with the appropriate EMM specific procedures and, if necessary, ESM procedures to make a PDN connection providing access to IMS available; see subclause 4.8.2 and 3GPP TS 24.301 [15];
 - 2) if the UE is operating in the dual-registration mode, the UE may proceed in S1 mode with the appropriate EMM specific procedures and ESM procedures to make a PDN connection providing access to IMS available; see subclause 4.8.3 and 3GPP TS 24.301 [15];

- 3) otherwise, the NAS shall notify the upper layers that the access attempt is barred. In this case, upon receiving an indication from the lower layers that the barring is alleviated for the access category with which the access attempt was associated, the NAS shall notify the upper layers that the barring is alleviated for the access category and may initiate the procedure to send the initial NAS message, if still needed; and
- b) if the event which triggered the access attempt was an MO-SMSoIP-attempt-started indication:
- 1) if the UE is operating in the single-registration mode, the UE may attempt to select an E-UTRA cell connected to EPC. If the UE finds a suitable E-UTRA cell connected to EPC, it then proceeds with the appropriate EMM specific procedures and, if necessary, ESM procedures to make a PDN connection providing access to IMS available; see subclause 4.8.2 and 3GPP TS 24.301 [15];
 - 2) if the UE is operating in the dual-registration mode, the UE may proceed in S1 mode with the appropriate EMM specific procedures and ESM procedures to make a PDN connection providing access to IMS available; see subclause 4.8.3 and 3GPP TS 24.301 [15];
 - 3) otherwise, the NAS layer shall notify the upper layers that the access attempt is barred. In this case, upon receiving an indication from the lower layers that the barring is alleviated for the access category with which the access attempt was associated, the NAS shall notify the upper layers that the barring is alleviated for the access category and may initiate the procedure to send the initial NAS message, if still needed.

NOTE 4: Barring timers, on a per access category basis, are run by the lower layers. At expiry of barring timers, the indication of alleviation of access barring is indicated to the NAS on a per access category basis.

[TS 24.501, clause 4.5.6]

When 5GMM requests the establishment of a NAS-signalling connection, the RRC establishment cause used by the UE shall be selected according to one or more access identities (see subclause 4.5.2) and the determined access category as specified in table 4.5.6.1 and table 4.5.6.2. If the determined access category is an operator-defined access category, then the RRC establishment cause used by the UE shall be selected according to table 4.5.6.1 and table 4.5.6.2 based on one or more access identities (see subclause 4.5.2) and the standardized access category determined for the operator-defined access category as described in subclause 4.5.3.

Table 4.5.6.1: Mapping table for access identities/access categories and RRC establishment cause when establishing N1 NAS signalling connection via NR connected to 5GCN

| Access identities | Access categories | RRC establishment cause is set to |
|--|-------------------------|-----------------------------------|
| 0 | 0 (= MT_acc) | mt-Access |
| | 1 (= delay tolerant) | Not applicable (NOTE 1) |
| | 2 (= emergency) | emergency |
| | 3 (= MO_sig) | mo-Signalling |
| | 4 (= MO MMTel voice) | mo-VoiceCall |
| | 5 (= MO MMTel video) | mo-VideoCall |
| | 6 (= MO SMS and SMSoIP) | mo-SMS |
| | 7 (= MO_data) | mo-Data |
| 1 | Any category | mps-PriorityAccess |
| 2 | Any category | mcs-PriorityAccess |
| 11, 15 | Any category | highPriorityAccess |
| 12, 13, 14, | Any category | highPriorityAccess |
| NOTE 1: A UE using access category 1 for the access barring check will determine a second access category in the range 3 to 7 that is to be used for determination of the RRC establishment cause. See subclause 4.5.2, table 4.5.2.2, NOTE 6. | | |
| NOTE 2: See subclause 4.5.2, table 4.5.2.1 for use of the access identities of 0, 1, 2, and 11-15. | | |

Table 4.5.6.2: Mapping table for access identities/access categories and RRC establishment cause when establishing N1 NAS signalling connection via E-UTRA connected to 5GCN

| Access identities | Access categories | RRC establishment cause is set to |
|--|-------------------------|-----------------------------------|
| 0 | 0 (= MT_acc) | mt-Access |
| | 1 (= delay tolerant) | Not applicable (NOTE 1) |
| | 2 (= emergency) | emergency |
| | 3 (= MO_sig) | mo-Signalling |
| | 4 (= MO MMTel voice) | mo-VoiceCall |
| | 5 (= MO MMTel video) | mo-VoiceCall |
| | 6 (= MO SMS and SMSoIP) | mo-Data |
| | 7 (= MO_data) | mo-Data |
| 1 | Any category | highPriorityAccess |
| 2 | Any category | highPriorityAccess |
| 11, 15 | Any category | highPriorityAccess |
| 12,13,14, | Any category | highPriorityAccess |
| NOTE 1: A UE using access category 1 for the access barring check will determine a second access category in the range 3 to 7 that is to be used for determination of the RRC establishment cause. See subclause 4.5.2, table 4.5.2.2, NOTE 6. | | |
| NOTE 2: See subclause 4.5.2, table 4.5.2.1 for use of the access identities of 0, 1, 2, and 11-15. | | |

[TS 38.331, clause 5.3.14.1]

The purpose of this procedure is to perform access barring check for an access attempt associated with a given Access Category and one or more Access Identities upon request from upper layers according to TS 24.501 [23] or the RRC layer.

After a handover resulting in change of PCell in RRC_CONNECTED the UE shall defer access barring checks until it has obtained valid UAC information (from *SIB1*) from the target cell.

[TS 38.331, clause 5.3.14.2]

Upon initiation of the procedure, the UE shall:

- 1> if timer T390 is running for the Access Category:
 - 2> consider the access attempt as barred;
- 1> else if timer T302 is running and the Access Category is neither '2' nor '0':
 - 2> consider the access attempt as barred;
- 1> else:
 - 2> if the Access Category is '0':
 - 3> consider the access attempt as allowed;
 - 2> else:
 - 3> if *SIB1* includes *uac-BarringPerPLMN-List* and the *uac-BarringPerPLMN-List* contains an *UAC-BarringPerPLMN* entry with the *plmn-IdentityIndex* corresponding to the PLMN selected by upper layers (see TS 24.501 [23]):
 - 4> select the *UAC-BarringPerPLMN* entry with the *plmn-IdentityIndex* corresponding to the PLMN selected by upper layers;
 - 4> in the remainder of this procedure, use the selected *UAC-BarringPerPLMN* entry (i.e. presence or absence of access barring parameters in this entry) irrespective of the *uac-BarringForCommon* included in *SIB1*;
 - 3> else if *SIB1* includes *uac-BarringForCommon*:
 - 4> in the remainder of this procedure use the *uac-BarringForCommon* (i.e. presence or absence of these parameters) included in *SIB1*;

- 3> else:
 - 4> consider the access attempt as allowed;
 - 3> if *uac-BarringForCommon* is applicable or the *uac-ACBarringListType* indicates that *uac-ExplicitACBarringList* is used:
 - 4> if the corresponding *UAC-BarringPerCatList* contains a *UAC-BarringPerCat* entry corresponding to the Access Category:
 - 5> select the *UAC-BarringPerCat* entry;
 - 5> if the *uac-BarringInfoSetList* contains a *UAC-BarringInfoSet* entry corresponding to the selected *uac-barringInfoSetIndex* in the *UAC-BarringPerCat*:
 - 6> select the *UAC-BarringInfoSet* entry;
 - 6> perform access barring check for the Access Category as specified in 5.3.14.5, using the selected *UAC-BarringInfoSet* as "UAC barring parameter";
 - 5> else:
 - 6> consider the access attempt as allowed;
 - 4> else:
 - 5> consider the access attempt as allowed;
 - 3> else if the *uac-ACBarringListType* indicates that *uac-ImplicitACBarringList* is used:
 - 4> select the *uac-BarringInfoSetIndex* corresponding to the Access Category in the *uac-ImplicitACBarringList*;
 - 4> if the *uac-BarringInfoSetList* contains the *UAC-BarringInfoSet* entry corresponding to the selected *uac-BarringInfoSetIndex*:
 - 5> select the *UAC-BarringInfoSet* entry;
 - 5> perform access barring check for the Access Category as specified in 5.3.14.5, using the selected *UAC-BarringInfoSet* as "UAC barring parameter";
 - 4> else:
 - 5> consider the access attempt as allowed;
 - 3> else:
 - 4> consider the access attempt as allowed;
- 1> if the access barring check was requested by upper layers:
- 2> if the access attempt is considered as barred:
 - 3> if timer T302 is running:
 - 4> inform the upper layer that access barring is applicable for all access categories except categories '0' and '2', upon which the procedure ends;
 - 3> else:
 - 4> inform upper layers that the access attempt for the Access Category is barred, upon which the procedure ends;
 - 2> else:
 - 3> inform upper layers that the access attempt for the Access Category is allowed, upon which the procedure ends;

- 1> else:
 - 2> the procedure ends.

[TS 38.331, clause 5.3.14.4]

The UE shall:

- 1> if timer T302 expires or is stopped, and if timer T390 corresponding to an Access Category is not running; or
- 1> if timer T390 corresponding to an Access Category other than '2' expires or is stopped, and if timer T302 is not running; or
- 1> if timer T390 corresponding to the Access Category '2' expires or is stopped:
 - 2> consider the barring for this Access Category to be alleviated;
- 1> when barring for an Access Category is considered being alleviated:
 - 2> if the Access Category was informed to upper layers as barred:
 - 3> inform upper layers about barring alleviation for the Access Category.
 - 2> if barring is alleviated for Access Category '8':
 - 3> perform actions specified in 5.3.13.8;

[TS 38.331, clause 5.3.14.5]

The UE shall:

- 1> if one or more Access Identities are indicated according to TS 24.501 [23], and
- 1> if for at least one of these Access Identities the corresponding bit in the *uac-BarringForAccessIdentity* contained in "UAC barring parameter" is set to *zero*:
 - 2> consider the access attempt as allowed;
- 1> else:
 - 2> draw a random number '*rand*' uniformly distributed in the range: $0 \leq rand < 1$;
 - 2> if '*rand*' is lower than the value indicated by *uac-BarringFactor* included in "UAC barring parameter":
 - 3> consider the access attempt as allowed;
 - 2> else:
 - 3> consider the access attempt as barred;
- 1> if the access attempt is considered as barred:
 - 2> draw a random number '*rand*' that is uniformly distributed in the range $0 \leq rand < 1$;
 - 2> start timer T390 for the Access Category with the timer value calculated as follows, using the *uac-BarringTime* included in "AC barring parameter":

$$T390 = (0.7 + 0.6 * rand) * uac-BarringTime.$$

11.3.5.3 Test description

11.3.5.3.1 Pre-test conditions

System Simulator:

- 2 NR cells: NR Cell 1 and 12 as specified in TS 38.508-1 [4] table 4.4.2-3 are configured as shown in Table 11.3.5.3.1-1.

Table 11.3.5.3.1–1: PLMN identifiers

| NR Cell | PLMN names | MCC | MNC |
|------------|------------|-----|-----|
| NR Cell 1 | PLMN1 | 001 | 01 |
| NR Cell 12 | PLMN2 | 002 | 11 |

- System information combination NR-1 as defined in TS 38.508-1 [4] Table 4.4.3.1.2-1 is used in NR cells.

UE:

- The UE is equipped with a USIM configuration as defined in TS 38.508-1 [4] Table FFS.

Preamble:

- The UE is in state 1N-A on NR Cell 1(serving cell) according to TS 38.508-1 [4] Table 4.4A.2-1 and using the message condition UE TEST LOOP MODE B active with IP PDU delay = 1 second according to TS 38.508-1 [4].

11.3.5.3.2 Test procedure sequence

Table 11.3.5.3.2-1 for FR1 and Table 11.3.5.3.2-2 for FR2 illustrates the downlink power levels and other changing parameters to be applied for the cells at various time instants of the test execution. Row marked "T0" denotes the initial conditions in preamble, while columns marked "T1", "T2" and "T3" are to be applied subsequently in the Main behaviour. The exact instants on which these values shall be applied are described in the texts in this clause.

Table 11.3.5.3.2-1: Time instances of cell power level and parameter changes for FR1

| | Parameter | Unit | NR Cell 1 | NR Cell 12 | Remarks |
|--|---------------------|---------|-----------|------------|--|
| T0 | SS/PBCH
SSS EPRE | dBm/SCS | -88 | Off | The power level values are assigned to ensure UE registered on NR Cell 1. |
| T1 | SS/PBCH
SSS EPRE | dBm/SCS | Off | -80 | The power level values are assigned to ensure UE registered on NR Cell 12. |
| T2 | SS/PBCH
SSS EPRE | dBm/SCS | -80 | Off | The power level values are assigned to ensure UE registered on NR Cell 1. |
| Note 1: Power level "Off" is defined in TS 38.508-1 [4] Table 6.2.2.1-3. | | | | | |

Table 11.3.5.3.2-2: Time instances of cell power level and parameter changes for FR2

| | Parameter | Unit | NR Cell 1 | NR Cell 12 | Remarks |
|--|---------------------|---------|-----------|------------|--|
| T0 | SS/PBCH
SSS EPRE | dBm/SCS | FFS | Off | The power level values are assigned to ensure UE registered on NR Cell 1. |
| T1 | SS/PBCH
SSS EPRE | dBm/SCS | Off | FFS | The power level values are assigned to ensure UE registered on NR Cell 12. |
| T2 | SS/PBCH
SSS EPRE | dBm/SCS | FFS | Off | The power level values are assigned to ensure UE registered on NR Cell 1. |
| Note 1: Power level "Off" is defined in TS 38.508-1 [4] Table 6.2.2.2-2. | | | | | |

Table 11.3.5.3.2-3: Main behaviour

| St | Procedure | Message Sequence | | TP | Verdict |
|-----|---|------------------|--------------------------------|----|---------|
| | | U - S | Message | | |
| 1 | The SS adjusts the NR Cells power levels according to row "T1" in table 11.3.5.3.2-1/2. | - | - | - | - |
| 2 | The UE transmits <i>RRCSetupRequest</i> message within 10 s on NR cell 12.
Check: Does the <i>RRCSetupRequest</i> message includes the <i>establishmentCause</i> which is any value except <i>mps-PriorityAccess</i> ? | --> | NR RRC: <i>RRCSetupRequest</i> | 1 | P |
| 3-6 | Steps 2 to 5 of the mobility registration updating | - | - | - | - |

| | | | | | |
|--------|---|-----|---|---|---|
| | procedure described in TS 38.508-1 [4] Table 4.9.5.2.2-1 are performed on NR Cell 12. (Note 1) | | | | |
| 7-10 | Steps 5 to 8 of the NR RRC_CONNECTED procedure in TS 38.508-1 [4] Table 4.5.4.2-3 are performed. | - | - | - | - |
| 11 | SS changes SIB1 of NR Cell 12 according to Table 11.3.1.3.3-2 and send Short Message on PDCCH using P-RNTI. Wait for 2.1* modification period to allow the new system information to take effect. | <-- | PDCCH (DCI 1_0): Short Message | - | - |
| 12 | The SS transmits one IP PDU. | - | - | - | - |
| 13 | The SS transmits an <i>RRCRelease</i> message and move the UE to RRC_IDLE. | <-- | NR RRC: <i>RRCRelease</i> | - | - |
| 14 | Check: Does the UE transmit a <i>RRCSetupRequest</i> message including establishmentCause equal to <i>mps-PriorityAccess</i> within 10 s? | --> | NR RRC: <i>RRCSetupRequest</i> | 2 | P |
| 15-20 | Steps 3 to 8 of the NR RRC_CONNECTED procedure in TS 38.508-1 [4] Table 4.5.4.2-3 are performed. | - | - | - | - |
| 21 | The UE loop back the IP PDU. | - | - | - | - |
| 22 | The SS transmits DEACTIVATE TEST MODE message. | <-- | DEACTIVATE TEST MODE | - | - |
| 23 | The UE transmits DEACTIVATE TEST MODE COMPLETE message. | --> | DEACTIVATE TEST MODE COMPLETE | - | - |
| 24 | The SS transmits an <i>RRCRelease</i> message to release RRC connection and moves the UE to RRC_IDLE. | <-- | NR RRC: <i>RRCRelease</i> | - | - |
| 25 | The SS adjusts the NR Cells power levels according to row "T2" in table 11.3.5.3.2-1/2. | - | - | - | - |
| 26 | SS changes <i>SIB1</i> of NR cell 1 according to Table 11.3.5.3.3-1 and notifies the UE of change of System Information on NR Cell 1 by send Short Message on PDCCH using P-RNTI. | <-- | PDCCH (DCI 1_0): Short Message | - | - |
| 27-32a | Steps 1 to 6 of the mobility registration updating procedure described in TS 38.508-1 [4] Table 4.9.5.2.2-1 are performed on NR Cell 1. (Note 2) | - | - | - | - |
| 33 | AT command to make the UE attempt MMTEL-Video call. | - | - | - | - |
| 34 | Check: Does the UE transmit a <i>RRCSetupRequest</i> message including establishmentCause equal to <i>mps-PriorityAccess</i> within 6 s? | --> | NR RRC: <i>RRCSetupRequest</i> | 3 | F |
| 35 | SS changes <i>SIB1</i> of NR cell 1 according to Table 11.3.5.3.3-1 and notifies the UE of change of System Information on NR Cell 1 by send Short Message on PDCCH using P-RNTI. | <-- | PDCCH (DCI 1_0): Short Message | - | - |
| 36 | Wait for 2.1* modification period to allow the new system information to take effect. | - | - | - | - |
| 37 | Make the UE attempt another MMTEL-Video call. | - | - | - | - |
| 38 | Check: Does the UE transmit a <i>RRCSetupRequest</i> message including establishmentCause equal to <i>mps-PriorityAccess</i> within 10 s? | --> | NR RRC: <i>RRCSetupRequest</i> | 4 | P |
| 39-44 | Steps 3-8 of expected sequence from Table 4.5.4.2-3 as defined in 38.508-1 [4] is performed. | - | - | - | - |
| - | EXCEPTION: In parallel to the events described in steps 42-44 below the events specified in steps FFS of the expected sequence defined in annex FFS of 34.229-5 [41] takes place.
Editor's Note: generic procedure to be provided in TS 34.229-5 | - | - | - | - |
| 45 | The SS transmits an RRCReconfiguration message and an PDU SESSION MODIFICATION COMMAND | <-- | NR RRC: RRCReconfiguration
5GMM: DL NAS TRANSPORT
5GSM: PDU SESSION | - | - |

| | | | | | |
|---|---|-----|--|---|---|
| | | | MODIFICATION COMMAND | | |
| 46 | The UE transmits an RRCReconfigurationComplete message | --> | NR RRC:
RRCReconfigurationComplete | - | - |
| 47 | Check: Does the UE transmit a ULInformationTransfer message, an UL NAS TRANSPORT message and an PDU SESSION MODIFICATION COMPLETE message? | --> | NR RRC: ULInformationTransfer
5GMM: UL NAS TRANSPORT
5GSM: PDU SESSION MODIFICATION COMPLETE | - | - |
| 48 | UE is triggered by MMI to release the call. | - | - | - | - |
| 49 | The Generic test procedure for MO Release of Voice Call / 5GS as specified in Annex A.7 of TS 34.229-5 [41] takes place.
Editor's Note: we should also depict the lower layers here that than might call 34.229-5. | - | - | - | - |
| Note 1: The SS includes a 5GS network feature support IE in the REGISTRATION ACCEPT message configured as Table 11.3.5.3.3-3. | | | | | |
| Note 2: The UE performs mobility registration updating procedure and the RRC connection is released. | | | | | |

Editor's Note: Test Procedures for IMS MO Video call establishment in 5GC are FFS.

11.3.5.3.3 Specific message contents

Table 11.3.5.3.3-1: SIB1 of NR Cell 1 (Preamble, step 26 and step 32 , Table 11.3.5.3.2-3)

| Derivation Path: TS 38.508-1 [4], Table 4.6.1-28 | | | |
|--|--------------|--|----------------------|
| Information Element | Value/remark | Comment | Condition |
| SIB1 ::= SEQUENCE { | | | |
| uac-BarringInfo SEQUENCE { | | | Preamble and step 26 |
| uac-BarringForCommon SEQUENCE (SIZE (1..maxAccessCat-1)) OF UAC-BarringPerCat { | 1 entry | | |
| UAC-BarringPerCat[1] SEQUENCE { | | entry 1 | |
| accessCategory | 5 | (= MO MMTel video) | |
| uac-barringInfoSetIndex | 1 | Value 1 corresponds to the first entry in uac-BarringInfoSetList | |
| } | | | |
| } | | | |
| uac-BarringPerPLMN-List | Not present | | |
| uac-BarringInfoSetList SEQUENCE (SIZE(1..maxBarringInfoSet)) OF UAC-BarringInfoSet { | 1 entry | | |
| UAC-BarringInfoSet[1] SEQUENCE { | | entry 1 | |
| uac-BarringFactor | p00 | 0% access probability | |
| uac-BarringTime | s16 | 16 s | |
| uac-BarringForAccessIdentity | '1111111'B | Value 1 means that access attempt is not allowed for the corresponding access identity.
The leftmost bit, bit 0 in the bit string corresponds to Access Identity 1. | |
| } | | | |
| } | | | |
| uac-AccessCategory1-SelectionAssistanceInfo | Not Present | | |
| } | | | |
| uac-BarringInfo | Not present | | Step 35 |
| } | | | |

Table 11.3.5.3.3-2: SIB1 of NR Cell 12 (Step 1 and step 11, Table 11.3.5.3.2-3)

| Derivation Path: TS 38.508-1 [4], Table 4.6.1-28 | | | |
|--|--------------|---|-----------|
| Information Element | Value/remark | Comment | Condition |
| SIB1 ::= SEQUENCE { | | | |
| uac-BarringInfo SEQUENCE { | | | Step 1 |
| uac-BarringForCommon SEQUENCE (SIZE(1..maxAccessCat-1)) OF UAC-BarringPerCat { | 1 entry | | |
| UAC-BarringPerCat[1] SEQUENCE { | | entry 1 | |
| accessCategory | 3 | (= MO_sig) | |
| uac-barringInfoSetIndex | 1 | Value 1 corresponds to the first entry in uac-BarringInfoSetList | |
| } | | | |
| } | | | |
| uac-BarringPerPLMN-List | Not present | | |
| uac-BarringInfoSetList SEQUENCE (SIZE(1..maxBarringInfoSet)) OF UAC-BarringInfoSet { | 1 entry | | |
| UAC-BarringInfoSet[1] SEQUENCE { | | entry 1 | |
| uac-BarringFactor | p00 | 0% access probability | |
| uac-BarringTime | s16 | 16 s | |
| uac-BarringForAccessIdentity | '1111111'B | Value 1 means that access attempt is not allowed for the corresponding access identity. The leftmost bit, bit 0 in the bit string corresponds to Access Identity 1. | |
| } | | | |
| } | | | |
| uac-AccessCategory1-SelectionAssistanceInfo | Not Present | | |
| } | | | |
| uac-BarringInfo | Not present | | Step 11 |
| } | | | |

Table 11.3.5.3.3-3: REGISTRATION ACCEPT(step 5, Table 11.3.5.3.2-3)

| Derivation path: TS 38.508 [4] Table 4.7.1-7 | | | |
|--|------------------------|--|-----------|
| Information Element | Value/remark | Comment | Condition |
| 5GS network feature support | '1000 0001 0000 0000'B | Access identity 1 valid in RPLMN or equivalent PLMN. IMS voice over PS session supported over 3GPP access. All other features set to "not supported" including the 'Interworking without N26 interface not supported'. | |

11.3.6 UAC / Access Identity 2 / New cell not in the country of its HPLMN/EHPLMN 0% access probability/MCS indicator / HPLMN/0%/100% accessibility AC7/RRC_INACTIVE

11.3.6.1 Test Purpose (TP)

(1)

```
with { UE configured for Access Identity 2 }
ensure that {
  when { UE moves to a new cell which is not in the country of its HPLMN or in an EHPLMN (if the
EHPLMN list is present) having received SIB1 message including UAC set to 0% accessibility for
Access Identity 2 }
  then { UE does not consider Access Identity 2 as valid and continues with the REGISTRATION
procedure }
}
```

(2)

```
with { UE configured for Access Identity 2 }
ensure that {
  when { UE moves to a new cell which is not in the country of its HPLMN or in an EHPLMN (if the
EHPLMN list is present) but receives the MCS indicator bit of the 5GS network feature support IE in
the REGISTRATION ACCEPT message being set to "Access identity 2 valid" }
  then { UE does consider Access Identity 2 as valid }
}
```

(3)

```
with { UE configured for Access Identity 2 having received SIB1 containing UAC Info indicating 0%
accessibility for Access Category 7 camped in NR RRC_INACTIVE state on HPLMN }
ensure that {
  when { UE attempts to send uplink user data packet for a PDU session with suspended user-plane
resources }
  then { UE does not attempt to initiate connection on the NR Cell until barring is alleviated }
}
```

(4)

```
with { UE configured for Access Identity 2 having received SIB1 containing UAC Info indicating 100%
accessibility for Access Category 7 while camped on HPLMN in NR RRC_INACTIVE state }
ensure that {
  when { UE attempts to send uplink user data packet for a PDU session with suspended user-plane
resources }
  then { UE initiates RRC Resume procedure with establishmentCause set to mcs-PriorityAccess }
}
```

11.3.6.2 Conformance requirements

References: The conformance requirements covered in the present TC are specified in TS 24.501: clause 4.5.2, 4.5.4.1 and 4.5.6 and TS 38.331: clause 5.3.14.1, 5.3.14.2, 5.3.14.4 and 5.3.14.5. Unless otherwise stated these are Rel-15 requirements.

[TS 24.501, clause 4.5.2]

When the UE needs to initiate an access attempt in one of the events listed in subclause 4.5.1, the UE shall determine one or more access identities from the set of standardized access identities, and one access category from the set of standardized access categories and operator-defined access categories, to be associated with that access attempt.

The set of the access identities applicable for the request is determined by the UE in the following way:

- a) for each of the access identities 1, 2, 11, 12, 13, 14 and 15 in table 4.5.2.1, the UE shall check whether the access identity is applicable in the selected PLMN, if a new PLMN is selected, or otherwise if it is applicable in the RPLMN or equivalent PLMN; and
- b) if none of the above access identities is applicable, then access identity 0 is applicable.

Table 4.5.2.1: Access identities

| Access Identity number | UE configuration |
|--|--|
| 0 | UE is not configured with any parameters from this table |
| 1 (NOTE 1) | UE is configured for multimedia priority service (MPS). |
| 2 (NOTE 2) | UE is configured for mission critical service (MCS). |
| 3-10 | Reserved for future use |
| 11 (NOTE 3) | Access Class 11 is configured in the UE. |
| 12 (NOTE 3) | Access Class 12 is configured in the UE. |
| 13 (NOTE 3) | Access Class 13 is configured in the UE. |
| 14 (NOTE 3) | Access Class 14 is configured in the UE. |
| 15 (NOTE 3) | Access Class 15 is configured in the UE. |
| <p>NOTE 1: Access identity 1 is valid when:</p> <ul style="list-style-type: none"> - the USIM file EF_{UAC_AIC} indicates the UE is configured for access identity 1 and the RPLMN is the HPLMN (if the EHPLMN list is not present or is empty) or EHPLMN (if the EHPLMN list is present), or a visited PLMN of the home country (see the definition of home country in 3GPP TS 24.301 [15]); or - the UE receives the 5GS network feature support IE with the MPS indicator bit set to "Access identity 1 valid in RPLMN or equivalent PLMN" from the RPLMN as described in subclause 5.5.1.2.4 and subclause 5.5.1.3.4. <p>NOTE 2: Access identity 2 is used by UEs configured for MCS and is valid when:</p> <ul style="list-style-type: none"> - the USIM file EF_{UAC_AIC} indicates the UE is configured for access identity 2 and the RPLMN is the HPLMN (if the EHPLMN list is not present or is empty) or EHPLMN (if the EHPLMN list is present), or a visited PLMN of the home country (see 3GPP TS 23.122 [5]); or - the UE receives the 5GS network feature support IE with the MCS indicator bit set to "Access identity 2 valid in RPLMN or equivalent PLMN" from the RPLMN as described in subclause 5.5.1.2.4 and subclause 5.5.1.3.4. <p>NOTE 3: Access identities 11 and 15 are valid in HPLMN (if the EHPLMN list is not present or is empty) or EHPLMN (if the EHPLMN list is present). Access Identities 12, 13 and 14 are valid in HPLMN and visited PLMNs of home country only (see the definition of home country in 3GPP TS 24.301 [15]).</p> | |

The UE uses the MPS indicator bit of the 5GS network feature support IE to determine if access identity 1 is valid. Processing of the MPS indicator bit of the 5GS network feature support IE in the REGISTRATION ACCEPT message is described in subclause 5.5.1.2.4 and subclause 5.5.1.3.4. The UE shall not consider access identity 1 to be valid when the UE is not in the country of its HPLMN prior to receiving the MPS indicator bit of the 5GS network feature support IE in the REGISTRATION ACCEPT message being set to "Access identity 1 valid in RPLMN or equivalent PLMN".

When the UE is in the country of its HPLMN, the contents of the USIM files EF_{UAC_AIC} and EF_{ACC} as specified in 3GPP TS 31.102 [22] and the rules specified in table 4.5.2.1 are used to determine the applicability of access identity 1 and access classes 11 - 15. When the UE is in the country of its HPLMN, and the USIM file EF_{UAC_AIC} does not indicate the UE is configured for access identity 1, the UE uses the MPS indicator bit of the 5GS network feature support IE in the REGISTRATION ACCEPT message to determine if access identity 1 is valid. When the UE is in the country of its HPLMN, and the USIM file EF_{UAC_AIC} indicates the UE is configured for access identity 1, the MPS indicator bit of the 5GS network feature support IE is not applicable. When the UE is not in the country of its HPLMN, the contents of the USIM files EF_{UAC_AIC} and EF_{ACC} are not applicable.

The UE uses the MCS indicator bit of the 5GS network feature support IE to determine if access identity 2 is valid. Processing of the MCS indicator bit of the 5GS network feature support IE in the REGISTRATION ACCEPT message is described in subclause 5.5.1.2.4 and subclause 5.5.1.3.4. The UE shall not consider access identity 2 to be valid when the UE is not in the country of its HPLMN prior to receiving the MCS indicator bit of the 5GS network feature support IE in the REGISTRATION ACCEPT message being set to "Access identity 2 valid in RPLMN or equivalent PLMN".

When the UE is in the country of its HPLMN, the contents of the USIM files EF_{UAC_AIC} and EF_{ACC} as specified in 3GPP TS 31.102 [22] and the rules specified in table 4.5.2.1 are used to determine the applicability of access identity 2 and access classes 11 - 15. When the UE is in the country of its HPLMN, and the USIM file EF_{UAC_AIC} does not indicate the UE is configured for access identity 2, the UE uses the MCS indicator bit of the 5GS network feature support IE in the REGISTRATION ACCEPT message to determine if access identity 2 is valid. When the UE is in the country of its HPLMN, and the USIM file EF_{UAC_AIC} indicates the UE is configured for access identity 2, the MCS indicator bit of the 5GS network feature support IE is not applicable. When the UE is not in the country of its HPLMN, the contents of the USIM files EF_{UAC_AIC} and EF_{ACC} are not applicable.

In order to determine the access category applicable for the access attempt, the NAS shall check the rules in table 4.5.2.2, and use the access category for which there is a match for barring check. If the access attempt matches

more than one rule, the access category of the lowest rule number shall be selected. If the access attempt matches more than one operator-defined access category definition, the UE shall select the access category from the operator-defined access category definition with the lowest precedence value (see subclause 4.5.3).

NOTE: The case when an access attempt matches more than one rule includes the case when multiple events trigger an access attempt at the same time.

Table 4.5.2.2: Mapping table for access categories

| Rule # | Type of access attempt | Requirements to be met | Access Category |
|--|--|--|---|
| 1 | Response to paging or NOTIFICATION over non-3GPP access; 5GMM connection management procedure initiated for the purpose of transporting an LPP message | Access attempt is for MT access | 0 (= MT_acc) |
| 2 | Emergency | UE is attempting access for an emergency session (NOTE 1, NOTE 2) | 2 (= emergency) |
| 3 | Access attempt for operator-defined access category | UE stores operator-defined access category definitions valid in the current PLMN as specified in subclause 4.5.3, and access attempt is matching criteria of an operator-defined access category definition | 32-63
(= based on operator classification) |
| 4 | Access attempt for delay tolerant service | (a) UE is configured for NAS signalling low priority or UE supporting S1 mode is configured for EAB (see the "ExtendedAccessBarring" leaf of NAS configuration MO in 3GPP TS 24.368 [17] or 3GPP TS 31.102 [22]) where "EAB override" does not apply, and
(b) the UE received one of the categories a, b or c as part of the parameters for unified access control in the broadcast system information, and the UE is a member of the broadcasted category in the selected PLMN or RPLMN/equivalent PLMN (NOTE 3, NOTE 5, NOTE 6, NOTE 7, NOTE 8) | 1 (= delay tolerant) |
| 5 | MO MMTel voice call | Access attempt is for MO MMTel voice call or for NAS signalling connection recovery during ongoing MO MMTel voice call (NOTE 2) | 4 (= MO MMTel voice) |
| 6 | MO MMTel video call | Access attempt is for MO MMTel video call or for NAS signalling connection recovery during ongoing MO MMTel video call (NOTE 2) | 5 (= MO MMTel video) |
| 7 | MO SMS over NAS or MO SMSoIP | Access attempt is for MO SMS over NAS (NOTE 4) or MO SMS over SMSoIP transfer or for NAS signalling connection recovery during ongoing MO SMS or SMSoIP transfer (NOTE 2) | 6 (= MO SMS and SMSoIP) |
| 8 | UE NAS initiated 5GMM specific procedures | Access attempt is for MO signalling | 3 (= MO_sig) |
| 9 | UE NAS initiated 5GMM connection management procedure or 5GMM NAS transport procedure | Access attempt is for MO data | 7 (= MO_data) |
| 10 | An uplink user data packet is to be sent for a PDU session with suspended user-plane resources | No further requirement is to be met | 7 (= MO_data) |
| NOTE 1: This includes 5GMM specific procedures while the service is ongoing and 5GMM connection management procedures required to establish a PDU session with request type = "initial emergency request" or "existing emergency PDU session", or to re-establish user-plane | | | |

| | |
|---------|---|
| | resources for such a PDU session. This further includes the service request procedure initiated with a SERVICE REQUEST message with the Service type IE set to "emergency services fallback".< |
| NOTE 2: | Access for the purpose of NAS signalling connection recovery during an ongoing service, or for the purpose of NAS signalling connection establishment following fallback indication from lower layers during an ongoing service, is mapped to the access category of the ongoing service in order to derive an RRC establishment cause, but barring checks will be skipped for this access attempt. |
| NOTE 3: | If the UE selects a new PLMN, then the selected PLMN is used to check the membership; otherwise the UE uses the RPLMN or a PLMN equivalent to the RPLMN. |
| NOTE 4: | This includes the 5GMM connection management procedures triggered by the UE-initiated NAS transport procedure for transporting the MO SMS. |
| NOTE 5: | The UE configured for NAS signalling low priority is not supported in this release of specification. If a UE supporting both S1 mode and N1 mode is configured for NAS signalling low priority in S1 mode as specified in 3GPP TS 24.368 [17] or 3GPP TS 31.102 [22], the UE shall ignore the configuration for NAS signalling low priority when in N1 mode. |
| NOTE 6: | If the access category applicable for the access attempt is 1, then the UE shall additionally determine a second access category from the range 3 to 7. If more than one access category matches, the access category of the lowest rule number shall be chosen. The UE shall use the second access category only to derive an RRC establishment cause for the access attempt. |
| NOTE 7: | "EAB override" does not apply, if the UE is not configured to allow overriding EAB (see the "Override_ExtendedAccessBarring" leaf of NAS configuration MO in 3GPP TS 24.368 [17] or 3GPP TS 31.102 [22]), or if NAS has not received an indication from the upper layers to override EAB and the UE does not have a PDU session that was established with EAB override. |
| NOTE 8: | For the definition of categories a, b and c associated with access category 1, see 3GPP TS 22.261 [3]. The categories associated with access category 1 are distinct from the categories a, b and c associated with EAB (see 3GPP TS 22.011 [1A]). |

[TS 24.501, clause 4.5.4.1]

When the UE is in 5GMM-IDLE mode, upon receiving a request from the upper layers for an access attempt, the NAS shall categorize the access attempt into access identities and an access category following subclause 4.5.2, table 4.5.2.1 and table 4.5.2.2, and subclause 4.5.3, and provide the applicable access identities and the access category to the lower layers for the purpose of access control checking. In this request to the lower layer the NAS can also provide to the lower layer the RRC establishment cause determined as specified in subclause 4.5.6 of this specification.

NOTE 1: The access barring check is performed by the lower layers.

NOTE 2: As an implementation option, the NAS can provide the RRC establishment cause to the lower layers after being informed by the lower layers that the access attempt is allowed.

If the UE has uplink user data pending for one or more PDU sessions when it builds a REGISTRATION REQUEST or SERVICE REQUEST message as initial NAS message, the UE shall indicate the respective PDU sessions in the Uplink data status IE as specified in subclause 5.5.1.3.2 and 5.6.1.2, regardless of the access category for which the access barring check is performed.

NOTE 3: The UE indicates pending user data for all the respective PDU sessions, even if barring timers are running for some of the corresponding access categories.

If the lower layers indicate that the access attempt is allowed, the NAS shall initiate the procedure to send the initial NAS message for the access attempt.

If the lower layers indicate that the access attempt is barred, the NAS shall not initiate the procedure to send the initial NAS message for the access attempt. Additionally:

- a) if the event which triggered the access attempt was an MO-MMTEL-voice-call-started indication or an MO-MMTEL-video-call-started indication:
 - 1) if the UE is operating in the single-registration mode and the UE's usage setting is "voice centric", the UE may attempt to select an E-UTRA cell connected to EPC. If the UE finds a suitable E-UTRA cell connected to EPC, it then proceeds with the appropriate EMM specific procedures and, if necessary, ESM procedures to make a PDN connection providing access to IMS available; see subclause 4.8.2 and 3GPP TS 24.301 [15];
 - 2) if the UE is operating in the dual-registration mode, the UE may proceed in S1 mode with the appropriate EMM specific procedures and ESM procedures to make a PDN connection providing access to IMS available; see subclause 4.8.3 and 3GPP TS 24.301 [15];

- 3) otherwise, the NAS shall notify the upper layers that the access attempt is barred. In this case, upon receiving an indication from the lower layers that the barring is alleviated for the access category with which the access attempt was associated, the NAS shall notify the upper layers that the barring is alleviated for the access category and may initiate the procedure to send the initial NAS message, if still needed; and
- b) if the event which triggered the access attempt was an MO-SMSoIP-attempt-started indication:
- 1) if the UE is operating in the single-registration mode, the UE may attempt to select an E-UTRA cell connected to EPC. If the UE finds a suitable E-UTRA cell connected to EPC, it then proceeds with the appropriate EMM specific procedures and, if necessary, ESM procedures to make a PDN connection providing access to IMS available; see subclause 4.8.2 and 3GPP TS 24.301 [15];
 - 2) if the UE is operating in the dual-registration mode, the UE may proceed in S1 mode with the appropriate EMM specific procedures and ESM procedures to make a PDN connection providing access to IMS available; see subclause 4.8.3 and 3GPP TS 24.301 [15];
 - 3) otherwise, the NAS layer shall notify the upper layers that the access attempt is barred. In this case, upon receiving an indication from the lower layers that the barring is alleviated for the access category with which the access attempt was associated, the NAS shall notify the upper layers that the barring is alleviated for the access category and may initiate the procedure to send the initial NAS message, if still needed.

NOTE 4: Barring timers, on a per access category basis, are run by the lower layers. At expiry of barring timers, the indication of alleviation of access barring is indicated to the NAS on a per access category basis.

[TS 24.501, clause 4.5.6]

When 5GMM requests the establishment of a NAS-signalling connection, the RRC establishment cause used by the UE shall be selected according to one or more access identities (see subclause 4.5.2) and the determined access category as specified in table 4.5.6.1 and table 4.5.6.2. If the determined access category is an operator-defined access category, then the RRC establishment cause used by the UE shall be selected according to table 4.5.6.1 and table 4.5.6.2 based on one or more access identities (see subclause 4.5.2) and the standardized access category determined for the operator-defined access category as described in subclause 4.5.3.

Table 4.5.6.1: Mapping table for access identities/access categories and RRC establishment cause when establishing N1 NAS signalling connection via NR connected to 5GCN

| Access identities | Access categories | RRC establishment cause is set to |
|--|-------------------------|-----------------------------------|
| 0 | 0 (= MT_acc) | mt-Access |
| | 1 (= delay tolerant) | Not applicable (NOTE 1) |
| | 2 (= emergency) | emergency |
| | 3 (= MO_sig) | mo-Signalling |
| | 4 (= MO MMTel voice) | mo-VoiceCall |
| | 5 (= MO MMTel video) | mo-VideoCall |
| | 6 (= MO SMS and SMSoIP) | mo-SMS |
| | 7 (= MO_data) | mo-Data |
| 1 | Any category | mps-PriorityAccess |
| 2 | Any category | mcs-PriorityAccess |
| 11, 15 | Any category | highPriorityAccess |
| 12,13,14, | Any category | highPriorityAccess |
| NOTE 1: A UE using access category 1 for the access barring check will determine a second access category in the range 3 to 7 that is to be used for determination of the RRC establishment cause. See subclause 4.5.2, table 4.5.2.2, NOTE 6. | | |
| NOTE 2: See subclause 4.5.2, table 4.5.2.1 for use of the access identities of 0, 1, 2, and 11-15. | | |

Table 4.5.6.2: Mapping table for access identities/access categories and RRC establishment cause when establishing N1 NAS signalling connection via E-UTRA connected to 5GCN

| Access identities | Access categories | RRC establishment cause is set to |
|--|-------------------------|-----------------------------------|
| 0 | 0 (= MT_acc) | mt-Access |
| | 1 (= delay tolerant) | Not applicable (NOTE 1) |
| | 2 (= emergency) | emergency |
| | 3 (= MO_sig) | mo-Signalling |
| | 4 (= MO MMTel voice) | mo-VoiceCall |
| | 5 (= MO MMTel video) | mo-VoiceCall |
| | 6 (= MO SMS and SMSoIP) | mo-Data |
| | 7 (= MO_data) | mo-Data |
| 1 | Any category | highPriorityAccess |
| 2 | Any category | highPriorityAccess |
| 11, 15 | Any category | highPriorityAccess |
| 12,13,14, | Any category | highPriorityAccess |
| NOTE 1: A UE using access category 1 for the access barring check will determine a second access category in the range 3 to 7 that is to be used for determination of the RRC establishment cause. See subclause 4.5.2, table 4.5.2.2, NOTE 6. | | |
| NOTE 2: See subclause 4.5.2, table 4.5.2.1 for use of the access identities of 0, 1, 2, and 11-15. | | |

[TS 38.331, clause 5.3.14.1]

The purpose of this procedure is to perform access barring check for an access attempt associated with a given Access Category and one or more Access Identities upon request from upper layers according to TS 24.501 [23] or the RRC layer.

After a handover resulting in change of PCell in RRC_CONNECTED the UE shall defer access barring checks until it has obtained valid UAC information (from *SIB1*) from the target cell.

[TS 38.331, clause 5.3.14.2]

Upon initiation of the procedure, the UE shall:

- 1> if timer T390 is running for the Access Category:
 - 2> consider the access attempt as barred;
- 1> else if timer T302 is running and the Access Category is neither '2' nor '0':
 - 2> consider the access attempt as barred;
- 1> else:
 - 2> if the Access Category is '0':
 - 3> consider the access attempt as allowed;
 - 2> else:
 - 3> if *SIB1* includes *uac-BarringPerPLMN-List* and the *uac-BarringPerPLMN-List* contains an *UAC-BarringPerPLMN* entry with the *plmn-IdentityIndex* corresponding to the PLMN selected by upper layers (see TS 24.501 [23]):
 - 4> select the *UAC-BarringPerPLMN* entry with the *plmn-IdentityIndex* corresponding to the PLMN selected by upper layers;
 - 4> in the remainder of this procedure, use the selected *UAC-BarringPerPLMN* entry (i.e. presence or absence of access barring parameters in this entry) irrespective of the *uac-BarringForCommon* included in *SIB1*;
 - 3> else if *SIB1* includes *uac-BarringForCommon*:
 - 4> in the remainder of this procedure use the *uac-BarringForCommon* (i.e. presence or absence of these parameters) included in *SIB1*;

- 3> else:
 - 4> consider the access attempt as allowed;
- 3> if *uac-BarringForCommon* is applicable or the *uac-ACBarringListType* indicates that *uac-ExplicitACBarringList* is used:
 - 4> if the corresponding *UAC-BarringPerCatList* contains a *UAC-BarringPerCat* entry corresponding to the Access Category:
 - 5> select the *UAC-BarringPerCat* entry;
 - 5> if the *uac-BarringInfoSetList* contains a *UAC-BarringInfoSet* entry corresponding to the selected *uac-barringInfoSetIndex* in the *UAC-BarringPerCat*:
 - 6> select the *UAC-BarringInfoSet* entry;
 - 6> perform access barring check for the Access Category as specified in 5.3.14.5, using the selected *UAC-BarringInfoSet* as "UAC barring parameter";
 - 5> else:
 - 6> consider the access attempt as allowed;
- 4> else:
 - 5> consider the access attempt as allowed;
- 3> else if the *uac-ACBarringListType* indicates that *uac-ImplicitACBarringList* is used:
 - 4> select the *uac-BarringInfoSetIndex* corresponding to the Access Category in the *uac-ImplicitACBarringList*;
 - 4> if the *uac-BarringInfoSetList* contains the *UAC-BarringInfoSet* entry corresponding to the selected *uac-BarringInfoSetIndex*:
 - 5> select the *UAC-BarringInfoSet* entry;
 - 5> perform access barring check for the Access Category as specified in 5.3.14.5, using the selected *UAC-BarringInfoSet* as "UAC barring parameter";
 - 4> else:
 - 5> consider the access attempt as allowed;
- 3> else:
 - 4> consider the access attempt as allowed;
- 1> if the access barring check was requested by upper layers:
 - 2> if the access attempt is considered as barred:
 - 3> if timer T302 is running:
 - 4> inform the upper layer that access barring is applicable for all access categories except categories '0' and '2', upon which the procedure ends;
 - 3> else:
 - 4> inform upper layers that the access attempt for the Access Category is barred, upon which the procedure ends;
 - 2> else:
 - 3> inform upper layers that the access attempt for the Access Category is allowed, upon which the procedure ends;

- 1> else:
 - 2> the procedure ends.

[TS 38.331, clause 5.3.14.4]

The UE shall:

- 1> if timer T302 expires or is stopped, and if timer T390 corresponding to an Access Category is not running; or
- 1> if timer T390 corresponding to an Access Category other than '2' expires or is stopped, and if timer T302 is not running; or
- 1> if timer T390 corresponding to the Access Category '2' expires or is stopped:
 - 2> consider the barring for this Access Category to be alleviated;
- 1> when barring for an Access Category is considered being alleviated:
 - 2> if the Access Category was informed to upper layers as barred:
 - 3> inform upper layers about barring alleviation for the Access Category.
 - 2> if barring is alleviated for Access Category '8':
 - 3> perform actions specified in 5.3.13.8;

[TS 38.331, clause 5.3.14.5]

The UE shall:

- 1> if one or more Access Identities are indicated according to TS 24.501 [23], and
- 1> if for at least one of these Access Identities the corresponding bit in the *uac-BarringForAccessIdentity* contained in "UAC barring parameter" is set to *zero*:
 - 2> consider the access attempt as allowed;
- 1> else:
 - 2> draw a random number '*rand*' uniformly distributed in the range: $0 \leq rand < 1$;
 - 2> if '*rand*' is lower than the value indicated by *uac-BarringFactor* included in "UAC barring parameter":
 - 3> consider the access attempt as allowed;
 - 2> else:
 - 3> consider the access attempt as barred;
- 1> if the access attempt is considered as barred:
 - 2> draw a random number '*rand*' that is uniformly distributed in the range $0 \leq rand < 1$;
 - 2> start timer T390 for the Access Category with the timer value calculated as follows, using the *uac-BarringTime* included in "AC barring parameter":

$$T390 = (0.7 + 0.6 * rand) * uac-BarringTime.$$

11.3.6.3 Test description

11.3.6.3.1 Pre-test conditions

System Simulator:

- 2 NR cells: NR Cell 1 and 12 as specified in TS 38.508-1[4] table 4.4.2-3 are configured as shown in Table 11.3.6.3.1-1.

Table 11.3.6.3.1–1: PLMN identifiers

| NR Cell | PLMN names | MCC | MNC |
|------------|------------|-----|-----|
| NR Cell 1 | PLMN1 | 001 | 01 |
| NR Cell 12 | PLMN2 | 002 | 11 |

- System information combination NR-1 as defined in TS 38.508-1 [4] Table 4.4.3.1.2-1 is used in NR cells.

UE:

- The UE is equipped with a USIM configuration as defined in TS 38.508-1 [4] Table 6.4.1-19.

Preamble:

- The UE is in state 1N-A on NR Cell 1(serving cell) according to TS 38.508-1 [4] Table 4.4A.2-1 and using the message condition UE TEST LOOP MODE B active with IP PDU delay = 1 second according to TS 38.508-1 [4].

11.3.6.3.2 Test procedure sequence

Table 11.3.6.3.2-1 for FR1 and Table 11.3.6.3.2-2 for FR2 illustrates the downlink power levels and other changing parameters to be applied for the cells at various time instants of the test execution. Row marked "T0" denotes the initial conditions in preamble, while columns marked "T1", "T2" and "T3" are to be applied subsequently in the Main behaviour. The exact instants on which these values shall be applied are described in the texts in this clause.

Table 11.3.6.3.2-1: Cell configuration changes over time for FR1

| | Parameter | Unit | NR Cell 1 | NR Cell 12 | Remarks |
|--|---------------------|---------|-----------|------------|--|
| T0 | SS/PBCH
SSS EPRE | dBm/SCS | -88 | Off | The power level values are assigned to ensure UE registered on NR Cell 1. |
| T1 | SS/PBCH
SSS EPRE | dBm/SCS | Off | -80 | The power level values are assigned to ensure UE registered on NR Cell 12. |
| T2 | SS/PBCH
SSS EPRE | dBm/SCS | -80 | Off | The power level values are assigned to ensure UE registered on NR Cell 1. |
| Note 1: Power level "Off" is defined in TS 38.508-1 [4] Table 6.2.2.1-3. | | | | | |

Table 11.3.6.3.2-2: Cell configuration changes over time for FR2

| | Parameter | Unit | NR Cell 1 | NR Cell 12 | Remarks |
|--|---------------------|---------|-----------|------------|--|
| T0 | SS/PBCH
SSS EPRE | dBm/SCS | FFS | Off | The power level values are assigned to ensure UE registered on NR Cell 1. |
| T1 | SS/PBCH
SSS EPRE | dBm/SCS | Off | FFS | The power level values are assigned to ensure UE registered on NR Cell 12. |
| T2 | SS/PBCH
SSS EPRE | dBm/SCS | FFS | Off | The power level values are assigned to ensure UE registered on NR Cell 1. |
| Note 1: Power level "Off" is defined in TS 38.508-1 [4] Table 6.2.2.2-2. | | | | | |

Table 11.3.6.3.2-3: Main behaviour

| St | Procedure | Message Sequence | | TP | Verdict |
|-----|---|------------------|--------------------------------|----|---------|
| | | U - S | Message | | |
| 1 | The SS adjusts the NR Cells power levels according to row "T1" in table 11.3.6.3.2-1/2. | - | - | - | - |
| 2 | The UE transmit a <i>RRCSetupRequest</i> message within 10 s on NR cell 12.
Check: Does the <i>RRCSetupRequest</i> message include the <i>establishmentCause</i> which is any value except <i>mcs-PriorityAccess</i> ? | --> | NR RRC: <i>RRCSetupRequest</i> | 1 | P |
| 3-6 | Steps 2 to 5 of the mobility registration updating | - | - | - | - |

| | | | | | |
|---|---|-----|--|---|---|
| | procedure described in TS 38.508-1 [4] Table 4.9.5.2.2-1 are performed on NR Cell 12. (Note 1) | | | | |
| 6A-6D | Steps 5 to 8 of the NR RRC_CONNECTED procedure in TS 38.508-1 Table 4.5.4.2-3 are performed. | - | - | - | - |
| 7 | The SS transmits one IP PDU. | - | - | - | - |
| 8 | The SS transmits an <i>RRCRelease</i> message and move the UE to RRC_IDLE. | <-- | NR RRC: <i>RRCRelease</i> | - | - |
| 9 | Check: Does the UE transmit a <i>RRCSetupRequest</i> message including <i>establishmentCause</i> of <i>mcs-PriorityAccess</i> within 10 s? | --> | NR RRC: <i>RRCSetupRequest</i> | 2 | P |
| 10 | SS transmit an <i>RRCSetup</i> message. | <-- | NR RRC: <i>RRCSetup</i> | - | - |
| 11 | The UE transmits an <i>RRCSetupComplete</i> message to confirm the successful completion of the connection establishment. | --> | NR RRC: <i>RRCSetupComplete</i>
5GMM: SERVICE REQUEST | - | - |
| 11A-11D | Steps 5 to 8 of the NR RRC_CONNECTED procedure in TS 38.508-1 Table 4.5.4.2-3 are performed. | - | - | - | - |
| 12 | The UE loops back the IP PDU. | - | - | - | - |
| 13 | The SS transmits an <i>RRCRelease</i> message to release RRC connection and move the UE to RRC_IDLE. | <-- | NR RRC: <i>RRCRelease</i> | - | - |
| 14 | The SS changes the SIB1 of NR Cell 1 to set the <i>uac-BarringInfo</i> and adjusts the NR Cells power levels according to row "T2" in table 11.3.6.3.2-1/2. | - | - | - | - |
| 15-19 | Steps 1 to 5 of the mobility registration updating procedure described in TS 38.508-1 [4] Table 4.9.5.2.2-1 are performed on NR Cell 1. (Note 2) | - | - | - | - |
| 19A-19D | Steps 5 to 8 of the NR RRC_CONNECTED procedure in TS 38.508-1 Table 4.5.4.2-3 are performed. | - | - | - | - |
| 20 | The SS transmits one IP PDU. | - | - | - | - |
| 21 | The SS transmits an <i>RRCRelease</i> message with suspend configuration and move the UE to RRC_INACTIVE. | <-- | NR RRC: <i>RRCRelease</i> | - | - |
| 22 | Check: Does the UE transmit a <i>RRCResumeRequest</i> message including <i>resumeCause</i> of <i>mcs-PriorityAccess</i> within 10 s? (Note 4) | --> | NR RRC: <i>RRCResumeRequest</i> | 3 | F |
| 23 | SS changes SIB1 according to Table 11.3.6.3.3-5. And the SS notifies the UE of change of System Information on NR Cell 1 by send Short Message on PDCCH using P-RNTI. | <-- | NR RRC: <i>Paging</i> | - | - |
| 24 | Check: Does the UE transmit a <i>RRCResumeRequest</i> message including <i>resumeCause</i> of <i>mcs-PriorityAccess</i> within 30 s? (Note 3) | --> | NR RRC: <i>RRCResumeRequest</i> | 4 | P |
| 25 | SS transmit an <i>RRCResume</i> message. | <-- | NR RRC: <i>RRCResume</i> | - | - |
| 26 | The UE transmits an <i>RRCResumeComplete</i> message to confirm the successful completion of the connection establishment. | --> | NR RRC:
<i>RRCResumeComplete</i> | - | - |
| 27 | The UE loops back the IP PDU. | - | - | - | - |
| 28 | The SS transmits an <i>RRCRelease</i> message to release RRC connection and move the UE to RRC_IDLE. | <-- | NR RRC: <i>RRCRelease</i> | - | - |
| <p>Note 1: The SS includes a 5GS network feature support IE in the REGISTRATION ACCEPT message configured as Table 11.3.6.3.3-3.</p> <p>Note 2: The UE performs registration and the RRC connection is released.</p> <p>Note 3: The wait time 30s is selected to cover $(0.7 + 0.6 * rand) * uac-BarringTime(16s) = 20.8s + 1s$ (IP PDU delay timer) + 5.12s (modification period) = 26.92s rounded up to 27s when 'rand' takes the maximum value of 1.</p> <p>Note 4: The wait time 10s is selected to be less than T390 minimum = $(0.7 + 0.6 * rand) * uac-BarringTime(16s) =$</p> | | | | | |

| |
|---|
| 11.2s when 'rand' takes the minimum value of 0. |
|---|

11.3.6.3.3 Specific message contents

Table 11.3.6.3.3-1: SIB1 of NR Cell 12 (preamble and all steps, Table 11.3.6.3.2-3)

| Derivation Path: TS 38.508-1 [4], Table 4.6.1-28 | | | |
|--|--------------|---|-----------|
| Information Element | Value/remark | Comment | Condition |
| SIB1 ::= SEQUENCE { | | | |
| uac-BarringInfo SEQUENCE { | | | |
| uac-BarringForCommon SEQUENCE (SIZE (1..maxAccessCat-1)) OF UAC-BarringPerCat { | 1 entry | | |
| UAC-BarringPerCat[1] SEQUENCE { | | entry 1 | |
| accessCategory | 3 | (= MO_sig) | |
| uac-barringInfoSetIndex | 1 | Value 1 corresponds to the first entry in uac-BarringInfoSetList | |
| } | | | |
| } | | | |
| uac-BarringPerPLMN-List | Not present | | |
| uac-BarringInfoSetList SEQUENCE (SIZE(1..maxBarringInfoSet)) OF UAC-BarringInfoSet { | 1 entry | | |
| UAC-BarringInfoSet[1] SEQUENCE { | | entry 1 | |
| uac-BarringFactor | p00 | 0% access probability | |
| uac-BarringTime | s16 | 16 s | |
| uac-BarringForAccessIdentity | '1111111'B | Value 1 means that access attempt is not allowed for the corresponding access identity. The leftmost bit, bit 0 in the bit string corresponds to Access Identity 1. | |
| } | | | |
| } | | | |
| uac-AccessCategory1-SelectionAssistanceInfo | Not present | | |
| } | | | |
| } | | | |

Table 11.3.6.3.3-2: RRCSetupRequest (step 2 and step 9, Table 11.3.6.3.2-3)

| Derivation Path: TS 38.508-1 [4], Table 4.6.1-23: | | | |
|---|---|---------|-----------|
| Information Element | Value/remark | Comment | Condition |
| RRCSetupRequest ::= SEQUENCE { | | | |
| rrcSetupRequest SEQUENCE { | | | |
| establishmentCause | Any allowed value other than mcs-PriorityAccess | | Step 2 |
| | mcs-PriorityAccess | | Step 9 |
| } | | | |
| } | | | |

Table 11.3.6.3.3-3: REGISTRATION ACCEPT(step 5, Table 11.3.6.3.2-3)

| Derivation path: TS 38.508 [4] Table 4.7.1-7 | | | |
|--|------------------------|--|-----------|
| Information Element | Value/remark | Comment | Condition |
| 5GS network feature support | '0000 0001 0000 0010'B | Access identity 2 valid in RPLMN or equivalent PLMN. IMS voice over PS session supported over 3GPP access. All other features set to "not supported" including the 'Interworking without N26 interface not supported'. | |

Table 11.3.6.3.3-3a: RRCReconfiguration (step 6C and step 19C in Table 11.3.6.3.2-3)

| Derivation path: TS 38.508-1 [4], Table 4.6.1-13 condition NR and SRB2 and DRB1 | | | |
|---|--------------|---------|-----------|
| Information Element | Value/remark | Comment | Condition |
| RRCReconfiguration ::= SEQUENCE { | | | |
| dedicatedNAS-MessageList | Not present | | |
| } | | | |

Table 11.3.6.3.3-4: SIB1 of NR Cell 1 (step 14, Table 11.3.6.3.2-3)

| Derivation Path: TS 38.508-1 [4], Table 4.6.1-28 | | | |
|---|--------------|--|-----------|
| Information Element | Value/remark | Comment | Condition |
| SIB1 ::= SEQUENCE { | | | |
| uac-BarringInfo SEQUENCE { | | | |
| uac-BarringForCommon SEQUENCE (SIZE (1..maxAccessCat-1)) OF UAC-BarringPerCat { | 1 entry | | |
| UAC-BarringPerCat[1] SEQUENCE { | | entry 1 | |
| accessCategory | 7 | (= MO_data) | |
| uac-barringInfoSetIndex | 1 | Value 1 corresponds to the first entry in uac-BarringInfoSetList | |
| } | | | |
| } | | | |
| uac-BarringPerPLMN-List | Not present | | |
| uac-BarringInfoSetList SEQUENCE (SIZE(1..maxBarringInfoSet)) OF SEQUENCE { | 1 entry | | |
| UAC-BarringInfoSet[1] SEQUENCE { | | entry 1 | |
| uac-BarringFactor | P00 | 0% access probability | |
| uac-BarringTime | s16 | 16 s | |
| uac-BarringForAccessIdentity | 1111111 | Value 1 means that access attempt is not allowed for the corresponding access identity.
The leftmost bit, bit 0 in the bit string corresponds to Access Identity 1. | |
| } | | | |
| } | | | |
| uac-AccessCategory1-SelectionAssistanceInfo | Not present | | |
| } | | | |
| } | | | |

Table 11.3.6.3.3-5: RRCResumeRequest (step 22 and step 24, Table 11.3.6.3.2-3)

| Derivation Path: TS 38.508-1 [4], Table 4.6.1-19: | | | |
|---|--------------------|---------|-----------|
| Information Element | Value/remark | Comment | Condition |
| RRCResumeRequest ::= SEQUENCE { | | | |
| rrcResumeRequest SEQUENCE { | | | |
| resumeCause | mcs-PriorityAccess | | |
| } | | | |
| } | | | |

Table 11.3.6.3.3-6: SIB1 of NR Cell 1 (step 23, Table 11.3.6.3.2-3)

| Derivation Path: TS 38.508-1 [4], Table 4.6.1-28 | | | |
|--|--------------|---------|-----------|
| Information Element | Value/remark | Comment | Condition |
| SIB1 ::= SEQUENCE { | | | |
| uac-BarringInfo | Not present | | |
| } | | | |

11.3.7 UAC / Access Identity 11..15 / High Priority Access / HPLMN/0% accessibility AC2/Emergency call

11.3.7.1 Test Purpose (TP)

(1)

```
with { UE configured for Access Identity 11..15 having received SIB1 containing UAC Info indicating
0% accessibility for Access Category 2 camped in NR RRC_IDLE state on HPLMN }
ensure that {
  when { User initiates MO emergency call }
  then { UE does not initiate emergency call on NR Cell }
}
```

11.3.7.2 Conformance requirements

References: The conformance requirements covered in the present TC are specified in: TS 24.501 clause 4.5.2, 4.5.4.1 and 4.5.6, TS 38.331 clause 5.3.14.2, 5.3.14.4 and 5.3.14.5, TS 22.101 clause 10.1.1. Unless otherwise stated these are Rel-15 requirements.

[TS 24.501, clause 4.5.2]

When the UE needs to initiate an access attempt in one of the events listed in subclause 4.5.1, the UE shall determine one or more access identities from the set of standardized access identities, and one access category from the set of standardized access categories and operator-defined access categories, to be associated with that access attempt.

The set of the access identities applicable for the request is determined by the UE in the following way:

- a) for each of the access identities 1, 2, 11, 12, 13, 14 and 15 in table 4.5.2.1, the UE shall check whether the access identity is applicable in the selected PLMN, if a new PLMN is selected, or otherwise if it is applicable in the RPLMN or equivalent PLMN; and
- b) if none of the above access identities is applicable, then access identity 0 is applicable.

Table 4.5.2.1: Access identities

| Access Identity number | UE configuration |
|--|--|
| 0 | UE is not configured with any parameters from this table |
| 1 (NOTE 1) | UE is configured for multimedia priority service (MPS). |
| 2 (NOTE 2) | UE is configured for mission critical service (MCS). |
| 3-10 | Reserved for future use |
| 11 (NOTE 3) | Access Class 11 is configured in the UE. |
| 12 (NOTE 3) | Access Class 12 is configured in the UE. |
| 13 (NOTE 3) | Access Class 13 is configured in the UE. |
| 14 (NOTE 3) | Access Class 14 is configured in the UE. |
| 15 (NOTE 3) | Access Class 15 is configured in the UE. |
| NOTE 1: Access identity 1 is valid when: <ul style="list-style-type: none"> - the USIM file EF_{UAC_AIC} indicates the UE is configured for access identity 1 and the selected PLMN, if a new PLMN is selected, or RPLMN is the HPLMN (if the EHPLMN list is not present or is empty) or EHPLMN (if the EHPLMN list is present), or a visited PLMN of the home country (see the definition of home country in 3GPP TS 24.301 [15]); or - the UE receives the 5GS network feature support IE with the MPS indicator bit set to "Access identity 1 valid" from the RPLMN as described in subclause 5.5.1.2.4 and subclause 5.5.1.3.4. | |
| NOTE 2: Access identity 2 is used by UEs configured for MCS and is valid when: <ul style="list-style-type: none"> - the USIM file EF_{UAC_AIC} indicates the UE is configured for access identity 2 and the selected PLMN, if a new PLMN is selected, or RPLMN is the HPLMN (if the EHPLMN list is not present or is empty) or EHPLMN (if the EHPLMN list is present), or a visited PLMN of the home country (see 3GPP TS 23.122 [5]); or - the UE receives the 5GS network feature support IE with the MCS indicator bit set to "Access identity 2 valid" from the RPLMN as described in subclause 5.5.1.2.4 and subclause 5.5.1.3.4. | |
| NOTE 3: Access identities 11 and 15 are valid in HPLMN (if the EHPLMN list is not present or is empty) or EHPLMN (if the EHPLMN list is present). Access Identities 12, 13 and 14 are valid in HPLMN and visited PLMNs of home country only (see the definition of home country in 3GPP TS 24.301 [15]). | |

...

In order to determine the access category applicable for the access attempt, the NAS shall check the rules in table 4.5.2.2, and use the access category for which there is a match for barring check. If the access attempt matches more than one rule, the access category of the lowest rule number shall be selected. If the access attempt matches more than one operator-defined access category definition, the UE shall select the access category from the operator-defined access category definition with the lowest precedence value (see subclause 4.5.3).

NOTE: The case when an access attempt matches more than one rule includes the case when multiple events trigger an access attempt at the same time.

Table 4.5.2.2: Mapping table for access categories

| Rule # | Type of access attempt | Requirements to be met | Access Category |
|--------|--|--|---|
| 1 | Response to paging or NOTIFICATION over non-3GPP access;
5GMM connection management procedure initiated for the purpose of transporting an LPP message without an ongoing 5GC-MO-LR procedure;
Access attempt to handover of ongoing MMTEL voice call, MMTEL video call or SMSoIP from non-3GPP access | Access attempt is for MT access, or handover of ongoing MMTEL voice call, MMTEL video call or SMSoIP from non-3GPP access | 0 (= MT_acc) |
| 2 | Emergency | UE is attempting access for an emergency session (NOTE 1, NOTE 2) | 2 (= emergency) |
| 3 | Access attempt for operator-defined access category | UE stores operator-defined access category definitions valid in the current PLMN as specified in subclause 4.5.3, and access attempt is matching criteria of an operator-defined access category definition | 32-63
(= based on operator classification) |
| 4 | Access attempt for delay tolerant service | (a) UE is configured for NAS signalling low priority or UE supporting S1 mode is configured for EAB (see the "ExtendedAccessBarring" leaf of NAS configuration MO in 3GPP TS 24.368 [17] or 3GPP TS 31.102 [22]) where "EAB override" does not apply, and
(b):the UE received one of the categories a, b or c as part of the parameters for unified access control in the broadcast system information, and the UE is a member of the broadcasted category in the selected PLMN or RPLMN/equivalent PLMN (NOTE 3, NOTE 5, NOTE 6, NOTE 7, NOTE 8) | 1 (= delay tolerant) |
| 4.1 | MO IMS registration related signalling | Access attempt is for MO IMS registration related signalling (e.g. IMS initial registration, re-registration, subscription refresh)
or for NAS signalling connection recovery during ongoing procedure for MO IMS registration related signalling (NOTE 2a) | 9 (= MO IMS registration related signalling) |
| 5 | MO MMTel voice call | Access attempt is for MO MMTel voice call or for NAS signalling connection recovery during ongoing MO MMTel voice call (NOTE 2) | 4 (= MO MMTel voice) |
| 6 | MO MMTel video call | Access attempt is for MO MMTel video call or for NAS signalling connection recovery during ongoing MO MMTel video call (NOTE 2) | 5 (= MO MMTel video) |
| 7 | MO SMS over NAS or MO SMSoIP | Access attempt is for MO SMS over NAS (NOTE 4) or MO SMS over SMSoIP transfer or for NAS signalling connection recovery during ongoing MO SMS or SMSoIP transfer (NOTE 2) | 6 (= MO SMS and SMSoIP) |
| 8 | UE NAS initiated 5GMM specific procedures | Access attempt is for MO signalling | 3 (= MO_sig) |
| 8.1 | Mobile originated location request | Access attempt is for mobile originated location request (NOTE 9) | 3 (= MO_sig) |
| 8.2 | Mobile originated signalling transaction | Access attempt is for mobile originated signalling transaction towards the PCF | 3 (= MO_sig) |

| | towards the PCF | (NOTE 10) | |
|--|--|-------------------------------------|---------------|
| 9 | UE NAS initiated 5GMM connection management procedure or 5GMM NAS transport procedure | Access attempt is for MO data | 7 (= MO_data) |
| 10 | An uplink user data packet is to be sent for a PDU session with suspended user-plane resources | No further requirement is to be met | 7 (= MO_data) |
| <p>NOTE 1: This includes 5GMM specific procedures while the service is ongoing and 5GMM connection management procedures required to establish a PDU session with request type = "initial emergency request" or "existing emergency PDU session", or to re-establish user-plane resources for such a PDU session. This further includes the service request procedure initiated with a SERVICE REQUEST message with the Service type IE set to "emergency services fallback".</p> <p>NOTE 2: Access for the purpose of NAS signalling connection recovery during an ongoing service as defined in subclause 4.5.5, or for the purpose of NAS signalling connection establishment following fallback indication from lower layers during an ongoing service as defined in subclause 4.5.5, is mapped to the access category of the ongoing service in order to derive an RRC establishment cause, but barring checks will be skipped for this access attempt.</p> <p>NOTE 2a: Access for the purpose of NAS signalling connection recovery during an ongoing procedure for MO IMS registration related signalling as defined in subclause 4.5.5, or for the purpose of NAS signalling connection establishment following fallback indication from lower layers during an ongoing procedure for MO IMS registration related signalling as defined in subclause 4.5.5, is mapped to the access category of the MO IMS registration related signalling in order to derive an RRC establishment cause, but barring checks will be skipped for this access attempt.</p> <p>NOTE 3: If the UE selects a new PLMN, then the selected PLMN is used to check the membership; otherwise the UE uses the RPLMN or a PLMN equivalent to the RPLMN.</p> <p>NOTE 4: This includes the 5GMM connection management procedures triggered by the UE-initiated NAS transport procedure for transporting the MO SMS.</p> <p>NOTE 5: The UE configured for NAS signalling low priority is not supported in this release of specification. If a UE supporting both S1 mode and N1 mode is configured for NAS signalling low priority in S1 mode as specified in 3GPP TS 24.368 [17] or 3GPP TS 31.102 [22], the UE shall ignore the configuration for NAS signalling low priority when in N1 mode.</p> <p>NOTE 6: If the access category applicable for the access attempt is 1, then the UE shall additionally determine a second access category from the range 3 to 7. If more than one access category matches, the access category of the lowest rule number shall be chosen. The UE shall use the second access category only to derive an RRC establishment cause for the access attempt.</p> <p>NOTE 7: "EAB override" does not apply, if the UE is not configured to allow overriding EAB (see the "Override_ExtendedAccessBarring" leaf of NAS configuration MO in 3GPP TS 24.368 [17] or 3GPP TS 31.102 [22]), or if NAS has not received an indication from the upper layers to override EAB and the UE does not have a PDU session that was established with EAB override.</p> <p>NOTE 8: For the definition of categories a, b and c associated with access category 1, see 3GPP TS 22.261 [3]. The categories associated with access category 1 are distinct from the categories a, b and c associated with EAB (see 3GPP TS 22.011 [1A]).</p> <p>NOTE 9: This includes:
 a) the UE-initiated NAS transport procedure for transporting a mobile originated location request;
 b) the 5GMM connection management procedure triggered by a) above; and
 c) NAS signalling connection recovery during an ongoing 5GC-MO-LR procedure.</p> <p>NOTE 10: This includes:
 a) the UE-initiated NAS transport procedure for transporting a mobile originated signalling transaction towards the PCF;
 b) the 5GMM connection management procedure triggered by a) above; and
 c) NAS signalling connection recovery during an ongoing UE triggered V2X policy provisioning procedure.</p> | | | |

[TS 24.501, clause 4.5.4.1]

When the UE is in 5GMM-IDLE mode or 5GMM-IDLE mode with suspend indication, upon receiving a request from the upper layers for an access attempt, the NAS shall categorize the access attempt into access identities and an access category following:

- a) subclause 4.5.2, table 4.5.2.1 and table 4.5.2.2, and subclause 4.5.3, if the UE is not operating in SNPN access mode; or

- b) subclause 4.5.2A, table 4.5.2A.1 and table 4.5.2A.2, and subclause 4.5.3, if the UE is operating in SNPN access mode,

and provide the applicable access identities and the access category to the lower layers for the purpose of access control checking. In this request to the lower layer the NAS can also provide to the lower layer the RRC establishment cause determined as specified in subclause 4.5.6 of this specification.

NOTE 1: The access barring check is performed by the lower layers.

NOTE 2: As an implementation option, the NAS can provide the RRC establishment cause to the lower layers after being informed by the lower layers that the access attempt is allowed.

...

If the lower layers indicate that the access attempt is barred, the NAS shall not initiate the procedure to send the initial NAS message for the access attempt. Additionally:

...

[TS 38.331, clause 5.3.14.2]

Upon initiation of the procedure, the UE shall:

...

1> else:

2> if the Access Category is '0':

3> consider the access attempt as allowed;

2> else:

3> if *SIB1* includes *uac-BarringPerPLMN-List* and the *uac-BarringPerPLMN-List* contains an *UAC-BarringPerPLMN* entry with the *plmn-IdentityIndex* corresponding to the PLMN or SNPN selected by upper layers (see TS 24.501 [23]):

4> select the *UAC-BarringPerPLMN* entry with the *plmn-IdentityIndex* corresponding to the PLMN or to the SNPN selected by upper layers;

4> in the remainder of this procedure, use the selected *UAC-BarringPerPLMN* entry (i.e. presence or absence of access barring parameters in this entry) irrespective of the *uac-BarringForCommon* included in *SIB1*;

3> else if *SIB1* includes *uac-BarringForCommon*:

4> in the remainder of this procedure use the *uac-BarringForCommon* (i.e. presence or absence of these parameters) included in *SIB1*;

3> else:

4> consider the access attempt as allowed;

3> if *uac-BarringForCommon* is applicable or the *uac-ACBarringListType* indicates that *uac-ExplicitACBarringList* is used:

4> if the corresponding *UAC-BarringPerCatList* contains a *UAC-BarringPerCat* entry corresponding to the Access Category:

5> select the *UAC-BarringPerCat* entry;

5> if the *uac-BarringInfoSetList* contains a *UAC-BarringInfoSet* entry corresponding to the selected *uac-barringInfoSetIndex* in the *UAC-BarringPerCat*:

6> select the *UAC-BarringInfoSet* entry;

- 6> perform access barring check for the Access Category as specified in 5.3.14.5, using the selected *UAC-BarringInfoSet* as "UAC barring parameter";
- 5> else:
 - 6> consider the access attempt as allowed;
- 4> else:
 - 5> consider the access attempt as allowed;
- 3> else if the *uac-ACBarringListType* indicates that *uac-ImplicitACBarringList* is used:
 - 4> select the *uac-BarringInfoSetIndex* corresponding to the Access Category in the *uac-ImplicitACBarringList*;
 - 4> if the *uac-BarringInfoSetList* contains the *UAC-BarringInfoSet* entry corresponding to the selected *uac-BarringInfoSetIndex*:
 - 5> select the *UAC-BarringInfoSet* entry;
 - 5> perform access barring check for the Access Category as specified in 5.3.14.5, using the selected *UAC-BarringInfoSet* as "UAC barring parameter";
 - 4> else:
 - 5> consider the access attempt as allowed;
- 3> else:
 - 4> consider the access attempt as allowed;
- 1> if the access barring check was requested by upper layers:
 - 2> if the access attempt is considered as barred:
 - ...
 - 3> else:
 - 4> inform upper layers that the access attempt for the Access Category is barred, upon which the procedure ends;
- 2> else:
 - 3> inform upper layers that the access attempt for the Access Category is allowed, upon which the procedure ends;
- 1> else:
 - 2> the procedure ends.

[TS 38.331, clause 5.3.14.5]

The UE shall:

- 1> if one or more Access Identities are indicated according to TS 24.501 [23], and
- 1> if for at least one of these Access Identities the corresponding bit in the *uac-BarringForAccessIdentity* contained in "UAC barring parameter" is set to *zero*:
 - 2> consider the access attempt as allowed;
- 1> else:
 - 2> draw a random number '*rand*' uniformly distributed in the range: $0 \leq rand < 1$;
 - 2> if '*rand*' is lower than the value indicated by *uac-BarringFactor* included in "UAC barring parameter":

- 3> consider the access attempt as allowed;
- 2> else:
- 3> consider the access attempt as barred;
- 1> if the access attempt is considered as barred:
- 2> draw a random number '*rand*' that is uniformly distributed in the range $0 \leq rand < 1$;
- 2> start timer T390 for the Access Category with the timer value calculated as follows, using the *uac-BarringTime* included in "AC barring parameter":
- $$T390 = (0.7 + 0.6 * rand) * uac-BarringTime.$$

[TS 22.101, subclause 10.1.1]

The ME shall identify an emergency number dialled by the end user as a valid emergency number and initiate emergency call establishment if it occurs under one or more of the following conditions. If it occurs outside of the following conditions, the ME should not initiate emergency call establishment but normal call establishment. Emergency number identification takes place before and takes precedence over any other (e.g. supplementary service related) number analysis.

- a) 112 and 911 shall always be available. These numbers shall be stored on the ME.

11.3.7.3 Test description

11.3.7.3.1 Pre-test conditions

System Simulator:

- NR Cell 1
- NR Cell 1 as defined in TS 38.508-1 [4] Table 4.4.2-3 is configured as per table 11.3.7.3.1-1 (PLMN1 is the HPLMN). System information combination NR-1 as defined in TS 38.508-1 [4], subclause 4.4.3.1.2.

Table 11.3.7.3.1-1: PLMN identifiers

| NR Cell | PLMN names | MCC | MNC |
|-----------|------------|-----|-----|
| NR Cell 1 | PLMN1 | 001 | 01 |

UE:

- The UE is equipped with a USIM configuration as defined in TS 38.508-1 [4] Table 6.4.1-17.

Preamble:

- The UE is brought to state 1N-A, RRC_IDLE Connectivity (NR), in accordance with the procedure described in TS 38.508-1 [4], Table 4.5.2.2-2.

11.3.7.3.2 Test procedure sequence

Table 11.3.7.3.2-1: Main behaviour

| St | Procedure | Message Sequence | | TP | Verdict |
|----|---|------------------|--------------------------------|----|---------|
| | | U - S | Message | | |
| 1 | Make the UE attempt an emergency call dialling a number which is stored on the ME (e.g. 112 or 911). (NOTE 1) | - | - | - | - |
| 2 | Check: Does the UE transmit an <i>RRCSetupRequest</i> message with <i>establishmentCause</i> set to 'emergency' within 30 s'? | --> | NR RRC: <i>RRCSetupRequest</i> | 1 | F |

NOTE 1: This could be done by e.g. MMI or AT command.

11.3.7.3.3 Specific message contents

Table 11.3.7.3.3-1: SIB1 for NR Cell 1 (preamble, Table 11.3.7.3.2-1)

| Derivation Path: TS 38.508-1 [4], Table 4.6.1-28 | | | |
|--|--------------|---------|-----------|
| Information Element | Value/remark | Comment | Condition |
| SIB1 ::= SEQUENCE { | | | |
| uac-BarringForCommon SEQUENCE { | | | |
| UAC-BarringPerCatList ::= SEQUENCE (SIZE (1..maxAccessCat-1)) OF UAC-BarringPerCat { | 1 entry | | |
| UAC-BarringPerCat[1] SEQUENCE { | | entry 1 | |
| accessCategory | 2 | | |
| uac-barringInfoSetIndex | 1 | | |
| } | | | |
| } | | | |
| uac-BarringPerPLMN-List | Not present | | |
| uac-BarringInfoSetList ::= SEQUENCE (SIZE(1..maxBarringInfoSet)) OF UAC-BarringInfoSet { | 1 entry | | |
| UAC-BarringInfoSet[1] SEQUENCE { | | entry 1 | |
| uac-BarringFactor | p00 | | |
| uac-BarringTime | s64 | | |
| uac-BarringForAccessIdentity | '00111111'B | | |
| } | | | |
| uac-AccessCategory1-SelectionAssistanceInfo | Not Present | | |
| } | | | |
| } | | | |

11.3.8 UAC / Access Identity 0 / NR RRC_IDLE / Cell re-selection while T390 is running

11.3.8.1 Test Purpose (TP)

(1)

```
with { UE not configured for special AIs (1,2,11-15) ,having access barred for MO MMTEL Voice and T390 running in NR RRC_IDLE state}
ensure that {
  when { UE performs Cell Reselection to a new NR Cell }
  then { UE stops T390 for MO MMTEL Voice and informs upper layers about barring alleviation for this Access Category }
}
```

11.3.8.2 Conformance requirements

References: The conformance requirements covered in the present TC are specified in TS 24.501: clause 4.5.2, 4.5.4.1 and 4.5.6 and TS 38.331: clause 5.3.14.1, 5.3.14.2, 5.3.14.4 and 5.3.14.5. Unless otherwise stated these are Rel-15 requirements.

[TS 24.501, clause 4.5.2]

When the UE needs to initiate an access attempt in one of the events listed in subclause 4.5.1, the UE shall determine one or more access identities from the set of standardized access identities, and one access category from the set of standardized access categories and operator-defined access categories, to be associated with that access attempt.

The set of the access identities applicable for the request is determined by the UE in the following way:

- for each of the access identities 1, 2, 11, 12, 13, 14 and 15 in table 4.5.2.1, the UE shall check whether the access identity is applicable in the selected PLMN, if a new PLMN is selected, or otherwise if it is applicable in the RPLMN or equivalent PLMN; and
- if none of the above access identities is applicable, then access identity 0 is applicable.

Table 4.5.2.1: Access identities

| Access Identity number | UE configuration |
|--|--|
| 0 | UE is not configured with any parameters from this table |
| 1 (NOTE 1) | UE is configured for multimedia priority service (MPS). |
| 2 (NOTE 2) | UE is configured for mission critical service (MCS). |
| 3-10 | Reserved for future use |
| 11 (NOTE 3) | Access Class 11 is configured in the UE. |
| 12 (NOTE 3) | Access Class 12 is configured in the UE. |
| 13 (NOTE 3) | Access Class 13 is configured in the UE. |
| 14 (NOTE 3) | Access Class 14 is configured in the UE. |
| 15 (NOTE 3) | Access Class 15 is configured in the UE. |
| <p>NOTE 1: Access identity 1 is valid when:</p> <ul style="list-style-type: none"> - the USIM file EF_{UAC_AIC} indicates the UE is configured for access identity 1 and the RPLMN is the HPLMN (if the EHPLMN list is not present or is empty) or EHPLMN (if the EHPLMN list is present), or a visited PLMN of the home country (see the definition of home country in 3GPP TS 24.301 [15]); or - the UE receives the 5GS network feature support IE with the MPS indicator bit set to "Access identity 1 valid in RPLMN or equivalent PLMN" from the RPLMN as described in subclause 5.5.1.2.4 and subclause 5.5.1.3.4. <p>NOTE 2: Access identity 2 is used by UEs configured for MCS and is valid when:</p> <ul style="list-style-type: none"> - the USIM file EF_{UAC_AIC} indicates the UE is configured for access identity 2 and the RPLMN is the HPLMN (if the EHPLMN list is not present or is empty) or EHPLMN (if the EHPLMN list is present), or a visited PLMN of the home country (see 3GPP TS 23.122 [5]); or - the UE receives the 5GS network feature support IE with the MCS indicator bit set to "Access identity 2 valid in RPLMN or equivalent PLMN" from the RPLMN as described in subclause 5.5.1.2.4 and subclause 5.5.1.3.4. <p>NOTE 3: Access identities 11 and 15 are valid in HPLMN (if the EHPLMN list is not present or is empty) or EHPLMN (if the EHPLMN list is present). Access Identities 12, 13 and 14 are valid in HPLMN and visited PLMNs of home country only (see the definition of home country in 3GPP TS 24.301 [15]).</p> | |

The UE uses the MPS indicator bit of the 5GS network feature support IE to determine if access identity 1 is valid. Processing of the MPS indicator bit of the 5GS network feature support IE in the REGISTRATION ACCEPT message is described in subclause 5.5.1.2.4 and subclause 5.5.1.3.4. The UE shall not consider access identity 1 to be valid when the UE is not in the country of its HPLMN prior to receiving the MPS indicator bit of the 5GS network feature support IE in the REGISTRATION ACCEPT message being set to "Access identity 1 valid in RPLMN or equivalent PLMN".

When the UE is in the country of its HPLMN, the contents of the USIM files EF_{UAC_AIC} and EF_{ACC} as specified in 3GPP TS 31.102 [22] and the rules specified in table 4.5.2.1 are used to determine the applicability of access identity 1 and access classes 11 - 15. When the UE is in the country of its HPLMN, and the USIM file EF_{UAC_AIC} does not indicate the UE is configured for access identity 1, the UE uses the MPS indicator bit of the 5GS network feature support IE in the REGISTRATION ACCEPT message to determine if access identity 1 is valid. When the UE is in the country of its HPLMN, and the USIM file EF_{UAC_AIC} indicates the UE is configured for access identity 1, the MPS indicator bit of the 5GS network feature support IE is not applicable. When the UE is not in the country of its HPLMN, the contents of the USIM files EF_{UAC_AIC} and EF_{ACC} are not applicable.

The UE uses the MCS indicator bit of the 5GS network feature support IE to determine if access identity 2 is valid. Processing of the MCS indicator bit of the 5GS network feature support IE in the REGISTRATION ACCEPT message is described in subclause 5.5.1.2.4 and subclause 5.5.1.3.4. The UE shall not consider access identity 2 to be valid when the UE is not in the country of its HPLMN prior to receiving the MCS indicator bit of the 5GS network feature support IE in the REGISTRATION ACCEPT message being set to "Access identity 2 valid in RPLMN or equivalent PLMN".

When the UE is in the country of its HPLMN, the contents of the USIM files EF_{UAC_AIC} and EF_{ACC} as specified in 3GPP TS 31.102 [22] and the rules specified in table 4.5.2.1 are used to determine the applicability of access identity 2 and access classes 11 - 15. When the UE is in the country of its HPLMN, and the USIM file EF_{UAC_AIC} does not indicate the UE is configured for access identity 2, the UE uses the MCS indicator bit of the 5GS network feature support IE in the REGISTRATION ACCEPT message to determine if access identity 2 is valid. When the UE is in the country of its HPLMN, and the USIM file EF_{UAC_AIC} indicates the UE is configured for access identity 2, the MCS indicator bit of the 5GS network feature support IE is not applicable. When the UE is not in the country of its HPLMN, the contents of the USIM files EF_{UAC_AIC} and EF_{ACC} are not applicable.

In order to determine the access category applicable for the access attempt, the NAS shall check the rules in table 4.5.2.2, and use the access category for which there is a match for barring check. If the access attempt matches

more than one rule, the access category of the lowest rule number shall be selected. If the access attempt matches more than one operator-defined access category definition, the UE shall select the access category from the operator-defined access category definition with the lowest precedence value (see subclause 4.5.3).

NOTE: The case when an access attempt matches more than one rule includes the case when multiple events trigger an access attempt at the same time.

Table 4.5.2.2: Mapping table for access categories

| Rule # | Type of access attempt | Requirements to be met | Access Category |
|--|--|--|---|
| 1 | Response to paging or NOTIFICATION over non-3GPP access; 5GMM connection management procedure initiated for the purpose of transporting an LPP message | Access attempt is for MT access | 0 (= MT_acc) |
| 2 | Emergency | UE is attempting access for an emergency session (NOTE 1, NOTE 2) | 2 (= emergency) |
| 3 | Access attempt for operator-defined access category | UE stores operator-defined access category definitions valid in the current PLMN as specified in subclause 4.5.3, and access attempt is matching criteria of an operator-defined access category definition | 32-63
(= based on operator classification) |
| 4 | Access attempt for delay tolerant service | (a) UE is configured for NAS signalling low priority or UE supporting S1 mode is configured for EAB (see the "ExtendedAccessBarring" leaf of NAS configuration MO in 3GPP TS 24.368 [17] or 3GPP TS 31.102 [22]) where "EAB override" does not apply, and
(b) the UE received one of the categories a, b or c as part of the parameters for unified access control in the broadcast system information, and the UE is a member of the broadcasted category in the selected PLMN or RPLMN/equivalent PLMN (NOTE 3, NOTE 5, NOTE 6, NOTE 7, NOTE 8) | 1 (= delay tolerant) |
| 5 | MO MMTel voice call | Access attempt is for MO MMTel voice call or for NAS signalling connection recovery during ongoing MO MMTel voice call (NOTE 2) | 4 (= MO MMTel voice) |
| 6 | MO MMTel video call | Access attempt is for MO MMTel video call or for NAS signalling connection recovery during ongoing MO MMTel video call (NOTE 2) | 5 (= MO MMTel video) |
| 7 | MO SMS over NAS or MO SMSoIP | Access attempt is for MO SMS over NAS (NOTE 4) or MO SMS over SMSoIP transfer or for NAS signalling connection recovery during ongoing MO SMS or SMSoIP transfer (NOTE 2) | 6 (= MO SMS and SMSoIP) |
| 8 | UE NAS initiated 5GMM specific procedures | Access attempt is for MO signalling | 3 (= MO_sig) |
| 9 | UE NAS initiated 5GMM connection management procedure or 5GMM NAS transport procedure | Access attempt is for MO data | 7 (= MO_data) |
| 10 | An uplink user data packet is to be sent for a PDU session with suspended user-plane resources | No further requirement is to be met | 7 (= MO_data) |
| NOTE 1: This includes 5GMM specific procedures while the service is ongoing and 5GMM connection management procedures required to establish a PDU session with request type = "initial emergency request" or "existing emergency PDU session", or to re-establish user-plane | | | |

| | |
|---------|---|
| | resources for such a PDU session. This further includes the service request procedure initiated with a SERVICE REQUEST message with the Service type IE set to "emergency services fallback".< |
| NOTE 2: | Access for the purpose of NAS signalling connection recovery during an ongoing service, or for the purpose of NAS signalling connection establishment following fallback indication from lower layers during an ongoing service, is mapped to the access category of the ongoing service in order to derive an RRC establishment cause, but barring checks will be skipped for this access attempt. |
| NOTE 3: | If the UE selects a new PLMN, then the selected PLMN is used to check the membership; otherwise the UE uses the RLPMN or a PLMN equivalent to the RPLMN. |
| NOTE 4: | This includes the 5GMM connection management procedures triggered by the UE-initiated NAS transport procedure for transporting the MO SMS. |
| NOTE 5: | The UE configured for NAS signalling low priority is not supported in this release of specification. If a UE supporting both S1 mode and N1 mode is configured for NAS signalling low priority in S1 mode as specified in 3GPP TS 24.368 [17] or 3GPP TS 31.102 [22], the UE shall ignore the configuration for NAS signalling low priority when in N1 mode. |
| NOTE 6: | If the access category applicable for the access attempt is 1, then the UE shall additionally determine a second access category from the range 3 to 7. If more than one access category matches, the access category of the lowest rule number shall be chosen. The UE shall use the second access category only to derive an RRC establishment cause for the access attempt. |
| NOTE 7: | "EAB override" does not apply, if the UE is not configured to allow overriding EAB (see the "Override_ExtendedAccessBarring" leaf of NAS configuration MO in 3GPP TS 24.368 [17] or 3GPP TS 31.102 [22]), or if NAS has not received an indication from the upper layers to override EAB and the UE does not have a PDU session that was established with EAB override. |
| NOTE 8: | For the definition of categories a, b and c associated with access category 1, see 3GPP TS 22.261 [3]. The categories associated with access category 1 are distinct from the categories a, b and c associated with EAB (see 3GPP TS 22.011 [1A]). |

[TS 24.501, clause 4.5.4.1]

When the UE is in 5GMM-IDLE mode, upon receiving a request from the upper layers for an access attempt, the NAS shall categorize the access attempt into access identities and an access category following subclause 4.5.2, table 4.5.2.1 and table 4.5.2.2, and subclause 4.5.3, and provide the applicable access identities and the access category to the lower layers for the purpose of access control checking. In this request to the lower layer the NAS can also provide to the lower layer the RRC establishment cause determined as specified in subclause 4.5.6 of this specification.

NOTE 1: The access barring check is performed by the lower layers.

NOTE 2: As an implementation option, the NAS can provide the RRC establishment cause to the lower layers after being informed by the lower layers that the access attempt is allowed.

If the UE has uplink user data pending for one or more PDU sessions when it builds a REGISTRATION REQUEST or SERVICE REQUEST message as initial NAS message, the UE shall indicate the respective PDU sessions in the Uplink data status IE as specified in subclause 5.5.1.3.2 and 5.6.1.2, regardless of the access category for which the access barring check is performed.

NOTE 3: The UE indicates pending user data for all the respective PDU sessions, even if barring timers are running for some of the corresponding access categories.

If the lower layers indicate that the access attempt is allowed, the NAS shall initiate the procedure to send the initial NAS message for the access attempt.

If the lower layers indicate that the access attempt is barred, the NAS shall not initiate the procedure to send the initial NAS message for the access attempt. Additionally:

- a) if the event which triggered the access attempt was an MO-MMTEL-voice-call-started indication or an MO-MMTEL-video-call-started indication:
 - 1) if the UE is operating in the single-registration mode and the UE's usage setting is "voice centric", the UE may attempt to select an E-UTRA cell connected to EPC. If the UE finds a suitable E-UTRA cell connected to EPC, it then proceeds with the appropriate EMM specific procedures and, if necessary, ESM procedures to make a PDN connection providing access to IMS available; see subclause 4.8.2 and 3GPP TS 24.301 [15];
 - 2) if the UE is operating in the dual-registration mode, the UE may proceed in S1 mode with the appropriate EMM specific procedures and ESM procedures to make a PDN connection providing access to IMS available; see subclause 4.8.3 and 3GPP TS 24.301 [15];

- 3) otherwise, the NAS shall notify the upper layers that the access attempt is barred. In this case, upon receiving an indication from the lower layers that the barring is alleviated for the access category with which the access attempt was associated, the NAS shall notify the upper layers that the barring is alleviated for the access category and may initiate the procedure to send the initial NAS message, if still needed; and
- b) if the event which triggered the access attempt was an MO-SMSoIP-attempt-started indication:
- 1) if the UE is operating in the single-registration mode, the UE may attempt to select an E-UTRA cell connected to EPC. If the UE finds a suitable E-UTRA cell connected to EPC, it then proceeds with the appropriate EMM specific procedures and, if necessary, ESM procedures to make a PDN connection providing access to IMS available; see subclause 4.8.2 and 3GPP TS 24.301 [15];
 - 2) if the UE is operating in the dual-registration mode, the UE may proceed in S1 mode with the appropriate EMM specific procedures and ESM procedures to make a PDN connection providing access to IMS available; see subclause 4.8.3 and 3GPP TS 24.301 [15];
 - 3) otherwise, the NAS layer shall notify the upper layers that the access attempt is barred. In this case, upon receiving an indication from the lower layers that the barring is alleviated for the access category with which the access attempt was associated, the NAS shall notify the upper layers that the barring is alleviated for the access category and may initiate the procedure to send the initial NAS message, if still needed.

NOTE 4: Barring timers, on a per access category basis, are run by the lower layers. At expiry of barring timers, the indication of alleviation of access barring is indicated to the NAS on a per access category basis.

[TS 24.501, clause 4.5.6]

When 5GMM requests the establishment of a NAS-signalling connection, the RRC establishment cause used by the UE shall be selected according to one or more access identities (see subclause 4.5.2) and the determined access category as specified in table 4.5.6.1 and table 4.5.6.2. If the determined access category is an operator-defined access category, then the RRC establishment cause used by the UE shall be selected according to table 4.5.6.1 and table 4.5.6.2 based on one or more access identities (see subclause 4.5.2) and the standardized access category determined for the operator-defined access category as described in subclause 4.5.3.

Table 4.5.6.1: Mapping table for access identities/access categories and RRC establishment cause when establishing N1 NAS signalling connection via NR connected to 5GCN

| Access identities | Access categories | RRC establishment cause is set to |
|--|-------------------------|-----------------------------------|
| 0 | 0 (= MT_acc) | mt-Access |
| | 1 (= delay tolerant) | Not applicable (NOTE 1) |
| | 2 (= emergency) | emergency |
| | 3 (= MO_sig) | mo-Signalling |
| | 4 (= MO MMTel voice) | mo-VoiceCall |
| | 5 (= MO MMTel video) | mo-VideoCall |
| | 6 (= MO SMS and SMSoIP) | mo-SMS |
| | 7 (= MO_data) | mo-Data |
| 1 | Any category | mps-PriorityAccess |
| 2 | Any category | mcs-PriorityAccess |
| 11, 15 | Any category | highPriorityAccess |
| 12, 13, 14, | Any category | highPriorityAccess |
| NOTE 1: A UE using access category 1 for the access barring check will determine a second access category in the range 3 to 7 that is to be used for determination of the RRC establishment cause. See subclause 4.5.2, table 4.5.2.2, NOTE 6. | | |
| NOTE 2: See subclause 4.5.2, table 4.5.2.1 for use of the access identities of 0, 1, 2, and 11-15. | | |

Table 4.5.6.2: Mapping table for access identities/access categories and RRC establishment cause when establishing N1 NAS signalling connection via E-UTRA connected to 5GCN

| Access identities | Access categories | RRC establishment cause is set to |
|--|-------------------------|-----------------------------------|
| 0 | 0 (= MT_acc) | mt-Access |
| | 1 (= delay tolerant) | Not applicable (NOTE 1) |
| | 2 (= emergency) | emergency |
| | 3 (= MO_sig) | mo-Signalling |
| | 4 (= MO MMTel voice) | mo-VoiceCall |
| | 5 (= MO MMTel video) | mo-VoiceCall |
| | 6 (= MO SMS and SMSoIP) | mo-Data |
| | 7 (= MO_data) | mo-Data |
| 1 | Any category | highPriorityAccess |
| 2 | Any category | highPriorityAccess |
| 11, 15 | Any category | highPriorityAccess |
| 12,13,14, | Any category | highPriorityAccess |
| NOTE 1: A UE using access category 1 for the access barring check will determine a second access category in the range 3 to 7 that is to be used for determination of the RRC establishment cause. See subclause 4.5.2, table 4.5.2.2, NOTE 6. | | |
| NOTE 2: See subclause 4.5.2, table 4.5.2.1 for use of the access identities of 0, 1, 2, and 11-15. | | |

[TS 38.331, clause 5.3.14.1]

The purpose of this procedure is to perform access barring check for an access attempt associated with a given Access Category and one or more Access Identities upon request from upper layers according to TS 24.501 [23] or the RRC layer.

After a handover resulting in change of PCell in RRC_CONNECTED the UE shall defer access barring checks until it has obtained valid UAC information (from *SIB1*) from the target cell.

[TS 38.331, clause 5.3.14.2]

Upon initiation of the procedure, the UE shall:

- 1> if timer T390 is running for the Access Category:
 - 2> consider the access attempt as barred;
- 1> else if timer T302 is running and the Access Category is neither '2' nor '0':
 - 2> consider the access attempt as barred;
- 1> else:
 - 2> if the Access Category is '0':
 - 3> consider the access attempt as allowed;
 - 2> else:
 - 3> if *SIB1* includes *uac-BarringPerPLMN-List* and the *uac-BarringPerPLMN-List* contains an *UAC-BarringPerPLMN* entry with the *plmn-IdentityIndex* corresponding to the PLMN selected by upper layers (see TS 24.501 [23]):
 - 4> select the *UAC-BarringPerPLMN* entry with the *plmn-IdentityIndex* corresponding to the PLMN selected by upper layers;
 - 4> in the remainder of this procedure, use the selected *UAC-BarringPerPLMN* entry (i.e. presence or absence of access barring parameters in this entry) irrespective of the *uac-BarringForCommon* included in *SIB1*;
 - 3> else if *SIB1* includes *uac-BarringForCommon*:
 - 4> in the remainder of this procedure use the *uac-BarringForCommon* (i.e. presence or absence of these parameters) included in *SIB1*;

- 3> else:
 - 4> consider the access attempt as allowed;
- 3> if *uac-BarringForCommon* is applicable or the *uac-ACBarringListType* indicates that *uac-ExplicitACBarringList* is used:
 - 4> if the corresponding *UAC-BarringPerCatList* contains a *UAC-BarringPerCat* entry corresponding to the Access Category:
 - 5> select the *UAC-BarringPerCat* entry;
 - 5> if the *uac-BarringInfoSetList* contains a *UAC-BarringInfoSet* entry corresponding to the selected *uac-barringInfoSetIndex* in the *UAC-BarringPerCat*:
 - 6> select the *UAC-BarringInfoSet* entry;
 - 6> perform access barring check for the Access Category as specified in 5.3.14.5, using the selected *UAC-BarringInfoSet* as "UAC barring parameter";
 - 5> else:
 - 6> consider the access attempt as allowed;
- 4> else:
 - 5> consider the access attempt as allowed;
- 3> else if the *uac-ACBarringListType* indicates that *uac-ImplicitACBarringList* is used:
 - 4> select the *uac-BarringInfoSetIndex* corresponding to the Access Category in the *uac-ImplicitACBarringList*;
 - 4> if the *uac-BarringInfoSetList* contains the *UAC-BarringInfoSet* entry corresponding to the selected *uac-BarringInfoSetIndex*:
 - 5> select the *UAC-BarringInfoSet* entry;
 - 5> perform access barring check for the Access Category as specified in 5.3.14.5, using the selected *UAC-BarringInfoSet* as "UAC barring parameter";
 - 4> else:
 - 5> consider the access attempt as allowed;
- 3> else:
 - 4> consider the access attempt as allowed;
- 1> if the access barring check was requested by upper layers:
 - 2> if the access attempt is considered as barred:
 - 3> if timer T302 is running:
 - 4> inform the upper layer that access barring is applicable for all access categories except categories '0' and '2', upon which the procedure ends;
 - 3> else:
 - 4> inform upper layers that the access attempt for the Access Category is barred, upon which the procedure ends;
 - 2> else:
 - 3> inform upper layers that the access attempt for the Access Category is allowed, upon which the procedure ends;

- 1> else:
 - 2> the procedure ends.

[TS 38.331, clause 5.3.14.4]

The UE shall:

- 1> if timer T302 expires or is stopped, and if timer T390 corresponding to an Access Category is not running; or
- 1> if timer T390 corresponding to an Access Category other than '2' expires or is stopped, and if timer T302 is not running; or
- 1> if timer T390 corresponding to the Access Category '2' expires or is stopped:
 - 2> consider the barring for this Access Category to be alleviated;
- 1> when barring for an Access Category is considered being alleviated:
 - 2> if the Access Category was informed to upper layers as barred:
 - 3> inform upper layers about barring alleviation for the Access Category.
 - 2> if barring is alleviated for Access Category '8':
 - 3> perform actions specified in 5.3.13.8;

[TS 38.331, clause 5.3.14.5]

The UE shall:

- 1> if one or more Access Identities are indicated according to TS 24.501 [23], and
- 1> if for at least one of these Access Identities the corresponding bit in the *uac-BarringForAccessIdentity* contained in "UAC barring parameter" is set to *zero*:
 - 2> consider the access attempt as allowed;
- 1> else:
 - 2> draw a random number '*rand*' uniformly distributed in the range: $0 \leq rand < 1$;
 - 2> if '*rand*' is lower than the value indicated by *uac-BarringFactor* included in "UAC barring parameter":
 - 3> consider the access attempt as allowed;
 - 2> else:
 - 3> consider the access attempt as barred;
- 1> if the access attempt is considered as barred:
 - 2> draw a random number '*rand*' that is uniformly distributed in the range $0 \leq rand < 1$;
 - 2> start timer T390 for the Access Category with the timer value calculated as follows, using the *uac-BarringTime* included in "AC barring parameter":

$$T390 = (0.7 + 0.6 * rand) * uac-BarringTime.$$

11.3.8.3 Test description

11.3.8.3.1 Pre-test conditions

System Simulator:

- NR Cell 1 and NR Cell 3 belong to the same tracking areas according to TS 38.508-1 [4] Table 4.4.2-3.

- System information combination NR-4 in TS 38.508-1 [4] sub-clause 4.4.3.1.2 is used in NR cells

UE:

None.

Preamble:

The UE is in state IN-A on NR cell 1 according to TS 38.508-1 [4] Table 4.4A.2-1.

11.3.8.3.2 Test procedure sequence

Table 11.3.8.3.2-1/2 illustrate the downlink power levels and other changing parameters to be applied for the cell at various time instants of the test execution. The exact instants on which these values shall be applied are described in the texts in this clause. The configuration "T1" indicates the initial conditions for preamble. Configurations marked "T2" is applied at the points indicated in the Main behaviour description in Table 11.3.8.3.2-3.

Table 11.3.8.3.2-1: Time instances of cell power level and parameter changes for FR1

| | Parameter | Unit | NR Cell 1 | NR Cell 3 | Remark |
|----|---------------------|-------------|-----------|-----------|---|
| T1 | SS/PBCH
SSS EPRE | dBm/
SCS | -88 | Off | The power level is such that $S_{rxlevNRCell1} > 0$ |
| | Qrxlevmin | dBm | -110 | - | |
| T2 | SS/PBCH
SSS EPRE | dBm/
SCS | -99 | -88 | The power level values are assigned to satisfy
$R_{NRCell 1} < R_{NRCell 3}$ |
| | Qrxlevmin | dBm | -110 | -110 | |

Table 11.3.8.3.2-2: Time instances of cell power level and parameter changes for FR2

| | Parameter | Unit | NR Cell 1 | NR Cell 3 | Remark |
|----|---------------------|-------------|--------------------------|--------------------------|---|
| T1 | SS/PBCH
SSS EPRE | dBm/
SCS | -82 | Off | The power level is such that $S_{rxlevNRCell1} > 0$ |
| | Qrxlevmin | dBm | -
110+Delta(
NRf1) | - | |
| T2 | SS/PBCH
SSS EPRE | dBm/
SCS | -91 | -82 | The power level values are assigned to satisfy
$R_{NRCell 1} < R_{NRCell 3}$ |
| | Qrxlevmin | dBm | -
110+Delta(
NRf1) | -
110+Delta(
NRf1) | |

Table 11.3.8.3.2-3: Main behaviour

| St | Procedure | Message Sequence | | TP | Verdict |
|--|--|------------------|---------------------------------|----|---------|
| | | U - S | Message | | |
| 1 | Make the UE attempt an MTSI MO Speech Call (Note 1).
Timer T390 is started (Note 2) | - | - | - | - |
| 2 | Check: Does the UE send NR <i>RRCSetupRequest</i> with <i>EstablishmentCause</i> set to ' <i>mo-VoiceCall</i> ' in the next 5 sec? | --> | NR RRC: <i>RRCSetupRequest</i> | 1 | F |
| 3 | Set the power levels according to "T2" as per Table 11.3.8.3.2-1/2 for UE to reselect to NR Cell 3. | - | - | - | - |
| 4 | FR1: Wait for 34 seconds after step 3 and within 20 seconds make the UE attempt an MTSI MO Speech Call
FR2: Wait for 130 seconds after step 3 and within 20 seconds make the UE attempt an MTSI MO Speech Call (Note 3) (Note 1). | | | | |
| 5 | Check: Does the UE send NR <i>RRCSetupRequest</i> with <i>EstablishmentCause</i> set to ' <i>mo-VoiceCall</i> ' on NR Cell 3? | --> | NR RRC: <i>RRCSetupRequest</i> | 1 | P |
| 5A | The SS transmits an <i>RRCSetup</i> message. | <-- | NR RRC: <i>RRCSetup</i> | | |
| 5B | The UE transmits an <i>RRCSetupComplete</i> . | --> | NR RRC: <i>RRCSetupComplete</i> | | |
| 6 | SS transmits an <i>RRCRelease</i> message to release RRC connection and move the UE to RRC_IDLE. | <-- | NR RRC: <i>RRCRelease</i> | - | - |
| <p>Note 1: MO MMTEL Voice call is triggered by AT commands.</p> <p>Note 2: T390 timer value is calculated by "T390 = (0.7 + 0.6 * rand) * uac-BarringTime". With uac-BarringTime as s256 the worst-case timer value is 180 seconds which covers both FR1 and FR2 reselection scenario.</p> <p>Note 3: The wait time for reselection to a newly detected inter frequency cell is selected to cover T_{detect,NR_Inter} ($25 \times 1280ms = 32s$ for FR1 and $25 \times 4 \times 1280ms = 128s$ for FR2) + T_{SI-NR} (1.28s for FR1 and FR2) = 33.28s rounded up to 34s for FR1 and 129.28s rounded up to 130s for FR2. 20 seconds is an arbitrary value chosen to allow the user to make the MTSI MO Speech Call.</p> | | | | | |

11.3.8.3.3

Specific message contents

Table 11.3.8.3.3-1: SIB1 for NR Cell 1 (All steps, Table 11.3.8.3.2-3)

| Derivation Path: TS 38.508-1 [4], Table 4.6.1-28 | | | |
|--|--------------|---------|-----------|
| Information Element | Value/remark | Comment | Condition |
| SIB1 ::= SEQUENCE { | | | |
| uac-BarringForCommon SEQUENCE { | | | |
| UAC-BarringPerCatList SEQUENCE (SIZE (1..maxAccessCat-1)) OF UAC-BarringPerCat { | 1 entry | | |
| UAC-BarringPerCat[1] SEQUENCE { | | entry 1 | |
| accessCategory | 4 | | |
| uac-barringInfoSetIndex | 1 | | |
| } | | | |
| } | | | |
| uac-BarringPerPLMN-List | Not present | | |
| uac-BarringInfoSetList ::= SEQUENCE (SIZE(1..maxBarringInfoSet)) OF UAC-BarringInfoSet { | 1 entry | | |
| UAC-BarringInfoSet[1] SEQUENCE { | | entry 1 | |
| uac-BarringFactor | p00 | | |
| uac-BarringTime | s256 | | |
| uac-BarringForAccessIdentity | '0000000'B | | |
| } | | | |
| } | | | |
| uac-AccessCategory1-SelectionAssistanceInfo | Not Present | | |
| } | | | |
| } | | | |

11.3.9 UAC / Access Identity 0 / ODAC / PLMN / RPLMN / not EPLMN

11.3.9.1 Test Purpose (TP)

(1)

```
with { UE not configured for special AIs (1,2,11-15) having received Operator Defined Access
Category "x" in the range 32..63 with access category criteria type set to "DNN" valid in the
selected PLMN or RPLMN as part of Registration Procedure }
ensure that {
  when { SIB1 message indicates no barring for Access category 7 but 0% accessibility for Access
Category "x" }
  then { UE does not initiate PDU Session Establishment for the "DNN" }
}
```

(2)

```
with { UE not configured for special AIs (1,2,11-15) having received Operator Defined Access
Category "x" in the range 32..63 with access category criteria type set to "DNN" valid in the
selected PLMN or RPLMN as part of Registration Procedure , SIB1 message indicates no barring for
Access category 7 but 0% accessibility for Access Category "x" }
ensure that {
  when { UE moves to another cell belonging to a different PLMN not equivalent to the previous
PLMN }
  then { UE is able to initiate PDU Session Establishment for "DNN" in the new PLMN }
}
```

11.3.9.2 Conformance requirements

References: The conformance requirements covered in the present TC are specified in TS 24.501: clause 4.5.3 and TS 38.331: clause 5.3.14.1, 5.3.14.2, 5.3.14.4 and 5.3.14.5. Unless otherwise stated these are Rel-15 requirements.

[TS 24.501, clause 4.5.3]

Operator-defined access category definitions can be signalled to the UE using NAS signalling. Each operator-defined access category definition consists of the following parameters:

- a) a precedence value which indicates in which order the UE shall evaluate the operator-defined category definition for a match;
- b) an operator-defined access category number, i.e. access category number in the 32-63 range that uniquely identifies the access category in the PLMN in which the access categories are being sent to the UE;
- c) criteria consisting of one or more access category criteria type and associated access category criteria type values. The access category criteria type can be set to one of the following:
 - 1) DNN;
 - 2) OS Id + OS App Id of application triggering the access attempt; or
 - 3) S-NSSAI; and

NOTE 1: An access category criteria type can be associated with more than one access category criteria values.

- d) optionally, a standardized access category. This standardized access category is used in combination with the access identities of the UE to determine the RRC establishment cause as specified in subclause 4.5.6.

An access attempt matches the criteria of an operator-defined access category definition, if the access attempt matches all access category criteria types included in the criteria with any of the associated access criteria type values.

Each operator-defined access category definition has a different precedence value.

Several operator-defined access category definitions can have the same operator-defined access category number.

If:

- an access category in bullet d) is not provided;

- an access category in bullet d) is provided and is not a standardized access category; or
- an access category in bullet d) is provided, is a standardized access category and is not recognized by the UE;

the UE shall use instead:

- access category 3 (MO_sig) if the access attempt is triggered by uplink signalling; or
- access category 7 (MO_data) if the access attempt is triggered by uplink data

in combination with the access identities of the UE to determine the RRC establishment cause as specified in subclause 4.5.6.

The operator-defined access category definitions are valid in the PLMN which provided them and in a PLMN equivalent to the PLMN which provided them, as specified in annex C.

If the UE stores operator-defined access category definitions valid in the selected PLMN or the RPLMN, then access control in 5GMM-IDLE mode will only be performed for the event a) defined in subclause 4.5.1. If the transition from 5GMM-IDLE mode over 3GPP access to 5GMM-CONNECTED mode is due to a UE NAS initiated 5GMM specific procedure, then this access attempt shall be mapped to one of the standardized access categories in the range < 32, see subclause 4.5.2. I.e. for this case the UE shall skip the checking of operator-defined access category definitions.

If the UE stores operator-defined access category definitions valid in the selected PLMN or the RPLMN, then access control in 5GMM-CONNECTED mode and in 5GMM-CONNECTED mode with RRC inactive indication will only be performed for the events 1) to 6) defined in subclause 4.5.1.

The UE shall handle the operator-defined access category definitions stored for the RPLMN as specified in subclause 5.4.4.3, subclause 5.5.1.2.4, and subclause 5.5.1.3.4.

When the UE is switched off, the UE shall keep the operator-defined access category definitions so that the operator-defined access category definitions can be used after switch on.

When the UE selects a new PLMN which is not equivalent to the previously selected PLMN, the UE shall stop using the operator-defined access category definitions stored for the previously selected PLMN and should keep the operator-defined access category definitions stored for the previously selected PLMN.

NOTE 2: When the UE selects a new PLMN which is not equivalent to the previously selected PLMN, the UE can delete the operator-defined access category definitions stored for the previously selected PLMN e.g. if there is no storage space in the UE.

[TS 38.331, clause 5.3.14.1]

The purpose of this procedure is to perform access barring check for an access attempt associated with a given Access Category and one or more Access Identities upon request from upper layers according to TS 24.501 [23] or the RRC layer.

After a PCell change in RRC_CONNECTED the UE shall defer access barring checks until it has obtained *SIB1* (as specified in 5.2.2.2) from the target cell.

[TS 38.331, clause 5.3.14.2]

Upon initiation of the procedure, the UE shall:

- 1> if timer T390 is running for the Access Category:
 - 2> consider the access attempt as barred;
- 1> else if timer T302 is running and the Access Category is neither '2' nor '0':
 - 2> consider the access attempt as barred;
- 1> else:
 - 2> if the Access Category is '0':
 - 3> consider the access attempt as allowed;

2> else:

3> if *SIB1* includes *uac-BarringPerPLMN-List* and the *uac-BarringPerPLMN-List* contains an *UAC-BarringPerPLMN* entry with the *plmn-IdentityIndex* corresponding to the PLMN selected by upper layers (see TS 24.501 [23]):

4> select the *UAC-BarringPerPLMN* entry with the *plmn-IdentityIndex* corresponding to the PLMN selected by upper layers;

4> in the remainder of this procedure, use the selected *UAC-BarringPerPLMN* entry (i.e. presence or absence of access barring parameters in this entry) irrespective of the *uac-BarringForCommon* included in *SIB1*;

3> else if *SIB1* includes *uac-BarringForCommon*:

4> in the remainder of this procedure use the *uac-BarringForCommon* (i.e. presence or absence of these parameters) included in *SIB1*;

3> else:

4> consider the access attempt as allowed;

3> if *uac-BarringForCommon* is applicable or the *uac-ACBarringListType* indicates that *uac-ExplicitACBarringList* is used:

4> if the corresponding *UAC-BarringPerCatList* contains a *UAC-BarringPerCat* entry corresponding to the Access Category:

5> select the *UAC-BarringPerCat* entry;

5> if the *uac-BarringInfoSetList* contains a *UAC-BarringInfoSet* entry corresponding to the selected *uac-barringInfoSetIndex* in the *UAC-BarringPerCat*:

6> select the *UAC-BarringInfoSet* entry;

6> perform access barring check for the Access Category as specified in 5.3.14.5, using the selected *UAC-BarringInfoSet* as "UAC barring parameter";

5> else:

6> consider the access attempt as allowed;

4> else:

5> consider the access attempt as allowed;

3> else if the *uac-ACBarringListType* indicates that *uac-ImplicitACBarringList* is used:

4> select the *uac-BarringInfoSetIndex* corresponding to the Access Category in the *uac-ImplicitACBarringList*;

4> if the *uac-BarringInfoSetList* contains the *UAC-BarringInfoSet* entry corresponding to the selected *uac-BarringInfoSetIndex*:

5> select the *UAC-BarringInfoSet* entry;

5> perform access barring check for the Access Category as specified in 5.3.14.5, using the selected *UAC-BarringInfoSet* as "UAC barring parameter";

4> else:

5> consider the access attempt as allowed;

3> else:

4> consider the access attempt as allowed;

- 1> if the access barring check was requested by upper layers:
 - 2> if the access attempt is considered as barred:
 - 3> if timer T302 is running:
 - 4> if timer T390 is running for Access Category '2':
 - 5> inform the upper layer that access barring is applicable for all access categories except categories '0', upon which the procedure ends;
 - 4> else
 - 5> inform the upper layer that access barring is applicable for all access categories except categories '0' and '2', upon which the procedure ends;
 - 3> else:
 - 4> inform upper layers that the access attempt for the Access Category is barred, upon which the procedure ends;
 - 2> else:
 - 3> inform upper layers that the access attempt for the Access Category is allowed, upon which the procedure ends;
- 1> else:
 - 2> the procedure ends.

[TS 38.331, clause 5.3.14.4]

The UE shall:

- 1> if timer T302 expires or is stopped:
 - 2> for each Access Category for which T390 is not running:
 - 3> consider the barring for this Access Category to be alleviated:
- 1> else if timer T390 corresponding to an Access Category other than '2' expires or is stopped, and if timer T302 is not running:
 - 2> consider the barring for this Access Category to be alleviated;
- 1> else if timer T390 corresponding to the Access Category '2' expires or is stopped:
 - 2> consider the barring for this Access Category to be alleviated;
- 1> when barring for an Access Category is considered being alleviated:
 - 2> if the Access Category was informed to upper layers as barred:
 - 3> inform upper layers about barring alleviation for the Access Category.
 - 2> if barring is alleviated for Access Category '8':
 - 3> perform actions specified in 5.3.13.8;

[TS 38.331, clause 5.3.14.5]

The UE shall:

- 1> if one or more Access Identities are indicated according to TS 24.501 [23], and
- 1> if for at least one of these Access Identities the corresponding bit in the *uac-BarringForAccessIdentity* contained in "UAC barring parameter" is set to *zero*:

2> consider the access attempt as allowed;

1> else:

2> draw a random number 'rand' uniformly distributed in the range: $0 \leq \text{rand} < 1$;

2> if 'rand' is lower than the value indicated by uac-BarringFactor included in "UAC barring parameter":

3> consider the access attempt as allowed;

2> else:

3> consider the access attempt as barred;

1> if the access attempt is considered as barred:

2> draw a random number 'rand' that is uniformly distributed in the range $0 \leq \text{rand} < 1$;

2> start timer T390 for the Access Category with the timer value calculated as follows, using the uac-BarringTime included in "AC barring parameter":

$$T390 = (0.7 + 0.6 * \text{rand}) * \text{uac-BarringTime}.$$

11.3.9.3 Test description

11.3.9.3.1 Pre-test conditions

System Simulator:

- 2 NR cells: NR Cell 1 and 12 as specified in TS 38.508-1 [4] table 4.4.2-3.
- System information combination NR-1 as defined in TS 38.508-1 [4] Table 4.4.3.1.2-1 is used in NR cells.

UE:

- None.

Preamble:

- The UE is registered on PLMN1 (NR Cell 1) and in state 3N-A on NR Cell 1(serving cell) by using the procedure described in TS 38.508-1 [4] clause 4.5.2.2 with "connected without release" except that the REGISTRATION ACCEPT message indicates Operator Defined Access Category ""33"" as described in Table 11.3.9.3.3-1.

11.3.9.3.2 Test procedure sequence

Table 11.3.9.3.2-1 for FR1 and Table 11.3.9.3.2-2 for FR2 illustrates the downlink power levels and other changing parameters to be applied for the cells at various time instants of the test execution. Row marked "T0" denotes the initial conditions in preamble, while the column marked "T1" is to be applied subsequently in the Main behaviour. The exact instants on which these values shall be applied are described in the texts in this clause.

Table 11.3.9.3.2-1: Time instances of cell power level and parameter changes for FR1

| | Parameter | Unit | NR Cell 1 | NR Cell 12 | Remarks |
|--|---------------------|---------|-----------|------------|--|
| T0 | SS/PBCH
SSS EPRE | dBm/SCS | -88 | Off | The power level values are assigned to ensure UE registered on NR Cell 1. |
| T1 | SS/PBCH
SSS EPRE | dBm/SCS | Off | -88 | The power level values are assigned to ensure UE registered on NR Cell 12. |
| Note 1: Power level "Off" is defined in TS 38.508-1 [4] Table 6.2.2.1-3. | | | | | |

Table 11.3.9.3.2-2: Time instances of cell power level and parameter changes for FR2

| | Parameter | Unit | NR Cell 1 | NR Cell 12 | Remarks |
|--|---------------------|---------|-----------|------------|--|
| T0 | SS/PBCH
SSS EPRE | dBm/SCS | -82 | Off | The power level values are assigned to ensure UE registered on NR Cell 1. |
| T1 | SS/PBCH
SSS EPRE | dBm/SCS | Off | -82 | The power level values are assigned to ensure UE registered on NR Cell 12. |
| Note 1: Power level "Off" is defined in TS 38.508-1 [4] Table 6.2.2.2-2. | | | | | |

Table 11.3.9.3.2-3: Main behaviour

| St | Procedure | Message Sequence | | TP | Verdict |
|------|--|------------------|--|----|---------|
| | | U - S | Message | | |
| 1-2 | Void | - | - | - | - |
| 3 | Make the UE attempt to establish a PDU session for the DNN defined in Table 11.3.9.3.3-1. This can be done by an AT/MMI command. | - | - | - | - |
| 4 | Check: Does the UE transmit a PDU SESSION ESTABLISHMENT REQUEST and the DNN in UL NAS TRANSPORT message is the same value in UL NAS TRANSPORT message in preamble within 20s? | --> | 5GMM: UL NAS TRANSPORT
5GSM: PDU SESSION
ESTABLISHMENT REQUEST | 1 | F |
| 5 | The SS adjusts the NR Cells power levels according to row "T1" in table 11.3.9.3.2-1/2. | - | - | - | - |
| 6 | The mobility registration updating procedure described in TS 38.508-1 [4] Table 4.9.5.2.2-1 is performed on NR Cell 12 and release RRC connection. | - | - | - | - |
| 7 | Make the UE attempt to establish a PDU session for the DNN defined in Table 11.3.9.3.3-1. This can be done by an AT/MMI command. | - | - | - | - |
| 8 | Check: Does the UE transmit a <i>RRCSetupRequest</i> message and <i>establishmentCause</i> is set to <i>mo-Data</i> ? | --> | NR RRC: <i>RRCSetupRequest</i> | 2 | P |
| 9-14 | Steps 3-8 of the generic procedure for NR RRC_Connected specified in TS 38.508-1 Table 4.5.4.2-3 are performed. | - | - | - | - |
| 15 | Check: Does the UE transmit a PDU SESSION ESTABLISHMENT REQUEST and the DNN value in UL NAS TRANSPORT message is the same as the DNN value of Operator-defined access category definitions defined in Table 11.3.9.3.3-1 | --> | 5GMM: UL NAS TRANSPORT
5GSM: PDU SESSION
ESTABLISHMENT REQUEST | 2 | P |
| 16 | The SS transmits <i>RRCReconfiguration</i> message containing PDU SESSION ESTABLISHMENT ACCEPT message. | <-- | NR RRC: <i>RRCReconfiguration</i>
5GMM: DL NAS TRANSPORT
5GSM: PDU SESSION
ESTABLISHMENT ACCEPT | - | - |
| 17 | The UE transmits <i>RRCReconfigurationComplete</i> message to confirm the establishment of DRB. | --> | NR RRC:
<i>RRCReconfigurationComplete</i> | - | - |
| 18 | Void | - | - | - | - |

11.3.9.3.3 Specific message contents

Table 11.3.9.3.3-1: REGISTRATION ACCEPT (preamble)

| Derivation path: TS 38.508 [4] Table 4.7.1-7 | | | |
|--|---|---|-----------|
| Information Element | Value/remark | Comment | Condition |
| Operator-defined access category definitions | | | |
| Precedence value | '0000 0000'B | | |
| PSAC | '1'B | Value 1 means that standardized access category is present. | |
| Operator-defined access category number | '00001'B | 33 | |
| Criteria | | | |
| Criteria type | '0000 0000'B | DNN type | |
| Criteria value | | | |
| DNN length-value pair count | '0000 0001'B | | |
| DNN length-value pair | | | |
| DNN value length | Set to the length in octets of the DNN value field. | | |
| DNN value | 'ABCD' | | |
| Standardized access category | '00111'B | Access category number 7 | |

Table 11.3.9.3.3-2: SIB1 of NR Cell 1 (preamble and all steps, Table 11.3.9.3.2-3)

| Derivation Path: TS 38.508-1 [4], Table 4.6.1-28 | | | |
|--|--------------|---|-----------|
| Information Element | Value/remark | Comment | Condition |
| SIB1 ::= SEQUENCE { | | | |
| uac-BarringInfo SEQUENCE { | | | NR cell 1 |
| uac-BarringForCommon SEQUENCE (SIZE (1..maxAccessCat-1)) OF UAC-BarringPerCat { | 1 entry | | |
| UAC-BarringPerCat[1] SEQUENCE { | | entry 1 | |
| accessCategory | 33 | | |
| uac-barringInfoSetIndex | 1 | Value 1 corresponds to the first entry in uac-BarringInfoSetList | |
| } | | | |
| } | | | |
| uac-BarringPerPLMN-List | Not present | | |
| uac-BarringInfoSetList SEQUENCE (SIZE(1..maxBarringInfoSet)) OF UAC-BarringInfoSet { | 1 entry | | |
| UAC-BarringInfoSet[1] SEQUENCE { | | entry 1 | |
| uac-BarringFactor | p00 | 0% access probability | |
| uac-BarringTime | s16 | 16 s | |
| uac-BarringForAccessIdentity | '1111111'B | Value 1 means that access attempt is not allowed for the corresponding access identity. The leftmost bit, bit 0 in the bit string corresponds to Access Identity 1. | |
| } | | | |
| } | | | |
| uac-AccessCategory1-SelectionAssistanceInfo | Not Present | | |
| } | | | |
| } | | | |

11.4 Emergency Services

11.4.1 5GMM-REGISTERED.NORMAL-SERVICE / 5GMM-IDLE / Emergency call / Utilising emergency number stored on the USIM / New emergency PDU session / Network failing the authentication check (5G AKA)

11.4.1.1 Test Purpose (TP)

(1)

```
with { UE in 5GMM-REGISTERED.NORMAL-SERVICE state and 5GMM-IDLE mode }
ensure that {
  when { UE is requested to make an outgoing call using an emergency number stored on the USIM }
  then { UE establishes an RRC connection with the RRC establishmentCause set to "emergency", and,
  sends a SERVICE REQUEST message with Service type IE set to "emergency services", and, establishes a
  New emergency PDU session by sending an UL NAS TRANSPORT message with Request type set to "initial
  emergency request" and a PDU SESSION ESTABLISHMENT REQUEST }
}
```

(2)

```
with { UE in 5GMM-REGISTERED.NORMAL-SERVICE state and 5GMM-CONNECTED mode having established an
Emergency call }
ensure that {
  when { UE establishes that the network has failed the authentication check during a 5G AKA based
  primary authentication and key agreement procedure }
  then { UE continues using the current security context, and, releases all non-emergency PDU
  sessions by initiating UE-requested PDU session release procedure and treats the active cell as
  barred for non-emergency services }
}
```

11.4.1.2 Conformance requirements

References: The conformance requirements covered in the present TC are specified in: TS 38.331 [12], subclause 5.3.3.3, TS 24.501 [22], subclauses 5.6.1.2, 6.4.1.2, 5.4.1.3.7, TS 22.101 [42], subclause 10.1.1. Unless otherwise stated these are Rel-15 requirements.

[TS 38.331, subclause 5.3.3.3]

The UE shall set the contents of *RRCSetupRequest* message as follows:

...

1> set the *establishmentCause* in accordance with the information received from upper layers;

The UE shall submit the *RRCSetupRequest* message to lower layers for transmission.

[TS 24.501, subclause 5.6.1.2]

The UE initiates the service request procedure by sending a SERVICE REQUEST message to the AMF and starts timer T3517.

If the UE is sending the SERVICE REQUEST message from 5GMM-IDLE mode and the UE needs to send non-clear-text IEs, the UE shall send the SERVICE REQUEST message including the NAS message container IE as described in subclause 4.4.6.

...

For case c) in subclause 5.6.1.1, the Uplink data status IE shall not be included in the SERVICE REQUEST message except if the UE has one or more active always-on PDU sessions associated with the access type over which the SERVICE REQUEST message is sent. If the UE is not a UE configured for high priority access in selected PLMN and:

- a) if the SERVICE REQUEST message is triggered by a request for emergency services from the upper layer, the UE shall set the service type IE in the SERVICE REQUEST message to "emergency services"; or

[TS 24.501, subclause 6.4.1.2]

In order to initiate the UE-requested PDU session establishment procedure, the UE shall create a PDU SESSION ESTABLISHMENT REQUEST message.

NOTE 0: When IMS voice is available over either 3GPP access or non-3GPP access, the "voice centric" UE in 5GMM-REGISTERED state will receive a request from upper layers to establish the PDU session for IMS signalling, if the conditions for performing an initial registration with IMS indicated in 3GPP TS 24.229 [14] subclause U.3.1.2 are satisfied.

If the UE requests to establish a new PDU session, the UE shall allocate a PDU session ID which is not currently being used by another PDU session over either 3GPP access or non-3GPP access.

The UE shall allocate a PTI value currently not used and shall set the PTI IE of the PDU SESSION ESTABLISHMENT REQUEST message to the allocated PTI value.

...

If the UE requests to establish a new emergency PDU session, the UE shall set the SSC mode IE of the PDU SESSION ESTABLISHMENT REQUEST message to "SSC mode 1".

...

The UE shall transport:

- a) the PDU SESSION ESTABLISHMENT REQUEST message;
- b) the PDU session ID of the PDU session being established, or being handed over or being transferred;
- ..
- e) the request type which is set to:
 - ...
 - 3) "initial emergency request", if the UE requests to establish a new emergency PDU session; and

...

If the request type is set to "initial emergency request" or "existing emergency PDU session", neither DNN nor S-NSSAI is transported by the UE using the NAS transport procedure as specified in subclause 5.4.5.

[TS 22.101, subclause 10.1.1]

The ME shall identify an emergency number dialled by the end user as a valid emergency number and initiate emergency call establishment if it occurs under one or more of the following conditions. If it occurs outside of the following conditions, the ME should not initiate emergency call establishment but normal call establishment. Emergency number identification takes place before and takes precedence over any other (e.g. supplementary service related) number analysis.

...

- b) Any emergency call number stored on a SIM/USIM when the SIM/USIM is present.

[TS 24.501, subclause 5.4.1.3.7]

- g) Network failing the authentication check.

If the UE deems that the network has failed the authentication check, then it shall request RRC to locally release the RRC connection and treat the active cell as barred (see 3GPP TS 38.304 [28]). The UE shall start any retransmission timers (e.g. T3510, T3517 or T3521), if they were running and stopped when the UE received the first AUTHENTICATION REQUEST message containing an incorrect authentication challenge data causing authentication failure.

...

For items c, d, e, and f whether or not the UE is registered for emergency services:

...

The UE shall deem that the network has failed the authentication check or assume that the authentication is not genuine and proceed as described in item g above if any of the following occurs:

- the timer T3520 expires;

...

For items c, d, e, and f:

...

If a UE has an emergency PDU session established or is establishing an emergency PDU session when timer T3520 expires, the UE shall not deem that the network has failed the authentication check and not behave as described in item g. Instead the UE shall continue using the current security context, if any, release all non-emergency PDU sessions, if any, by initiating UE-requested PDU session release procedure. If there is an ongoing PDU session establishment procedure, the UE shall release all non-emergency PDU sessions upon completion of the PDU session establishment procedure. The UE shall start any retransmission timers (e.g. T3510, T3517 or T3521) if:

- they were running and stopped when the UE received the AUTHENTICATION REQUEST message and detected an authentication failure;
- the procedures associated with these timers have not yet been completed.

The UE shall behave as if the UE is registered for emergency services.

11.4.1.3 Test description

11.4.1.3.1 Pre-test conditions

System Simulator:

- 2 NR Cells
 - NR Cell 1 and NR Cell 2 as defined in TS 38.508-1 [4] Table 4.4.2-3. System information combination NR-1 as defined in TS 38.508-1 [4], subclause 4.4.3.1.2. SIB1 indicates *ims-EmergencySupport*.

UE:

- The UE is equipped with a test USIM with USIM Configuration 20 as defined in TS 38.508-1 [4] Table 6.4.1-20 (USIM contains two Emergency Numbers: 144, 117).

Preamble:

- Cells power level configuration in accordance with TS 38.508-1 [4], Table 6.2.2.1-3:
 - NR Cell 1 "Serving cell"
 - NR Cell 2 "Non-Suitable "Off" cell"
- The UE is in test state 1N-A as defined in TS 38.508-1 [4], subclause 4.4A.2 on NR Cell 1.

11.4.1.3.2 Test procedure sequence

Table 11.4.1.3.2-1: Main behaviour

| St | Procedure | Message Sequence | | TP | Verdict |
|----|---|------------------|--------------------------------|----|---------|
| | | U - S | Message | | |
| - | The following messages are to be observed on NR Cell 1 unless explicitly stated otherwise. | - | - | - | - |
| 1 | Make the UE attempt an IMS emergency call dialling the number 144 which is stored on the USIM. (NOTE 1) | - | - | - | - |
| 2 | Check: Does the UE performs Generic Test Procedure for IMS Emergency call establishment with IMS emergency registration as specified in TS 38.508-1 [4], subclause 4.9.11? | - | - | 1 | - |
| 2A | The SS initiates the 5G AKA based primary authentication and key agreement procedure by sending an AUTHENTICATION REQUEST message; the included ngKSI value is the same as the one used in the initial message SERVICE REQUEST sent in step 2. | <- | AUTHENTICATION REQUEST | - | - |
| 2B | The UE sends an AUTHENTICATION FAILURE message with 5GMM cause #71 "ngKSI already in use" | --> | AUTHENTICATION FAILURE | - | - |
| - | EXCEPTION: Depending on the number of non-IMS Emergency relevant PDUs active at this moment of time step 2C is repeated 1 or more times. | - | - | - | - |
| 2C | FOR i=1 TO i=pc_noOf_PDUs

Repeat the PDU session release procedure specified in Table 11.4.1.3.2-2: Parallel behaviour.

Depending on UE implementation the PDU session release procedures can run in parallel or in sequence. | - | - | - | - |
| 3 | Make the UE release the emergency call. (NOTE 1) | - | - | - | - |
| 4 | The Generic test procedure for IMS MO Emergency call release as specified in TS 38.508-1 [4], subclause 4.9.12A takes place. | - | - | - | - |
| 5 | SS releases the RRC connection | <- | NR RRC: <i>RRCRelease</i> | - | - |
| 6 | Make the UE attempt an IMS [non-emergency] call. (NOTE 1) | - | - | - | - |
| 7 | Check: Does the UE transmit in the next 10 sec an <i>RRCSetupRequest</i> message? | --> | NR RRC: <i>RRCSetupRequest</i> | 2 | F |
| - | The SS configures:
- NR Cell 1 as "Non-Suitable "Off" cell"
- NR Cell 2 as "Serving cell". | - | - | - | - |
| - | The following messages are to be observed on NR Cell 2 unless explicitly stated otherwise. | - | - | - | - |
| 8 | The UE performs the Registration procedure for mobility registration update as specified in TS 38.508-1 [4] subclause 4.9.5, ' <i>connected without release</i> '. | - | - | - | - |
| 9 | The UE performs the generic procedure for UE-requested PDU session(s) establishment, specified in TS 38.508-1 [4] subclause 4.5A.2, performing establishment of UE-requested PDU session(s) with ExpectedNumberOfNewPDUSessions = pc_noOf_PDUs. | - | - | 2 | - |

NOTE 1: This could be done by e.g. MMI or AT command.

Table 11.4.1.3.2-2: Parallel behaviour

| St | Procedure | Message Sequence | | TP | Verdict |
|----|---|------------------|-----------------------------|----|---------|
| | | U - S | Message | | |
| 1 | Check: Does the UE transmit a PDU SESSION RELEASE REQUEST message with PDU session ID equal to one of the IDs of an existing PDU session BUT different to the PDU session ID assigned to the Emergency PDU session in step 2, Table 11.4.1.3.2-1? | - | PDU SESSION RELEASE REQUEST | 2 | P |
| 2 | Check: Does the UE perform PDU session release procedure defined in clause 4.9.21 of TS 38.508-1 [4]? | - | | 2 | P |

11.4.1.3.3 Specific message contents

Table 11.4.1.3.3-1: Message AUTHENTICATION REQUEST (step 2A, Table 11.4.1.3.2-1)

| Derivation path: TS 38.508-1 [4], Table 4.7.1-1 | | | |
|---|--|---------|-----------|
| Information Element | Value/Remark | Comment | Condition |
| ngKSI | The same ng-KSI assigned in the Preamble and indicated in the initial message SERVICE REQUEST sent in step 2 | | |

Table 11.4.1.3.3-2: Message AUTHENTICATION FAILURE (step 2B, Table 11.4.1.3.2-1)

| Derivation path: TS 38.508-1 [4], Table 4.7.1-4 | | | |
|---|--------------|----------------------|-----------|
| Information Element | Value/Remark | Comment | Condition |
| 5GMM cause | '0100 0111'B | ngKSI already in use | |

11.4.2 5GMM-DEREGISTERED.LIMITED-SERVICE / Emergency call / Utilisation of emergency numbers stored on the ME / Initial registration for emergency services / Handling of forbidden PLMNs

11.4.2.1 Test Purpose (TP)

(1)

```

with { UE in 5GMM-DEREGISTERED.LIMITED-SERVICE state }
ensure that {
  when { UE is requested to make an outgoing call using an emergency number stored on the ME }
  then { UE establishes an RRC connection with the RRC establishmentCause set to "emergency", and,
attempts an Initial registration for emergency services by sending a REGISTRATION REQUEST message
with IE Service type set to "emergency services", and, accepts and applies security with NULL
security and integrity algorithms, and, after successful completion of the registration for
emergency services establishes an emergency PDU session by sending an UL NAS TRANSPORT message with
Request type set to "initial emergency request" and a PDU SESSION ESTABLISHMENT REQUEST }
}

```

(2)

```

with { UE in 5GMM-DEREGISTERED.LIMITED-SERVICE state }
ensure that {
  when { UE has performed an IMS Emergency call on a forbidden PLMN }
  then { UE does not remove the PLMN code of the accessed PLMN from the list of forbidden PLMNs }
}

```

11.4.2.2 Conformance requirements

References: The conformance requirements covered in the present TC are specified in: TS 38.331 [12], subclause 5.3.3.3, TS 23.501 [37], subclause 5.16.4.1, TS 23.122 [38], subclauses 2, 3.1, 3.5, TS 24.501 [22], subclauses 4.4.4.1, 5.1.3.2.1.3.3, 5.3.2, 5.4.2.3, 5.5.1.2.2, 5.5.1.2.4, 6.4.1.2, TS 22.101 [42], subclause 10.1.1. Unless otherwise stated these are Rel-15 requirements.

[TS 36.331, subclause 5.3.3.3]

The UE shall set the contents of *RRCSetupRequest* message as follows:

...

1> set the *establishmentCause* in accordance with the information received from upper layers;

The UE shall submit the *RRCSetupRequest* message to lower layers for transmission.

[TS 23.501, subclause 5.16.4.1]

UEs that are in limited service state, as specified in TS 23.122 [17], or that camp normally on a cell but failed to register successfully to the network under conditions specified in TS 24.501 [47], initiate the Registration procedure by indicating that the registration is to receive Emergency Services, referred to as Emergency Registration, and a Follow-on request is included in the Registration Request to initiate PDU Session Establishment procedure with a Request Type indicating "Emergency Request". UEs that had registered for normal services and do not have emergency PDU Sessions established and that are subject to Mobility Restriction in the present area or RAT (e.g. because of restricted tracking area) shall initiate the UE Requested PDU Session Establishment procedure to receive Emergency Services, i.e. with a Request Type indicating "Emergency Request". Based on local regulation, the network supporting Emergency Services for UEs in limited service state provides Emergency Services to these UE, regardless whether the UE can be authenticated, has roaming or Mobility Restrictions or a valid subscription.

[TS 23.122, clause 2]

If the MS is unable to find a suitable cell to camp on, or the SIM is not inserted, or if it receives certain responses to an LR request (e.g., "illegal MS"), it attempts to camp on a cell irrespective of the PLMN identity, and enters a "limited service" state in which it can only attempt to make emergency calls. An MS operating in NB-S1 mode, never attempts to make emergency calls.

[TS 23.122, subclause 3.1]

An MS that is attaching for emergency bearer services or is attached for emergency bearer services may access PLMNs in the list of "forbidden PLMNs" or the list of "forbidden PLMNs for GPRS service". The MS shall not remove any entry from the list of "forbidden PLMNs" or the list of "forbidden PLMNs for GPRS service" as a result of such accesses.

[TS 23.122, subclause 3.5]

There are a number of situations in which the MS is unable to obtain normal service from a PLMN. These include:

a) Failure to find a suitable cell of the selected PLMN;

...

(In automatic PLMN selection mode, items a, c and f would normally cause a new PLMN selection, but even in this case, the situation may arise when no PLMNs are available and allowable for use).

For the items a to f, the MS attempts to camp on an acceptable cell, irrespective of its PLMN identity, so that emergency calls can be made if necessary, with the exception that an MS operating in NB-S1 mode, shall never attempt to make emergency calls. When in the limited service state with a valid SIM, the MS shall search for available and allowable PLMNs in the manner described in subclause 4.4.3.1 and when indicated in the SIM also as described in subclause 4.4.3.4. For an MS that is not in eCall only mode, with the exception of performing GPRS attach or EPS attach for emergency bearer services, or performing registration for emergency services, no LR requests are made until a valid SIM is present and either a suitable cell is found or a manual network reselection is performed. For an MS in eCall only mode, no LR requests are made except for performing EPS attach for emergency bearer services or registration for emergency services. When performing GPRS attach or EPS attach for emergency bearer services, or registration for emergency services, the PLMN of the current serving cell is considered as the selected PLMN for the

duration the MS is attached for emergency bearer services or registered for emergency services. In the limited service state the presence of the MS need not be known to the PLMN on whose cell it has camped.

There are also other conditions under which only emergency calls may be made. These are shown in table 2 in clause 5. ProSe direct communication and ProSe direct discovery for public safety use can be initiated if necessary (see 3GPP TS 24.334 [51]) when in the limited service state due to items a) or c) or f). V2X communication over PC5 can be initiated if necessary (see 3GPP TS 24.386 [59]) when in the limited service state due to items a) or c) or f).

[TS 24.501, subclause 4.4.4.1]

The use of "null integrity protection algorithm" 5G-IA0 (see subclause 9.11.3.32) in the current 5G NAS security context is only allowed for an unauthenticated UE for which establishment of emergency services is allowed. For setting the security header type in outbound NAS messages, the UE and the AMF shall apply the same rules irrespective of whether the "null integrity protection algorithm" or any other integrity protection algorithm is indicated in the 5G NAS security context.

If the "null integrity protection algorithm" 5G-IA0 has been selected as an integrity protection algorithm, the receiver shall regard the NAS messages with the security header indicating integrity protection as integrity protected.

[TS 24.501, subclause 5.1.3.2.1.3.3]

The substate 5GMM-DEREGISTERED.LIMITED-SERVICE is chosen in the UE, when it is known that a selected cell for 3GPP access or TA for non-3GPP access is unable to provide normal service (e.g. the selected cell over 3GPP access is in a forbidden PLMN or is in a forbidden tracking area or TA for non-3GPP access is forbidden).

[TS 24.501, subclause 5.3.2]

The UE provides the SUPI to the network in concealed form. The SUCI is a privacy preserving identifier containing the concealed SUPI. When the SUPI contains a network specific identifier, the SUCI shall take the form of an NAI as specified in 3GPP TS 23.003 [4].

A UE supporting N1 mode includes a SUCI:

- a) in the REGISTRATION REQUEST message when the UE is attempting initial registration procedure and a valid 5G-GUTI is not available; or

...

The UE shall use the "null-scheme" as specified in 3GPP TS 33.501 [24] to generate the SUCI, if the following applies:

- a) the UE performs a registration procedure for emergency services or initiates a de-registration procedure before the registration procedure for emergency services was completed successfully; and

[TS 24.501, subclause 5.4.2.3]

If the UE is registered for emergency services, performing initial registration for emergency services or establishing an emergency PDU session and the SECURITY MODE COMMAND message is received with ngKSI value "000" and 5G-IA0 and 5G-EA0 as selected 5G NAS security algorithms, the UE shall locally derive and take in use 5G NAS security context. The UE shall delete existing current 5G NAS security context.

The UE shall accept a SECURITY MODE COMMAND message indicating the "null integrity protection algorithm" 5G-EA0 as the selected 5G NAS integrity algorithm only if the message is received when the UE is registered for emergency services, performing initial registration for emergency services or establishing an emergency PDU session.

[TS 24.501, subclause 5.5.1.2.2]

The UE in state 5GMM-DEREGISTERED shall initiate the registration procedure for initial registration by sending a REGISTRATION REQUEST message to the AMF,

...

- b) when the UE performs initial registration for emergency services;

...

If the UE initiates an initial registration for emergency services or needs to prolong the established NAS signalling connection after the completion of the initial registration procedure (e.g. due to uplink signalling pending), the UE shall set the Follow-on request indicator to 1.

[TS 24.501, subclause 5.5.1.2.4]

If the initial registration procedure is not for emergency services, and if the PLMN identity of the registered PLMN is a member of the list of "forbidden PLMNs", any such PLMN identity shall be deleted from the corresponding list(s).

[TS 24.501, subclause 6.4.1.2]

In order to initiate the UE-requested PDU session establishment procedure, the UE shall create a PDU SESSION ESTABLISHMENT REQUEST message.

NOTE 0: When IMS voice is available over either 3GPP access or non-3GPP access, the "voice centric" UE in 5GMM-REGISTERED state will receive a request from upper layers to establish the PDU session for IMS signalling, if the conditions for performing an initial registration with IMS indicated in 3GPP TS 24.229 [14] subclause U.3.1.2 are satisfied.

If the UE requests to establish a new PDU session, the UE shall allocate a PDU session ID which is not currently being used by another PDU session over either 3GPP access or non-3GPP access.

The UE shall allocate a PTI value currently not used and shall set the PTI IE of the PDU SESSION ESTABLISHMENT REQUEST message to the allocated PTI value.

...

If the UE requests to establish a new emergency PDU session, the UE shall set the SSC mode IE of the PDU SESSION ESTABLISHMENT REQUEST message to "SSC mode 1".

...

The UE shall transport:

- a) the PDU SESSION ESTABLISHMENT REQUEST message;
- b) the PDU session ID of the PDU session being established, or being handed over or being transferred;
- ..
- e) the request type which is set to:
 - ...
 - 3) "initial emergency request", if the UE requests to establish a new emergency PDU session; and

...

If the request type is set to "initial emergency request" or "existing emergency PDU session", neither DNN nor S-NSSAI is transported by the UE using the NAS transport procedure as specified in subclause 5.4.5.

[TS 22.101, subclause 10.1.1]

The ME shall identify an emergency number dialled by the end user as a valid emergency number and initiate emergency call establishment if it occurs under one or more of the following conditions. If it occurs outside of the following conditions, the ME should not initiate emergency call establishment but normal call establishment. Emergency number identification takes place before and takes precedence over any other (e.g. supplementary service related) number analysis.

- a) 112 and 911 shall always be available. These numbers shall be stored on the ME.

11.4.2.3 Test description

11.4.2.3.1 Pre-test conditions

System Simulator:

- 1 NR Cell
- NR Cell 1, as defined in TS 38.508-1 [4], Table 4.4.2-3, with the exception that cells' PLMN is defined in Table 11.4.2.3.1-1 below.

Table 11.4.2.3.1-1: PLMN identifiers

| NR Cell | PLMN name |
|---------|-----------|
| 1 | PLMN2 |

- System information combination NR-1 as defined in TS 38.508-1 [4], subclause 4.4.3.1.2. SIB1 indicates *ims-EmergencySupport*.

UE:

- The UE is equipped with a test USIM with USIM Configuration 15 as defined in TS 38.508-1 [4], Table 6.4.1-15 (PLMN2 is set in it as 'forbidden PLMN', PLMN1 is the HPLMN).

Preamble:

- The UE is in test state 0N-B (Switched Off) as defined in TS 38.508-1 [4], subclause 4.4A.2. Prior to being switched off the UE is registered on PLMN1.

11.4.2.3.2 Test procedure sequence

Table 11.4.2.3.2-1: Main behaviour

| St | Procedure | Message Sequence | | TP | Verdict |
|---|--|------------------|--|----|---------|
| | | U - S | Message | | |
| 1 | Void | - | - | - | - |
| - | The SS configures:
- NR Cell 1 as "Serving cell" | - | - | - | - |
| 2 | Switch the UE on. | - | - | - | - |
| 3 | Make the UE attempt an IMS emergency call dialling a number which is stored on the ME (e.g. 112 or 911). (NOTE 1) | - | - | - | - |
| 4 | Check: Does the UE performs Generic Test Procedure for IMS Emergency call establishment without IMS emergency registration as specified in TS 38.508-1 [4], subclause 4.9.12? | - | - | 1 | - |
| 5 | Make the UE release the emergency call. (NOTE 1) | - | - | - | - |
| 6 | The Generic test procedure for IMS MO Emergency call release as specified in TS 38.508-1 [4], subclause 4.9.12A takes place. | - | - | - | - |
| 7 | Start Timer=10 Check: Does the UE transmit an <i>RRCS_{SetupRequest}</i> message in the next 30sec?sec.
NOTE: This is an arbitrary value to wait for UE initiated detach. | - | - | - | - |
| - | EXCEPTION: Steps 8a1-8b3 describes optional behaviour that depends on the UE implementation. | - | - | - | - |
| 8a1 | The UE transmits a DEREGISTRATION REQUEST message with De-registration type IE set to "Normal de-registration". | --> | NR RRC: <i>ULInformationTransfer</i>
5GMM: DEREGISTRATION REQUEST | - | - |
| 8a2 | The UE transmits a DEREGISTRATION ACCEPT message. | <-- | NR RRC: <i>DLInformationTransfer</i>
5GMM: DEREGISTRATION REQUEST | - | - |
| 8a3 | Stop Timer=10. | - | - | - | - |
| 8b1 | Timer=10 sec expires | - | - | - | - |
| 8b2 | The SS transmits a DEREGISTRATION REQUEST message with Deregistration type IE set to "re-registration required". | <-- | NR RRC: <i>DLInformationTransfer</i>
5GMM: DEREGISTRATION REQUEST | - | - |
| 8b3 | The UE transmits a DEREGISTRATION ACCEPT message. | --> | NR RRC: <i>ULInformationTransfer</i>
5GMM: DEREGISTRATION REQUEST | - | - |
| 9 | SS releases the RRC connection | <-- | NR RRC: <i>RRRelease</i> | - | - |
| 10 | NOTE: This is an arbitrary value to wait for catching not allowed UE behaviour. | - | - | - | - |
| NOTE 1: This could be done by e.g. MMI or AT command. | | | | | |

11.4.2.3.3 Specific message contents

Table 11.4.2.3.3-1: REGISTRATION REQUEST (step 4, Table 11.4.2.3.2-1; step 3, TS 38.508-1 [4], Table 4.9.12.2.2-1)

| Derivation Path: TS 38.508-1 [4], Table 4.7.1-6, condition EMERGENCY. | | | |
|---|--------------|---|-----------|
| Information Element | Value/remark | Comment | Condition |
| 5GS mobile identity | SUCI | The UE shall use the "null-scheme" as specified in 3GPP TS 33.501 [20] to generate the SUCI | |

Table 11.4.2.3.3-2: DEREGISTRATION REQUEST (Step 8a1, Table 11.4.2.3.2-1)

| Derivation Path: TS 38.508-1 [4], Table 4.7.1-12, Condition NORMAL. | | | |
|---|--|--|--|
|---|--|--|--|

Table 11.4.2.3.3-3: DEREGISTRATION REQUEST (Step 8b2, Table 11.4.2.3.2-1)

| Derivation Path: TS 38.508-1 [4], Table 4.7.1-14. | | | |
|---|--------------|------------------------------|-----------|
| Information Element | Value/remark | Comment | Condition |
| De-registration type | | | |
| bit 3 | '0'B | re-registration not required | |
| Access type | '01'B | 3GPP access | |
| 5GMM cause | '00001011'B | #11 PLMN not allowed | |

11.4.3 5GMM-DEREGISTERED.NO-SUPI / Emergency call / Utilisation of emergency numbers stored on the ME / Initial registration for emergency services

11.4.3.1 Test Purpose (TP)

(1)

```

with { UE in 5GMM-DEREGISTERED.NO-SUPI state (no USIM) }
ensure that {
  when { UE is requested to make an outgoing call using an emergency number stored on the ME }
  then { UE establishes an RRC connection with the RRC establishmentCause set to "emergency", and,
attempts an Initial registration for emergency services by sending a REGISTRATION REQUEST message
with IE Service type set to "emergency services", and, accepts and applies security with NULL
security and integrity algorithms, and, after successful completion of the registration for
emergency services establishes an emergency PDU session by sending an UL NAS TRANSPORT message with
Request type set to "initial emergency request" and a PDU SESSION ESTABLISHMENT REQUEST }
}

```

11.4.3.2 Conformance requirements

References: The conformance requirements covered in the present TC are specified in: TS 38.331 [12], subclause 5.3.3.3, TS 23.501 [37], subclause 5.16.4.1, TS 23.122 [38], subclauses 2, 3.5, TS 24.501 [22], subclauses 4.4.4.1, 5.1.3.2.1.3.6, 5.3.2, 5.4.2.3, 5.5.1.2.2, 6.4.1.2, TS 22.101 [42], subclause 10.1.1. Unless otherwise stated these are Rel-15 requirements.

[TS 36.331, subclause 5.3.3.3]

The UE shall set the contents of *RRCSetupRequest* message as follows:

...

1> set the *establishmentCause* in accordance with the information received from upper layers;

The UE shall submit the *RRCSetupRequest* message to lower layers for transmission.

[TS 23.501, subclause 5.16.4.1]

UEs that are in limited service state, as specified in TS 23.122 [17], or that camp normally on a cell but failed to register successfully to the network under conditions specified in TS 24.501 [47], initiate the Registration procedure by indicating that the registration is to receive Emergency Services, referred to as Emergency Registration, and a Follow-on request is included in the Registration Request to initiate PDU Session Establishment procedure with a Request Type indicating "Emergency Request". UEs that had registered for normal services and do not have emergency PDU Sessions established and that are subject to Mobility Restriction in the present area or RAT (e.g. because of restricted tracking area) shall initiate the UE Requested PDU Session Establishment procedure to receive Emergency Services, i.e. with a Request Type indicating "Emergency Request". Based on local regulation, the network supporting Emergency Services for UEs in limited service state provides Emergency Services to these UE, regardless whether the UE can be authenticated, has roaming or Mobility Restrictions or a valid subscription.

[TS 23.122, clause 2]

If the MS is unable to find a suitable cell to camp on, or the SIM is not inserted, or if it receives certain responses to an LR request (e.g., "illegal MS"), it attempts to camp on a cell irrespective of the PLMN identity, and enters a "limited service" state in which it can only attempt to make emergency calls. An MS operating in NB-S1 mode, never attempts to make emergency calls.

[TS 23.122, subclause 3.5]

There are a number of situations in which the MS is unable to obtain normal service from a PLMN. These include:

...

b) No SIM in the MS;

...

For the items a to f, the MS attempts to camp on an acceptable cell, irrespective of its PLMN identity, so that emergency calls can be made if necessary, with the exception that an MS operating in NB-S1 mode, shall never attempt to make emergency calls. When in the limited service state with a valid SIM, the MS shall search for available and allowable PLMNs in the manner described in subclause 4.4.3.1 and when indicated in the SIM also as described in subclause 4.4.3.4. For an MS that is not in eCall only mode, with the exception of performing GPRS attach or EPS attach for emergency bearer services, or performing registration for emergency services, no LR requests are made until a valid SIM is present and either a suitable cell is found or a manual network reselection is performed. For an MS in eCall only mode, no LR requests are made except for performing EPS attach for emergency bearer services or registration for emergency services. When performing GPRS attach or EPS attach for emergency bearer services, or registration for emergency services, the PLMN of the current serving cell is considered as the selected PLMN for the duration the MS is attached for emergency bearer services or registered for emergency services. In the limited service state the presence of the MS need not be known to the PLMN on whose cell it has camped.

There are also other conditions under which only emergency calls may be made. These are shown in table 2 in clause 5. ProSe direct communication and ProSe direct discovery for public safety use can be initiated if necessary (see 3GPP TS 24.334 [51]) when in the limited service state due to items a) or c) or f). V2X communication over PC5 can be initiated if necessary (see 3GPP TS 24.386 [59]) when in the limited service state due to items a) or c) or f).

[TS 24.501, subclause 4.4.4.1]

The use of "null integrity protection algorithm" 5G-IA0 (see subclause 9.11.3.32) in the current 5G NAS security context is only allowed for an unauthenticated UE for which establishment of emergency services is allowed. For setting the security header type in outbound NAS messages, the UE and the AMF shall apply the same rules irrespective of whether the "null integrity protection algorithm" or any other integrity protection algorithm is indicated in the 5G NAS security context.

If the "null integrity protection algorithm" 5G-IA0 has been selected as an integrity protection algorithm, the receiver shall regard the NAS messages with the security header indicating integrity protection as integrity protected.

[TS 24.501, subclause 5.1.3.2.1.3.6]

The substate 5GMM-DEREGISTERED.NO-SUPI is chosen in the UE, if the N1 mode is enabled and the UE has no valid subscriber data available (SIM/USIM not available, the SIM/USIM is considered invalid by the UE).

[TS 24.501, subclause 5.3.2]

A UE supporting NG-RAN includes a PEI:

- a) when neither SUPI nor valid 5G-GUTI is available to use for emergency services in the REGISTRATION REQUEST message with 5GS registration type IE set to "emergency registration"; and

[TS 24.501, subclause 5.4.2.3]

If the UE is registered for emergency services, performing initial registration for emergency services or establishing an emergency PDU session and the SECURITY MODE COMMAND message is received with ngKSI value "000" and 5G-IA0 and 5G-EA0 as selected 5G NAS security algorithms, the UE shall locally derive and take in use 5G NAS security context. The UE shall delete existing current 5G NAS security context.

The UE shall accept a SECURITY MODE COMMAND message indicating the "null integrity protection algorithm" 5G-EA0 as the selected 5G NAS integrity algorithm only if the message is received when the UE is registered for emergency services, performing initial registration for emergency services or establishing an emergency PDU session.

[TS 24.501, subclause 5.5.1.2.2]

The UE in state 5GMM-DEREGISTERED shall initiate the registration procedure for initial registration by sending a REGISTRATION REQUEST message to the AMF,

...

- b) when the UE performs initial registration for emergency services;

...

If the UE initiates an initial registration for emergency services or needs to prolong the established NAS signalling connection after the completion of the initial registration procedure (e.g. due to uplink signalling pending), the UE shall set the Follow-on request indicator to 1.

[TS 24.501, subclause 6.4.1.2]

In order to initiate the UE-requested PDU session establishment procedure, the UE shall create a PDU SESSION ESTABLISHMENT REQUEST message.

- NOTE 0: When IMS voice is available over either 3GPP access or non-3GPP access, the "voice centric" UE in 5GMM-REGISTERED state will receive a request from upper layers to establish the PDU session for IMS signalling, if the conditions for performing an initial registration with IMS indicated in 3GPP TS 24.229 [14] subclause U.3.1.2 are satisfied.

If the UE requests to establish a new PDU session, the UE shall allocate a PDU session ID which is not currently being used by another PDU session over either 3GPP access or non-3GPP access.

The UE shall allocate a PTI value currently not used and shall set the PTI IE of the PDU SESSION ESTABLISHMENT REQUEST message to the allocated PTI value.

...

If the UE requests to establish a new emergency PDU session, the UE shall set the SSC mode IE of the PDU SESSION ESTABLISHMENT REQUEST message to "SSC mode 1".

...

The UE shall transport:

- a) the PDU SESSION ESTABLISHMENT REQUEST message;
- b) the PDU session ID of the PDU session being established, or being handed over or being transferred;

..

e) the request type which is set to:

...

3) "initial emergency request", if the UE requests to establish a new emergency PDU session; and

...

If the request type is set to "initial emergency request" or "existing emergency PDU session", neither DNN nor S-NSSAI is transported by the UE using the NAS transport procedure as specified in subclause 5.4.5.

[TS 22.101, subclause 10.1.1]

The ME shall identify an emergency number dialled by the end user as a valid emergency number and initiate emergency call establishment if it occurs under one or more of the following conditions. If it occurs outside of the following conditions, the ME should not initiate emergency call establishment but normal call establishment. Emergency number identification takes place before and takes precedence over any other (e.g. supplementary service related) number analysis.

a) 112 and 911 shall always be available. These numbers shall be stored on the ME.

11.4.3.3 Test description

11.4.3.3.1 Pre-test conditions

System Simulator:

- 1 NR Cells
- NR Cell 1, as defined in TS 38.508-1 [4] Table 4.4.2-3. System information combination NR-1 as defined in TS 38.508-1 [4], subclause 4.4.3.1.2. SIB1 indicates ims-EmergencySupport.

UE:

- The UE is NOT equipped with USIM.

Preamble:

- The UE is in test state ON-B (Switched Off) as defined in TS 38.508-1 [4], subclause 4.4A.2.

11.4.3.3.2 Test procedure sequence

Table 11.4.3.3.2-1: Main behaviour

| St | Procedure | Message Sequence | | TP | Verdict |
|-----|---|------------------|--|----|---------|
| | | U - S | Message | | |
| 1 | Switch the UE on. | - | - | - | - |
| 2 | Make the UE attempt an IMS emergency call dialling a number which is stored on the ME (e.g. 112 or 911). (NOTE 1) | - | - | - | - |
| 3 | Check: Does the UE performs Generic Test Procedure for IMS Emergency call establishment without IMS emergency registration as specified in TS 38.508-1 [4], subclause 4.9.12? | - | - | 1 | - |
| 4 | Make the UE release the emergency call. (NOTE 1) | - | - | - | - |
| 5 | The Generic test procedure for IMS MO Emergency call release as specified in TS 38.508-1 [4], subclause 4.9.12A takes place. | - | - | - | - |
| 6 | Start Timer=10 sec.
NOTE: This is an arbitrary value to wait for UE initiated detach. | - | - | - | - |
| - | EXCEPTION: Steps 7a1-7b1 describes optional behaviour that depends on the UE implementation. | - | - | - | - |
| 7a1 | The UE transmits a DEREGISTRATION REQUEST message with De-registration type IE set to "Normal de-registration". | --> | NR RRC: <i>ULInformationTransfer</i>
5GMM: DEREGISTRATION REQUEST | - | - |
| 7a2 | The UE transmits a DEREGISTRATION ACCEPT message. | <-- | NR RRC: <i>DLInformationTransfer</i>
5GMM: DEREGISTRATION REQUEST | - | - |
| 7a3 | Stop Timer=10. | - | - | - | - |
| 7b1 | Timer=10 sec expires | - | - | - | - |

NOTE 1: This could be done by e.g. MMI or AT command.

11.4.3.3.3 Specific message contents

Table 11.4.3.3.3-1: REGISTRATION REQUEST (step 3, Table 11.4.3.3.2-1; step 3, TS 38.508-1 [4], Table 4.9.12.2.2-1)

| Derivation Path: TS 38.508-1 [4], Table 4.7.1-6, condition EMERGENCY. | | | |
|---|--------------|---------|-----------|
| Information Element | Value/remark | Comment | Condition |
| 5GS mobile identity | PEI | | |

Table 11.4.3.3.3-2: DEREGISTRATION REQUEST (Step 7a1, Table 11.4.3.3.2-1)

| Derivation Path: TS 38.508-1 [4], Table 4.7.1-12, Condition NORMAL. |
|---|
|---|

11.4.4 5GMM-REGISTERED.ATTEMPTING-REGISTRATION-UPDATE T3346 running / Emergency call establishment / 5GMM-REGISTERED.NORMAL-SERVICE / Emergency call establishment before T3396 expiry

11.4.4.1 Test Purpose (TP)

(1)

with { UE in 5GMM-REGISTERED.ATTEMPTING-REGISTRATION-UPDATE state, timer T3346 is running and 5GMM-IDLE mode }

```

ensure that {
  when { UE is requested to make an Emergency call }
  then { UE initiates the registration procedure for mobility and periodic registration update,
and, establishes the Emergency call }
}

```

(2)

```

with { UE in 5GMM-REGISTERED.NORMAL-SERVICE state, timer T3396 is running and 5GMM-IDLE mode }
ensure that {
  when { UE is requested to make an Emergency call }
  then { UE establishes the Emergency call }
}

```

11.4.4.2 Conformance requirements

References: The conformance requirements covered in the present TC are specified in: TS 24.501 [22], subclause 5.5.1.3.5, 5.3.9, 5.5.1.3.2, 6.3.3.3, TS 22.101 [42], subclause 10.1.1. Unless otherwise stated these are Rel-15 requirements.

[TS 24.501, subclause 5.5.1.3.5]

If the mobility and periodic registration update request cannot be accepted by the network, the AMF shall send a REGISTRATION REJECT message to the UE including an appropriate 5GMM cause value.

...

The UE shall take the following actions depending on the 5GMM cause value received in the REGISTRATION REJECT message.

...

#22 (Congestion).

If the T3346 value IE is present in the REGISTRATION REJECT message and the value indicates that this timer is neither zero nor deactivated, the UE shall proceed as described below, otherwise it shall be considered as an abnormal case and the behaviour of the UE for this case is specified in subclause 5.5.1.3.7.

The UE shall abort the registration procedure for mobility and periodic registration update. If the rejected request was not for initiating an emergency PDU session, the UE shall set the 5GS update status to 5U2 NOT UPDATED and change to state 5GMM-REGISTERED.ATTEMPTING-REGISTRATION-UPDATE.

The UE shall stop timer T3346 if it is running.

If the REGISTRATION REJECT message is integrity protected, the UE shall start timer T3346 with the value provided in the T3346 value IE.

...

The UE stays in the current serving cell and applies the normal cell reselection process. The registration procedure for mobility and periodic registration update is started, if still necessary, when timer T3346 expires or is stopped.

[TS 24.501, subclause 5.3.9]

If timer T3346 is running or is deactivated, and the UE is a UE configured for high priority access in selected PLMN, or the UE needs to initiate signalling for emergency services or emergency services fallback, then the UE is allowed to initiate 5GMM procedures.

[TS 24.501, subclause 5.5.1.3.2]

The UE in state 5GMM-REGISTERED shall initiate the registration procedure for mobility and periodic registration update by sending a REGISTRATION REQUEST message to the AMF,

...

- k) when the UE in state 5GMM-REGISTERED.ATTEMPTING-REGISTRATION-UPDATE receives a request from the upper layers to establish an emergency PDU session or perform emergency services fallback;

[TS 24.501, subclause 6.3.3.3]

Upon receipt of a PDU SESSION RELEASE COMMAND message and a PDU session ID, using the NAS transport procedure as specified in subclause 5.4.5, the UE considers the PDU session as released and the UE shall create a PDU SESSION RELEASE COMPLETE message.

...

If the PDU SESSION RELEASE COMMAND message includes 5GSM cause #26 "insufficient resources" and the Back-off timer value IE, the UE shall ignore the 5GSM congestion re-attempt indicator IE provided by the network, if any, and the UE shall take different actions depending on the timer value received for timer T3396 in the Back-off timer value:

...

When the timer T3396 is running or the timer is deactivated, the UE is allowed to initiate a PDU session establishment procedure for emergency services.

...

The UE shall set the Follow-on request indicator to 1, if the UE:

- a) initiates the mobility and periodic registration updating procedure upon request of the upper layers to establish an emergency PDU session;

[TS 22.101, subclause 10.1.1]

The ME shall identify an emergency number dialled by the end user as a valid emergency number and initiate emergency call establishment if it occurs under one or more of the following conditions. If it occurs outside of the following conditions, the ME should not initiate emergency call establishment but normal call establishment. Emergency number identification takes place before and takes precedence over any other (e.g. supplementary service related) number analysis.

- a) 112 and 911 shall always be available. These numbers shall be stored on the ME.
- b) Any emergency call number stored on a SIM/USIM when the SIM/USIM is present.
- c) 000, 08, 110, 999, 118 and 119 when a SIM/USIM is not present. These numbers shall be stored on the ME.
- d) Additional emergency call numbers that may have been downloaded by the serving network when the SIM/USIM is present.

11.4.4.3 Test description

11.4.4.3.1 Pre-test conditions

System Simulator:

- 2 NR Cells
- NR Cell 1 and NR Cell 11 as defined in TS 38.508-1 [4] Table 4.4.2-3.
- On all cells when active: System information combination NR-1 as defined in TS 38.508-1 [4], subclause 4.4.3.1.2. SIB1 indicates ims-EmergencySupport.

UE:

None.

Preamble:

- Cells power level configuration in accordance with TS 38.508-1 [4], Table 6.2.2.1-3:
 - NR Cell 1 "Serving cell"
 - NR Cell 11 "Non-Suitable "Off" cell"
- The UE is in test state 1N-A as defined in TS 38.508-1 [4], subclause 4.4A.2 on NR Cell 1
 - During the initial registration:
 - The list of tracking areas provided by the AMF (IE 'TAI list') contains only the TAI of NR Cell 1.

11.4.4.3.2 Test procedure sequence

Table 11.4.4.3.2-1: Main behaviour

| St | Procedure | Message Sequence | | TP | Verdict |
|------|---|------------------|---|----|---------|
| | | U - S | Message | | |
| 1 | The SS configures:
- NR Cell 11 as "Serving cell"
- NR Cell 1 as "Non-Suitable "Off" cell". | - | - | - | - |
| - | The following messages are to be observed on NR Cell 11 unless explicitly stated otherwise. | - | - | - | - |
| 2 | The UE transmits an <i>RRCConnectionRequest</i> message. | --> | NR RRC: <i>RRCSetupRequest</i> | - | - |
| 3 | SS transmit an <i>RRCConnectionSetup</i> message. | <-- | NR RRC: <i>RRCSetup</i> | - | - |
| 4 | The UE transmits an <i>RRCConnectionSetupComplete</i> message to confirm the successful completion of the connection establishment and a REGISTRATION REQUEST message indicating "mobility registration updating" is sent to update the registration of the actual tracking area. | --> | NR RRC: <i>RRCSetupComplete</i>
5GMM: REGISTRATION REQUEST | - | - |
| 5 | SS sends a REGISTRATION REJECT message containing 5GMM cause value = #22 (Congestion). | <-- | NR RRC: <i>DLInformationTransfer</i>
5GMM: REGISTRATION REJECT | - | - |
| 6 | The SS transmits an <i>RRCConnectionRelease</i> message. | <-- | NR RRC: <i>RRCRelease</i> | - | - |
| 7 | Make the UE attempt an IMS emergency call dialling an emergency number e.g. 112 or 911). (NOTE 1) | - | - | - | - |
| 8 | Check: Does the UE perform the Registration procedure for mobility registration update as specified in TS 38.508-1 [4] subclause 4.9.5, 'connected without release'? | - | - | 1 | - |
| 8A | Check: Does the UE transmit an UL NAS TRANSPORT message with 'Request type' set to 'initial emergency request', and, a PDU SESSION ESTABLISHMENT REQUEST for establishing an emergency PDU? | --> | NR RRC: <i>ULInformationTransfer</i>
5GMM: UL NAS TRANSPORT
5GSM: PDU SESSION ESTABLISHMENT REQUEST | 1 | P |
| 9-9D | Steps 9-13 from Generic Test Procedure for IMS Emergency call establishment with IMS Emergency registration as specified in TS 38.508-1 [4], subclause 4.9.11, including the parallel behaviour specified in table 4.9.11.2.2-2 are performed. | - | - | - | - |
| 10 | Make the UE release the emergency call. (NOTE 1) | - | - | - | - |
| 11 | The Generic test procedure for IMS MO Emergency call release as specified in TS 38.508-1 [4], subclause 4.9.12A takes place. | - | - | - | - |
| - | EXCEPTION: Steps 12-13 below are repeated pc_noOf_PDUs times. The SS releases all active PDUs due to insufficient resources. | - | - | - | - |
| 12 | The generic test procedure in TS 38.508-1 clause 4.9.21 for PDU Session Release is performed with a PDU SESSION RELEASE COMMAND including 5GSM cause #26 "insufficient resources", and, Back-off timer value IE, which provides the value of the T3396, set to a value which is neither zero nor a value which indicates that the timer is deactivated. | - | - | - | - |
| 13 | Void | - | - | - | - |
| 14 | The SS releases the RRC connection. | - | NR RRC: <i>RRCRelease</i> | - | - |
| 15 | Make the UE attempt an IMS emergency call | - | - | - | - |

| | | | | | |
|---|--|---|---|---|---|
| | dialling an emergency number e.g. 112 or 911). (NOTE 1) | | | | |
| 16 | Check: Does the UE performs Generic Test Procedure for IMS Emergency call establishment with IMS Emergency registration as specified in TS 38.508-1 [4], subclause 4.9.11? | - | - | 2 | - |
| 17 | Make the UE release the emergency call. (NOTE 1) | - | - | - | - |
| 18 | The Generic test procedure for IMS MO Emergency call release as specified in TS 38.508-1 [4], subclause 4.9.12A takes place. | - | - | - | - |
| NOTE 1: This could be done by e.g. MMI or AT command. | | | | | |

11.4.4.3.3 Specific message contents

Table 11.4.4.3.3-0: REGISTRATION REQUEST (step 4, Table 11.4.4.3.2-1)

Derivation Path: TS 38.508-1 [4], Table 4.7.1-6, Condition MOBILITY.

Table 11.4.4.3.3-1: REGISTRATION REJECT (step 5, Table 11.4.4.3.2-1)

| Derivation Path: TS 38.508-1 [4], Table 4.7.1-9 | | | |
|---|--------------|------------------|-----------|
| Information Element | Value/remark | Comment | Condition |
| 5GMM cause | '00010110'B | #22 (Congestion) | |
| T3346 value | '00100011'B | 3 minutes | |

Table 11.4.4.3.3-2: REGISTRATION REQUEST (step 8, Table 11.4.4.3.2-1; step 3, TS 38.508-1 [4] Table 4.9.5.2.2-1)

Derivation Path: TS 38.508-1 [4], Table 4.7.1-6, Condition EMERGENCY.

Table 11.4.4.3.3-3: UL NAS TRANSPORT (step 8A, Table 11.4.4.3.2-1)

| Derivation Path: Table 4.7.1-10, condition INITIAL_PDU_REQUEST. | | | |
|---|--------------|---------------------------|-----------|
| Information Element | Value/remark | Comment | Condition |
| Request type | '011'B | initial emergency request | |
| S-NSSAI | Not Present | | |
| DNN | Not Present | | |

Table 11.4.4.3.3-4: PDU SESSION ESTABLISHMENT REQUEST (step 8A, Table 11.4.4.3.2-1)

| Derivation Path: Table 4.7.2-1. | | | |
|---------------------------------|---|------------|-----------|
| Information Element | Value/remark | Comment | Condition |
| PDU session ID | A value that is not currently being used by another PDU session | | |
| PTI | A value currently not used | | |
| SSC mode | '001'B | SSC mode 1 | |

Table 11.4.4.3.3-5: PDU SESSION RELEASE COMMAND (step 12, Table 11.4.4.3.2-1; step 1, TS 36.508 [4] Table 4.9.21.2.2-1)

| Derivation Path: TS 38.508-1 [4] Table 4.7.2-14 | | | |
|---|----------------------------------|------------------------|-----------|
| Information Element | Value/remark | Comment | Condition |
| PDU session ID | An ID of an existing PDU session | | |
| 5GSM cause | '0001 1010'B | insufficient resources | |
| Back-off timer value | '1010 0101'B | 5 minutes | |

11.4.5 5GMM-REGISTERED.LIMITED-SERVICE / 5GMM-IDLE / Emergency call establishment and release / Handling of 5GS forbidden tracking areas for roaming

11.4.5.1 Test Purpose (TP)

(1)

```
with { UE in 5GMM-REGISTERED.LIMITED-SERVICE state and 5GMM-IDLE mode }
ensure that {
  when { UE is requested to make an Emergency call }
  then { UE establishes the Emergency call }
}
```

(2)

```
with { UE in 5GMM-REGISTERED.LIMITED-SERVICE state and 5GMM-IDLE mode having established an
Emergency call }
ensure that {
  when { UE is requested to release the Emergency call }
  then { UE releases the Emergency call, and, the UE considers the current cell as belonging to
5GS forbidden tracking areas for roaming }
}
```

11.4.5.2 Conformance requirement

References: The conformance requirements covered in the present TC are specified in: TS 24.501 [22], subclause 5.5.1.3.5, TS 23.122 [38], subclause 3.4.2. Unless otherwise stated these are Rel-15 requirements.

[TS 24.501, subclause 5.5.1.3.5]

#15 (No suitable cells in tracking area).

The UE shall set the 5GS update status to 5U3 ROAMING NOT ALLOWED (and shall store it according to subclause 5.1.3.2.2). The UE shall reset the registration attempt counter and shall enter the state 5GMM-REGISTERED.LIMITED-SERVICE. The UE shall search for a suitable cell in another tracking area according to 3GPP TS 38.304 [28].

The UE shall store the current TAI in the list of "5GS forbidden tracking areas for roaming" and shall remove the current TAI from the stored TAI list, if present.

If the UE is operating in single-registration mode, the UE shall handle the EMM parameters EMM state, EPS update status and tracking area updating attempt counter as specified in 3GPP TS 24.301 [15] for the case when the normal tracking area updating procedure is rejected with the EMM cause with the same value.

[TS 23.122, subclause 3.4.2]

The MS is not allowed to request 5GS services except emergency services when camped on a cell of a TA of which belongs to the list of "5GS forbidden tracking areas for regional provision of service".

11.4.5.3 Test description

11.4.5.3.1 Pre-test conditions

System Simulator:

- 3 NR Cells
 - NR Cell 1, NR Cell 2 and NR Cell 11 as defined in TS 38.508-1 [4], Table 4.4.2-3.
 - Maximum of 2 cells are active at any point of time.
 - On all cells when active: System information combination NR-1 as defined in TS 38.508-1 [4], subclause 4.4.3.1.2. SIB1 indicates ims-EmergencySupport.

UE:

None.

Preamble:

- Cell configuration " in accordance with TS 38.508-1 [4], Table 4.4.2-3:
 - NR Cell 1 "Serving cell"
 - NR Cell 2 "Non-Suitable "Off" cell"
 - NR Cell 11 "Non-Suitable "Off" cell"
- The UE is in test state 1N-A as defined in TS 38.508-1 [4], subclause 4.4A.2 on NR Cell 1
 - During the initial registration:
 - In the list of tracking areas provided by the AMF (IE 'TAI list') contains only the TAI of NR Cell 1.

11.4.5.3.2 Test procedure sequence

Table 11.4.5.3.2-1: Main behaviour

| St | Procedure | Message Sequence | | TP | Verdict |
|----|---|------------------|---|----|---------|
| | | U - S | Message | | |
| 1 | The SS configures:
- NR Cell 11 as "Serving cell"
- NR Cell 1 as "Non-Suitable "Off" cell"
- NR Cell 2 as "Non-Suitable "Off" cell". | - | - | - | - |
| - | EXCEPTION: The following messages are to be observed on NR Cell 11 unless explicitly stated otherwise. | - | - | - | - |
| 2 | The UE transmits an <i>RRCCONNECTIONREQUEST</i> message. | --> | NR RRC: <i>RRCCONNECTIONREQUEST</i> | - | - |
| 3 | SS transmit an <i>RRCCONNECTIONSETUP</i> message. | <-- | NR RRC: <i>RRCCONNECTIONSETUP</i> | - | - |
| 4 | The UE transmits an <i>RRCCONNECTIONSETUPCOMPLETE</i> message to confirm the successful completion of the connection establishment and a REGISTRATION REQUEST message indicating "mobility registration updating" is sent to update the registration of the actual tracking area. | --> | NR RRC: <i>RRCCONNECTIONSETUPCOMPLETE</i>
5GMM: REGISTRATION REQUEST | - | - |
| 5 | SS sends a REGISTRATION REJECT message containing 5GMM cause value = #15 (No suitable cells in tracking area). | <-- | NR RRC: <i>DLINFORMATIONTRANSFER</i>
5GMM: REGISTRATION REJECT | - | - |
| 6 | The SS transmits an <i>RRCCONNECTIONRELEASE</i> message. | <-- | NR RRC: <i>RRCCONNECTIONRELEASE</i> | - | - |
| 7 | Make the UE attempt an IMS emergency call dialling an emergency number e.g. 112 or 911). (NOTE 1) | - | - | - | - |
| 8 | Check: Does the UE performs Generic Test Procedure for IMS Emergency call establishment with IMS Emergency registration as specified in TS 38.508-1 [4], subclause 4.9.11? | - | - | 1 | - |
| 9 | Make the UE release the emergency call. (NOTE 1) | - | - | - | - |
| 10 | The Generic test procedure for IMS MO Emergency call release as specified in TS 38.508-1 [4], subclause 4.9.12A takes place. | - | - | - | - |
| 11 | The SS transmits an <i>RRCCONNECTIONRELEASE</i> message. | <-- | NR RRC: <i>RRCCONNECTIONRELEASE</i> | - | - |
| 12 | Check: Does the UE respond to paging (the Generic Test Procedure for no response to paging as specified in TS 38.508-1 [4], subclause 4.9.13 is performed)? | - | - | 2 | - |
| 13 | The SS configures:
- NR Cell 2 as "Serving cell"
- NR Cell 11 as "Non-Suitable "Off" cell"
- NR Cell 1 as "Non-Suitable "Off" cell". | - | - | - | - |
| 14 | Check: Does the UE perform on NR Cell 2 the Registration procedure for mobility registration update as specified in TS 38.508-1 [4] subclause 4.9.5, 'connected without release'? | - | - | 2 | - |

NOTE 1: This could be done by e.g. MMI or AT command.

11.4.5.3.3 Specific message contents

Table 11.4.5.3.3-1: REGISTRATION REJECT (step 5, Table 11.4.5.3.2-1)

| Derivation path: TS 38.508-1 [4] table 4.7.1-9 | | | |
|--|--------------|---|-----------|
| Information Element | Value/remark | Comment | Condition |
| 5GMM cause | '00001111'B | #15 (No suitable cells in tracking area). | |

11.4.6 5GMM-REGISTERED.NON-ALLOWED-SERVICE / Emergency call establishment and release / Handling of non-allowed tracking areas

11.4.6.1 Test Purpose (TP)

(1)

```
with { UE in 5GMM-REGISTERED.NON-ALLOWED-SERVICE state and 5GMM-IDLE mode }
ensure that {
  when { UE is requested to make an Emergency call }
  then { UE establishes the Emergency call }
}
```

(2)

```
with { UE in 5GMM-REGISTERED.NON-ALLOWED-SERVICE state and 5GMM-CONNECTED mode having established an
Emergency call }
ensure that {
  when { UE is requested to release the Emergency call }
  then { UE releases the Emergency call, and, the UE considers the current cell as belonging to
non-allowed tracking areas }
}
```

11.4.6.2 Conformance requirements

References: The conformance requirements covered in the present TC are specified in: TS 24.501 [22], subclause 5.3.5, TS 22.101 [42], subclause 10.1.1. Unless otherwise stated these are Rel-15 requirements.

[TS 24.501, subclause 5.3.5]

When the UE receives a Service area list IE with a non-allowed area indication during a registration procedure or a generic UE configuration update procedure, the UE shall delete the old list of "non-allowed tracking areas" and store the tracking areas in the non-allowed area as the list of "non-allowed tracking areas". If the UE has a stored list of "allowed tracking areas", the UE shall delete that list.

...

If the UE is successfully registered to a PLMN and has a stored list of "non-allowed tracking areas":

...

b) while camped on a cell whose TAI is in the list of "non-allowed tracking areas", the UE shall enter the state 5GMM-REGISTERED.NON-ALLOWED-SERVICE, and:

1) if the UE is in 5GMM-IDLE mode over 3GPP access, the UE:

...

ii) shall not initiate a service request procedure except for emergency services, high priority access, responding to paging or notification or indicating a change of 3GPP PS data off UE status; and

[TS 22.101, subclause 10.1.1]

The ME shall identify an emergency number dialled by the end user as a valid emergency number and initiate emergency call establishment if it occurs under one or more of the following conditions. If it occurs outside of the following conditions, the ME should not initiate emergency call establishment but normal call establishment. Emergency number identification takes place before and takes precedence over any other (e.g. supplementary service related) number analysis.

- a) 112 and 911 shall always be available. These numbers shall be stored on the ME.
- b) Any emergency call number stored on a SIM/USIM when the SIM/USIM is present.
- c) 000, 08, 110, 999, 118 and 119 when a SIM/USIM is not present. These numbers shall be stored on the ME.
- d) Additional emergency call numbers that may have been downloaded by the serving network when the SIM/USIM is present.

11.4.6.3 Test description

11.4.6.3.1 Pre-test conditions

System Simulator:

- 3 NR Cells
 - NR Cell 1, NR Cell 2 and NR Cell 11 as defined in TS 38.508-1 [4] Table 4.4.2-3.
 - Maximum of 2 cells are active at any point of time.
 - On all cells when active: System information combination NR-1 as defined in TS 38.508-1 [4], subclause 4.4.3.1.2. SIB1 indicates ims-EmergencySupport.

UE:

None.

Preamble:

- Cells power level configuration in accordance with TS 38.508-1 [4], Table 6.2.2.1-3:
 - NR Cell 1 "Serving cell"
 - NR Cell 2 "Non-Suitable "Off" cell"
 - NR Cell 11 "Non-Suitable "Off" cell"
- The UE is in test state 1N-A as defined in TS 38.508-1 [4], subclause 4.4A.2 on NR Cell 1
 - During the initial registration:
 - The list of tracking areas provided by the AMF (IE 'TAI list') contains only the TAI of NR Cell 1 whereas the TAI of NR Cell 11 is indicated in the Service area list IE with non-allowed areas as specified in Table 11.4.6.3.3-2.

11.4.6.3.2 Test procedure sequence

Table 11.4.6.3.2-1: Main behaviour

| St | Procedure | Message Sequence | | TP | Verdict |
|---|--|------------------|--------------------------------|----|---------|
| | | U - S | Message | | |
| 1 | The SS configures:
- NR Cell 11 as "Serving cell"
- NR Cell 1 as "Non-Suitable "Off" cell"
- NR Cell 2 as "Non-Suitable "Off" cell". | - | - | - | - |
| - | The following messages are to be observed on NR Cell 11 unless explicitly stated otherwise. | - | - | - | - |
| 2 | Check: Does in the next 5 sec the UE transmit an <i>RRCSetupRequest</i> message? | --> | NR RRC: <i>RRCSetupRequest</i> | 1 | F |
| 3 | Make the UE attempt an IMS emergency call dialling an emergency number e.g. 112 or 911. (NOTE 1) | - | - | - | - |
| 4 | Check: Does the UE performs Generic Test Procedure for IMS Emergency call establishment with IMS Emergency registration as specified in TS 38.508-1 [4], subclause 4.9.11? | - | - | 1 | - |
| 5 | Make the UE release the emergency call. (NOTE 1) | - | - | - | - |
| 6 | The Generic test procedure for IMS MO Emergency call release as specified in TS 38.508-1 [4], subclause 4.9.12A takes place. | - | - | - | - |
| 6 | SS releases the RRC connection | <-- | NR RRC: <i>RRCRelease</i> | - | - |
| 7 | Make the UE attempt an IMS none-emergency call. (NOTE 1) | | | | |
| 8 | Check: Does the UE transmit in the next 10 sec an <i>RRCSetupRequest</i> message? | --> | NR RRC: <i>RRCSetupRequest</i> | 2 | F |
| 9 | The SS configures:
- NR Cell 2 as "Serving cell"
- NR Cell 11 as "Non-Suitable "Off" cell"
- NR Cell 1 as "Non-Suitable "Off" cell". | - | - | - | - |
| 10 | Check: Does the UE perform on NR Cell 2 the Registration procedure for mobility registration update as specified in TS 38.508-1 [4] subclause 4.9.5, ' <i>connected without release</i> '? | - | - | 2 | - |
| NOTE 1: This could be done by e.g. MMI or AT command. | | | | | |

11.4.6.3.3 Specific message contents

Table 11.4.6.3.3-2: REGISTRATION ACCEPT (Preamble)

| Derivation Path: TS 38.508-1 [4], Table 4.7.1-7. | | | |
|--|--|---|-----------|
| Information Element | Value/remark | Comment | Condition |
| Service area list | | | |
| Allowed type (octet 1) | '1'B | TAs in the list are in the non-allowed area | |
| Type of list (octet 1) | '00'B | list of TACs belonging to one PLMN, with non-consecutive TAC values | |
| Number of elements (octet 1) | '00000'B | 1 element | |
| MCC | As defined for NR Cell 11 in TS 38.508-1 [4], Table 4.4.2-3. | | |
| MNC | As defined for NR Cell 11 in TS 38.508-1 [4], Table 4.4.2-3. | | |
| TAC 1 | As defined for NR Cell 11 in TS 38.508-1 [4], Table 4.4.2-3. | | |

11.4.7 Handling of Local and Extended emergency numbers / Mobility

11.4.7.1 Test Purpose (TP)

(1)

```
with { UE in 5GMM-REGISTERED.NORMAL-SERVICE state and 5GMM-IDLE mode, UE receives a Local emergency numbers list in the REGISTRATION ACCEPT message, provided in the Emergency number list IE }
ensure that {
  when { UE is requested to make an outgoing call using any of the emergency numbers received in the Local emergency numbers list }
  then { UE establishes an IMS Emergency call }
}
```

(2)

```
with { UE in 5GMM-REGISTERED.NORMAL-SERVICE state and 5GMM-IDLE mode, UE receives an Extended local emergency numbers list in the REGISTRATION ACCEPT message, provided in the Extended emergency number list IE }
ensure that {
  when { UE is requested to make an outgoing call using any of the emergency numbers received in the Extended local emergency numbers list }
  then { UE establishes an IMS Emergency call }
}
```

(3)

```
with { UE in 5GMM-REGISTERED.NORMAL-SERVICE state and 5GMM-IDLE mode, having stored a Local emergency numbers list and an Extended local emergency numbers list }
ensure that {
  when { UE receives a new Local emergency numbers list in the REGISTRATION ACCEPT message, provided in the Emergency number list IE }
  then { UE replaces the previously stored Local emergency numbers list }
}
```

(4)

```
with { UE in 5GMM-REGISTERED.NORMAL-SERVICE state and 5GMM-IDLE mode, having stored a Local emergency numbers list and an Extended local emergency numbers list }
ensure that {
```

```

when { UE receives a new Extended local emergency numbers list, in the REGISTRATION ACCEPT
message, provided in the Extended emergency number list IE }
  then { UE replaces the previously stored Extended local emergency numbers list }
}

```

(5)

```

with { UE in 5GMM-REGISTERED.NORMAL-SERVICE state and 5GMM-IDLE mode, having stored a Local
emergency numbers list }
ensure that {
  when { UE moves within the same PLMN from which the currently stored Local emergency numbers list
provided in an Emergency number list IE were received, and, no Emergency number list IE is contained
in the REGISTRATION ACCEPT message received during a Mobility and periodic update procedure }
    then { UE keeps the stored Local emergency numbers list in the user equipment }
}

```

(6)

```

with { UE in 5GMM-REGISTERED.NORMAL-SERVICE state and 5GMM-IDLE mode, having stored an Extended
local emergency numbers list }
ensure that {
  when { UE moves within the same PLMN from which the currently stored Extended local Emergency
Numbers List provided in an Extended emergency number list IE were received, and, no Extended
emergency number list IE is contained in the REGISTRATION ACCEPT message received during a Mobility
and periodic update procedure }
    then { UE keeps the stored Extended local Emergency Numbers List in the user equipment }
}

```

(7)

```

with { UE in 5GMM-REGISTERED.NORMAL-SERVICE state and 5GMM-IDLE mode, having stored a Local
emergency numbers list}
ensure that {
  when { UE moves to a new PLMN in the same country as the PLMN from which the currently stored
Local emergency numbers list provided in an Emergency number list IE were received, and, no
Emergency number list IE is contained in the REGISTRATION ACCEPT message received in the new PLMN }
    then { UE keeps the stored Local emergency numbers list in the user equipment }
}

```

(8)

```

with { UE in 5GMM-REGISTERED.NORMAL-SERVICE state and 5GMM-IDLE mode, having stored an Extended
local emergency numbers list }
ensure that {
  when { UE moves to a new PLMN in the same country as the PLMN from which the currently stored
Extended Emergency Numbers List provided in an Extended emergency number list IE were received, and
the Extended Emergency Number List Validity (EENLV) field within the Extended emergency number list
IE indicated "Extended local Emergency Numbers List is valid in the country of the PLMN from which
this IE is received", and, no Extended emergency number list IE is contained in the REGISTRATION
ACCEPT message received in the new PLMN }
    then { UE keeps the stored Extended local Emergency Numbers List in the user equipment }
}

```

(9)

```

with { UE in 5GMM-REGISTERED.NORMAL-SERVICE state and 5GMM-IDLE mode, having stored a Local
emergency numbers list and an Extended local emergency numbers list }
ensure that {
  when { UE moves to a new PLMN in the same country as the PLMN from which the currently stored
Extended Emergency Numbers List provided in an Extended emergency number list IE were received, and
the Extended Emergency Number List Validity (EENLV) field within the Extended emergency number list
IE indicated "Extended local Emergency Numbers List is valid only in the PLMN from which this IE is
received", and, no Extended emergency number list IE is contained in the REGISTRATION ACCEPT message
received in the new PLMN }
    then { UE deletes the stored Extended local Emergency Numbers List, and, keeps the stored Local
emergency numbers list in the user equipment }
}

```

(10)

```

with { UE in 5GMM-REGISTERED.NORMAL-SERVICE state and 5GMM-IDLE mode, having stored a Local
emergency numbers list }
ensure that {

```

```

when { UE moves to a new PLMN in a different country as the PLMN from which the currently stored
Local emergency numbers list provided in an Emergency number list IE was received, and, no Emergency
number list IE is contained in the REGISTRATION ACCEPT message received in the new PLMN }
then { UE deletes the stored Local emergency numbers list in the user equipment }
}

```

(11)

```

with { UE in 5GMM-REGISTERED.NORMAL-SERVICE state and 5GMM-IDLE mode, having stored an Extended
local emergency numbers list }
ensure that {
when { UE moves to a new PLMN in a different country as the PLMN from which the currently stored
Extended Emergency Numbers List provided in an Extended emergency number list IE were, and, no
Extended emergency number list IE is contained in the REGISTRATION ACCEPT message received in the
new PLMN }
then { UE deletes the stored Extended emergency numbers list in the user equipment }
}

```

11.4.7.2 Conformance requirements

References: The conformance requirements covered in the present TC are specified in: TS 38.331 [12], subclause 5.3.3.3, TS 24.501 [22], subclause 5.3.12, TS 24.301 [21], subclause 5.3.7, TS 22.101 [42], subclause 10.1.1. Unless otherwise stated these are Rel-15 requirements.

[TS 38.331, subclause 5.3.3.3]

The UE shall set the contents of *RRCSetupRequest* message as follows:

...

1> set the *establishmentCause* in accordance with the information received from upper layers;

The UE shall submit the *RRCSetupRequest* message to lower layers for transmission.

[TS 24.501, subclause 5.3.12]

The network may send a Local emergency numbers list or an Extended local emergency numbers list or both, in the REGISTRATION ACCEPT message, by including the Emergency number list IE and the Extended emergency number list IE, respectively. The Local emergency numbers list can be updated as described in 3GPP TS 24.301 [15], subclause 5.3.7.

The user equipment shall store the Local emergency numbers list and the Extended local emergency numbers list, as provided by the network. The Local emergency numbers list stored in the user equipment shall be replaced on each receipt of the Emergency number list IE. The Extended local emergency numbers list stored in the user equipment shall be replaced on each receipt of the Extended emergency number list IE. The received Local emergency numbers list or the received Extended local emergency numbers list or both shall be provided to the upper layers.

...

The emergency number(s) received in the Emergency number list IE are valid only in networks in the same country as the PLMN from which this IE is received. If no Emergency number list IE is contained in the REGISTRATION ACCEPT message, then the stored Local emergency numbers list in the user equipment shall be kept, except if the user equipment has successfully registered to a PLMN in a country different from that of the PLMN that sent the list.

The emergency number(s) received in the Extended emergency number list IE are valid only in:

- networks in the same country as the PLMN from which this IE is received, if the Extended Emergency Number List Validity (EENLV) field within the Extended emergency number list IE indicates "Extended local Emergency Numbers List is valid in the country of the PLMN from which this IE is received"; and
- the PLMN from which this IE is received, if the EENLV field within the Extended emergency number list IE indicates "Extended local Emergency Numbers List is valid only in the PLMN from which this IE is received".

If no Extended local Emergency Numbers List is contained in the REGISTRATION ACCEPT message, and the registered PLMN has not changed, then the stored Extended local Emergency Numbers List in the user equipment shall be kept. If no Extended local Emergency Numbers List is contained in the REGISTRATION ACCEPT message, but the registered PLMN has changed, then:

- if the last received indication in the EENLV field within the Extended emergency number list IE indicates "Extended local Emergency Numbers List is valid only in the PLMN from which this IE is received", the stored Extended local Emergency Numbers List in the user equipment shall be deleted; and
- if the last received indication in the EENLV field within the Extended emergency number list IE indicates "Extended local Emergency Numbers List is valid in the country of the PLMN from which this IE is received" the list shall be kept except if the user equipment has successfully registered to a PLMN in a country different from that of the PLMN that sent the stored list.

NOTE: To prevent the misrouting of emergency calls, all operators within a country need to follow the regulation or agree on the setting of the Extended emergency number list IE in accordance to national agreement – either to indicate validity within a country or to indicate validity only within the PLMN.

The Local emergency numbers list and the Extended local emergency numbers list shall be deleted at switch off or removal of the USIM. The user equipment shall be able to store up to ten entries in the Local emergency numbers list and up to twenty entries in the Extended local emergency numbers list, received from the network.

For the use of the Local emergency numbers list and the Extended local emergency numbers list by the UE see 3GPP TS 24.301 [15], subclause 5.3.7.

[TS 24.301, subclause 5.3.7]

The Local Emergency Numbers List and the Extended local Emergency Numbers list contain additional Local emergency numbers used by the serving network. These lists can be downloaded by the network to the UE at successful registration and subsequent registration updates. There is only one Local Emergency Numbers List and only one Extended local Emergency Numbers list in the UE. The Local Emergency Numbers List can be updated with EMM procedures if the UE is in S1 mode, with GMM and MM procedures if the UE is in A/Gb or Iu mode, and with 5GMM procedures, as specified in 3GPP TS 24.501 [54], if UE is in N1 mode. The Extended local Emergency Numbers List can be updated with EMM procedures if the UE is in S1 mode and with 5GMM procedures, as specified in 3GPP TS 24.501 [54], if UE is in N1 mode.

The UE shall use the stored Local Emergency Numbers List and the stored Extended local Emergency Numbers List received from the network in addition to the emergency numbers stored on the USIM or user equipment to detect that the number dialled is an emergency number.

If the UE determines that the number dialled is an emergency number, the procedures specified in 3GPP TS 23.167 [45] and 3GPP TS 24.229 [13D] are utilised to select a domain for the emergency session attempt.

If the domain selected for the emergency session attempt is the PS domain, then the UE shall perform the session establishment procedures specified in 3GPP TS 24.229 [13D] to initiate an emergency session.

[TS 22.101, subclause 10.1.1]

The ME shall identify an emergency number dialled by the end user as a valid emergency number and initiate emergency call establishment if it occurs under one or more of the following conditions. If it occurs outside of the following conditions, the ME should not initiate emergency call establishment but normal call establishment. Emergency number identification takes place before and takes precedence over any other (e.g. supplementary service related) number analysis.

- a) 112 and 911 shall always be available. These numbers shall be stored on the ME.
- b) Any emergency call number stored on a SIM/USIM when the SIM/USIM is present.
- c) 000, 08, 110, 999, 118 and 119 when a SIM/USIM is not present. These numbers shall be stored on the ME.
- d) Additional emergency call numbers that may have been downloaded by the serving network when the SIM/USIM is present.

11.4.7.3 Test description

11.4.7.3.1 Pre-test conditions

System Simulator:

- 4 NR Cells
- NR Cell 1, NR Cell 3, NR Cell 11, NR Cell 12 as defined in TS 38.508-1 [4], Table 4.4.2-3, with the exception that cells' PLMNs are defined in Table 11.4.7.3.1-1 below.

Table 11.4.7.3.1-1: PLMN identifiers

| NR Cell | PLMN name |
|--|-----------|
| 1 | PLMN1 |
| 3 | PLMN15 |
| 11 | PLMN1 |
| 12 | PLMN2 |
| NOTE 1: PLMN1 is stored in EF _{IMSI} on the test USIM card. | |
| NOTE 2: PLMN1 and PLMN15 are in the same country; PLMN2 is in a different country. | |

- System information combination NR-1 as defined in TS 38.508-1 [4], subclause 4.4.3.1.2. SIB1 indicates *ims-EmergencySupport*.

NOTE: No more than 2 cells are active simultaneously at any time throughout the test.

UE:

- The UE is equipped with a test USIM with USIM Configuration 20 as defined in TS 38.508-1 [4] Table 6.4.1-20 (USIM contains two Emergency Numbers: 144, 117).

Preamble:

- Cells signal level in accordance with TS 38.508-1 [4], Table 6.2.2.1-3:
 - NR Cell 12 "Serving cell"
 - NR Cell 1 "Non-Suitable "Off" cell"
 - NR Cell 11 "Non-Suitable "Off" cell"
 - NR Cell 3 "Non-Suitable "Off" cell"
- The UE is in test state 1N-A as defined in TS 38.508-1 [4], subclause 4.4A.2 on NR Cell 12.
- During the initial registration:
 - Local emergency number(s) and Extended local emergency number(s) are provided by the Network as specified in Table 11.4.7.3.3-1.

11.4.7.3.2 Test procedure sequence

Table 11.4.7.3.2-1: Main behaviour

| St | Procedure | Message Sequence | | TP | Verdict |
|----|---|------------------|---------------------------|----|---------|
| | | U - S | Message | | |
| - | The following messages are to be observed on NR Cell 12 unless explicitly stated otherwise. | - | - | - | - |
| 1 | Make the UE attempt an IMS call dialling number 120. (NOTE 1)
The number is expected to be stored in the Local emergency number list being received in the REGISTRATION ACCEPT message in the Preamble. | - | - | - | - |
| 2 | Check: Does the UE performs Generic Test Procedure for IMS Emergency call establishment with IMS emergency registration as specified in TS 38.508-1 [4], subclause 4.9.11? | - | - | 1 | - |
| 3 | Make the UE release the emergency call. (NOTE 1) | - | - | - | - |
| 4 | The Generic test procedure for IMS MO Emergency call release as specified in TS 38.508-1 [4], subclause 4.9.12A takes place. | - | - | - | - |
| 5 | SS releases the RRC connection | <-- | NR RRC: <i>RRCRelease</i> | - | - |
| 6 | Make the UE attempt an IMS call dialling number 10. (NOTE 1)
The number is expected to be stored in the Extended local emergency number list being received in the REGISTRATION ACCEPT message in the Preamble. | - | - | - | - |
| 7 | Check: Does the UE performs Generic Test Procedure for IMS Emergency call establishment with IMS emergency registration as specified in TS 38.508-1 [4], subclause 4.9.11? | - | - | 2 | - |
| 8 | Make the UE release the emergency call. (NOTE 1) | - | - | - | - |
| 9 | The Generic test procedure for IMS MO Emergency call release as specified in TS 38.508-1 [4], subclause 4.9.12A takes place. | - | - | - | - |
| 10 | SS releases the RRC connection | <-- | NR RRC: <i>RRCRelease</i> | - | - |
| - | The SS configures:
- NR Cell 1 as "Serving cell"
- NR Cell 12 as "Non-Suitable "Off" cell"
- NR Cell 11 as "Non-Suitable "Off" cell"
- NR Cell 3 as "Non-Suitable "Off" cell" | - | - | - | - |
| - | The following messages are to be observed on NR Cell 1 unless explicitly stated otherwise. | - | - | - | - |
| 11 | The UE performs the Registration procedure for mobility registration update as specified in TS 38.508-1 [4] subclause 4.9.5.
During the procedure the Network provides new Local emergency number list and Extended local emergency number list (EENLV=Extended Local Emergency Numbers List is valid in the country of the PLMN from which this IE is received) in the REGISTRATION ACCEPT message. | - | - | - | - |
| 12 | Make the UE attempt an IMS call dialling number 1001. (NOTE 1)
The number is expected to be stored in the Local emergency number list being received in the REGISTRATION ACCEPT message in step 11. | - | - | - | - |
| 13 | Check: Does the UE performs Generic Test Procedure for IMS Emergency call | - | - | 3 | - |

| | | | | | |
|----|--|-----|---------------------------|---|---|
| | establishment with IMS emergency registration as specified in TS 38.508-1 [4], subclause 4.9.11? | | | | |
| 14 | Make the UE release the emergency call. (NOTE 1) | - | - | - | - |
| 15 | The Generic test procedure for IMS MO Emergency call release as specified in TS 38.508-1 [4], subclause 4.9.12A takes place. | - | - | - | - |
| 16 | SS releases the RRC connection | <-- | NR RRC: <i>RRCRelease</i> | - | - |
| 17 | Make the UE attempt an IMS call dialling number 120. (NOTE 1)
The number was initially stored in the Local emergency number list being received in the REGISTRATION ACCEPT message in the Preamble but is expected to have been removed from the list when a new list was received in the REGISTRATION ACCEPT message in step 11. | - | - | - | - |
| 18 | Check: Does the UE performs Generic Test Procedure for IMS MO speech call establishment as specified in TS 38.508-1 [4], subclause 4.9.15? | - | - | 3 | - |
| 19 | Make the UE release the call. (NOTE 1) | - | - | - | - |
| 20 | The Generic test procedure for IMS MO call release as specified in TS 38.508-1 [4], subclause 4.9.17 takes place. | - | - | - | - |
| 21 | SS releases the RRC connection | <-- | NR RRC: <i>RRCRelease</i> | - | - |
| 22 | Make the UE attempt an IMS call dialling number 12345. (NOTE 1)
The number is expected to be stored in the Extended local emergency number list being received in the REGISTRATION ACCEPT message in step 11. | - | - | - | - |
| 23 | Check: Does the UE performs Generic Test Procedure for IMS Emergency call establishment with IMS emergency registration as specified in TS 38.508-1 [4], subclause 4.9.11? | - | - | 4 | - |
| 24 | Make the UE release the emergency call. (NOTE 1) | - | - | - | - |
| 25 | The Generic test procedure for IMS MO Emergency call release as specified in TS 38.508-1 [4], subclause 4.9.12A takes place. | - | - | - | - |
| 26 | SS releases the RRC connection | <-- | NR RRC: <i>RRCRelease</i> | - | - |
| 27 | Make the UE attempt an IMS call dialling number 10. (NOTE 1)
The number was initially stored in the Extended local emergency number list being received in the REGISTRATION ACCEPT message in the Preamble but is expected to have been removed from the list when a new list was received in the REGISTRATION ACCEPT message in step 11. | - | - | - | - |
| 28 | Check: Does the UE performs Generic Test Procedure for IMS MO speech call establishment as specified in TS 38.508-1 [4], subclause 4.9.15? | - | - | 4 | - |
| 29 | Make the UE release the call. (NOTE 1) | - | - | - | - |
| 30 | The Generic test procedure for IMS MO call release as specified in TS 38.508-1 [4], subclause 4.9.17 takes place. | - | - | - | - |
| 31 | SS releases the RRC connection | <-- | NR RRC: <i>RRCRelease</i> | - | - |
| - | The SS configures:
- NR Cell 11 as "Serving cell"
- NR Cell 1 as "Non-Suitable "Off" cell"
- NR Cell 12 as "Non-Suitable "Off" cell"
- NR Cell 3 as "Non-Suitable "Off" cell" | - | - | - | - |

| | | | | | |
|----|--|-----|---------------------------|---|---|
| - | The following messages are to be observed on NR Cell 11 unless explicitly stated otherwise. | - | - | - | - |
| 32 | The UE performs the Registration procedure for mobility registration update as specified in TS 38.508-1 [4] subclause 4.9.5. During the procedure the Network does not send new Local emergency number list and Extended local emergency number list in the REGISTRATION ACCEPT message. | - | - | - | - |
| 33 | Make the UE attempt an IMS call dialling number 1001. (NOTE 1)
The number is expected to be stored in the Local emergency number list being received in the REGISTRATION ACCEPT message in step 11. | - | - | - | - |
| 34 | Check: Does the UE performs Generic Test Procedure for IMS Emergency call establishment with IMS emergency registration as specified in TS 38.508-1 [4], subclause 4.9.11? | - | - | 5 | - |
| 35 | Make the UE release the emergency call. (NOTE 1) | - | - | - | - |
| 36 | The Generic test procedure for IMS MO Emergency call release as specified in TS 38.508-1 [4], subclause 4.9.12A takes place. | - | - | - | - |
| 37 | SS releases the RRC connection | <-- | NR RRC: <i>RRCRelease</i> | - | - |
| 38 | Make the UE attempt an IMS call dialling number 12345. (NOTE 1)
The number is expected to be stored in the Extended local emergency number list being received in the REGISTRATION ACCEPT message in step 11. | - | - | - | - |
| 39 | Check: Does the UE performs Generic Test Procedure for IMS Emergency call establishment with IMS emergency registration as specified in TS 38.508-1 [4], subclause 4.9.11? | - | - | 6 | - |
| 40 | Make the UE release the emergency call. (NOTE 1) | - | - | - | - |
| 41 | The Generic test procedure for IMS MO Emergency call release as specified in TS 38.508-1 [4], subclause 4.9.12A takes place. | - | - | - | - |
| 42 | SS releases the RRC connection | <-- | NR RRC: <i>RRCRelease</i> | - | - |
| - | The SS configures:
- NR Cell 3 as "Serving cell"
- NR Cell 1 as "Non-Suitable "Off" cell"
- NR Cell 11 as "Non-Suitable "Off" cell"
- NR Cell 12 as "Non-Suitable "Off" cell" | - | - | - | - |
| - | The following messages are to be observed on NR Cell 3 unless explicitly stated otherwise. | - | - | - | - |
| 43 | The UE performs the Registration procedure for mobility registration update as specified in TS 38.508-1 [4] subclause 4.9.5. During the procedure the Network does not send new Local emergency number list and Extended local emergency number list in the REGISTRATION ACCEPT message. | - | - | - | - |
| 44 | Make the UE attempt an IMS call dialling number 1001. (NOTE 1)
The number is expected to be stored in the Local emergency number list being received in the REGISTRATION ACCEPT message in step 11. | - | - | - | - |
| 45 | Check: Does the UE performs Generic Test Procedure for IMS Emergency call establishment with IMS emergency registration as specified in TS 38.508-1 [4], subclause 4.9.11? | - | - | 7 | - |

| | | | | | |
|----|---|-----|---------------------------|----|---|
| 46 | Make the UE release the emergency call. (NOTE 1) | - | - | - | - |
| 47 | The Generic test procedure for IMS MO Emergency call release as specified in TS 38.508-1 [4], subclause 4.9.12A takes place. | - | - | - | - |
| 48 | SS releases the RRC connection | <-- | NR RRC: <i>RRCRelease</i> | - | - |
| 49 | Make the UE attempt an IMS call dialling number 12345. (NOTE 1)
The number is expected to be stored in the Extended local emergency number list being received in the REGISTRATION ACCEPT message in step 11. | - | - | - | - |
| 50 | Check: Does the UE performs Generic Test Procedure for IMS Emergency call establishment with IMS emergency registration as specified in TS 38.508-1 [4], subclause 4.9.11? | - | - | 8 | - |
| 51 | Make the UE release the emergency call. (NOTE 1) | - | - | - | - |
| 52 | The Generic test procedure for IMS MO Emergency call release as specified in TS 38.508-1 [4], subclause 4.9.12A takes place. | - | - | - | - |
| 53 | SS releases the RRC connection | <-- | NR RRC: <i>RRCRelease</i> | - | - |
| - | The SS configures:
- NR Cell 12 as "Serving cell"
- NR Cell 1 as "Non-Suitable "Off" cell"
- NR Cell 11 as "Non-Suitable "Off" cell"
- NR Cell 3 as "Non-Suitable "Off" cell" | - | - | - | - |
| - | The following messages are to be observed on NR Cell 12 unless explicitly stated otherwise. | - | - | - | - |
| 54 | The UE performs the Registration procedure for mobility registration update as specified in TS 38.508-1 [4] subclause 4.9.5.
During the procedure the Network does not send new Local emergency number list and Extended local emergency number list in the REGISTRATION ACCEPT message. | - | - | - | - |
| 55 | Make the UE attempt an IMS call dialling number 1001. (NOTE 1)
The number was initially stored in the Local emergency number list being received in the REGISTRATION ACCEPT message in step 11 but is expected to have been removed from the list when no new list was received in the REGISTRATION ACCEPT message in step 54. | - | - | - | - |
| 56 | Check: Does the UE performs Generic Test Procedure for IMS MO speech call establishment as specified in TS 38.508-1 [4], subclause 4.9.15? | - | - | 10 | - |
| 57 | Make the UE release the call. (NOTE 1) | - | - | - | - |
| 58 | The Generic test procedure for IMS MO call release as specified in TS 38.508-1 [4], subclause 4.9.17 takes place. | - | - | - | - |
| 59 | SS releases the RRC connection | <-- | NR RRC: <i>RRCRelease</i> | - | - |
| 60 | Make the UE attempt an IMS call dialling number 12345. (NOTE 1)
The number was initially stored in the Extended local emergency number list being received in the REGISTRATION ACCEPT message in step 11 but is expected to have been removed from the list when no new list was received in the REGISTRATION ACCEPT message in step 54. | - | - | - | - |
| 61 | Check: Does the UE performs Generic Test Procedure for IMS MO speech call establishment as specified in TS 38.508-1 [4], subclause 4.9.15? | - | - | 11 | - |

| | | | | | |
|----|--|-----|---------------------------|---|---|
| 62 | Make the UE release the call. (NOTE 1) | - | - | - | - |
| 63 | The Generic test procedure for IMS MO call release as specified in TS 38.508-1 [4], subclause 4.9.17 takes place. | - | - | - | - |
| 64 | SS releases the RRC connection | <-- | NR RRC: <i>RRCRelease</i> | - | - |
| - | The SS configures:
- NR Cell 1 as "Serving cell"
- NR Cell 12 as "Non-Suitable "Off" cell"
- NR Cell 11 as "Non-Suitable "Off" cell"
- NR Cell 3 as "Non-Suitable "Off" cell" | - | - | - | - |
| - | The following messages are to be observed on NR Cell 1 unless explicitly stated otherwise. | - | - | - | - |
| 65 | The UE performs the Registration procedure for mobility registration update as specified in TS 38.508-1 [4] subclause 4.9.5.
During the procedure the Network provides new Local emergency number list and Extended local emergency number list (EENLV=Extended Local Emergency Numbers List is valid in the PLMN from which this IE is received) in the REGISTRATION ACCEPT message. | - | - | - | - |
| - | The SS configures:
- NR Cell 3 as "Serving cell"
- NR Cell 1 as "Non-Suitable "Off" cell"
- NR Cell 11 as "Non-Suitable "Off" cell"
- NR Cell 12 as "Non-Suitable "Off" cell" | - | - | - | - |
| - | The following messages are to be observed on NR Cell 3 unless explicitly stated otherwise. | - | - | - | - |
| 66 | The UE performs the Registration procedure for mobility registration update as specified in TS 38.508-1 [4] subclause 4.9.5.
During the procedure the Network does not send new Local emergency number list and Extended local emergency number list in the REGISTRATION ACCEPT message. | - | - | - | - |
| 67 | Make the UE attempt an IMS call dialling number 12345. (NOTE 1)
The number was initially stored in the Extended local emergency number list being received in the REGISTRATION ACCEPT message in step 65 but is expected to have been removed from the list when no new list was received in the REGISTRATION ACCEPT message in step 66. | - | - | - | - |
| 68 | Check: Does the UE performs Generic Test Procedure for IMS MO speech call establishment as specified in TS 38.508-1 [4], subclause 4.9.15? | - | - | 9 | - |
| 69 | Make the UE release the call. (NOTE 1) | - | - | - | - |
| 70 | The Generic test procedure for IMS MO call release as specified in TS 38.508-1 [4], subclause 4.9.17 takes place. | - | - | - | - |
| 71 | SS releases the RRC connection | <-- | NR RRC: <i>RRCRelease</i> | - | - |
| 72 | Make the UE attempt an IMS call dialling number 1001. (NOTE 1)
The number was initially stored in the Local emergency number list being received in the REGISTRATION ACCEPT message in step 65 and is not expected to have been removed from the list when no new list was received in the REGISTRATION ACCEPT message in step 66. | - | - | - | - |
| 73 | Check: Does the UE performs Generic Test Procedure for IMS Emergency call establishment with IMS emergency registration as specified in TS 38.508-1 [4], subclause 4.9.11? | - | - | 9 | - |

| | | | | | |
|---|--|-----|---------------------------|---|---|
| 74 | Make the UE release the emergency call.
(NOTE 1) | - | - | - | - |
| 75 | The Generic test procedure for IMS MO
Emergency call release as specified in TS
38.508-1 [4], subclause 4.9.12A takes place. | - | - | - | - |
| 76 | SS releases the RRC connection | <-- | NR RRC: <i>RRCRelease</i> | - | - |
| NOTE 1: This could be done by e.g. MMI or AT command. | | | | | |

11.4.7.3.3

Specific message contents

Table 11.4.7.3.3-1: REGISTRATION ACCEPT (Preamble)

| Derivation Path: TS 38.508-1 [4], Table 4.7.1-7. | | | |
|--|--------------------------------------|--|-----------|
| Information Element | Value/remark | Comment | Condition |
| Emergency number list | | | |
| Emergency Number information | 120
TS 24.008 [43],
10.5.3.13. | Number is different to any emergency number stored permanently in the ME AND the numbers stored in the USIM, as indicated in TS 22.101 [42] clause 10.1.1 a)-c). | |
| Extended emergency number list | | | |
| EENLV | '0' | Extended Local Emergency Numbers List is valid in the country of the PLMN from which this IE is received | |
| Emergency Number information | 10
TS 24.301 [21],
9.9.3.37A. | Number is different to any emergency number stored permanently in the ME AND the numbers stored in the USIM, as indicated in TS 22.101 [42] clause 10.1.1 a)-c). | |

Table 11.4.7.3.3-2: REGISTRATION ACCEPT (step 11, Table 11.4.7.3.2-1; step 4, TS 38.508-1 [4], Table 4.9.5.2.2-1)

| Derivation Path: TS 38.508-1 [4], Table 4.7.1-7. | | | |
|--|--|--|-----------|
| Information Element | Value/remark | Comment | Condition |
| Emergency number list | | | |
| Emergency Number information | 1 number: 1001

TS 24.008 [43],
10.5.3.13. | Number is different to any emergency number stored permanently in the ME AND the numbers stored in the USIM, as indicated in TS 22.101 [42] clause 10.1.1 a)-c). | |
| Extended emergency number list | | | |
| EENLV | '0' | Extended Local Emergency Numbers List is valid in the country of the PLMN from which this IE is received | |
| Emergency Number information | 1 number: 12345

TS 24.301 [21],
9.9.3.37A. | Number is different to any emergency number stored permanently in the ME AND the numbers stored in the USIM, as indicated in TS 22.101 [42] clause 10.1.1 a)-c). | |

Table 11.4.7.3.3-3: REGISTRATION ACCEPT (step 65, Table 11.4.7.3.2-1; step 4, TS 38.508-1 [4], Table 4.9.5.2.2-1)

| Derivation Path: TS 38.508-1 [4], Table 4.7.1-7. | | | |
|--|--|--|-----------|
| Information Element | Value/remark | Comment | Condition |
| Emergency number list | | | |
| Emergency Number information | 1 number: 1001

TS 24.008 [43],
10.5.3.13. | Number is different to any emergency number stored permanently in the ME AND the numbers stored in the USIM, as indicated in TS 22.101 [42] clause 10.1.1 a)-c). | |
| Extended emergency number list | | | |
| EENLV | '1' | Extended Local Emergency Numbers List is valid in the PLMN from which this IE is received | |
| Emergency Number information | 1 number: 12345

TS 24.301 [21],
9.9.3.37A. | Number is different to any emergency number stored permanently in the ME AND the numbers stored in the USIM, as indicated in TS 22.101 [42] clause 10.1.1 a)-c). | |

11.4.8 Handling of Local and extended emergency numbers / Switch-off and maximum local numbers storage

11.4.8.1 Test Purpose (TP)

(1)

```
with { UE in 5GMM-REGISTERED.NORMAL-SERVICE state and 5GMM-IDLE mode, having stored a Local
emergency numbers list }
ensure that {
  when { UE is switched off or the USIM is removed }
    then { UE deletes the stored Local emergency numbers list in the user equipment }
}
```

(2)

```
with { UE in 5GMM-REGISTERED.NORMAL-SERVICE state and 5GMM-IDLE mode, having stored an Extended
local emergency numbers list }
ensure that {
  when { UE is switched off or the USIM is removed }
    then { UE deletes the stored Extended local Emergency Numbers List in the user equipment }
}
```

(3)

```

with { UE in 5GMM-REGISTERED.NORMAL-SERVICE state and 5GMM-IDLE mode, UE receives a Local emergency
numbers list with 10 entries in the REGISTRATION ACCEPT message, provided in the Emergency number
list IE and the UE has stored them in local emergency numbers list }
ensure that {
  when { UE is requested to make an outgoing call using any of the emergency numbers received in the
Local emergency numbers list }
  then { UE establishes an IMS Emergency call }
}

```

(4)

```

with { UE in 5GMM-REGISTERED.NORMAL-SERVICE state and 5GMM-IDLE mode, UE receives an Extended local
emergency numbers list with 20 entries, in the REGISTRATION ACCEPT message, provided in the Extended
emergency number list IE and the UE has stored them in local emergency numbers lists }
ensure that {
  when { UE is requested to make an outgoing call using any of the emergency numbers received in the
Extended local emergency numbers list }
  then { UE establishes an IMS Emergency call }
}

```

11.4.8.2 Conformance requirements

References: The conformance requirements covered in the present TC are specified in: TS 38.331 [12], subclause 5.3.3.3, TS 24.501 [22], subclause 5.3.12, TS 24.301 [21], subclause 5.3.7, TS 22.101 [42], subclause 10.1.1. Unless otherwise stated these are Rel-15 requirements.

[TS 38.331, subclause 5.3.3.3]

The UE shall set the contents of *RRCSetupRequest* message as follows:

...

1> set the *establishmentCause* in accordance with the information received from upper layers;

The UE shall submit the *RRCSetupRequest* message to lower layers for transmission.

[TS 24.501, subclause 5.3.12]

The network may send a Local emergency numbers list or an Extended local emergency numbers list or both, in the REGISTRATION ACCEPT message, by including the Emergency number list IE and the Extended emergency number list IE, respectively. The Local emergency numbers list can be updated as described in 3GPP TS 24.301 [15], subclause 5.3.7.

The user equipment shall store the Local emergency numbers list and the Extended local emergency numbers list, as provided by the network. The Local emergency numbers list stored in the user equipment shall be replaced on each receipt of the Emergency number list IE. The Extended local emergency numbers list stored in the user equipment shall be replaced on each receipt of the Extended emergency number list IE. The received Local emergency numbers list or the received Extended local emergency numbers list or both shall be provided to the upper layers.

...

The Local emergency numbers list and the Extended local emergency numbers list shall be deleted at switch off or removal of the USIM. The user equipment shall be able to store up to ten entries in the Local emergency numbers list and up to twenty entries in the Extended local emergency numbers list, received from the network.

For the use of the Local emergency numbers list and the Extended local emergency numbers list by the UE see 3GPP TS 24.301 [15], subclause 5.3.7.

[TS 24.301, subclause 5.3.7]

The Local Emergency Numbers List and the Extended local Emergency Numbers list contain additional Local emergency numbers used by the serving network. These lists can be downloaded by the network to the UE at successful registration and subsequent registration updates. There is only one Local Emergency Numbers List and only one Extended local Emergency Numbers list in the UE. The Local Emergency Numbers List can be updated with EMM procedures if the UE is in S1 mode, with GMM and MM procedures if the UE is in A/Gb or Iu mode, and with 5GMM procedures, as specified in 3GPP TS 24.501 [54], if UE is in N1 mode. The Extended local Emergency Numbers List

can be updated with EMM procedures if the UE is in S1 mode and with 5GMM procedures, as specified in 3GPP TS 24.501 [54], if UE is in N1 mode.

The UE shall use the stored Local Emergency Numbers List and the stored Extended local Emergency Numbers List received from the network in addition to the emergency numbers stored on the USIM or user equipment to detect that the number dialled is an emergency number.

If the UE determines that the number dialled is an emergency number, the procedures specified in 3GPP TS 23.167 [45] and 3GPP TS 24.229 [13D] are utilised to select a domain for the emergency session attempt.

If the domain selected for the emergency session attempt is the PS domain, then the UE shall perform the session establishment procedures specified in 3GPP TS 24.229 [13D] to initiate an emergency session.

[TS 22.101, subclause 10.1.1]

The ME shall identify an emergency number dialled by the end user as a valid emergency number and initiate emergency call establishment if it occurs under one or more of the following conditions. If it occurs outside of the following conditions, the ME should not initiate emergency call establishment but normal call establishment. Emergency number identification takes place before and takes precedence over any other (e.g. supplementary service related) number analysis.

- a) 112 and 911 shall always be available. These numbers shall be stored on the ME.
- b) Any emergency call number stored on a SIM/USIM when the SIM/USIM is present.
- c) 000, 08, 110, 999, 118 and 119 when a SIM/USIM is not present. These numbers shall be stored on the ME.
- d) Additional emergency call numbers that may have been downloaded by the serving network when the SIM/USIM is present.

11.4.8.3 Test description

11.4.8.3.1 Pre-test conditions

System Simulator:

- 2 NR Cells
 - NR Cell 1 and NR Cell 12 as defined in TS 38.508-1 [4], Table 4.4.2-3. System information combination NR-1 as defined in TS 38.508-1 [4], subclause 4.4.3.1.2. SIB1 indicates *ims-EmergencySupport*.
 - No more than 2 cells active simultaneously at any time throughout the test.

UE:

- The UE is equipped with a test USIM with USIM Configuration 20 as defined in TS 38.508-1 [4], Table 6.4.1-20 (USIM contains two Emergency Numbers: 144, 117).

Preamble:

- Cells signal level in accordance with TS 38.508-1 [4], Table 6.2.2.1-3:
 - NR Cell 1 "Serving cell"
 - NR Cell 12 "Non-Suitable "Off" cell"
- The UE is in state SWITCHED_OFF as defined in TS 38.508-1 [4], subclause 4.5.5.
 - During the initial registration on NR Cell 1:
 - Local emergency number(s) and Extended local emergency number(s) are provided by the Network as specified in Table 11.4.8.3.3-1.

11.4.8.3.2 Test procedure sequence

Table 11.4.8.3.2-1: Main behaviour

| St | Procedure | Message Sequence | | TP | Verdict |
|----|---|------------------|---------------------------|----|---------|
| | | U - S | Message | | |
| - | The following messages are to be observed on NR Cell 1 unless explicitly stated otherwise. | - | - | - | - |
| 1 | Power on the UE. | - | - | - | - |
| 2 | The Generic test procedure for NR RRC_IDLE described in TS 38.508-1 [4], Table 4.5.2.2-2 is performed. The UE performs registration and the RRC connection is released.

During the procedure the SS does not send new Local emergency number list and Extended local emergency number list in the REGISTRATION ACCEPT message. | - | - | - | - |
| 3 | Make the UE attempt an IMS call dialling number 120. (NOTE 1)
The number was initially stored in the Local emergency number list being received in the REGISTRATION ACCEPT message in the Preamble but is expected to have been removed from the list upon switch-off. | - | - | - | - |
| 4 | Check: Does the UE performs Generic Test Procedure for IMS MO speech call establishment as specified in TS 38.508-1 [4], subclause 4.9.15? | - | - | 1 | - |
| 5 | Make the UE release the call. (NOTE 1) | - | - | - | - |
| 6 | The Generic test procedure for IMS MO call release as specified in TS 38.508-1 [4], subclause 4.9.17 takes place. | - | - | - | - |
| 7 | SS releases the RRC connection | <-- | NR RRC: <i>RRCRelease</i> | - | - |
| 8 | Make the UE attempt an IMS call dialling number 10. (NOTE 1)
The number was initially stored in the Extended local emergency number list being received in the REGISTRATION ACCEPT message in the Preamble but is expected to have been removed from the list upon switch-off. | - | - | - | - |
| 9 | Check: Does the UE performs Generic Test Procedure for IMS MO speech call establishment as specified in TS 38.508-1 [4], subclause 4.9.15? | - | - | 2 | - |
| 10 | Make the UE release the call. (NOTE 1) | - | - | - | - |
| 11 | The Generic test procedure for IMS MO call release as specified in TS 38.508-1 [4], subclause 4.9.17 takes place. | - | - | - | - |
| 12 | SS releases the RRC connection | <-- | NR RRC: <i>RRCRelease</i> | - | - |
| - | The SS configures:
- NR Cell 12 as "Serving cell"
- NR Cell 1 as "Non-Suitable "Off" cell" | - | - | - | - |
| - | The following messages are to be observed on NR Cell 12 unless explicitly stated otherwise. | - | - | - | - |
| 13 | The UE performs the Registration procedure for mobility registration update as specified in TS 38.508-1 [4] subclause 4.9.5.
During the procedure the UE receives new Local emergency number list with 10 entries and Extended local emergency number list with 20 entries in the REGISTRATION ACCEPT message. | - | - | - | - |
| - | EXCEPTION: Steps 14-18 are repeated 10 times. Each iteration shall be started with different number being dialled. The following | - | - | - | - |

| | | | | | |
|---|---|-----|---------------------------|---|---|
| | Local emergency numbers received in the REGISTRATION ACCEPT message in step 13 shall be used: 120 ... 129 | | | | |
| 14 | Make the UE attempt an IMS call dialling one of the numbers specified in the EXCEPTION step above. (NOTE 1) | - | - | - | - |
| 15 | Check: Does the UE performs Generic Test Procedure for IMS Emergency call establishment with IMS emergency registration as specified in TS 38.508-1 [4], subclause 4.9.11? | - | - | 3 | - |
| 16 | Make the UE release the emergency call. (NOTE 1) | - | - | - | - |
| 17 | The Generic test procedure for IMS MO Emergency call release as specified in TS 38.508-1 [4], subclause 4.9.12A takes place. | - | - | - | - |
| 18 | SS releases the RRC connection | <-- | NR RRC: <i>RRCRelease</i> | - | - |
| - | EXCEPTION: Steps 19-23 are repeated 20 times. Each iteration shall be started with different number being dialled. The following Extended local emergency numbers received in the REGISTRATION ACCEPT message in step 13 shall be used: 10 ... 37, 130, 4001. | - | - | - | - |
| 19 | Make the UE attempt an IMS call dialling one of the numbers specified in the EXCEPTION step above. (NOTE 1) | - | - | - | - |
| 20 | Check: Does the UE performs Generic Test Procedure for IMS Emergency call establishment with IMS emergency registration as specified in TS 38.508-1 [4], subclause 4.9.11? | - | - | 4 | - |
| 21 | Make the UE release the emergency call. (NOTE 1) | - | - | - | - |
| 22 | The Generic test procedure for IMS MO Emergency call release as specified in TS 38.508-1 [4], subclause 4.9.12A takes place. | - | - | - | - |
| 23 | SS releases the RRC connection | <-- | NR RRC: <i>RRCRelease</i> | - | - |
| NOTE 1: This could be done by e.g. MMI or AT command. | | | | | |

11.4.8.3.3

Specific message contents

Table 11.4.8.3.3-1: REGISTRATION ACCEPT (Preamble)

| Derivation Path: TS 38.508-1 [4], Table 4.7.1-7. | | | |
|--|--------------------------------------|--|-----------|
| Information Element | Value/remark | Comment | Condition |
| Emergency number list | | | |
| Emergency Number information | 120
TS 24.008 [43],
10.5.3.13. | Number is different to any emergency number stored permanently in the ME AND the numbers stored in the USIM, as indicated in TS 22.101 [42] clause 10.1.1 a)-c). | |
| Extended emergency number list | | | |
| EENLV | '0' | Extended Local Emergency Numbers List is valid in the country of the PLMN from which this IE is received | |
| Emergency Number information | 10
TS 24.301 [21],
9.9.3.37A. | Number is different to any emergency number stored permanently in the ME AND the numbers stored in the USIM, as indicated in TS 22.101 [42] clause 10.1.1 a)-c). | |

Table 11.4.8.3.3-2: REGISTRATION ACCEPT (step 13, Table 11.4.8.3.2-1; step 4, TS 38.508-1 [4], Table 4.9.5.2.2-1)

| Derivation Path: TS 38.508-1 [4], Table 4.7.1-7. | | | |
|--|--|--|-----------|
| Information Element | Value/remark | Comment | Condition |
| Emergency number list | | | |
| Emergency Number information | 10 numbers: 120 ... 129

TS 24.008 [43],
10.5.3.13. | Numbers different to any emergency number stored permanently in the ME AND the numbers stored in the USIM, as indicated in TS 22.101 [42] clause 10.1.1 a)-c). | |
| Extended emergency number list | | | |
| EENLV | '0' | Extended Local Emergency Numbers List is valid in the country of the PLMN from which this IE is received | |
| Emergency Number information | 20 numbers:
10 ... 37, 130, 4001

TS 24.301 [21],
9.9.3.37A. | Numbers different to any emergency number stored permanently in the ME AND the numbers stored in the USIM, as indicated in TS 22.101 [42] clause 10.1.1 a)-c). | |

11.4.9 5GMM-DEREGISTERED.LIMITED-SERVICE No suitable cells in tracking area / Emergency call establishment and release

11.4.9.1 Test Purpose (TP)

(1)

```
with { UE in 5GMM-DEREGISTERED.LIMITED-SERVICE state after receiving REGISTRATION REJECT message
with 5GMM cause value #15 'No suitable cells in tracking area' }
ensure that {
  when { UE is requested to make an Emergency call }
  then { UE establishes an RRC connection with the RRC establishmentCause set to "emergency", and,
attempts an Initial registration for emergency services by sending a REGISTRATION REQUEST message
with IE Service type set to "emergency services", and, accepts and applies security with NULL
security and integrity algorithms, and, after successful completion of the registration for
emergency services establishes an emergency PDU session by sending an UL NAS TRANSPORT message with
Request type set to "initial emergency request" and a PDU SESSION ESTABLISHMENT REQUEST }
}
```

(2)

```
with { UE in 5GMM-DEREGISTERED.LIMITED-SERVICE state after receiving REGISTRATION REJECT message
with 5GMM cause value #15 'No suitable cells in tracking area' and having established an Emergency
call }
ensure that {
  when { UE is requested to release the Emergency call }
  then { UE releases the Emergency call, and, the UE considers the current cell as belonging to
SGS forbidden tracking areas for roaming }
}
```

11.4.9.2 Conformance requirements

References: The conformance requirements covered in the present TC are specified in: TS 38.331 [12], subclause 5.3.3.3, TS 23.501 [37], subclause 5.16.4.1, TS 23.122 [38], subclause 3.4.2, TS 24.501 [22], subclauses 5.5.1.2.5, 4.4.4.1, 5.1.3.2.1.3.3, 5.3.2, 5.4.2.3, 5.5.1.2.2, 6.4.1.2, TS 22.101 [42], subclause 10.1.1. Unless otherwise stated these are Rel-15 requirements.

[TS 24.501, subclause 5.5.1.2.5]

If the initial registration request cannot be accepted by the network, the AMF shall send a REGISTRATION REJECT message to the UE including an appropriate 5GMM cause value.

...

The UE shall take the following actions depending on the 5GMM cause value received in the REGISTRATION REJECT message.

...

#15 (No suitable cells in tracking area).

The UE shall set the 5GS update status to 5U3 ROAMING NOT ALLOWED (and shall store it according to subclause 5.1.3.2.2). The UE shall reset the registration attempt counter and shall enter the state 5GMM-REGISTERED.LIMITED-SERVICE. The UE shall search for a suitable cell in another tracking area according to 3GPP TS 38.304 [28].

The UE shall store the current TAI in the list of "5GS forbidden tracking areas for roaming" and shall remove the current TAI from the stored TAI list, if present.

If the UE is operating in single-registration mode, the UE shall handle the EMM parameters EMM state, EPS update status and tracking area updating attempt counter as specified in 3GPP TS 24.301 [15] for the case when the normal tracking area updating procedure is rejected with the EMM cause with the same value.

[TS 23.122, subclause 3.4.2]

The MS is not allowed to request 5GS services except emergency services when camped on a cell of a TA of which belongs to the list of "5GS forbidden tracking areas for regional provision of service".

[TS 36.331, subclause 5.3.3.3]

The UE shall set the contents of *RRCSetupRequest* message as follows:

...

1> set the *establishmentCause* in accordance with the information received from upper layers;

The UE shall submit the *RRCSetupRequest* message to lower layers for transmission.

[TS 23.501, subclause 5.16.4.1]

UEs that are in limited service state, as specified in TS 23.122 [17], or that camp normally on a cell but failed to register successfully to the network under conditions specified in TS 24.501 [47], initiate the Registration procedure by indicating that the registration is to receive Emergency Services, referred to as Emergency Registration, and a Follow-on request is included in the Registration Request to initiate PDU Session Establishment procedure with a Request Type indicating "Emergency Request". UEs that had registered for normal services and do not have emergency PDU Sessions established and that are subject to Mobility Restriction in the present area or RAT (e.g. because of restricted tracking area) shall initiate the UE Requested PDU Session Establishment procedure to receive Emergency Services, i.e. with a Request Type indicating "Emergency Request". Based on local regulation, the network supporting Emergency Services for UEs in limited service state provides Emergency Services to these UE, regardless whether the UE can be authenticated, has roaming or Mobility Restrictions or a valid subscription.

[TS 24.501, subclause 4.4.4.1]

The use of "null integrity protection algorithm" 5G-IA0 (see subclause 9.11.3.32) in the current 5G NAS security context is only allowed for an unauthenticated UE for which establishment of emergency services is allowed. For

setting the security header type in outbound NAS messages, the UE and the AMF shall apply the same rules irrespective of whether the "null integrity protection algorithm" or any other integrity protection algorithm is indicated in the 5G NAS security context.

If the "null integrity protection algorithm" 5G-IA0 has been selected as an integrity protection algorithm, the receiver shall regard the NAS messages with the security header indicating integrity protection as integrity protected.

[TS 24.501, subclause 5.1.3.2.1.3.3]

The substate 5GMM-DEREGISTERED.LIMITED-SERVICE is chosen in the UE, when it is known that a selected cell for 3GPP access or TA for non-3GPP access is unable to provide normal service (e.g. the selected cell over 3GPP access is in a forbidden PLMN or is in a forbidden tracking area or TA for non-3GPP access is forbidden).

[TS 24.501, subclause 5.3.2]

The UE provides the SUPI to the network in concealed form. The SUCI is a privacy preserving identifier containing the concealed SUPI. When the SUPI contains a network specific identifier, the SUCI shall take the form of an NAI as specified in 3GPP TS 23.003 [4].

A UE supporting N1 mode includes a SUCI:

- a) in the REGISTRATION REQUEST message when the UE is attempting initial registration procedure and a valid 5G-GUTI is not available; or

...

The UE shall use the "null-scheme" as specified in 3GPP TS 33.501 [24] to generate the SUCI, if the following applies:

- a) the UE performs a registration procedure for emergency services or initiates a de-registration procedure before the registration procedure for emergency services was completed successfully; and

[TS 24.501, subclause 5.4.2.3]

If the UE is registered for emergency services, performing initial registration for emergency services or establishing an emergency PDU session and the SECURITY MODE COMMAND message is received with ngKSI value "000" and 5G-IA0 and 5G-EA0 as selected 5G NAS security algorithms, the UE shall locally derive and take in use 5G NAS security context. The UE shall delete existing current 5G NAS security context.

The UE shall accept a SECURITY MODE COMMAND message indicating the "null integrity protection algorithm" 5G-EA0 as the selected 5G NAS integrity algorithm only if the message is received when the UE is registered for emergency services, performing initial registration for emergency services or establishing an emergency PDU session.

[TS 24.501, subclause 5.5.1.2.2]

The UE in state 5GMM-DEREGISTERED shall initiate the registration procedure for initial registration by sending a REGISTRATION REQUEST message to the AMF,

...

- b) when the UE performs initial registration for emergency services;

...

If the UE initiates an initial registration for emergency services or needs to prolong the established NAS signalling connection after the completion of the initial registration procedure (e.g. due to uplink signalling pending), the UE shall set the Follow-on request indicator to 1.

[TS 24.501, subclause 6.4.1.2]

In order to initiate the UE-requested PDU session establishment procedure, the UE shall create a PDU SESSION ESTABLISHMENT REQUEST message.

- NOTE 0: When IMS voice is available over either 3GPP access or non-3GPP access, the "voice centric" UE in 5GMM-REGISTERED state will receive a request from upper layers to establish the PDU session for IMS signalling, if the conditions for performing an initial registration with IMS indicated in 3GPP TS 24.229 [14] subclause U.3.1.2 are satisfied.

If the UE requests to establish a new PDU session, the UE shall allocate a PDU session ID which is not currently being used by another PDU session over either 3GPP access or non-3GPP access.

The UE shall allocate a PTI value currently not used and shall set the PTI IE of the PDU SESSION ESTABLISHMENT REQUEST message to the allocated PTI value.

...

If the UE requests to establish a new emergency PDU session, the UE shall set the SSC mode IE of the PDU SESSION ESTABLISHMENT REQUEST message to "SSC mode 1".

...

The UE shall transport:

- a) the PDU SESSION ESTABLISHMENT REQUEST message;
- b) the PDU session ID of the PDU session being established, or being handed over or being transferred;
- ..
- e) the request type which is set to:
 - ...
 - 3) "initial emergency request", if the UE requests to establish a new emergency PDU session; and

...

If the request type is set to "initial emergency request" or "existing emergency PDU session", neither DNN nor S-NSSAI is transported by the UE using the NAS transport procedure as specified in subclause 5.4.5.

[TS 22.101, subclause 10.1.1]

The ME shall identify an emergency number dialled by the end user as a valid emergency number and initiate emergency call establishment if it occurs under one or more of the following conditions. If it occurs outside of the following conditions, the ME should not initiate emergency call establishment but normal call establishment. Emergency number identification takes place before and takes precedence over any other (e.g. supplementary service related) number analysis.

- a) 112 and 911 shall always be available. These numbers shall be stored on the ME.

11.4.9.3 Test description

11.4.9.3.1 Pre-test conditions

System Simulator:

- 1 NR Cell
- NR Cell 1, as defined in TS 38.508-1 [4], Table 4.4.2-3.
- System information combination NR-1 as defined in TS 38.508-1 [4], subclause 4.4.3.1.2. SIB1 indicates *ims-EmergencySupport*.

UE:

None.

Preamble:

- The UE is in test state 0N-B (Switched Off) as defined in TS 38.508-1 [4], subclause 4.4A.2.

11.4.9.3.2 Test procedure sequence

Table 11.4.9.3.2-1: Main behaviour

| St | Procedure | Message Sequence | | TP | Verdict |
|----------|---|------------------|--|----|---------|
| | | U - S | Message | | |
| 1 | Switch the UE on. | - | - | - | - |
| 2-4 | Steps 2-4 of Table 4.5.2.2-2 NR RRC_IDLE in TS38.508-1 [4] take place (the UE initiates an initial registration procedure). | - | - | - | - |
| 5 | SS sends a REGISTRATION REJECT message containing 5GMM cause value = #15 (No suitable cells in tracking area). | <-- | NR RRC: <i>DLInformationTransfer</i>
5GMM: REGISTRATION REJECT | - | - |
| 6 | The SS transmits an <i>RRCConnectionRelease</i> message. | <-- | NR RRC: <i>RRCRelease</i> | - | - |
| 7 | Make the UE attempt an IMS emergency call dialling a number which is stored on the ME (e.g. 112 or 911). (NOTE 1) | - | - | - | - |
| 8 | Check: Does the UE performs Generic Test Procedure for IMS Emergency call establishment without IMS emergency registration as specified in TS 38.508-1 [4], subclause 4.9.12? | - | - | 1 | - |
| 9 | Make the UE release the emergency call. (NOTE 1) | - | - | - | - |
| 10 | The Generic test procedure for IMS MO Emergency call release as specified in TS 38.508-1 [4], subclause 4.9.12A takes place. | - | - | - | - |
| 11 | Start Timer=10 sec.
NOTE: This is an arbitrary value to wait for UE initiated detach. | - | - | - | - |
| - | EXCEPTION: Steps 12a1-12b3 describes optional behaviour that depends on the UE implementation. | - | - | - | - |
| 12a
1 | The UE transmits a DEREGISTRATION REQUEST message with De-registration type IE set to "Normal de-registration". | --> | NR RRC: <i>ULInformationTransfer</i>
5GMM: DEREGISTRATION REQUEST | - | - |
| 12a
2 | The SS transmits a DEREGISTRATION ACCEPT message. | <-- | NR RRC: <i>DLInformationTransfer</i>
5GMM: DEREGISTRATION ACCEPT | - | - |
| 12a
3 | Stop Timer=10. | - | - | - | - |
| 12b
1 | Timer=10 sec expires | - | - | - | - |
| 12b
2 | The SS transmits a DEREGISTRATION REQUEST message with Deregistration type IE set to "re-registration not required". | <-- | NR RRC: <i>DLInformationTransfer</i>
5GMM: DEREGISTRATION REQUEST | - | - |
| 12b
3 | The UE transmits a DEREGISTRATION ACCEPT message. | --> | NR RRC: <i>ULInformationTransfer</i>
5GMM: DEREGISTRATION ACCEPT | - | - |
| 13 | SS releases the RRC connection | <-- | NR RRC: <i>RRCRelease</i> | - | - |
| 14 | Check: Does the UE transmit an <i>RRCSetupRequest</i> message in the next 30sec?
NOTE: This is an arbitrary value to wait for catching not allowed UE behaviour. | --> | NR RRC: <i>RRCSetupRequest</i> | 2 | F |

NOTE 1: This could be done by e.g. MMI or AT command.

11.4.9.3.3 Specific message contents

Table 11.4.9.3.3-1: REGISTRATION REJECT (step 5, Table 11.4.9.3.2-1)

| Derivation path: TS 38.508-1 [4] table 4.7.1-9. | | | |
|---|--------------|---|-----------|
| Information Element | Value/remark | Comment | Condition |
| 5GMM cause | '00001111'B | #15 (No suitable cells in tracking area). | |

Table 11.4.9.3.3-2: REGISTRATION REQUEST (step 8, Table 11.4.9.3.2-1; step 3, TS 38.508-1 [4], Table 4.9.12.2.2-1)

| Derivation Path: TS 38.508-1 [4], Table 4.7.1-6, condition EMERGENCY. | | | |
|---|--------------|---|-----------|
| Information Element | Value/remark | Comment | Condition |
| 5GS mobile identity | SUCI | The UE shall use the "null-scheme" as specified in 3GPP TS 33.501 [20] to generate the SUCI | |

Table 11.4.9.3.3-3: DEREGISTRATION REQUEST (Step 12a1, Table 11.4.9.3.2-1)

| Derivation Path: TS 38.508-1 [4], Table 4.7.1-12, Condition NORMAL. |
|---|
|---|

Table 11.4.9.3.3-4: DEREGISTRATION REQUEST (Step 12b2, Table 11.4.9.3.2-1)

| Derivation Path: TS 38.508-1 [4], Table 4.7.1-14. | | | |
|---|--------------|---|-----------|
| Information Element | Value/remark | Comment | Condition |
| De-registration type | | | |
| bit 3 | '0'B | re-registration not required | |
| Access type | '01'B | 3GPP access | |
| 5GMM cause | '00001111'B | #15 (No suitable cells in tracking area). | |

11.4.10 5GMM-REGISTERED.NORMAL-SERVICE / N26 interface not supported / N1 mode to S1 mode transfer of an existing emergency PDU session

11.4.10.1 Test Purpose (TP)

(1)

```

with { UE in 5GMM-REGISTERED.NORMAL-SERVICE state and 5GMM-IDLE mode with Interworking without N26
interface supported, and, the UE has an emergency PDU session established }
ensure that {
  when { UE performs a inter-system change from the N1 to S1 mode }
  then { UE correctly transfers the existing emergency PDU session into an emergency PDN
connection }
}

```

11.4.10.2 Conformance requirements

References: The conformance requirements covered in the present TC are specified in: TS 24.501 [22], subclause 6.1.4.2, TS 22.101 [42], subclause 10.1.1. Unless otherwise stated these are Rel-15 requirements.

[TS 24.501, subclause 6.1.4.2]

Upon inter-system change from N1 mode to S1 mode in EMM-IDLE mode, the UE shall use the parameters from each PDU session which the UE intends to transfer to EPS to create the contents of a PDN CONNECTIVITY REQUEST message as follows:

- a) if the PDU session is an emergency PDU session, the request type shall be set to "handover of emergency bearer services". Otherwise the request type shall be set to "handover";
- b) the PDU session type of the PDU session shall be mapped to the PDN type of the default EPS bearer context as follows:
 - 1) the PDN type shall be set to "non-IP" if the PDU session type is "Ethernet" or "Unstructured";
 - 2) the PDN type shall be set to "IPv4" if the PDU session type is "IPv4";
 - 3) the PDN type shall be set to "IPv6" if the PDU session type is "IPv6"; and
 - 4) the PDN type shall be set to "IPv4v6" if the PDU session type is "IPv4v6";
- c) the DNN of the PDU session shall be mapped to the APN of the default EPS bearer context; and
- d) the PDU session ID parameter in the PCO IE shall be set to the PDU session identity of the PDU session.

After inter-system change from N1 mode to S1 mode, the UE shall associate the PDU session identity with the default EPS bearer context.

[TS 22.101, subclause 10.1.1]

The ME shall identify an emergency number dialled by the end user as a valid emergency number and initiate emergency call establishment if it occurs under one or more of the following conditions. If it occurs outside of the following conditions, the ME should not initiate emergency call establishment but normal call establishment. Emergency number identification takes place before and takes precedence over any other (e.g. supplementary service related) number analysis.

- a) 112 and 911 shall always be available. These numbers shall be stored on the ME.

11.4.10.3 Test description

11.4.10.3.1 Pre-test conditions

System Simulator:

- 2 cells
- NR Cell 1 as defined in TS 38.508-1 [4] Table 4.4.2-3. System information combination NR-6 as defined in TS 38.508-1 [4], subclause 4.4.3.1.2.
- E-UTRA Cell 1 as defined in TS 36.508 [7] Table 4.4.2-2. System information combination 31 as defined in TS 36.508 [7], subclause 4.4.3.1.1.

UE:

None.

Preamble:

With E-UTRA Cell 1 "Non-suitable "Off" cell" and NR Cell 1 "Serving cell" in accordance with TS 38.508-1 [4], Table 6.2.2.1-3, the UE is brought to state 1N-A, RRC_IDLE Connectivity (NR), in accordance with the procedure described in TS 38.508-1 [4], subclause 4.5.2 (Table 4.5.2.2-2 and depending on UE implementation Table 4.5.2.2-4). Interworking without N26 interface supported in accordance with the definition specified in TS 38.508-1 [4], subclause 4.5.1.

11.4.10.3.2 Test procedure sequence

Table 11.4.10.3.2-1: Main behaviour

| St | Procedure | Message Sequence | | TP | Verdict |
|-------------------|---|------------------|---------------------------|----|---------|
| | | U - S | Message | | |
| 1 | Make the UE attempt an IMS emergency call dialling an emergency number. (NOTE 1) | - | - | - | - |
| 2 | The UE performs Generic Test Procedure for IMS Emergency call establishment with IMS emergency registration as specified in TS 38.508-1 [4], subclause 4.9.11. | - | - | - | - |
| 3 | SS releases the RRC connection | <- | NR RRC: <i>RRCRelease</i> | - | - |
| 4 | The SS configures:
- E-UTRA Cell A as "Serving cell"
- NGC Cell A as "Non-suitable "off" cell". | - | - | - | - |
| 5-10 | Steps 1-6 from the test procedure for UE for Tracking area updating / Inter-system change from N1 mode to S1 mode in 5GMM/EMM-IDLE mode as specified in TS 38.508-1 [4], Table 4.9.7.2.2-1, take place. | - | - | - | - |
| - | EXCEPTION: In parallel to step 10Aa1 below the steps described in table 11.4.10.3.2-2 take place. | - | - | - | - |
| 10Aa1 | Step 6Aa1 from the test procedure for UE for Tracking area updating / Inter-system change from N1 mode to S1 mode in 5GMM/EMM-IDLE mode as specified in TS 38.508-1 [4], Table 4.9.7.2.2-1, takes place. | - | - | - | - |
| 10Ab2a1 - 10Ab2a8 | Steps 6Ab2a1 - 6Ab2a8 from the test procedure for UE for Tracking area updating / Inter-system change from N1 mode to S1 mode in 5GMM/EMM-IDLE mode as specified in TS 38.508-1 [4], Table 4.9.7.2.2-1, take place. | - | - | - | - |

NOTE 1: This could be done by e.g. MMI or AT command.

Table 11.4.10.3.2-2: Parallel behaviour

| St | Procedure | Message Sequence | | TP | Verdict |
|-----|--|------------------|--------------------------|----|---------|
| | | U - S | Message | | |
| 1 | Check: Does the UE transmit a PDN CONNECTIVITY REQUEST message to request an additional PDN, with 'Request type' set to 'handover of emergency bearer services'? | --> | PDN CONNECTIVITY REQUEST | 1 | P |
| 2-7 | Steps 10-15 from the Generic Test Procedure for IMS Emergency call establishment in EUTRA: Normal Service as specified in TS 36.508 [7], Table 4.5A.4.3-1 are performed. | - | - | - | - |

11.4.10.3.3 Specific message contents

Table 11.4.10.3.3-1: REGISTRATION ACCEPT (Preamble)

| Derivation path: TS 38.508-1 [4], Table 4.7.1-7, condition EMERGENCY | | | |
|--|------------------------|--|--|
| Information Element | Value/remark | Comment | Condition |
| 5GS network feature support | '0100 1101 0000 0000'B | IMS voice over PS session supported over 3GPP access, Emergency services supported in NR connected to 5GCN and E-UTRA connected to 5GCN.
Interworking without N26 interface supported (octet 3, bit 7)
All other features set to "not supported". | Interworking without N26 interface supported |

Table 11.4.10.3.3-2: PDN CONNECTIVITY REQUEST (step 1, Table 11.4.10.3.2-2)

| Derivation Path: TS 36.508 [7], Table 4.7.2-1. | | | |
|--|--|--|-----------|
| Information Element | Value/remark | Comment | Condition |
| Request type | '001'B | 'handover of emergency bearer services' | |
| PDN type | The PDU session type of the emergency PDU session established prior to the N1 to S1 move | The PDU session established in step 2, Table 11.4.10.3.2-1 | |
| Access point name | sos | | |
| Protocol configuration options | Only the values indicated below are checked | | |
| protocol identifier | | | |
| length of the protocol identifier contents of the unit | | | |
| protocol identifier contents | | | |
| Additional parameters list | | | |
| container identifier | 001AH | (PDU session ID) | |
| container identifier contents | The PDU session ID of the emergency PDU session established prior to the N1 to S1 move. | | |

12 NR sidelink

12.1 PC5-only operation

12.2 Inter-carrier concurrent operation

12.2.1 Inter-carrier concurrent operation / Sidelink communication

12.2.1.1

12.2.1.2

12.2.1.3 Inter-carrier concurrent operation / Sidelink communication / RRC_CONNECTED / Transmission / Network scheduling

12.2.1.3.1 Test Purpose (TP)

(1)

```
with { UE is in RRC_CONNECTED state and its serving cell broadcasts SIB12 including sl-
ConfigCommonNR }
ensure that {
  when { UE is configured by upper layers to perform sidelink transmission on the frequency included
in sl-FreqInfoList }
  then { UE sends a SidelinkUEInformationNR message to indicate it requires sidelink transmission
resources }
}
```

(2)

```
with { UE is in RRC_CONNECTED state and is configured by upper layers to perform sidelink
transmission }
ensure that {
  when { UE receives an RRCReconfiguration message which includes sl-ScheduledConfig and no sl-
ConfiguredGrantConfigList }
  then { UE performs sidelink transmission based on dynamic scheduling }
}
```

(3)

```
with { UE is in RRC_CONNECTED state }
ensure that {
  when { UE is configured by upper layers to provide configured grant assistance information for NR
sidelink communication }
  then { UE sends a UEAssistanceInformation message including sl-UE-AssistanceInformationNR }
}
```

(4)

```
with { UE is in RRC_CONNECTED state and is configured by upper layers to perform sidelink
transmission }
ensure that {
  when { UE receives an RRCReconfiguration message which includes sl-ConfiguredGrantConfigList }
  then { UE performs sidelink transmission using the configured grant included in sl-
ConfiguredGrantConfigList }
}
```

(5)

```
with { UE is in RRC_CONNECTED state and is configured by upper layer to perform sidelink
transmission }
```



```

ensure that {
  when { UE is no longer configured by upper layers to perform sidelink transmission }
  then { UE sends a SidelinkUEInformationNR message to indicate it no longer requires sidelink
transmission resources }
}

```

12.2.1.3.2 Conformance requirements

References: The conformance requirements covered in the current TC are specified in: TS 38.331, clause 5.3.5.3, 5.5.2, 5.5.4.1, 5.5.4.2, 5.5.4.3 and 5.5.5. Unless otherwise stated these are Rel-16 requirements.

[TS 38.331, clause 5.3.5.3]

The UE shall perform the following actions upon reception of the *RRCReconfiguration*, or upon execution of the conditional reconfiguration (CHO or CPC):

...

1> if the *RRCReconfiguration* message includes the *otherConfig*:

2> perform the other configuration procedure as specified in 5.3.5.9;

...

1> if the *RRCReconfiguration* message includes the *sl-ConfigDedicatedNR*:

2> perform the sidelink dedicated configuration procedure as specified in 5.3.5.14;

...

1> else (*RRCReconfiguration* was received via SRB1):

2> submit the *RRCReconfigurationComplete* message via SRB1 to lower layers for transmission using the new configuration;

...

[TS 38.331, clause 5.3.5.14]

Upon initiating the procedure, the UE shall:

...

1> if *sl-FreqInfoToAddModList* is included in *sl-ConfigDedicatedNR* within *RRCReconfiguration*:

...

2> if configured to transmit NR sidelink communication:

3> use the resource pool(s) indicated by *sl-TxPoolSelectedNormal*, *sl-TxPoolScheduling* or *sl-TxPoolExceptional* for NR sidelink communication transmission, as specified in 5.8.8;

2> perform CBR measurement on the transmission resource pools indicated by *sl-TxPoolSelectedNormal*, *sl-TxPoolScheduling* or *sl-TxPoolExceptional* for NR sidelink communication transmission, as specified in 5.5.3;

2> use the synchronization configuration parameters for NR sidelink communication on frequencies included in *sl-FreqInfoToAddModList*, as specified in 5.8.5;

...

1> if *sl-RadioBearerToAddModList* or *sl-RLC-BearerToAddModList* is included in *sl-ConfigDedicatedNR* within *RRCReconfiguration*:

2> perform sidelink DRB addition/modification as specified in 5.8.9.1a.2;

1> if *sl-ScheduledConfig* is included in *sl-ConfigDedicatedNR* within *RRCReconfiguration*:

- 2> configure the MAC entity parameters, which are to be used for NR sidelink communication, in accordance with the received *sl-ScheduledConfig*;

...

[TS 38.331, clause 5.7.4.2]

...

A UE capable of providing configured grant assistance information for NR sidelink communication in RRC_CONNECTED may initiate the procedure in several cases, including upon being configured to provide traffic pattern information and upon change of traffic patterns.

...

Upon initiating the procedure, the UE shall:

...

- 1> if configured to provide configured grant assistance information for NR sidelink communication:
 - 2> initiate transmission of the *UEAssistanceInformation* message in accordance with 5.7.4.3 to provide configured grant assistance information for NR sidelink communication;

...

[TS 38.331, clause 5.7.4.3]

...

The UE shall set the contents of the *UEAssistanceInformation* message for configured grant assistance information for NR sidelink communication:

- 1> if configured to provide configured grant assistance information for NR sidelink communication:
 - 2> include the *sl-UE-AssistanceInformationNR*;
- ...
- 1> else:
 - 2> submit the *UEAssistanceInformation* message to lower layers for transmission.

[TS 38.331, clause 5.8.3.2]

Upon initiating this procedure, the UE shall:

- 1> if *SIB12* including *sl-ConfigCommonNR* is provided by the PCell:
 - 2> ensure having a valid version of *SIB12* for the PCell;
- ...
- 2> if configured by upper layers to transmit NR sidelink communication on the frequency included in *sl-FreqInfoList* in *SIB12* of the PCell:
 - 3> if the UE did not transmit a *SidelinkUEInformationNR* message since last entering RRC_CONNECTED state; or
 - 3> if since the last time the UE transmitted a *SidelinkUEInformationNR* message the UE connected to a PCell not providing *SIB12* including *sl-ConfigCommonNR*; or
 - 3> if the last transmission of the *SidelinkUEInformationNR* message did not include *sl-TxResourceReqList*; or if the information carried by the *sl-TxResourceReqList* has changed since the last transmission of the *SidelinkUEInformationNR* message:
 - 4> initiate transmission of the *SidelinkUEInformationNR* message to indicate the NR sidelink communication transmission resources required by the UE in accordance with 5.8.3.3;

2> else:

3> if the last transmission of the *SidelinkUEInformationNR* message included *sl-TxResourceReqList*:

4> initiate transmission of the *SidelinkUEInformationNR* message to indicate it no longer requires NR sidelink communication transmission resources in accordance with 5.8.3.3.

[TS 38.331, clause 5.8.3.3]

The UE shall set the contents of the *SidelinkUEInformationNR* message as follows:

1> if the UE initiates the procedure to indicate it is (no more) interested to receive NR sidelink communication or to request (configuration/ release) of NR sidelink communication transmission resources or to report to the network that a sidelink radio link failure or sidelink RRC reconfiguration failure has been declared (i.e. UE includes all concerned information, irrespective of what triggered the procedure):

2> if *SIB12* including *sl-ConfigCommonNR* is provided by the PCell:

...

3> if configured by upper layers to transmit NR sidelink communication:

4> include *sl-TxResourceReqList* and set its fields (if needed) as follows for each destination for which it requests network to assign NR sidelink communication resource:

5> set *sl-DestinationIdentity* to the destination identity configured by upper layer for NR sidelink communication transmission;

5> set *sl-CastType* to the cast type of the associated destination identity configured by the upper layer for the NR sidelink communication transmission;

...

5> set *sl-QoS-InfoList* to include QoS profile(s) of the sidelink QoS flow(s) of the associated destination configured by the upper layer for the NR sidelink communication transmission;

5> set *sl-InterestedFreqList* to indicate the frequency of the associated destination for NR sidelink communication transmission;

5> set *sl-TypeTxSyncList* to the current synchronization reference type used on the associated *sl-InterestedFreqList* for NR sidelink communication transmission.

...

...

1> else:

2> submit the *SidelinkUEInformationNR* message to lower layers for transmission;

[TS 38.331, clause 5.8.8]

A UE capable of NR sidelink communication that is configured by upper layers to transmit NR sidelink communication and has related data to be transmitted shall:

1> if the conditions for NR sidelink communication operation as defined in 5.8.2 are met:

2> if the frequency used for NR sidelink communication is included in *sl-FreqInfoToAddModList* in *sl-ConfigDedicatedNR* within *RRCReconfiguration* message or included in *sl-ConfigCommonNR* within *SIB12*:

3> if the UE is in *RRC_CONNECTED* and uses the frequency included in *sl-ConfigDedicatedNR* within *RRCReconfiguration* message:

4> if the UE is configured with *sl-ScheduledConfig*:

...

5> else:

6> configure lower layers to perform the sidelink resource allocation mode 1 for NR sidelink communication;

...

[TS 38.321, clause 5.22.1.1]

...

If the MAC entity has been configured with Sidelink resource allocation mode 1 as indicated in TS 38.331 [5], the MAC entity shall for each PDCCH occasion and for each grant received for this PDCCH occasion:

1> if a sidelink grant has been received on the PDCCH for the MAC entity's SL-RNTI:

...

2> else:

3> use the received sidelink grant to determine PSCCH duration(s) and PSSCH duration(s) for initial transmission and, if available, retransmission(s) of a single MAC PDU according to clause 8.1.2 of TS 38.214 [7].

...

1> else if a sidelink grant has been received on the PDCCH for the MAC entity's SLCS-RNTI:

2> if PDCCH contents indicate retransmission(s) for the identified HARQ process ID that has been set for an activated configured sidelink grant identified by *sl-ConfigIndexCG*:

3> use the received sidelink grant to determine PSCCH duration(s) and PSSCH duration(s) for one or more retransmissions of a single MAC PDU according to clause 8.1.2 of TS 38.214 [7].

...

The MAC entity shall for each PSSCH duration:

1> for each sidelink grant occurring in this PSSCH duration:

2> if the MAC entity has been configured with Sidelink resource allocation mode 1:

3> select a MCS which is, if configured, within the range that is configured by RRC between *sl-MinMCS-PSSCH* and *sl-MaxMCS-PSSCH* included in *sl-ConfigDedicatedNR*;

3> set the resource reservation interval to 0ms.

...

2> if the configured sidelink grant has been activated and this PSSCH duration corresponds to the first PSSCH transmission opportunity within this *sl-PeriodCG* of the configured sidelink grant:

3> set the HARQ Process ID to the HARQ Process ID associated with this PSSCH duration and, if available, all subsequent PSSCH duration(s) occurring in this *sl-PeriodCG* for the configured sidelink grant;

3> determine that this PSSCH duration is used for initial transmission;

3> if a dynamic sidelink grant associated to the HARQ Process ID has been received on the PDCCH for the MAC entity's SLCS-RNTI:

4> clear the dynamic sidelink grant.

2> deliver the sidelink grant, the selected MCS, and the associated HARQ information to the Sidelink HARQ Entity for this PSSCH duration.

...

[TS 38.321, clause 5.22.1.1]

...

A SL-BSR shall be triggered if any of the following events occur:

- 1> if the MAC entity has been configured with Sidelink resource allocation mode 1:
 - 2> SL data, for a logical channel of a Destination, becomes available to the MAC entity; and either
 - 3> this SL data belongs to a logical channel with higher priority than the priorities of the logical channels containing available SL data which belong to any LCG belonging to the same Destination; or
 - 3> none of the logical channels which belong to an LCG belonging to the same Destination contains any available SL data.
- in which case the SL-BSR is referred below to as 'Regular SL-BSR';

...

- 1> else:
 - 2> Sidelink resource allocation mode 1 is configured by RRC and SL data is available for transmission in the RLC entity or in the PDCP entity, in which case the Sidelink BSR is referred below to as "Regular SL-BSR".

For Regular SL-BSR, the MAC entity shall:

- 1> if the SL-BSR is triggered for a logical channel for which *sl-logicalChannelSR-DelayTimerApplied* with value *true* is configured by RRC:
 - 2> start or restart the *sl-logicalChannelSR-DelayTimer*.
- 1> else:
 - 2> if running, stop the *sl-logicalChannelSR-DelayTimer*.

For Regular and Periodic SL-BSR, the MAC entity shall:

- 1> if *sl-PrioritizationThres* is configured and the value of the highest priority of the logical channels that belong to any LCG and contain SL data for any Destination is lower than *sl-PrioritizationThres*; and
- 1> if either *ul-PrioritizationThres* is not configured or *ul-PrioritizationThres* is configured and the value of the highest priority of the logical channels that belong to any LCG and contain UL data is equal to or higher than *ul-PrioritizationThres* according to clause 5.4.5:
 - 2> prioritize the LCG(s) for the Destination(s).
- 1> if the Buffer Status reporting procedure determines that at least one BSR has been triggered and not cancelled according to clause 5.4.5 and the UL grant cannot accommodate a SL-BSR MAC CE containing buffer status only for all prioritized LCGs having data available for transmission plus the subheader of the SL-BSR according to clause 5.4.3.1.3, in case the SL-BSR is considered as not prioritized:
 - 2> prioritize the SL-BSR for logical channel prioritization specified in clause 5.4.3.1;
 - 2> report Truncated SL-BSR containing buffer status for as many prioritized LCGs having data available for transmission as possible, taking the number of bits in the UL grant into consideration.
- 1> else if the number of bits in the UL grant is expected to be equal to or larger than the size of a SL-BSR containing buffer status for all LCGs having data available for transmission plus the subheader of the SL-BSR according to clause 5.4.3.1.3:
 - 2> report SL-BSR containing buffer status for all LCGs having data available for transmission.
- 1> else:
 - 2> report Truncated SL-BSR containing buffer status for as many LCGs having data available for transmission as possible, taking the number of bits in the UL grant into consideration.

...

The MAC entity shall:

- 1> if the sidelink Buffer Status reporting procedure determines that at least one SL-BSR has been triggered and not cancelled:
 - 2> if UL-SCH resources are available for a new transmission and the UL-SCH resources can accommodate the SL-BSR MAC CE plus its subheader as a result of logical channel prioritization according to clause 5.4.3.1:
 - 3> instruct the Multiplexing and Assembly procedure in clause 5.4.3 to generate the SL-BSR MAC CE(s);
 - 3> start or restart *sl-periodicBSR-Timer* except when all the generated SL-BSRs are Truncated SL-BSRs;
 - 3> start or restart *sl-retxBSR-Timer*.

...

12.2.1.3.3 Test description

12.2.1.3.3.1 Pre-test conditions

System Simulator:

- SS-NW
- NR Cell 1
- System information combination FFS as defined in TS 38.508-1[4] clause 4.4.3.1 is used in NR Cell 1.
- SS-UE
- Operating as NR sidelink communication receiving device on the resources that UE is expected to use for transmission.

UE:

- UE is authorised to perform NR sidelink communication.

Preamble:

- The UE is in state 3N-A as defined in TS 38.508-1 [4], subclause 4.4A on NR Cell 1 and Test Loop Function (*On*) with UE test loop mode FFS defined in 38.509 [6], subclause FFS.

12.2.1.3.3.2 Test procedure sequence

FFS

Table 12.2.1.3.3.2-1: Main behaviour

| St | Procedure | Message Sequence | | TP | Verdict |
|----|---|------------------|---|----|---------|
| | | U - S | Message | | |
| 1 | Upper layers of the UE configures the UE to perform sidelink transmission.
Note: This step is triggered by MMI or AT command | - | - | - | - |
| 2 | Check: Does the UE send a SidelinkUEInformationNR message to request sidelink transmission resource? | --> | NR RRC:
<i>SidelinkUEInformationNR</i> | 1 | P |
| 3 | SS-NW transmits an RRCReconfiguration message with sl-ConfigDedicatedNR to configure transmission resources and to configure the UE to perform network scheduling-based sidelink transmission | <-- | NR RRC: <i>RRCReconfiguration</i> | - | - |
| 4 | The UE transmits an RRCReconfigurationComplete message. | --> | NR RRC:
<i>RRCReconfigurationComplete</i> | | |
| 5 | Check: Does the UE send a Sidelink BSR MAC-CE? | --> | MAC CE (sidelink BSR) | 2 | P |
| 5 | SS-NW sends a DCI format 3_0 to configure sidelink grant for the UE | <-- | DCI format 3_0 | - | - |
| 6 | Check: Does the UE transmit one STCH PDCP SDU over the PC5 interface using the resources scheduled by SS-NW? | --> | STCH PDCP SDU | 2 | P |
| 7 | Upper layers of the UE configures the UE to send a UEAssistanceInformation message.
Note: This step is triggered by MMI or AT command | - | - | - | - |
| 8 | Check: Does the UE send a UEAssistanceInformation message to provide configured grant assistance information? | --> | NR RRC:
<i>UEAssistanceInformation</i> | 3 | P |
| 9 | SS-NW transmits an RRCReconfiguration message with sl-ConfiguredGrantConfigList to provide a Type 2 configured grant for the UE. | <-- | NR RRC: <i>RRCReconfiguration</i> | - | - |
| 10 | The UE transmits an RRCReconfigurationComplete message. | --> | NR RRC:
<i>RRCReconfigurationComplete</i> | - | - |
| 11 | SS-NW transmits an DCI format 3_0 to activate the configured grant. | <-- | DCI format 3_0 | - | - |
| 12 | The UE sends a Sidelink Configured Grant Confirmation MAC CE | --> | MAC CE (Sidelink Configured Grant Confirmation) | - | - |
| 13 | Check: Does the UE transmit one STCH PDCP SDU over the PC5 interface using the resources indicated by the configured grant? | --> | STCH PDCP SDU | 4 | P |
| 14 | Upper layer of the UE configures the UE to stop sidelink transmission. | - | - | - | - |
| 15 | Check: Does the UE send a SidelinkUEInformationNR message to indicate that sidelink transmission resource is not needed? | --> | NR RRC:
<i>SidelinkUEInformationNR</i> | 1 | P |

12.2.1.3.3.3 Specific message contents

FFS

12.2.2

12.2.3 Inter-carrier concurrent operation / Measurement configuration and reporting via Uu RRC

12.2.3.1 Inter-carrier concurrent operation / Measurement configuration and reporting via Uu RRC / CBR measurement reporting / Event C1 and C2

12.2.3.1.1 Test Purpose (TP)

(1)

```
with { UE is in NR RRC_CONNECTED state and is configured to perform event C1 triggered CBR
measurement reporting on resource pool }
ensure that {
  when { CBR measurement result of indicated resource pool satisfies entering condition for event C1
}
  then { UE sends MeasurementReport message to report CBR measurement results of indicated
resource pool }
}
```

(2)

```
with { UE is in NR RRC_CONNECTED state and the periodical measurement reporting triggered by event
C1 is ongoing }
ensure that {
  when { CBR measurement result of indicated resource pool satisfies leaving condition for event C1
}
  then { UE stops sending MeasurementReport message }
}
```

(3)

```
with { UE is in NR RRC_CONNECTED state and is configured to perform event C2 triggered CBR
measurement reporting on resource pool }
ensure that {
  when { CBR measurement result of indicated resource pool satisfies entering condition for event C1
}
  then { UE sends MeasurementReport message to report CBR measurement results of indicated
resource pool }
}
```

(4)

```
with { UE is in NR RRC_CONNECTED state and the periodical measurement reporting triggered by event
C2 is ongoing }
ensure that {
  when { CBR measurement result of indicated resource pool satisfies leaving condition for event C2
}
  then { UE stops sending MeasurementReport message }
}
```

12.2.3.1.2 Conformance requirements

References: The conformance requirements covered in the current TC are specified in: TS 38.331, clause 5.3.5.3, 5.5.2, 5.5.4.1, 5.5.4.2, 5.5.4.3 and 5.5.5. Unless otherwise stated these are Rel-16 requirements.

[TS 38.331, clause 5.3.5.3]

The UE shall perform the following actions upon reception of the *RRCReconfiguration*, or upon execution of the conditional reconfiguration (CHO or CPC):

...

1> if the *RRCReconfiguration* message includes the *measConfig*:

2> perform the measurement configuration procedure as specified in 5.5.2;

...

1> else (*RRCReconfiguration* was received via SRB1):

2> submit the *RRCReconfigurationComplete* message via SRB1 to lower layers for transmission using the new configuration;

...

[TS 38.331, clause 5.5.2.1]

...

The UE shall:

...

1> if the received *measConfig* includes the *measObjectToAddModList*:

2> perform the measurement object addition/modification procedure as specified in 5.5.2.5;

...

1> if the received *measConfig* includes the *reportConfigToAddModList*:

2> perform the reporting configuration addition/modification procedure as specified in 5.5.2.7;

1> if the received *measConfig* includes the *quantityConfig*:

2> perform the quantity configuration procedure as specified in 5.5.2.8;

...

1> if the received *measConfig* includes the *measIdToAddModList*:

2> perform the measurement identity addition/modification procedure as specified in 5.5.2.3;

...

[TS 38.331, clause 5.5.3.1]

The UE shall:

1> whenever the UE has a *measConfig*, perform RSRP and RSRQ measurements for each serving cell for which *servingCellMO* is configured as follows:

2> if the *reportConfig* associated with at least one *measId* included in the *measIdList* within *VarMeasConfig* contains an *rsType* set to *ssb* and *ssb-ConfigMobility* is configured in the *measObject* indicated by the *servingCellMO*:

3> if the *reportConfig* associated with at least one *measId* included in the *measIdList* within *VarMeasConfig* contains a *reportQuantityRS-Indexes* and *maxNrofRS-IndexesToReport* and contains an *rsType* set to *ssb*:

4> derive layer 3 filtered RSRP and RSRQ per beam for the serving cell based on SS/PBCH block, as described in 5.5.3.3a;

3> derive serving cell measurement results based on SS/PBCH block, as described in 5.5.3.3;

...

The UE capable of CBR measurement when configured to transmit NR sidelink communication shall:

1> If the frequency used for NR sidelink communication is included in *sl-FreqInfoToAddModList* in *sl-ConfigDedicatedNR* within *RRCReconfiguration* message or included in *sl-ConfigCommonNR* within *SIB12*:

...

- 2> if the UE is in RRC_CONNECTED:
 - 3> if *tx-PoolMeasToAddModList* is included in *VarMeasConfig*:
 - 4> perform CBR measurements on each transmission resource pool indicated in the *tx-PoolMeasToAddModList*;
 - 3> if *sl-TxPoolSelectedNormal*, *sl-TxPoolScheduling* or *sl-TxPoolExceptional* is included in *sl-ConfigDedicatedNR* for the concerned frequency within RRCReconfiguration:
 - 4> perform CBR measurement on pools in *sl-TxPoolSelectedNormal*, *sl-TxPoolScheduling* or *sl-TxPoolExceptional* if included in *sl-ConfigDedicatedNR* for the concerned frequency within RRCReconfiguration;
 - 3> else if the cell chosen for NR sidelink communication provides *SIB12* which includes *sl-TxPoolSelectedNormal* or *sl-TxPoolExceptional* for the concerned frequency:
 - 4> perform CBR measurement on pools in *sl-TxPoolSelectedNormal* and *sl-TxPoolExceptional* for the concerned frequency in *SIB12*;
- 1> else:
 - 2> perform CBR measurement on pools in *sl-TxPoolSelectedNormal* and *sl-TxPoolExceptional* in *SidelinkPreconfigNR* for the concerned frequency.

...

[TS 38.331, clause 5.5.4.1]

If AS security has been activated successfully, the UE shall:

- 1> for each *measId* included in the *measIdList* within *VarMeasConfig*:
 - ...
 - 2> if the corresponding *reportConfig* concerns the reporting for NR sidelink communication (i.e. *reportConfigNR-SL*):
 - 3> consider the transmission resource pools indicated by the *tx-PoolMeasToAddModList* defined within the *VarMeasConfig* for this *measId* to be applicable;
 - ...
 - 2> else if the *reportType* is set to *eventTriggered* and if the entry condition applicable for this event, i.e. the event corresponding with the *eventId* of the corresponding *reportConfig* within *VarMeasConfig*, is fulfilled for one or more applicable transmission resource pools for all measurements taken during *timeToTrigger* defined for this event within the *VarMeasConfig*, while the *VarMeasReportList* does not include an measurement reporting entry for this *measId* (a first transmission resource pool triggers the event):
 - 3> include a measurement reporting entry within the *VarMeasReportList* for this *measId*;
 - 3> set the *numberOfReportsSent* defined within the *VarMeasReportList* for this *measId* to 0;
 - 3> include the concerned transmission resource pool(s) in the *poolsTriggeredList* defined within the *VarMeasReportList* for this *measId*;
 - 3> initiate the measurement reporting procedure, as specified in 5.5.5;
 - 2> else if the *reportType* is set to *eventTriggered* and if the entry condition applicable for this event, i.e. the event corresponding with the *eventId* of the corresponding *reportConfig* within *VarMeasConfig*, is fulfilled for one or more applicable transmission resource pools not included in the *poolsTriggeredList* for all measurements taken during *timeToTrigger* defined for this event within the *VarMeasConfig* (a subsequent transmission resource pool triggers the event):
 - 3> set the *numberOfReportsSent* defined within the *VarMeasReportList* for this *measId* to 0;

- 3> include the concerned transmission resource pool(s) in the *poolTriggeredList* defined within the *VarMeasReportList* for this *measId*;
- 3> initiate the measurement reporting procedure, as specified in 5.5.5;
- 2> else if the *reportType* is set to *eventTriggered* and if the leaving condition applicable for this event is fulfilled for one or more applicable transmission resource pools included in the *poolTriggeredList* defined within the *VarMeasReportList* for this *measId* for all measurements taken during *timeToTrigger* defined within the *VarMeasConfig* for this event:
 - 3> remove the concerned transmission resource pool(s) in the *poolTriggeredList* defined within the *VarMeasReportList* for this *measId*;
 - 3> if the *poolTriggeredList* defined within the *VarMeasReportList* for this *measId* is empty:
 - 4> remove the measurement reporting entry within the *VarMeasReportList* for this *measId*;
 - 4> stop the periodical reporting timer for this *measId*, if running
- ...
- 2> upon expiry of the periodical reporting timer for this *measId*:
 - 3> initiate the measurement reporting procedure, as specified in 5.5.5.
- ...

[TS 38.331, clause 5.5.4.11]

The UE shall:

- 1> consider the entering condition for this event to be satisfied when condition C1-1, as specified below, is fulfilled;
- 1> consider the leaving condition for this event to be satisfied when condition C1-2, as specified below, is fulfilled;

Inequality C1-1 (Entering condition)

$$Ms - Hys > Thresh$$

Inequality C1-2 (Leaving condition)

$$Ms + Hys < Thresh$$

The variables in the formula are defined as follows:

Ms is the measurement result of channel busy ratio of the transmission resource pool, not taking into account any offsets.

Hys is the hysteresis parameter for this event (i.e. *hysteresis* as defined within *reportConfigNR-SL* for this event).

Thresh is the threshold parameter for this event (i.e. *c1-Threshold* as defined within *reportConfigNR-SL* for this event).

Ms is expressed in decimal from 0 to 1 in steps of 0.01.

Hys is expressed in the same unit as ***Ms***.

Thresh is expressed in the same unit as ***Ms***.

[TS 38.331, clause 5.5.4.12]

The UE shall:

- 1> consider the entering condition for this event to be satisfied when condition C2-1, as specified below, is fulfilled;
- 1> consider the leaving condition for this event to be satisfied when condition C2-2, as specified below, is fulfilled;

Inequality C2-1 (Entering condition)

$$Ms + Hys < Thresh$$

Inequality C2-2 (Leaving condition)

$$Ms - Hys > Thresh$$

The variables in the formula are defined as follows:

Ms is the measurement result of channel busy ratio of the transmission resource pool, not taking into account any offsets.

Hys is the hysteresis parameter for this event (i.e. *hysteresis* as defined within *reportConfigNR-SL* for this event).

Thresh is the threshold parameter for this event (i.e. *c2-Threshold* as defined within *reportConfigNR-SL* for this event).

Ms is expressed in decimal from 0 to 1 in steps of 0.01.

Hys is expressed in the same unit as ***Ms***.

Thresh is expressed in the same unit as ***Ms***.

[TS 38.331, clause 5.5.5.1]



Figure 5.5.5.1-1: Measurement reporting

The purpose of this procedure is to transfer measurement results from the UE to the network. The UE shall initiate this procedure only after successful AS security activation.

For the *measId* for which the measurement reporting procedure was triggered, the UE shall set the *measResults* within the *MeasurementReport* message as follows:

- 1> set the *measId* to the measurement identity that triggered the measurement reporting;
- 1> for each serving cell configured with *servingCellMO*:
 - ...
 - 2> else:
 - 3> if SSB based serving cell measurements are available:
 - 4> set the *measResultServingCell* within *measResultServingMOList* to include RSRP, RSRQ and the available SINR of the serving cell, derived based on SSB;
 - ...
 - 1> set the *servCellId* within *measResultServingMOList* to include each NR serving cell that is configured with *servingCellMO*, if any;
 - ...
 - 1> if there is at least one applicable transmission resource pool for NR sidelink communication (for *measResultsSL*):
 - 2> set the *measResultsListSL* to include the CBR measurement results in accordance with the following:
 - 3> if the *reportType* is set to *eventTriggered*:

4> include the transmission resource pools included in the *poolsTriggeredList* as defined within the *VarMeasReportList* for this *measId*;

3> else:

4> include the applicable transmission resource pools for which the new measurement results became available since the last periodical reporting or since the measurement was initiated or reset;

3> if the corresponding *measObject* concerns NR sidelink communication, then for each transmission resource pool to be reported:

4> set the *sl-poolReportIdentity* to the identity of this transmission resource pool;

4> set the *sl-CBR-ResultsNR* to the CBR measurement results on PSSCH and PSCCH of this transmission resource pool provided by lower layers, if available;

...

1> increment the *numberOfReportsSent* as defined within the *VarMeasReportList* for this *measId* by 1;

1> stop the periodical reporting timer, if running;

1> if the *numberOfReportsSent* as defined within the *VarMeasReportList* for this *measId* is less than the *reportAmount* as defined within the corresponding *reportConfig* for this *measId*:

2> start the periodical reporting timer with the value of *reportInterval* as defined within the corresponding *reportConfig* for this *measId*;

...

1> else:

2> submit the *MeasurementReport* message to lower layers for transmission, upon which the procedure ends..

12.2.3.1.3 Test description

12.2.3.1.3.1 Pre-test conditions

System Simulator:

- SS-NW
- NR Cell 1
- System information combination FFS as defined in TS 38.508-1[4] clause 4.4.3.1 is used in NR Cell 1.
- SS-UE
- Operating as NR sidelink communication transmitting device on the resources that UE is expected to use for transmission.

UE:

- UE is authorised to perform NR sidelink communication.

Preamble:

- The UE is in state 3N-A as defined in TS 38.508-1 [4], subclause 4.4A on NR Cell 1.

12.2.3.1.3.2 Test procedure sequence

FFS

Table 12.2.3.1.3.2-3: Main behaviour

| St | Procedure | Message Sequence | | TP | Verdict |
|----|---|------------------|--|----|---------|
| | | U - S | Message | | |
| 1 | The UE transmits a SidelinkUEInformationNR message to request resources for transmission of NR sidelink communication. | --> | NR RRC:
<i>SidelinkUEInformationNR</i> | - | - |
| 2 | SS-UE is configured to achieve 50% congestion continuously in consecutive slots according to the transmission pattern shown in FFS | - | - | - | - |
| 3 | SS-NW transmits an RRCReconfiguration message with sl-ConfigDedicatedNR to configure transmission resources. | <-- | NR RRC: <i>RRCReconfiguration</i> | - | - |
| 4 | UE transmits an RRCReconfigurationComplete message. | --> | NR RRC:
<i>RRCReconfigurationComplete</i> | | |
| 5 | SS-NW transmits an RRCReconfiguration message with measConfig to setup event C1 triggered CBR measurement and reporting. | <-- | NR RRC: <i>RRCReconfiguration</i> | - | - |
| 6 | UE transmits an RRCReconfigurationComplete message. | --> | NR RRC:
<i>RRCReconfigurationComplete</i> | | |
| 7 | Check: Does the UE transmit a MeasurementReport message in the following 5s? | --> | NR RRC: <i>MeasurementReport</i> | 1 | F |
| 8 | SS-UE is configured to achieve 100% congestion continuously in consecutive slots according to the transmission pattern shown in FFS | - | - | - | - |
| 9 | Check: Does the UE transmit a MeasurementReport message with the measured CBR value for indicated resource pool? | --> | NR RRC: <i>MeasurementReport</i> | 1 | P |
| 10 | SS-UE is configured to achieve 50% congestion continuously in consecutive slots according to the transmission pattern shown in FFS | - | - | - | - |
| 11 | SS-NW waits for 2s | - | - | - | - |
| 12 | Check: Does the UE transmit a MeasurementReport message in the following 5s? | --> | NR RRC: <i>MeasurementReport</i> | 2 | F |
| 13 | SS-NW transmits an RRCReconfiguration message with measConfig to release event C1 and setup event C2 triggered CBR measurement and reporting. | <-- | NR RRC: <i>RRCReconfiguration</i> | - | - |
| 14 | UE transmits an RRCReconfigurationComplete message. | --> | NR RRC:
<i>RRCReconfigurationComplete</i> | | |
| 15 | Check: Does the UE transmit a MeasurementReport message with the measured CBR value for indicated resource pool? | --> | NR RRC: <i>MeasurementReport</i> | 3 | P |
| 16 | SS-UE is configured to achieve 100% congestion continuously in consecutive slots according to the transmission pattern shown in FFS | - | - | - | - |
| 17 | SS-NW waits for 2s | - | - | - | - |
| 18 | Check: Does the UE transmit a MeasurementReport message in the following 5s? | --> | NR RRC: <i>MeasurementReport</i> | 4 | F |

12.2.3.1.3.3 Specific message contents

FFS

Annex A (informative): Change history

| Change history | | | | | | | |
|----------------|--------------------|-----------|----|-----|-----|---|-------------|
| Date | Meeting | TDoc | CR | Rev | Cat | Subject/Comment | New version |
| 2017-08 | RAN5#76 | R5-174427 | - | - | - | Introduction of TS 38.523-1. | 0.0.1 |
| 2017-12 | RAN5#77 | R5-176926 | - | - | - | Addition of new NR PDCP test case 7.3.1.2 | 0.1.0 |
| 2017-12 | RAN5#77 | R5-176928 | - | - | - | Addition of new NR MAC test case 7.1.3.1 | 0.1.0 |
| 2017-12 | RAN5#77 | R5-177072 | - | - | - | Addition of new NR RLC UM test case 7.2.2.1 | 0.1.0 |
| 2017-12 | RAN5#77 | R5-177073 | - | - | - | Addition of new NR RLC UM test case 7.2.2.2 | 0.1.0 |
| 2017-12 | RAN5#77 | R5-177074 | - | - | - | Addition of new NR PDCP test case 7.3.1.1 | 0.1.0 |
| 2017-12 | RAN5#77 | R5-177075 | - | - | - | Addition of new NR MAC test case 7.1.2.1 | 0.1.0 |
| 2018-03 | RAN5#77 | R5-181171 | - | - | - | 5GS RRC TC 8.2.2.1 | 0.2.0 |
| 2018-03 | RAN5#77 | R5-181172 | - | - | - | 5GS RRC TC 8.2.2.2.6 | 0.2.0 |
| 2018-03 | RAN5#77 | R5-181173 | - | - | - | 5GS RRC TC 8.2.3.1 | 0.2.0 |
| 2018-03 | RAN5#77 | R5-181174 | - | - | - | 5GS RRC TC 8.2.3.16 | 0.2.0 |
| 2018-03 | RAN5#77 | R5-181175 | - | - | - | 5GS RRC TC 8.2.5.1 | 0.2.0 |
| 2018-03 | RAN5#77 | R5-181176 | - | - | - | 5GS MAC Test case 7.1.1.2 | 0.2.0 |
| 2018-03 | RAN5#77 | R5-181177 | - | - | - | Addition of new NR MAC test case 7.1.3.2 | 0.2.0 |
| 2018-03 | RAN5#77 | R5-181178 | - | - | - | Addition of new NR MAC test case 7.1.3.3 | 0.2.0 |
| 2018-03 | RAN5#77 | R5-181179 | - | - | - | Addition of new NR MAC test case 7.1.3.4 | 0.2.0 |
| 2018-03 | RAN5#77 | R5-181180 | - | - | - | Addition of new NR MAC test case 7.1.3.5 | 0.2.0 |
| 2018-03 | RAN5#77 | R5-181181 | - | - | - | Addition of new NR MAC test case 7.1.3.6 | 0.2.0 |
| 2018-03 | RAN5#77 | R5-181182 | - | - | - | Addition of new NR RLC test case 7.2.3.1 | 0.2.0 |
| 2018-03 | RAN5#77 | R5-181183 | - | - | - | Addition of new NR RLC test case 7.2.3.2 | 0.2.0 |
| 2018-03 | RAN5#77 | R5-181184 | - | - | - | Addition of new NR PDCP test case 7.3.2.1 | 0.2.0 |
| 2018-03 | RAN5#77 | R5-181185 | - | - | - | Addition of new NR PDCP test case 7.3.2.2 | 0.2.0 |
| 2018-03 | RAN5#77 | R5-181186 | - | - | - | Addition of new NR PDCP test case 7.3.2.3 | 0.2.0 |
| 2018-03 | RAN5#77 | R5-181187 | - | - | - | Addition of new NR PDCP test case 7.3.3.1 | 0.2.0 |
| 2018-03 | RAN5#77 | R5-181188 | - | - | - | Addition of new NR PDCP test case 7.3.3.2 | 0.2.0 |
| 2018-03 | RAN5#77 | R5-181189 | - | - | - | Addition of new NR PDCP test case 7.3.3.3 | 0.2.0 |
| 2018-03 | RAN5#77 | R5-181201 | - | - | - | Addition of new NR MAC test case 7.1.5.1 | 0.2.0 |
| 2018-03 | RAN5#77 | R5-181202 | - | - | - | Addition of new NR MAC test case 7.1.5.2 | 0.2.0 |
| 2018-03 | RAN5#77 | R5-181203 | - | - | - | Addition of new NR PDCP test case 7.3.5.1 | 0.2.0 |
| 2018-03 | RAN5#77 | R5-181204 | - | - | - | Addition of new NR RRC test case 8.2.2.2.5 | 0.2.0 |
| 2018-03 | RAN5#77 | R5-181205 | - | - | - | Addition of new NR RRC test case 8.2.3.5 | 0.2.0 |
| 2018-03 | RAN5#77 | R5-181206 | - | - | - | Update of NR MAC test cases | 0.2.0 |
| 2018-03 | RAN5#77 | R5-181207 | - | - | - | Update of NR RLC test cases | 0.2.0 |
| 2018-03 | RAN5#77 | R5-181208 | - | - | - | Update of NR PDCP test cases | 0.2.0 |
| 2018-03 | RAN5#77 | R5-181209 | - | - | - | 5GS MAC Test case 7.1.5.3 | 0.2.0 |
| 2018-03 | RAN5#77 | R5-181312 | - | - | - | Addition of new NR PDCP test case 7.3.5.2 | 0.2.0 |
| 2018-03 | RAN5#77 | R5-181334 | - | - | - | Addition of new NR PDCP test case 7.3.4.2 | 0.2.0 |
| 2018-04 | RAN5#2-5G-NR Adhoc | R5-181805 | - | - | - | Corrections to RRC TC 8.2.3.1 Measurement configuration control and reporting / Inter-RAT measurements / Event B1 / Measurement of NR cells | 0.3.0 |
| 2018-04 | RAN5#2-5G-NR Adhoc | R5-181806 | - | - | - | 5GS RRC TC 8.2.1.2 | 0.3.0 |
| 2018-04 | RAN5#2-5G-NR Adhoc | R5-181914 | - | - | - | Addition of 5GS NR RRC test case 8.2.3.6 | 0.3.0 |
| 2018-04 | RAN5#2-5G-NR Adhoc | R5-181951 | - | - | - | Correction to RLC UM Test cases | 0.3.0 |
| 2018-04 | RAN5#2-5G-NR Adhoc | R5-181952 | - | - | - | Correction to RLC AM Test cases | 0.3.0 |
| 2018-04 | RAN5#2-5G-NR Adhoc | R5-181967 | - | - | - | Correction to PDCP ciphering test cases | 0.3.0 |
| 2018-04 | RAN5#2-5G-NR Adhoc | R5-181980 | - | - | - | 5GS RRC TC 8.2.2.2.9 | 0.3.0 |
| 2018-04 | RAN5#2-5G-NR Adhoc | R5-181981 | - | - | - | Corrections to RRC TC 8.2.3.16 Handover with PSCell release / SCG DRB | 0.3.0 |
| 2018-04 | RAN5#2-5G-NR | R5-181982 | - | - | - | 5GS RRC TC 8.2.3.2 | 0.3.0 |

| | | | | | | | |
|---------|--------------------|-----------|---|---|---|---|-------|
| | Adhoc | | | | | | |
| 2018-04 | RAN5#2-5G-NR Adhoc | R5-181983 | - | - | - | 5GS RRC TC 8.2.3.3 | 0.3.0 |
| 2018-04 | RAN5#2-5G-NR Adhoc | R5-181984 | - | - | - | 5GS RRC TC 8.2.3.4 | 0.3.0 |
| 2018-04 | RAN5#2-5G-NR Adhoc | R5-181986 | - | - | - | Addition of new NR RRC test case 8.2.2.2.4 | 0.3.0 |
| 2018-04 | RAN5#2-5G-NR Adhoc | R5-181988 | - | - | - | Addition of new NR NAS test case for dedicated EPS bearer context activation | 0.3.0 |
| 2018-04 | RAN5#2-5G-NR Adhoc | R5-181991 | - | - | - | Addition of text to clarify that 5GS requirements may be implicitly tested in other specs | 0.3.0 |
| 2018-04 | RAN5#2-5G-NR Adhoc | R5-181992 | - | - | - | New NAS test case EPS bearer resource allocation / New EPS bearer context | 0.3.0 |
| 2018-04 | RAN5#2-5G-NR Adhoc | R5-181994 | - | - | - | Addition of new NR MAC test case 7.1.4.1.1 | 0.3.0 |
| 2018-04 | RAN5#2-5G-NR Adhoc | R5-181995 | - | - | - | Addition of new NR MAC test case 7.1.4.1.2 | 0.3.0 |
| 2018-04 | RAN5#2-5G-NR Adhoc | R5-181996 | - | - | - | Addition of new NR MAC test case 7.1.4.1.3 | 0.3.0 |
| 2018-04 | RAN5#2-5G-NR Adhoc | R5-181997 | - | - | - | Addition of new NR MAC test case 7.1.4.1.4 | 0.3.0 |
| 2018-04 | RAN5#2-5G-NR Adhoc | R5-181998 | - | - | - | Addition of new NR RLC test case 7.2.2.6 | 0.3.0 |
| 2018-04 | RAN5#2-5G-NR Adhoc | R5-181999 | - | - | - | Addition of new NR RLC test case 7.2.3.5 | 0.3.0 |
| 2018-04 | RAN5#2-5G-NR Adhoc | R5-182050 | - | - | - | Addition of new NR RLC test case 7.2.2.5 | 0.3.0 |
| 2018-04 | RAN5#2-5G-NR Adhoc | R5-182051 | - | - | - | Addition of new NR RLC test case 7.2.3.6 | 0.3.0 |
| 2018-04 | RAN5#2-5G-NR Adhoc | R5-182052 | - | - | - | Addition of new NR RLC test case 7.2.3.7 | 0.3.0 |
| 2018-04 | RAN5#2-5G-NR Adhoc | R5-182053 | - | - | - | Addition of new NR RLC test case 7.2.3.8 | 0.3.0 |
| 2018-04 | RAN5#2-5G-NR Adhoc | R5-182054 | - | - | - | Addition of new NR RLC test case 7.2.3.3 | 0.3.0 |
| 2018-04 | RAN5#2-5G-NR Adhoc | R5-182055 | - | - | - | Addition of new NR RLC test case 7.2.3.4 | 0.3.0 |
| 2018-04 | RAN5#2-5G-NR Adhoc | R5-182056 | - | - | - | Addition of new NR RRC test case 8.2.3.9 | 0.3.0 |
| 2018-04 | RAN5#2-5G-NR Adhoc | R5-182057 | - | - | - | Addition of new NR RRC test case 8.2.3.10 | 0.3.0 |
| 2018-04 | RAN5#2-5G-NR Adhoc | R5-182058 | - | - | - | Addition of new NR RRC test case 8.2.3.11 | 0.3.0 |
| 2018-04 | RAN5#2-5G-NR Adhoc | R5-182059 | - | - | - | Addition of new NR RRC test case 8.2.3.12 | 0.3.0 |
| 2018-04 | RAN5#2-5G-NR Adhoc | R5-182060 | - | - | - | Correction to MAC test case 7.1.2.1 | 0.3.0 |
| 2018-04 | RAN5#2-5G-NR Adhoc | R5-182061 | - | - | - | Addition of new NR RRC test case 8.2.3.19 | 0.3.0 |
| 2018-04 | RAN5#2-5G-NR | R5-182076 | - | - | - | 5GS PDCP Test case 7.3.4.1 | 0.3.0 |

| | | | | | | | |
|---------|-------------------------|-----------|---|---|---|--|-------|
| | Adhoc | | | | | | |
| 2018-04 | RAN5#2-5G-NR Adhoc | R5-182077 | - | - | - | 5GS PDCP Test case 7.3.5.4 | 0.3.0 |
| 2018-04 | RAN5#2-5G-NR Adhoc | R5-182078 | - | - | - | 5GS RLC test case 7.2.3.11 | 0.3.0 |
| 2018-04 | RAN5#2-5G-NR Adhoc | R5-182079 | - | - | - | 5GS RLC test case 7.2.3.12 | 0.3.0 |
| 2018-04 | RAN5#2-5G-NR Adhoc | R5-182080 | - | - | - | Addition of new NR RRC test case 8.2.3.7 | 0.3.0 |
| 2018-04 | RAN5#2-5G-NR Adhoc | R5-182081 | - | - | - | Addition of new NR RLC test case 7.2.2.3 | 0.3.0 |
| 2018-04 | RAN5#2-5G-NR Adhoc | R5-182082 | - | - | - | Addition of new NR RLC test case 7.2.2.4 | 0.3.0 |
| 2018-04 | RAN5#2-5G-NR Adhoc | R5-182083 | - | - | - | Addition of new NR RRC test case 8.2.3.17 | 0.3.0 |
| 2018-04 | RAN5#2-5G-NR Adhoc | R5-182085 | - | - | - | Correction to PDCP integrity protection test cases | 0.3.0 |
| 2018-04 | RAN5#2-5G-NR Adhoc | R5-182089 | - | - | - | 5GS RRC TC 8.2.5.5 | 0.3.0 |
| 2018-04 | RAN5#2-5G-NR Adhoc | R5-182100 | - | - | - | 5GS RRC TC 8.2.5.6 | 0.3.0 |
| 2018-04 | RAN5#2-5G-NR Adhoc | R5-182101 | - | - | - | 5GS RRC TC 8.2.5.7 | 0.3.0 |
| 2018-04 | RAN5#2-5G-NR Adhoc | R5-182102 | - | - | - | 5GS RRC TC 8.2.2.2.7 | 0.3.0 |
| 2018-04 | RAN5#2-5G-NR Adhoc | R5-182103 | - | - | - | Corrections to RRC TC 8.2.5.1 RRC connection reconfiguration / PSCell addition failure | 0.3.0 |
| 2018-04 | RAN5#2-5G-NR Adhoc | R5-182104 | - | - | - | Corrections to RRC TC 8.2.2.2.1 PSCell addition, modification and release / SCG DRB | 0.3.0 |
| 2018-04 | RAN5#2-5G-NR Adhoc | R5-182105 | - | - | - | Corrections to RRC TC 8.2.2.2.6 Bearer Modification / SCG DRB / Split DRB Reconfiguration | 0.3.0 |
| 2018-04 | RAN5#2-5G-NR Adhoc | R5-182106 | - | - | - | Addition of new NR RRC test case 8.2.2.1.2 | 0.3.0 |
| 2018-04 | RAN5#2-5G-NR Adhoc | R5-182115 | - | - | - | Introduction of 5GS RRC TC 8.2.4.3.1 | 0.3.0 |
| 2018-04 | RAN5#2-5G-NR Adhoc | R5-182116 | - | - | - | Adding NR test case 8.2.2.1.1 | 0.3.0 |
| 2018-04 | RAN5#2-5G-NR Adhoc | R5-182117 | - | - | - | Adding NR test case 8.2.2.1.3 | 0.3.0 |
| 2018-04 | post RAN5#2-5G-NR Adhoc | - | - | - | - | Editorial update to apply with the 3GPP drafting rules (styles) | 0.3.1 |
| 2018-05 | RAN5#79 | R5-183094 | - | - | - | Addition of UE power headroom reporting test case 7.1.1.3.7 | 1.0.0 |
| 2018-05 | RAN5#79 | R5-183101 | - | - | - | Addition of DRX Operation test case 7.1.1.5.4 | 1.0.0 |
| 2018-05 | RAN5#79 | R5-183102 | - | - | - | Addition of Correct handling of DL assignment/Semi-persistent test case 7.1.1.6.1 | 1.0.0 |
| 2018-05 | RAN5#79 | R5-183103 | - | - | - | Addition of AM RLC test case 7.1.2.3.10 | 1.0.0 |
| 2018-05 | RAN5#79 | R5-183227 | - | - | - | Editorial updates to 38.523-1 | 1.0.0 |
| 2018-05 | RAN5#79 | R5-183229 | - | - | - | Correction to PDCP Test case - PDCP reordering/Maximum re-ordering delay below t-Reordering/ t-Reordering timer operations | 1.0.0 |
| 2018-05 | RAN5#79 | R5-183109 | - | - | - | Update to MAC Test case - Random access procedure / Successful/ C-RNTI Based/Preamble selected by MAC itself | 1.0.0 |
| 2018-05 | RAN5#79 | R5-183111 | - | - | - | Update RLC test case - AM RLC / Re-transmission of RLC PDU with and without re-segmentation | 1.0.0 |
| 2018-05 | RAN5#79 | R5-183112 | - | - | - | Correction to MAC Test case - DRX operation / Short cycle | 1.0.0 |

| | | | | | | | |
|---------|---------|-----------|---|---|---|--|-------|
| | | | | | configured / Parameters configured by RRC | | |
| 2018-05 | RAN5#79 | R5-183113 | - | - | - | Correction to PDCP Test case - PDCP handover / Lossless handover / PDCP sequence number maintenance/PDCP status report to convey the information on missing or acknowledged PDCP SDUs at handover/ In-order delivery and duplicate elimination in the downlink | 1.0.0 |
| 2018-05 | RAN5#79 | R5-182497 | - | - | - | Corrections to RRC TC - BandwidthPart Configuration / SCG | 1.0.0 |
| 2018-05 | RAN5#79 | R5-183230 | - | - | - | Corrections to RRC TC - PSCell addition, modification and release / SCG DRB | 1.0.0 |
| 2018-05 | RAN5#79 | R5-183114 | - | - | - | Corrections to RRC TC - Bearer Modification / Handling for bearer type change with security key change | 1.0.0 |
| 2018-05 | RAN5#79 | R5-183115 | - | - | - | Corrections to RRC TC - Bearer Modification / Uplink data path / Split DRB Reconfiguration | 1.0.0 |
| 2018-05 | RAN5#79 | R5-183117 | - | - | - | Corrections to RRC TC - Measurement configuration control and reporting / Inter-RAT measurements / Event B1 / Measurement of NR cells | 1.0.0 |
| 2018-05 | RAN5#79 | R5-183116 | - | - | - | Corrections to RRC TC - RRC connection reconfiguration / PSCell addition failure | 1.0.0 |
| 2018-05 | RAN5#79 | R5-183231 | - | - | - | Corrections to RRC TC - NR SCG Failure Information / RLC-MaxNumRetx | 1.0.0 |
| 2018-05 | RAN5#79 | R5-183118 | - | - | - | Corrections to RRC TC - SCG Reconfiguration Failure / SRB3 | 1.0.0 |
| 2018-05 | RAN5#79 | R5-183119 | - | - | - | Corrections to RRC TC - SCG Reconfiguration Failure / SRB1 | 1.0.0 |
| 2018-05 | RAN5#79 | R5-182508 | - | - | - | Void RRC TC - Handover with PSCell release / SCG DRB | 1.0.0 |
| 2018-05 | RAN5#79 | R5-182509 | - | - | - | Void RRC TC - Bearer Modification / SCG DRB / Split DRB Reconfiguration | 1.0.0 |
| 2018-05 | RAN5#79 | R5-183120 | - | - | - | Correction to NR RRC test case 8.2.3.17 | 1.0.0 |
| 2018-05 | RAN5#79 | R5-183121 | - | - | - | Correction to NR RRC test case 8.2.3.19 | 1.0.0 |
| 2018-05 | RAN5#79 | R5-183228 | - | - | - | Correction to NR MAC test case 7.1.1.3.2 | 1.0.0 |
| 2018-05 | RAN5#79 | R5-183122 | - | - | - | Correction to NR PDCP test case 7.1.3.4.2 | 1.0.0 |
| 2018-05 | RAN5#79 | R5-183123 | - | - | - | Addition of new NR RRC test case 8.2.5.2.1 | 1.0.0 |
| 2018-05 | RAN5#79 | R5-183124 | - | - | - | Addition of new NR RRC test case 8.2.5.4.1 | 1.0.0 |
| 2018-05 | RAN5#79 | R5-182601 | - | - | - | Removal of NR RRC test case 8.2.2.5 | 1.0.0 |
| 2018-05 | RAN5#79 | R5-183126 | - | - | - | Addition of new 5GS RRC TC 8.2.4.3.1 | 1.0.0 |
| 2018-05 | RAN5#79 | R5-183127 | - | - | - | Addition of new NR RRC test case - Bearer Modification / Handling for bearer type change without security key change / EN-DC | 1.0.0 |
| 2018-05 | RAN5#79 | R5-182652 | - | - | - | Void RRC TC - Bearer Modification / MCG DRB / SCG DRB Reconfiguration | 1.0.0 |
| 2018-05 | RAN5#79 | R5-182774 | - | - | - | Addition of 5GS NR RRC test case 8.2.3.8.1 | 1.0.0 |
| 2018-05 | RAN5#79 | R5-183130 | - | - | - | Removal of RRC TC 8.2.4.3.1 | 1.0.0 |
| 2018-05 | RAN5#79 | R5-182798 | - | - | - | Update of 5GS NR RRC test case 8.2.3.6 | 1.0.0 |
| 2018-05 | RAN5#79 | R5-183232 | - | - | - | Addition of 5GS NR RRC test case 8.2.2.6.1 | 1.0.0 |
| 2018-05 | RAN5#79 | R5-183233 | - | - | - | Addition of 5GS NR PDCP test case 7.1.3.5.3 | 1.0.0 |
| 2018-05 | RAN5#79 | R5-183132 | - | - | - | Update of NR RRC TC - Measurement configuration control and reporting / Inter-RAT measurements / Event B1 / Measurement of NR cells / RSRQ based measurements | 1.0.0 |
| 2018-05 | RAN5#79 | R5-183133 | - | - | - | Update of NR RRC TC - Measurement configuration control and reporting / Inter-RAT measurements / Periodic reporting / Measurement of NR cells | 1.0.0 |
| 2018-05 | RAN5#79 | R5-183134 | - | - | - | Update of NR RRC TC - Measurement configuration control and reporting / Event A1 / Measurement of NR PSCell | 1.0.0 |
| 2018-05 | RAN5#79 | R5-183135 | - | - | - | Addition of NR RRC TC - PSCell addition, modification and release / Split DRB / EN-DC | 1.0.0 |
| 2018-05 | RAN5#79 | R5-183137 | - | - | - | Addition of 5GS NR RRC test case 8.2.1.1.1 | 1.0.0 |
| 2018-05 | RAN5#79 | R5-183138 | - | - | - | Addition of new NR MAC UL TBS test case 7.1.1.4.2.1 | 1.0.0 |
| 2018-05 | RAN5#79 | R5-183139 | - | - | - | Addition of new NR MAC UL TBS test case 7.1.1.4.2.2 | 1.0.0 |
| 2018-05 | RAN5#79 | R5-183140 | - | - | - | Addition of new NR MAC UL TBS test case 7.1.1.4.2.3 | 1.0.0 |
| 2018-05 | RAN5#79 | R5-183141 | - | - | - | Addition of new NR MAC UL TBS test case 7.1.1.4.2.4 | 1.0.0 |
| 2018-05 | RAN5#79 | R5-183142 | - | - | - | Addition of Layer 2 test case specific parameters | 1.0.0 |
| 2018-05 | RAN5#79 | R5-183143 | - | - | - | Correction to MAC Pre-test conditions | 1.0.0 |
| 2018-05 | RAN5#79 | R5-183144 | - | - | - | Correction to RLC Pre-test conditions | 1.0.0 |
| 2018-05 | RAN5#79 | R5-183145 | - | - | - | Correction to PDCP Pre-test conditions | 1.0.0 |
| 2018-05 | RAN5#79 | R5-183146 | - | - | - | Correction to MAC RACH Test Cases | 1.0.0 |
| 2018-05 | RAN5#79 | R5-182940 | - | - | - | Correction to MAC DL Data Transfer test cases | 1.0.0 |
| 2018-05 | RAN5#79 | R5-183147 | - | - | - | Correction to MAC UL Data Transfer test cases | 1.0.0 |
| 2018-05 | RAN5#79 | R5-183148 | - | - | - | Correction to MAC DL-SCH TBS test cases | 1.0.0 |
| 2018-05 | RAN5#79 | R5-183149 | - | - | - | Correction to RLC UM Test cases | 1.0.0 |
| 2018-05 | RAN5#79 | R5-183150 | - | - | - | Correction to RLC AM Test cases | 1.0.0 |
| 2018-05 | RAN5#79 | R5-182945 | - | - | - | Corrections to PDCP sequence number test cases | 1.0.0 |
| 2018-05 | RAN5#79 | R5-183151 | - | - | - | Correction to PDCP integrity protection test cases | 1.0.0 |
| 2018-05 | RAN5#79 | R5-182947 | - | - | - | Correction to PDCP Ciphering test cases | 1.0.0 |
| 2018-05 | RAN5#79 | R5-183152 | - | - | - | Corrections to PDCP other test cases | 1.0.0 |
| 2018-05 | RAN5#79 | R5-183153 | - | - | - | Addition of new NR RACH test case 7.1.1.1.1 | 1.0.0 |
| 2018-05 | RAN5#79 | R5-182966 | - | - | - | Correction to NR RLC test case 7.1.2.3.4 | 1.0.0 |

| | | | | | | | |
|---------|---------|-----------|------|---|---|---|--------|
| 2018-05 | RAN5#79 | R5-183154 | - | - | - | Correction to PDCP test case 7.1.3.5.2 | 1.0.0 |
| 2018-05 | RAN5#79 | R5-183155 | - | - | - | Correction to NR MAC DRX Test cases | 1.0.0 |
| 2018-05 | RAN5#79 | R5-183156 | - | - | - | Correction to NR RRC intra frequency measurement Test case 8.2.3.9 | 1.0.0 |
| 2018-05 | RAN5#79 | R5-183157 | - | - | - | Correction to NR RRC inter frequency measurement Test case 8.2.3.10 | 1.0.0 |
| 2018-05 | RAN5#79 | R5-183016 | - | - | - | Removal of NR RRC test case 8.2.3.11 | 1.0.0 |
| 2018-05 | RAN5#79 | R5-183017 | - | - | - | Removal of NR RRC test case 8.2.3.12 | 1.0.0 |
| 2018-05 | RAN5#79 | R5-183129 | - | - | - | Addition of new 5GS RRC TC 8.2.3.13.1 | 1.0.0 |
| 2018-05 | RAN5#79 | R5-183136 | - | - | - | Correction to NR RRC test case 8.2.3.5 | 1.0.0 |
| 2018-05 | RAN5#79 | R5-183263 | - | - | - | Addition of new NR NAS test case Default EPS bearer context activation | 1.0.0 |
| 2018-05 | RAN5#79 | R5-183265 | - | - | - | Updates to session management TC 10.2.2.1 | 1.0.0 |
| 2018-06 | RAN#80 | RP-181210 | - | - | - | put under revision control as v15.0.0 with small editorial changes | 15.0.0 |
| 2018-09 | RAN#81 | R5-184226 | 0010 | - | F | Addition of Correct handling of Configured UL grant Type 1 test case 7.1.1.6.2 | 15.1.0 |
| 2018-09 | RAN#81 | R5-184227 | 0011 | - | F | Addition of Correct handling of Configured UL grant Type 2 test case 7.1.1.6.3 | 15.1.0 |
| 2018-09 | RAN#81 | R5-184228 | 0012 | - | F | CR of Correct handling of DL assignment Semi persistent test case 7.1.1.6.1 | 15.1.0 |
| 2018-09 | RAN#81 | R5-184229 | 0013 | - | F | CR of UE power headroom reporting test case 7.1.1.3.7 | 15.1.0 |
| 2018-09 | RAN#81 | R5-184343 | 0020 | - | F | Correction to 5GS PDCP Test case 7.1.3.4.1 PDCP handover / Lossless handover / PDCP sequence number maintenance / PDCP status report to convey the information on missing or acknowledged PDCP SDUs at handover / In-order delivery and duplicate elimination in the downlink | 15.1.0 |
| 2018-09 | RAN#81 | R5-184344 | 0021 | - | F | Correction to 5GS PDCP Test case 7.1.3.5.4 PDCP reordering / Maximum re-ordering delay below t-Reordering / t-Reordering timer operations | 15.1.0 |
| 2018-09 | RAN#81 | R5-184353 | 0023 | - | F | Corrections to RRC TC - BandwidthPart Configuration / SCG / EN-DC | 15.1.0 |
| 2018-09 | RAN#81 | R5-184500 | 0031 | - | F | Addition of new 5GS RRC TC 8.2.4.3.1.3 | 15.1.0 |
| 2018-09 | RAN#81 | R5-184517 | 0032 | - | F | Correction to NR PDCP test case 7.1.3.4.2 | 15.1.0 |
| 2018-09 | RAN#81 | R5-184523 | 0036 | - | F | Corrections to MAC TBS test cases | 15.1.0 |
| 2018-09 | RAN#81 | R5-184527 | 0040 | - | F | Addition of new MAC test case for Reset | 15.1.0 |
| 2018-09 | RAN#81 | R5-184680 | 0055 | - | F | Update of RRC SCG failure TC 8.2.5.5.1 | 15.1.0 |
| 2018-09 | RAN#81 | R5-184681 | 0056 | - | F | Update of RRC SCG failure TC 8.2.5.6.1 | 15.1.0 |
| 2018-09 | RAN#81 | R5-184760 | 0059 | - | F | Correction to RRC TC - PSCell addition, modification and release / Split DRB / EN-DC | 15.1.0 |
| 2018-09 | RAN#81 | R5-184761 | 0060 | - | F | Correction to RRC TC - Measurement configuration control and reporting / Inter-RAT measurements / Periodic reporting / Measurement of NR cells / EN-DC | 15.1.0 |
| 2018-09 | RAN#81 | R5-184763 | 0061 | - | F | Correction to RRC TC - Measurement configuration control and reporting / Inter-RAT measurements / Event B1 / Measurement of NR cells / RSRQ based measurements / EN-DC | 15.1.0 |
| 2018-09 | RAN#81 | R5-184769 | 0063 | - | F | Update of 5GS NR RRC test case 8.2.2.6.1 | 15.1.0 |
| 2018-09 | RAN#81 | R5-185059 | 0001 | 1 | F | Correction to NR MAC test case 7.1.1.3.2 | 15.1.0 |
| 2018-09 | RAN#81 | R5-185060 | 0004 | 1 | F | Addition of Correct Handling of DL HARQ process PDSCH Aggregation test case 7.1.1.2.2 | 15.1.0 |
| 2018-09 | RAN#81 | R5-185061 | 0005 | 1 | F | Addition of NR CA reconfiguration test case 8.2.4.2.1.1 | 15.1.0 |
| 2018-09 | RAN#81 | R5-185062 | 0006 | 1 | F | Addition of NR CA reconfiguration test case 8.2.4.2.1.2 | 15.1.0 |
| 2018-09 | RAN#81 | R5-185064 | 0015 | 1 | F | Addition of 5GS NR SDAP test case 7.1.4.1 | 15.1.0 |
| 2018-09 | RAN#81 | R5-185065 | 0016 | 1 | F | Correction to 5GS MAC Test case 7.1.1.1.2 Random access procedure / Successful / C-RNTI Based / Preamble selected by MAC itself | 15.1.0 |
| 2018-09 | RAN#81 | R5-185066 | 0017 | 1 | F | Correction to 5GS MAC Test case 7.1.1.5.3 DRX operation / Short cycle configured / Parameters configured by RRC | 15.1.0 |
| 2018-09 | RAN#81 | R5-185067 | 0018 | 1 | F | Correction to 5GS RLC Test case 7.1.2.3.10 AM RLC / Re-transmission of RLC PDU with and without re-segmentation | 15.1.0 |
| 2018-09 | RAN#81 | R5-185068 | 0019 | 1 | F | Correction to 5GS RLC Test case 7.1.2.3.11 AM RLC / RLC re-establishment procedure | 15.1.0 |
| 2018-09 | RAN#81 | R5-185069 | 0022 | 1 | F | Addition of NR CA / NR SCell addition / modification / release / Success test cases 8.2.4.1.1.1, 8.2.4.1.1.2 and 8.2.4.1.1.3 | 15.1.0 |
| 2018-09 | RAN#81 | R5-185070 | 0027 | 1 | F | Corrections to RRC TC - Measurement configuration control and reporting / Inter-RAT measurements / Event B1 / Measurement of NR cells / EN-DC | 15.1.0 |
| 2018-09 | RAN#81 | R5-185071 | 0029 | 1 | F | Correction to 5GS RRC TC 8.2.4.3.1.1 | 15.1.0 |
| 2018-09 | RAN#81 | R5-185072 | 0030 | 1 | F | Addition of 5GS RRC TC 8.2.4.3.1.2 | 15.1.0 |
| 2018-09 | RAN#81 | R5-185073 | 0033 | 1 | F | Corrections to Layer 2 test cases | 15.1.0 |
| 2018-09 | RAN#81 | R5-185074 | 0034 | 1 | F | Corrections to MAC test case 7.1.2.2.1 | 15.1.0 |
| 2018-09 | RAN#81 | R5-185075 | 0035 | 1 | F | Corrections to MAC test case 7.1.2.3.1 | 15.1.0 |
| 2018-09 | RAN#81 | R5-185076 | 0037 | 1 | F | Addition of new MAC RACH test case for PDCCH order | 15.1.0 |
| 2018-09 | RAN#81 | R5-185077 | 0039 | 1 | F | Addition of new MAC test case for SCell Activation Deactivation | 15.1.0 |

| | | | | | | | |
|---------|--------|-----------|------|---|---|--|--------|
| 2018-09 | RAN#81 | R5-185078 | 0041 | 1 | F | Addition of new MAC UL TBS test case with transform precoding configured | 15.1.0 |
| 2018-09 | RAN#81 | R5-185079 | 0042 | 1 | F | Correction to default pre-test conditions for UM RLC test cases | 15.1.0 |
| 2018-09 | RAN#81 | R5-185080 | 0043 | 1 | F | New NAS test case 9.1.5.1.12 | 15.1.0 |
| 2018-09 | RAN#81 | R5-185082 | 0045 | 1 | F | Correction to NR PDCP test case 7.1.3.5.1 | 15.1.0 |
| 2018-09 | RAN#81 | R5-185083 | 0046 | 1 | F | Correction to NR RLC test case 7.1.2.3.3 and 7.1.2.3.4 | 15.1.0 |
| 2018-09 | RAN#81 | R5-185089 | 0049 | 1 | F | Corrections to RRC TC - Measurement configuration control and reporting / Inter-RAT measurements / Event B2 / Measurement of NR cells / EN-DC | 15.1.0 |
| 2018-09 | RAN#81 | R5-185090 | 0050 | 1 | F | CR of AM RLC test case 7.1.2.3.10 | 15.1.0 |
| 2018-09 | RAN#81 | R5-185091 | 0051 | 1 | F | Update of RRC SCG failure TC 8.2.5.1.1 | 15.1.0 |
| 2018-09 | RAN#81 | R5-185092 | 0052 | 1 | F | Update of RRC SCG failure TC 8.2.5.2.1 | 15.1.0 |
| 2018-09 | RAN#81 | R5-185093 | 0053 | 1 | F | Update of RRC SCG failure TC 8.2.5.3.1 | 15.1.0 |
| 2018-09 | RAN#81 | R5-185094 | 0054 | 1 | F | Update of RRC SCG failure TC 8.2.5.4.1 | 15.1.0 |
| 2018-09 | RAN#81 | R5-185095 | 0057 | 1 | F | Addition of 5GS NR SDAP test case 7.1.4.2 | 15.1.0 |
| 2018-09 | RAN#81 | R5-185096 | 0064 | 1 | F | Update of 5GS NR RRC test case 8.2.3.6.1 | 15.1.0 |
| 2018-09 | RAN#81 | R5-185097 | 0066 | 1 | F | Update of 5GS NR RRC test case 8.2.3.8.1 | 15.1.0 |
| 2018-09 | RAN#81 | R5-185098 | 0067 | 1 | F | Update of 5GS NR RRC test case 8.2.1.1.1 | 15.1.0 |
| 2018-09 | RAN#81 | R5-185099 | 0068 | 1 | F | L2 Preamble Parameter Update for Multi-PDN configuration | 15.1.0 |
| 2018-09 | RAN#81 | R5-185100 | 0069 | 1 | F | Correction to NR RLC test cases 7.1.2.2.3 and 7.1.2.2.4 | 15.1.0 |
| 2018-09 | RAN#81 | R5-185101 | 0070 | 1 | F | Correction to NR RRC test case 8.2.3.14.1 | 15.1.0 |
| 2018-09 | RAN#81 | R5-185148 | 0007 | 1 | F | Addition of NR CA reconfiguration test case 8.2.4.2.1.3 | 15.1.0 |
| 2018-09 | RAN#81 | R5-185149 | 0024 | 1 | F | Corrections to RRC TC - PSCell addition, modification and release / SCG DRB / EN-DC | 15.1.0 |
| 2018-09 | RAN#81 | R5-185150 | 0025 | 1 | F | Corrections to RRC TC - Bearer Modification / Handling for bearer type change with security key change / EN-DC | 15.1.0 |
| 2018-09 | RAN#81 | R5-185151 | 0026 | 1 | F | Corrections to RRC TC - Bearer Modification / Uplink data path / Split DRB Reconfiguration / EN-DC | 15.1.0 |
| 2018-09 | RAN#81 | R5-185152 | 0038 | 1 | F | Addition of new MAC test case for Power Headroom report | 15.1.0 |
| 2018-09 | RAN#81 | R5-185153 | 0047 | 1 | F | Addition of RRC Default Pre-test conditions for NSA | 15.1.0 |
| 2018-09 | RAN#81 | R5-185154 | 0058 | 1 | F | Correction to RRC TC - Measurement configuration control and reporting / Event A1 / Measurement of NR PSCell / EN-DC | 15.1.0 |
| 2018-09 | RAN#81 | R5-185155 | 0062 | 1 | F | Updates to NAS test case 10.2.1.2 | 15.1.0 |
| 2018-09 | RAN#81 | R5-185167 | 0071 | 1 | F | Update to EPS SM Test case for Multi-PDN | 15.1.0 |
| 2018-12 | RAN#82 | R5-186649 | 0157 | - | F | Correction to NR PDCP test case 7.1.3.5.1 | 15.2.0 |
| 2018-12 | RAN#82 | R5-186650 | 0158 | - | F | Correction to NR PDCP test case 7.1.3.5.2 | 15.2.0 |
| 2018-12 | RAN#82 | R5-186679 | 0163 | - | F | Corrections to PDCP test case 7.1.3.5.3 | 15.2.0 |
| 2018-12 | RAN#82 | R5-186725 | 0167 | - | F | Correction to 5GS test case 7.1.2.2.5 | 15.2.0 |
| 2018-12 | RAN#82 | R5-186801 | 0178 | - | F | Update RRC TC 8.2.2.2.1 - Split SRB Establishment and Release / EN-DC | 15.2.0 |
| 2018-12 | RAN#82 | R5-186802 | 0179 | - | F | Update RRC TC 8.2.2.7.1 - Bearer Modification / Handling for bearer type change without security key change / EN-DC | 15.2.0 |
| 2018-12 | RAN#82 | R5-186803 | 0180 | - | F | Update RRC TC 8.2.3.7.1 - Measurement configuration control and reporting / Event A4 (intra-frequency, inter-frequency and inter-band measurements) / Measurement of Neighbour NR cell / EN-DC | 15.2.0 |
| 2018-12 | RAN#82 | R5-186872 | 0181 | - | F | Removal of RRC SCG failure TC 8.2.5.5.1 | 15.2.0 |
| 2018-12 | RAN#82 | R5-186873 | 0182 | - | F | Removal of RRC SCG failure TC 8.2.5.6.1 | 15.2.0 |
| 2018-12 | RAN#82 | R5-186890 | 0185 | - | F | Correction to NR RRC test case 8.2.3.14.1 | 15.2.0 |
| 2018-12 | RAN#82 | R5-186891 | 0186 | - | F | Correction to NR RRC test case 8.2.3.13.1 | 15.2.0 |
| 2018-12 | RAN#82 | R5-186892 | 0187 | - | F | Correction to NR PDCP test case 7.1.3.4.2 | 15.2.0 |
| 2018-12 | RAN#82 | R5-186995 | 0228 | - | F | CR of test case 8.2.4.2_Nr CA release_Resubmission of 186101 | 15.2.0 |
| 2018-12 | RAN#82 | R5-187104 | 0229 | - | F | Correction to MAC test cases | 15.2.0 |
| 2018-12 | RAN#82 | R5-187105 | 0230 | - | F | Correction to RLC UM test cases | 15.2.0 |
| 2018-12 | RAN#82 | R5-187106 | 0231 | - | F | Correction to RLC AM test cases | 15.2.0 |
| 2018-12 | RAN#82 | R5-187236 | 0235 | - | F | Update RRC TC 8.2.1.2.1 - BandwidthPart Configuration / SCG / EN-DC | 15.2.0 |
| 2018-12 | RAN#82 | R5-187237 | 0236 | - | F | Update RRC TC 8.2.2.4.1 - PSCell addition, modification and release / SCG DRB / EN-DC | 15.2.0 |
| 2018-12 | RAN#82 | R5-187238 | 0237 | - | F | Update RRC TC 8.2.2.8.1 - Bearer Modification / Handling for bearer type change with security key change / EN-DC | 15.2.0 |
| 2018-12 | RAN#82 | R5-187239 | 0238 | - | F | Update RRC TC 8.2.2.9.1 - Bearer Modification / Uplink data path / Split DRB Reconfiguration / EN-DC | 15.2.0 |
| 2018-12 | RAN#82 | R5-187248 | 0247 | - | F | Correction to MAC Test case 7.1.1.1.2 Random access procedure / Successful / C-RNTI Based / Preamble selected by MAC itself | 15.2.0 |
| 2018-12 | RAN#82 | R5-187249 | 0248 | - | F | Correction to MAC Test case 7.1.1.5.3 DRX operation / Short cycle configured / Parameters configured by RRC | 15.2.0 |
| 2018-12 | RAN#82 | R5-187250 | 0249 | - | F | Correction to RLC Test case 7.1.2.3.10 AM RLC / Re-transmission of RLC PDU with and without re-segmentation | 15.2.0 |
| 2018-12 | RAN#82 | R5-187251 | 0250 | - | F | Correction to RLC Test case 7.1.2.3.11 AM RLC / RLC re-establishment procedure | 15.2.0 |
| 2018-12 | RAN#82 | R5-187252 | 0251 | - | F | Correction to PDCP Test case 7.1.3.4.1 PDCP handover / Lossless handover / PDCP sequence number maintenance / PDCP status report to convey the information on missing or acknowledged PDCP | 15.2.0 |

| | | | | | | | |
|---------|--------|-----------|------|---|---|--|--------|
| | | | | | | SDUs at handover / In-order delivery and duplicate elimination | |
| 2018-12 | RAN#82 | R5-187254 | 0253 | - | F | Update RRC TCs 8.2.4.1.1.1, 8.2.4.1.1.2 and 8.2.4.1.1.3 NR CA / NR SCell addition / modification / release / Success | 15.2.0 |
| 2018-12 | RAN#82 | R5-187255 | 0254 | - | F | Correction to EN-DC NAS test case 10.2.1.1 - Default EPS bearer context activation | 15.2.0 |
| 2018-12 | RAN#82 | R5-187302 | 0260 | - | F | Correction to test case 8.2.4.3.1.1 | 15.2.0 |
| 2018-12 | RAN#82 | R5-187410 | 0273 | - | F | Update of 5GS NR RRC test case 8.2.2.6.1 | 15.2.0 |
| 2018-12 | RAN#82 | R5-187411 | 0274 | - | F | Addition of 5GS NR MAC test case 7.1.1.3.9 | 15.2.0 |
| 2018-12 | RAN#82 | R5-187492 | 0278 | - | F | Correction to test case 8.2.2.1.1 | 15.2.0 |
| 2018-12 | RAN#82 | R5-187497 | 0279 | - | F | Correction to test case 8.2.2.3.1 | 15.2.0 |
| 2018-12 | RAN#82 | R5-187528 | 0285 | - | F | Update to RRC TC - PSCell addition, modification and release / Split DRB / EN-DC | 15.2.0 |
| 2018-12 | RAN#82 | R5-187530 | 0286 | - | F | Update to RRC TC - Measurement configuration control and reporting / Inter-RAT measurements / Event B1 / Measurement of NR cells / RSRQ based measurements / EN-DC | 15.2.0 |
| 2018-12 | RAN#82 | R5-187534 | 0287 | - | F | Update to RRC TC - Measurement configuration control and reporting / Inter-RAT measurements / Periodic reporting / Measurement of NR cells / EN-DC | 15.2.0 |
| 2018-12 | RAN#82 | R5-187540 | 0290 | - | F | Update to 5G-NR RRC TCs for Multi-PDN support and specific message content IEs | 15.2.0 |
| 2018-12 | RAN#82 | R5-187611 | 0294 | - | F | Correction to MAC TBS test cases | 15.2.0 |
| 2018-12 | RAN#82 | R5-187686 | 0283 | 1 | F | Adding test case 6.1.1.7 | 15.2.0 |
| 2018-12 | RAN#82 | R5-187688 | 0202 | 1 | F | Addition of NR test case 7.1.1.1.3_Sl Request | 15.2.0 |
| 2018-12 | RAN#82 | R5-187689 | 0203 | 1 | F | Addition of NR test case 7.1.1.1.6_Random access | 15.2.0 |
| 2018-12 | RAN#82 | R5-187690 | 0204 | 1 | F | Addition of NR test case 7.1.1.2.3_CCCH HARQ | 15.2.0 |
| 2018-12 | RAN#82 | R5-187691 | 0213 | 1 | F | CR of NR test case 7.1.2.3.9_RLC Reassembling | 15.2.0 |
| 2018-12 | RAN#82 | R5-187692 | 0252 | 1 | F | Correction to PDCP Test case 7.1.3.5.4 PDCP reordering / Maximum re-ordering delay below t-Reordering / t-Reordering timer operations | 15.2.0 |
| 2018-12 | RAN#82 | R5-187693 | 0234 | 1 | F | Correction to SDAP test cases | 15.2.0 |
| 2018-12 | RAN#82 | R5-187695 | 0243 | 1 | F | Addition of 5GS SA RRC TC 8.1.1.1.1 | 15.2.0 |
| 2018-12 | RAN#82 | R5-187696 | 0246 | 1 | F | Addition of 5GS SA RRC TC 8.1.5.2.1 | 15.2.0 |
| 2018-12 | RAN#82 | R5-187698 | 0159 | 1 | F | Correction to NR RRC test case 8.2.3.5.1 | 15.2.0 |
| 2018-12 | RAN#82 | R5-187699 | 0160 | 1 | F | Correction to NR RRC test case 8.2.3.9.1 and 8.2.3.10.1 | 15.2.0 |
| 2018-12 | RAN#82 | R5-187700 | 0239 | 1 | F | Update RRC TC 8.2.3.1.1 - Measurement configuration control and reporting / Inter-RAT measurements / Event B1 / Measurement of NR cells / EN-DC | 15.2.0 |
| 2018-12 | RAN#82 | R5-187701 | 0272 | 1 | F | Update RRC TC 8.2.3.12.1 | 15.2.0 |
| 2018-12 | RAN#82 | R5-187702 | 0276 | 1 | F | Update of 5GS NR RRC test case 8.2.3.6.1 | 15.2.0 |
| 2018-12 | RAN#82 | R5-187703 | 0277 | 1 | F | Update of 5GS NR RRC test case 8.2.3.8.1 | 15.2.0 |
| 2018-12 | RAN#82 | R5-187704 | 0288 | 1 | F | Update to RRC TC - Measurement configuration control and reporting / Event A1 / Measurement of NR PSCell / EN-DC | 15.2.0 |
| 2018-12 | RAN#82 | R5-187705 | 0289 | 1 | F | Update to 5G-NR RRC measurement report TCs for FR1/FR2 cell power level | 15.2.0 |
| 2018-12 | RAN#82 | R5-187706 | 0168 | 1 | F | Updates to EN-DC TC 8.2.5.3.1 | 15.2.0 |
| 2018-12 | RAN#82 | R5-187707 | 0140 | 1 | F | Corrections to NAS test case 9.1.5.1.14 | 15.2.0 |
| 2018-12 | RAN#82 | R5-187778 | 0284 | 1 | F | Adding test case 6.1.1.8 | 15.2.0 |
| 2018-12 | RAN#82 | R5-187779 | 0226 | 1 | F | Addition of NR test case 7.1.1.1.4_Beam Failure | 15.2.0 |
| 2018-12 | RAN#82 | R5-187780 | 0227 | 1 | F | Addition of NR test case 7.1.1.1.5 SUL | 15.2.0 |
| 2018-12 | RAN#82 | R5-187781 | 0281 | 1 | F | Correction to NR MAC test case 7.1.1.3.2 | 15.2.0 |
| 2018-12 | RAN#82 | R5-187782 | 0291 | 1 | F | Addition of 5GS NR MAC test case 7.1.1.8.1 | 15.2.0 |
| 2018-12 | RAN#82 | R5-187784 | 0184 | 1 | F | Correction to the default Pre-Test Conditions for AM and UM RLC test cases | 15.2.0 |
| 2018-12 | RAN#82 | R5-187785 | 0232 | 1 | F | Correction to PDCP Ciphering test cases | 15.2.0 |
| 2018-12 | RAN#82 | R5-187786 | 0233 | 1 | F | Correction to PDCP Integrity test cases | 15.2.0 |
| 2018-12 | RAN#82 | R5-187787 | 0216 | 1 | F | Addition of NR test case 8.1.1.2.3_T300 expiry | 15.2.0 |
| 2018-12 | RAN#82 | R5-187789 | 0245 | 1 | F | Addition of 5GS SA RRC TC 8.1.1.2.5 | 15.2.0 |
| 2018-12 | RAN#82 | R5-187790 | 0275 | 1 | F | Addition of 5GS NR RRC test case 8.1.1.3.2 | 15.2.0 |
| 2018-12 | RAN#82 | R5-187792 | 0224 | 1 | F | Addition of NR test case 8.2.3.11.1_gapFR1 | 15.2.0 |
| 2018-12 | RAN#82 | R5-187794 | 0221 | 1 | F | Addition of NR test case 8.1.5.3.1_PWS notification | 15.2.0 |
| 2018-12 | RAN#82 | R5-187795 | 0240 | 1 | F | Update RRC SCG failure TC 8.2.5.1.1 | 15.2.0 |
| 2018-12 | RAN#82 | R5-187797 | 0263 | 1 | F | Addition of new 5GC TC 9.1.6.1.1 | 15.2.0 |
| 2018-12 | RAN#82 | R5-188159 | 0222 | 2 | F | Addition of NR test case 9.1.5.1.1_Registration Request | 15.2.0 |
| 2018-12 | RAN#82 | R5-188187 | 0296 | - | F | Correction to NR MAC DRX test cases 7.1.1.5.1 and 7.1.1.5.2 | 15.2.0 |
| 2018-12 | RAN#82 | R5-188188 | 0217 | 2 | F | Addition of NR test case 8.1.1.3.1_Redirection to NR | 15.2.0 |
| 2018-12 | RAN#82 | R5-188190 | 0225 | 2 | F | Addition of NR test case 8.2.3.11.2_gapFR2 | 15.2.0 |
| 2019-01 | RAN#82 | R5-188192 | 0205 | 2 | F | Addition of NR test case 7.1.1.2.4_BCCH HARQ | 15.2.1 |
| 2019-01 | RAN#82 | R5-188193 | 0295 | 2 | F | Correction to Layer 2 Pre Test Conditions | 15.2.1 |
| 2019-01 | RAN#82 | R5-188194 | 0218 | 2 | F | Addition of NR test case 8.1.3.1.1_Event A1 | 15.2.1 |
| 2019-01 | RAN#82 | R5-188195 | 0183 | 2 | F | Update to 5G TC TA registration update | 15.2.1 |
| 2019-01 | RAN#82 | R5-188202 | 0280 | 2 | F | Update of 5GS NR RRC test case 8.2.1.1.1 | 15.2.1 |
| 2019-03 | RAN#83 | R5-191197 | 0421 | - | F | Correction to 5GS RLC Test case 7.1.2.2.5 | 15.3.0 |

| | | | | | | | |
|---------|--------|-----------|------|---|---|--|--------|
| 2019-03 | RAN#83 | R5-191198 | 0422 | - | F | Correction to 5GS RLC Test case 7.1.2.3.8 | 15.3.0 |
| 2019-03 | RAN#83 | R5-191199 | 0423 | - | F | Correction to 5GS RLC Test case 7.1.2.3.9 | 15.3.0 |
| 2019-03 | RAN#83 | R5-191200 | 0424 | - | F | Correction to EN-DC RRC test case 8.2.5.3.1 | 15.3.0 |
| 2019-03 | RAN#83 | R5-191202 | 0426 | - | F | Correction to 5GS RLC Test case 7.1.2.3.10 | 15.3.0 |
| 2019-03 | RAN#83 | R5-191203 | 0427 | - | F | Correction to EN-DC RRC test case 8.2.2.2.1 | 15.3.0 |
| 2019-03 | RAN#83 | R5-191353 | 0431 | - | F | Correcting test case 7.1.1.3.1 | 15.3.0 |
| 2019-03 | RAN#83 | R5-191393 | 0445 | - | F | Correction to NR test case 7.1.1.1.6-Random access procedure | 15.3.0 |
| 2019-03 | RAN#83 | R5-191397 | 0449 | - | F | Correction to NR test case 7.1.2.3.9-RLC Reassembling | 15.3.0 |
| 2019-03 | RAN#83 | R5-191403 | 0455 | - | F | Correction to NR test case 8.1.3.1.1-Event A1 and A2 | 15.3.0 |
| 2019-03 | RAN#83 | R5-191405 | 0457 | - | F | Correction to NR test case 8.2.3.1.1.2-ENDC measurement gap FR2 | 15.3.0 |
| 2019-03 | RAN#83 | R5-191415 | 0466 | - | F | Addition of TC 8.1.3.2.3-inter-RAT measurement B2 RSRQ | 15.3.0 |
| 2019-03 | RAN#83 | R5-191426 | 0475 | - | F | Addition of NR test case 6.1.2.4-Cell Reselection for interband operation | 15.3.0 |
| 2019-03 | RAN#83 | R5-191427 | 0476 | - | F | Addition of NR test case 6.1.2.5-Cell Reselection for interband operation using Pcompensation Between FDD and TDD | 15.3.0 |
| 2019-03 | RAN#83 | R5-191430 | 0479 | - | F | Addition of NR test case 6.1.2.21-Cell reselection, SIntra SearchQ and SnonIntraSearchQ | 15.3.0 |
| 2019-03 | RAN#83 | R5-191431 | 0480 | - | F | Addition of NR test case 6.1.2.22-Inter-frequency cell reselection with parameters ThreshX, HighQ, ThreshX, LowQ and ThreshServing, LowQ | 15.3.0 |
| 2019-03 | RAN#83 | R5-191432 | 0481 | - | F | Correction to NR test case 7.1.1.3.7-Power Headroom Reporting | 15.3.0 |
| 2019-03 | RAN#83 | R5-191433 | 0482 | - | F | Correction to NR test case 7.1.1.6.1-Correct handling of DL assignment Semi persistent | 15.3.0 |
| 2019-03 | RAN#83 | R5-191434 | 0483 | - | F | Addition of NR test case 8.1.1.1.2-Paging | 15.3.0 |
| 2019-03 | RAN#83 | R5-191435 | 0484 | - | F | Correction to NR test case 8.1.1.2.1-T300 expiry | 15.3.0 |
| 2019-03 | RAN#83 | R5-191436 | 0485 | - | F | Addition of NR test case 8.1.5.3.3-PWS notification | 15.3.0 |
| 2019-03 | RAN#83 | R5-191445 | 0494 | - | F | Correction to NR test case 9.1.5.1.1-Initial Registration | 15.3.0 |
| 2019-03 | RAN#83 | R5-191447 | 0495 | - | F | Addition of NR test case 8.1.3.1.5-Two event A3 RSRQ | 15.3.0 |
| 2019-03 | RAN#83 | R5-191448 | 0496 | - | F | Addition of NR test case 8.1.3.1.6 Two event A5 SINR | 15.3.0 |
| 2019-03 | RAN#83 | R5-191449 | 0497 | - | F | Correction to NR test case 8.1.5.3.1-ETWS | 15.3.0 |
| 2019-03 | RAN#83 | R5-191509 | 0504 | - | F | Addition of new RRC TC 8.1.5.3.2 | 15.3.0 |
| 2019-03 | RAN#83 | R5-191621 | 0514 | - | F | Update of 5GS NR RRC test case 8.1.1.3.2 | 15.3.0 |
| 2019-03 | RAN#83 | R5-191641 | 0523 | - | F | Updates to 5GS SA RRC TC - RRC / Paging for connection / Multiple paging records | 15.3.0 |
| 2019-03 | RAN#83 | R5-191642 | 0524 | - | F | Updates to 5GS SA RRC TC - RRC connection establishment / RRC Reject with wait time | 15.3.0 |
| 2019-03 | RAN#83 | R5-191643 | 0525 | - | F | Updates to 5GS SA RRC TC - SI change / Notification of BCCH modification / Short message for SI update | 15.3.0 |
| 2019-03 | RAN#83 | R5-191651 | 0530 | - | F | Update EN-DC RRC TC 8.2.2.4.1 | 15.3.0 |
| 2019-03 | RAN#83 | R5-191652 | 0531 | - | F | Update EN-DC RRC TC 8.2.2.8.1 | 15.3.0 |
| 2019-03 | RAN#83 | R5-191653 | 0532 | - | F | Update EN-DC RRC TC 8.2.2.9.1 | 15.3.0 |
| 2019-03 | RAN#83 | R5-191654 | 0533 | - | F | Update EN-DC RRC TC 8.2.4.1.1.1 | 15.3.0 |
| 2019-03 | RAN#83 | R5-191656 | 0535 | - | F | Update EN-DC RRC TC 8.2.5.3.1 | 15.3.0 |
| 2019-03 | RAN#83 | R5-191660 | 0539 | - | F | Addition of 5GC TC- PDU session authentication and authorization / during the UE-requested PDU session procedure | 15.3.0 |
| 2019-03 | RAN#83 | R5-191661 | 0540 | - | F | Addition of Idle Mode TC - Steering of UE in roaming during registration/security check successful using List Type 1 | 15.3.0 |
| 2019-03 | RAN#83 | R5-191663 | 0542 | - | F | Addition of Idle mode Test Case - PLMN selection of RPLMN, HPLMN/EHPLMN, UPLMN and OPLMN / Automatic mode | 15.3.0 |
| 2019-03 | RAN#83 | R5-191733 | 0546 | - | F | Update RRC TC 8.2.2.1.1 - SRB3 Establishment, Reconfiguration and Release / NR addition, modification and release / EN-DC | 15.3.0 |
| 2019-03 | RAN#83 | R5-191764 | 0550 | - | F | Addition of new TC 8.2.3.15 | 15.3.0 |
| 2019-03 | RAN#83 | R5-191804 | 0552 | - | F | Title correction to MAC TC 7.1.1.7.1.1 | 15.3.0 |
| 2019-03 | RAN#83 | R5-191806 | 0553 | - | F | Addition of new RRC TC 8.1.1.4.3 | 15.3.0 |
| 2019-03 | RAN#83 | R5-191810 | 0554 | - | F | Addition of new 5GC TC 9.1.5.2.9 | 15.3.0 |
| 2019-03 | RAN#83 | R5-191823 | 0555 | - | F | Addition of new 5GC TC 9.1.6.1.4 | 15.3.0 |
| 2019-03 | RAN#83 | R5-191827 | 0556 | - | F | Addition of new RRC TC 8.1.1.4.2 | 15.3.0 |
| 2019-03 | RAN#83 | R5-191859 | 0559 | - | F | Addition of new 5G-NR Idle Mode TC 6.1.1.6 - PLMN selection / Periodic reselection / MinimumPeriodicSearchTimer | 15.3.0 |
| 2019-03 | RAN#83 | R5-191869 | 0561 | - | F | Update to 5G-NR RRC Measurement configuration and reporting TC 8.2.3.3.1 | 15.3.0 |
| 2019-03 | RAN#83 | R5-191877 | 0562 | - | F | Update to 5G-NR RRC Measurement configuration and reporting TC 8.2.3.4.1 | 15.3.0 |
| 2019-03 | RAN#83 | R5-191897 | 0570 | - | F | Update to TC 8.2.5.4.1 SCG change failure / EN-DC | 15.3.0 |
| 2019-03 | RAN#83 | R5-191898 | 0571 | - | F | Editorial update to TC 7.1.3.2.1 | 15.3.0 |
| 2019-03 | RAN#83 | R5-191911 | 0574 | - | F | Correction to MAC TBS test cases | 15.3.0 |
| 2019-03 | RAN#83 | R5-191916 | 0577 | - | F | Introduction of Non 3GPP Access over WLAN test cases | 15.3.0 |
| 2019-03 | RAN#83 | R5-192203 | 0587 | - | F | Update to 5G-NR RRC Measurement configuration and reporting TCs 8.2.3.x.x | 15.3.0 |
| 2019-03 | RAN#83 | R5-192222 | 0589 | - | F | Correction to NR RRC test case 8.2.3.5.1 | 15.3.0 |
| 2019-03 | RAN#83 | R5-192282 | 0429 | 1 | F | Addition of new 5G-NR Idle Mode TC 6.1.2.19 - Speed-dependent cell reselection | 15.3.0 |
| 2019-03 | RAN#83 | R5-192283 | 0440 | 1 | F | Addition of NR test case 6.1.2.15-Cell reselection in shared network | 15.3.0 |

| | | | | | | environment | |
|---------|--------|-----------|------|---|---|---|--------|
| 2019-03 | RAN#83 | R5-192284 | 0441 | 1 | F | Addition of NR test case 6.1.2.17-Cell reselection | 15.3.0 |
| 2019-03 | RAN#83 | R5-192285 | 0541 | 1 | F | Addition of Idle mode Test Case 6.1.2.7: Cell reselection / Equivalent PLMN | 15.3.0 |
| 2019-03 | RAN#83 | R5-192286 | 0446 | 1 | F | Correction to NR test case 7.1.1.5.4-CDRX | 15.3.0 |
| 2019-03 | RAN#83 | R5-192287 | 0447 | 1 | F | Correction to NR test case 7.1.1.6.2-Configured grant Type 1 | 15.3.0 |
| 2019-03 | RAN#83 | R5-192288 | 0448 | 1 | F | Correction to NR test case 7.1.1.6.3-Configured grant Type 2 | 15.3.0 |
| 2019-03 | RAN#83 | R5-192289 | 0548 | 1 | F | Addition of a new test purpose to TC 7.1.1.2.1 and TC 7.1.1.3.1 for a TDD-UL-DL-ConfigCommon including pattern2 | 15.3.0 |
| 2019-03 | RAN#83 | R5-192291 | 0575 | 1 | F | Reduction of loops in MAC TBS test cases | 15.3.0 |
| 2019-03 | RAN#83 | R5-192293 | 0565 | 1 | F | Correction to 5GS RLC Test case 7.1.2.3.11 | 15.3.0 |
| 2019-03 | RAN#83 | R5-192296 | 0536 | 1 | F | Correction to PDCP Test case 7.1.3.4.1 PDCP handover / Lossless handover / PDCP sequence number maintenance / PDCP status report to convey the information on missing or acknowledged PDCP SDUs at handover / In-order delivery and duplicate elimination in th | 15.3.0 |
| 2019-03 | RAN#83 | R5-192297 | 0544 | 1 | F | Correction to SDAP Test Cases | 15.3.0 |
| 2019-03 | RAN#83 | R5-192298 | 0451 | 1 | F | Addition of NR test case 8.1.1.3.4-RRCRelease with priority information of E-UTRA | 15.3.0 |
| 2019-03 | RAN#83 | R5-192299 | 0526 | 1 | F | Addition of 5GS SA RRC TC - RRC connection release / With priority information / T320 expiry | 15.3.0 |
| 2019-03 | RAN#83 | R5-192300 | 0527 | 1 | F | Addition of 5GS SA RRC TC - RRC connection release / With priority information / T320 expiry / E-UTRA | 15.3.0 |
| 2019-03 | RAN#83 | R5-192301 | 0528 | 1 | F | Addition of 5GS SA RRC TC - RRC resume / Suspend-Resume / Success | 15.3.0 |
| 2019-03 | RAN#83 | R5-192302 | 0588 | 1 | F | Addition of 5GS SA RRC TC - 8.1.2.1.1 | 15.3.0 |
| 2019-03 | RAN#83 | R5-192303 | 0590 | 1 | F | Addition of 5GS SA RRC TC - 8.1.2.1.3 | 15.3.0 |
| 2019-03 | RAN#83 | R5-192304 | 0591 | 1 | F | Addition of 5GS SA RRC TC - 8.1.5.3.4 | 15.3.0 |
| 2019-03 | RAN#83 | R5-192307 | 0557 | 1 | F | Update ENDC TC 8.2.2.3.1 | 15.3.0 |
| 2019-03 | RAN#83 | R5-192308 | 0420 | 1 | F | Update to 5G-NR RRC Measurement configuration and reporting TC 8.2.3.2.1 | 15.3.0 |
| 2019-03 | RAN#83 | R5-192329 | 0456 | 1 | F | Correction to NR test case 8.2.3.11.1-ENDC measurement gap FR1 | 15.3.0 |
| 2019-03 | RAN#83 | R5-192330 | 0428 | 1 | F | Correction to NR RRC test case 8.2.3.13.1 | 15.3.0 |
| 2019-03 | RAN#83 | R5-192331 | 0579 | 1 | F | Correction to NR RRC test case 8.2.3.12.1 | 15.3.0 |
| 2019-03 | RAN#83 | R5-192332 | 0581 | 1 | F | Correction to NR RRC test case 8.2.3.14.1 | 15.3.0 |
| 2019-03 | RAN#83 | R5-192333 | 0582 | 1 | F | Correction to NR RRC test case 8.2.3.1.1 | 15.3.0 |
| 2019-03 | RAN#83 | R5-192334 | 0596 | 1 | F | Correction to NR RRC test case 8.2.3.9.1 and 8.2.3.10.1 | 15.3.0 |
| 2019-03 | RAN#83 | R5-192339 | 0534 | 1 | F | Update EN-DC RRC TC 8.2.5.1.1 | 15.3.0 |
| 2019-03 | RAN#83 | R5-192340 | 0506 | 1 | F | Update to 5G testcase 9.1.5.1.14 | 15.3.0 |
| 2019-03 | RAN#83 | R5-192341 | 0572 | 1 | F | Update to 5G TC 9.1.5.2.1 TA registration update | 15.3.0 |
| 2019-03 | RAN#83 | R5-192342 | 0543 | 1 | F | Correction to EN-DC NAS test case 10.2.1.1 - Default EPS bearer context activation | 15.3.0 |
| 2019-03 | RAN#83 | R5-192343 | 0537 | 1 | F | Addition of 5GC TC SMS over NAS service | 15.3.0 |
| 2019-03 | RAN#83 | R5-192383 | 0459 | 1 | F | Addition of NR test case 9.1.5.1.10-PLMN not allowed | 15.3.0 |
| 2019-03 | RAN#83 | R5-192385 | 0498 | 1 | F | Addition of new 5GC TC 9.1.7.1 | 15.3.0 |
| 2019-03 | RAN#83 | R5-192386 | 0502 | 1 | F | Addition of new 5GC TC 9.1.5.1.11 | 15.3.0 |
| 2019-03 | RAN#83 | R5-192387 | 0503 | 1 | F | Addition of new 5GC TC 9.1.5.1.12 | 15.3.0 |
| 2019-03 | RAN#83 | R5-192388 | 0507 | 1 | F | Addition of 5G testcase 9.1.5.1.4 | 15.3.0 |
| 2019-03 | RAN#83 | R5-192389 | 0508 | 1 | F | Addition of 5G testcase 9.1.3.1 | 15.3.0 |
| 2019-03 | RAN#83 | R5-192390 | 0538 | 1 | F | Addition of 5GC TC - Initial registration / 5GS services / NSSAI handling | 15.3.0 |
| 2019-03 | RAN#83 | R5-192391 | 0545 | 1 | F | Addition of new 5GC TC 9.1.5.1.5 | 15.3.0 |
| 2019-03 | RAN#83 | R5-192392 | 0547 | 1 | F | Introduction of TC 9.1.1.1 EAP based primary authentication and key agreement | 15.3.0 |
| 2019-03 | RAN#83 | R5-192393 | 0549 | 1 | F | Introduction of TC 9.1.1.3 EAP based primary authentication and key agreement | 15.3.0 |
| 2019-03 | RAN#83 | R5-192394 | 0558 | 1 | F | Addition of new 5GC TC 9.1.5.1.7 | 15.3.0 |
| 2019-03 | RAN#83 | R5-192396 | 0564 | 1 | F | Addition of new 5GC TC 9.1.5.1.8 | 15.3.0 |
| 2019-03 | RAN#83 | R5-192397 | 0566 | 1 | F | Update TC 9.1.6.1.1 | 15.3.0 |
| 2019-03 | RAN#83 | R5-192398 | 0573 | 1 | F | Introduction of TC 9.1.5.2.4 Mobility registration update / The lower layer requests NAS signalling connection recovery | 15.3.0 |
| 2019-03 | RAN#83 | R5-192399 | 0580 | 1 | F | New 5GC test case 9.1.2.2 | 15.3.0 |
| 2019-03 | RAN#83 | R5-192700 | 0499 | 1 | F | Addition of new 5GC TC 10.1.3.2 | 15.3.0 |
| 2019-03 | RAN#83 | R5-192701 | 0500 | 1 | F | Addition of new 5GC TC 10.1.6.1 | 15.3.0 |
| 2019-03 | RAN#83 | R5-192702 | 0501 | 1 | F | Addition of new 5GC TC 10.1.6.2 | 15.3.0 |
| 2019-03 | RAN#83 | R5-192703 | 0563 | 1 | F | Addition of new 5GC TC 10.1.2.2 | 15.3.0 |
| 2019-03 | RAN#83 | R5-192749 | 0474 | 1 | F | Addition of NR test case 6.1.2.2-Cell selection based on Qqualmin | 15.3.0 |
| 2019-03 | RAN#83 | R5-192750 | 0432 | 1 | F | Correcting test case 6.1.1.7 | 15.3.0 |
| 2019-03 | RAN#83 | R5-192751 | 0433 | 1 | F | Updating test case 6.1.1.8 | 15.3.0 |
| 2019-03 | RAN#83 | R5-192754 | 0599 | - | F | Addition of NR test case 6.1.2.1-Cell selection based on Qrxlevmin and Cell Reselection for Intra Frequency | 15.3.0 |
| 2019-03 | RAN#83 | R5-192756 | 0600 | - | F | Addition of NR test case 6.1.2.3-Cell selection-Serving cell bar | 15.3.0 |
| 2019-03 | RAN#83 | R5-192757 | 0470 | 1 | F | Addition of NR test case 6.1.1.2- PLMN selection of Other PLMN | 15.3.0 |

| | | | | | | | |
|---------|--------|-----------|------|---|---|---|--------|
| 2019-03 | RAN#83 | R5-192758 | 0471 | 1 | F | Addition of NR test case 6.1.1.3-Cell reselection of ePLMN | 15.3.0 |
| 2019-03 | RAN#83 | R5-192759 | 0473 | 1 | F | Addition of NR test case 6.1.1.5-PLMN selection | 15.3.0 |
| 2019-03 | RAN#83 | R5-192760 | 0477 | 1 | F | Addition of NR test case 6.1.2.9-Cell Reselection using Qhyst, Qoffset and Treselection | 15.3.0 |
| 2019-03 | RAN#83 | R5-192761 | 0478 | 1 | F | Addition of NR test case 6.1.2.20-Inter-frequency cell reselection according to priority | 15.3.0 |
| 2019-03 | RAN#83 | R5-192762 | 0509 | 1 | F | Adding test case 6.2.1.2 | 15.3.0 |
| 2019-03 | RAN#83 | R5-192763 | 0510 | 1 | F | Adding test case 6.2.1.1 | 15.3.0 |
| 2019-03 | RAN#83 | R5-192764 | 0511 | 1 | F | Adding test case 6.2.1.3 | 15.3.0 |
| 2019-03 | RAN#83 | R5-192765 | 0512 | 1 | F | Adding test case 6.2.1.4 | 15.3.0 |
| 2019-03 | RAN#83 | R5-192766 | 0513 | 1 | F | Adding test case 6.2.1.5 | 15.3.0 |
| 2019-03 | RAN#83 | R5-192767 | 0592 | 1 | F | Addition of Idle Mode test case 6.1.2.8 | 15.3.0 |
| 2019-03 | RAN#83 | R5-192768 | 0472 | 1 | F | Addition of NR test case 6.1.1.4-PLMN selection in shared network environment | 15.3.0 |
| 2019-03 | RAN#83 | R5-192769 | 0444 | 1 | F | Correction to NR test case 7.1.1.1.3-SI request | 15.3.0 |
| 2019-03 | RAN#83 | R5-192770 | 0585 | 1 | F | Update to NR MAC Bandwidth Part operation TC 7.1.1.8.1 | 15.3.0 |
| 2019-03 | RAN#83 | R5-192771 | 0521 | 1 | F | Correction to 5GS PDCP Test case 7.1.3.5.3 PDCP Data Recovery | 15.3.0 |
| 2019-03 | RAN#83 | R5-192772 | 0450 | 1 | F | Addition of NR test case 8.1.1.3.3-RRC connection release-Success-With priority information | 15.3.0 |
| 2019-03 | RAN#83 | R5-192774 | 0453 | 1 | F | Addition of NR test case 8.1.4.2.2.1-L2NR handover success | 15.3.0 |
| 2019-03 | RAN#83 | R5-192776 | 0464 | 1 | F | Addition of TC 8.1.3.2.1-Event B1 E-UTRA | 15.3.0 |
| 2019-03 | RAN#83 | R5-192777 | 0465 | 1 | F | Addition of TC 8.1.3.2.2-Event B2 E-UTRA | 15.3.0 |
| 2019-03 | RAN#83 | R5-192782 | 0488 | 1 | F | Addition of NR test case 8.1.3.1.11.1_intra-band Contiguous CA Event A6 | 15.3.0 |
| 2019-03 | RAN#83 | R5-192783 | 0489 | 1 | F | Addition of NR test case 8.1.3.1.11.2_inter-band CA Event A6 | 15.3.0 |
| 2019-03 | RAN#83 | R5-192784 | 0490 | 1 | F | Addition of NR test case 8.1.3.1.11.3_intra-band non Contiguous CA Event A6 | 15.3.0 |
| 2019-03 | RAN#83 | R5-192785 | 0491 | 1 | F | Addition of NR test case 8.1.3.1.12.1_ Additional intra-band Contiguous CA | 15.3.0 |
| 2019-03 | RAN#83 | R5-192786 | 0492 | 1 | F | Addition of NR test case 8.1.3.1.12.2_ Additional inter-band CA | 15.3.0 |
| 2019-03 | RAN#83 | R5-192787 | 0493 | 1 | F | Addition of NR test case 8.1.3.1.12.3_ Additional intra-band non Contiguous CA | 15.3.0 |
| 2019-03 | RAN#83 | R5-192794 | 0516 | 1 | F | Addition of 5GS NR RRC test case 8.1.5.1.1 | 15.3.0 |
| 2019-03 | RAN#83 | R5-192795 | 0586 | 1 | F | Addition of TC 8.1.4.2.1.1 Inter-RAT handover / From NR to E-UTRA | 15.3.0 |
| 2019-03 | RAN#83 | R5-192796 | 0598 | 1 | F | New RRC test case 8.1.5.2.2 SI change / Notification of BCCH modification / Short message for SI update in NR RRC_CONNECTED state | 15.3.0 |
| 2019-03 | RAN#83 | R5-192798 | 0425 | 1 | F | Update to EN-DC test case 8.2.3.7.1 | 15.3.0 |
| 2019-03 | RAN#83 | R5-192800 | 0435 | 1 | F | Addition of 5GC test case 9.1.1.2 | 15.3.0 |
| 2019-03 | RAN#83 | R5-192801 | 0458 | 1 | F | Addition of NR test case 9.1.1.6-Authentication abnormal | 15.3.0 |
| 2019-03 | RAN#83 | R5-192802 | 0460 | 1 | F | Addition of NR test case 9.1.6.1.2-T3521 timeout | 15.3.0 |
| 2019-03 | RAN#83 | R5-192803 | 0461 | 1 | F | Addition of NR test case 9.1.6.2.1-Network-initiated deregistration-deregistration for 3GPP access-reregistration required | 15.3.0 |
| 2019-03 | RAN#83 | R5-192805 | 0463 | 1 | F | Addition of NR test case 9.1.7.2-Service request for user data pending | 15.3.0 |
| 2019-03 | RAN#83 | R5-192806 | 0568 | 1 | F | Addition of new 5GC TC 9.1.5.2.2 | 15.3.0 |
| 2019-03 | RAN#83 | R5-192815 | 0567 | 1 | F | Addition of new 5GC TC 9.1.2.1 | 15.3.0 |
| 2019-03 | RAN#83 | R5-192816 | 0569 | 1 | F | Addition of 5GC Test case 10.1.5.1 | 15.3.0 |
| 2019-03 | RAN#83 | R5-192819 | 0576 | 2 | F | Update of 5GS NR MAC test case 7.1.1.9.1 | 15.3.0 |
| 2019-03 | RAN#83 | R5-192824 | 0560 | 2 | F | Addition of new 5GC TC 9.1.5.1.13 | 15.3.0 |
| 2019-03 | RAN#83 | R5-192829 | 0517 | 2 | F | Update of 5GS NR RRC test case 8.2.1.1.1 | 15.3.0 |
| 2019-03 | RAN#83 | R5-192830 | 0595 | 2 | F | Addition of 5GS PDCP TC 7.1.3.5.5 | 15.3.0 |
| 2019-03 | RAN#83 | R5-192838 | 0603 | - | F | Addition of 5GS SA RRC TC - 8.1.3.1.13 | 15.3.0 |
| 2019-03 | RAN#83 | R5-192839 | 0604 | - | F | Addition of 5GS SA RRC TC - 8.1.3.1.14 | 15.3.0 |
| 2019-03 | RAN#83 | R5-192852 | 0601 | 1 | F | Addition of NR test case Event A4 | 15.3.0 |
| 2019-03 | RAN#83 | R5-192853 | 0602 | 1 | F | Addition of NR test case Event A5 | 15.3.0 |
| 2019-03 | RAN#83 | R5-192854 | 0518 | 2 | F | Update of 5GS NR RRC test case 8.2.3.6.1 and 8.2.3.8.1 | 15.3.0 |
| 2019-03 | RAN#83 | R5-192855 | 0462 | 2 | F | Addition of NR test case 9.1.6.2.2-Reregistration not required | 15.3.0 |
| 2019-03 | RAN#83 | - | - | - | - | Editorial update to align referenced to TS 38.508-1 table numbers | 15.3.0 |
| 2019-06 | RAN#84 | R5-193861 | 0676 | - | F | Correction to NR RLC test cases 7.1.2.2.3 and 7.1.2.2.4 | 15.4.0 |
| 2019-06 | RAN#84 | R5-193869 | 0677 | - | F | Correction to 5GMM test case 9.1.5.2.4 | 15.4.0 |
| 2019-06 | RAN#84 | R5-193884 | 0681 | - | F | Update of TC 9.1.5.1.13 | 15.4.0 |
| 2019-06 | RAN#84 | R5-193898 | 0687 | - | F | Removal of TC 9.1.5.1.7 | 15.4.0 |
| 2019-06 | RAN#84 | R5-193984 | 0689 | - | F | Clarification on DRB to use in MAC test cases | 15.4.0 |
| 2019-06 | RAN#84 | R5-193986 | 0691 | - | F | Clarification on DRB to use in RLC test cases | 15.4.0 |
| 2019-06 | RAN#84 | R5-193987 | 0692 | - | F | Correction to NR RLC test case 7.1.2.3.9 | 15.4.0 |
| 2019-06 | RAN#84 | R5-193988 | 0693 | - | F | Clarification on DRB to use in PDCP test cases | 15.4.0 |
| 2019-06 | RAN#84 | R5-194008 | 0698 | - | F | Correction to EN-DC RRC test case 8.2.5.2.1 | 15.4.0 |
| 2019-06 | RAN#84 | R5-194031 | 0703 | - | F | Correction to PDCP test case 7.1.3.5.1 | 15.4.0 |
| 2019-06 | RAN#84 | R5-194033 | 0705 | - | F | Correction to 5GC NAS test case 9.1.8.1 - SMS over NAS / MO and MT SMS over NAS - Idle mode | 15.4.0 |
| 2019-06 | RAN#84 | R5-194045 | 0713 | - | F | Updates to 5GS SA RRC TC 8.1.1.4.1 | 15.4.0 |

| | | | | | | | |
|---------|--------|-----------|------|---|---|--|--------|
| 2019-06 | RAN#84 | R5-194046 | 0714 | - | F | Updates to 5GS SA RRC TC 8.1.5.2.1 | 15.4.0 |
| 2019-06 | RAN#84 | R5-194050 | 0718 | - | F | Addition of 5GS SA RRC TC - Intra NR handover / Success / Security key reconfiguration | 15.4.0 |
| 2019-06 | RAN#84 | R5-194051 | 0719 | - | F | Addition of 5GS SA RRC TC - Intra NR handover / Failure / Security key reconfiguration | 15.4.0 |
| 2019-06 | RAN#84 | R5-194119 | 0730 | - | F | Correction to EN-DC RRC measurement test cases | 15.4.0 |
| 2019-06 | RAN#84 | R5-194266 | 0735 | - | F | Correction to EN-DC RRC test case 8.2.5.1.1 | 15.4.0 |
| 2019-06 | RAN#84 | R5-194288 | 0742 | - | F | Correction to EN-DC RRC test case 8.2.5.3.1 | 15.4.0 |
| 2019-06 | RAN#84 | R5-194296 | 0745 | - | F | Correction to RLC test case - AM RLC / RLC re-establishment procedure | 15.4.0 |
| 2019-06 | RAN#84 | R5-194395 | 0751 | - | F | Update of NR RRC TC 8.2.3.12.1 | 15.4.0 |
| 2019-06 | RAN#84 | R5-194396 | 0752 | - | F | Addition of new RRC TC 8.1.5.6.5.1 | 15.4.0 |
| 2019-06 | RAN#84 | R5-194448 | 0759 | - | F | Addition of new TC 9.1.5.1.6 | 15.4.0 |
| 2019-06 | RAN#84 | R5-194481 | 0764 | - | F | Updates to 5GC NAS test case 9.1.2.2 | 15.4.0 |
| 2019-06 | RAN#84 | R5-194514 | 0776 | - | F | Update of TC 9.1.5.2.4 Mobility registration update / The lower layer requests NAS signalling connection recovery | 15.4.0 |
| 2019-06 | RAN#84 | R5-194637 | 0786 | - | F | Update to TC 8.1.4.2.1.1 | 15.4.0 |
| 2019-06 | RAN#84 | R5-194696 | 0791 | - | F | Correction to NR RLC test case 7.1.2.3.1 | 15.4.0 |
| 2019-06 | RAN#84 | R5-194699 | 0793 | - | F | Correction to NR PDCP test case 7.1.3.5.2 | 15.4.0 |
| 2019-06 | RAN#84 | R5-194787 | 0795 | - | F | Correction to NR test case 6.1.2.3-Cell selection-Serving cell bar | 15.4.0 |
| 2019-06 | RAN#84 | R5-194788 | 0796 | - | F | Correction to NR test case 6.1.2.9-Cell reselection using Qhyst, Qoffset and Treselection | 15.4.0 |
| 2019-06 | RAN#84 | R5-194792 | 0797 | - | F | Update to IDLE mode test case 6.1.1.1 | 15.4.0 |
| 2019-06 | RAN#84 | R5-194819 | 0727 | 1 | F | Correction to MAC test cases | 15.4.0 |
| 2019-06 | RAN#84 | R5-194822 | 0629 | 1 | F | Correction to NR test case 7.1.1.1.3-SI request | 15.4.0 |
| 2019-06 | RAN#84 | R5-194823 | 0611 | 1 | F | Addition of NR test case 6.1.2.12-Cell reselection CellReservedForOtherUse | 15.4.0 |
| 2019-06 | RAN#84 | R5-194833 | 0628 | 1 | F | Correction to NR test case 6.1.2.1-Cell selection Qrxlevmin | 15.4.0 |
| 2019-06 | RAN#84 | R5-194834 | 0746 | 1 | F | Editorial Corrections to Test Cases 6.3.1.1, 6.1.1.1, 6.1.2.7, 7.1.1.1.3, 8.1.1.3.1, 8.1.1.3.5, 9.1.5.2.4 | 15.4.0 |
| 2019-06 | RAN#84 | R5-194835 | 0747 | 1 | F | Corrections to Test Case 6.3.1.1 | 15.4.0 |
| 2019-06 | RAN#84 | R5-194836 | 0726 | 1 | F | Correction to EN-DC RLC test cases 7.1.2.2.1, 7.1.2.2.2, 7.1.2.3.1 and 7.1.2.3.2 | 15.4.0 |
| 2019-06 | RAN#84 | R5-194837 | 0704 | 1 | F | Correction to PDCP test case 7.1.3.5.4 - PDCP reordering / Maximum re-ordering delay below t-Reordering / t-Reordering timer operations | 15.4.0 |
| 2019-06 | RAN#84 | R5-194838 | 0711 | 1 | F | Updates to 5GS SA RRC TC 8.1.1.1.1 | 15.4.0 |
| 2019-06 | RAN#84 | R5-194839 | 0712 | 1 | F | Updates to 5GS SA RRC TC 8.1.1.2.3 | 15.4.0 |
| 2019-06 | RAN#84 | R5-194840 | 0734 | 1 | F | Correction of 5GC Test case 8.1.1.3.5 | 15.4.0 |
| 2019-06 | RAN#84 | R5-194841 | 0641 | 1 | F | Correction of NR test case 8.1.3.1.5-Intra Freq Event A4 | 15.4.0 |
| 2019-06 | RAN#84 | R5-194842 | 0642 | 1 | F | Correction of NR test case 8.1.3.1.8-Intra Freq Event A5 | 15.4.0 |
| 2019-06 | RAN#84 | R5-194843 | 0717 | 1 | F | Removal of EN-DC RRC TC - BandwidthPart Configuration / SCG | 15.4.0 |
| 2019-06 | RAN#84 | R5-194844 | 0770 | 1 | F | Update of 5GS NR RRC test case 8.2.1.1.1 | 15.4.0 |
| 2019-06 | RAN#84 | R5-194845 | 0657 | 1 | F | Correction to NR test case 8.2.3.11.1-ENDC measurement gap FR1 | 15.4.0 |
| 2019-06 | RAN#84 | R5-194846 | 0658 | 1 | F | Correction to NR test case 8.2.3.11.2-ENDC measurement gap FR2 | 15.4.0 |
| 2019-06 | RAN#84 | R5-194847 | 0661 | 1 | F | Corrections to 5G-NR RRC Measurement configuration and reporting test cases | 15.4.0 |
| 2019-06 | RAN#84 | R5-194848 | 0673 | 1 | F | Correction to EN-DC RRC test case 8.2.3.6.1 | 15.4.0 |
| 2019-06 | RAN#84 | R5-194849 | 0674 | 1 | F | Correction to EN-DC RRC test case 8.2.3.7.1 | 15.4.0 |
| 2019-06 | RAN#84 | R5-194850 | 0675 | 1 | F | Correction to EN-DC RRC test case 8.2.3.3.1 | 15.4.0 |
| 2019-06 | RAN#84 | R5-194851 | 0740 | 1 | F | Correction to EN-DC RRC test case 8.2.3.8.1 | 15.4.0 |
| 2019-06 | RAN#84 | R5-194853 | 0741 | 1 | F | Correction to EN-DC RRC test case 8.2.3.4.1 and 8.2.3.5.1 | 15.4.0 |
| 2019-06 | RAN#84 | R5-194854 | 0749 | 1 | F | Update TC 8.2.3.15.1 | 15.4.0 |
| 2019-06 | RAN#84 | R5-194855 | 0755 | 1 | F | Correction to EN-DC RRC measurement test cases 8.2.3.9.1 and 8.2.3.10.1
Editor's note: could not be implemented | 15.4.0 |
| 2019-06 | RAN#84 | R5-194856 | 0665 | 1 | F | Update of RRC TC 8.2.5.4.1 | 15.4.0 |
| 2019-06 | RAN#84 | R5-194857 | 0679 | 1 | F | Correction to 5GMM test case 9.1.2.1 | 15.4.0 |
| 2019-06 | RAN#84 | R5-194858 | 0756 | 1 | F | Correction to NR5GC testcase 9.1.3.1 | 15.4.0 |
| 2019-06 | RAN#84 | R5-194859 | 0659 | 1 | F | Correction to NR test case 9.1.5.1.1-Registration Request | 15.4.0 |
| 2019-06 | RAN#84 | R5-194867 | 0668 | 1 | F | Update of TC 9.1.6.1.1 | 15.4.0 |
| 2019-06 | RAN#84 | R5-194868 | 0758 | 1 | F | Correction to NR5GC testcase 9.1.5.1.14 | 15.4.0 |
| 2019-06 | RAN#84 | R5-194869 | 0609 | 1 | F | Correction to 5GC TC 9.1.7.1 | 15.4.0 |
| 2019-06 | RAN#84 | R5-194871 | 0610 | 1 | F | Correction to 5GC TC 10.1.3.2 | 15.4.0 |
| 2019-06 | RAN#84 | R5-194872 | 0680 | 1 | F | Correction on 5GC TC 10.1.2.2 | 15.4.0 |
| 2019-06 | RAN#84 | R5-194873 | 0607 | 1 | F | Correction to 5GC TC 10.1.6.1 | 15.4.0 |
| 2019-06 | RAN#84 | R5-194874 | 0608 | 1 | F | Correction to 5GC TC 10.1.6.2 | 15.4.0 |
| 2019-06 | RAN#84 | R5-194890 | 0728 | 1 | F | Introduction of Non 3GPP Access over WLAN test cases | 15.4.0 |
| 2019-06 | RAN#84 | R5-195208 | 0765 | 1 | F | Addition of new TC 9.1.5.1.9 | 15.4.0 |
| 2019-06 | RAN#84 | R5-195209 | 0707 | 1 | F | Addition of 5GC NAS Test Case - Generic UE configuration update / New 5G-GUTI / NITZ / registration requested / Network slicing indication / New Allowed NSSAI / acknowledgement from the UE | 15.4.0 |

| | | | | | | | |
|---------|--------|-----------|------|---|---|---|--------|
| 2019-06 | RAN#84 | R5-195210 | 0708 | 1 | F | Addition of 5GC NAS Test Case - UE-initiated de-registration / Abnormal / Change of cell into a new tracking area | 15.4.0 |
| 2019-06 | RAN#84 | R5-195211 | 0757 | 1 | F | Addition of NR5GC testcase 9.1.5.1.2 | 15.4.0 |
| 2019-06 | RAN#84 | R5-195212 | 0774 | 1 | F | Introduction of TC 9.1.5.2.7 Mobility and periodic registration update / Rejected / UE identity cannot be derived by the network | 15.4.0 |
| 2019-06 | RAN#84 | R5-195213 | 0775 | 1 | F | Introduction of TC 9.1.5.2.8 Mobility and periodic registration update / Rejected / Implicitly de-registered | 15.4.0 |
| 2019-06 | RAN#84 | R5-195226 | 0794 | 1 | F | Addition of 5GSM test case 10.1.1.2 | 15.4.0 |
| 2019-06 | RAN#84 | R5-195228 | 0777 | 1 | F | Introduction of TC 9.3.1.1 Mobility registration update / Single-registration mode with N26 / 5GMM-IDLE / 5GC to EPC | 15.4.0 |
| 2019-06 | RAN#84 | R5-195229 | 0778 | 1 | F | Introduction of TC 9.3.1.2 Mobility registration update / Single-registration mode with N26 / 5GMM-IDLE / EPC to 5GC | 15.4.0 |
| 2019-06 | RAN#84 | R5-195230 | 0779 | 1 | F | Introduction of TC 9.3.1.3 Mobility and periodic registration update / Rejected / Single-registration mode with N26 / Handling of EPS relevant parameters | 15.4.0 |
| 2019-06 | RAN#84 | R5-195231 | 0682 | 1 | F | New multilayer test case 11.1.3 | 15.4.0 |
| 2019-06 | RAN#84 | R5-195238 | 0780 | 1 | F | Introduction of new TC 11.1.7 Emergency call setup from NR RRC_IDLE / Emergency Services Fallback to EPS with redirection / Single registration mode with N26 interface / Success | 15.4.0 |
| 2019-06 | RAN#84 | R5-195243 | 0616 | 1 | F | Addition of NR test case 6.2.3.3-Inter-RAT Cell reselection NR2L by priority Srxlev based | 15.4.0 |
| 2019-06 | RAN#84 | R5-195244 | 0612 | 1 | F | Addition of NR test case 6.1.2.13-Cell reselection CellReservedForOperatorUse with Access Identity 1-2-12-13-14 | 15.4.0 |
| 2019-06 | RAN#84 | R5-195245 | 0613 | 1 | F | Addition of NR test case 6.1.2.14-Cell reselection CellReservedForOperatorUse with Access Identity 11-15 | 15.4.0 |
| 2019-06 | RAN#84 | R5-195247 | 0618 | 1 | F | Addition of NR test case 6.2.3.5-Inter-RAT Cell reselection NR2L by priority from dedicated signalling | 15.4.0 |
| 2019-06 | RAN#84 | R5-195249 | 0620 | 1 | F | Addition of NR test case 6.2.3.7-Inter-RAT Cell reselection NR2L Snonintrasearch | 15.4.0 |
| 2019-06 | RAN#84 | R5-195252 | 0623 | 1 | F | Addition of NR test case 6.4.2.1-Cell selection Qrxlevmin and Cell reselection | 15.4.0 |
| 2019-06 | RAN#84 | R5-195256 | 0627 | 1 | F | Addition of NR test case 6.4.1.2-Cell reselection of ePLMN in manual mode | 15.4.0 |
| 2019-06 | RAN#84 | R5-195257 | 0709 | 1 | F | Addition of Idle Mode Test Case - Steering of UE in roaming during registration/security check successful but SOR Transparent container indicates ACK has been NOT been requested | 15.4.0 |
| 2019-06 | RAN#84 | R5-195259 | 0631 | 1 | F | Addition of NR test case 8.1.3.1.6-Inter Freq Event A4 | 15.4.0 |
| 2019-06 | RAN#84 | R5-195260 | 0632 | 1 | F | Addition of NR test case 8.1.3.1.7-Inter Band Event A4 | 15.4.0 |
| 2019-06 | RAN#84 | R5-195261 | 0633 | 1 | F | Addition of NR test case 8.1.3.1.9-Inter Freq Event A5 | 15.4.0 |
| 2019-06 | RAN#84 | R5-195262 | 0634 | 1 | F | Addition of NR test case 8.1.3.1.10-Inter Band Event A5 | 15.4.0 |
| 2019-06 | RAN#84 | R5-195268 | 0640 | 1 | F | Addition of NR test case 8.1.3.2.5-Event A2 and B2 | 15.4.0 |
| 2019-06 | RAN#84 | R5-195269 | 0643 | 1 | F | Correction of NR test case 8.1.3.1.11-Two Event A3 RSRQ | 15.4.0 |
| 2019-06 | RAN#84 | R5-195270 | 0644 | 1 | F | Correction of NR test case 8.1.3.1.12-Two Event A5 SINR | 15.4.0 |
| 2019-06 | RAN#84 | R5-195271 | 0645 | 1 | F | Correction of NR test case 8.1.3.1.17.1-Intra Band Event A6 | 15.4.0 |
| 2019-06 | RAN#84 | R5-195272 | 0646 | 1 | F | Correction of NR test case 8.1.3.1.17.2-Inter Band Event A6 | 15.4.0 |
| 2019-06 | RAN#84 | R5-195273 | 0647 | 1 | F | Correction of NR test case 8.1.3.1.17.3-Intra Band non Contiguous Event A6 | 15.4.0 |
| 2019-06 | RAN#84 | R5-195274 | 0648 | 1 | F | Correction of NR test case 8.1.3.1.18.1-Additional Reporting Intra Band | 15.4.0 |
| 2019-06 | RAN#84 | R5-195275 | 0649 | 1 | F | Correction of NR test case 8.1.3.1.18.2-Additional Reporting Inter Band | 15.4.0 |
| 2019-06 | RAN#84 | R5-195276 | 0650 | 1 | F | Correction of NR test case 8.1.3.1.18.3-Additional Reporting Intra Band non Contiguous | 15.4.0 |
| 2019-06 | RAN#84 | R5-195277 | 0782 | 1 | F | Addition of 5GS NR RRC test case 8.1.3.1.2 | 15.4.0 |
| 2019-06 | RAN#84 | R5-195278 | 0783 | 1 | F | Addition of 5GS NR RRC test case 8.1.3.1.3 | 15.4.0 |
| 2019-06 | RAN#84 | R5-195279 | 0784 | 1 | F | Addition of 5GS NR RRC test case 8.1.3.1.4 | 15.4.0 |
| 2019-06 | RAN#84 | R5-195280 | 0790 | 1 | F | Addition of 5GS NR RRC test case for Intra NR measurements / Blacklisting | 15.4.0 |
| 2019-06 | RAN#84 | R5-195285 | 0699 | 1 | F | New 5GS SA RRC TC 8.1.4.1.9.1 | 15.4.0 |
| 2019-06 | RAN#84 | R5-195286 | 0700 | 1 | F | New 5GS SA RRC TC 8.1.4.1.9.2 | 15.4.0 |
| 2019-06 | RAN#84 | R5-195287 | 0701 | 1 | F | New 5GS SA RRC TC 8.1.4.1.9.3 | 15.4.0 |
| 2019-06 | RAN#84 | R5-195288 | 0724 | 1 | F | Addition of 5GS SA RRC TC - Intra NR handover / Failure / Re-establishment successful | 15.4.0 |
| 2019-06 | RAN#84 | R5-195289 | 0725 | 1 | F | Addition of 5GS SA RRC TC - Intra NR handover / Failure / Re-establishment failure | 15.4.0 |
| 2019-06 | RAN#84 | R5-195290 | 0731 | 1 | F | Addition of Intra-NR intra-frequency handover test case 8.1.4.1.1 | 15.4.0 |
| 2019-06 | RAN#84 | R5-195291 | 0732 | 1 | F | Addition of Intra-NR inter-frequency handover test case 8.1.4.1.2 | 15.4.0 |
| 2019-06 | RAN#84 | R5-195292 | 0720 | 1 | F | Addition of 5GS SA RRC TC - Redirection to NR / From E-UTRA / Success | 15.4.0 |
| 2019-06 | RAN#84 | R5-195293 | 0736 | 1 | F | New 5G Radio link failure test case 8.1.5.6.1 | 15.4.0 |
| 2019-06 | RAN#84 | R5-195294 | 0753 | 1 | F | Addition of new RRC TC 8.1.5.6.2 | 15.4.0 |
| 2019-06 | RAN#84 | R5-195295 | 0754 | 1 | F | Addition of new RRC TC 8.1.5.6.3
Editor's note: could not be implemented | 15.4.0 |

| | | | | | | | |
|---------|--------|-----------|------|---|---|--|--------|
| 2019-06 | RAN#84 | R5-195296 | 0768 | 1 | F | Addition of 5GS NR RRC test case 8.1.5.4.1 | 15.4.0 |
| 2019-06 | RAN#84 | R5-195297 | 0771 | 1 | F | New 5G Radio link failure test case 8.1.5.6.2 | 15.4.0 |
| 2019-06 | RAN#84 | R5-195298 | 0772 | 1 | F | New 5G Radio link failure test case 8.1.5.6.3 | 15.4.0 |
| 2019-06 | RAN#84 | R5-195299 | 0773 | 1 | F | New 5G Radio link failure test case 8.1.5.6.4 | 15.4.0 |
| 2019-06 | RAN#84 | R5-195300 | 0696 | 1 | F | Correction to RRC test case 8.2.3.13.1 | 15.4.0 |
| 2019-06 | RAN#84 | R5-195301 | 0697 | 1 | F | Correction to RRC test case 8.2.3.14.1 | 15.4.0 |
| 2019-06 | RAN#84 | R5-195302 | 0722 | 1 | F | Addition of new EN-DC RRC TC - Measurement configuration control and reporting / Event A4 / Measurement of Neighbour NR cell / Inter-frequency measurements / EN-DC | 15.4.0 |
| 2019-06 | RAN#84 | R5-195303 | 0723 | 1 | F | Addition of new EN-DC RRC TC - Measurement configuration control and reporting / Event A4 / Measurement of Neighbour NR cell / Inter-band measurements / EN-DC | 15.4.0 |
| 2019-06 | RAN#84 | R5-195336 | 0690 | 1 | F | Correction to NR MAC test case 7.1.1.1.1 | 15.4.0 |
| 2019-06 | RAN#84 | R5-195338 | 0694 | 1 | F | Correction to NR PDCP test case 7.1.3.4.1 | 15.4.0 |
| 2019-06 | RAN#84 | R5-195339 | 0715 | 1 | F | Updates to PDCP Integrity Protection TCs 7.1.3.2.x | 15.4.0 |
| 2019-06 | RAN#84 | R5-195340 | 0716 | 1 | F | Updates to PDCP Ciphering and Deciphering TCs 7.1.3.3.x | 15.4.0 |
| 2019-06 | RAN#84 | R5-195341 | 0662 | 1 | F | Update of RRC TC 8.1.1.4.2 | 15.4.0 |
| 2019-06 | RAN#84 | R5-195342 | 0743 | 1 | F | Correction to NR test case 8.1.2.1.3 | 15.4.0 |
| 2019-06 | RAN#84 | R5-195343 | 0744 | 1 | F | Correction to 5GS SA RRC TC - 8.1.2.1.1 | 15.4.0 |
| 2019-06 | RAN#84 | R5-195344 | 0669 | 1 | F | Correction of NR test case 8.1.3.1.1-Intra Freq Event A1 A2 | 15.4.0 |
| 2019-06 | RAN#84 | R5-195345 | 0670 | 1 | F | Correction of NR test case 8.1.3.2.1-Event B1 | 15.4.0 |
| 2019-06 | RAN#84 | R5-195346 | 0671 | 1 | F | Correction of NR test case 8.1.3.2.2-Event B2 | 15.4.0 |
| 2019-06 | RAN#84 | R5-195347 | 0672 | 1 | F | Correction of NR test case 8.1.3.2.3-Event B2 RSRQ | 15.4.0 |
| 2019-06 | RAN#84 | R5-195350 | 0667 | 1 | F | Update of 5GC TC 9.1.5.1.5 | 15.4.0 |
| 2019-06 | RAN#84 | R5-195351 | 0688 | 1 | F | New multilayer test case 11.1.4 | 15.4.0 |
| 2019-06 | RAN#84 | R5-195352 | 0683 | 1 | F | Addition of Multilayer test case 11.1.2 | 15.4.0 |
| 2019-06 | RAN#84 | R5-195353 | 0684 | 1 | F | Addition of Multilayer test case 11.1.5 | 15.4.0 |
| 2019-06 | RAN#84 | R5-195354 | 0685 | 1 | F | Addition of Multilayer test case 11.1.6 | 15.4.0 |
| 2019-06 | RAN#84 | R5-195355 | 0710 | 1 | F | Addition of 5GS Multilayer Test Case 11.1.1 MO MMTEL voice call setup from NR RRC_IDLE / EPS Fallback with redirection / Single registration mode with N26 interface / Success | 15.4.0 |
| 2019-06 | RAN#84 | R5-195358 | 0798 | 1 | F | Update of EN-DC RRC TC 8.2.3.2.1 | 15.4.0 |
| 2019-06 | RAN#84 | R5-195363 | 0781 | 2 | F | Update to NR MAC Bandwidth Part operation TC 7.1.1.8.1 | 15.4.0 |
| 2019-06 | RAN#84 | R5-195364 | 0695 | 2 | F | Correction to NR PDCP test case 7.1.3.4.2 | 15.4.0 |
| 2019-06 | RAN#84 | R5-195365 | 0785 | 2 | F | Addition of 5GS NR RRC test case 8.2.3.6.1a | 15.4.0 |
| 2019-06 | RAN#84 | R5-195366 | 0787 | 2 | F | Addition of 5GS NR RRC test case 8.2.3.6.1b | 15.4.0 |
| 2019-06 | RAN#84 | R5-195367 | 0788 | 2 | F | Addition of 5GS NR RRC test case 8.2.3.8.1a | 15.4.0 |
| 2019-06 | RAN#84 | R5-195368 | 0789 | 2 | F | Addition of 5GS NR RRC test case 8.2.3.8.1b | 15.4.0 |
| 2019-06 | RAN#84 | R5-195369 | 0799 | 2 | F | Correction to EN-DC RRC Measurement test cases for FR2 Power table | 15.4.0 |
| 2019-06 | RAN#84 | R5-195370 | 0666 | 2 | F | Update of 5GC TC 9.1.6.1.2 | 15.4.0 |
| 2019-06 | RAN#84 | - | - | - | - | Administrative release upgrade to match the release of 3GPP TS 38.508-1 which was upgraded at RAN#84 to Rel-16 due to Rel-16 relevant CR(s) | 16.0.0 |
| 2019-09 | RAN#85 | R5-195649 | 0810 | - | F | Addition of NR test case 6.4.1.1-HPLMN in Automatic PLMN Selection Mode in RRC_INACTIVE state | 16.1.0 |
| 2019-09 | RAN#85 | R5-195650 | 0811 | - | F | Addition of NR test case 6.4.2.2-Inter-Freq Cell reselection by priority of SIBs | 16.1.0 |
| 2019-09 | RAN#85 | R5-195663 | 0824 | - | F | Addition of NR test case 8.1.4.1.7.2-PCell Change and SCell addition Inter-band CA | 16.1.0 |
| 2019-09 | RAN#85 | R5-195664 | 0825 | - | F | Addition of NR test case 8.1.4.1.7.3-PCell Change and SCell addition Intra-band non-contiguous CA | 16.1.0 |
| 2019-09 | RAN#85 | R5-195666 | 0827 | - | F | Addition of NR test case 8.1.4.1.8.2-SCell no change Inter-band CA | 16.1.0 |
| 2019-09 | RAN#85 | R5-195667 | 0828 | - | F | Addition of NR test case 8.1.4.1.8.3-SCell no change Intra-band non-contiguous CA | 16.1.0 |
| 2019-09 | RAN#85 | R5-195676 | 0837 | - | F | Correction to NR test case 8.1.5.3.1-PWS reception in NR RRC_IDLE state | 16.1.0 |
| 2019-09 | RAN#85 | R5-195677 | 0838 | - | F | Correction to NR test case 8.1.5.3.3-PWS reception in NR RRC_CONNECTED state | 16.1.0 |
| 2019-09 | RAN#85 | R5-195681 | 0842 | - | F | Correction to NR test case 9.1.5.1.10-PLMN not allowed | 16.1.0 |
| 2019-09 | RAN#85 | R5-195712 | 0850 | - | F | Update to RRC measurement test cases in EN-DC for FR2 support | 16.1.0 |
| 2019-09 | RAN#85 | R5-195929 | 0863 | - | F | Update to PDCP test cases in EN-DC for FR2 support | 16.1.0 |
| 2019-09 | RAN#85 | R5-195947 | 0870 | - | F | Correction to references to test procedure for Switch off / Power off UE | 16.1.0 |
| 2019-09 | RAN#85 | R5-195948 | 0871 | - | F | Correction of power level units for test case 7.1.1.7.1 | 16.1.0 |
| 2019-09 | RAN#85 | R5-195949 | 0872 | - | F | Correction of power level units for test cases 8.1.3.1.11, 8.1.3.1.12, 8.1.3.1.15A, 8.1.3.2.3 | 16.1.0 |
| 2019-09 | RAN#85 | R5-195981 | 0876 | - | F | Correction to 5GC TC 10.1.6.1 | 16.1.0 |
| 2019-09 | RAN#85 | R5-195996 | 0878 | - | F | Update PDCP test case 7.1.3.2.1 | 16.1.0 |
| 2019-09 | RAN#85 | R5-195997 | 0879 | - | F | Update PDCP test case 7.1.3.3.1 | 16.1.0 |
| 2019-09 | RAN#85 | R5-196002 | 0884 | - | F | Update RRC measurement test case 8.2.3.14 | 16.1.0 |
| 2019-09 | RAN#85 | R5-196039 | 0889 | - | F | Addition of new 5GC TC 10.1.2.1 | 16.1.0 |
| 2019-09 | RAN#85 | R5-196046 | 0895 | - | F | Correction to 5GC TC 8.1.5.1.1 | 16.1.0 |

| | | | | | | | |
|---------|--------|-----------|------|---|---|--|--------|
| 2019-09 | RAN#85 | R5-196055 | 0902 | - | F | Correction to TC 9.1.7.1-Service Request in Idle state | 16.1.0 |
| 2019-09 | RAN#85 | R5-196093 | 0919 | - | F | Correction to RLC test case 7.1.2.3.11 | 16.1.0 |
| 2019-09 | RAN#85 | R5-196109 | 0930 | - | F | To void TC 8.1.1.3.5 | 16.1.0 |
| 2019-09 | RAN#85 | R5-196110 | 0931 | - | F | To void TC 8.1.1.3.6 | 16.1.0 |
| 2019-09 | RAN#85 | R5-196111 | 0932 | - | F | To void TC 8.1.1.4.3 | 16.1.0 |
| 2019-09 | RAN#85 | R5-196112 | 0933 | - | F | To void TC 8.1.4.1.3 | 16.1.0 |
| 2019-09 | RAN#85 | R5-196113 | 0934 | - | F | To void TC 8.1.4.1.4 | 16.1.0 |
| 2019-09 | RAN#85 | R5-196114 | 0935 | - | F | Correction to EN-DC RRC TCs 8.2.2.4.1 & 8.2.2.5.1 | 16.1.0 |
| 2019-09 | RAN#85 | R5-196118 | 0939 | - | F | Updates to EN-DC RRC TC 8.2.3.7.1a | 16.1.0 |
| 2019-09 | RAN#85 | R5-196119 | 0940 | - | F | Updates to EN-DC RRC TC 8.2.3.7.1b | 16.1.0 |
| 2019-09 | RAN#85 | R5-196156 | 0947 | - | F | Correction to NR Idle test case 6.1.1.6 | 16.1.0 |
| 2019-09 | RAN#85 | R5-196217 | 0954 | - | F | Update of NR test case 6.1.2.2-Intra-NR Cell Selection Qqualmin based | 16.1.0 |
| 2019-09 | RAN#85 | R5-196218 | 0955 | - | F | Update of NR test case 6.1.2.21-Cell reselection, SIntraSearchQ and SnonIntraSearchQ | 16.1.0 |
| 2019-09 | RAN#85 | R5-196261 | 0962 | - | F | Correction to NR test case 7.1.3.4.1 - PDCP Lossless handover | 16.1.0 |
| 2019-09 | RAN#85 | R5-196285 | 0964 | - | F | Correction to EN-DC RRC test case 8.2.5.3.1 | 16.1.0 |
| 2019-09 | RAN#85 | R5-196306 | 0969 | - | F | Removal of NR RRC test case 8.1.2.1.3 | 16.1.0 |
| 2019-09 | RAN#85 | R5-196353 | 0971 | - | F | Correction to test cases 6.1.1.8 | 16.1.0 |
| 2019-09 | RAN#85 | R5-196354 | 0972 | - | F | Update sub-clause 6.2.1 test cases with the latest generic procedure references | 16.1.0 |
| 2019-09 | RAN#85 | R5-196355 | 0973 | - | F | Update to test case 9.1.5.1.5 | 16.1.0 |
| 2019-09 | RAN#85 | R5-196489 | 0976 | - | F | Update of RRC TC 8.1.5.6.5.2 | 16.1.0 |
| 2019-09 | RAN#85 | R5-196492 | 0977 | - | F | New RRC TC 8.1.5.6.5.3 | 16.1.0 |
| 2019-09 | RAN#85 | R5-196598 | 0982 | - | F | Correction to Idle TC 6.1.1.3 | 16.1.0 |
| 2019-09 | RAN#85 | R5-196610 | 0985 | - | F | Correction to Idle TC 6.1.2.8 | 16.1.0 |
| 2019-09 | RAN#85 | R5-196614 | 0988 | - | F | Deletion of TC 8.1.4.1.1 | 16.1.0 |
| 2019-09 | RAN#85 | R5-196624 | 0991 | - | F | Correction to RLC TC 7.1.2.2.5 and 7.1.2.2.6 | 16.1.0 |
| 2019-09 | RAN#85 | R5-196633 | 0995 | - | F | Correction to 5GC TC 9.1.6.1.4 | 16.1.0 |
| 2019-09 | RAN#85 | R5-196642 | 0996 | - | F | Adding specs to TS 38.523-1 References section | 16.1.0 |
| 2019-09 | RAN#85 | R5-196730 | 1009 | - | F | Update of test case 9.3.1.1 Mobility registration update / Single-registration mode with N26 / 5GMM-IDLE / 5GC to EPC | 16.1.0 |
| 2019-09 | RAN#85 | R5-196731 | 1010 | - | F | Update of test case 9.3.1.2 Mobility registration update / Single-registration mode with N26 / 5GMM-IDLE / EPC to 5GC | 16.1.0 |
| 2019-09 | RAN#85 | R5-196732 | 1011 | - | F | Update of test case 9.3.1.3 Mobility and periodic registration update / Rejected / Single-registration mode with N26 / Handling of EPC relevant parameters | 16.1.0 |
| 2019-09 | RAN#85 | R5-196745 | 1013 | - | F | Correction to pre-condition of MAC test cases | 16.1.0 |
| 2019-09 | RAN#85 | R5-196753 | 1019 | - | F | Correction to ENDC test case 7.1.2.2.6 | 16.1.0 |
| 2019-09 | RAN#85 | R5-196755 | 1020 | - | F | Correction to NR5GC test case 9.1.5.2.8 | 16.1.0 |
| 2019-09 | RAN#85 | R5-196779 | 1029 | - | F | Update to TC 8.1.3.1.15A | 16.1.0 |
| 2019-09 | RAN#85 | R5-196827 | 1031 | - | F | Removal of Radio Link Failure test cases | 16.1.0 |
| 2019-09 | RAN#85 | R5-196828 | 1032 | - | F | Editorial changes to SERVICE REQUEST parameters for multi layer test cases | 16.1.0 |
| 2019-09 | RAN#85 | R5-196835 | 1036 | - | F | Update to 5GS NR RRC test case 8.1.5.4.1 | 16.1.0 |
| 2019-09 | RAN#85 | R5-197001 | 0941 | 1 | F | Correction of NR test case 7.1.1.3.3 | 16.1.0 |
| 2019-09 | RAN#85 | R5-197002 | 0943 | 1 | F | Correction to test case 7.1.1.3.4 | 16.1.0 |
| 2019-09 | RAN#85 | R5-197003 | 0944 | 1 | F | Correction to test case 7.1.1.3.5 | 16.1.0 |
| 2019-09 | RAN#85 | R5-197005 | 0905 | 1 | F | Correction to test case 8.1.1.4.2 | 16.1.0 |
| 2019-09 | RAN#85 | R5-197006 | 0914 | 1 | F | Correction to ENDC test case 10.2.2.1 | 16.1.0 |
| 2019-09 | RAN#85 | R5-197007 | 0983 | 1 | F | Correction to RLC AM test case 7.1.2.3.9 | 16.1.0 |
| 2019-09 | RAN#85 | R5-197008 | 0953 | 1 | F | Correction to RLC test case 7.1.2.3.10 in EN-DC | 16.1.0 |
| 2019-09 | RAN#85 | R5-197011 | 1026 | 1 | F | Correction to ENDC test case 7.1.2.3.5 | 16.1.0 |
| 2019-09 | RAN#85 | R5-197012 | 0918 | 1 | F | Correction to PDCP test case 7.1.3.2.1 | 16.1.0 |
| 2019-09 | RAN#85 | R5-197013 | 1002 | 1 | F | Correction to NR PDCP test case 7.1.3.4.2 | 16.1.0 |
| 2019-09 | RAN#85 | R5-197015 | 0904 | 1 | F | Updates to EN-DC RRC measurement test case 8.2.3.3.1 | 16.1.0 |
| 2019-09 | RAN#85 | R5-197016 | 1012 | 1 | F | Correction to EN-DC RRC test case 8.2.3.4.1 and 8.2.3.7.1 | 16.1.0 |
| 2019-09 | RAN#85 | R5-197017 | 0865 | 1 | F | Update to NR RRC Idle mode test cases for FR2 support | 16.1.0 |
| 2019-09 | RAN#85 | R5-197018 | 0864 | 1 | F | Update to CA test cases in EN-DC for FR2 support | 16.1.0 |
| 2019-09 | RAN#85 | R5-197019 | 0897 | 1 | F | Correction to NR test case 6.1.2.1-cell selection | 16.1.0 |
| 2019-09 | RAN#85 | R5-197020 | 0898 | 1 | F | Correction to NR test case 6.1.2.13-Cell reselection CellReservedForOperatorUse with Access Identity 0-1-2-12-13-14 | 16.1.0 |
| 2019-09 | RAN#85 | R5-197021 | 0814 | 1 | F | Correction to NR test case 7.1.1.1.4-BeamFailure | 16.1.0 |
| 2019-09 | RAN#85 | R5-197022 | 0899 | 1 | F | Correction to TC 7.1.1.3.5-Padding BSR | 16.1.0 |
| 2019-09 | RAN#85 | R5-197023 | 0961 | 1 | F | Correction to NR test case 7.1.1.9.1 - MAC Reset | 16.1.0 |
| 2019-09 | RAN#85 | R5-197026 | 0978 | 1 | F | Correction to Several MAC test cases | 16.1.0 |
| 2019-09 | RAN#85 | R5-197027 | 0990 | 1 | F | Correction to MAC TC 7.1.1.1.3 | 16.1.0 |
| 2019-09 | RAN#85 | R5-197029 | 0911 | 1 | F | Correction to 5GS RLC test case 7.1.2.3.6 | 16.1.0 |
| 2019-09 | RAN#85 | R5-197030 | 0974 | 1 | F | Correction to RLC test case 7.1.2.3.7 | 16.1.0 |
| 2019-09 | RAN#85 | R5-197051 | 0949 | 1 | F | Updates to 5GS PDCP test cases 7.1.3.1.1 and 7.1.3.1.2 | 16.1.0 |
| 2019-09 | RAN#85 | R5-197052 | 0901 | 1 | F | Correction to TC 8.1.1.3.4-NR2L reselection by RRCRelease | 16.1.0 |
| 2019-09 | RAN#85 | R5-197053 | 0927 | 1 | F | Updates to 5GS SA RRC TC 8.1.1.4.1 | 16.1.0 |

| | | | | | | | |
|---------|--------|-----------|------|---|---|--|--------|
| 2019-09 | RAN#85 | R5-197054 | 0956 | 1 | F | Correction to TC 8.1.1.2.1-T300 expiry | 16.1.0 |
| 2019-09 | RAN#85 | R5-197055 | 0957 | 1 | F | Correction to TC 8.1.1.3.3-T320 expiry | 16.1.0 |
| 2019-09 | RAN#85 | R5-197057 | 0968 | 1 | F | Correction to NR RRC Test case 8.1.2.1.1 | 16.1.0 |
| 2019-09 | RAN#85 | R5-197058 | 0832 | 1 | F | Correction to NR test case 8.1.3.1.11-two RSRQ A3 | 16.1.0 |
| 2019-09 | RAN#85 | R5-197059 | 0833 | 1 | F | Correction to NR test case 8.1.3.1.12-two SINR A5 | 16.1.0 |
| 2019-09 | RAN#85 | R5-197060 | 0834 | 1 | F | Correction to NR test case 8.1.3.1.17.3-A6 intraband non contiguous | 16.1.0 |
| 2019-09 | RAN#85 | R5-197061 | 0835 | 1 | F | Correction to NR test case 8.1.3.1.18.3-A6 intraband non contiguous additional reporting | 16.1.0 |
| 2019-09 | RAN#85 | R5-197062 | 0836 | 1 | F | Correction to NR test case 8.1.3.2.5-A2 and B2 | 16.1.0 |
| 2019-09 | RAN#85 | R5-197063 | 0861 | 1 | F | Editorial update MeasurementReport table | 16.1.0 |
| 2019-09 | RAN#85 | R5-197064 | 1028 | 1 | F | Correction to RRC TC 8.1.3.1.11, 8.1.3.1.12, 8.1.3.2.3 and 8.1.4.1.9.1 | 16.1.0 |
| 2019-09 | RAN#85 | R5-197065 | 0928 | 1 | F | Updates to 5GS SA RRC TC 8.1.5.2.1 | 16.1.0 |
| 2019-09 | RAN#85 | R5-197066 | 0929 | 1 | F | Updates to 5GS SA RRC TC 8.1.5.5.1 | 16.1.0 |
| 2019-09 | RAN#85 | R5-197067 | 1033 | 1 | F | Updates to RLF test case 8.1.5.6.1 | 16.1.0 |
| 2019-09 | RAN#85 | R5-197068 | 1034 | 1 | F | Updates to RLF test case 8.1.5.6.3 | 16.1.0 |
| 2019-09 | RAN#85 | R5-197070 | 1001 | 1 | F | Correction to EN-DC RRC test case 8.2.1.1.1 | 16.1.0 |
| 2019-09 | RAN#85 | R5-197071 | 1003 | 1 | F | Correction to EN-DC RRC test case 8.2.2.7.1 | 16.1.0 |
| 2019-09 | RAN#85 | R5-197072 | 0839 | 1 | F | Correction to NR test case 8.2.3.15.1-A2 and A3 | 16.1.0 |
| 2019-09 | RAN#85 | R5-197073 | 0873 | 1 | F | Correction to EN-DC RRC measurement test case 8.2.3.9.1 | 16.1.0 |
| 2019-09 | RAN#85 | R5-197074 | 1030 | 1 | F | Correction to EN-DC RRC measurement test case 8.2.3.10.1 | 16.1.0 |
| 2019-09 | RAN#85 | R5-197075 | 0948 | 1 | F | Correction to EN-DC RRC test case 8.2.4.3.1.1 | 16.1.0 |
| 2019-09 | RAN#85 | R5-197076 | 1035 | 1 | F | Updates to test cases using SERVICE REQUEST procedure | 16.1.0 |
| 2019-09 | RAN#85 | R5-197077 | 0840 | 1 | F | Correction to NR test case 9.1.1.6-5G AKA authentication abnormal | 16.1.0 |
| 2019-09 | RAN#85 | R5-197078 | 0993 | 1 | F | Correction to 5GC TC 9.1.2.2 | 16.1.0 |
| 2019-09 | RAN#85 | R5-197079 | 0841 | 1 | F | Correction to NR test case 9.1.5.1.1-Initial registration | 16.1.0 |
| 2019-09 | RAN#85 | R5-197080 | 0843 | 1 | F | Correction to NR test case 9.1.5.2.4-Mobility registration update by lower layer failure | 16.1.0 |
| 2019-09 | RAN#85 | R5-197081 | 0896 | 1 | F | Correction to 5GC TC 9.1.5.1.9 | 16.1.0 |
| 2019-09 | RAN#85 | R5-197082 | 0920 | 1 | F | Correction to 5GC NAS test case 9.1.6.1.3 | 16.1.0 |
| 2019-09 | RAN#85 | R5-197083 | 0945 | 1 | F | Update of 5GC TC 9.1.5.1.11 | 16.1.0 |
| 2019-09 | RAN#85 | R5-197084 | 0946 | 1 | F | Update of 5GC TC 9.1.5.1.12 | 16.1.0 |
| 2019-09 | RAN#85 | R5-197085 | 0965 | 1 | F | Correction to NR5GC testcase 9.1.5.1.2 | 16.1.0 |
| 2019-09 | RAN#85 | R5-197086 | 0966 | 1 | F | Correction to NR5GC testcase 9.1.5.1.14 | 16.1.0 |
| 2019-09 | RAN#85 | R5-197087 | 0981 | 1 | F | Correction to 5GC test case 9.1.6.1.1 De-registration | 16.1.0 |
| 2019-09 | RAN#85 | R5-197088 | 0844 | 1 | F | Correction to NR test case 9.1.7.2-Data pending without user-plane resource | 16.1.0 |
| 2019-09 | RAN#85 | R5-197089 | 0924 | 1 | F | Corrections to 5GS Multilayer Test Case 11.1.1 | 16.1.0 |
| 2019-09 | RAN#85 | R5-197090 | 0975 | 1 | F | Correction to 5GS/EPS Fallback test case 11.1.3 | 16.1.0 |
| 2019-09 | RAN#85 | R5-197091 | 0997 | 1 | F | Update of 5GS/EPS Fallback test cases for System information, type of cells and more | 16.1.0 |
| 2019-09 | RAN#85 | R5-197092 | 1007 | 1 | F | Correction to 5GS/EPS Fallback test case 11.1.4 | 16.1.0 |
| 2019-09 | RAN#85 | R5-197093 | 1015 | 1 | F | Update multi-layer test case 11.1.2 | 16.1.0 |
| 2019-09 | RAN#85 | R5-197094 | 1016 | 1 | F | Update multi-layer test case 11.1.5 | 16.1.0 |
| 2019-09 | RAN#85 | R5-197095 | 1017 | 1 | F | Update multi-layer test case 11.1.6 | 16.1.0 |
| 2019-09 | RAN#85 | R5-197097 | 1039 | - | F | Correction to NR test case 8.1.5.3.4-PWS reception using dedicatedSystemInformationDelivery | 16.1.0 |
| 2019-09 | RAN#85 | R5-197185 | 0804 | 1 | F | Addition of NR test case 6.2.3.1-Inter-RAT Cell reselection L2NR by priority Srxlev based | 16.1.0 |
| 2019-09 | RAN#85 | R5-197186 | 0805 | 1 | F | Addition of NR test case 6.2.3.2-Inter-RAT Cell reselection L2NR by priority Squal based | 16.1.0 |
| 2019-09 | RAN#85 | R5-197187 | 0806 | 1 | F | Addition of NR test case 6.2.3.4-Inter-RAT Cell reselection NR2L by priority Squal based | 16.1.0 |
| 2019-09 | RAN#85 | R5-197188 | 0807 | 1 | F | Addition of NR test case 6.2.3.6-Inter-RAT Cell reselection L2NR by priority from dedicated signalling | 16.1.0 |
| 2019-09 | RAN#85 | R5-197189 | 0808 | 1 | F | Addition of NR test case 6.2.3.8-Inter-RAT Cell reselection L2NR Snointrasearch | 16.1.0 |
| 2019-09 | RAN#85 | R5-197190 | 0809 | 1 | F | Addition of NR test case 6.2.3.9-Inter-RAT Cell reselection NR2L Speed Dependent | 16.1.0 |
| 2019-09 | RAN#85 | R5-197191 | 0812 | 1 | F | Addition of NR test case 6.4.3.1-Inter-RAT Cell reselection NR2L Srxlev based | 16.1.0 |
| 2019-09 | RAN#85 | R5-197192 | 1043 | - | F | Correction to UE capability transfer test case 8.1.5.1.1 | 16.1.0 |
| 2019-09 | RAN#85 | R5-197193 | 0813 | 1 | F | Update of NR test case 6.1.2.22-Inter-frequency cell reselection with parameters | 16.1.0 |
| 2019-09 | RAN#85 | R5-197195 | 0846 | 1 | F | Addition of test case 6.3.1.3 of TS 38.523-1 | 16.1.0 |
| 2019-09 | RAN#85 | R5-197196 | 0847 | 1 | F | Addition of test case 6.3.1.4 of TS 38.523-1 | 16.1.0 |
| 2019-09 | RAN#85 | R5-197197 | 0848 | 1 | F | Addition of test case 6.3.1.8 of TS 38.523-1 | 16.1.0 |
| 2019-09 | RAN#85 | R5-197198 | 0849 | 1 | F | Addition of test case 6.3.1.9 of TS 38.523-1 | 16.1.0 |
| 2019-09 | RAN#85 | R5-197199 | 0893 | 1 | F | Addition of NR Idle test case 6.1.2.23 - Cell reselection/ MFBI | 16.1.0 |
| 2019-09 | RAN#85 | R5-197201 | 1014 | 1 | F | Update of 5GC test case 9.1.1.2 | 16.1.0 |
| 2019-09 | RAN#85 | R5-197202 | 1038 | 1 | F | Addition of new NR MAC test case 7.1.1.3.2b | 16.1.0 |
| 2019-09 | RAN#85 | R5-197203 | 0923 | 1 | F | Addition of Idle Mode Test Case -Cell reselection, Sintrasearch, | 16.1.0 |

| | | | | | | Snonintrasearch | |
|---------|--------|-----------|------|---|---|--|--------|
| 2019-09 | RAN#85 | R5-197205 | 0866 | 1 | F | Add RRC reconfiguration test case 8.1.2.1.4 | 16.1.0 |
| 2019-09 | RAN#85 | R5-197206 | 0867 | 1 | F | Add RRC reconfiguration test case 8.1.2.1.5.1 | 16.1.0 |
| 2019-09 | RAN#85 | R5-197207 | 0868 | 1 | F | Add RRC reconfiguration test case 8.1.2.1.5.2 | 16.1.0 |
| 2019-09 | RAN#85 | R5-197208 | 0869 | 1 | F | Add RRC reconfiguration test case 8.1.2.1.5.3 | 16.1.0 |
| 2019-09 | RAN#85 | R5-197209 | 0817 | 1 | F | Addition of NR test case 8.1.3.1.16-whitelisting | 16.1.0 |
| 2019-09 | RAN#85 | R5-197210 | 0818 | 1 | F | Addition of NR test case 8.1.3.1.20-GapFR1 | 16.1.0 |
| 2019-09 | RAN#85 | R5-197211 | 0819 | 1 | F | Addition of NR test case 8.1.3.1.21-GapFR2 | 16.1.0 |
| 2019-09 | RAN#85 | R5-197213 | 0822 | 1 | F | Addition of NR test case 8.1.3.2.4-Event B2 SINR | 16.1.0 |
| 2019-09 | RAN#85 | R5-197214 | 0984 | 1 | F | Addition of SA NR measurement test case TC 8.1.3.1.23 | 16.1.0 |
| 2019-09 | RAN#85 | R5-197215 | 0823 | 1 | F | Addition of NR test case 8.1.4.1.7.1-PCell Change and SCell addition Intra-band Contiguous CA | 16.1.0 |
| 2019-09 | RAN#85 | R5-197216 | 0826 | 1 | F | Addition of NR test case 8.1.4.1.8.1-SCell no change Intra-band Contiguous CA | 16.1.0 |
| 2019-09 | RAN#85 | R5-197217 | 0894 | 1 | F | Addition of 5GC test case 9.1.1.4 | 16.1.0 |
| 2019-09 | RAN#85 | R5-197218 | 0887 | 1 | F | Addition of new 5GC TC 10.1.3.1 | 16.1.0 |
| 2019-09 | RAN#85 | R5-197219 | 0998 | 1 | F | Introduction of new TC 11.4.1 5GMM-REGISTERED.NORMAL-SERVICE / 5GMM-IDLE / Emergency call / Utilising emergency number stored on the USIM / New emergency PDU session | 16.1.0 |
| 2019-09 | RAN#85 | R5-197220 | 0999 | 1 | F | Introduction of new TC 11.4.2 5GMM-DEREGISTERED.LIMITED-SERVICE / Emergency call / Handling of forbidden PLMNs | 16.1.0 |
| 2019-09 | RAN#85 | R5-197221 | 1000 | 1 | F | Introduction of new TC 11.4.3 5GMM-DEREGISTERED.NO-SUPI / Emergency call / Utilisation of emergency numbers stored on the ME / Initial registration for emergency services | 16.1.0 |
| 2019-09 | RAN#85 | R5-197227 | 0979 | 1 | F | Non 3GPP Access over WLAN test cases | 16.1.0 |
| 2019-09 | RAN#85 | R5-197247 | 0877 | 1 | F | Update MAC test case 7.1.1.1 | 16.1.0 |
| 2019-09 | RAN#85 | R5-197250 | 0989 | 1 | F | Correction to RLC UM test case 7.1.2.2.5 | 16.1.0 |
| 2019-09 | RAN#85 | R5-197255 | 0938 | 1 | F | Correction to PDCP TC 7.1.3.5.3 | 16.1.0 |
| 2019-09 | RAN#85 | R5-197256 | 0986 | 1 | F | Corrections to TC 8.1.4.1.2 | 16.1.0 |
| 2019-09 | RAN#85 | R5-197258 | 1023 | 1 | F | Correction to test cases 8.1.1.2.3 | 16.1.0 |
| 2019-09 | RAN#85 | R5-197259 | 0917 | 1 | F | Correction to test case 10.1.5.1 | 16.1.0 |
| 2019-09 | RAN#85 | R5-197260 | 0880 | 1 | F | Update PDCP test case 7.1.3.4.1 | 16.1.0 |
| 2019-09 | RAN#85 | R5-197263 | 0915 | 2 | F | Correction to NR test case 7.1.1.2.1 | 16.1.0 |
| 2019-09 | RAN#85 | R5-197264 | 0916 | 2 | F | Correction to NR test case 7.1.1.3.1 | 16.1.0 |
| 2019-09 | RAN#85 | R5-197266 | 1027 | 1 | F | Correction to test case 7.1.2.3.8 | 16.1.0 |
| 2019-09 | RAN#85 | R5-197267 | 0922 | 1 | F | Initial registration / 5GS services / NSSAI handling / NSSAI Storage | 16.1.0 |
| 2019-09 | RAN#85 | R5-197292 | 1044 | - | F | Update of 5GC test case 9.1.1.1 | 16.1.0 |
| 2019-09 | RAN#85 | R5-197297 | 1045 | - | F | Update of 5GC test case 9.1.1.3 | 16.1.0 |
| 2019-09 | RAN#85 | R5-197299 | 1005 | 2 | F | Correction to NR MAC test case 7.1.1.3.2 | 16.1.0 |
| 2019-09 | RAN#85 | R5-197661 | 1037 | 1 | F | Update to NR MAC Bandwidth Part operation TC 7.1.1.8.1 | 16.1.0 |
| 2019-09 | RAN#85 | R5-197662 | 1042 | 1 | F | Corrections to NR MAC test case 7.1.1.1.1a | 16.1.0 |
| 2019-09 | RAN#85 | R5-197663 | 0900 | 2 | F | Correction to TC 7.1.2.3.4-18 bit SN processing | 16.1.0 |
| 2019-09 | RAN#85 | R5-197664 | 1022 | 3 | F | Correction to ENDC test case 7.1.2.3.3 | 16.1.0 |
| 2019-09 | RAN#85 | R5-197665 | 1041 | 1 | F | Correction to EN-DC RRC Test case 8.2.3.13.1 | 16.1.0 |
| 2019-09 | RAN#85 | R5-197666 | 1040 | 1 | F | Correction to NR test case 9.1.3.1-Identification procedure | 16.1.0 |
| 2019-12 | RAN#86 | R5-197740 | 1046 | - | F | Update RRC reconfiguration test case 8.1.2.1.4 | 16.2.0 |
| 2019-12 | RAN#86 | R5-197741 | 1047 | - | F | Update RRC reconfiguration test case 8.1.2.1.5.1 | 16.2.0 |
| 2019-12 | RAN#86 | R5-197744 | 1049 | - | F | Update RRC reconfiguration test case 8.1.3.1.18.1 | 16.2.0 |
| 2019-12 | RAN#86 | R5-197745 | 1050 | - | F | Update RRC reconfiguration test case 8.1.5.6.5.1 | 16.2.0 |
| 2019-12 | RAN#86 | R5-197838 | 1054 | - | F | Update of TC 6.4.1.1-HPLMN in Automatic PLMN Selection Mode | 16.2.0 |
| 2019-12 | RAN#86 | R5-197839 | 1055 | - | F | Correction to NR test case 6.1.2.14-Cell reselection CellReservedForOperatorUse with Access Identity 11 or 15 | 16.2.0 |
| 2019-12 | RAN#86 | R5-197840 | 1056 | - | F | Correction of NR test case 6.2.3.2-Inter-RAT cell reselection from L2NR | 16.2.0 |
| 2019-12 | RAN#86 | R5-197841 | 1057 | - | F | Correction of NR test case 6.2.3.4-Inter-RAT cell reselection from NR2L | 16.2.0 |
| 2019-12 | RAN#86 | R5-197842 | 1058 | - | F | Correction of NR test case 6.2.3.5-Inter-RAT cell reselection from N2L by dedicated signalling | 16.2.0 |
| 2019-12 | RAN#86 | R5-197843 | 1059 | - | F | Correction of NR test case 6.2.3.6-Inter-RAT cell reselection from L2N by dedicated signalling | 16.2.0 |
| 2019-12 | RAN#86 | R5-197849 | 1065 | - | F | Correction to NR test case 7.1.2.3.5-Control of receive window for AM RLC | 16.2.0 |
| 2019-12 | RAN#86 | R5-197854 | 1070 | - | F | Correction of NR test case 8.1.3.1.2 - Event A3 Intra-Freq | 16.2.0 |
| 2019-12 | RAN#86 | R5-197856 | 1072 | - | F | Correction to NR TC 8.1.3.1.8-Event A5 Intra-Freq | 16.2.0 |
| 2019-12 | RAN#86 | R5-197860 | 1076 | - | F | Correction to NR test case 8.1.5.3.1-PWS reception in NR RRC_IDLE state | 16.2.0 |
| 2019-12 | RAN#86 | R5-197867 | 1083 | - | F | Correction to NR test case 9.1.6.2.2-Re-registration not required | 16.2.0 |
| 2019-12 | RAN#86 | R5-197904 | 1089 | - | F | Correction to NR MAC test case 7.1.1.3.5 to accommodate the DCI format change to DCI_0_1 | 16.2.0 |
| 2019-12 | RAN#86 | R5-198006 | 1099 | - | F | Addition of new 5GC test case 9.1.2.3 | 16.2.0 |
| 2019-12 | RAN#86 | R5-198085 | 1110 | - | F | Update of References in 38.523-1 | 16.2.0 |
| 2019-12 | RAN#86 | R5-198086 | 1111 | - | F | Introduction of new TC 9.1.5.2.6 Mobility registration update / | 16.2.0 |

| | | | | | | Registered slice(s) change | |
|---------|--------|-----------|------|---|---|--|--------|
| 2019-12 | RAN#86 | R5-198147 | 1127 | - | F | Updates to 5GMM test case 9.1.4.1 for NAS cells definition in pre-test conditions | 16.2.0 |
| 2019-12 | RAN#86 | R5-198148 | 1128 | - | F | Updates to 5GMM initial registration test cases for NAS cells definition in pre-test conditions | 16.2.0 |
| 2019-12 | RAN#86 | R5-198180 | 1130 | - | F | Correction to PDCP Test Case 7.1.3.5.3 | 16.2.0 |
| 2019-12 | RAN#86 | R5-198181 | 1131 | - | F | Correction to EN-DC Inter-RAT Measurement Test Cases 8.2.3.1.1, 8.2.3.2.1, 8.2.3.3.1, 8.2.3.12.1 | 16.2.0 |
| 2019-12 | RAN#86 | R5-198184 | 1134 | - | F | Corrections to 5GC NAS Test Case 10.1.1.1 | 16.2.0 |
| 2019-12 | RAN#86 | R5-198185 | 1135 | - | F | Corrections to 5GC NAS Test Case 9.1.6.1.3 | 16.2.0 |
| 2019-12 | RAN#86 | R5-198186 | 1136 | - | F | Corrections to 5GC NAS Test Case 9.1.4.1 | 16.2.0 |
| 2019-12 | RAN#86 | R5-198187 | 1137 | - | F | Correction to RLC Test Case 7.1.2.3.5 | 16.2.0 |
| 2019-12 | RAN#86 | R5-198188 | 1138 | - | F | Correction to RLC Test Case 7.1.2.3.11 | 16.2.0 |
| 2019-12 | RAN#86 | R5-198189 | 1139 | - | F | Correction to 5GC NAS NSSAI Test Case 9.1.5.1.3a | 16.2.0 |
| 2019-12 | RAN#86 | R5-198216 | 1149 | - | F | Correction to TC 7.1.1.1.2 | 16.2.0 |
| 2019-12 | RAN#86 | R5-198235 | 1151 | - | F | Correction to 5GC test case 9.1.1.1 | 16.2.0 |
| 2019-12 | RAN#86 | R5-198242 | 1153 | - | F | Correction to 5GC test case 9.1.1.2 | 16.2.0 |
| 2019-12 | RAN#86 | R5-198299 | 1164 | - | F | Correction to NR TC 9.1.5.1.9 | 16.2.0 |
| 2019-12 | RAN#86 | R5-198322 | 1166 | - | F | Corrections to 5GC test case 10.1.1.2 | 16.2.0 |
| 2019-12 | RAN#86 | R5-198323 | 1167 | - | F | Correction to NR MAC test case 7.1.1.1.2 | 16.2.0 |
| 2019-12 | RAN#86 | R5-198325 | 1168 | - | F | Correction to 5GC test case 9.1.5.1.6 | 16.2.0 |
| 2019-12 | RAN#86 | R5-198331 | 1169 | - | F | Correction to NR MAC test cases 7.1.1.2.1 and 7.1.1.3.1 | 16.2.0 |
| 2019-12 | RAN#86 | R5-198355 | 1174 | - | F | Correction to ENDC RLC AM testcases 7.1.2.3.1 and 7.1.2.3.2 | 16.2.0 |
| 2019-12 | RAN#86 | R5-198361 | 1176 | - | F | Update to test case 10.2.1.1 to align EPS bearer ID description | 16.2.0 |
| 2019-12 | RAN#86 | R5-198362 | 1177 | - | F | Update to test case 11.1.5 to align EPS bearer ID description | 16.2.0 |
| 2019-12 | RAN#86 | R5-198438 | 1182 | - | F | Updates of 5GC test case titles | 16.2.0 |
| 2019-12 | RAN#86 | R5-198757 | 1199 | - | F | Correction to test cases 8.1.1.2.3 | 16.2.0 |
| 2019-12 | RAN#86 | R5-198759 | 1200 | - | F | Correction to NR MAC test case 7.1.1.3.2b | 16.2.0 |
| 2019-12 | RAN#86 | R5-198772 | 1210 | - | F | Correction to test case 9.1.5.2.7 | 16.2.0 |
| 2019-12 | RAN#86 | R5-198784 | 1214 | - | F | Corrections to MAC Test Case 7.1.1.5.3 | 16.2.0 |
| 2019-12 | RAN#86 | R5-198786 | 1215 | - | F | Update of 5GC TC 9.1.5.2.9 | 16.2.0 |
| 2019-12 | RAN#86 | R5-198825 | 1219 | - | F | Update of test case 8.1.5.1.1 | 16.2.0 |
| 2019-12 | RAN#86 | R5-198874 | 1053 | 1 | F | Addition of NR TC 6.1.2.11-systemInformationArealD | 16.2.0 |
| 2019-12 | RAN#86 | R5-198875 | 1060 | 1 | F | Correction of NR test case 6.2.3.7-Inter-RAT cell reselection N2L, Snonintra search | 16.2.0 |
| 2019-12 | RAN#86 | R5-198877 | 1132 | 1 | F | Corrections to Idle Mode SoR Test Case 6.3.1.1 | 16.2.0 |
| 2019-12 | RAN#86 | R5-198878 | 1133 | 1 | F | Corrections to Idle Mode SoR Test Case 6.3.1.2 | 16.2.0 |
| 2019-12 | RAN#86 | R5-198879 | 1178 | 1 | F | Correction to FR1 power levels for several test cases | 16.2.0 |
| 2019-12 | RAN#86 | R5-198880 | 1195 | 1 | F | Update to test cases 6.1.1.7 and 6.1.1.8 | 16.2.0 |
| 2019-12 | RAN#86 | R5-198881 | 1196 | 1 | F | Update to test cases 6.2.1.1 and 6.2.1.5 | 16.2.0 |
| 2019-12 | RAN#86 | R5-198882 | 1197 | 1 | F | Update to test cases 6.2.1.2, 6.2.1.3 and 6.2.1.4 | 16.2.0 |
| 2019-12 | RAN#86 | R5-198883 | 1183 | 1 | F | Update FR2 power of NR TC 7.1.1.1.3-SI request | 16.2.0 |
| 2019-12 | RAN#86 | R5-198884 | 1091 | 1 | F | Correction to NR MAC test case 7.1.1.4.2.1 | 16.2.0 |
| 2019-12 | RAN#86 | R5-198885 | 1129 | 1 | F | Correction to NR MAC transport size selection test cases | 16.2.0 |
| 2019-12 | RAN#86 | R5-198886 | 1145 | 1 | F | Corrections to MAC Test Case 7.1.1.1.1 | 16.2.0 |
| 2019-12 | RAN#86 | R5-198887 | 1154 | 1 | F | Update to NR MAC test case 7.1.1.1.5 | 16.2.0 |
| 2019-12 | RAN#86 | R5-198888 | 1158 | 1 | F | Correction to EN-DC MAC Test Case 7.1.1.1.1a | 16.2.0 |
| 2019-12 | RAN#86 | R5-198889 | 1184 | 1 | F | Correction to MAC test case 7.1.1.7.1 | 16.2.0 |
| 2019-12 | RAN#86 | R5-198890 | 1186 | 1 | F | Addition of new MAC test case for data inactivity timer | 16.2.0 |
| 2019-12 | RAN#86 | R5-198891 | 1187 | 1 | F | Split of CA MAC test case into 3 variants | 16.2.0 |
| 2019-12 | RAN#86 | R5-198892 | 1095 | 1 | F | Correction to NR test case 7.1.2.3.10-Re-transmission of RLC PDU | 16.2.0 |
| 2019-12 | RAN#86 | R5-198893 | 1090 | 1 | F | Correction to NR RLC test cases to accommodate the DCI format change to DCI_0_1 | 16.2.0 |
| 2019-12 | RAN#86 | R5-198894 | 1093 | 1 | F | Correction to RLC UM test case 7.1.2.2.5 | 16.2.0 |
| 2019-12 | RAN#86 | R5-198900 | 1123 | 1 | F | Correction to NR RLC test case 7.1.2.3.10 | 16.2.0 |
| 2019-12 | RAN#86 | R5-198901 | 1157 | 1 | F | Correction to RLC test case 7.1.2.2.6 in EN-DC | 16.2.0 |
| 2019-12 | RAN#86 | R5-198902 | 1172 | 1 | F | Correction to RLC AM test case 7.1.2.3.9 | 16.2.0 |
| 2019-12 | RAN#86 | R5-198903 | 1193 | 1 | F | Correction to RLC AM Test case 7.1.2.3.8 | 16.2.0 |
| 2019-12 | RAN#86 | R5-198904 | 1122 | 1 | F | Correction to NR PDCP test case 7.1.3.4.2 | 16.2.0 |
| 2019-12 | RAN#86 | R5-198905 | 1141 | 1 | F | Corrections to PDCP Test Case 7.1.3.5.2 | 16.2.0 |
| 2019-12 | RAN#86 | R5-198906 | 1150 | 1 | F | Correction to PDCP TC 7.1.3.4.1 | 16.2.0 |
| 2019-12 | RAN#86 | R5-198907 | 1092 | 1 | F | Corrections to SDAP test cases 7.1.4.1 and 7.1.4.2 | 16.2.0 |
| 2019-12 | RAN#86 | R5-198909 | 1221 | - | F | Correction to NR TCs | 16.2.0 |
| 2019-12 | RAN#86 | R5-198910 | 1175 | 1 | F | Update to 5GS NR RRC test case 8.1.1.3.2 | 16.2.0 |
| 2019-12 | RAN#86 | R5-198911 | 1198 | 1 | F | Correction to test case 8.1.1.2.1 | 16.2.0 |
| 2019-12 | RAN#86 | R5-198912 | 1201 | 1 | F | Correction to test case 8.1.1.4.1 | 16.2.0 |
| 2019-12 | RAN#86 | R5-198913 | 1066 | 1 | F | Addition of NR test case 8.1.2.1.2-uplinkTxDirectCurrentList | 16.2.0 |
| 2019-12 | RAN#86 | R5-198914 | 1048 | 1 | F | Update RRC reconfiguration test case 8.1.3.1.17.1 | 16.2.0 |
| 2019-12 | RAN#86 | R5-198915 | 1067 | 1 | F | Addition of NR TC 8.1.3.3.1-CGI reporting of NR cell | 16.2.0 |
| 2019-12 | RAN#86 | R5-198916 | 1068 | 1 | F | Addition of NR TC 8.1.3.3.2-CGI reporting of E-UTRA cell | 16.2.0 |
| 2019-12 | RAN#86 | R5-198917 | 1071 | 1 | F | Correction to NR TC 8.1.3.1.5-Event A4 Intra-Freq | 16.2.0 |
| 2019-12 | RAN#86 | R5-198918 | 1073 | 1 | F | correction of NR TC 8.1.3.1.18.1-Additional measurement report of | 16.2.0 |

| | | | | | | Intra-band Contiguous CA | |
|---------|--------|-----------|------|---|---|--|--------|
| 2019-12 | RAN#86 | R5-198920 | 1222 | - | F | correction of NR TCs 8.1.3.2.1 and TC 8.1.3.2.2 | 16.2.0 |
| 2019-12 | RAN#86 | R5-198921 | 1220 | 1 | F | Update of test case 8.1.3.2.4 | 16.2.0 |
| 2019-12 | RAN#86 | R5-198922 | 1075 | 1 | F | Correction to NR test case 8.1.4.2.2.1 E-UTRA To NR handover success | 16.2.0 |
| 2019-12 | RAN#86 | R5-198923 | 1203 | 1 | F | Correction to test case 8.1.4.2.2.1 | 16.2.0 |
| 2019-12 | RAN#86 | R5-198924 | 1119 | 1 | F | Correction to 5GS SA RRC test case 8.1.4.1.5 | 16.2.0 |
| 2019-12 | RAN#86 | R5-198925 | 1077 | 1 | F | Correction to NR test case 8.1.5.3.4-PWS reception using dedicatedSystemInformationDelivery | 16.2.0 |
| 2019-12 | RAN#86 | R5-198926 | 1204 | 1 | F | Correction to test case 8.1.5.5.1 | 16.2.0 |
| 2019-12 | RAN#86 | R5-198927 | 1173 | 1 | F | Update to 5GS NR RRC test case 8.1.5.4.1 | 16.2.0 |
| 2019-12 | RAN#86 | R5-198928 | 1148 | 1 | F | Correction to ENDC test case 8.2.2.8.1 | 16.2.0 |
| 2019-12 | RAN#86 | R5-198930 | 1216 | 1 | F | Correction to test case 8.2.2.6.1 | 16.2.0 |
| 2019-12 | RAN#86 | R5-198931 | 1078 | 1 | F | Correction to NR test case 8.2.3.11.X-ENDC-GAP | 16.2.0 |
| 2019-12 | RAN#86 | R5-198932 | 1125 | 1 | F | Correction to EN-DC RRC measurement test case 8.2.3.9.1 | 16.2.0 |
| 2019-12 | RAN#86 | R5-198933 | 1126 | 1 | F | Correction to EN-DC RRC measurement test case 8.2.3.10.1 | 16.2.0 |
| 2019-12 | RAN#86 | R5-198935 | 1069 | 1 | F | Addition of NR TC 8.2.6.2.1-Processing delay of ENDC | 16.2.0 |
| 2019-12 | RAN#86 | R5-198937 | 1096 | 1 | F | Addition of 5GC test case 9.1.1.5 | 16.2.0 |
| 2019-12 | RAN#86 | R5-198938 | 1152 | 1 | F | Correction to 5GC test case 9.1.1.3 | 16.2.0 |
| 2019-12 | RAN#86 | R5-198939 | 1080 | 1 | F | Correction to NR test case 9.1.2.1-NAS security mode command | 16.2.0 |
| 2019-12 | RAN#86 | R5-198940 | 1100 | 1 | F | Addition of new 5GC test case 9.1.2.4 | 16.2.0 |
| 2019-12 | RAN#86 | R5-198941 | 1101 | 1 | F | Addition of new 5GC test case 9.1.2.5 | 16.2.0 |
| 2019-12 | RAN#86 | R5-198942 | 1103 | 1 | F | Addition of new 5GC test case 9.1.2.7 | 16.2.0 |
| 2019-12 | RAN#86 | R5-198943 | 1104 | 1 | F | Addition of new 5GC test case 9.1.2.8 | 16.2.0 |
| 2019-12 | RAN#86 | R5-198944 | 1102 | 1 | F | Addition of new 5GC test case 9.1.2.6 | 16.2.0 |
| 2019-12 | RAN#86 | R5-198947 | 1052 | 1 | F | Correction to 5GC TC 9.1.5.1.12 | 16.2.0 |
| 2019-12 | RAN#86 | R5-198948 | 1081 | 1 | F | Correction to NR test case 9.1.5.1.10-PLMN not allowed | 16.2.0 |
| 2019-12 | RAN#86 | R5-198949 | 1082 | 1 | F | Correction to NR test case 9.1.6.1.2-Transmission failure of De-registration | 16.2.0 |
| 2019-12 | RAN#86 | R5-198950 | 1084 | 1 | F | Update of NR TC 9.1.7.2-Service request | 16.2.0 |
| 2019-12 | RAN#86 | R5-198951 | 1140 | 1 | F | Correction to 5GC NAS NSSAI Test Case 9.1.5.1.3 | 16.2.0 |
| 2019-12 | RAN#86 | R5-198952 | 1189 | 1 | F | Correction to NR5GC test case 9.1.5.1.5 | 16.2.0 |
| 2019-12 | RAN#86 | R5-198953 | 1208 | 1 | F | Correction to test case 9.1.5.1.2 | 16.2.0 |
| 2019-12 | RAN#86 | R5-198954 | 1217 | 1 | F | Update of 5GC TC 9.1.6.1.4 | 16.2.0 |
| 2019-12 | RAN#86 | R5-198972 | 1098 | 1 | F | Correction to 5GC test case 10.1.2.1 | 16.2.0 |
| 2019-12 | RAN#86 | R5-198975 | 1112 | 1 | F | Update of 11.1.7 Emergency call setup from NR RRC_IDLE - Emergency Services Fallback to EPS with redirection | 16.2.0 |
| 2019-12 | RAN#86 | R5-198977 | 1224 | - | F | Editorial improvements of Multilayer EPS Fallback test cases | 16.2.0 |
| 2019-12 | RAN#86 | R5-198978 | 1161 | 1 | F | Update EPS fallback test case 11.1.2 | 16.2.0 |
| 2019-12 | RAN#86 | R5-198979 | 1162 | 1 | F | Update EPS fallback test case 11.1.5 | 16.2.0 |
| 2019-12 | RAN#86 | R5-198980 | 1163 | 1 | F | Update EPS fallback test case 11.1.6 | 16.2.0 |
| 2019-12 | RAN#86 | R5-198981 | 1170 | 1 | F | Correction to test case 11.1.4 | 16.2.0 |
| 2019-12 | RAN#86 | R5-198982 | 1171 | 1 | F | Correction to test case 11.1.3 | 16.2.0 |
| 2019-12 | RAN#86 | R5-198985 | 1106 | 1 | F | Addition of new UAC test case 11.3.4 | 16.2.0 |
| 2019-12 | RAN#86 | R5-198986 | 1113 | 1 | F | Update to TC 11.4.1 5GMM-REGISTERED.NORMAL-SERVICE / 5GMM-IDLE / Emergency call / ... / New emergency PDU session | 16.2.0 |
| 2019-12 | RAN#86 | R5-198987 | 1114 | 1 | F | Update to TC 11.4.2 5GMM-DEREGISTERED.LIMITED-SERVICE / Emergency call / ... / Handling of forbidden PLMNs | 16.2.0 |
| 2019-12 | RAN#86 | R5-198988 | 1115 | 1 | F | Update to TC 11.4.3 5GMM-DEREGISTERED.NO-SUPI / Emergency call / ... / Initial registration for emergency services | 16.2.0 |
| 2019-12 | RAN#86 | R5-198989 | 1116 | 1 | F | Introduction of new TC 11.4.4 5GMM-REGISTERED.ATTEMPTING-REGISTRATION-UPDATE T3346 running / Emergency call establishment | 16.2.0 |
| 2019-12 | RAN#86 | R5-198990 | 1117 | 1 | F | Introduction of new 11.4.5 5GMM-REGISTERED.LIMITED-SERVICE / 5GMM-IDLE / Emergency call establishment and release / Handling of 5GS forbidden tracking areas for roaming | 16.2.0 |
| 2019-12 | RAN#86 | R5-198991 | 1118 | 1 | F | Introduction of new TC 11.4.6 5GMM-REGISTERED.NON-ALLOWED-SERVICE / Emergency call establishment and release / Handling of non-allowed tracking areas | 16.2.0 |
| 2019-12 | RAN#86 | R5-199000 | 1185 | 1 | F | Non 3GPP Access over WLAN test cases | 16.2.0 |
| 2019-12 | RAN#86 | R5-199027 | 1190 | 1 | F | Update of QBASED in pre-test condition for RSRQ test cases | 16.2.0 |
| 2019-12 | RAN#86 | R5-199028 | 1194 | 1 | F | Addition of NR Idle mode cell reselection test case 6.1.2.16 | 16.2.0 |
| 2019-12 | RAN#86 | R5-199029 | 1202 | 1 | F | Correction to test case 8.1.1.4.2 | 16.2.0 |
| 2019-12 | RAN#86 | R5-199030 | 1156 | 1 | F | Correction to RRC test case 8.2.2.1.1 | 16.2.0 |
| 2019-12 | RAN#86 | R5-199033 | 1223 | 1 | F | Corrections to Test Case 8.2.4.1.1.1 and 8.2.4.1.1.2 and 8.2.4.1.1.3 | 16.2.0 |
| 2019-12 | RAN#86 | R5-199034 | 1207 | 1 | F | Correction to test case 9.1.3.1 | 16.2.0 |
| 2019-12 | RAN#86 | R5-199035 | 1227 | - | F | New 5GC NAS test case 10.1.4.1 | 16.2.0 |
| 2019-12 | RAN#86 | R5-199036 | 1086 | 1 | F | Addition of new NR test case 11.3.6-Access Identity 2-accessibility AC7-RRC_INACTIVE | 16.2.0 |
| 2019-12 | RAN#86 | R5-199037 | 1105 | 1 | F | Addition of new UAC test case 11.3.3 | 16.2.0 |
| 2019-12 | RAN#86 | R5-199038 | 1191 | 1 | F | Correction to RRC test case 8.1.3.1.2 | 16.2.0 |
| 2019-12 | RAN#86 | R5-199072 | 1107 | 2 | F | Update of 5G Idle test case 6.1.2.23 | 16.2.0 |

| | | | | | | | |
|---------|--------|-----------|------|---|---|---|--------|
| 2019-12 | RAN#86 | R5-199095 | 1225 | 1 | F | Correction to NR RRC Test case 8.1.5.6.3 | 16.2.0 |
| 2019-12 | RAN#86 | R5-199096 | 1212 | 1 | F | Correction to test cases 8.2.3.6.1 / 1a and 1b | 16.2.0 |
| 2019-12 | RAN#86 | R5-199097 | 1228 | 1 | F | Corrections to EN-DC inter frequency and inter band measurement test cases | 16.2.0 |
| 2019-12 | RAN#86 | R5-199098 | 1079 | 2 | F | Correction to NR test case 9.1.1.6-5G AKA authentication abnormal | 16.2.0 |
| 2019-12 | RAN#86 | R5-199099 | 1211 | 2 | F | Correction to test case 9.1.7.1 | 16.2.0 |
| 2019-12 | RAN#86 | R5-199101 | 1051 | 2 | F | Correction to 5G TC 9.1.5.1.11 | 16.2.0 |
| 2019-12 | RAN#86 | R5-199102 | 1226 | 1 | F | Correction to NR Idle mode test case 6.1.2.1 | 16.2.0 |
| 2020-03 | RAN#87 | R5-200148 | 1250 | - | F | Correction to test case 6.1.1.6 | 16.3.0 |
| 2020-03 | RAN#87 | R5-200150 | 1252 | - | F | Correction to test case 8.1.3.1.16 | 16.3.0 |
| 2020-03 | RAN#87 | R5-200175 | 1268 | - | F | Correction to NR TC 6.2.3.9-Speed Dependent Cell Reselection N2L | 16.3.0 |
| 2020-03 | RAN#87 | R5-200182 | 1275 | - | F | Correction to NR TC 8.1.2.1.2-uplinkTxDirectCurrentList | 16.3.0 |
| 2020-03 | RAN#87 | R5-200185 | 1278 | - | F | Correction to NR TC 8.1.4.1.6-Handover Failure | 16.3.0 |
| 2020-03 | RAN#87 | R5-200187 | 1280 | - | F | Correction to NR TC 8.1.4.1.8.1-SCell no change Intra-band Contiguous CA | 16.3.0 |
| 2020-03 | RAN#87 | R5-200188 | 1281 | - | F | Correction to NR TC 8.1.4.2.2.1-L2N Handover | 16.3.0 |
| 2020-03 | RAN#87 | R5-200195 | 1285 | - | F | Correction to NR TC 9.1.1.1-EAP-AKA related procedures | 16.3.0 |
| 2020-03 | RAN#87 | R5-200205 | 1295 | - | F | Correction to NR TC 9.1.5.2.2-Periodic Register T3512 | 16.3.0 |
| 2020-03 | RAN#87 | R5-200206 | 1296 | - | F | Correction to NR TC 9.1.5.2.8-Registration Reject 10 | 16.3.0 |
| 2020-03 | RAN#87 | R5-200208 | 1298 | - | F | Correction to NR TC 9.1.6.1.3-Deregistration in new TA | 16.3.0 |
| 2020-03 | RAN#87 | R5-200211 | 1301 | - | F | Correction to NR TC 9.3.1.1-5GC to EPC | 16.3.0 |
| 2020-03 | RAN#87 | R5-200213 | 1303 | - | F | Correction to NR TC 10.1.1.1-Authentication during PDU establish | 16.3.0 |
| 2020-03 | RAN#87 | R5-200214 | 1304 | - | F | Correction to NR TC 10.1.1.2-Authentication after PDU establish | 16.3.0 |
| 2020-03 | RAN#87 | R5-200221 | 1311 | - | F | Correction to NR RLC test case 7.1.2.3.10 | 16.3.0 |
| 2020-03 | RAN#87 | R5-200226 | 1313 | - | F | Adding core specs to section References | 16.3.0 |
| 2020-03 | RAN#87 | R5-200227 | 1314 | - | F | Corrections to IMS Emergency Services TC 11.4.1 | 16.3.0 |
| 2020-03 | RAN#87 | R5-200229 | 1316 | - | F | Corrections to IMS Emergency Services TC 11.4.2 | 16.3.0 |
| 2020-03 | RAN#87 | R5-200230 | 1317 | - | F | Corrections to IMS Emergency Services TC 11.4.4 | 16.3.0 |
| 2020-03 | RAN#87 | R5-200232 | 1319 | - | F | Corrections to IMS Emergency Services TC 11.4.6 | 16.3.0 |
| 2020-03 | RAN#87 | R5-200233 | 1320 | - | F | Introduction of new TC 11.4.7 Handling of Local and extended emergency numbers / Mobility | 16.3.0 |
| 2020-03 | RAN#87 | R5-200234 | 1321 | - | F | Introduction of new TC 11.4.8 Handling of Local and extended emergency numbers / Switch-off and maximum local numbers storage | 16.3.0 |
| 2020-03 | RAN#87 | R5-200250 | 1326 | - | F | Corrections to NR RLC test case 7.1.2.3.8 | 16.3.0 |
| 2020-03 | RAN#87 | R5-200253 | 1329 | - | F | Corrections to EN-DC test case 8.2.2.3.1 | 16.3.0 |
| 2020-03 | RAN#87 | R5-200254 | 1330 | - | F | Corrections to 5GC test case 9.1.5.1.1 | 16.3.0 |
| 2020-03 | RAN#87 | R5-200338 | 1332 | - | F | Correction to NR TC 6.1.1.3-Cell reselection of ePLMN in manual mode | 16.3.0 |
| 2020-03 | RAN#87 | R5-200339 | 1333 | - | F | Correction to NR TC 6.4.1.2-Cell reselection of ePLMN in manual mode INACTIVE | 16.3.0 |
| 2020-03 | RAN#87 | R5-200341 | 1335 | - | F | Correction to NR TC 8.1.3.1.17.1-Event A6 | 16.3.0 |
| 2020-03 | RAN#87 | R5-200347 | 1338 | - | F | Correction to NR test case 8.1.5.2.1 | 16.3.0 |
| 2020-03 | RAN#87 | R5-200354 | 1342 | - | F | Correction to 5G RRC test case 8.1.1.2.3 | 16.3.0 |
| 2020-03 | RAN#87 | R5-200355 | 1343 | - | F | Correction to 5G RRC test case 8.1.1.4.1 | 16.3.0 |
| 2020-03 | RAN#87 | R5-200357 | 1345 | - | F | Correction to 5G UAC test case 11.3.3 | 16.3.0 |
| 2020-03 | RAN#87 | R5-200358 | 1346 | - | F | Correction to 5G UAC test case 11.3.4 | 16.3.0 |
| 2020-03 | RAN#87 | R5-200360 | 1348 | - | F | Update of 5GC test case 10.1.3.1 | 16.3.0 |
| 2020-03 | RAN#87 | R5-200366 | 1351 | - | F | Correction of NR test case 6.4.3.1-Inter-RAT cell reselection in RRC_INACTIVE | 16.3.0 |
| 2020-03 | RAN#87 | R5-200551 | 1354 | - | F | Correction to NR PDCP test case 7.1.3.5.5 | 16.3.0 |
| 2020-03 | RAN#87 | R5-200579 | 1358 | - | F | Corrections to RRC TC 8.2.2.7.1 | 16.3.0 |
| 2020-03 | RAN#87 | R5-200583 | 1362 | - | F | Correction to RRC TC 8.2.2.5.1 | 16.3.0 |
| 2020-03 | RAN#87 | R5-200587 | 1365 | - | F | Correction to 5G TC 9.1.5.2.1 | 16.3.0 |
| 2020-03 | RAN#87 | R5-200616 | 1373 | - | F | Update to 5GC test case 9.1.1.3 in 38.523-1 | 16.3.0 |
| 2020-03 | RAN#87 | R5-200622 | 1375 | - | F | Inclusion of 5G-NR Idle Mode TC 6.1.2.19 - Speed-dependent cell reselection | 16.3.0 |
| 2020-03 | RAN#87 | R5-200623 | 1376 | - | F | Update of RRC TC 8.1.5.6.5.1 | 16.3.0 |
| 2020-03 | RAN#87 | R5-200625 | 1377 | - | F | Update of RRC TC 8.2.3.12.1 | 16.3.0 |
| 2020-03 | RAN#87 | R5-200634 | 1378 | - | F | Corrections to NR MAC Test Case | 16.3.0 |
| 2020-03 | RAN#87 | R5-200673 | 1382 | - | F | Editorial correction: Assign title to section 10.1.4 | 16.3.0 |
| 2020-03 | RAN#87 | R5-200675 | 1384 | - | F | Correction to NR Idle mode test case 6.1.2.1 | 16.3.0 |
| 2020-03 | RAN#87 | R5-200680 | 1386 | - | F | Correction to NSSAI TC 9.1.5.1.3 | 16.3.0 |
| 2020-03 | RAN#87 | R5-200803 | 1398 | - | F | Correction to NR TC 8.1.3.1.23-Intra NR measurements | 16.3.0 |
| 2020-03 | RAN#87 | R5-200872 | 1403 | - | F | Correction to Multilayer TC 11.1.5 | 16.3.0 |
| 2020-03 | RAN#87 | R5-200877 | 1404 | - | F | Correction to Multilayer TC 11.1.6 | 16.3.0 |
| 2020-03 | RAN#87 | R5-200997 | 1249 | 1 | F | Correction to EN-DC RRC Test case 8.2.3.2.1 | 16.3.0 |
| 2020-03 | RAN#87 | R5-200999 | 1230 | 1 | F | Correction to NR RLC test case 7.1.2.3.5 | 16.3.0 |
| 2020-03 | RAN#87 | R5-201000 | 1248 | 1 | F | Correction to NR PDCP test case 7.1.3.5.3 | 16.3.0 |
| 2020-03 | RAN#87 | R5-201001 | 1236 | 1 | F | Correction to NR SDAP test case 7.1.4.2 | 16.3.0 |
| 2020-03 | RAN#87 | R5-201002 | 1243 | 1 | F | Correction to 5GMM test case 9.1.5.1.8 | 16.3.0 |
| 2020-03 | RAN#87 | R5-201006 | 1389 | 1 | F | Correction to NR TC 6.1.2.11-Area Specific SIBs using | 16.3.0 |

| | | | | | | systemInformationAreaID | |
|---------|--------|-----------|------|---|---|--|--------|
| 2020-03 | RAN#87 | R5-201007 | 1368 | 1 | F | Editorial Correction to TC 8.1.1.1.2 | 16.3.0 |
| 2020-03 | RAN#87 | R5-201009 | 1379 | 1 | F | Correction to Non 3GPP Access test cases | 16.3.0 |
| 2020-03 | RAN#87 | R5-201018 | 1374 | 1 | F | Correction to NR test case 8.2.3.8.1x | 16.3.0 |
| 2020-03 | RAN#87 | R5-201031 | 1312 | 1 | F | Adding generic test parameters references and updating subclause 5 | 16.3.0 |
| 2020-03 | RAN#87 | R5-201032 | 1315 | 1 | F | Update to IMS Emergency Services TC 11.4.1 for adding new TPs | 16.3.0 |
| 2020-03 | RAN#87 | R5-201033 | 1318 | 1 | F | Update of TC 11.4.4 5G Emergency Services to add a new TP | 16.3.0 |
| 2020-03 | RAN#87 | R5-201084 | 1287 | 1 | F | Correction to NR TC 9.1.1.6-5G AKA abnormal | 16.3.0 |
| 2020-03 | RAN#87 | R5-201085 | 1288 | 1 | F | Correction to NR TC 9.1.2.2-Initial NAS msg ciphering | 16.3.0 |
| 2020-03 | RAN#87 | R5-201086 | 1290 | 1 | F | Correction to NR TC 9.1.5.1.2-Equivalent PLMN list handling | 16.3.0 |
| 2020-03 | RAN#87 | R5-201087 | 1293 | 1 | F | Correction to NR TC 9.1.5.1.9-Change of cell into a new tracking area | 16.3.0 |
| 2020-03 | RAN#87 | R5-201088 | 1299 | 1 | F | Correction to NR TC 9.1.7.2-Service Request | 16.3.0 |
| 2020-03 | RAN#87 | R5-201089 | 1300 | 1 | F | Correction to NR TC 9.1.8.1-SMS | 16.3.0 |
| 2020-03 | RAN#87 | R5-201094 | 1353 | 1 | F | Correction to EN-DC RLC test case 7.1.2.3.11 | 16.3.0 |
| 2020-03 | RAN#87 | R5-201095 | 1385 | 1 | F | Correction to NR RLC AM test case 7.1.2.3.9 | 16.3.0 |
| 2020-03 | RAN#87 | R5-201096 | 1355 | 1 | F | Correction to NR PDCP Test cases 7.1.3.2.1, 7.1.3.2.2 and 7.1.3.2.3 | 16.3.0 |
| 2020-03 | RAN#87 | R5-201097 | 1381 | 1 | F | Correction to NR RRC measurement test case for SINR report of serving cell | 16.3.0 |
| 2020-03 | RAN#87 | R5-201098 | 1393 | 1 | F | Correction NR CA Test case 8.2.4.1.1.1 | 16.3.0 |
| 2020-03 | RAN#87 | R5-201100 | 1369 | 1 | F | Corrections to MAC TC 7.1.1.1.2 | 16.3.0 |
| 2020-03 | RAN#87 | R5-201101 | 1359 | 1 | F | Corrections to RRC TC 8.2.2.8.1 | 16.3.0 |
| 2020-03 | RAN#87 | R5-201103 | 1395 | 1 | F | Correction to test case 11.1.2 | 16.3.0 |
| 2020-03 | RAN#87 | R5-201107 | 1256 | 1 | F | Correction to 5GC TC 10.1.3.2 | 16.3.0 |
| 2020-03 | RAN#87 | R5-201112 | 1262 | 1 | F | Correction to NR TC 6.1.2.21-Cell reselection | 16.3.0 |
| 2020-03 | RAN#87 | R5-201113 | 1322 | 1 | F | Correction to NR TC 6.1.2.4-Cell Reselection for interband operation | 16.3.0 |
| 2020-03 | RAN#87 | R5-201114 | 1323 | 1 | F | Correction to NR TC 6.1.2.5-Cell reselection for interband operation Between FDD and TDD | 16.3.0 |
| 2020-03 | RAN#87 | R5-201115 | 1334 | 1 | F | Correction to NR TC 6.1.2.18-Cell reselection with parameters Sintrasearch and Snonintrasearch | 16.3.0 |
| 2020-03 | RAN#87 | R5-201117 | 1336 | 1 | F | Correction to NR test case 7.1.2.3.6 | 16.3.0 |
| 2020-03 | RAN#87 | R5-201118 | 1337 | 1 | F | Correction to NR test case 8.1.3.2.2 | 16.3.0 |
| 2020-03 | RAN#87 | R5-201119 | 1339 | 1 | F | Correction to NR test case 9.1.5.2.6 | 16.3.0 |
| 2020-03 | RAN#87 | R5-201125 | 1258 | 1 | F | Correction to NR TC 6.1.1.2-PLMN selection of Other PLMN | 16.3.0 |
| 2020-03 | RAN#87 | R5-201126 | 1259 | 1 | F | Correction to NR TC 6.1.1.4-PLMN selection in shared network environment with Automatic mode | 16.3.0 |
| 2020-03 | RAN#87 | R5-201127 | 1260 | 1 | F | Correction to NR TC 6.1.1.5-PLMN selection with Automatic mode and user reselection | 16.3.0 |
| 2020-03 | RAN#87 | R5-201128 | 1263 | 1 | F | Correction to NR TC 6.1.2.22-Inter frequency cell reselection based on common priority information | 16.3.0 |
| 2020-03 | RAN#87 | R5-201129 | 1264 | 1 | F | Correction to NR TC 6.2.3.2-Inter-RAT cell reselection L2N | 16.3.0 |
| 2020-03 | RAN#87 | R5-201130 | 1265 | 1 | F | Correction to NR TC 6.2.3.5-Inter-RAT cell reselection N2L by dedicated signalling | 16.3.0 |
| 2020-03 | RAN#87 | R5-201131 | 1266 | 1 | F | Correction to NR TC 6.2.3.6-Inter-RAT cell reselection | 16.3.0 |
| 2020-03 | RAN#87 | R5-201132 | 1267 | 1 | F | Correction to NR TC 6.2.3.8-Inter-RAT cell reselection L2N Snonintrasearch | 16.3.0 |
| 2020-03 | RAN#87 | R5-201133 | 1269 | 1 | F | Correction to NR TC 6.4.2.1-Inactive-Reselection | 16.3.0 |
| 2020-03 | RAN#87 | R5-201134 | 1270 | 1 | F | Correction to NR TC 7.1.1.1.4-Beam Failure | 16.3.0 |
| 2020-03 | RAN#87 | R5-201135 | 1272 | 1 | F | Correction to NR TC 8.1.1.3.1-Redirection | 16.3.0 |
| 2020-03 | RAN#87 | R5-201136 | 1273 | 1 | F | Correction to NR TC 8.1.1.3.3-With priority information of NR Cell | 16.3.0 |
| 2020-03 | RAN#87 | R5-201137 | 1274 | 1 | F | Correction to NR TC 8.1.1.3.4-With priority information of LTE Cell | 16.3.0 |
| 2020-03 | RAN#87 | R5-201138 | 1276 | 1 | F | Correction to NR TC 8.1.3.3.1-NR CGI | 16.3.0 |
| 2020-03 | RAN#87 | R5-201139 | 1277 | 1 | F | Correction to NR TC 8.1.3.3.2-LTE CGI | 16.3.0 |
| 2020-03 | RAN#87 | R5-201140 | 1279 | 1 | F | Correction to NR TC 8.1.4.1.7.1-PCell Change and SCell addition Intra-band Contiguous CA | 16.3.0 |
| 2020-03 | RAN#87 | R5-201141 | 1282 | 1 | F | Correction to NR TC 8.2.1.1.1-UE Capability | 16.3.0 |
| 2020-03 | RAN#87 | R5-201142 | 1286 | 1 | F | Correction to NR TC 9.1.1.2-Authentication Reject | 16.3.0 |
| 2020-03 | RAN#87 | R5-201143 | 1289 | 1 | F | Correction to NR TC 9.1.4.1-Generic UE configuration update | 16.3.0 |
| 2020-03 | RAN#87 | R5-201144 | 1294 | 1 | F | Correction to NR TC 9.1.5.1.14-RegisterReject 22 and T3346 | 16.3.0 |
| 2020-03 | RAN#87 | R5-201145 | 1297 | 1 | F | Correction to NR TC 9.1.6.1.2-UE initiated deregistration procedure | 16.3.0 |
| 2020-03 | RAN#87 | R5-201146 | 1306 | 1 | F | Correction to NR TC 10.1.4.1-T3580 | 16.3.0 |
| 2020-03 | RAN#87 | R5-201149 | 1324 | 1 | F | Update to NR MAC test case 7.1.1.1.5 | 16.3.0 |
| 2020-03 | RAN#87 | R5-201153 | 1310 | 1 | F | Correction to NR RLC test case 7.1.2.3.7 | 16.3.0 |
| 2020-03 | RAN#87 | R5-201170 | 1340 | 1 | F | Correction to NR RRC measurement Test cases 8.1.3.1.13 and 8.1.3.1.14A | 16.3.0 |
| 2020-03 | RAN#87 | R5-201171 | 1350 | 1 | F | Correction to NR test case 6.2.3.1 | 16.3.0 |
| 2020-03 | RAN#87 | R5-201200 | 1302 | 1 | F | Correction to NR TC 9.3.1.2-Inter-system mobility registration update EPC to 5GC | 16.3.0 |
| 2020-03 | RAN#87 | R5-201204 | 1253 | 1 | F | Update to test case 8.2.2.2.1 | 16.3.0 |
| 2020-03 | RAN#87 | R5-201206 | 1257 | 1 | F | Correction to NR TC 6.1.1.1-PLMN selection with Automatic mode | 16.3.0 |
| 2020-03 | RAN#87 | R5-201208 | 1231 | 1 | F | Correction to Inter-frequency Cell reselection test case 6.1.2.20 | 16.3.0 |

| | | | | | | | |
|---------|--------|-----------|------|---|---|--|--------|
| 2020-03 | RAN#87 | R5-201209 | 1232 | 1 | F | Correction to NR Idle mode test case 6.1.2.9 | 16.3.0 |
| 2020-03 | RAN#87 | R5-201210 | 1233 | 1 | F | Correction to NR MAC test case 7.1.1.1.2 | 16.3.0 |
| 2020-03 | RAN#87 | R5-201211 | 1234 | 1 | F | Correction to NR RLC test case 7.1.2.2.6 | 16.3.0 |
| 2020-03 | RAN#87 | R5-201212 | 1237 | 1 | F | Correction to NR RRC test case 8.1.1.4.1 | 16.3.0 |
| 2020-03 | RAN#87 | R5-201213 | 1239 | 1 | F | Correction to NR5GC IRAT test case 8.1.3.2.1 | 16.3.0 |
| 2020-03 | RAN#87 | R5-201214 | 1247 | 1 | F | Correction to NR5GC RRC test case 8.1.3.1.2 | 16.3.0 |
| 2020-03 | RAN#87 | R5-201215 | 1240 | 1 | F | Correction to NR5GC IRAT test case 8.1.4.2.1.1 | 16.3.0 |
| 2020-03 | RAN#87 | R5-201216 | 1383 | 1 | F | Correction to NR5GC RRC test case 8.1.1.2.1 | 16.3.0 |
| 2020-03 | RAN#87 | R5-201218 | 1327 | 1 | F | Enhancement of NR PDCP test cases 7.1.3.1.x | 16.3.0 |
| 2020-03 | RAN#87 | R5-201219 | 1328 | 1 | F | Corrections to NR PDCP test case 7.1.3.4.1 | 16.3.0 |
| 2020-03 | RAN#87 | R5-201223 | 1347 | 1 | F | Update of 5G Idle test case 6.1.2.23 | 16.3.0 |
| 2020-03 | RAN#87 | R5-201224 | 1341 | 1 | F | Correction to 5G RRC test case 8.2.4.3.1 | 16.3.0 |
| 2020-03 | RAN#87 | R5-201225 | 1392 | 1 | F | Correction to 5G RRC test case 8.2.4.3.1.3 | 16.3.0 |
| 2020-03 | RAN#87 | R5-201226 | 1352 | 1 | F | Correction to 5GC test case 10.1.2.2 | 16.3.0 |
| 2020-03 | RAN#87 | R5-201227 | 1344 | 1 | F | Correction to 5G UAC test case 11.3.6 | 16.3.0 |
| 2020-03 | RAN#87 | R5-201230 | 1399 | 1 | F | Corrections to EN-DC RRC TC 8.2.2.1.1 | 16.3.0 |
| 2020-03 | RAN#87 | R5-201231 | 1402 | 1 | F | Correction to Multilayer TC 11.1.1 | 16.3.0 |
| 2020-03 | RAN#87 | R5-201235 | 1396 | 2 | F | Correction to NR Idle mode test case 6.1.2.3 | 16.3.0 |
| 2020-03 | RAN#87 | R5-201236 | 1397 | 2 | F | Update of RRC TC 8.1.3.1.1 | 16.3.0 |
| 2020-03 | RAN#87 | R5-201241 | 1367 | 2 | F | Correction to 5G TC 9.1.7.1 | 16.3.0 |
| 2020-06 | RAN#88 | R5-201326 | 1405 | - | F | Correction to EN-DC Carrier Aggregation test case 8.2.4.1.1.1 | 16.4.0 |
| 2020-06 | RAN#88 | R5-201340 | 1408 | - | F | Correction to NR TC 6.1.2.18-Cell reselection with Sintrasearch and Snointrasearch | 16.4.0 |
| 2020-06 | RAN#88 | R5-201341 | 1409 | - | F | Correction to NR TC 6.1.2.19-N2N Speed dependent cell reselection | 16.4.0 |
| 2020-06 | RAN#88 | R5-201344 | 1412 | - | F | Correction to NR TC 6.2.3.9-N2L Speed dependent cell reselection | 16.4.0 |
| 2020-06 | RAN#88 | R5-201349 | 1417 | - | F | Correction to NR TC 6.4.1.1-PLMN selection Automatic mode in RRC_INACTIVE state | 16.4.0 |
| 2020-06 | RAN#88 | R5-201353 | 1421 | - | F | Correction to NR TC 8.1.2.1.4-RRC reconfiguration Dedicated RLF timer | 16.4.0 |
| 2020-06 | RAN#88 | R5-201356 | 1424 | - | F | Correction to NR TC 8.1.3.1.23-Continuation of the measurements after RRC Resume | 16.4.0 |
| 2020-06 | RAN#88 | R5-201361 | 1429 | - | F | Correction to NR TC 8.1.5.4.1-Reception of CounterCheck message by the UE | 16.4.0 |
| 2020-06 | RAN#88 | R5-201367 | 1434 | - | F | Addition of NR TC 8.1.5.8.1-Connected state latency check | 16.4.0 |
| 2020-06 | RAN#88 | R5-201372 | 1439 | - | F | Correction to NR TC 9.1.5.1.2-Equivalent PLMN list handling | 16.4.0 |
| 2020-06 | RAN#88 | R5-201379 | 1446 | - | F | Addition of new NR TC 11.3.5-UAC AI1-accessibility AC5-MMTEL-Video call | 16.4.0 |
| 2020-06 | RAN#88 | R5-201431 | 1461 | - | F | Correction to ENDC TC 7.1.3.3.2-Correct functionality of encryption algorithm AES | 16.4.0 |
| 2020-06 | RAN#88 | R5-201432 | 1462 | - | F | Correction to ENDC TC 7.1.3.3.3-Correct functionality of encryption algorithm ZUC | 16.4.0 |
| 2020-06 | RAN#88 | R5-201440 | 1470 | - | F | Correction to NR TC 6.1.2.2-Qualmin Serving Cell non-suitable | 16.4.0 |
| 2020-06 | RAN#88 | R5-201471 | 1479 | - | F | Addition of NR TC 6.2.2.1-N2L Serving cell becomes non-suitable | 16.4.0 |
| 2020-06 | RAN#88 | R5-201477 | 1482 | - | F | Correction to FR1 power level table for several test cases to not to assign beyond maximum power level -78 | 16.4.0 |
| 2020-06 | RAN#88 | R5-201484 | 1485 | - | F | Correction 7.1.2.3.7 to use downlink timing reference for scheduling less than 100ms timing gap | 16.4.0 |
| 2020-06 | RAN#88 | R5-201499 | 1486 | - | F | Correction to NR Idle mode test case 6.1.2.5 | 16.4.0 |
| 2020-06 | RAN#88 | R5-201500 | 1487 | - | F | Correction to NR idle mode test case 6.4.2.2 | 16.4.0 |
| 2020-06 | RAN#88 | R5-201501 | 1488 | - | F | Correction to NR MAC test case 7.1.1.1.1a | 16.4.0 |
| 2020-06 | RAN#88 | R5-201502 | 1489 | - | F | Correction to BWP Dependent Parameters for RA type 0 in MAC testcases | 16.4.0 |
| 2020-06 | RAN#88 | R5-201519 | 1497 | - | F | Corrections to MAC test cases for Logical Channel ID | 16.4.0 |
| 2020-06 | RAN#88 | R5-201574 | 1499 | - | F | Updates to NR RLC test case 7.1.2.3.11 | 16.4.0 |
| 2020-06 | RAN#88 | R5-201575 | 1500 | - | F | Enhancement of NR PDCP test case 7.1.3.1.1 | 16.4.0 |
| 2020-06 | RAN#88 | R5-201578 | 1503 | - | F | Correction to NR test cases 8.1.3.1.13 and 8.1.3.1.14A | 16.4.0 |
| 2020-06 | RAN#88 | R5-201629 | 1510 | - | F | Correction to 5GC TC 10.1.3.2 | 16.4.0 |
| 2020-06 | RAN#88 | R5-201632 | 1511 | - | F | Corrections to RRC TCs 8.2.3.1.1, 8.2.3.2.1, 8.2.3.3.1 and 8.2.3.12.1 | 16.4.0 |
| 2020-06 | RAN#88 | R5-201633 | 1512 | - | F | Addition of NR5G UAC TC 11.3.7 | 16.4.0 |
| 2020-06 | RAN#88 | R5-201637 | 1516 | - | F | Corrections to NR5G MAC TC 7.1.1.3.1 | 16.4.0 |
| 2020-06 | RAN#88 | R5-201638 | 1517 | - | F | Corrections to NR5G RRC TC 8.1.4.2.1.1 | 16.4.0 |
| 2020-06 | RAN#88 | R5-201644 | 1522 | - | F | Corrections to NR5G NAS TC 9.1.6.1.4 | 16.4.0 |
| 2020-06 | RAN#88 | R5-201646 | 1524 | - | F | Corrections to NR5G RRC TC 8.1.1.4.1 | 16.4.0 |
| 2020-06 | RAN#88 | R5-201650 | 1528 | - | F | Corrections to NR5G SDAP TC 7.1.4.2 | 16.4.0 |
| 2020-06 | RAN#88 | R5-201651 | 1529 | - | F | Corrections to NR5G RRC TC 8.1.5.4.1 | 16.4.0 |
| 2020-06 | RAN#88 | R5-201761 | 1538 | - | F | Correction to NR UE Capability test case 8.2.1.1.1 | 16.4.0 |
| 2020-06 | RAN#88 | R5-201790 | 1539 | - | F | Correction to NR idle mode test case 6.4.2.1 | 16.4.0 |
| 2020-06 | RAN#88 | R5-201791 | 1540 | - | F | Correction to NR5GC IRAT test case 6.2.3.1 | 16.4.0 |
| 2020-06 | RAN#88 | R5-201793 | 1542 | - | F | Removal of requirement of USIM configuration 14 from 5GMM Idle mode test cases | 16.4.0 |
| 2020-06 | RAN#88 | R5-201802 | 1545 | - | F | Update of RRC TC 8.2.3.12.1 | 16.4.0 |

| | | | | | | | |
|---------|--------|-----------|------|---|---|---|--------|
| 2020-06 | RAN#88 | R5-201913 | 1547 | - | F | Update of RRC TC 8.1.5.6.5.1 | 16.4.0 |
| 2020-06 | RAN#88 | R5-201943 | 1549 | - | F | Correction to NR TC 6.2.3.4-inter-RAT reselection | 16.4.0 |
| 2020-06 | RAN#88 | R5-202026 | 1559 | - | F | Corrections to NR MAC Test Case 7.1.1.3.2b | 16.4.0 |
| 2020-06 | RAN#88 | R5-202048 | 1560 | - | F | Corrections to EN-DC test case 8.2.3.12.1 | 16.4.0 |
| 2020-06 | RAN#88 | R5-202107 | 1561 | - | F | Editorial Corrections to NR5G MAC TC 7.1.1.1.2 | 16.4.0 |
| 2020-06 | RAN#88 | R5-202140 | 1564 | - | F | Addition of new DRX TC 7.1.1.5.5 for short DRX configured and Long DRX command MAC CE is received | 16.4.0 |
| 2020-06 | RAN#88 | R5-202178 | 1566 | - | F | Correction to 5G test case 6.2.1.2 | 16.4.0 |
| 2020-06 | RAN#88 | R5-202183 | 1567 | - | F | Editorial update to NR measurements test case 8.1.3.1.2 | 16.4.0 |
| 2020-06 | RAN#88 | R5-202185 | 1568 | - | F | Correction to 5G test case 6.2.1.3 | 16.4.0 |
| 2020-06 | RAN#88 | R5-202205 | 1569 | - | F | Correction to 5G test case 6.2.1.4 | 16.4.0 |
| 2020-06 | RAN#88 | R5-202221 | 1572 | - | F | Removal of 5GC test case 10.1.3.1 | 16.4.0 |
| 2020-06 | RAN#88 | R5-202411 | 1581 | - | F | Correction to EN-DC RRC test case 8.2.2.1.1 | 16.4.0 |
| 2020-06 | RAN#88 | R5-202506 | 1584 | - | F | Correction to NR PDCP test case 7.1.3.5.5 | 16.4.0 |
| 2020-06 | RAN#88 | R5-202530 | 1585 | - | F | Correction to NR CA RRC test cases 8.1.3.1.18.x | 16.4.0 |
| 2020-06 | RAN#88 | R5-202535 | 1442 | 1 | F | Correction to NR TC 9.3.1.3-Handling of EPC relevant parameters | 16.4.0 |
| 2020-06 | RAN#88 | R5-202537 | 1586 | - | F | Correction to NR RRC IDLE testcase 6.1.2.1 | 16.4.0 |
| 2020-06 | RAN#88 | R5-202538 | 1587 | - | F | Correction to the ENDC testcase 7.1.1.3.7 | 16.4.0 |
| 2020-06 | RAN#88 | R5-202539 | 1588 | - | F | Correction to NR MAC test case 7.1.1.3.3 | 16.4.0 |
| 2020-06 | RAN#88 | R5-202540 | 1589 | - | F | Correction to NR TC 8.2.3.2.1 | 16.4.0 |
| 2020-06 | RAN#88 | R5-202543 | 1554 | 1 | F | Correction to NR MAC test case 7.1.1.3.1 | 16.4.0 |
| 2020-06 | RAN#88 | R5-202550 | 1555 | 1 | F | Corrections to IMS Emergency Services TC 11.4.2 | 16.4.0 |
| 2020-06 | RAN#88 | R5-202551 | 1556 | 1 | F | Introduction of new IMS Emergency TC 11.4.9 5GMM-DEREGISTERED.LIMITED-SERVICE No suitable cells in tracking area call | 16.4.0 |
| 2020-06 | RAN#88 | R5-202592 | 1577 | 1 | F | Adding generic test parameters references to section 5.3 | 16.4.0 |
| 2020-06 | RAN#88 | R5-202593 | 1406 | 1 | F | Correction to NR TC 6.1.1.1-PLMN selection Automatic mode | 16.4.0 |
| 2020-06 | RAN#88 | R5-202594 | 1407 | 1 | F | Correction to NR TC 6.1.1.5-PLMN selection with Automatic mode and user reselection | 16.4.0 |
| 2020-06 | RAN#88 | R5-202595 | 1411 | 1 | F | Correction to NR TC 6.2.3.3-From NR RRC_IDLE to E-UTRA_IDLE | 16.4.0 |
| 2020-06 | RAN#88 | R5-202596 | 1413 | 1 | F | Correction to NR TC 6.3.1.1-Security check successful using List Type 1 | 16.4.0 |
| 2020-06 | RAN#88 | R5-202597 | 1416 | 1 | F | Correction to NR TC 6.3.1.4-Security check unsuccessful manual mode | 16.4.0 |
| 2020-06 | RAN#88 | R5-202598 | 1449 | 1 | F | Corrections to Idle Mode SoR Test Case 6.3.1.2 | 16.4.0 |
| 2020-06 | RAN#88 | R5-202599 | 1450 | 1 | F | Corrections to Idle Mode SoR Test Case 6.3.1.3 | 16.4.0 |
| 2020-06 | RAN#88 | R5-202600 | 1452 | 1 | F | Addition of Idle Mode SoR Test Case 6.3.1.5 | 16.4.0 |
| 2020-06 | RAN#88 | R5-202601 | 1453 | 1 | F | Addition of Idle Mode SoR Test Case 6.3.1.7 | 16.4.0 |
| 2020-06 | RAN#88 | R5-202602 | 1480 | 1 | F | Addition of NR TC 6.2.2.2-L2N Serving cell becomes non-suitable | 16.4.0 |
| 2020-06 | RAN#88 | R5-202603 | 1531 | 1 | F | Correction to NR5G Idle Mode TC 6.1.2.11 | 16.4.0 |
| 2020-06 | RAN#88 | R5-202604 | 1543 | 1 | F | Correction to NR TC 6.3.1.8-SoR after registration Automatic mode | 16.4.0 |
| 2020-06 | RAN#88 | R5-202605 | 1544 | 1 | F | Correction to NR TC 6.3.1.9-SoR after registration Manual mode | 16.4.0 |
| 2020-06 | RAN#88 | R5-202606 | 1570 | 1 | F | Correction to test case 6.1.2.23 | 16.4.0 |
| 2020-06 | RAN#88 | R5-202607 | 1474 | 1 | F | Correction to NR TC 7.1.1.4.2.x-TBS ambiguity of UL | 16.4.0 |
| 2020-06 | RAN#88 | R5-202608 | 1490 | 1 | F | Correction to NR MAC test case 7.1.1.4.2.3 | 16.4.0 |
| 2020-06 | RAN#88 | R5-202609 | 1558 | 1 | F | Corrections to NR DRX Test Cases | 16.4.0 |
| 2020-06 | RAN#88 | R5-202610 | 1574 | 1 | F | Corrections to MAC TBS test cases with dynamicSwitch | 16.4.0 |
| 2020-06 | RAN#88 | R5-202611 | 1583 | 1 | F | Correction to NR MAC CA Test Case | 16.4.0 |
| 2020-06 | RAN#88 | R5-202612 | 1498 | 1 | F | Editorial corrections to NR RLC test cases 7.1.2.3.x | 16.4.0 |
| 2020-06 | RAN#88 | R5-202613 | 1507 | 1 | F | Correction to 7.1.2.3.3 and 7.1.2.3.4 to reduce test execution time | 16.4.0 |
| 2020-06 | RAN#88 | R5-202614 | 1457 | 1 | F | Correction to ENDC TC 7.1.3.2.1-Correct functionality of Integrity algorithm SNOW3G | 16.4.0 |
| 2020-06 | RAN#88 | R5-202615 | 1458 | 1 | F | Correction to ENDC TC 7.1.3.2.2-Correct functionality of Integrity algorithm AES | 16.4.0 |
| 2020-06 | RAN#88 | R5-202616 | 1459 | 1 | F | Correction to ENDC TC 7.1.3.2.3-Correct functionality of Integrity algorithm ZUC | 16.4.0 |
| 2020-06 | RAN#88 | R5-202617 | 1460 | 1 | F | Correction to ENDC TC 7.1.3.3.1-Correct functionality of encryption algorithm SNOW3G | 16.4.0 |
| 2020-06 | RAN#88 | R5-202618 | 1520 | 1 | F | Corrections to NR5G PDCP TC 7.1.3.4.1 and 7.1.3.4.2 | 16.4.0 |
| 2020-06 | RAN#88 | R5-202619 | 1418 | 1 | F | Correction to NR TC 8.1.1.2.1-T300 expiry | 16.4.0 |
| 2020-06 | RAN#88 | R5-202620 | 1419 | 1 | F | Correction to NR TC 8.1.1.3.2-Redirection from NR to E-UTRA | 16.4.0 |
| 2020-06 | RAN#88 | R5-202621 | 1464 | 1 | F | Correction to test case 8.1.1.3.1 | 16.4.0 |
| 2020-06 | RAN#88 | R5-202622 | 1465 | 1 | F | Correction to test case 8.1.1.3.3 | 16.4.0 |
| 2020-06 | RAN#88 | R5-202623 | 1466 | 1 | F | Correction to test case 8.1.1.3.4 | 16.4.0 |
| 2020-06 | RAN#88 | R5-202624 | 1467 | 1 | F | Correction to test case 8.1.1.4.1 | 16.4.0 |
| 2020-06 | RAN#88 | R5-202625 | 1468 | 1 | F | Correction to test case 8.1.1.4.2 | 16.4.0 |
| 2020-06 | RAN#88 | R5-202626 | 1469 | 1 | F | Correction to test case 8.1.2.1.1 | 16.4.0 |
| 2020-06 | RAN#88 | R5-202627 | 1515 | 1 | F | Corrections to NR5G RRC TC 8.2.2.6.1 | 16.4.0 |
| 2020-06 | RAN#88 | R5-202628 | 1576 | 1 | F | Update RRC TC 8.1.2.1.5 | 16.4.0 |
| 2020-06 | RAN#88 | R5-202629 | 1582 | 1 | F | Corrections to EN-DC RRC TC 8.2.2.7.1 | 16.4.0 |
| 2020-06 | RAN#88 | R5-202630 | 1422 | 1 | F | Correction to NR TC 8.1.3.1.11-Two RSRQ event A3 | 16.4.0 |
| 2020-06 | RAN#88 | R5-202631 | 1423 | 1 | F | Correction to NR TC 8.1.3.1.16-Intra NR measurements with | 16.4.0 |

| | | | | | | Whitelisting | |
|---------|--------|-----------|------|---|---|--|--------|
| 2020-06 | RAN#88 | R5-202632 | 1425 | 1 | F | Correction to NR TC 8.1.3.2.3-RSRQ event B2 | 16.4.0 |
| 2020-06 | RAN#88 | R5-202633 | 1426 | 1 | F | Correction to NR TC 8.1.3.3.1-NR CGI | 16.4.0 |
| 2020-06 | RAN#88 | R5-202634 | 1427 | 1 | F | Correction to NR TC 8.1.3.3.2-LTE CGI | 16.4.0 |
| 2020-06 | RAN#88 | R5-202635 | 1501 | 1 | F | Corrections to NR measurement test cases 8.1.3.x | 16.4.0 |
| 2020-06 | RAN#88 | R5-202636 | 1518 | 1 | F | Corrections to NR5G RRC TC 8.1.3.1.15A | 16.4.0 |
| 2020-06 | RAN#88 | R5-202637 | 1536 | 1 | F | Correction to NR TC 8.1.3.1.15a-Intra NR measurements with Blacklisting | 16.4.0 |
| 2020-06 | RAN#88 | R5-202638 | 1550 | 1 | F | Correction to NR TC 8.1.3.2.4-SINR event B2 | 16.4.0 |
| 2020-06 | RAN#88 | R5-202639 | 1428 | 1 | F | Correction to NR TC 8.1.4.2.2.1-L2N handover | 16.4.0 |
| 2020-06 | RAN#88 | R5-202640 | 1492 | 1 | F | Correction to NR5G IRAT test case 8.1.4.2.1.1 | 16.4.0 |
| 2020-06 | RAN#88 | R5-202641 | 1563 | 1 | F | Correction to NR RRC test case 8.1.4.1.2 to update the security | 16.4.0 |
| 2020-06 | RAN#88 | R5-202642 | 1433 | 1 | F | Addition of NR TC 8.1.5.7.1-MCG RLC failure | 16.4.0 |
| 2020-06 | RAN#88 | R5-202643 | 1506 | 1 | F | Updates on RRC others TC 8.1.5.2.2 | 16.4.0 |
| 2020-06 | RAN#88 | R5-202644 | 1546 | 1 | F | Corrections to NR5G RRC TC 8.1.5.5.1 | 16.4.0 |
| 2020-06 | RAN#88 | R5-202645 | 1483 | 1 | F | Correction to 8.2.2.8.1 not to check reception of RRCReconfigurationComplete if RRCReconfiguration is not sent | 16.4.0 |
| 2020-06 | RAN#88 | R5-202646 | 1493 | 1 | F | Correction to EN-DC RRC test case 8.2.2.7.1 | 16.4.0 |
| 2020-06 | RAN#88 | R5-202647 | 1505 | 1 | F | Corrections to EN-DC test case 8.2.2.3.1 | 16.4.0 |
| 2020-06 | RAN#88 | R5-202648 | 1526 | 1 | F | Addition of NRDC RRC TC 8.2.2.4.2 | 16.4.0 |
| 2020-06 | RAN#88 | R5-202649 | 1527 | 1 | F | Addition of NRDC RRC TC 8.2.2.5.2 | 16.4.0 |
| 2020-06 | RAN#88 | R5-202650 | 1435 | 1 | F | Addition of NR TC 8.2.3.16.1-MeasConfig via SRB3 | 16.4.0 |
| 2020-06 | RAN#88 | R5-202651 | 1504 | 1 | F | Corrections to NR measurement test cases 8.2.3.x | 16.4.0 |
| 2020-06 | RAN#88 | R5-202652 | 1475 | 1 | F | Correction to NR TC 8.2.4.2.1.x-CA release | 16.4.0 |
| 2020-06 | RAN#88 | R5-202653 | 1537 | 1 | F | Corrections to EN-DC test case 8.2.4.3.1.1 | 16.4.0 |
| 2020-06 | RAN#88 | R5-202654 | 1436 | 1 | F | Addition of NR TC 8.2.6.1.1-RLC failure | 16.4.0 |
| 2020-06 | RAN#88 | R5-202655 | 1551 | 1 | F | Corrections to 5GC Test Case 9.1.1.3 | 16.4.0 |
| 2020-06 | RAN#88 | R5-202656 | 1494 | 1 | F | Correction to 5GMM test case 9.1.2.1 | 16.4.0 |
| 2020-06 | RAN#88 | R5-202657 | 1495 | 1 | F | Correction to 5GMM test case 9.1.4.1 | 16.4.0 |
| 2020-06 | RAN#88 | R5-202658 | 1438 | 1 | F | Correction to NR TC 9.1.5.1.3-NSSAI handling | 16.4.0 |
| 2020-06 | RAN#88 | R5-202659 | 1440 | 1 | F | Correction to NR TC 9.1.5.1.9-Change of cell into a new tracking area | 16.4.0 |
| 2020-06 | RAN#88 | R5-202660 | 1508 | 1 | F | Correction to NR TC 9.1.6.1.3-Deregistration in new TA | 16.4.0 |
| 2020-06 | RAN#88 | R5-202661 | 1530 | 1 | F | Corrections to NR5G NAS TC 9.1.7.2 | 16.4.0 |
| 2020-06 | RAN#88 | R5-202662 | 1578 | 1 | F | Correction to test case 9.1.7.1 | 16.4.0 |
| 2020-06 | RAN#88 | R5-202663 | 1573 | 1 | F | Addition to 5GC SMS test case 9.1.8.2 | 16.4.0 |
| 2020-06 | RAN#88 | R5-202664 | 1444 | 1 | F | Correction to NR TC 10.1.4.1-T3580 expiry | 16.4.0 |
| 2020-06 | RAN#88 | R5-202665 | 1476 | 1 | F | Update of multilayer test case 11.1.5 | 16.4.0 |
| 2020-06 | RAN#88 | R5-202666 | 1477 | 1 | F | Update of multilayer test case 11.1.6 | 16.4.0 |
| 2020-06 | RAN#88 | R5-202667 | 1478 | 1 | F | Update of multilayer test case 11.1.2 | 16.4.0 |
| 2020-06 | RAN#88 | R5-202668 | 1445 | 1 | F | Addition of new NR TC 11.3.1-UAC AIO-MTSI MO speech call-SMSoIP-Uplink User data transfer | 16.4.0 |
| 2020-06 | RAN#88 | R5-202669 | 1447 | 1 | F | Addition of new NR TC 11.3.9-UAC Operator Defined Access Category | 16.4.0 |
| 2020-06 | RAN#88 | R5-202670 | 1513 | 1 | F | Addition of NR5G UAC TC 11.3.8 | 16.4.0 |
| 2020-06 | RAN#88 | R5-202671 | 1571 | 1 | F | Update to UAC test case 11.3.4 | 16.4.0 |
| 2020-06 | RAN#88 | R5-202672 | 1557 | 1 | F | Introduction of new IMS emergency TC 11.4.10 5GMM-REGISTERED.NORMAL-SERVICE N26 interface not supported N1 to S1 | 16.4.0 |
| 2020-09 | RAN#89 | R5-203363 | 1590 | - | F | Correction to NR TC 6.1.1.1-PLMN selection in automatic mode | 16.5.0 |
| 2020-09 | RAN#89 | R5-203367 | 1594 | - | F | Correction to NR TC 6.1.1.5-PLMN selection in Automatic mode User reselection | 16.5.0 |
| 2020-09 | RAN#89 | R5-203372 | 1599 | - | F | Correction to NR TC 6.1.2.21-Cell reselection | 16.5.0 |
| 2020-09 | RAN#89 | R5-203373 | 1600 | - | F | Correction to NR TC 6.1.2.23-Cell Reselection MFBI | 16.5.0 |
| 2020-09 | RAN#89 | R5-203374 | 1601 | - | F | Correction to NR TC 6.2.1.1-Selection of correct RAT for OPLMN | 16.5.0 |
| 2020-09 | RAN#89 | R5-203375 | 1602 | - | F | Correction to NR TC 6.2.1.4-Inter-RAT PLMN Selection with Manual mode | 16.5.0 |
| 2020-09 | RAN#89 | R5-203377 | 1604 | - | F | Correction to NR TC 6.2.3.9-Inter-RAT Speed Dependent Cell Reselection | 16.5.0 |
| 2020-09 | RAN#89 | R5-203382 | 1609 | - | F | Correction to NR TC 6.4.1.1-PLMN Selection | 16.5.0 |
| 2020-09 | RAN#89 | R5-203383 | 1610 | - | F | Correction to NR TC 7.1.1.1.1-Correct selection of RACH parameters | 16.5.0 |
| 2020-09 | RAN#89 | R5-203389 | 1616 | - | F | Correction to NR TC 8.1.1.3.1-Redirection to another NR frequency | 16.5.0 |
| 2020-09 | RAN#89 | R5-203394 | 1621 | - | F | Correction to NR TC 8.1.3.1.15A-Intra NR measurements Blacklisting | 16.5.0 |
| 2020-09 | RAN#89 | R5-203396 | 1623 | - | F | Correction to NR TC 8.1.5.7.1.X-RLC Failure MCG | 16.5.0 |
| 2020-09 | RAN#89 | R5-203397 | 1624 | - | F | Correction to ENDC TC 8.2.2.1.1-SRB3 | 16.5.0 |
| 2020-09 | RAN#89 | R5-203398 | 1625 | - | F | Addition of NRDC TC 8.2.2.1.2-SRB3 | 16.5.0 |
| 2020-09 | RAN#89 | R5-203403 | 1630 | - | F | Correction to ENDC TC 8.2.3.11.X-Measurement Gap | 16.5.0 |
| 2020-09 | RAN#89 | R5-203405 | 1632 | - | F | Correction to ENDC TC 8.2.6.1.1.X-RLC Failure SCG | 16.5.0 |
| 2020-09 | RAN#89 | R5-203406 | 1633 | - | F | Addition of NRDC TC 8.2.6.1.2.1-RLC Failure SCG intra-band | 16.5.0 |
| 2020-09 | RAN#89 | R5-203407 | 1634 | - | F | Addition of NRDC TC 8.2.6.1.2.2-RLC Failure SCG inter-band | 16.5.0 |

| | | | | | | | |
|---------|--------|-----------|------|---|---|---|--------|
| 2020-09 | RAN#89 | R5-203408 | 1635 | - | F | Addition of NRDC TC 8.2.6.1.2.3-RLC Failure SCG intra-band NC | 16.5.0 |
| 2020-09 | RAN#89 | R5-203409 | 1636 | - | F | Correction to ENDC TC 8.2.6.2.1-Processing delay | 16.5.0 |
| 2020-09 | RAN#89 | R5-203412 | 1639 | - | F | Correction to NR TC 9.1.5.1.1-Initial registration with 5G-GUTI reallocation | 16.5.0 |
| 2020-09 | RAN#89 | R5-203413 | 1640 | - | F | Correction to NR TC 9.1.5.1.8-Serving network not authorized | 16.5.0 |
| 2020-09 | RAN#89 | R5-203481 | 1648 | - | F | Correction to NR TC 6.1.1.4-PLMN selection in shared network environment | 16.5.0 |
| 2020-09 | RAN#89 | R5-203502 | 1652 | - | F | Correction to 5G NR Idle mode test case 6.4.2.2 | 16.5.0 |
| 2020-09 | RAN#89 | R5-203503 | 1653 | - | F | Correction to NR CA RRC test cases 8.1.3.1.18.x | 16.5.0 |
| 2020-09 | RAN#89 | R5-203504 | 1654 | - | F | Correction to NR RRC test cases 8.1.3.2.3 and 8.1.3.2.4 | 16.5.0 |
| 2020-09 | RAN#89 | R5-203505 | 1655 | - | F | Correction to 5GMM test case 9.1.5.1.13 | 16.5.0 |
| 2020-09 | RAN#89 | R5-203524 | 1661 | - | F | Corrections to NR MAC Test Case 7.1.1.5.4 | 16.5.0 |
| 2020-09 | RAN#89 | R5-203535 | 1662 | - | F | Splitting and updates to NR RLC test case 7.1.2.3.5 | 16.5.0 |
| 2020-09 | RAN#89 | R5-203539 | 1666 | - | F | Correction to NR test case 8.1.3.1.15A | 16.5.0 |
| 2020-09 | RAN#89 | R5-203540 | 1667 | - | F | Editorial correction to EN-DC test case 8.2.3.5.1 | 16.5.0 |
| 2020-09 | RAN#89 | R5-203567 | 1671 | - | F | Correction to NR TC 7.1.1.1.2-Random access procedure for Preamble selected by MAC itself | 16.5.0 |
| 2020-09 | RAN#89 | R5-203648 | 1690 | - | F | Editorial updates to NR5G Idle Mode TC 6.1.2.11 | 16.5.0 |
| 2020-09 | RAN#89 | R5-203649 | 1691 | - | F | Corrections to NR5G BWP TC 7.1.1.8.1 | 16.5.0 |
| 2020-09 | RAN#89 | R5-203650 | 1692 | - | F | Corrections to NR5G RRC NR-DC TC 8.2.2.4.2 and 8.2.2.5.2 | 16.5.0 |
| 2020-09 | RAN#89 | R5-203656 | 1695 | - | F | Corrections to NR5G MAC DRX TC 7.1.1.5.3 | 16.5.0 |
| 2020-09 | RAN#89 | R5-203657 | 1696 | - | F | Corrections to NR5G RRC TC 8.1.3.1.16 | 16.5.0 |
| 2020-09 | RAN#89 | R5-203658 | 1697 | - | F | Void NR5G NAS TC 9.1.5.2.6 | 16.5.0 |
| 2020-09 | RAN#89 | R5-203659 | 1698 | - | F | Corrections to NR5G MAC TC 7.1.1.2.1 | 16.5.0 |
| 2020-09 | RAN#89 | R5-203665 | 1703 | - | F | Corrections to NR5G RRC CA TCs to add Data Path verification | 16.5.0 |
| 2020-09 | RAN#89 | R5-203666 | 1704 | - | F | Corrections to ENDC RRC CA TCs to add Data Path verification | 16.5.0 |
| 2020-09 | RAN#89 | R5-203706 | 1708 | - | F | Correction to NR test case 7.1.2.3.1 | 16.5.0 |
| 2020-09 | RAN#89 | R5-203709 | 1711 | - | F | Correction to NR test case 8.1.3.1.5 | 16.5.0 |
| 2020-09 | RAN#89 | R5-203710 | 1712 | - | F | Correction to NR test case 8.1.3.1.8 | 16.5.0 |
| 2020-09 | RAN#89 | R5-203728 | 1715 | - | F | Correction to NR test case 8.1.3.1.16 | 16.5.0 |
| 2020-09 | RAN#89 | R5-203739 | 1717 | - | F | Corrections to 5GS Non-3GPP Access TC 9.2.1.1 | 16.5.0 |
| 2020-09 | RAN#89 | R5-203740 | 1718 | - | F | Corrections to 5GS Non-3GPP Access TC 9.2.5.1.4 | 16.5.0 |
| 2020-09 | RAN#89 | R5-203741 | 1719 | - | F | Corrections to 5GS Non-3GPP Access TC 9.2.7.1 | 16.5.0 |
| 2020-09 | RAN#89 | R5-203742 | 1720 | - | F | Corrections to 5GS Non-3GPP Access TC 9.2.7.2 | 16.5.0 |
| 2020-09 | RAN#89 | R5-203745 | 1721 | - | F | Correction to 5G NR Idle mode test case 6.4.3.1 | 16.5.0 |
| 2020-09 | RAN#89 | R5-203772 | 1727 | - | F | Correction to NR5GC testcase 9.1.4.1 | 16.5.0 |
| 2020-09 | RAN#89 | R5-203785 | 1728 | - | F | Correction to NR5GC testcase 10.1.1.2 | 16.5.0 |
| 2020-09 | RAN#89 | R5-203810 | 1729 | - | F | Correction to NR5GC test case 6.1.2.9 | 16.5.0 |
| 2020-09 | RAN#89 | R5-203811 | 1730 | - | F | Correction to NR CA RRC Test cases 8.1.3.1.17.x and 8.1.3.1.18.x | 16.5.0 |
| 2020-09 | RAN#89 | R5-204015 | 1733 | - | F | Correction of NR TC 6.2.2.1 | 16.5.0 |
| 2020-09 | RAN#89 | R5-204016 | 1734 | - | F | Correction to NR TC 8.1.4.1.8.X-Scell no change | 16.5.0 |
| 2020-09 | RAN#89 | R5-204018 | 1735 | - | F | Correction of NR TC 6.2.2.2 | 16.5.0 |
| 2020-09 | RAN#89 | R5-204019 | 1736 | - | F | Correction to NR5G UAC TC 11.3.8 | 16.5.0 |
| 2020-09 | RAN#89 | R5-204107 | 1740 | - | F | Correction to NR test case 7.1.2.3.11 | 16.5.0 |
| 2020-09 | RAN#89 | R5-204217 | 1744 | - | F | Addition of NR-DC RRC test case 8.2.2.9.2 | 16.5.0 |
| 2020-09 | RAN#89 | R5-204237 | 1746 | - | F | Correction to NR5G RRC TC 8.1.4.1.2 | 16.5.0 |
| 2020-09 | RAN#89 | R5-204254 | 1748 | - | F | Correction to NR UE Capability test case 8.1.5.1.1 | 16.5.0 |
| 2020-09 | RAN#89 | R5-204334 | 1749 | - | F | Correction to NR5G RRC test case 8.1.5.2.2 | 16.5.0 |
| 2020-09 | RAN#89 | R5-204336 | 1750 | - | F | Correction to test case 11.1.3 | 16.5.0 |
| 2020-09 | RAN#89 | R5-204341 | 1751 | - | F | Correction to the NR5GC testcase 8.1.3.1.12 | 16.5.0 |
| 2020-09 | RAN#89 | R5-204359 | 1754 | - | F | Correction to NR test case 8.1.4.1.6 | 16.5.0 |
| 2020-09 | RAN#89 | R5-204363 | 1755 | - | F | Corrections to NR5G PDCP TC 7.1.3.4.1 | 16.5.0 |
| 2020-09 | RAN#89 | R5-204372 | 1756 | - | F | Correction to NR5GC CA RRC test cases 8.1.2.1.5.x | 16.5.0 |
| 2020-09 | RAN#89 | R5-204379 | 1678 | 1 | F | Correction to Idle mode test case 6.4.1.2 | 16.5.0 |
| 2020-09 | RAN#89 | R5-204380 | 1680 | 1 | F | Correction to Idle mode test case 6.1.2.9 | 16.5.0 |
| 2020-09 | RAN#89 | R5-204381 | 1689 | 1 | F | Correction to the power level of NR RRC TC 8.1.1.2.1 and 8.1.1.4.1 | 16.5.0 |
| 2020-09 | RAN#89 | R5-204382 | 1739 | 1 | F | Correction to NR RRC TC 8.1.3.2.2 | 16.5.0 |
| 2020-09 | RAN#89 | R5-204403 | 1592 | 1 | F | Correction to NR TC 6.1.1.2-access technology combinations | 16.5.0 |
| 2020-09 | RAN#89 | R5-204404 | 1596 | 1 | F | Correction to NR TC 6.1.1.7-PLMN selection of RPLMN or HPLMN in Automatic mode | 16.5.0 |
| 2020-09 | RAN#89 | R5-204405 | 1598 | 1 | F | Correction to NR TC 6.1.2.19-Speed-dependent cell reselection | 16.5.0 |
| 2020-09 | RAN#89 | R5-204406 | 1603 | 1 | F | Correction to NR TC 6.2.1.5-Inter-RAT Background HPLMN Search with Automatic Mode | 16.5.0 |
| 2020-09 | RAN#89 | R5-204407 | 1605 | 1 | F | Correction to NR TC 6.3.1.1-SOR during registration with security check successful using List Type 1 | 16.5.0 |
| 2020-09 | RAN#89 | R5-204408 | 1606 | 1 | F | Correction to NR TC 6.3.1.2-SOR during registration with security check successful but no requested acknowledgement | 16.5.0 |
| 2020-09 | RAN#89 | R5-204409 | 1608 | 1 | F | Correction to NR TC 6.3.1.5-SOR during registration with no SOR information received | 16.5.0 |
| 2020-09 | RAN#89 | R5-204410 | 1645 | 1 | F | Correction to Idle Mode SoR TC 6.3.1.7 | 16.5.0 |
| 2020-09 | RAN#89 | R5-204411 | 1647 | 1 | F | Correction to NR TC 6.3.1.8-Steering of UE in roaming after registration | 16.5.0 |

| | | | | | | | |
|---------|--------|-----------|------|---|---|--|--------|
| 2020-09 | RAN#89 | R5-204412 | 1669 | 1 | F | Correction to NR TC 6.2.2.1-N2L cell reselection | 16.5.0 |
| 2020-09 | RAN#89 | R5-204413 | 1670 | 1 | F | Correction to NR TC 6.2.2.2-L2N cell reselection | 16.5.0 |
| 2020-09 | RAN#89 | R5-204414 | 1677 | 1 | F | Correction to the power level of Idle mode test cases | 16.5.0 |
| 2020-09 | RAN#89 | R5-204415 | 1693 | 1 | F | Corrections to NR5G Idle Mode TC 6.4.2.1 | 16.5.0 |
| 2020-09 | RAN#89 | R5-204416 | 1700 | 1 | F | Corrections to NR5G Idle Mode TC 6.1.2.13 | 16.5.0 |
| 2020-09 | RAN#89 | R5-204417 | 1722 | 1 | F | Correction to 5G NR Idle mode inter-RAT test cases | 16.5.0 |
| 2020-09 | RAN#89 | R5-204418 | 1613 | 1 | F | Correction to NR TC 7.1.1.9.1-MAC Reset | 16.5.0 |
| 2020-09 | RAN#89 | R5-204419 | 1614 | 1 | F | Correction to NR TC 7.1.1.2.2-PDSCH Aggregation | 16.5.0 |
| 2020-09 | RAN#89 | R5-204420 | 1656 | 1 | F | Correction to NR MAC test case 7.1.1.5.2 | 16.5.0 |
| 2020-09 | RAN#89 | R5-204421 | 1694 | 1 | F | Corrections to NR5G MAC TC 7.1.1.2.4 | 16.5.0 |
| 2020-09 | RAN#89 | R5-204422 | 1699 | 1 | F | Corrections to NR5G MAC TC 7.1.1.1.2 | 16.5.0 |
| 2020-09 | RAN#89 | R5-204423 | 1743 | 1 | F | Addition of NR-DC MAC Test Case | 16.5.0 |
| 2020-09 | RAN#89 | R5-204426 | 1682 | 1 | F | Modification of PDCP TC 7.1.3.5.2 to add testing for change of ul-DataSplitThreshold and transmission of SRs | 16.5.0 |
| 2020-09 | RAN#89 | R5-204429 | 1709 | 1 | F | Correction to NR test case 7.1.3.5.5 | 16.5.0 |
| 2020-09 | RAN#89 | R5-204430 | 1724 | 1 | F | Update to test case NR5GC 7.1.3.5.3 (NR-DC) | 16.5.0 |
| 2020-09 | RAN#89 | R5-204431 | 1725 | 1 | F | Correction to NR5GC SDAP test cases 7.1.4.1 and 7.1.4.2 | 16.5.0 |
| 2020-09 | RAN#89 | R5-204432 | 1617 | 1 | F | Correction to NR TC 8.1.1.3.3-With priority information | 16.5.0 |
| 2020-09 | RAN#89 | R5-204433 | 1685 | 1 | F | Addition of new RRC TC for checking extended / spare field handling in SI | 16.5.0 |
| 2020-09 | RAN#89 | R5-204434 | 1723 | 1 | F | Correction to NR RRC IRAT test case 8.1.1.3.4 | 16.5.0 |
| 2020-09 | RAN#89 | R5-204435 | 1737 | 1 | F | Correction to NR5GC test case 8.1.1.3.2 | 16.5.0 |
| 2020-09 | RAN#89 | R5-204436 | 1745 | 1 | F | Correction to NR5G RRC TC 8.1.1.4.1 | 16.5.0 |
| 2020-09 | RAN#89 | R5-204437 | 1619 | 1 | F | Correction to NR TC 8.1.X on SINR related configuration | 16.5.0 |
| 2020-09 | RAN#89 | R5-204438 | 1620 | 1 | F | Correction to NR TC 8.1.3.1.13-CSI-RS based intra-freq | 16.5.0 |
| 2020-09 | RAN#89 | R5-204439 | 1627 | 1 | F | Correction to ENDC TC 8.2.2.6.1-PDCP version change | 16.5.0 |
| 2020-09 | RAN#89 | R5-204440 | 1646 | 1 | F | Correction to NR TC 8.1.3.1.14A-CSI-RS based inter-freq | 16.5.0 |
| 2020-09 | RAN#89 | R5-204441 | 1649 | 1 | F | Addition of new test purpose to test case 8.1.3.1.23 | 16.5.0 |
| 2020-09 | RAN#89 | R5-204442 | 1659 | 1 | F | Correction to NR RRC test case 8.1.3.1.20 | 16.5.0 |
| 2020-09 | RAN#89 | R5-204444 | 1674 | 1 | F | Correction to NR5GC test case 8.1.3.1.12 | 16.5.0 |
| 2020-09 | RAN#89 | R5-204445 | 1675 | 1 | F | Addition of NR-DC RRC test case 8.2.2.8.2 | 16.5.0 |
| 2020-09 | RAN#89 | R5-204446 | 1622 | 1 | F | Correction to NR TC 8.1.4.1.7.X-Scell Release | 16.5.0 |
| 2020-09 | RAN#89 | R5-204447 | 1628 | 1 | F | Correction to ENDC TC 8.2.3.9.1-CSI-RS based Intra-frequency measurements | 16.5.0 |
| 2020-09 | RAN#89 | R5-204448 | 1629 | 1 | F | Correction to ENDC TC 8.2.3.10.1-CSI-RS based Inter-frequency measurements | 16.5.0 |
| 2020-09 | RAN#89 | R5-204449 | 1631 | 1 | F | Addition of NRDC TC 8.2.3.16.2-Intra-NR Measurement configuration control and reporting | 16.5.0 |
| 2020-09 | RAN#89 | R5-204450 | 1650 | 1 | F | Correction to include data path check after handover in test case 8.1.4.1.2 | 16.5.0 |
| 2020-09 | RAN#89 | R5-204451 | 1672 | 1 | F | Correction to Inter-RAT HO test case 8.1.4.2.2 | 16.5.0 |
| 2020-09 | RAN#89 | R5-204452 | 1679 | 1 | F | Correction to Inter-RAT HO test case 8.1.4.2.1 | 16.5.0 |
| 2020-09 | RAN#89 | R5-204453 | 1702 | 1 | F | Corrections to NR5G RRC IRAT TC 8.1.4.2.2.1 | 16.5.0 |
| 2020-09 | RAN#89 | R5-204454 | 1731 | 1 | F | Addition of NR-DC RRC test case 8.2.3.14.2 | 16.5.0 |
| 2020-09 | RAN#89 | R5-204455 | 1742 | 1 | F | Correction to MR-DC RRC TC 8.2.3.8.1 | 16.5.0 |
| 2020-09 | RAN#89 | R5-204456 | 1676 | 1 | F | Correction to NR RRC TC 8.1.5.1.1 | 16.5.0 |
| 2020-09 | RAN#89 | R5-204457 | 1637 | 1 | F | Correction to NR TC 9.1.1.3-EAP message transport abnormal | 16.5.0 |
| 2020-09 | RAN#89 | R5-204458 | 1638 | 1 | F | Correction to NR TC 9.1.1.6-5G AKA abnormal | 16.5.0 |
| 2020-09 | RAN#89 | R5-204459 | 1716 | 1 | F | Correction to 5GC TC 9.1.3.1 | 16.5.0 |
| 2020-09 | RAN#89 | R5-204460 | 1641 | 1 | F | Correction to NR TC 9.1.5.1.9-Initial registration with Change of cell into a new tracking area | 16.5.0 |
| 2020-09 | RAN#89 | R5-204461 | 1642 | 1 | F | Correction to NR TC 9.1.6.1.4-Transmission failure with TAI change from lower layers | 16.5.0 |
| 2020-09 | RAN#89 | R5-204462 | 1706 | 1 | F | Correction to 5GC TC 9.1.5.2.9 | 16.5.0 |
| 2020-09 | RAN#89 | R5-204463 | 1752 | 1 | F | Correction to NR TC 9.1.5.1.14 | 16.5.0 |
| 2020-09 | RAN#89 | R5-204464 | 1753 | 1 | F | Corrections to NR5G NAS TC 9.1.6.1.3 | 16.5.0 |
| 2020-09 | RAN#89 | R5-204465 | 1726 | 1 | F | Correction to Multilayer TC 11.1.2 and 11.1.5 | 16.5.0 |
| 2020-09 | RAN#89 | R5-204466 | 1732 | 1 | F | Corrections to EPS fallback regarding IMS procedures | 16.5.0 |
| 2020-09 | RAN#89 | R5-204467 | 1738 | 1 | F | Correction to test case 11.1.7 | 16.5.0 |
| 2020-09 | RAN#89 | R5-204468 | 1643 | 1 | F | Correction to NR TC 11.3.9-UAC AI-0 Operator Defined Access Category | 16.5.0 |
| 2020-09 | RAN#89 | R5-204512 | 1701 | 1 | F | Corrections to NR5G RLC TC 7.1.2.3.11 | 16.5.0 |
| 2020-09 | RAN#89 | R5-204513 | 1660 | 1 | F | Addition of new test case 8.1.4.2.1.2 for Inter-RAT handover from NR to EN-DC | 16.5.0 |
| 2020-09 | RAN#89 | R5-204517 | 1658 | 1 | F | Introduction of a new test case for voice fallback indication under EPS fallback with redirection | 16.5.0 |
| 2020-09 | RAN#89 | R5-204518 | 1747 | 1 | F | Addition of NR5G UAC TC 11.3.2 | 16.5.0 |
| 2020-09 | RAN#89 | R5-204543 | 1607 | 1 | F | Correction to NR TC 6.3.1.3-SOR during registration with security check unsuccessful for Automatic mode | 16.5.0 |
| 2020-12 | RAN#90 | R5-205142 | 1758 | - | F | Update of test case 9.3.1.2 Inter-system mobility registration update / Single-registration mode with N26 / 5GMM-IDLE / EPC to 5GC | 16.6.0 |
| 2020-12 | RAN#90 | R5-205176 | 1768 | - | F | Correction to ENDC TC 8.2.6.2.1 | 16.6.0 |

| | | | | | | | |
|---------|--------|-----------|------|---|---|--|--------|
| 2020-12 | RAN#90 | R5-205180 | 1770 | - | F | Corrections to TC 8.1.4.2.2 regarding IMS usage | 16.6.0 |
| 2020-12 | RAN#90 | R5-205192 | 1771 | - | F | Correction to 5G NR Idle mode test case 6.1.2.14 | 16.6.0 |
| 2020-12 | RAN#90 | R5-205244 | 1778 | - | F | Correction to the Preamble of Test case 8.1.4.1.2 | 16.6.0 |
| 2020-12 | RAN#90 | R5-205279 | 1779 | - | F | Correction to NR-DC RRC test case 8.2.3.14.2 | 16.6.0 |
| 2020-12 | RAN#90 | R5-205292 | 1783 | - | F | Corrections to EPS Fallback test cases regarding IMS usage | 16.6.0 |
| 2020-12 | RAN#90 | R5-205320 | 1787 | - | F | Correction to NR5G Idle Mode TC 6.1.1.1 | 16.6.0 |
| 2020-12 | RAN#90 | R5-205321 | 1788 | - | F | Correction to NR5G UAC TC 11.3.2 | 16.6.0 |
| 2020-12 | RAN#90 | R5-205341 | 1790 | - | F | Updates to PDCP default Pre-Test Conditions | 16.6.0 |
| 2020-12 | RAN#90 | R5-205342 | 1791 | - | F | Corrections to NR CA HO test cases 8.1.4.1.9.x | 16.6.0 |
| 2020-12 | RAN#90 | R5-205361 | 1795 | - | F | Correction to Idle Mode SoR Test Case 6.3.1.7 | 16.6.0 |
| 2020-12 | RAN#90 | R5-205365 | 1796 | - | F | Correction to NR TC 6.1.2.9-Cell reselection using Qhyst and Qoffset | 16.6.0 |
| 2020-12 | RAN#90 | R5-205366 | 1797 | - | F | Correction to NR TC 6.1.2.13-Cell reselection CellReservedForOperatorUse with Access Identity 0-1-2-12-13-14 | 16.6.0 |
| 2020-12 | RAN#90 | R5-205368 | 1799 | - | F | Correction to NR TC 6.3.1.3-SOR security check unsuccessful | 16.6.0 |
| 2020-12 | RAN#90 | R5-205369 | 1800 | - | F | Correction to NR TC 6.3.1.5-Steering of UE in roaming during registration | 16.6.0 |
| 2020-12 | RAN#90 | R5-205373 | 1804 | - | F | Correction to NR TC 8.1.3.1.11-RSRQ based | 16.6.0 |
| 2020-12 | RAN#90 | R5-205374 | 1805 | - | F | Correction to NR TC 8.1.3.2.X-Inter-RAT | 16.6.0 |
| 2020-12 | RAN#90 | R5-205377 | 1808 | - | F | Correction to MRDC TC 8.2.2.8.2-key change | 16.6.0 |
| 2020-12 | RAN#90 | R5-205379 | 1810 | - | F | Correction to MRDC TC 8.2.3.9.1-CSI-RS based intra-freq | 16.6.0 |
| 2020-12 | RAN#90 | R5-205381 | 1812 | - | F | Correction to MRDC TC 8.2.3.16.2-Measurement via SRB3 | 16.6.0 |
| 2020-12 | RAN#90 | R5-205383 | 1814 | - | F | Correction to NR TC 9.1.4.1-Generic UE configuration update | 16.6.0 |
| 2020-12 | RAN#90 | R5-205385 | 1816 | - | F | Correction to NR TC 9.1.6.1.3-DeRegistration | 16.6.0 |
| 2020-12 | RAN#90 | R5-205388 | 1819 | - | F | Correction to NR TC 11.3.9-UAC AI-0 Operator Defined Access Category | 16.6.0 |
| 2020-12 | RAN#90 | R5-205575 | 1862 | - | F | Correction to NR PDCP test case 7.1.3.5.2 for NR-DC | 16.6.0 |
| 2020-12 | RAN#90 | R5-205577 | 1864 | - | F | Correction to ENDC CA RRC test cases 8.2.4.1.1.x | 16.6.0 |
| 2020-12 | RAN#90 | R5-205578 | 1865 | - | F | Correction to NR5G MAC TC 7.1.1.8.1 | 16.6.0 |
| 2020-12 | RAN#90 | R5-205579 | 1866 | - | F | Correction NR5G NAS TC 9.1.1.2 | 16.6.0 |
| 2020-12 | RAN#90 | R5-205600 | 1871 | - | F | Correction to NR TC 6.4.2.1-Cell Selection in RRC_INACTIVE state | 16.6.0 |
| 2020-12 | RAN#90 | R5-205615 | 1879 | - | F | Correction to 5GS Non-3GPP Access Test Case 9.2.4.1 | 16.6.0 |
| 2020-12 | RAN#90 | R5-205616 | 1880 | - | F | Correction to 5GS Non-3GPP Access Test Case 9.2.5.1.2 | 16.6.0 |
| 2020-12 | RAN#90 | R5-205637 | 1882 | - | F | Update to TC 7.1.3.5.5 PDCP Duplication | 16.6.0 |
| 2020-12 | RAN#90 | R5-205671 | 1884 | - | F | Correction to ENDC RLC TC 7.1.2.3.6 | 16.6.0 |
| 2020-12 | RAN#90 | R5-205673 | 1885 | - | F | Correction to RLC TCs 7.1.2.3.7 and 7.1.2.3.8 | 16.6.0 |
| 2020-12 | RAN#90 | R5-205718 | 1887 | - | F | Correction to NR testcases 8.1.3.1.11, 8.1.3.1.12 | 16.6.0 |
| 2020-12 | RAN#90 | R5-205752 | 1888 | - | F | Correction to NR test case 8.2.2.1.2 | 16.6.0 |
| 2020-12 | RAN#90 | R5-205753 | 1889 | - | F | Correction to NR test case 8.2.2.2.1 | 16.6.0 |
| 2020-12 | RAN#90 | R5-205759 | 1891 | - | F | Correction to NR5G RRC TC 8.1.1.4.1 | 16.6.0 |
| 2020-12 | RAN#90 | R5-205856 | 1897 | - | F | Correction to Inter-RAT Idle mode test case 6.2.1.4 | 16.6.0 |
| 2020-12 | RAN#90 | R5-205866 | 1903 | - | F | Correction of NR test case 9.1.5.1.8 | 16.6.0 |
| 2020-12 | RAN#90 | R5-205942 | 1906 | - | F | Update for Flexible PDU-PDN - Test Cases | 16.6.0 |
| 2020-12 | RAN#90 | R5-206123 | 1907 | - | F | Corrections to NR MAC Test Case 7.1.1.5.4 | 16.6.0 |
| 2020-12 | RAN#90 | R5-206265 | 1912 | - | F | Correction of Idle TC 6.2.3.2 | 16.6.0 |
| 2020-12 | RAN#90 | R5-206280 | 1815 | 1 | F | Correction to NR TC 9.1.5.2.9-Mobility and periodic registration update | 16.6.0 |
| 2020-12 | RAN#90 | R5-206311 | 1772 | 1 | F | Correction to Idle TC 6.3.1.9 | 16.6.0 |
| 2020-12 | RAN#90 | R5-206312 | 1792 | 1 | F | Correction to Cell Reselection Test Case 6.1.2.18 | 16.6.0 |
| 2020-12 | RAN#90 | R5-206313 | 1793 | 1 | F | Correction to Cell Reselection Test Case 6.1.2.21 | 16.6.0 |
| 2020-12 | RAN#90 | R5-206314 | 1798 | 1 | F | Correction to NR TC 6.3.1.1-SOR | 16.6.0 |
| 2020-12 | RAN#90 | R5-206315 | 1856 | 1 | F | Addition of new NR TC-Additional extended field in LTE SIB1_schedulingInfoList-v12j0 | 16.6.0 |
| 2020-12 | RAN#90 | R5-206316 | 1857 | 1 | F | Addition of new NR TC-Additional extended field in LTE SIB1_schedulingInfoListExt-r12 | 16.6.0 |
| 2020-12 | RAN#90 | R5-206317 | 1909 | 1 | F | Correction to test case 6.2.3.9 | 16.6.0 |
| 2020-12 | RAN#90 | R5-206318 | 1910 | 1 | F | Correction to NR IDLE mode test case 6.1.2.2 | 16.6.0 |
| 2020-12 | RAN#90 | R5-206319 | 1801 | 1 | F | Correction to NR TC 7.1.1.5.5-Long DRX command MAC control element reception | 16.6.0 |
| 2020-12 | RAN#90 | R5-206320 | 1802 | 1 | F | Correction to NR TC 7.1.1.9.1-MAC Reset | 16.6.0 |
| 2020-12 | RAN#90 | R5-206321 | 1858 | 1 | F | Correction to MAC TC 7.1.1.8.1 | 16.6.0 |
| 2020-12 | RAN#90 | R5-206322 | 1869 | 1 | F | Correction to NR TC 7.1.1.10.1-DatInactivityTimer expiry | 16.6.0 |
| 2020-12 | RAN#90 | R5-206323 | 1892 | 1 | F | Addition of MAC Test Case for Recommended Bit Rate | 16.6.0 |
| 2020-12 | RAN#90 | R5-206324 | 1893 | 1 | F | Corrections to MAC CA Power Headroom Test case | 16.6.0 |
| 2020-12 | RAN#90 | R5-206325 | 1895 | 1 | F | Correction to MAC CA test case | 16.6.0 |
| 2020-12 | RAN#90 | R5-206326 | 1803 | 1 | F | Correction to NR TC 7.1.2.3.3 and 7.1.2.3.4-SN | 16.6.0 |
| 2020-12 | RAN#90 | R5-206327 | 1761 | 1 | F | Correction to NR PDCP test cases 7.1.3.2.x | 16.6.0 |
| 2020-12 | RAN#90 | R5-206328 | 1762 | 1 | F | Correction to NR PDCP test cases 7.1.3.3.x | 16.6.0 |
| 2020-12 | RAN#90 | R5-206329 | 1863 | 1 | F | Correction to NR PDCP test case 7.1.3.5.5 for NR-DC | 16.6.0 |
| 2020-12 | RAN#90 | R5-206330 | 1886 | 1 | F | Update to test case NR5GC 7.1.3.5.3 (NR-DC) | 16.6.0 |
| 2020-12 | RAN#90 | R5-206331 | 1769 | 1 | F | Correction to SDAP testcase 7.1.4.1 and 7.1.4.2 | 16.6.0 |
| 2020-12 | RAN#90 | R5-206332 | 1785 | 1 | F | Correction to NR5G RRC TC 8.1.1.3.4 | 16.6.0 |

| | | | | | | | |
|---------|--------|-----------|------|---|---|--|--------|
| 2020-12 | RAN#90 | R5-206333 | 1896 | 1 | F | Correction to NR5GC test case 8.1.2.1.4 | 16.6.0 |
| 2020-12 | RAN#90 | R5-206334 | 1781 | 1 | F | Correction to RRC TC 8.1.3.1.2 | 16.6.0 |
| 2020-12 | RAN#90 | R5-206335 | 1786 | 1 | F | Correction to NR5G RRC TC 8.1.3.1.2, 8.1.3.1.3 and 8.1.3.1.4 | 16.6.0 |
| 2020-12 | RAN#90 | R5-206336 | 1900 | 1 | F | Correction to NR5GC test case 8.1.4.1.5 | 16.6.0 |
| 2020-12 | RAN#90 | R5-206337 | 1806 | 1 | F | Correction to NR TC 8.1.5.2.2-SI Change in NR RRC_CONNECTED state | 16.6.0 |
| 2020-12 | RAN#90 | R5-206338 | 1807 | 1 | F | Correction to NR TC 8.1.5.7.1-MCG RLC failure | 16.6.0 |
| 2020-12 | RAN#90 | R5-206339 | 1902 | 1 | F | Correction to NR5GC test case 8.1.5.6.1 | 16.6.0 |
| 2020-12 | RAN#90 | R5-206340 | 1760 | 1 | F | Correction to ENDC RRC test case 8.2.2.3.1 | 16.6.0 |
| 2020-12 | RAN#90 | R5-206341 | 1809 | 1 | F | Correction to MRDC TC 8.2.2.9.2-split DRB | 16.6.0 |
| 2020-12 | RAN#90 | R5-206342 | 1867 | 1 | F | Correction to NRDC TC 8.2.2.4.2 and 8.2.2.5.2 | 16.6.0 |
| 2020-12 | RAN#90 | R5-206343 | 1890 | 1 | F | Correction to NR5G RRC TC 8.2.2.1.2 | 16.6.0 |
| 2020-12 | RAN#90 | R5-206344 | 1911 | 1 | F | Addition of NR-DC RRC test case 8.2.2.7.2 | 16.6.0 |
| 2020-12 | RAN#90 | R5-206345 | 1759 | 1 | F | Correction to ENDC CA RRC test cases 8.2.4.3.1.x | 16.6.0 |
| 2020-12 | RAN#90 | R5-206346 | 1777 | 1 | F | Addition of new Test Case 8.2.5.1.2 Radio link failure / Random access problem / NR-DC | 16.6.0 |
| 2020-12 | RAN#90 | R5-206347 | 1789 | 1 | F | Addition of NRDC TC 8.2.5.2.2 | 16.6.0 |
| 2020-12 | RAN#90 | R5-206348 | 1813 | 1 | F | Correction to MRDC TC 8.2.6.1.X-SCG RLC failure | 16.6.0 |
| 2020-12 | RAN#90 | R5-206349 | 1773 | 1 | F | Correction to 5GC TC 9.1.1.3 | 16.6.0 |
| 2020-12 | RAN#90 | R5-206350 | 1774 | 1 | F | Correction to 5GC TC 9.1.1.6 | 16.6.0 |
| 2020-12 | RAN#90 | R5-206351 | 1766 | 1 | F | Correction to NR5GC testcase 9.1.5.2.1 | 16.6.0 |
| 2020-12 | RAN#90 | R5-206352 | 1775 | 1 | F | Correction to 5GC TC 9.1.5.1.3 | 16.6.0 |
| 2020-12 | RAN#90 | R5-206353 | 1859 | 1 | F | Update preamble of 5GC TC 9.1.5.1.2, 9.1.5.1.4 and 9.1.5.1.14 | 16.6.0 |
| 2020-12 | RAN#90 | R5-206354 | 1868 | 1 | F | Correction to NR5GC testcase 10.1.1.2 | 16.6.0 |
| 2020-12 | RAN#90 | R5-206355 | 1767 | 1 | F | Correction to NR5GC testcase 10.1.3.2 | 16.6.0 |
| 2020-12 | RAN#90 | R5-206356 | 1872 | 1 | F | Correction to NR5GC testcase 10.1.2.2 | 16.6.0 |
| 2020-12 | RAN#90 | R5-206357 | 1873 | 1 | F | Correction to NR5GC testcase 10.1.4.1 | 16.6.0 |
| 2020-12 | RAN#90 | R5-206358 | 1874 | 1 | F | Correction to NR5GC testcase 10.1.6.1 | 16.6.0 |
| 2020-12 | RAN#90 | R5-206359 | 1875 | 1 | F | Correction to NR5GC testcase 10.1.6.2 | 16.6.0 |
| 2020-12 | RAN#90 | R5-206360 | 1776 | 1 | F | Correction to Multilayer TC 11.1.4 | 16.6.0 |
| 2020-12 | RAN#90 | R5-206361 | 1817 | 1 | F | Correction to NR TC 11.1.1-MO MMTEL voice call setup from NR RRC_IDLE with EPS Fallback | 16.6.0 |
| 2020-12 | RAN#90 | R5-206362 | 1818 | 1 | F | Correction to NR TC 11.1.3-MO MMTEL voice call setup from NR RRC_CONNECTED with EPS Fallback | 16.6.0 |
| 2020-12 | RAN#90 | R5-206363 | 1784 | 1 | F | Corrections to Unified Access Control test cases regarding IMS usage | 16.6.0 |
| 2020-12 | RAN#90 | R5-206364 | 1794 | 1 | F | Correction to Access Barring test 11.3.4 | 16.6.0 |
| 2020-12 | RAN#90 | R5-206365 | 1876 | 1 | F | Correction to Emergency Services testcase 11.4.1 | 16.6.0 |
| 2020-12 | RAN#90 | R5-206366 | 1877 | 1 | F | Correction to Emergency Services testcase 11.4.4 | 16.6.0 |
| 2020-12 | RAN#90 | R5-206396 | 1820 | 1 | F | Addition of TC for DL assignment Multi Semi-persistent configuration | 16.6.0 |
| 2020-12 | RAN#90 | R5-206397 | 1860 | 1 | F | Addition of TC PDCP Duplication for Rel-16 | 16.6.0 |
| 2020-12 | RAN#90 | R5-206398 | 1908 | 1 | F | New testcase for ethernet header compression and decompression for NR | 16.6.0 |
| 2020-12 | RAN#90 | R5-206405 | 1824 | 1 | F | Addition of NR TC 8.1.4.3.1-MobEnh DAPS handover | 16.6.0 |
| 2020-12 | RAN#90 | R5-206411 | 1822 | 1 | F | Addition of NR V2X TC 12.1.2.1.3-Network Scheduling | 16.6.0 |
| 2020-12 | RAN#90 | R5-206412 | 1823 | 1 | F | Addition of NR V2X TC 12.1.2.3.1-C1 and C2 | 16.6.0 |
| 2020-12 | RAN#90 | R5-206415 | 1904 | 1 | F | Addition of eMIMO MAC Test Case | 16.6.0 |
| 2020-12 | RAN#90 | R5-206417 | 1780 | 1 | F | Addition of UE power saving test case 7.1.1.12.1 | 16.6.0 |
| 2020-12 | RAN#90 | R5-206418 | 1782 | 1 | F | Addition of UE power saving test case 7.1.1.12.3 | 16.6.0 |
| 2020-12 | RAN#90 | R5-206429 | 1764 | 1 | F | Update test case 8.1.5.1.1 to add UE capability nr-HO-ToEN-DC-r16 | 16.6.0 |
| 2020-12 | RAN#90 | R5-206430 | 1765 | 1 | F | Update of test case 8.2.1.1.1 to support Inter-RAT handover from NR to EN-DC | 16.6.0 |
| 2020-12 | RAN#90 | R5-206431 | 1878 | 1 | F | Correction to 5GS Non-3GPP Access Test Case 9.2.2.1 | 16.6.0 |

History

| Document history | | |
|-------------------------|---------------|-------------|
| V16.4.0 | October 2020 | Publication |
| V16.5.0 | November 2020 | Publication |
| V16.6.0 | February 2021 | Publication |
| | | |
| | | |